

# COSORI™



## User Manual



### Helio 4-Quart Smart Air Fryer

Model: CAF-LI401S



#### Questions or Concerns?

Mon–Fri, 9:00 am–5:00 pm PST/PDT  
support@cosori.com | (888) 402-1684

 Thank you for  
your purchase! 

(We hope you love your new air fryer as much as we do)



*join*

the Cosori Cooks Community on Facebook  
[facebook.com/groups/cosoricooks](https://www.facebook.com/groups/cosoricooks)

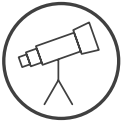

*explore*

our recipe gallery  
[www.cosori.com/recipes](https://www.cosori.com/recipes)



*enjoy*

weekly, featured recipes  
*made exclusively by our in-house chefs*



## CONTACT OUR CHEFS

Our helpful, in-house chefs are ready to assist you with any questions you might have!

**Email:** [recipes@cosori.com](mailto:recipes@cosori.com)

**Toll-Free:** (888) 402-1684

Mon–Fri, 9:00 am–5:00 pm PST/PDT

On behalf of all of us at Cosori,

*Happy cooking!*

## Table of Contents

Package Contents	3
Specifications	3
Important Safeguards	4
VeSync App Setup	8
VeSync App Features	8
Getting To Know Your Smart Air Fryer	9
Before First Use	11
Using Your Smart Air Fryer	12
Care & Maintenance	18
Accessories	18
Troubleshooting	19
Warranty Information	21
Customer Support	22

## Package Contents

1 x Helio 4-Quart Smart Air Fryer
1 x Crisper Plate
1 x Quick Reference Guide
1 x User Manual

## Specifications

<b>Power Supply</b>	AC 120V, 60Hz
<b>Rated Power</b>	1500W
<b>Capacity</b>	4.0 qt / 3.8 L (serves 2–4 people)
<b>Temperature Range</b>	170°–450°F / 75°–230°C
<b>Time Range</b>	1–60 min
<b>Dimensions</b>	11.7 x 12.9 x 13.8 in / 29.7 x 32.7 x 35.2 cm
<b>Weight</b>	13.7 lb / 6.22 kg

Download the free VeSync app to discover smart functions, original recipes from the Cosori chefs, and more!



# READ AND SAVE THESE INSTRUCTIONS

## IMPORTANT SAFEGUARDS

---

Follow basic safety precautions when using your air fryer. Read all instructions.

### Key Safety Points

- **Do not** touch hot surfaces. Use handle.
- Use caution when turning the basket over after cooking, as the hot crisper plate may fall out and create a safety hazard.
- **Do not** block any ventilation openings. Hot steam is released through openings. Keep your hands and face clear of openings.
- Be extremely cautious when moving your air fryer (or removing the basket) if it contains hot oil or other hot liquids.
- **Always** place the crisper plate on a heat-resistant surface after removing it from the basket.
- **Do not** clean with metal scouring pads. Metal fragments can break off the pad and touch electrical parts, creating a risk of electric shock.
- This air fryer is not to be used by persons (including children) with reduced physical, sensory, or mental capabilities, or lack of experience and knowledge, unless they have been given supervision or instruction concerning use of the appliance by a person responsible for their safety.

### General Safety

- To protect against electric shock, **do not** immerse the air fryer cord, plug, or housing in water or other liquids.
- Close supervision is necessary when the air fryer is used by or near children.
- Unplug when not in use and before cleaning. Allow to cool before putting on or taking off parts.
- **Do not** use your air fryer if it has a damaged cord or plug, if it malfunctions, or if it has been damaged in any way. Contact **Customer Support** (see page 22).
- Using accessory attachments not recommended by Cosori may cause injuries.
- **Do not** use outdoors.
- **Do not** place the air fryer or any of its parts on a stove, near gas or electric burners, or in a heated oven.
- **Do not** allow children to clean or perform maintenance on the air fryer unless they are supervised.
- Children should be supervised to ensure that they do not play with the air fryer.
- This air fryer is not intended to be operated by means of an external timer or separate remote-control system.
- **Do not** use the air fryer for any purpose other than its intended use.
- Not for commercial use. Household use **only**.

## While Air Frying

- Use on a flat, stable, heat-resistant surface away from heat sources or liquids.
- An air fryer works with hot air **only**. **Never** fill the basket with oil or fat.
- **CAUTION:** To avoid risk of electric shock, cook only in the removable basket.
- To avoid risk of fire or electric shock, **do not** place oversized foods or metal utensils into the air fryer.
- **Do not** overfill the air fryer basket. Heaping amounts of food may touch the heating coils and cause a fire hazard.
- **Do not** touch the basket or crisper plate during or immediately after air frying.
- **Do not** place paper, cardboard, non-heat-resistant plastic, or similar materials, into your air fryer.
- **Never** put baking or parchment paper into the air fryer without food on top. Air circulation can cause paper to lift and touch heating coils.
- **Always** use heat-safe containers. Be extremely cautious if using containers that aren't metal or glass.
- To avoid risk of fire, **do not** cover or allow the air fryer to touch flammable materials (curtains, draperies, walls, etc.) when it is turned on.
- **Do not** place items on top of the air fryer when it is turned on.
- **Do not** store any materials other than Cosori's recommended accessories in the air fryer when not in use.
- To turn the air fryer off, press  once. The air fryer will beep,  will turn orange, and other buttons will turn off.

- Immediately turn off and unplug your air fryer if you see dark smoke coming out. White smoke is normal, caused by heating fat or food splashing, but dark smoke means that food is burning or there is a circuit problem. Wait for smoke to clear before pulling the basket out. If the cause was not burnt food, contact **Customer Support** (page 22).
- **Do not** leave your air fryer unattended while in use.

## Power & Cord

- Your air fryer has a polarized plug (one prong is wider than the other), which fits into a polarized outlet only one way. If the plug does not fit, reverse the plug. If it still does not fit, **do not** use the plug in that outlet. **Do not** alter the plug in any way.
- Turn off the air fryer before removing the plug from the outlet.
- **Do not** let the power cord (or any extension cord) hang over the edge of a table or counter, or touch hot surfaces.
- Remove and discard the protective cover fitted over the power plug of the air fryer to prevent choking hazards.
- **Never** use an outlet below the counter when plugging in your air fryer.
- If the power supply cord is damaged, it must be replaced by Arovast Corporation or similarly qualified persons in order to avoid an electric or fire hazard. Please contact **Customer Support** (page 22).

- Keep the air fryer and its cord out of reach of children.
- Your air fryer should only be used with **120V, 60Hz** electrical systems. **Do not** plug into another type of outlet.

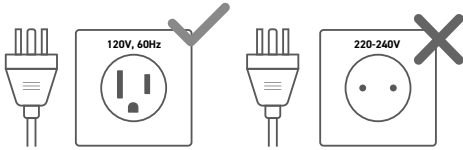

## Extension Cords

- A short power-supply cord is provided to reduce the risk resulting from becoming entangled in or tripping over a longer cord.
- Longer extension cords are available and may be used if care is exercised in their use. If a longer extension cord is used:
  - The marked electrical rating of the cord set or extension cord should be at least as great as the electrical rating of the air fryer.
  - The cord should be arranged so that it will not drape over the countertop or tabletop where it can be pulled on by children or tripped over unintentionally.

## Electromagnetic Fields (EMF)

The Cosori Smart Air Fryer complies with all standards regarding electromagnetic fields (EMF). If handled properly and according to the instructions in this user manual, the appliance is safe to use based on scientific evidence available today.



**Note:** Items marked with the following symbol may reach high temperatures and should be handled carefully.



**CAUTION:** Hot surface.

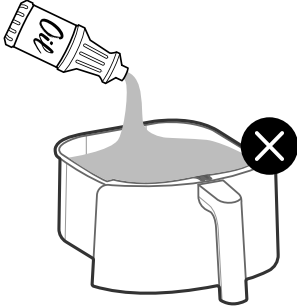

**DO NOT** fill with oil.  
This is not a deep fryer.

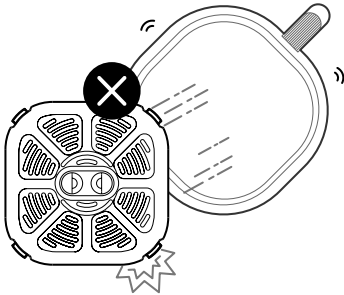

**CAUTION:** The hot crisper plate may fall out when turning the basket over.

**Note:** Firmly insert the crisper plate into the basket to reduce the chance of it falling out.

**SAVE THESE  
INSTRUCTIONS**

## VeSync App Setup

**Note:** The VeSync app is continually being improved and may change over time. If there are any differences, follow the in-app instructions.

1. To download the VeSync app, scan the QR code or search “VeSync” in the Apple App Store® or Google Play Store.

**Note:** For Android™ users, choose “Allow” to use VeSync.



2. Open the VeSync app. If you already have an account, tap **Log In**. To create a new account, tap **Sign Up**.

**Note:** You must create your own VeSync account to use third-party services and products. These will not work with a guest account. With a VeSync account, you can also allow your family and friends to control your smart air fryer.

3. Tap **+** and select your smart air fryer.
4. Follow the in-app instructions to set up your smart air fryer.

**Note:**

- You can change the name and icon at any time by going to the smart air fryer screen and tapping .
- You can use the VeSync app to connect your smart air fryer to **Amazon Alexa** or **Google Assistant™**.

## Disconnecting From WiFi®:

- To disconnect Wi-Fi®, press and hold the  for 15 seconds until the Wi-Fi indicator blinks. This will restore the smart air fryer’s default settings and disconnect it from the VeSync app.
- To reconnect, please follow the instructions in the VeSync app for adding a device.

## VeSync App Features

The VeSync app allows you to access additional smart air fryer functions, including those listed below.

### Remote Control

- All smart air fryer functions can be controlled remotely, except for starting cooking (to comply with UL safety regulations).
- Cooking progress can be monitored from a distance.

### In-App Recipes

- Pre-programmed recipes made by Cosori’s in-house chefs are available on the app. These recipes automatically set the recommended time and temperature.
- Create and save custom recipes.

### Third-Party Voice Control

- Compatible with Amazon Alexa and Google Assistant™ for voice commands.

**Note:** The VeSync app is continually updated and app features will expand.



# GETTING TO KNOW YOUR SMART AIR FRYER

---

Your Cosori Smart Air Fryer uses rapid 360° air circulation technology to cook with little to no oil, for quick, crispy, delicious food with up to 85% fewer calories than deep fryers. With a nonstick basket and an easy-to-use, safe design, the Cosori Smart Air Fryer is the star of your kitchen.

**Note:**

- **Do not** try to open the top of the air fryer. This is not a lid.
- The basket and crisper plate are made of aluminum metal with nonstick coating. They are PFOA-free and BPA-free.

## Air Fryer Diagram

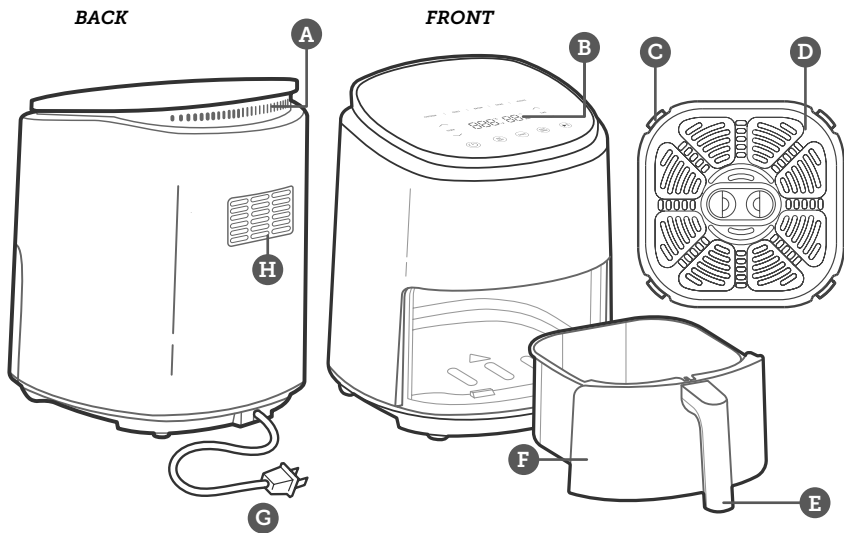

- |                      |                  |               |
|----------------------|------------------|---------------|
| A. Air Inlet         | D. Crisper Plate | G. Power Cord |
| B. Control Screen    | E. Basket Handle | H. Air Outlet |
| C. Silicone Stoppers | F. Basket        |               |

# Display Diagram

**Note:** When you press a button to use a function or program, it will turn white to show that it's active.

## Control Panel

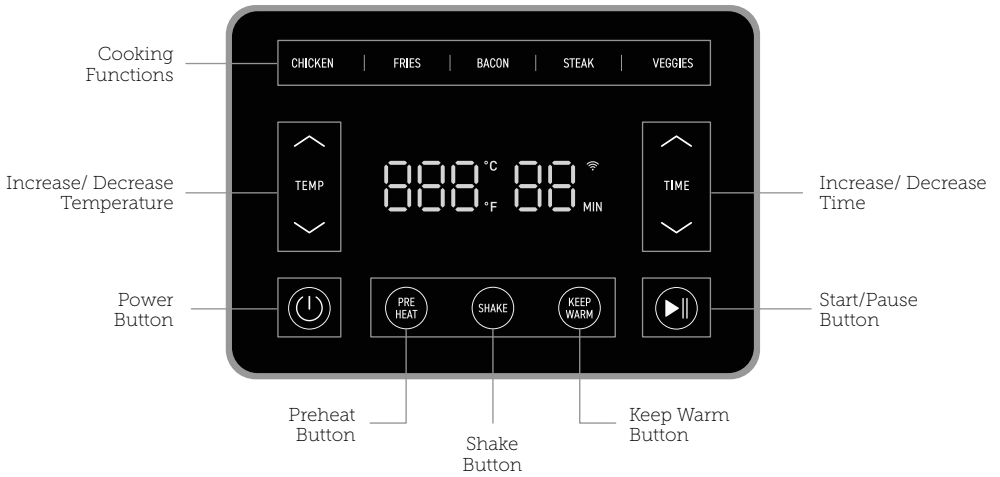

### Note:

- To save or reset presets, see **Cooking Functions** (see page 13).
- Press and hold  for 5 seconds to configure your air fryer. See the VeSync in-app instructions for more information.

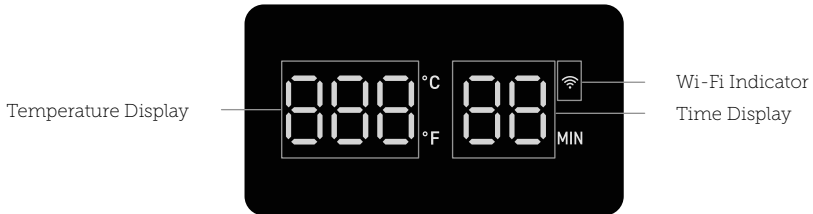

**Note:** The Wi-Fi indicator tells you your VeSync configuration status. See the VeSync in-app instructions for more information.

# BEFORE FIRST USE

## Setting Up

1. Remove all packaging from the air fryer, including any temporary stickers and the protective cover fitted over the power plug.
2. Place the air fryer on a stable, level, heat-resistant surface. Keep away from areas that can be damaged by steam (such as walls or cupboards).

**Note:** Leave 5 inches / 13 cm of space behind and above the air fryer. [Figure 1.1] Leave enough room to remove the basket.

3. Pull the handle to remove the basket. Remove all plastic from the basket.
4. Wash the basket and crisper plate thoroughly, using either a dishwasher or a non-abrasive sponge.
5. Wipe the inside and outside of the air fryer with a slightly moist cloth. Dry with a towel.
6. Insert the crisper plate back into the basket, and place the basket inside the air fryer.

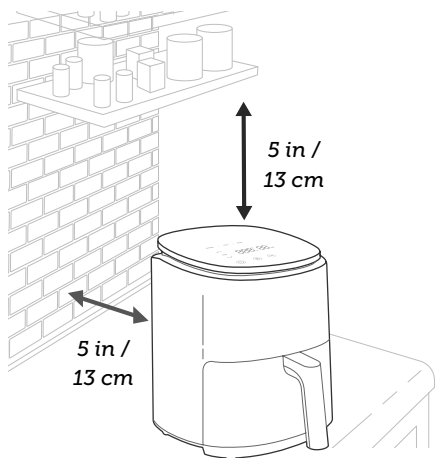

Figure 1.1

## Test Run

A test run will help you become familiar with your air fryer, make sure it's working correctly, and clean it of possible residues in the process.

1. Make sure the air fryer basket is empty and plug in the air fryer.
2. Press . The display will show "400°F" and "4 MIN".
3. Press to begin preheating. When preheating is done, the air fryer will beep.
4. Pull out the basket and let it cool for 4 minutes. Then place the empty basket back in the air fryer.
5. Press **BACON** to select the Bacon function. The display will show "320°F" and "8 MIN".
6. Press button to change the time to 5 minutes.
7. Press to begin. When finished, the air fryer will beep.
8. Remove the basket. This time, let the basket cool completely for 10–30 minutes.

### Note:

- Any air fryer may have a plastic smell from the manufacturing process. This is normal. If a plastic smell is still present after a test run, contact **Customer Support** (see page 22).
- Use caution when turning the basket over after cooking, as the hot crisper plate may fall out and create a safety hazard.
- **Do not** unscrew the basket handle from the basket.

## Silicone Stoppers





- The crisper plate contains 4 silicone stoppers made of safe, FDA-approved material. These stoppers keep the crisper plate fitted to the bottom of the basket, preventing the crisper plate from directly touching the basket, and in rare cases, damaging the nonstick coating on the basket.

# USING YOUR SMART AIR FRYER

**Note:** You can use the VeSync app to monitor cooking, follow in-app recipes, and access additional features. For a list of smart features, see **VeSync App Features** (see page 8).

## Preheating

We recommend preheating before placing food into the air fryer, unless your air fryer is already hot. Food will not cook thoroughly without preheating.

1. Plug in. Press  to turn on the air fryer display.
2. Press . The display will show "400°F" and "4 MIN".
3. Optionally, press  or  buttons to change the temperature. The time will adjust automatically.

Temperature	Time
405°–450°F	5 minutes
380°–400°F	4 minutes
170°–375°F	3 minutes

4. Press  to begin preheating.
5. When preheating is done, the air fryer will beep 3 times. The display will show "End".

**Note:** If no buttons are pressed for 5 minutes, the air fryer will clear all settings and go into standby.

## Air Frying

### Note:

- **Do not** place anything on top of your air fryer. The objects may fall off and damage your air fryer. [Figure 2.1]
- An air fryer is not a deep fryer. **Do not** fill the basket with oil, frying fat, or any liquid.
- When taking the basket out of the air fryer, be careful of hot steam.

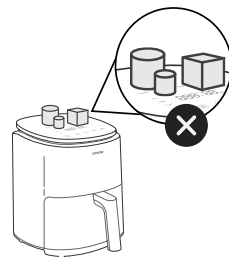







Figure 2.1

# Cooking Functions

Using a cooking function is the easiest way to air fry. Cooking functions are programmed with an ideal time and temperature for cooking certain foods.

1. Press the function's button to select the function. The air fryer will automatically change to the function's default settings.
2. You can change a function's time (1–60 minutes) and temperature (170°–450°F) by pressing  or  buttons to increase or decrease the temperature/time. To return to a function's default settings, press the function's button again.

**Note:** Press and hold the  or  buttons to rapidly increase or decrease the time or temperature.

- To customize a cooking function:
  - a. Choose a function and adjust the time and temperature.
  - b. Press and hold the cooking function icon for 3 seconds.
- To reset all cooking functions:
  - a. Press and hold  for 5 seconds.

**Note:**

- The *Chicken* function and *Fries* function have 2-phase cooking. The temperature and time will automatically adjust during cooking to provide optimal results. If you customize a function with 2-phase cooking, the function **cannot** be reset.
- Certain functions have an automatic Shake Reminder. Halfway through the cooking time, the air fryer will beep 5 times and  will blink on the display (see **Shaking Food**, page 15).

Function	Default Temperature	Default Time (Minutes)	Shake Reminder?*
Chicken	415°F / 435°F	10 (415°F) / 3 (435°F)	/
Fries**	390°F / 425°F	12 (390°F) / 5 (425°F)	Shake
Bacon	320°F	8	/
Steak	450°F	6	Shake
Veggies	395°F	8	Shake
Keep Warm	170°F	5	/
Preheat	400°F	4	/

\*See **Shaking Food** (page 15).

\*\*See **Cooking Guide** (page 16) for tips on air frying french fries.



## Air Frying

1. Place the crisper plate into the basket. The crisper plate allows excess oil to drip down to the bottom of the basket.

**Note:** *The crisper plate may not be used for certain recipes, such as muffins and breads.*

2. **Preheat your air fryer** (see page 12).
3. When the air fryer beeps and the display shows **"End"**, add food to the basket.
4. Select a cooking function (see page 13).
  - a. If no cooking function is selected, the air fryer will default to previously used settings.
  - b. Optionally, you can set a custom time and temperature without choosing a cooking function.
  - c. Press  $\sphericalangle$  or  $\sphericalangle$  buttons to increase or decrease the temperature (170°–450°F) or time (1–60 minutes).
5. Press  $\blacktriangleright$  to begin air frying.

**Note:** *You can change the temperature and time anytime during cooking. Press  $\sphericalangle$  or  $\sphericalangle$  buttons to change the settings.*

6. Certain functions have an automatic Shake Reminder. Halfway through the cooking time, the air fryer will beep 5 times and  will blink on the display (see **Shaking Food**, page 15).
  - a. Take the basket out of the air fryer (be careful of hot steam). The air fryer will pause cooking automatically and the display will turn off until the basket is replaced.
  - b. Shake or flip the food.
  - c. Put the basket back into the air fryer to continue cooking.
7. The air fryer will beep 3 times when finished. The display will show **"End"**.
  - a. Optionally, press . Press the  $\sphericalangle$  or  $\sphericalangle$  buttons to change the time (1–60 minutes).
8. Take the basket out of the air fryer, being careful of hot steam. Use tongs or heat-safe utensils to remove the food from the basket.
9. Allow to cool before cleaning.

# Shaking Food

## How to Shake

During cooking, take the basket out of the air fryer and shake, mix, or flip the food.

- a. To shake food:
  1. For safety purposes, hold the basket just above a heat-resistant surface.
  2. Shake the basket.

**Note:** *Do not use this method if there is a risk of hot liquids splashing.*

- b. If the basket is too heavy to shake or there are hot liquids present:
    1. Place the basket on a heat-resistant holder or surface.
    2. Use tongs to mix or flip the food.
- When you remove the basket, the air fryer will pause cooking automatically, and the display will show [- - -] until the basket is replaced.
  - When you replace the basket, cooking will automatically resume.
  - Avoid shaking longer than 30 seconds, as the air fryer may start to cool down.

## What to Shake

- Small foods that are stacked will usually need shaking, such as fries or nuggets.
- Without shaking, foods may not be crispy or evenly cooked.
- You can flip other foods, such as steak, to ensure even browning.

## When to Shake

- Shake or flip food once halfway through cooking, or more if desired.
- The Shake Reminder is designed to remind you to check on your food. Certain cooking functions use the Shake Reminder automatically (see **Cooking Functions**, page 13).

## Shake Reminder

- The Shake Reminder will alert you with 5 beeps, and  will blink on the display.
- If you do not remove the basket, the Shake Reminder will beep again after 1 minute.
- The Shake Reminder will go away once you remove the basket.

# Cooking Guide

## Overfilling

- If the basket is overfilled, food will cook unevenly. **Do not** pack in food.

## Using Oil

- Adding a small amount of oil to your food will make it crispier. Use no more than 2 US tbsp / 30 mL of oil.
- Oil sprays are excellent for applying small amounts of oil evenly to all food items.

## Food Tips

- You can air fry any frozen foods or goods that can be baked in an oven.
- To make cakes, hand pies, or any food with filling or batter, place food in a heat-safe container before placing in the basket.
- Air frying high-fat foods will cause fat to drip to the bottom of the basket. To avoid excess smoke while cooking, pour out fat drippings after cooking.
- Liquid-marinated foods create splatter and excess smoke. Pat these foods dry before air frying.

## French Fries



- Add ½–1 US tbsp / 8–15 mL oil for crispiness.
- When making fries from raw potatoes, soak uncooked fries in water for 15 minutes to remove starch prior to air frying. Pat dry with a towel before adding oil.
- Cut uncooked fries smaller for crispier results.
- Try cutting fries into ¼-inch by 3-inch / 0.6-cm by 7.6-cm strips.

**Note:** For more tips and recipes, check out the *VeSync* app and *Cosori* website.





# More Functions

## Switching Temperature Units

- Press and hold **Temp**  or  for 3 second.
- The temperature unit will change from Fahrenheit to Celsius.
- Repeat to switch back to Fahrenheit.

## Pausing

- Press  to pause cooking. The air fryer will stop heating, and  will blink until you press  again to resume cooking.
- After 30 minutes of inactivity, the air fryer will turn off.
- This function allows you to pause the cooking program without removing the baskets from the air fryer.

## Automatically Resume Cooking

- If you pull out the basket, the air fryer will pause cooking automatically and the display will show **[- - - - ]**.
- When you return the basket, the air fryer will automatically resume cooking based on your previous settings.

## Automatic Shutoff

- If the air fryer has no active cooking programs, it will clear all settings and turn off after 5 minutes of inactivity.
- If the basket is removed, the air fryer will clear all settings and turn off after 30 minutes of inactivity.

## Overheat Protection

- If the air fryer overheats, it will automatically shut down as a safety feature.
- Let the air fryer cool down completely before using it again.

# CARE & MAINTENANCE

---

**Note:**

- **Always** clean the air fryer basket and crisper plate after every use.
  - Lining the basket with foil (except the crisper plate) may make cleanup easier.
1. Turn off and unplug the air fryer. Allow it to cool completely before cleaning. Pull out the basket for faster cooling.
  2. Wipe the outside of the air fryer with a moist cloth, if necessary.
  3. The basket and crisper plate are dishwasher safe. You can also wash the basket and crisper plate with hot, soapy water and a non-abrasive sponge. Soak if necessary.

**Note:** The basket and crisper plate have a nonstick coating. Avoid using metal utensils and abrasive cleaning materials.

4. For stubborn grease:
  - a. In a small bowl, mix 2 US tbsp / 30 mL of baking soda and 1 US tbsp / 15 mL of water to form a spreadable paste.

- b. Use a sponge to spread the paste on the basket and crisper plate and scrub. Let the basket and crisper plate sit for 15 minutes before rinsing.
  - c. Wash basket with soap and water before using.
5. Clean the inside of the air fryer with a slightly moist, non-abrasive sponge or cloth. **Do not** immerse in water. If needed, clean the heating coil to remove food debris. [Figure 3.1]
  6. Dry before using.

**Note:** Make sure the heating coil is completely dry before turning on the air fryer.

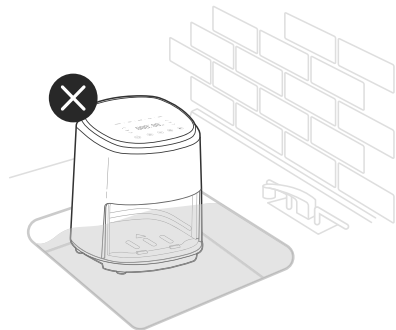

Figure 3.1

# ACCESSORIES

---

Additional and replacement accessories are available for your air fryer. For more information, contact **Customer Support** (see page 22).

# TROUBLESHOOTING

Problem	Possible Solution
The air fryer will not turn on.	Make sure the air fryer is plugged in.
	Push the basket securely into the air fryer.
Food is not completely cooked.	Place smaller batches of food into the basket. If the basket is overstuffed, then food will be undercooked.
	Increase cooking temperature or time.
Food is cooked unevenly.	Foods that are stacked on top of each other or close to each other need to be shaken or flipped during cooking (see <b>Shaking Food</b> , page 15).
Food is not crispy after air frying.	Spraying or brushing a small amount of oil can increase crispiness (see <b>Cooking Guide</b> , page 16).
French fries are not cooked correctly.	See <b>French Fries</b> , page 16.
Basket will not slide into the air fryer securely.	Make sure the basket is not overfilled with food.
White smoke is coming out of the air fryer.	The air fryer may produce some white smoke when you use it for the first time. This is normal.
	Make sure the basket and the inside of the air fryer are properly cleaned and not greasy.
	Cooking greasy foods will cause oil to collect beneath the crisper plate. This oil will produce white smoke, and the basket may be hotter than usual. This is normal, and should not affect cooking. Handle the basket with care.
Dark smoke is coming out of the air fryer.	Immediately unplug your air fryer. Dark smoke means that food is burning or there is a circuit problem. Wait for smoke to clear before pulling the basket out. If the cause was not burnt food, contact <b>Customer Support</b> (see page 22).
The air fryer has a plastic smell.	Any air fryer may have a plastic smell from the manufacturing process. This is normal. Follow the instructions for a <b>Test Run</b> (page 11) to get rid of the plastic smell. If a plastic smell is still present, please contact <b>Customer Support</b> (see page 22).
Display shows Error Code "E1".	There is an open circuit in the temperature monitor. Contact <b>Customer Support</b> (see page 22).
Display shows Error Code "E2".	There is a short circuit in the temperature monitor. Contact <b>Customer Support</b> (see page 22).
Display shows Error Code "E3".	The air fryer's overheat protection has activated. Turn off and unplug the air fryer and allow it to cool completely. If the display continues to show "E3", contact <b>Customer Support</b> (see page 22).
Display shows Error Code "E4".	The air fryer has been plugged into a 220–240V outlet. Turn off and unplug the air fryer. <b>Only</b> use the air fryer with 120V, 60Hz outlets.

If your problem is not listed, please contact **Customer Support** (see page 22).

# FEDERAL COMMUNICATION COMMISSION INTERFERENCE STATEMENT - PART 15

---

This device complies with Part 15 of the FCC Rules. Operation is subject to the following two conditions:

1. This device may not cause harmful interference, and
2. This device must accept any interference received, including interference that may cause undesired operation.

NOTE: This equipment has been tested and found to comply with the limits for a Class B digital device, pursuant to Part 15 of the FCC Rules. These limits are designed to provide reasonable protection against harmful interference in a residential installation. This equipment generates, uses and can radiate radio frequency energy and, if not installed and used in accordance with the instructions, may cause harmful interference to radio communications. However, there is no guarantee that interference will not occur in a particular installation. If this equipment does cause harmful interference to radio or television reception, which can be determined by turning the equipment off and on, the user is encouraged to try to correct the interference by one or more of the following measures:

- Reorient or relocate the receiving antenna.
- Increase the separation between the equipment and receiver.
- Connect the equipment into an outlet on a circuit different from that to which the receiver is connected.
- Consult the dealer or an experienced radio/TV technician for help.

**FCC Caution:** Any changes or modifications not expressly approved by the party responsible for compliance could void the user's authority to operate this equipment.

## FCC RADIATION EXPOSURE STATEMENT

---

This equipment complies with FCC radiation exposure limits set forth for an uncontrolled environment. End users must follow the specific operating instructions for satisfying RF exposure compliance. To maintain compliance with FCC RF exposure compliance requirements, please follow operation instructions as documented in this manual. This transmitter must not be co-located or operating in conjunction with any other antenna or transmitter. This equipment should be installed and operated with a minimum distance of 20 cm between the radiator and your body. The availability of some specific channels and/or operational frequency bands are country dependent and are firmware programmed at the factory to match the intended destination. The firmware setting is not accessible by the end user.

### FCC SUPPLIER'S DECLARATION OF CONFORMITY (SDOC)

Arovast Corporation hereby declares that this equipment is in compliance with the FCC Part 15 Subpart B.

The declaration of conformity may be consulted in the support section of our website, accessible from [www.cosori.com](http://www.cosori.com)

# WARRANTY INFORMATION

---

<b>Product Name</b>	Helio 4-Quart Smart Air Fryer
<b>Model</b>	CAF-LI401S
<i>For your own reference, we strongly recommend that you record your order ID and date of purchase.</i>	
<b>Date of Purchase</b>	
<b>Order ID</b>	

## TERMS & POLICY

Arovast Corporation ("Arovast") warrants this product to the original purchaser to be free from defects in material and workmanship, under normal use and conditions, for a period of 2 years from the date of original purchase.

Arovast agrees, at our option during the warranty period, to repair any defect in material or workmanship or furnish an equal product in exchange without charge, subject to verification of the defect or malfunction and proof of the date of purchase.

There is no other express warranty. This warranty does not apply:

- If the product has been modified from its original condition;
- If the product has not been used in accordance with directions and instructions in the user manual;
- To damages or defects caused by accident, abuse, misuse or improper or inadequate maintenance;
- To damages or defects caused by service or repair of the product performed by an unauthorized service provider or by anyone other than Arovast;
- To damages or defects occurring during commercial use, rental use, or any use for which the product is not intended;
- To damages or defects exceeding the cost of the product.

Arovast will not be liable for indirect, incidental, or consequential damages in connection with the use of the product covered by this warranty.

This warranty extends only to the original consumer purchaser of the product and is not transferable to any subsequent owner of the product regardless of whether the product is transferred during the specified term of the warranty.

This warranty does not extend to products purchased from unauthorized sellers. Arovast's warranty extends only to products purchased from authorized sellers that are subject to Arovast's quality controls and have agreed to follow its quality controls.

All implied warranties are limited to the period of this limited warranty.

This warranty gives you specific legal rights and you may also have other rights which vary from state to state. Some states do not allow the exclusion or limitation of incidental or consequential damages, so the above limitation or exclusion may not apply to you.

If you discover that your product is defective within the specified warranty period, please contact Customer Support via [support@cosori.com](mailto:support@cosori.com). **DO NOT** dispose of your product before contacting us. Once our Customer Support Team has approved your request, please return the product with a copy of the invoice and order ID.

Every Cosori product automatically includes a 2-year warranty. To make the customer support process quick and easy, register your product online at [www.cosori.com/warranty](http://www.cosori.com/warranty).

This warranty is made by:

Arovast Corporation  
1202 N. Miller St., Suite A  
Anaheim, CA 92806

# CUSTOMER SUPPORT

---

If you have any questions or concerns about your new product, please contact our helpful Customer Support Team.

## **Arovast Corporation**

1202 N. Miller St., Suite A  
Anaheim, CA 92806

**Email:** [support@cosori.com](mailto:support@cosori.com)

**Toll-Free:** (888) 402-1684

## **Support Hours**

Mon–Fri, 9:00 am–5:00 pm PST/PDT

*\*Please have your invoice and order ID ready before contacting Customer Support.*

## **Attributions**

Apple App Store® is a trademark of Apple Inc.

Google, Android, and Google Play are trademarks of Google LLC.

Amazon, Alexa and all related logos are trademarks of Amazon.com, Inc. or its affiliates.

Wi-Fi® is a registered trademark of Wi-Fi Alliance®.

The Bluetooth® word mark and logos are registered trademarks owned by Bluetooth SIG, Inc. and any use of such marks by Arovast Corporation is under license. Other trademarks and trade names are those of their respective owners.

# SHOW US WHAT YOU'RE MAKING

---

We hope this has been helpful to you. We can't wait to see your beautiful results, and we think you'll want to share glam shots! Our community awaits your uploads—just pick your platform of choice below. Snap, tag, and hashtag away, Cosori chef!

**#LiveLifeTastefully #iCookCosori**

**@CosoriCooks**



**@Cosori**



## MORE COSORI RECIPES

---

Considering *what* to cook? Many recipe ideas are available, both from us, the Cosori community, and through the VeSync app.



**Scan the QR code  
to get the app.**

# COSORI™

**Questions or Concerns?**

Mon-Fri, 9:00 am-5:00 pm PST/PDT  
support@cosori.com | (888) 402-1684