

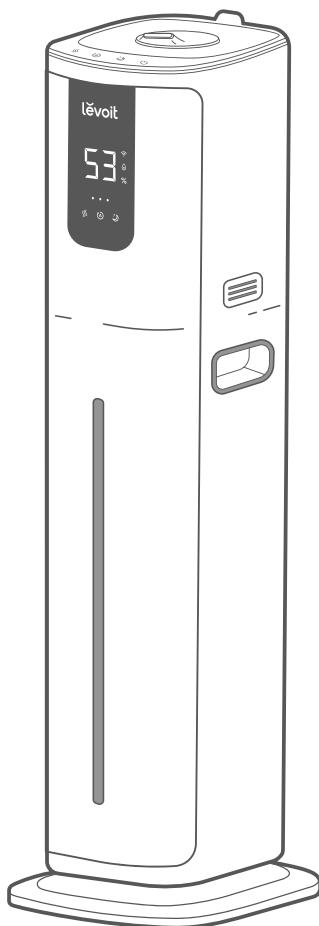

USER MANUAL

Levoit OasisMist1000S Smart Ultrasonic Cool Mist Tower Humidifier



Questions or Concerns?

Please contact us Mon–Fri, 9:00 am–5:00 pm PST/PDT at support@levoit.com or at **(888) 726-8520**.

Table of Contents

Package Contents	2
Specifications	2
Safety Information	3
Getting to Know Your Smart Humidifier	6
Controls	8
Remote Control	9
Getting Started	9
VeSync App Setup	11
Using Your Smart Humidifier	12
Care & Maintenance	16
Troubleshooting	21
VeSync App Troubleshooting	24
Warranty Information	26
Customer Support	27

Package Contents

1 × Smart Ultrasonic Tower Humidifier
3 × Aroma Pad (1 Pre-Installed)
2 × Cleaning Brush
1 × Screwdriver
4 × Screw
1 × Stand
1 × Cable Winder
1 × Remote Control
1 × Quick Start Guide
1 × User Manual

Specifications

Model	LUH-M101S-WUS
Power Supply	AC 120V, 60Hz
Rated Power	27.5W
Water Tank Capacity	2.6 gal / 10 L
Max Mist Output	350 mL/h
Max Runtime	100 hours on low mist setting Note: The humidifier may run for a longer or shorter time depending on the environmental temperature and humidity.
Noise Level	< 28dB
Effective Range	300–600 ft ² / 27–55 m ²
Dimensions	8.4 x 10.0 x 28.7 in / 21.4 x 25.3 x 72.8 cm
Weight	6.4 lb / 2.9 kg

Note: To access additional smart humidifier functions, download the free VeSync app (see page 11).

READ AND SAVE THESE INSTRUCTIONS

SAFETY INFORMATION

To reduce the risk of fire, electric shock, or other injury, follow all instructions and safety guidelines.

General Safety

- **Only** use the humidifier as described in this manual.
- Place the humidifier and cord so that it will not be knocked over. **Do not** place near large pieces of furniture or in high-traffic areas.
- When not in use, turn the humidifier off and disconnect from power by removing the plug from the outlet.
- **Do not** use the humidifier in wet environments.
- Keep the humidifier out of reach from children.
- **Do not** open the base or remove the water level sensor for self-servicing.
- **Always** unplug your humidifier from the power outlet before cleaning your humidifier or detaching the humidifier base from the water tank.
- **Always** make sure to place the humidifier on a flat, level surface before operation.
- **Only** fill the water tank with clean water. **Never** fill the water tank with any other liquids.
- **Do not** place the humidifier near sources of heat, such as stovetops, ovens, or radiators.
- **Do not** use other items as replacement parts for this product.
- **Do not** cover the nozzle while the humidifier is on. Doing so may damage the humidifier.
- **Do not** immerse the humidifier base, power cord, or plug in water.
- If the humidifier is damaged or is not functioning properly, stop using it and contact **Customer Support** immediately (see page 27).
- This humidifier is not to be used by persons (including children) with reduced physical, sensory, or mental capabilities, or lack of experience and knowledge, unless they have been given supervision or instruction concerning use of the appliance by a person responsible for their safety.
- Supervise children when they are near the humidifier.
- Children should not clean or perform maintenance on the humidifier without supervision.
- Children should be supervised to ensure that they **do not** play with the humidifier.
- Not for commercial use. Household use **only**.

SAFETY INFORMATION (CONT.)

Power & Cord

- Ensure that the plug fits properly into a polarized socket.
- Your humidifier has a polarized plug (one prong is wider than the other), which fits into a polarized outlet only one way. This is a safety feature to reduce the risk of electric shock. If the plug does not fit, reverse the plug. If it still does not fit, **do not** use the plug in that outlet. **Do not** bypass this safety feature.
- **Do not** handle the power cord or plug with wet hands. Keep the plug and power cord away from liquids.
- If the power supply cord is damaged, it must be replaced by Arovast Corporation or similarly qualified persons in order to avoid an electric or fire hazard. Please contact **Customer Support** (see page 27).
- Unplugging the power cord will disable remote control of the humidifier and temporarily disconnect the humidifier from VeSync and other third-party apps.

Electromagnetic Fields (EMF)

This humidifier complies with all standards regarding electromagnetic fields (EMF). If handled properly and according to the instructions in this user manual, the appliance is safe to use based on scientific evidence available today.

Caution: Risk of Leaks and Electric Shock

- **Only** add essential oils to the aroma pad.
- **Do not** add essential oils, supplemental water treatment liquids, or water filters into the water inlet tank, base chamber, or water tank.

This product contains a coin/button battery.



WARNING: CHEMICAL BURN HAZARD.
KEEP OUT OF REACH OF CHILDREN.

Swallowing can lead to chemical burns, perforation of soft tissue, and death. Severe burns can occur within 2 hours of ingestion. Seek medical attention immediately.

- Place sticky tape around both sides of the battery and dispose of it immediately in an outdoor trashcan or recycle safely;
- Store spare batteries securely;
- Empty recycling units on a regular basis;
- Use non-transparent containers to keep the batteries out of view.

SAFETY INFORMATION (CONT.)

Unfortunately, it is not obvious when a button or coin battery is stuck in a child's esophagus (food pipe). The child might:

- Cough, gag or drool a lot;
- Appear to have a stomach upset or a virus;
- Be sick;
- Point to their throat or stomach;
- Have pain in their abdomen, chest, or throat;
- Be tired or lethargic;
- Be quieter or more clingy than usual or otherwise “not themselves”;
- Lose their appetite or have a reduced appetite;
- Not want to eat solid food / be unable to eat solid food.

These sorts of symptoms vary or fluctuate, with the pain increasing and then subsiding.

A specific symptom to button and coin battery ingestion is vomiting fresh (bright red) blood. If a child does this, seek immediate medical help.

The lack of clear symptoms is why it is important to be cautious with “flat” or spare button or coin batteries in the home and the products that contain them. Even used cells may cause injury.

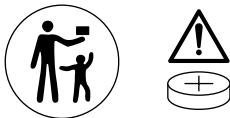

GETTING TO KNOW YOUR SMART HUMIDIFIER

- A. Top Cover
- B. Nozzle
- C. Muffler
- D. Mist Tube
- E. Water Inlet Tank
- F. Base Chamber
- G. Control Panel
- H. LED Display
- I. Humidifier Base

- J. Aroma Pad
- K. Aroma Box / Air Inlet
- L. Handles
- M. Water Tank
- N. Water Level Window
- O. Power Cord
- P. Cable Winder (Behind)
- Q. Stand

Inside Water Tank

- R. Silicone Tube
- S. Filter

Inside Base Chamber

- T. Overflow Valve
- U. Water Inlet
- V. Air Outlet
- W. Pump Cover
- X. Water Level Sensor
- Y. Transducer

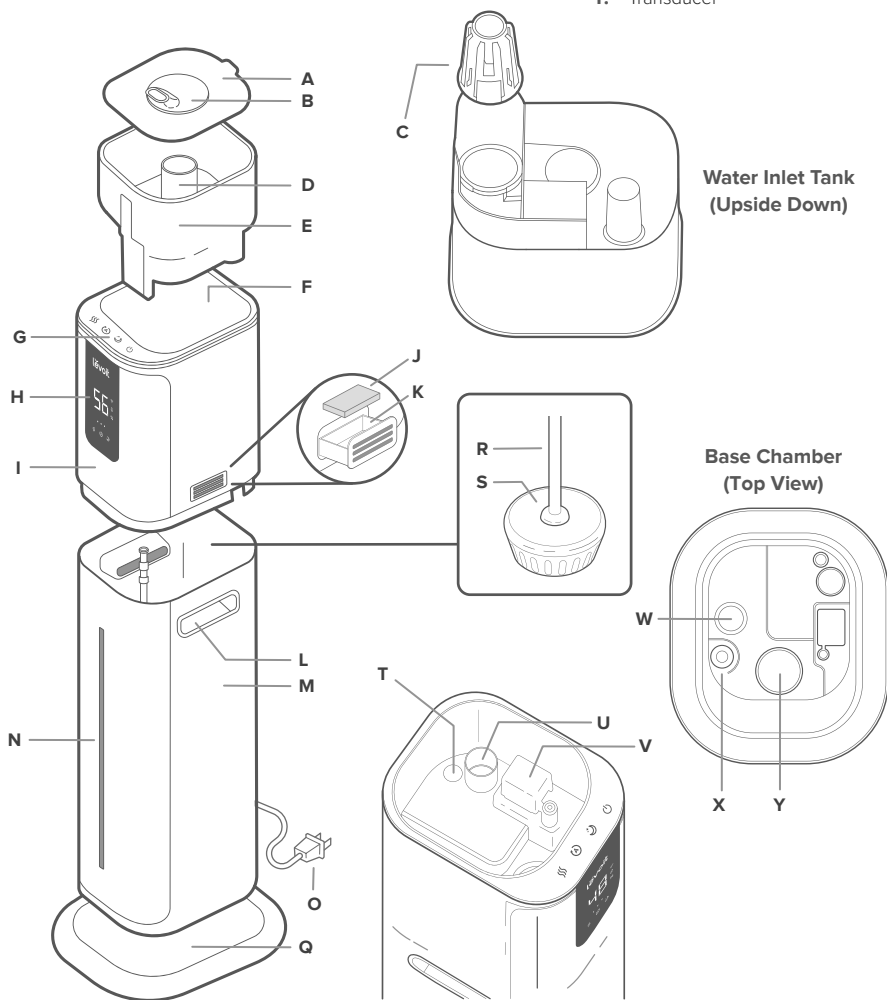

GETTING TO KNOW YOUR SMART HUMIDIFIER (CONT.)

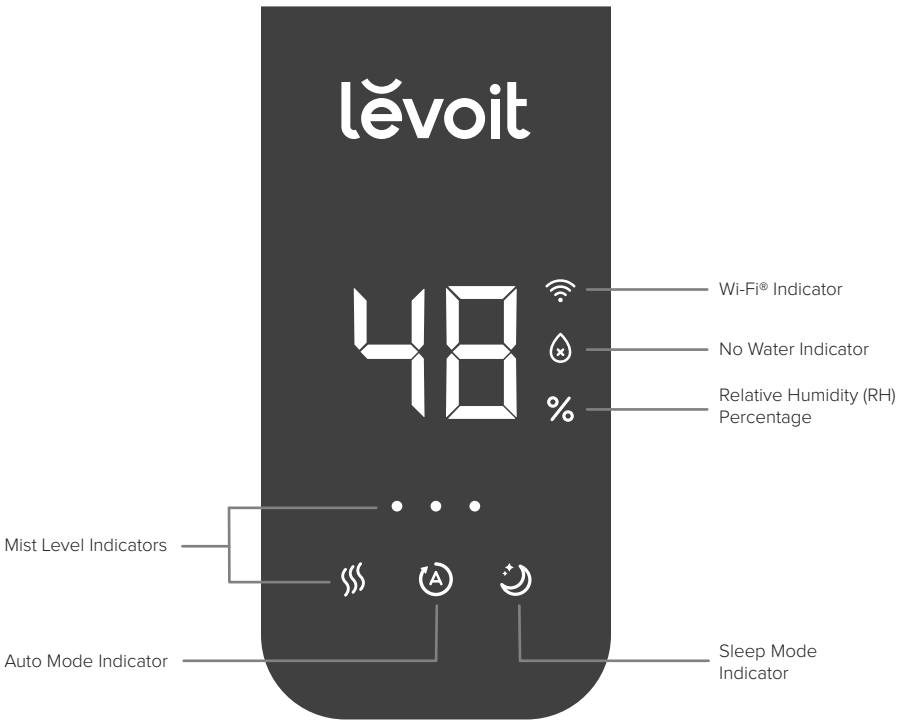
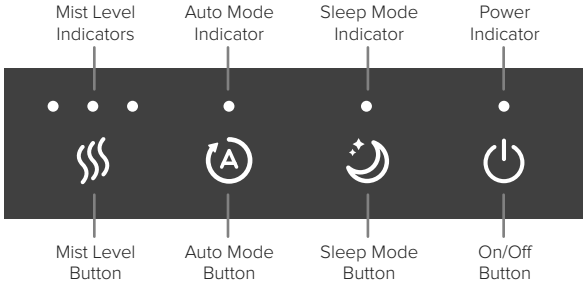

Mist Level Indicators

- ● ● Low Mist
- ● ● Medium Mist
- ● ● High Mist

CONTROLS

Note: You can also use the VeSync app to control these functions, as well as additional app-only features (see page 11).



On/Off Button

- Tap to turn the humidifier on/off.

Note: During first use, the humidifier may take 10–25 seconds to start misting.

- Press and hold for 5 seconds to pair with the VeSync app. See the in-app instructions for more information.
- Press and hold for 15 seconds to reset the humidifier. This will restore the humidifier's default settings and disconnect it from Wi-Fi® and the VeSync app (see page 11).





Mist Level Button

- Tap repeatedly to cycle through mist level settings: low, medium, and high mist.
- Press and hold for 3 seconds to turn the display off. Tap any button (except ) to turn the display back on.



Auto Mode Button

- Tap to turn Auto Mode on (see page 12).
- Tap  /  to turn Auto Mode off and resume manual controls, or tap  for Sleep Mode.



Sleep Mode Button

- Tap to turn Sleep Mode on/off (see page 13).



Wi-Fi Indicator

- Turns on, off, or blinks to indicate pairing status. See the VeSync in-app instructions for more information.



No Water Indicator

- Blinks when there is no water in the tank. After this indicator blinks 10 times, the humidifier will turn off. Refill the tank to resume using your humidifier.
- Lights up when the humidifier base is removed. Remains on until the humidifier base is replaced.

REMOTE CONTROL

The remote control can be used to control any of the humidifier's functions from a distance. The remote must be within 16 ft / 5 m of the humidifier to work.

Note:

- Remove the plastic tab from the remote control's battery compartment before using.
- To replace the battery, see page 20.

Display Off Button

- Press to turn the humidifier display off.
- Press any button to turn the display back on.

Humidity Level Button

- Press to set a target humidity level from 40–80% that's used with Auto Mode.
- Continue pressing to cycle through target humidity options in increments of 10%.

Timer Button

- Press to cycle through timer options from 1–12 hours.
- Press and hold to quickly cycle through options in increments of 1 hour.

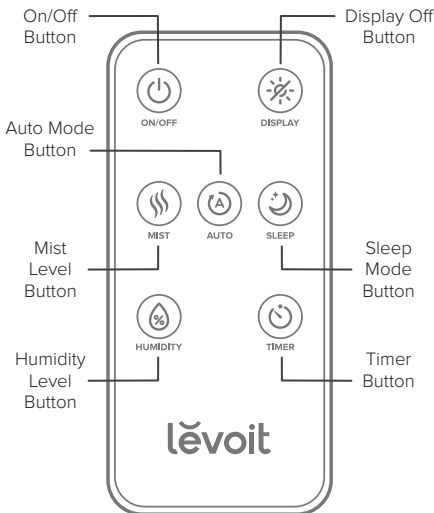

GETTING STARTED

1. Remove all packaging.
2. Flip the water tank over. Use the screwdriver to attach the stand to the water tank with the 4 included screws. [Figure 1.1]

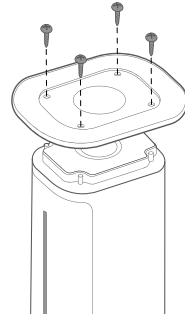

Figure 1.1

Note: Do not overtighten the screws.

3. Take out the filter from inside the water tank. Remove the foam around the filter.
4. Place the humidifier base on the water tank.
5. Optionally, peel off the sticker cover on the cable winder and attach the cable winder to the back of the humidifier base.
6. Choose a hard, flat location for the humidifier at least 12 inches / 30 cm away from any walls. The surface must be water-resistant. [Figure 1.2]

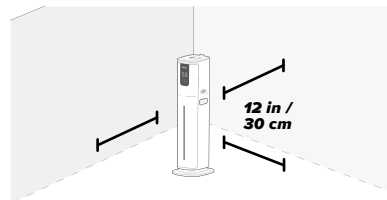

Figure 1.2

Note: Placing the humidifier away from walls ensures that the humidity sensor and air inlets function properly.

GETTING STARTED (CONT.)

- Mist should be directed away from walls, furniture, bedding, and appliances. [Figure 1.3]. Avoid letting too much mist fall on the side of the humidifier with the aroma box, as this may interfere with the sensor inside the aroma box.

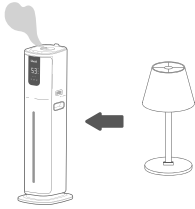

Figure 1.3

Filling & Refilling

Note: Make sure the water tank is clean before filling.

- Remove the top cover. [Figure 1.4]
- Use a pitcher or bottle to fill the water inlet tank with room-temperature water. You can also add water directly to the water tank. [Figure 1.5]

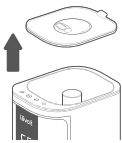

Figure 1.4

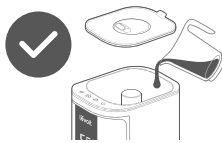

Figure 1.5

Note:

- We recommend using purified or distilled water to fill the tank.
- Do not** fill with hot water.
- Using tap water may result in a white dust (dried minerals) on surfaces.

CAUTION

- Do not** remove the water inlet tank during filling.
- Only** add water into the water inlet tank or water tank. **Do not** add water directly into the base chamber or mist tube.
- Do not** add essential oils into the humidifier. **Only** add essential oils to the aroma pad. [Figure 1.7]

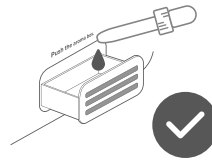

Figure 1.7

- Do not** use water treatment liquids or third-party water filters in this humidifier.

- Use the water level window to see how much of the tank is filled. **Do not** fill past the max line or water may overflow out of the vents in the handles.
- Replace the top cover. [Figure 1.6]

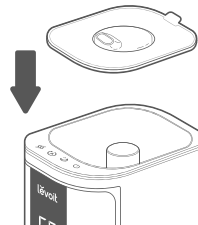

Figure 1.6

VESYNC APP SETUP

Note: Due to ongoing updates and improvements, the VeSync app may be slightly different than shown in the manual. In case of any differences, follow the in-app instructions.

1. To download the VeSync app, scan the QR code or search “VeSync” in the Apple App Store® or Google Play Store.

Note: For Android™ users, choose “Allow” to use VeSync.



2. Open the VeSync app. If you already have an account, tap **Log In**. To create a new account, tap **Sign Up**.

Note: You must create your own VeSync account to use third-party services and products. These will not work with a guest account. With a VeSync account, you can also allow your family and friends to control your smart humidifier.

3. Follow the in-app instructions to set up your smart humidifier.

Note:

- You can use the VeSync app to connect your smart humidifier to Amazon Alexa or Google Assistant™. Follow the in-app instructions to connect VeSync to your voice assistant.
- Your phone must have Location turned on while your phone is connecting to your smart humidifier. This is required to establish the Bluetooth® connection. You can turn Location off after your smart humidifier is finished connecting to the VeSync app.

Wi-Fi Connection

- To disconnect Wi-Fi, press and hold  for 15 seconds until the Wi-Fi indicator turns off. This will restore the smart humidifier's default settings and disconnect it from the VeSync app.
- To reconnect, please follow the instructions in the VeSync app for adding a device.

USING YOUR SMART HUMIDIFIER

Note: Using the VeSync app allows you to control your smart humidifier remotely and access additional functions and features (see page 1).

1. Plug in the humidifier. The indicators on the display will light up for 1 second, then turn off.
2. Tap  to turn your humidifier on. The humidifier will start misting.

Note:

- During first use, the humidifier may take 10–25 seconds to start misting.
- If there is no water in the tank,  will flash 10 times, and the humidifier will turn off. Fill the water tank (see **Getting Started**, page 9).

3. Tap  repeatedly to cycle through mist settings: Low, Medium, and High. [Figure 2.1]

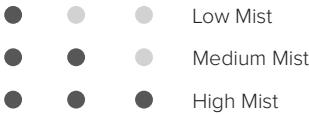

Figure 2.1

4. Rotate the nozzle to adjust the direction of the mist. [Figure 2.2]

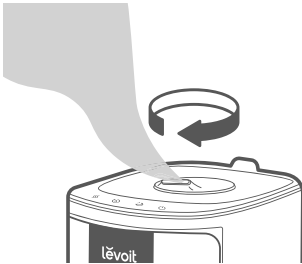



Figure 2.2

Note:

- Direct the nozzle away from any furniture, walls, or other objects to prevent them from getting wet.
 - **Do not** inhale the mist directly from the nozzle.
5. Optionally, use the controls or the VeSync app to turn on Auto Mode, activate Sleep Mode, and more (see **Controls**, page 8).
 6. When your room has reached your preferred humidity level, turn the humidifier to a lower setting, or turn it off. A comfortable humidity level is between 40–60%.

Note: You can also set the humidifier to automatically stop misting when the room reaches a specific humidity level (see **Auto Mode**, page 12).

7. Tap  to turn your humidifier off.

Auto Mode

Auto Mode uses the humidifier's sensor to automatically adjust the mist level to maintain a target humidity level. The default target humidity level is 60%.

1. Tap  to turn Auto Mode on.

Note: The humidifier will automatically mist for 15 seconds after being turned on, even if the room has reached the target humidity level.

2. By default, Auto Mode uses Automatic Stop. The humidifier will stop misting when the highest target humidity level is reached (default 60%).

AUTO MODE (CONT.)

Note:

- In the VeSync app, you can turn Automatic Stop on/off.
- If Automatic Stop is off, the humidifier will keep running on low mist level when the highest target humidity level is reached.

3. The humidifier will continue detecting the humidity level in the room. It will start and stop misting again according to the following table:

Room Relative Humidity *	Automatic Mist Level
Under 50%	High
50–55%	Medium
55–60%	Low
Over 60%	Automatic Stop

*If you change the target humidity from 60%, the humidity percentages will change accordingly.

Setting Target Humidity

You can set a target humidity level from 40–80%, in increments of 10%. There are several ways to change the target humidity:

- Change the target humidity in the VeSync app.
- Press  on the remote control. Continue pressing to cycle through target humidity options.

- Press and hold  on the control panel until the display flashes and shows the target humidity. Continue tapping to cycle through target humidity options.



Sleep Mode

Sleep Mode changes the humidifier's mist setting to low and turns off the display lights.

- Tap  to turn Sleep Mode on/off.
- When Sleep Mode is on, you can tap any button to wake up the display. If you stop touching the display, the display will turn off again after 6 seconds.
- Once you wake up the display, tap any button again to exit Sleep Mode and resume manual controls.

Turning Off the Display

The display will automatically dim after 3 seconds of inactivity.

- To turn off the display, press and hold  for 3 seconds, or press  on the remote control.
- To turn the display back on, tap any button.

Using the Aroma Box

Your humidifier can be used for aromatherapy.

1. Push the aroma box at the back of the base and pull it out. [Figure 3.1]

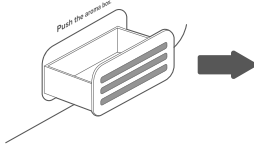

Figure 3.1

2. Put 8–10 drops of essential oils on the aroma pad. [Figure 3.2]

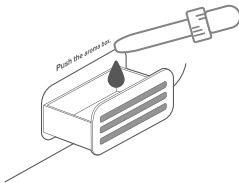

Figure 3.2

3. Insert the aroma box back into the humidifier.
4. Turn on the humidifier. The humidifier will automatically diffuse aroma when used.

Note: Do not add essential oils, water treatment liquids, or third-party water filters into the water inlet tank, base chamber, or water tank. **Only** add essential oils to the aroma pad. [Figure 3.3]

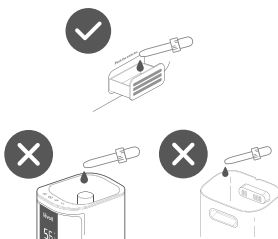

Figure 3.3

- The aroma pads can be cleaned and reused after diffusing essential oils (see **Cleaning the Aroma Pad**, page 19).
- The aroma is intended to be light.
- For information on replacement aroma pads, see page 19.

Memory Function

- If turned off and unplugged, the humidifier will remember your settings for Sleep Mode, Mist Level, and Wi-Fi, and will resume those settings when turned back on.
- If turned off and plugged in, the humidifier will remember your settings for Auto Mode, Sleep Mode, Mist Level, and Wi-Fi, and will resume those settings when turned back on.

Automatic Shutoff

The humidifier will automatically turn off when all of the water in the tank has been diffused. (X) will show on the display and blink 10 times before the humidifier turns off. Fill the water tank (see **Getting Started**, page 9).

If the humidifier base has been removed from the water tank, the humidifier will automatically stop misting. (X) will show on the display and will turn off once the base is placed properly back on the water tank.

VeSync App Functions

The VeSync app allows you to access additional smart functions, including those listed below.

Remote Control From Your Phone

- Turn the humidifier on/off.
- Cycle through mist levels.
- Turn Auto Mode on/off.
- Set a target humidity level.
- Turn Sleep Mode on/off.
- Turn the display lights on/off.

Monitor Humidity Levels

- Check current humidity levels in the humidifier's environment.

Set Timers & Schedules

- Program individual timers or create a schedule for your smart humidifier.

Third-Party Voice Control

- Compatible with Amazon Alexa and Google Assistant™ for voice commands.

Note: The VeSync app is continually updated and app features will expand.

- Avoid moving or shaking the humidifier. [Figure 4.1] This may cause the water tank pump to deliver too much water into the base chamber or reduce the amount of water in the base chamber.



Figure 4.1

- Before moving the humidifier, turn it off and unplug it.

Important Tips

Your humidifier must have the correct level of water in the base chamber to work properly. If there is too much water in the base chamber, the humidifier cannot create mist.

- **Do not** place the humidifier on an inclined surface.
- **Do not** add water directly into the base chamber or mist tube. **Only** add water to the water inlet tank or directly into the water tank. The humidifier will automatically deliver the correct amount of water into the base chamber.
- **Do not** remove the water inlet tank during filling.

CARE & MAINTENANCE

Note:

- All maintenance should be done on a water-resistant surface.
- Change the water daily to avoid bacteria growth.
- Use a tissue or cloth to clean the nozzle regularly.
- If not using the humidifier for 1 week or longer, **do not** leave water inside. Clean and dry the humidifier instead.

Cleaning

You should clean your humidifier water inlet tank, base chamber, and water tank every 3 days, and when you're ready to store it.

Note:

- **Never** immerse the base in water or liquid. **Do not** place any part of the humidifier in a dishwasher.
- **Do not** use detergents to clean the humidifier.

1. Unplug the humidifier.
2. Remove and rinse the water tank cover. [Figure 5.1]
3. Remove the water inlet tank from the humidifier base. [Figure 5.2]

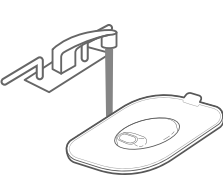

Figure 5.1

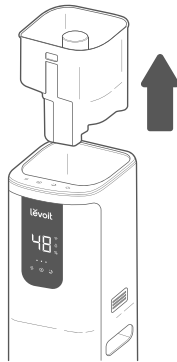

Figure 5.2

4. Pull the mist tube from the narrow end to remove it. [Figure 5.3]

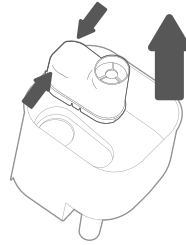

Figure 5.3

5. Flip the water inlet tank over and remove the muffler. [Figure 5.4]

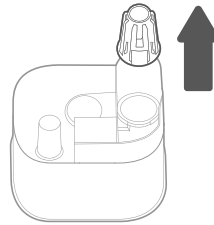

Figure 5.4

6. Rinse the water inlet tank, mist tube, and muffler.
7. Remove the humidifier base and pour out any water. Pour from the corner of the base chamber to prevent water from damaging the humidifier. [Figure 5.5]

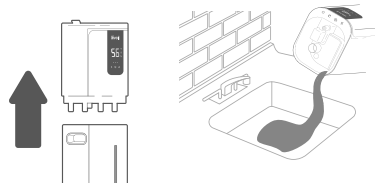

Figure 5.5

CARE & MAINTENENCE (CONT.)

8. Use a small brush to clean the base chamber. Rinse with room-temperature water.

Note: *Do not* allow water to contact the air outlet, aroma box, or underside of the humidifier base.

9. Pour out any water in the water tank. Use a brush to clean the inside of the tank, then rinse with room-temperature water. [Figure 5.6]

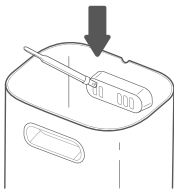

Figure 5.6

10. Pull to remove the filter from the silicone tube. Wash the filter with water and a soft cloth. [Figure 5.7]

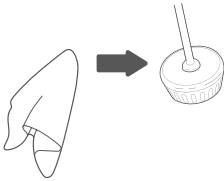

Figure 5.7

Note: *Do not* remove the silicone tube from the water tank.

11. Dry all parts with a cloth. Make sure all parts are completely dry before reassembling or storing.

Descaling Your Humidifier

To descale the humidifier (remove mineral buildup):

1. Remove the humidifier base from the water tank.
2. Fill the water tank with 6 US cups / 1,420 mL of distilled white vinegar. [Figure 6.1]

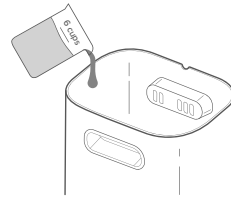

Figure 6.1

3. Fill the base chamber with 1 US cup / 240 mL of distilled white vinegar [Figure 6.2]

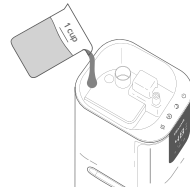

Figure 6.2

4. Carefully swish the vinegar around the tank and base chamber. **Do not** allow liquid to contact the air outlet. [Figure 6.3]

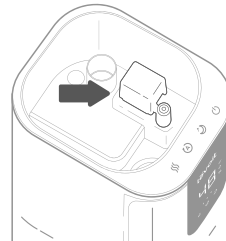

Figure 6.3

DESCALING YOUR HUMIDIFIER (CONT.)

5. Allow the parts to soak for 15–20 minutes. Vinegar will loosen scale (mineral buildup) in the tank and base chamber. *[Figure 6.4]*

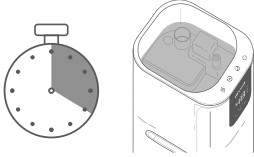

Figure 6.4

8. Pull to remove the filter from the silicone tube. Place the filter in a container and fill with enough vinegar to cover the filter. Soak for 1 hour. *[Figure 6.7]*

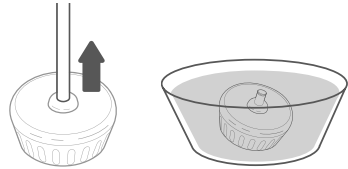

Figure 6.7

6. Pour out the vinegar. *[Figure 6.5]*

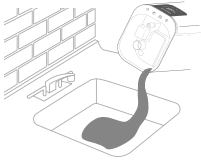

Figure 6.5

9. Rinse all parts until any vinegar smell is completely gone. *[Figure 6.8]*

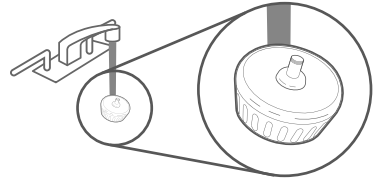

Figure 6.8

7. Use a soft cloth and cleaning brush to remove scale from all parts. *[Figure 6.6]*

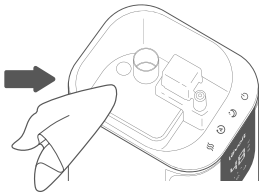

Figure 6.6

Cleaning the Aroma Pad

1. Pull out the aroma box and remove the aroma pad. [Figure 7.1]

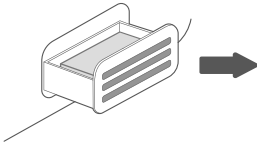

Figure 7.1

2. Rinse the pad under warm, running water. [Figure 7.2]

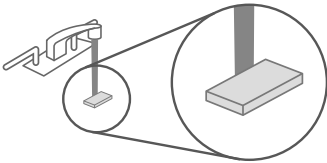

Figure 7.2

3. Dry the pad with a clean cloth.
4. Place the aroma pad back into the aroma box. [Figure 7.3]

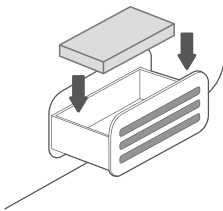

Figure 7.3

Note: Do not use liquid cleaners or detergents to clean the pad or any other part of the humidifier.

Replacing the Aroma Pad

If the aroma pad is stiff even after cleaning, then it needs to be replaced. Extra pads are included with the humidifier.

To maintain the performance of your humidifier, **only** use official Levoit aroma pads. For more information, contact **Customer Support** (see page 27).

Reassembling

1. Push the filter back onto the silicone tube. Place the filter in the water tank. [Figure 8.1]

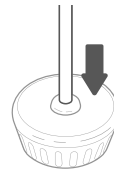

Figure 8.1

2. Replace the mist tube on the water inlet tank. [Figure 8.2]

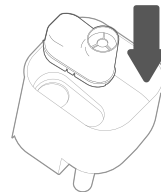

Figure 8.2

REASSEMBLING (CONT.)

3. Flip the water inlet tank over and replace the muffler. [Figure 8.3]

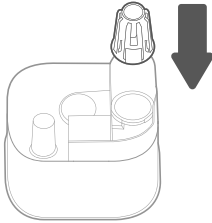

Figure 8.3

4. Place the water inlet tank in the humidifier base and replace the top cover.
5. Place the humidifier base properly on the water tank.
6. Refill the tank, if necessary.

Replacing the Remote Control Battery

1. Remove the battery compartment by pinching the tab in and pulling the compartment out. [Figure 9.1]
2. Remove the old battery
3. Replace with a new 3V CR2025 battery. Make sure the polarities match.
4. Replace the battery compartment.

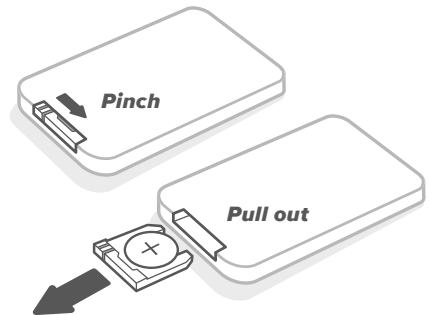

Figure 9.1

Storing

1. Follow the cleaning instructions (see page 16) and allow all parts to dry completely before storing.
2. Wrap the power cord around the cable winder.
3. Store in a cool, dry location.

TROUBLESHOOTING

Problem	Possible Solution
Humidifier doesn't turn on, or turns off unexpectedly.	Plug the humidifier into a working outlet and turn it on.
	Add purified or distilled water to the water tank.
Little or no mist comes out.	Turn the mist level to a higher setting.
	Fill the water tank.
	Wait 30 seconds after turning the humidifier on. During first use, and after cleaning or storage, the humidifier may take 10–25 seconds to start misting.
	Make sure the air inlets on the bottom of the humidifier base and in the aroma box are not blocked.
	Clean the humidifier (see Care & Maintenance , page 16). Make sure the nozzles are not blocked or clogged.
	Make sure the humidifier is on a flat, level surface.
	If the water tank or humidifier base was washed with detergent, rinse thoroughly with clean water to remove any detergent. Do not use detergents to clean the humidifier.
	Clean or replace the pump cover. For information on replacements, contact Customer Support (see page 27).
Humidifier uses water too quickly.	In Auto Mode, the humidifier will stop misting when the target humidity level is reached. Increase the target humidity or manually select a mist level (see Auto Mode , page 12).
	Make sure the humidifier base is properly placed on the water tank.
Humidifier produces an unusual smell.	The humidifier uses up water based on the environmental temperature and humidity. If your environment is cold and/or dry, the humidifier will run out of water faster.
	If the humidifier is new, unplug and rinse all parts, then place in a cool, dry place for 12 hours.
	If essential oils were placed on the aroma pad, rinse the pad under clean water and allow it to dry.
	Clean the humidifier (see Care & Maintenance , page 16).

TROUBLESHOOTING (CONT.)

Problem	Possible Solution
Humidifier makes a loud or unusual noise.	Make sure the water tank is properly in place (see Getting Started , page 9).
	Set mist level to a lower setting.
	Empty the base chamber. Place the humidifier base properly on the water tank, then refill the tank.
	The water pump makes sound when it is refilling the base chamber. This is normal.
The humidifier may be malfunctioning. Stop using the humidifier and contact Customer Support (see page 27).	Mist leaks from the base.
White dust appears around the humidifier.	Make sure the water tank is properly in place (see Getting Started , page 9).
	We recommend using purified or distilled water to fill the humidifier. Avoid using water with high mineral content, such as tap water.
Water visibly leaks from the humidifier.	Clean the humidifier (see Care & Maintenance , page 16).
	Avoid running the humidifier in a room with over 60% relative humidity.
	Wipe any excess water off the top and bottom of the base.
	Do not shake the humidifier.
	Make sure to place the humidifier on a flat, level surface.
The area around the humidifier is damp or wet from condensation.	Check the water tank for leaks. If there are leaks, contact Customer Support (see page 27).
	Humidity may be too high. Turn down the mist level, turn off the humidifier, or open a door or window to the room.
	Open a window to ensure proper airflow for the humidifier, or move the humidifier to a more well-ventilated room.
	Make sure the water tank is properly in place (see Getting Started , page 9).
Mold grows inside the humidifier.	When filling the water tank, wipe off excess water from the water tank and humidifier base.
	Clean the water tank and base chamber regularly (see Care & Maintenance , page 16).
 lights up red.	Fill the water tank.
	Place the humidifier base properly on the water tank.

TROUBLESHOOTING (CONT.)

Problem	Possible Solution
Essential oil has little or no smell.	Add more essential oil. For best results, use pure essential oil.
Display shows an incorrect humidity percentage.	The room may be larger than the humidifier's effective range. Move to a room smaller than 300–600 ft ² / 27–55 m ² .
	Moisture may have built up inside the humidity sensor. Make sure the nozzle is facing away from the aroma box so that mist does not settle on the sensor inside the aroma box (see diagram in Getting To Know Your Smart Humidifier , page 6). Turn off the humidifier, remove the aroma box, and allow the sensor to air dry.
	If the humidifier is placed within 12 inches / 30 cm of a wall or in a corner, the humidity sensor cannot provide a proper reading for the relative humidity in the room.
	The humidity sensor will give an improper reading if it is exposed to dust. Avoid using the humidifier in dusty rooms. Avoid using tap water in the humidifier as this can increase dust in the air.
The humidity level isn't changing in my room.	Use a higher mist level setting.
	Depending on your environment, the humidifier may take longer to humidify your air.
	The room may be larger than the humidifier's effective range. If the room is larger than 300–600 ft ² / 27–55 m ² , the humidifier will not be as effective.
Display shows Error Code "E1", "E2", "E7".	The humidifier is malfunctioning. Contact Customer Support (see page 27).

If your problem is not listed, please contact **Customer Support** (see page 27).

VESYNC APP TROUBLESHOOTING

Why isn't my humidifier connecting to the VeSync app?

- Make sure your phone has Bluetooth® turned on and is not currently connected to another Bluetooth device.
- During the setup process, you must be on a secure 2.4GHz Wi-Fi network. Confirm that the network is working correctly.
- Make sure the Wi-Fi password you entered is correct.
- Make sure your humidifier and phone are within 30 ft / 10 m of each other.
- Reset the humidifier by pressing and holding  for 15 seconds. Then try connecting again.

My humidifier is offline.

- Make sure the humidifier is plugged in. The humidifier may appear to be offline if it is unplugged, or if the outlet does not have power.
- Refresh the VeSync menu by swiping down on the screen.
- Make sure your router is connected to the internet and your phone's network connection is working.
- Reset the humidifier using one of these options:
 - a. Delete the humidifier from the VeSync app. Swipe left (iOS®) or press and hold (Android), then tap **Delete**. Then reconfigure your humidifier with the VeSync app.
 - b. Press and hold  for 15 seconds. Then reconfigure your humidifier with the VeSync app.

Note: Power outages, internet outages, or changing Wi-Fi routers may cause your humidifier to go offline.

The VeSync app is displaying an incorrect humidity percentage while the humidifier is turned on.

- The room may be larger than the humidifier's effective range. Move to a room smaller than 300–600 ft² / 27–55 m².
- Moisture may have built up inside the humidity sensor. Make sure the nozzles are facing away from the aroma box so that mist does not settle on the sensor inside the aroma box (see diagram in **Getting To Know Your Smart Humidifier**, page 6). Turn off the humidifier, remove the aroma box, and allow the sensor to air dry.
- If the humidifier is placed within 12 inches / 30 cm of a wall or in a corner, the humidity sensor cannot provide a proper reading for the relative humidity in the room.
- The humidity sensor will give an improper reading if it is exposed to dust. Avoid using the humidifier in dusty rooms.

If your problem is not listed, please contact **Customer Support** (see page 27).

ATTRIBUTIONS

Apple App Store is a trademark of Apple Inc.

Google, Android, and Google Play are trademarks of Google LLC.

Wi-Fi® is a registered trademark of Wi-Fi Alliance®.

Amazon, Alexa and all related logos are trademarks of Amazon.com, Inc. or its affiliates.

iOS is a registered trademark of Cisco Systems, Inc. and/or its affiliates in the United States and certain other countries.

The Bluetooth® word mark and logos are registered trademarks owned by Bluetooth SIG, Inc. and any use of such marks by Arovast Corporation is under license. Other trademarks and trade names are those of their respective owners.

FEDERAL COMMUNICATION COMMISSION INTERFERENCE STATEMENT - PART 15

This device complies with Part 15 of the FCC Rules. Operation is subject to the following two conditions:

- (1) This device may not cause harmful interference, and
- (2) This device must accept any interference received, including interference that may cause undesired operation.

NOTE: This equipment has been tested and found to comply with the limits for a Class B digital device, pursuant to Part 15 of the FCC Rules. These limits are designed to provide reasonable protection against harmful interference in a residential installation. This equipment generates, uses and can radiate radio frequency energy and, if not installed and used in accordance with the instructions, may cause harmful interference to radio communications. However, there is no guarantee that interference will not occur in a particular installation. If this equipment does cause harmful interference to radio or television reception, which can be determined by turning the equipment off and on, the user is encouraged to try to correct the interference by one or more of the following measures:

- Reorient or relocate the receiving antenna.
- Increase the separation between the equipment and receiver.
- Connect the equipment into an outlet on a circuit different from that to which the receiver is connected.
- Consult the dealer or an experienced radio/TV technician for help.

FCC Caution: Any changes or modifications not expressly approved by the party responsible for compliance could void the user's authority to operate this equipment.

FCC Radiation Exposure Statement

This equipment complies with FCC radiation exposure limits set forth for an uncontrolled environment. End users must follow the specific operating instructions for satisfying RF exposure compliance. To maintain compliance with FCC RF exposure compliance requirements, please follow operation instructions as documented in this manual. This transmitter must not be co-located or operating in conjunction with any other antenna or transmitter. This equipment should be installed and operated with a minimum distance of 20 cm between the radiator and your body. The availability of some specific channels and/or operational frequency bands are country dependent and are firmware programmed at the factory to match the intended destination. The firmware setting is not accessible by the end user.

FEDERAL COMMUNICATION COMMISSION INTERFERENCE STATEMENT - PART 18

This device complies with part 18 of the FCC Rules.

This equipment generates and uses ISM frequency energy and if not installed and used properly, that is in strict accordance with the manufacturer's instructions, may cause interference to radio and television reception. It has been type tested and found to comply with limits for an ISM Equipment pursuant to part 18 of FCC Rules, which are designed to provide reasonable protection against such interference in a residential installation. However, there is no guarantee that interference will not occur in a particular installation. If this equipment does cause interference to radio or television reception, which can be determined by tuning the equipment off and on, the user is encouraged to try to correct the interference by one or more of the following:

- Reorient the receiving antenna of radio or television.
- Relocate the equipment with respect to the receiver.
- Move the equipment away from the receiver.
- Plug the equipment into a different outlet so that the equipment and receiver are on different branch circuits.

Conduct only the user maintenance found in this manual. Other maintenance and servicing can cause harmful interference and can void the required FCC compliance. The manufacturer is not responsible for any radio or TV interference caused by unauthorized modification to the equipment. It is the responsibility of the user to correct such interference.

FCC SDOC SUPPLIER'S DECLARATION OF CONFORMITY

Arovast Corporation hereby declares that this equipment is in compliance with the FCC rules. The declaration of conformity may be consulted in the support section of our website, accessible from www.levoit.com

WARRANTY INFORMATION

Product	Levoit OasisMist1000S Smart Ultrasonic Cool Mist Tower Humidifier
Model	LUH-M101S-WUS
<i>For your own reference, we strongly recommend that you record your order ID and date of purchase.</i>	
Order ID	
Date of Purchase	

Terms & Policy

Arovast Corporation ("Arovast") warrants this product to the original purchaser to be free from defects in material and workmanship, under normal use and conditions, for a period of 2 years from the date of original purchase.

Arovast agrees, at our option during the warranty period, to repair any defect in material or workmanship or furnish an equal product in exchange without charge, subject to verification of the defect or malfunction and proof of the date of purchase.

There is no other express warranty. This warranty does not apply:

- If the product has been modified from its original condition;
- If the product has not been used in accordance with directions and instructions in the user manual;
- To damages or defects caused by accident, abuse, misuse or improper or inadequate maintenance;
- To damages or defects caused by service or repair of the product performed by an unauthorized service provider or by anyone other than Arovast;
- To damages or defects occurring during commercial use, rental use, or any use for which the product is not intended;
- To damages or defects exceeding the cost of the product.

Arovast will not be liable for indirect, incidental, or consequential damages in connection with the use of the product covered by this warranty.

This warranty extends only to the original consumer purchaser of the product and is not transferable to any subsequent owner of the product regardless of whether the product is transferred during the specified term of the warranty.

This warranty does not extend to products purchased from unauthorized sellers. Arovast's warranty extends only to products purchased from authorized sellers that are subject to Arovast's quality controls and have agreed to follow its quality controls.

All implied warranties are limited to the period of this limited warranty.

This warranty gives you specific legal rights and you may also have other rights which vary from state to state. Some states do not allow the exclusion or limitation of incidental or consequential damages, so the above limitation or exclusion may not apply to you.

If you discover that your product is defective within the specified warranty period, please contact Customer Support via support@levoit.com. **DO NOT** dispose of your product before contacting us. Once our Customer Support Team has approved your request, please return the product with a copy of the invoice and order ID.

Every Levoit product automatically includes a 2-year warranty. To make the customer support process quick and easy, register your product online at www.levoit.com/warranty.

This warranty is made by:

Arovast Corporation
1202 N. Miller St., Suite A
Anaheim, CA 92806

CUSTOMER SUPPORT

If you have any questions or concerns about your new product, please contact our helpful Customer Support Team.

Arovast Corporation

1202 N. Miller St., Suite A
Anaheim, CA 92806

Email: support@levoit.com

Toll-Free: (888) 726-8520

Support Hours

Mon–Fri, 9:00 am–5:00 pm PST/PDT

*Please have your order invoice and order ID ready before contacting Customer Support.

lěvoit



/LEVOIT



/LEVOIT



/LEVOITLIFESTYLE



/LEVOITLIFESTYLE



/LEVOITLIFESTYLE



LEVOIT.COM