

levoit Core™ 200S Series



USER MANUAL

# Levoit VeSync Core™ 200S Plus True HEPA Smart Air Purifier

**Model:** LAP-C202S-WUSR

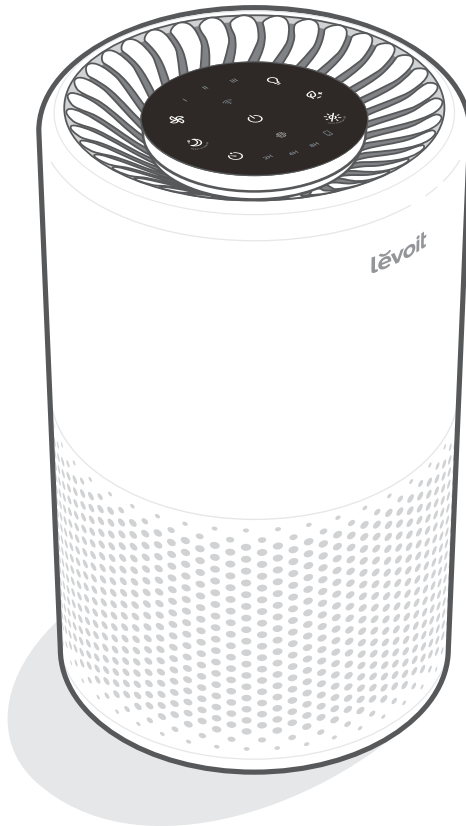

## Questions or Concerns?

Please contact us Mon–Fri, 9:00 am–5:00 pm PST/PDT  
at [support@levoit.com](mailto:support@levoit.com) or at **(888) 726-8520**.

## Table of Contents

Package Contents	2
Specifications	2
Safety Information	3
Getting to Know Your Smart Air Purifier	4
Controls	5
Getting Started	6
VeSync App Setup	7
Using Your Smart Air Purifier	8
VeSync App Functions	9
About the Filter	10
Care & Maintenance	12
Troubleshooting	14
VeSync App Troubleshooting	16
Warranty Information	18
Customer Support	19

## Package Contents

- 1 × Smart Air Purifier
- 1 × 3-Stage Filter (Pre-Installed)
- 1 × User Manual
- 1 × Quick Start Guide

## Specifications

<b>Power Supply</b>	AC 120V, 60Hz
<b>Rated Power</b>	34W
<b>Ideal Room Size</b>	178 ft <sup>2</sup> / 16.5 m <sup>2</sup> <b>Note:</b> <ul style="list-style-type: none"><li>• Effective for larger rooms, but purification will take longer.</li><li>• Ideal Room Size is based on 5 air changes per hour (ACH).</li></ul>
<b>CADR</b>	115 CFM / 200 m <sup>3</sup> /h
<b>Operating Conditions</b>	<b>Temperature:</b> 14°–104°F / -10°–40°C
	<b>Humidity:</b> < 85% RH
<b>Noise Level</b>	27–52dB
<b>Air Purifier Dimensions</b>	8.1 × 8.1 × 12.6 in / 20.5 × 20.5 × 32 cm
<b>Air Purifier Weight</b>	6.6 lb / 3 kg

**Note:** To access additional smart functions, download the free VeSync app (see page 7).

# READ AND SAVE THESE INSTRUCTIONS

## SAFETY INFORMATION

To reduce the risk of fire, electric shock, or other injury, follow all instructions and safety guidelines.

### General Safety

- **Only** use your air purifier as described in this manual.
- **Do not** use without removing the plastic wrap from the filter. The air purifier will not filter air, and may overheat, causing a fire hazard.
- **Do not** use the air purifier outdoors.
- Keep the air purifier away from water, and wet or damp areas. **Never** place in water or liquid.
- **Do not** use in excessively humid areas.
- Keep the air purifier away from heat sources.
- **Do not** use where combustible gases, vapors, metallic dust, aerosol (spray) products, or fumes from industrial oil are present.
- Keep 5 ft / 1.5 m away from where oxygen is being administered.
- Supervise children when they are near the air purifier.
- **Do not** place anything into any opening on the air purifier.
- **Do not** sit or place heavy objects on the air purifier.
- Keep the inside of the air purifier dry. To prevent moisture buildup, avoid placing in rooms with major temperature changes or underneath air conditioners.
- **Always** unplug the air purifier before servicing (such as changing the filter).
- **Do not** use the air purifier if it is damaged or not working correctly, or if the cord or plug is damaged. **Do not** try to repair it yourself. Contact **Customer Support** (see page 19).
- **WARNING:** To reduce the risk of fire or electric shock, **do not** use this air purifier with any solid-state speed controls (such as a dimmer switch).
- Not for commercial use. Household use **only**.
- Keep the air purifier near the outlet it is plugged into.
- Never place the cord near any heat source.
- Do not cover the cord with a rug, carpet, or other covering. Do not place the cord under furniture or appliances.
- Keep the cord out of areas where people walk often. Place the cord where it will not be tripped over.
- This appliance has a polarized plug (one blade is wider than the other). To reduce the risk of electric shock, this plug is intended to fit in a polarized outlet only one way. If the plug does not fit fully in the outlet, reverse the plug. If it still does not fit, contact a qualified electrician. Do not attempt to defeat this safety feature.
- This air purifier uses standard US 120V, 60Hz outlets. If using outside the US, check for compatibility.

### Power & Cord

- The appliance is not to be used by persons (including children) with reduced physical, sensory or mental capabilities, or lack of experience and knowledge, unless they have been given supervision or instruction concerning use of the appliance by a person responsible for their safety.
- Children should be supervised to ensure that they do not play with the appliance.
- Cleaning and user maintenance shall not be made by children without supervision.
- If the supply cord is damaged, it must be replaced by the manufacturer, its service agent or similarly qualified persons in order to avoid a hazard.
- The attachment plug of the appliance and receptacle serve as the manual means for disconnecting remote operation commands, external communication or data signals shall specify that unplugging the appliance disconnects the remote functions.
- This air purifier complies with the maximum allowable concentration of ozone of 0.050 parts per million by volume (ppmv) in a 24-hour period. The Health Canada Guideline 2010 recommends that the maximum exposure limit, based on an averaging time of 8 hours, is 0.020 ppmv or less when tested in a sealed, controlled room approximately 30 m<sup>3</sup>.
- Ce produit est conforme avec la concentration maximale permise d'ozone de 0,050 parties par million par volume (ppmv) pendant une période de 24 heures. La Ligne directrice (2010) de Santé Canada recommande un niveau maximal d'exposition, basé sur un moyen de 8 heures, soit 0,020 ppmv ou moins dans une chambre de teste étanchée et contrôlée de 30 m<sup>3</sup>.

### Electromagnetic Fields (EMF)

Your Levoit air purifier complies with all standards regarding electromagnetic fields (EMF). If handled properly and according to the instructions in this user manual, the appliance is safe to use based on scientific evidence available today.

# GETTING TO KNOW YOUR SMART AIR PURIFIER

- A.** Fan Speed Indicators
- B.** Fan Speed Button
- C.** On/Off Button
- D.** Sleep Mode Button/  
Reset Filter Status Button
- E.** Timer Button
- F.** Timer Indicators
- G.** Wi-Fi® Indicator
- H.** Night Light Button
- I.** Plasma Button
- J.** Check Filter Indicator
- K.** Display Off Button/  
Display Lock Button
- L.** Air Outlet
- M.** Housing
- N.** Air Inlet
- O.** Power Cord
- P.** Filter Cover
- Q.** True HEPA Filter

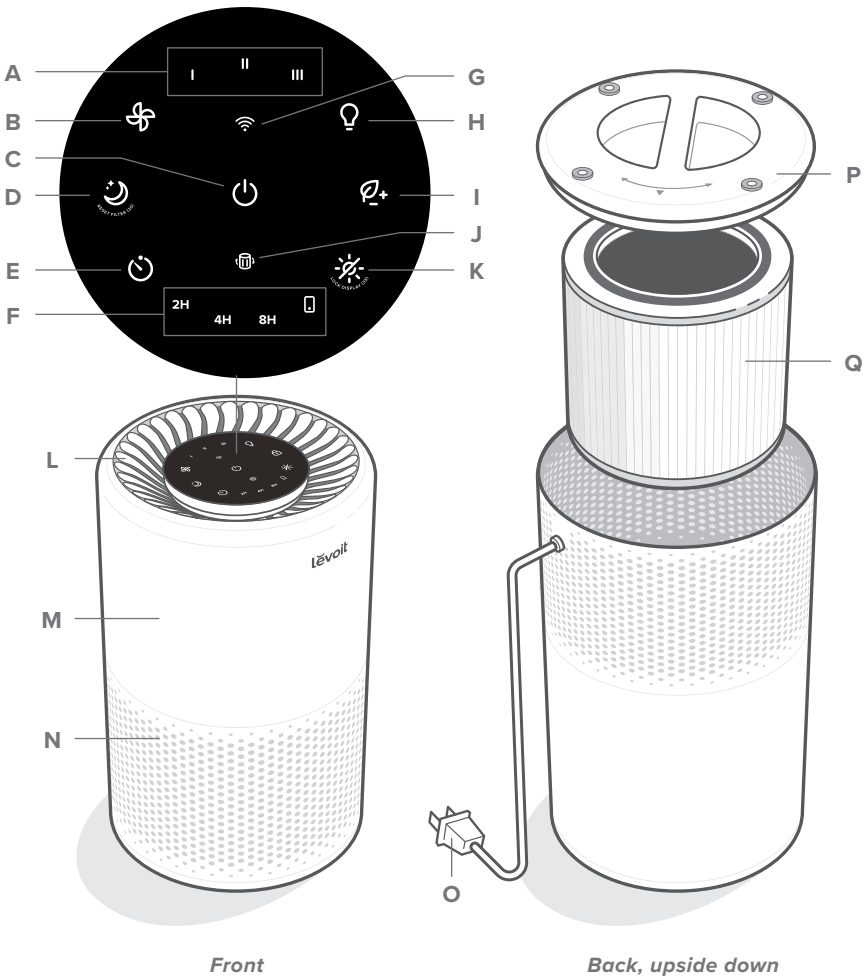

# CONTROLS



## On/Off Button

- Turns the air purifier on/off.
- Press and hold to configure the air purifier. See the VeSync in-app instructions for more information.
- Press and hold to reset the air purifier and disconnect from Wi-Fi (see page 7).



## Timer Button

- Cycles through timer options (see page 8).



## Night Light Button

- Turns the night light on/off (see page 9).



## Wi-Fi Indicator

- Turns on, off, or blinks to indicate configuration status. See the VeSync in-app instructions for more information.



## Display Off Button

- Turns the display off (not including the night light).
- Tap any button (except ) to turn the display back on.
- Press and hold for 3 seconds to lock the display, to prevent current settings from being changed. Blinks when any other button is tapped to indicate that Display Lock is on.



## Fan Speed Button

- Cycles through fan speeds: I (low), II (medium), and III (high).
- Tapping the Fan Speed Button while the air purifier is in Sleep Mode will exit Sleep Mode.



## Plasma Button

- Turns the Plasma function on/off (see page 9).



## Sleep Mode Button

- Turns Sleep Mode on (see page 8).
- Press and hold for 3 seconds to reset the Check Filter Indicator.



## Check Filter Indicator

- Lights up when the filter should be checked (see **Check Filter Indicator**, page 12).
- Reset the Check Filter Indicator light by pressing and holding the Sleep Mode button for 3 seconds.

# GETTING STARTED

1. Flip the air purifier over. Twist the filter cover counterclockwise and remove it. [Figure 1.1]
2. Remove the filter from its plastic packaging and place the filter back into the air purifier. [Figure 1.2]
3. Replace the filter cover and twist clockwise to lock. [Figure 1.3]
4. Place the air purifier on a flat, stable surface with the display facing up. Allow at least 15 in / 38 cm of clearance on all sides of the air purifier. Keep away from anything that would block airflow, such as curtains. [Figure 1.4]

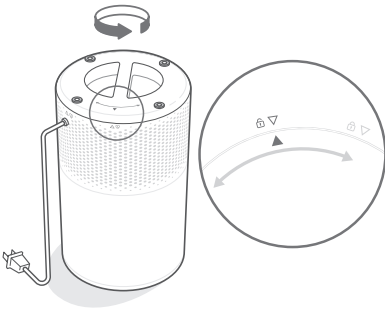

Figure 1.1

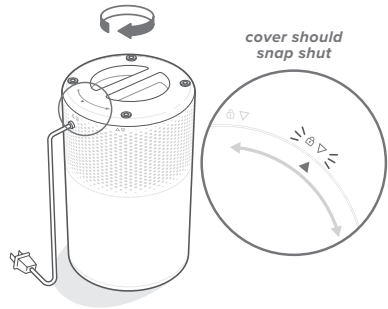

Figure 1.3

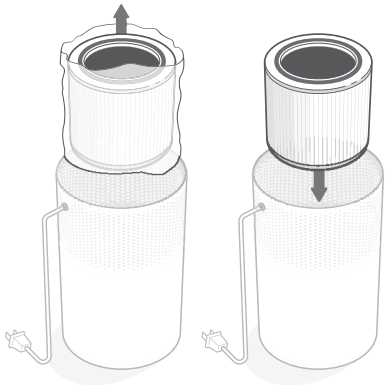

Figure 1.2

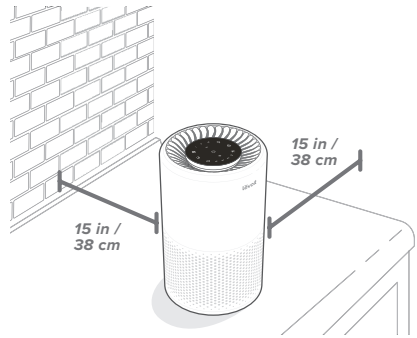

Figure 1.4

# VESYNC APP SETUP

1. To download the VeSync app, scan the QR code or search “VeSync” in the Apple App Store® or Google Play Store.
2. Open the VeSync app. **Log In** or **Sign Up**.
3. Follow the in-app instructions to set up your smart air purifier.



**Note:**

- To disconnect Wi-Fi, press and hold the On/Off button for 15 seconds until the Wi-Fi indicator turns off. This will restore the smart air purifier's default settings and disconnect it from the VeSync app.
- To reconnect, please follow the instructions in the VeSync app for adding a device.

## CONNECT WITH AMAZON ALEXA OR GOOGLE ASSISTANT™



You can use the VeSync app to connect your smart air purifier to **Amazon Alexa** or **Google Assistant™**. Please follow the in-app instructions to set up your voice assistant.

**Note:** You must create your own VeSync account to access voice assistants.

# USING YOUR SMART AIR PURIFIER

**Note:** Using the VeSync app allows you to control your air purifier remotely and access additional functions and features.

## General Operation

1. Plug in and tap  to turn on the air purifier. The fan will start on level I. [Figure 2.1]
2. Optionally, tap  to change fan speed between I, II, and III.

**Note:**

- The indicators are not buttons and cannot be used to change the fan speed.
- The fan speed indicators will light up when active.
- Fan speed III is the loudest, but cleans air the quickest.
- For best results, or to address a specific air quality issue such as smoke, run the air purifier at high speed (level III) for 15–20 minutes before using a lower speed.
- To effectively clean air, keep windows and doors closed while the air purifier is on.

3. Tap  to turn off the air purifier.

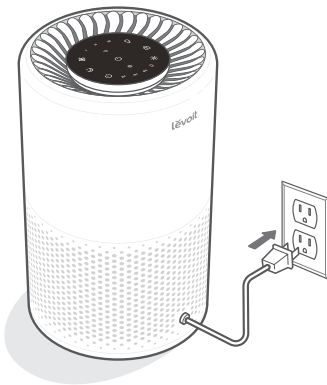



Figure 2.1

## Sleep Mode

Sleep Mode dims all icons to half brightness and operates quietly by using a fan speed lower than fan speed I.

Tap  to turn Sleep Mode on.

**Note:**

- Tapping  will exit Sleep Mode.
- You can still adjust the night light while the air purifier is in Sleep Mode.

## Timer

You can manually set a timer for 2, 4, or 8 hours using the display buttons. You can also set a timer for 1 to 24 hours through the VeSync app.

1. Tap  repeatedly to select a time. The timer will start automatically.

**Note:**

- The indicators are not buttons and cannot be used to select a time.
- The timer indicators will light up blue when active.
-  indicator lights up when a timer is set up through the app.

2. Once the timer has finished, the air purifier will turn off.
3. To cancel a timer, tap  until all timer indicators are off.

**Note:**

- You can change the fan speed at any time while the timer is on.
- The timer will restart if the time is changed.



## Night Light



You can choose between 2 night light brightness levels, even when the air purifier is turned off (as long as it is still plugged in).

1. Tap once to turn on the light.
2. Tap a second time to dim the brightness to half.
3. Tap a third time to turn off the light.

**Note:** Turning off the display will not turn off the night light.

## Display Lock

Locking the display prevents settings from being accidentally changed. Buttons will not respond to being tapped.

1. Press and hold  for 3 seconds to lock/unlock the display.  will blink 3 times to show that the display is locked.
2. If the display is locked and other buttons are tapped,  will blink 3 times to show that the display is locked.

## Plasma Function

The plasma function generates positive and negative ions that bind with pollutants and neutralize them by breaking down their molecular structure.

This helps neutralize particulate matter, bacteria, odorous gases, aerosols, and volatile organic compounds (VOCs).

## Memory Function

Even while turned off, as long as the air purifier is plugged in, it will remember its previous fan speed, Sleep Mode, and Display Lock settings.

When unplugged, the air purifier will remember the fan speed and Sleep Mode, but not Display Lock or Display Off.

**Note:** The memory function does not work with timers or night light settings.

# VESYNC APP FUNCTIONS

The VeSync app allows you to access additional smart air purifier functions, including those listed below. As the app develops, more features may become available.

## Remote Control

- Change any air purifier settings through the app, even while the Display Lock is on.

## Schedules

- Create and customize schedules for your air purifier to match your routines.

## Timer Function

- Set a timer setting between 1 and 24 hours.

## Filter Replacement Info

- Keep tabs on remaining filter life by checking the filter life percentage in the app.
- Shop for replacement filters.

# ABOUT THE FILTER

The air purifier uses a 3-stage filtration system to purify air.

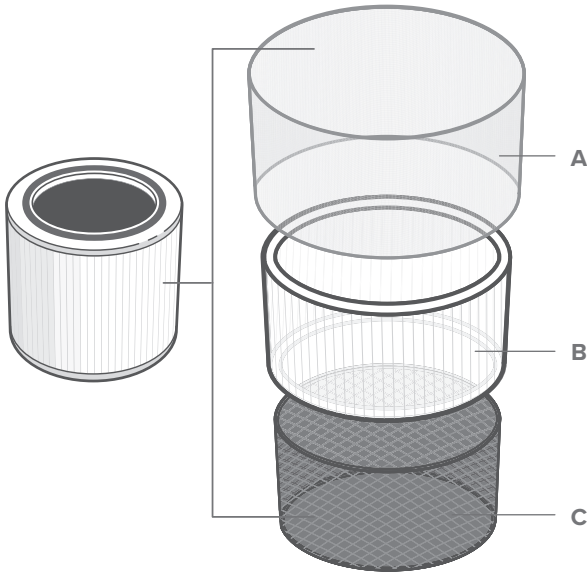

## A. Nylon Pre-Filter

- Captures large particles such as dust, lint, fibers, hair, and pet fur.
- Maximizes the filter's life by protecting it.

## B. H13 True HEPA Filter

- Captures at least 99.97% of airborne particles 0.3 microns ( $\mu\text{m}$ ) in size.
- Filters small particles such as fine dust, smoke particles, and allergens such as pollen and pet dander.

## C. High-Efficiency Activated Carbon Filter

- Physically adsorbs smoke, odors, and fumes.
- Filters compounds such as formaldehyde, benzene, ammonia, hydrogen sulfide and volatile organic compounds (VOCs).

**Note:** *Levoit air purifiers filter airborne particles 0.3 microns in size. Arovast Corporation makes no claims that this air purifier helps reduce the COVID-19 virus.*

## ABOUT THE FILTER (CONT.)

### Clean Air Delivery Rate

This air purifier has a Clean Air Delivery Rate of 115 cubic feet per minute (CFM), or 200 m<sup>3</sup>/h.

Clean Air Delivery Rate (CADR) measures the efficiency of an air purifier by indicating the volume of clean air that it produces per minute. This is based on removal of dust, pollen, and smoke, which are the 3 most common indoor air pollutants. The higher the CADR, the more particles the air purifier will remove and the larger the area it can clean. The rating is measured at the air purifier's highest speed.

### Air Change per Hour

The air change rate is how many times all of the air in a room can be purified (or "changed") by the air purifier in 1 hour. Air changes per hour are calculated on the recommended room size, assuming 8 ft / 2.4 m ceilings. For smaller rooms, the air change per hour will increase. This air purifier has an air change per hour of 5, which means it can change air 5 times per hour at the max speed in a single, closed room up to 178 ft<sup>2</sup> / 16.5 m<sup>2</sup>. The air purifier is effective for larger rooms, but air purification will take longer, with fewer air changes per hour.

**Note:** *To effectively clean air, keep windows and doors closed while the air purifier is on.*

### Humidity

Moisture may damage the filters. This air purifier should be used in an area with a humidity level below 85% RH. If you use the air purifier in excessively humid areas, the surface of the filter will become moldy.

**Note:** *Water or moisture will allow mold to grow. To solve a mold problem, get rid of the source of the moisture and clean up the mold.*

### Essential Oils



**Do not** add essential oils to the air purifier or filter. The filter will become damaged by the oil and will eventually release an unpleasant smell. **Do not** use diffusers near the air purifier.

# CARE & MAINTENANCE

## Cleaning the Smart Air Purifier

- Unplug before cleaning.
- Wipe the outside of the air purifier with a soft, dry cloth. If necessary, wipe the housing with a damp cloth, then immediately dry.
- Vacuum the inside of the air purifier.
- Do not clean with abrasive chemicals or flammable cleaning agents.

## Check Filter Indicator

 will light up as a reminder to check the filter. Depending on how often you use the air purifier, the indicator should turn on within 6–8 months. You may not need to replace your filter yet, but you should check it when  turns on.







When your air purifier is set up with the VeSync app, you can also check the app to see your remaining filter life. You will also receive a notification from VeSync when it's time to check your filter.

## Cleaning the Filter

The outer pre-filter should be cleaned every 2–4 weeks to increase efficiency and extend the life of your filter. Clean the pre-filter using a soft brush or vacuum hose to remove hair, dust, and large particles. **Do not** clean the filter with water or other liquids. [Figure 3.1]

## Resetting the Check Filter Indicator

Reset the Check Filter Indicator when:

- A.  lights up red.
1. Replace the filter (see page 13).
  2. Turn on the air purifier.
  3. Press and hold  for 3 seconds.  will blink 3 times and turn off once successfully reset.
- B. The filter was changed before  lit up.
3. Press and hold  for 3 seconds.  will blink 3 times and turn off once successfully reset.

**Note:** You can also reset the Check Filter Indicator in the VeSync app.

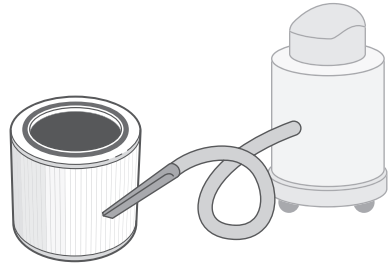



Figure 3.1

Filter	When to Clean	How to Clean	When to Replace
Nylon Pre-Filter	Every 2–4 weeks	Use a soft brush or vacuum hose [Figure 3.1]	6–8 months
True HEPA & High-Efficiency Activated Carbon Filters	Do not clean		

## CARE & MAINTENANCE (CONT.)

### When Should I Replace the Filter?

Check the VeSync app to see your remaining filter life.

The filter should be replaced every 6–8 months. You may need to replace your filter sooner or later depending on how often you use your air purifier. Using your air purifier in an environment with relatively high pollution may mean you will need to replace the filter more often, even if  is off.

You may need to replace your filter if you notice:

- Increased noise when the air purifier is on
- Decreased airflow
- Unusual odors
- A visibly clogged filter

#### Note:

- To maintain the performance of your air purifier, **only** use official Levoit filters. To buy replacement filters, visit Levoit's online store. Go to [levoit.com](https://www.levoit.com) for more information.
- Remember to reset  after changing the filter (see page 12).

### Replacing the Filter

1. Unplug the air purifier. Flip the air purifier over and remove the filter cover (see **Getting Started**, page 6).
2. Remove the old filter.
3. Clean out any remaining dust or hair inside the air purifier using a vacuum hose. **Do not** use water or liquids to clean the air purifier. [Figure 3.2]
4. Unwrap the new filter and place it into the housing (see **Getting Started**, page 6).
5. Replace the cover. Plug in the air purifier.
6. Reset the Check Filter Indicator (see page 12).

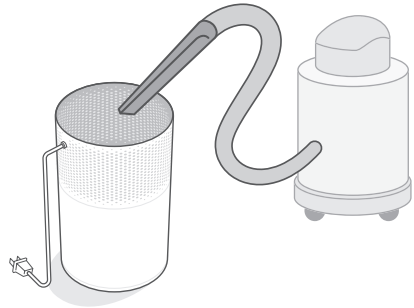



Figure 3.2









### Storage

If not using the air purifier for an extended period of time, wrap both the air purifier and the filter in plastic packaging and store in a dry place to avoid moisture damage.

# TROUBLESHOOTING

Problem	Possible Solution
<p><b>Air purifier will not turn on or respond to button controls.</b></p>	<p>Plug in the air purifier.</p>
	<p>Check to see if the power cord is damaged. If so, stop using the air purifier and contact <b>Customer Support</b> (see page 19).</p>
	<p>Plug the air purifier into a different outlet.</p>
	<p>The air purifier may be malfunctioning. Contact <b>Customer Support</b> (see page 19).</p>
<p><b>Airflow is significantly reduced.</b></p>	<p>Make sure the filter is removed from its packaging and properly in place (see page 6).</p>
	<p>Tap  to increase the fan speed.</p>
	<p>Make sure there are at least 15 in / 38 cm of clearance on all sides of the air purifier.</p>
	<p>The pre-filter may be clogged by large particles, such as hair or lint, blocking air flow. Clean the pre-filter (see page 12).</p>
<p><b>Air purifier makes an unusual noise while the fan is on.</b></p>	<p>Make sure the filter is properly in place with plastic packaging removed (see page 6).</p>
	<p>Make sure the air purifier is operating on a hard, flat, level surface.</p>
	<p>Replace the filter (see page 13).</p>
	<p>The air purifier may be damaged, or a foreign object may be inside. Stop using the air purifier and contact <b>Customer Support</b> (see page 19). <b>Do not</b> try to repair the air purifier.</p>
<p><b>Strange smell coming from the purifier.</b></p>	<p>Clean the filter or replace if necessary.</p>
	<p>Make sure not to use your air purifier in an area with high humidity or while diffusing essential oils.</p>

**TROUBLESHOOTING (CONT.)**

Problem	Possible Solution
<p><b>Poor air purification quality.</b></p>	<p>Tap  to increase the fan speed.</p>
	<p>Make sure no objects are blocking the sides or top of the air purifier (the inlet or outlet).</p>
	<p>Make sure the filter is removed from its packaging and properly in place (see page 6).</p>
	<p>Close doors and windows while using the air purifier.</p>
	<p>If the room is larger than 178 ft<sup>2</sup> / 16.5 m<sup>2</sup>, air purification will take longer. The air purifier may not be as effective in significantly larger rooms.</p>
	<p>Replace the filter (see page 13).</p>
<p> is still on after replacing the filter.</p>	<p>Reset the Check Filter Indicator (see page 12).</p>
<p> has not turned on within 8 months.</p>	<p> is a reminder for you to check the filter and will light up based on how long the air purifier has been used (see page 12). If you don't use your air purifier often,  will take longer to turn on.</p>
<p> turned on before 6 months.</p>	<p> is a reminder for you to check the filter and will light up based on how long the air purifier has been used (see page 12). If you run your air purifier frequently,  will turn on sooner.</p>

**If your problem is not listed, please contact Customer Support (see page 19).**

# VESYNC APP TROUBLESHOOTING

## **My smart air purifier isn't connecting to the VeSync app.**

- Make sure your phone has Bluetooth® turned on and is not currently connected to another Bluetooth device.
- During the setup process, you must be on a secure 2.4GHz Wi-Fi network. Confirm that the network is working correctly.
- Make sure the Wi-Fi password you entered is correct.
  - There should be no spaces at the beginning or end of the password.
  - Test the password by connecting a different electronic device to the router.
  - If you're manually typing in the SSID and password, double check that both are entered correctly.
- Try moving your air purifier closer to the router. Your phone should be as close as possible to your air purifier.
- Your router may need to be at a higher location, away from obstructions.
- Make sure your air purifier and router are away from appliances (such as microwave ovens, refrigerators, electronic devices, etc.) to avoid signal interference.
- If you're using a VPN, make sure it's turned off while setting up your air purifier.
- Disable portal authentication for your Wi-Fi network. If portal authentication is enabled, the air purifier will not be able to access your Wi-Fi network, and setup will fail.

***Note:** Portal authentication means that you need to sign in to your Wi-Fi network through a web page before you can use the Internet.*

## **My air purifier is offline.**

- Make sure the air purifier is plugged in and has power, then refresh the VeSync menu by swiping down on the screen.
- Make sure your router is connected to the internet and your phone's network connection is working.
- Delete the offline air purifier from the VeSync app. Swipe left (iOS®) or press and hold (Android™), then tap Delete.
- Reconfigure the air purifier with the VeSync app.

***Note:** Power outages, internet outages, or changing Wi-Fi routers may cause the air purifier to go offline.*

**If your problem is not listed,** please contact **Customer Support** (see page 19).



# FEDERAL COMMUNICATION COMMISSION INTERFERENCE STATEMENT FCC STATEMENT

This device complies with Part 15 of the FCC Rules. Operation is subject to the following two conditions:

1. This device may not cause harmful interference, and
2. This device must accept any interference received, including interference that may cause undesired operation.

NOTE: This equipment has been tested and found to comply with the limits for a Class B digital device, pursuant to Part 15 of the FCC Rules. These limits are designed to provide reasonable protection against harmful interference in a residential installation. This equipment generates, uses and can radiate radio frequency energy and, if not installed and used in accordance with the instructions, may cause harmful interference to radio communications. However, there is no guarantee that interference will not occur in a particular installation. If this equipment does cause harmful interference to radio or television reception, which can be determined by turning the equipment off and on, the user is encouraged to try to correct the interference by one of the following measures:

- Reorient or relocate the receiving antenna.
- Increase the separation between the equipment and receiver.
- Connect the equipment into an outlet on a circuit different from that to which the receiver is connected.
- Consult the dealer or an experienced radio/TV technician for help.

**FCC Caution:** Any changes or modifications not expressly approved by the party responsible for compliance could void the user's authority to operate this equipment.

## FCC RADIATION EXPOSURE STATEMENT

This equipment complies with FCC radiation exposure limits set forth for an uncontrolled environment. End users must follow the specific operating instructions for satisfying RF exposure compliance. To maintain compliance with FCC RF exposure compliance requirements, please follow operation instructions as documented in this manual. This transmitter must not be co-located or operating in conjunction with any other antenna or transmitter. This equipment should be installed and operated with a minimum distance of 20 cm between the radiator and your body. The availability of some specific channels and/or operational frequency bands are country dependent and are firmware programmed at the factory to match the intended destination. The firmware setting is not accessible by the end user.

# WARRANTY INFORMATION

<b>Product Name</b>	Smart True HEPA Air Purifier
<b>Models</b>	LAP-C201S-WUSR
<i>For your own reference, we strongly recommend that you record your order ID and date of purchase.</i>	
<b>Date of Purchase</b>	
<b>Order ID</b>	

## Terms & Policy

Arovast Corporation (“Arovast”) warrants this product to the original purchaser to be free from defects in material and workmanship, under normal use and conditions, for a period of 1 year from the date of original purchase.

Arovast agrees, at our option during the warranty period, to repair any defect in material or workmanship or furnish an equal product in exchange without charge, subject to verification of the defect or malfunction and proof of the date of purchase.

### **There is no other express warranty. This warranty does not apply:**

- If the product has been modified from its original condition;
- If the product has not been used in accordance with directions and instructions in the user manual;
- To damages or defects caused by accident, abuse, misuse or improper or inadequate maintenance;
- To damages or defects caused by service or repair of the product performed by an unauthorized service provider or by anyone other than Arovast;
- To damages or defects occurring during commercial use, rental use, or any use for which the product is not intended;
- To damages or defects exceeding the cost of the product.

Arovast will not be liable for indirect, incidental, or consequential damages in connection with the use of the product covered by this warranty.

This warranty extends only to the original consumer purchaser of the product and is not transferable to any subsequent owner of the product regardless of whether the product is transferred during the specified term of the warranty.

This warranty does not extend to products purchased from unauthorized sellers. Arovast’s warranty extends only to products purchased from authorized sellers that are subject to Arovast’s quality controls and have agreed to follow its quality controls.

All implied warranties are limited to the period of this limited warranty.

This warranty gives you specific legal rights and you may also have other rights which vary from state to state. Some states do not allow the exclusion or limitation of incidental or consequential damages, so the above limitation or exclusion may not apply to you.

If you discover that your product is defective within the specified warranty period, please contact Customer Support via [support@levoit.com](mailto:support@levoit.com). **DO NOT** dispose of your product before contacting us. Once our Customer Support Team has approved your request, please return the product with a copy of the invoice and order ID.

### **Extend Your Warranty by 1 Year**

Register your product within 14 days of purchase at [www.levoit.com/warranty](http://www.levoit.com/warranty) to extend your 1-year warranty by an additional year.

This warranty is made by:

Arovast Corporation  
1202 N. Miller St. Suite A  
Anaheim, CA 92806

# CUSTOMER SUPPORT

If you have any questions or concerns about your new product, please contact our helpful Customer Support Team.

## **Distributed by Arovast Corporation**

1202 N. Miller St., Suite A  
Anaheim, CA 92806

**Email:** support@levoit.com

**Toll-Free:** (888) 726-8520

## **Support Hours**

Mon–Fri, 9:00 am–5:00 pm PST/PDT

\*Please have your order invoice and order ID ready before contacting Customer Support.

## **Trademark Information**

Amazon, Alexa, and all related logos are trademarks of Amazon.com, Inc. or its affiliates.

Google, Android, and Google Play are trademarks of Google LLC.

Apple App Store is a trademark of Apple Inc.

Wi-Fi® is a registered trademark of Wi-Fi Alliance®.

The Bluetooth® word mark and logos are registered trademarks owned by Bluetooth SIG, Inc. and any use of such marks by Arovast Corporation is under license. Other trademarks and trade names are those of their respective owners.

iOS is a registered trademark of Cisco Systems, Inc. and/or its affiliates in the United States and certain other countries.



The energy efficiency of this ENERGY STAR certified model is measured based on a ratio between the model's CADR for Smoke and the electrical energy it consumes, or CADR/Watt.

lěvoit®



/LEVOITLIFESTYLE



/LEVOIT



/LEVOITLIFESTYLE



/LEVOIT



LEVOIT.COM