

RADIO TEST REPORT

FCC 47 CFR PART 15 SUBPART C

| | |
|--------------------------|---|
| Test Standard | FCC Part 15.247 |
| Product name | Gpacers LoRa module |
| Brand Name | gpacers |
| Model No. | GPM-RF2021 |
| Test Result | Pass |
| Statements of Conformity | Determination of compliance is based on the results of the compliance measurement, not taking into account measurement instrumentation uncertainty. |

The test Result was tested by Compliance Certification Services Inc. The test data, data evaluation, test procedures, and equipment configurations shown in this report were given in ANSI C63.10: 2013 and compliance standards.

The test results of this report relate only to the tested sample (EUT) identified in this report.

The test Report of full or partial shall not copy. Without written approval of Compliance Certification Services Inc. (Wugu Laboratory)

Approved by:



Kevin Tsai
Deputy Manager

Unless otherwise stated the results shown in this test report refer only to the sample(s) tested and such sample(s) are retained for 90 days only.
除非另有說明，此報告結果僅對測試之樣品負責，同時此樣品僅保留90天。本報告未經本公司書面許可，不可部份複製。

This document is issued by the Company subject to its General Conditions of Service printed overleaf, available on request or accessible at <http://www.sgs.com.tw/Terms-and-Conditions> and, for electronic format documents, subject to Terms and Conditions for Electronic Documents at <http://www.sgs.com.tw/Terms-and-Conditions>. Attention is drawn to the limitation of liability, indemnification and jurisdiction issues defined therein. Any holder of this document is advised that information contained hereon reflects the Company's findings at the time of its intervention only and within the limits of client's instruction, if any. The Company's sole responsibility is to its Client and this document does not exonerate parties to a transaction from exercising all their rights and obligations under the transaction documents. This document cannot be reproduced, except in full, without prior written approval of the Company. Any unauthorized alteration, forgery or falsification of the content or appearance of this document is unlawful and offenders may be prosecuted to the fullest extent of the law.

Revision History

| Rev. | Issue Date | Revisions | Effect Page | Revised By |
|------|----------------|----------------------------------|--|------------|
| 00 | April 12, 2021 | Initial Issue | ALL | Doris Chu |
| 01 | April 23, 2021 | See the following Note Rev. (01) | P.8, P.12, P.14, P.17, P.18, P.5 | Doris Chu |

Rev. (01)

- 1.Added X8 Power bank in section 1.7.
- 2.Revised duty cycle in section 3.3.
- 3.Revised section 4.2.2
- 4.Revised section 4.3.4 limit.
- 5.Revised section 4.4.2.
- 6.Revised remark in section 1.3.

Table of contents

| | | |
|---------------------------------|---|----|
| 1. | GENERAL INFORMATION | 4 |
| 1.1 | EUT INFORMATION | 4 |
| 1.2 | EUT CHANNEL INFORMATION | 5 |
| 1.3 | ANTENNA INFORMATION | 5 |
| 1.4 | MEASUREMENT UNCERTAINTY..... | 6 |
| 1.5 | FACILITIES AND TEST LOCATION | 7 |
| 1.6 | INSTRUMENT CALIBRATION | 7 |
| 1.7 | SUPPORT AND EUT ACCESSORIES EQUIPMENT | 8 |
| 1.8 | TEST METHODOLOGY AND APPLIED STANDARDS | 8 |
| 2. | TEST SUMMERY | 9 |
| 3. | DESCRIPTION OF TEST MODES..... | 10 |
| 3.1 | THE WORST MODE OF OPERATING CONDITION | 10 |
| 3.2 | THE WORST MODE OF MEASUREMENT | 11 |
| 3.3 | EUT DUTY CYCLE..... | 12 |
| 4. | TEST RESULT | 13 |
| 4.1 | AC POWER LINE CONDUCTED EMISSION | 13 |
| 4.2 | 6dB BANDWIDTH AND OCCUPIED BANDWIDTH(99%)..... | 14 |
| 4.3 | OUTPUT POWER MEASUREMENT | 16 |
| 4.4 | POWER SPECTRAL DENSITY..... | 18 |
| 4.5 | CONDUCTED BAND EDGE AND SPURIOUS EMISSION | 20 |
| 4.6 | RADIATION BANDEDGE AND SPURIOUS EMISSION | 23 |
| APPENDIX 1 - PHOTOGRAPHS OF EUT | | |

1. GENERAL INFORMATION

1.1 EUT INFORMATION

| | |
|--------------------------|---|
| Applicant | Gpacers Technology 4th Floor, No.168 Yongji Road, Xinyi District, Taipei 110, Taiwan |
| Manufacturer | Gpacers Technology 4th Floor, No.168 Yongji Road, Xinyi District, Taipei 110, Taiwan |
| Equipment | Gpacers LoRa module |
| Model No. | GPM-RF2021 |
| Model Discrepancy | N/A |
| Trade Name | gpacers |
| Received Date | January 15, 2021 |
| Date of Test | February 24 ~ March 11, 2021 |
| Power Supply | Power from Power Supply. (DC 5V) |

Remark:

1. For more details, please refer to the User's manual of the EUT.
2. Disclaimer: Antenna information is provided by the applicant, test results of this report are applicable to the sample EUT received.

Report No.: T210115W01-RP

1.2 EUT CHANNEL INFORMATION

| | |
|--------------------|---------------------|
| Frequency Range | 920.5 MHz-924.5 MHz |
| Modulation Type | CSS |
| Number of channels | 9 Channels |

Remark:

Refer as ANSI C63.10: 2013 clause 5.6.1 Table 4 for test channels

| Number of frequencies to be tested | | |
|---|-----------------------|--|
| Frequency range in which device operates | Number of frequencies | Location in frequency range of operation |
| <input type="checkbox"/> 1 MHz or less | 1 | Middle |
| <input checked="" type="checkbox"/> 1 MHz to 10 MHz | 2 | 1 near top and 1 near bottom |
| <input type="checkbox"/> More than 10 MHz | 3 | 1 near top, 1 near middle, and 1 near bottom |

1.3 ANTENNA INFORMATION

| | |
|-------------------|--|
| Antenna Type | <input type="checkbox"/> CHIP <input type="checkbox"/> PIFA <input type="checkbox"/> PCB <input checked="" type="checkbox"/> Dipole <input type="checkbox"/> Coils |
| Antenna Gain | Gain: 2 dBi |
| Antenna Connector | N/A |

Remark:

1. The industrial epoxy adhesive is used making Antenna connection permanently prior to shipping. It complies with rule 15.203.

Report No.: T210115W01-RP

1.4 MEASUREMENT UNCERTAINTY

| PARAMETER | UNCERTAINTY |
|---------------------------------------|-------------|
| AC Powerline Conducted Emission | +/- 1.2575 |
| Emission bandwidth, 20dB bandwidth | +/- 0.0014 |
| RF output power, conducted | +/- 1.14 |
| Power density, conducted | +/- 1.40 |
| 3M Semi Anechoic Chamber / 30M~200M | +/- 4.12 |
| 3M Semi Anechoic Chamber / 200M~1000M | +/- 4.68 |
| 3M Semi Anechoic Chamber / 1G~8G | +/- 5.18 |
| 3M Semi Anechoic Chamber / 8G~18G | +/- 5.47 |
| 3M Semi Anechoic Chamber / 18G~26G | +/- 3.81 |
| 3M Semi Anechoic Chamber / 26G~40G | +/- 3.87 |

Remark:

1. This uncertainty represents an expanded uncertainty expressed at approximately the 95% confidence level using a coverage factor of k=2
2. ISO/IEC 17025 requires that an estimate of the measurement uncertainties associated with the emissions test results be included in the report.

Report No.: T210115W01-RP

1.5 FACILITIES AND TEST LOCATION

All measurement facilities used to collect the measurement data are located at No.11, Wugong 6th Rd., Wugong Dist., New Taipei City, Taiwan. (R.O.C.)

| Test site | Test Engineer | Remark |
|--------------------|---------------|---|
| AC Conduction Room | N/A | Not applicable, because EUT doesn't connect to AC Main Source direct. |
| Radiation | Ray Li | - |
| RF Conducted | Dally Hong | - |

Remark: The sites are constructed in conformance with the requirements of ANSI C63.7, ANSI C63.4 and CISPR Publication 22.

1.6 INSTRUMENT CALIBRATION

| RF Conducted Test Site | | | | | |
|------------------------|--------------|---------|---------------|------------------|-----------------|
| Equipment | Manufacturer | Model | Serial Number | Calibration Date | Calibration Due |
| Coaxial Cable | Woken | WC12 | CC003 | 06/29/2020 | 06/28/2021 |
| Signal Analyzer | R&S | FSV 40 | 101073 | 09/17/2020 | 09/16/2021 |
| Power Meter | Anritsu | ML2487A | 6K00003260 | 05/21/2020 | 05/20/2021 |
| Power Seneor | Anritsu | MA2490A | 032910 | 05/21/2020 | 05/20/2021 |
| Software | N/A | | | | |

| 3M 966 Chamber Test Site | | | | | |
|----------------------------------|------------------|-----------------|-----------------|------------------|-----------------|
| Equipment | Manufacturer | Model | Serial Number | Calibration Date | Calibration Due |
| Band Reject Filters | MICRO TRONICS | BRM 50702 | 120 | 02/25/2021 | 02/24/2022 |
| Bilog Antenna | Sunol Sciences | JB3 | A030105 | 07/24/2020 | 07/23/2021 |
| Coaxial Cable | HUBER SUHNER | SUCOFLEX 104PEA | 20995 | 02/25/2021 | 02/24/2022 |
| Coaxial Cable | EMCI | EMC105 | 190914+327109/4 | 09/19/2020 | 09/18/2021 |
| Digital Thermo-Hygro Meter | WISEWIND | 1206 | D07 | 01/06/2021 | 01/05/2022 |
| double Ridged Guide Horn Antenna | ETC | MCTD 1209 | DRH13M02003 | 09/30/2020 | 09/29/2021 |
| Loop Ant | COM-POWER | AL-130 | 121051 | 03/27/2020 | 03/26/2021 |
| Pre-Amplifier | EMEC | EM330 | 060609 | 02/25/2021 | 02/24/2022 |
| Pre-Amplifier | HP | 8449B | 3008A00965 | 02/25/2021 | 02/24/2022 |
| PSA Series Spectrum Analyzer | Agilent | E4446A | MY46180323 | 07/24/2020 | 07/23/2021 |
| Antenna Tower | CCS | CC-A-1F | N/A | N.C.R | N.C.R |
| Controller | CCS | CC-C-1F | N/A | N.C.R | N.C.R |
| Turn Table | CCS | CC-T-1F | N/A | N.C.R | N.C.R |
| Software | e3 6.11-20180413 | | | | |

Note:

- The calibration interval of the above test instruments is 12 months and the calibrations are traceable to NML/ROC and NIST/USA.
- N.C.R. = No Calibration Required.

Report No.: T210115W01-RP

1.7 SUPPORT AND EUT ACCESSORIES EQUIPMENT

| EUT Accessories Equipment | | | | | |
|---------------------------|-----------|-------|-------|------------|--------|
| No. | Equipment | Brand | Model | Series No. | FCC ID |
| | N/A | | | | |

| Support Equipment | | | | | |
|-------------------|---------------|---------------------------|-------|------------|--------|
| No. | Equipment | Brand | Model | Series No. | FCC ID |
| 1 | X8 power bank | KXD Electronics Co., Ltd. | X8 | N/A | N/A |

1.8 TEST METHODOLOGY AND APPLIED STANDARDS

The test methodology, setups and results comply with all requirements in accordance with ANSI C63.10:2013, FCC Part 2, FCC Part 15.247.

Report No.: T210115W01-RP

2. TEST SUMMARY

| FCC Standard Section | Report Section | Test Item | Result |
|----------------------|----------------|-----------------------------|--------|
| 15.203 | 1.3 | Antenna Requirement | Pass |
| 15.207(a) | 4.1 | AC Conducted Emission | N/A |
| 15.247(a)(2) | 4.2 | 6 dB Bandwidth | Pass |
| - | 4.2 | Occupied Bandwidth (99%) | Pass |
| 15.247(b)(3) | 4.3 | Output Power Measurement | Pass |
| 15.247(e) | 4.4 | Power Spectral Density | Pass |
| 15.247(d) | 4.5 | Conducted Spurious Emission | Pass |
| 15.247(d) | 4.5 | Conducted Emission | Pass |
| 15.247(d) | 4.6 | Radiation Band Edge | Pass |
| 15.247(d) | 4.6 | Radiation Spurious Emission | Pass |

Report No.: T210115W01-RP

3. DESCRIPTION OF TEST MODES

3.1 THE WORST MODE OF OPERATING CONDITION

| | |
|--------------------------|---|
| Operation mode | LoRa: 920.5 MHz ~ 924.5 MHz |
| Test Channel Frequencies | 1.Lowest Channel : 920.5 MHz 2.Highest Channel : 924.5 MHz |

Remark:

1. EUT pre-scanned data rate of output power for each mode, the worst data rate were recorded in this report.

Report No.: T210115W01-RP

3.2 THE WORST MODE OF MEASUREMENT

| Radiated Emission Measurement Above 1G | |
|--|--|
| Test Condition | Radiated Emission Above 1G |
| Power supply Mode | Mode 1: EUT power by Power Supply |
| Worst Mode | <input checked="" type="checkbox"/> Mode 1 <input type="checkbox"/> Mode 2 <input type="checkbox"/> Mode 3 <input type="checkbox"/> Mode 4 |
| Worst Position | <input checked="" type="checkbox"/> Placed in fixed position at X-Plane (E2-Plane) |

| Radiated Emission Measurement Below 1G | |
|--|--|
| Test Condition | Radiated Emission Below 1G |
| Power supply Mode | Mode 1: EUT power by Power Supply |
| Worst Mode | <input checked="" type="checkbox"/> Mode 1 <input type="checkbox"/> Mode 2 <input type="checkbox"/> Mode 3 <input type="checkbox"/> Mode 4 |

Remark:

1. The worst mode was record in this test report.
2. EUT pre-scanned in axis X and two polarity, for radiated measurement. The worst case(X-Plane) were recorded in this report

3.3 EUT DUTY CYCLE

Temperature: 22.5°C
 Humidity: 56% RH

Test Date: February 24, 2021
 Test by: Dally Hong

| Duty Cycle | | | | |
|---------------|----------------|--|-----------|-------------------|
| Configuration | Duty Cycle (%) | Duty Factor (dB) =10*log (1/Duty Cycle) | 1/T (kHz) | VBW setting (kHz) |
| LoRa | 0.73 | 21.37 | 0.086 | 1.00 |

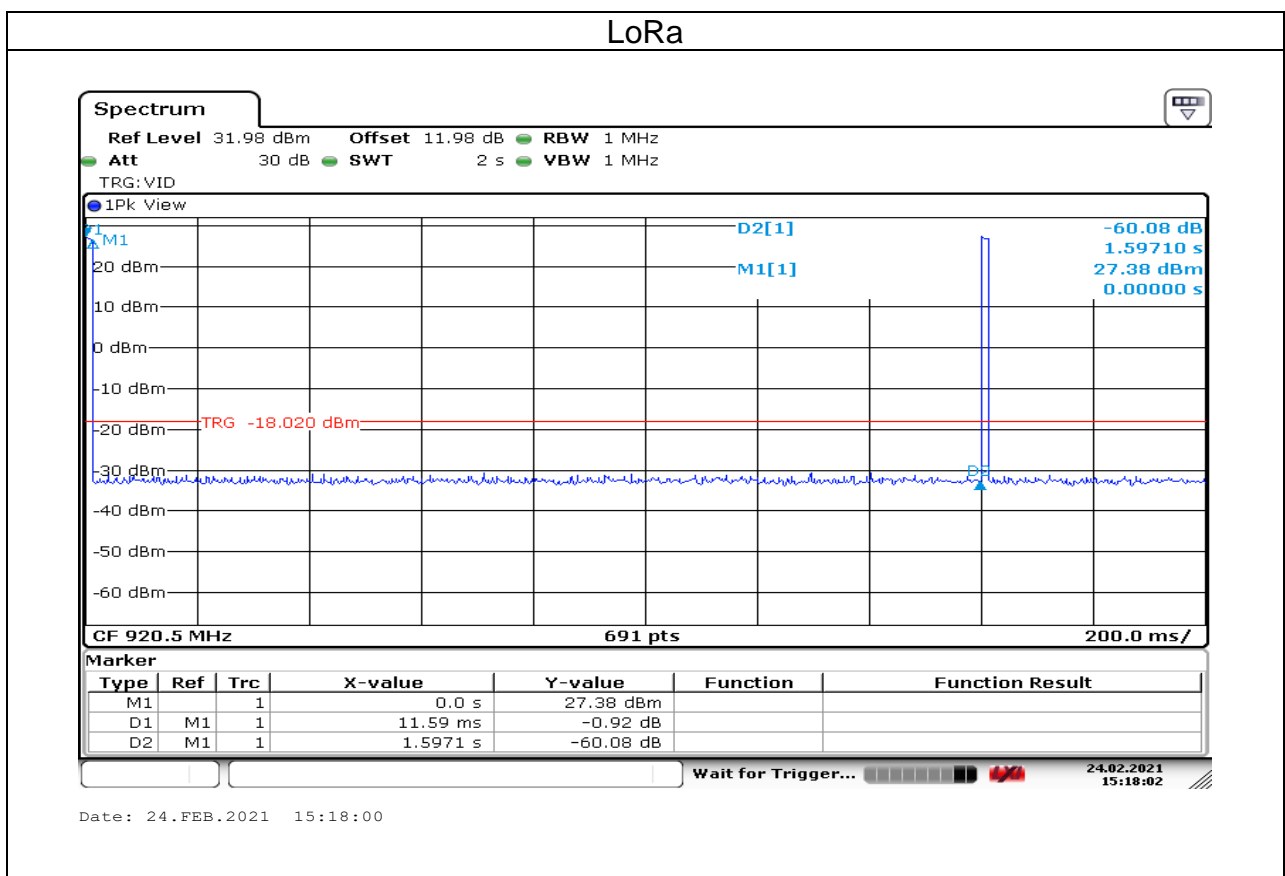

Report No.: T210115W01-RP

4. TEST RESULT

4.1 AC POWER LINE CONDUCTED EMISSION

4.1.1 Test Limit

According to §15.207(a),

| Frequency Range (MHz) | Limits(dB μ V) | |
|-----------------------|--------------------|-----------|
| | Quasi-peak | Average |
| 0.15 to 0.50 | 66 to 56* | 56 to 46* |
| 0.50 to 5 | 56 | 46 |
| 5 to 30 | 60 | 50 |

* Decreases with the logarithm of the frequency.

4.1.2 Test Procedure

Test method Refer as ANSI C63.10: 2013 clause 6.2,

1. The EUT was placed above horizontal ground plane and 0.4m above vertical ground plane
2. EUT connected to the line impedance stabilization network (LISN)
3. Receiver set RBW of 9kHz and Detector Peak, and note as quasi-peak and average.
4. Maximum procedure was performed on the six highest emissions to ensure EUT compliance.
5. Recorded Line for Neutral and Line.

4.1.3 Test Setup

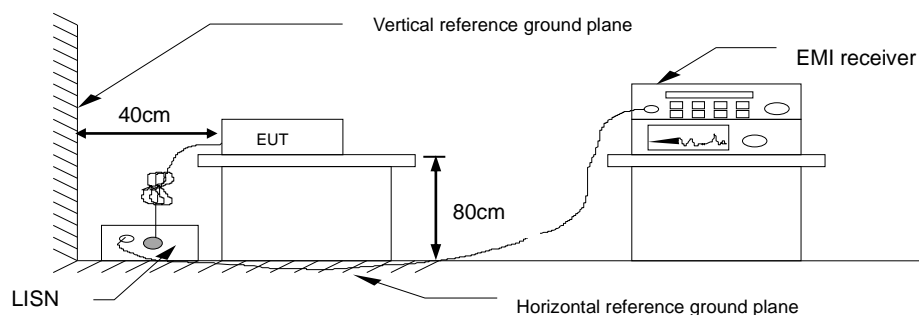

4.1.4 Test Result

Not applicable, because EUT not connect to AC Main Source direct.

Report No.: T210115W01-RP

4.2 6dB BANDWIDTH AND OCCUPIED BANDWIDTH (99%)

4.2.1 Test Limit

According to §15.247(a)(2),

6 dB Bandwidth :

| | |
|-------|--------------------------|
| Limit | Shall be at least 500kHz |
|-------|--------------------------|

Occupied Bandwidth(99%) : For reporting purposes only.

4.2.2 Test Procedure

Test method Refer as ANSI C63.10: 2013 clause 6.9.2,

1. The EUT RF output connected to the spectrum analyzer by RF cable.
2. Setting maximum power transmit of EUT.
3. SA set RBW = 1% ~ 5% OBW, VBW = three times the RBW and Detector = Peak, to measurement 99% Bandwidth and 6dB Bandwidth.
4. Measure and record the result of 6 dB Bandwidth and 99% Bandwidth. in the test report.

4.2.3 Test Setup



4.2.4 Test Result

Temperature: 22.1°C Test Date: March 9, 2021
Humidity: 54% RH Test by: Dally Hong

| Test mode: LoRa mode / 920-925 MHz | | | | |
|------------------------------------|-----------------|-----------------|--------------|-----------------|
| Channel | Frequency (MHz) | OBW (99%) (MHz) | 6dB BW (MHz) | 6dB limit (kHz) |
| Low | 920.5 | 0.6165 | 0.5152 | >500 |
| High | 924.5 | 0.6223 | 0.5123 | |

Report No.: T210115W01-RP

6dB BANDWIDTH Test Data

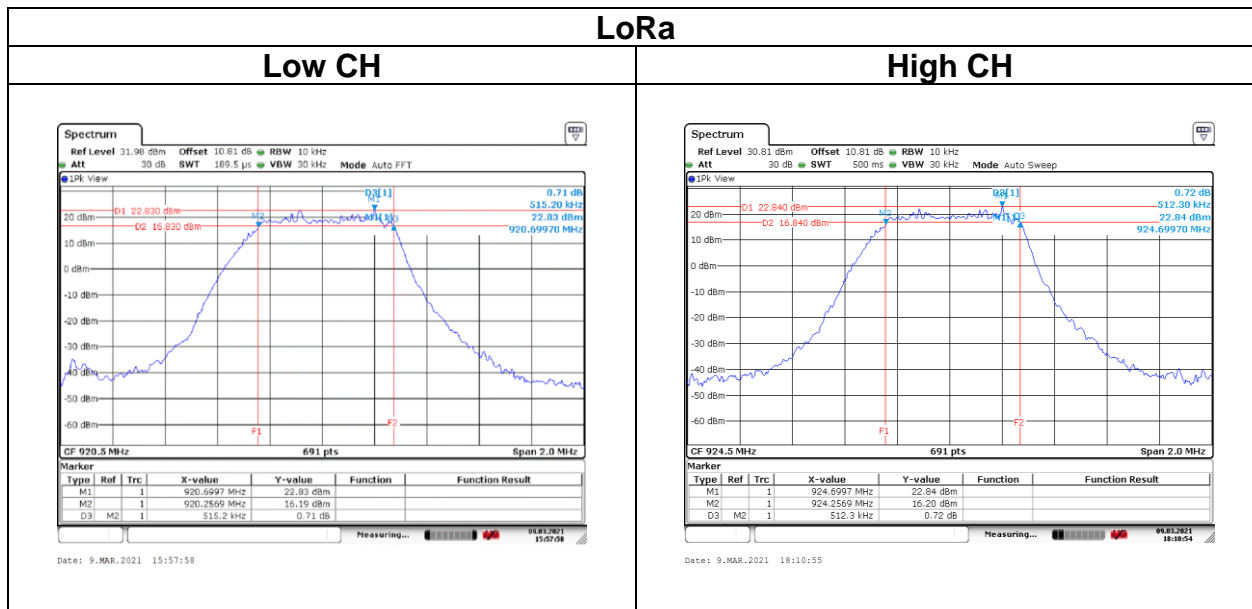

BANDWIDTH (99%) Test Data

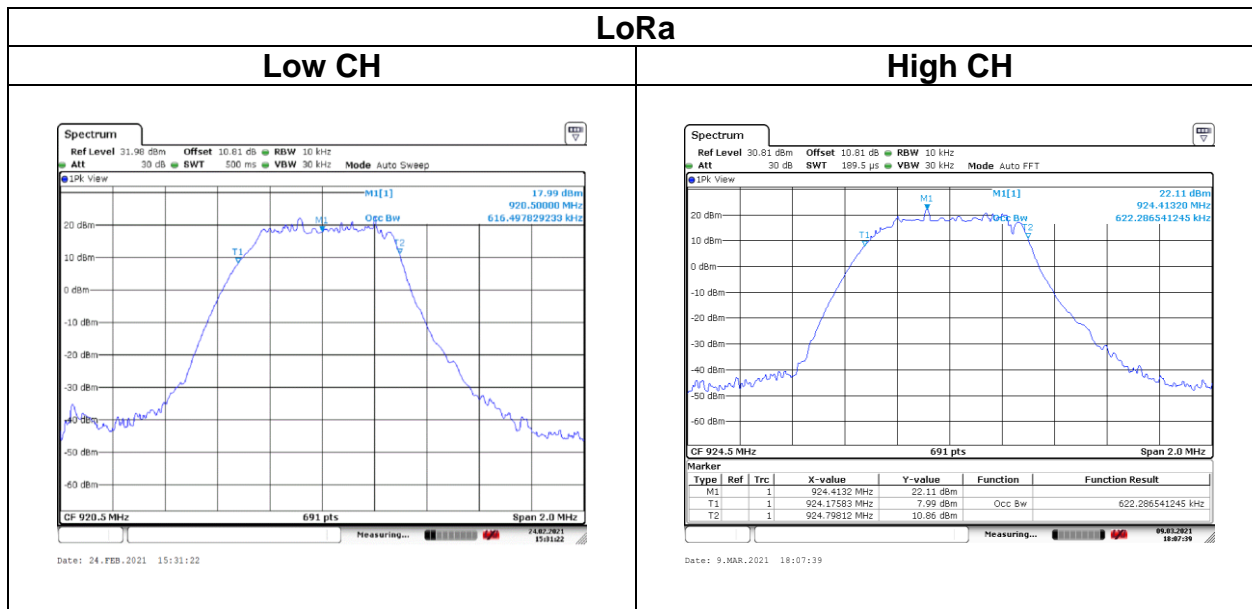

Report No.: T210115W01-RP

4.3 OUTPUT POWER MEASUREMENT

4.3.1 Test Limit

According to §15.247(b)(3).

Peak output power :

For systems using digital modulation in the 902-928 MHz: 1 Watt(30 dBm), base on the use of antennas with directional gain not exceed 6 dBi If transmitting antennas of directional gain greater than 6dBi are used the peak output power the conducted output power from the intentional radiator shall be reduced by the amount in dB that the directional gain of the antenna exceeds 6 dBi. In case of point-to-point operation, the limit has to be reduced by 1dB for every 3 dB that the directional gain of the antenna exceeds 6 dBi.

| | |
|-------|---|
| Limit | <input checked="" type="checkbox"/> Antenna not exceed 6 dBi : 30dBm <input type="checkbox"/> Antenna with DG greater than 6 dBi [Limit = 30 – (DG – 6)] <input type="checkbox"/> Point-to-point operation |
|-------|---|

Average output power : For reporting purposes only.

4.3.2 Test Procedure

Test method Refer as ANSI C63.10:2013.

1. The EUT RF output connected to the power meter by RF cable.
2. Setting maximum power transmit of EUT.
3. The path loss was compensated to the results for each measurement.
4. Measure and record the result of Average output power. in the test report.

4.3.3 Test Setup

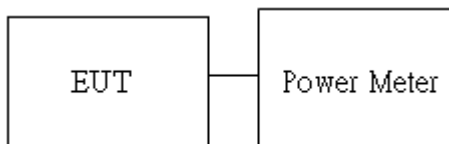

Report No.: T210115W01-RP

4.3.4 Test Result

Temperature: 22.1°C **Test Date:** March 9, 2021
Humidity: 54% RH **Test by:** Dally Hong

Average output power :

| LoRa Mode | | | | | | |
|-----------|------|-------------|---------------|-----------------|---------------|-------------|
| Config. | CH | Freq. (MHz) | Power Setting | AVG Power (dBm) | AVG Power (W) | Limit (dBm) |
| 920~925M | Low | 920.5 | 30 | 26.12 | 0.4093 | 30 |
| | High | 924.5 | 30 | 26.23 | 0.4198 | |

Report No.: T210115W01-RP

4.4 POWER SPECTRAL DENSITY

4.4.1 Test Limit

According to §15.247(e),

For digitally modulated systems, the power spectral density conducted from the intentional radiator to the antenna shall not be greater than 8 dBm in any 3 kHz band during any time interval of continuous transmission.

| | |
|-------|---|
| Limit | <input checked="" type="checkbox"/> Antenna not exceed 6 dBi : 8dBm <input type="checkbox"/> Antenna with DG greater than 6 dBi [Limit = 8 – (DG – 6)] <input type="checkbox"/> Point-to-point operation : |
|-------|---|

4.4.2 Test Procedure

Test method Refer as ANSI C63.10:2013.

1. The EUT RF output connected to the spectrum analyzer by RF cable.
2. Setting maximum power transmit of EUT
3. SA set RBW = 3kHz, VBW = 10kHz, Span = 1.5 times DTS Bandwidth (6 dB BW), Detector = Peak, Sweep Time = Auto and Trace = Max hold.
4. The path loss and Duty Factor were compensated to the results for each measurement by SA.
5. Mark the maximum level.
6. Measure and record the result of power spectral density. in the test report.

4.4.3 Test Setup

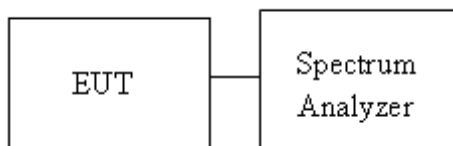

4.4.4 Test Result

Temperature: 22.1°C
Humidity: 54% RH

Test Date: March 9, 2021
Test by: Dally Hong

| Test mode: LoRa mode / 920-925 MHz | | | |
|------------------------------------|-----------------|-----------|-----------------|
| Channel | Frequency (MHz) | PSD (dBm) | FCC limit (dBm) |
| Low | 920.5 | -1.33 | 8 |
| High | 924.5 | -1.25 | |

Test Data

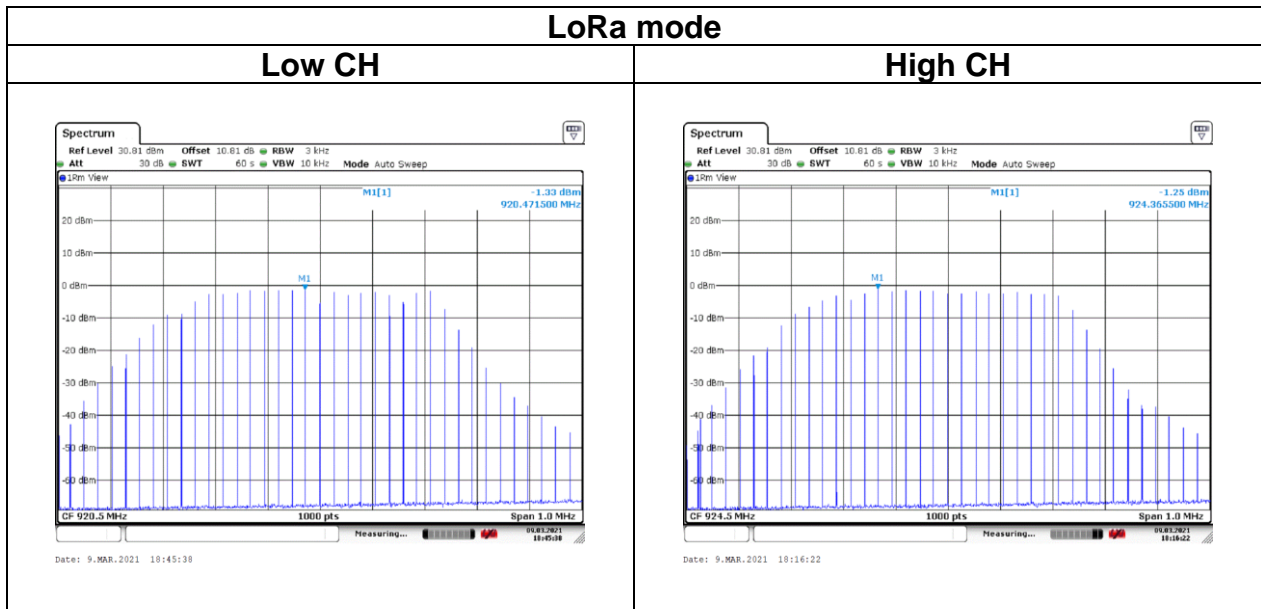

Report No.: T210115W01-RP

4.5 CONDUCTED BAND EDGE AND SPURIOUS EMISSION

4.5.1 Test Limit

According to §15.247(d),

In any 100 kHz bandwidth outside the authorized frequency band,

Non-restricted bands shall be attenuated at least 20 dB/30 dB relative to the maximum PSD level in 100 kHz by RF conducted or a radiated measurement which fall in the restricted bands, as defined in §15.205(a), must also comply with the radiated emission limits specified in §15.209(a).

4.5.2 Test Procedure

Test method Refer as ANSI C63.10:2013.

1. EUT RF output port connected to the SA by RF cable, and the path loss was compensated to result.
2. SA setting, RBW=100kHz, VBW=300kHz, Detector=Peak, Trace mode = max hold, SWT = Auto.
3. In any 100 kHz bandwidth outside the authorized frequency band, shall be attenuated at least 20 dB relative to the maximum in-band peak PSD level in 100 kHz when conducted power procedure is used. If the transmitter complies with the conducted power limits based on the use of RMS averaging over a time interval, the attenuation required under this paragraph shall be 30 dB instead of 20 dB.

4.5.3 Test Setup



Report No.: T210115W01-RP

4.5.4 Test Result

Temperature: 22.1°C
 Humidity: 54% RH

Test Date: March 9, 2021
 Test by: Dally Hong

Test Data

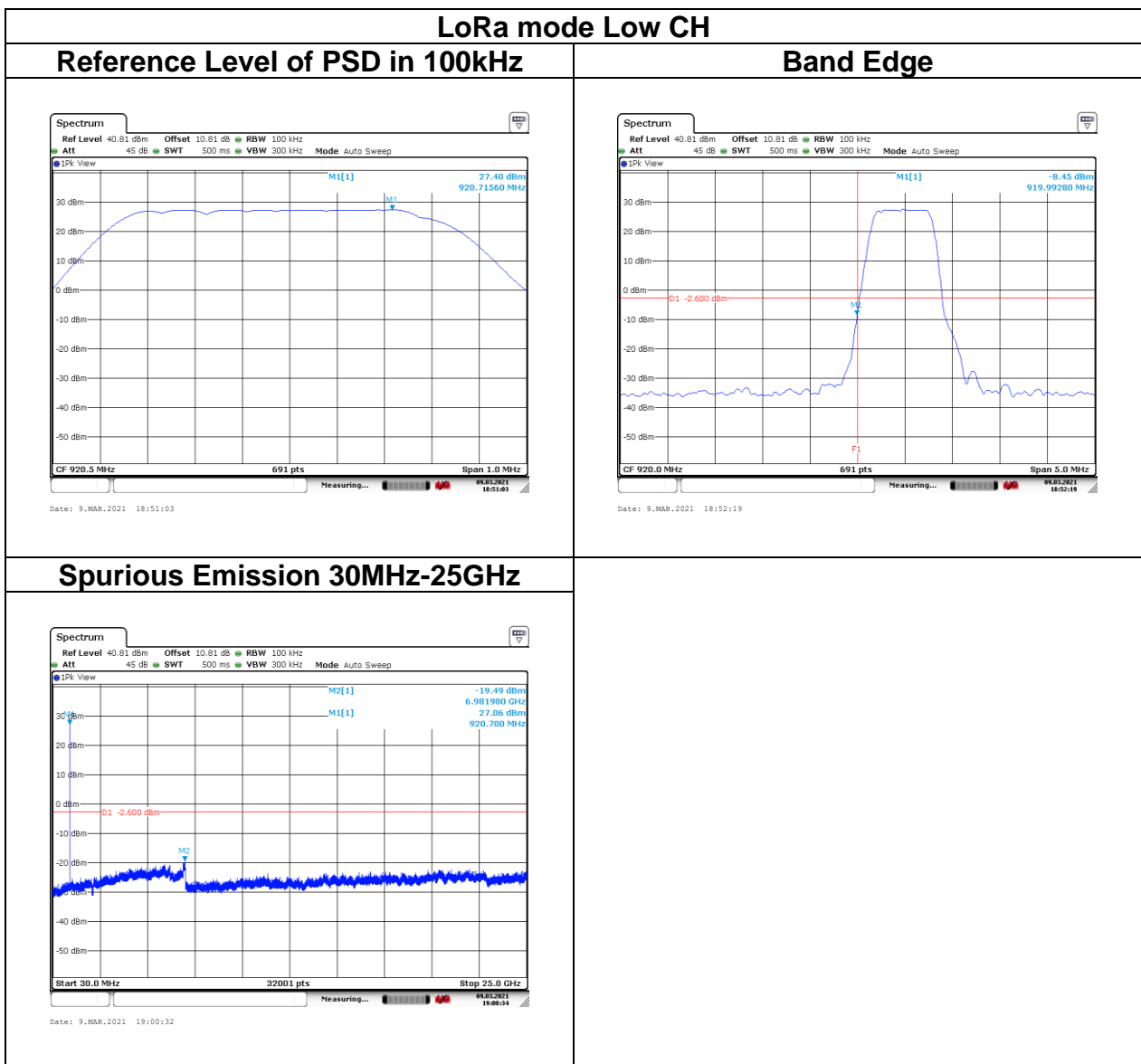

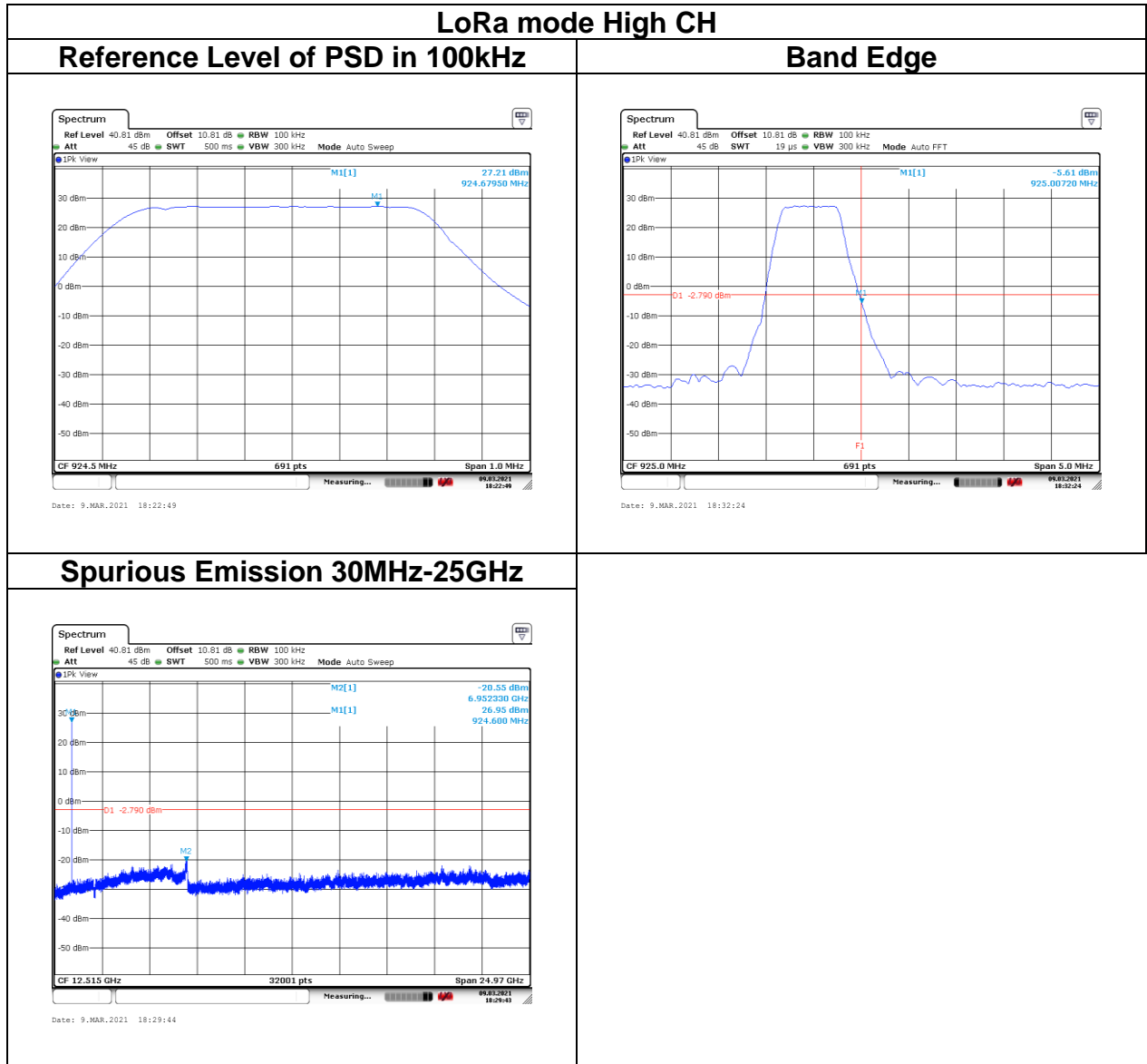

4.6 RADIATION BANDEDGE AND SPURIOUS EMISSION

4.6.1 Test Limit

FCC according to §15.247(d), §15.209 and §15.205,

In any 100 kHz bandwidth outside the authorized frequency band, all harmonic and spurious must be least 20 dB below the highest emission level with the authorized frequency band. Radiation emission which fall in the restricted bands must also follow the FCC section 15.209 as below limit in table.

Below 30 MHz

| Frequency | Field Strength (microvolts/m) | Magnetic H-Field (microamperes/m) | Measurement Distance (metres) |
|---------------|-------------------------------|-----------------------------------|-------------------------------|
| 9-490 kHz | 2,400/F (F in kHz) | 2,400/F (F in kHz) | 300 |
| 490-1,705 kHz | 24,000/F (F in kHz) | 24,000/F (F in kHz) | 30 |
| 1.705-30 MHz | 30 | N/A | 30 |

Above 30 MHz

| Frequency (MHz) | Field Strength microvolts/m at 3 metres (watts, e.i.r.p.) | |
|-----------------|---|--------------|
| | Transmitters | Receivers |
| 30-88 | 100 (3 nW) | 100 (3 nW) |
| 88-216 | 150 (6.8 nW) | 150 (6.8 nW) |
| 216-960 | 200 (12 nW) | 200 (12 nW) |
| Above 960 | 500 (75 nW) | 500 (75 nW) |

Remark:

Although these tests were performed other than open area test site, adequate comparison measurements were confirmed against 30 m open area test site. Therefore sufficient tests were made to demonstrate that the alternative site produces results that correlate with the ones of tests made in an open field based on KDB 414788.

Report No.: T210115W01-RP

4.6.2 Test Procedure

Test method Refer as ANSI C63.10:2013.

1. The EUT is placed on a turntable, Above 1 GHz is 1.5m and below 1 GHz is 0.8m above ground plane. The EUT Configured un accordance with ANSI C63.10: 2013, and the EUT set in a continuous mode.
2. The turntable shall be rotated for 360 degrees to determine the position of maximum emission level. And EUT is set 3m away from the receiving antenna, which is scanned from 1m to 4m above the ground plane to find out the highest emissions. Measurement are made polarized in both the vertical and the horizontal positions with antenna.
3. Span shall wide enough to full capture the emission measured. The SA from 9KHz to 26.5GHz set to the low, Mid and High channels with the EUT transmit.

Remark:

1. Although these tests were performed other than open area test site, adequate comparison measurements were confirmed against 30 m open are test site. Therefore sufficient tests were made to demonstrate that the alternative site produces results that correlate with the ones of tests made in an open field based on KDB 414788.
 2. No emission found between lowest internal used/generated frequency to 30MHz (9kHz~30MHz).
4. The SA setting following :
- (1) Below 1G : RBW = 100kHz, VBW \geq 3 RBW, Sweep = Auto, Detector = Peak, Trace = Max hold.
 - (2) Above 1G :
 - (2.1) For Peak measurement : RBW = 1MHz, VBW \geq 3 RBW, Sweep = Auto, Detector = Peak, Trace = Max hold.
 - (2.2) For Average measurement : RBW = 1MHz, VBW
 - 'If Duty Cycle \geq 98%, VBW=10Hz.
 - 'If Duty Cycle < 98%, VBW=1/T.

4.6.3 Test Setup

9kHz ~ 30MHz

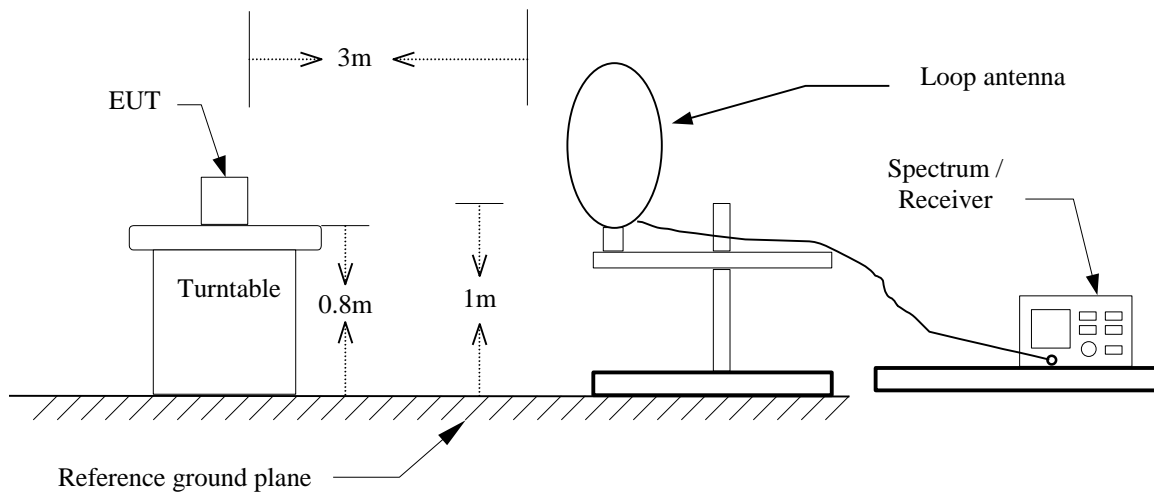

30MHz ~ 1GHz

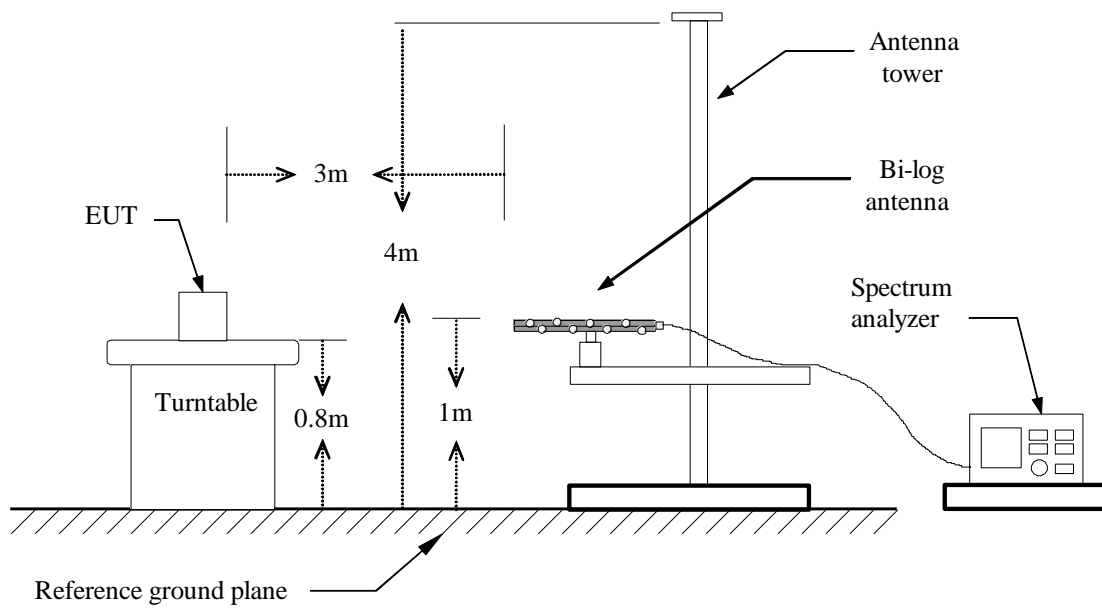

Report No.: T210115W01-RP

Above 1 GHz

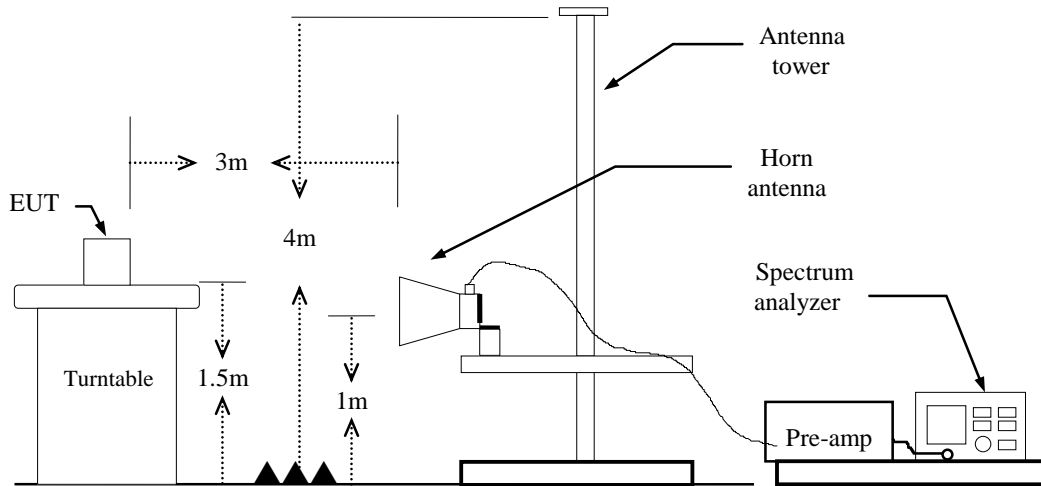

Report No.: T210115W01-RP

4.6.4 Test Result

Band Edge Test Data

| | | | |
|-----------|---------------------|---------------|------------------|
| Test Mode | Low CH 920.5 MHz | Temp/Hum | 21.4(°C) / 60%RH |
| Test Item | Band Edge | Test Date | March 11, 2021 |
| Polarize | Vertical | Test Engineer | Ray Li |
| Detector | Peak / Average | | |

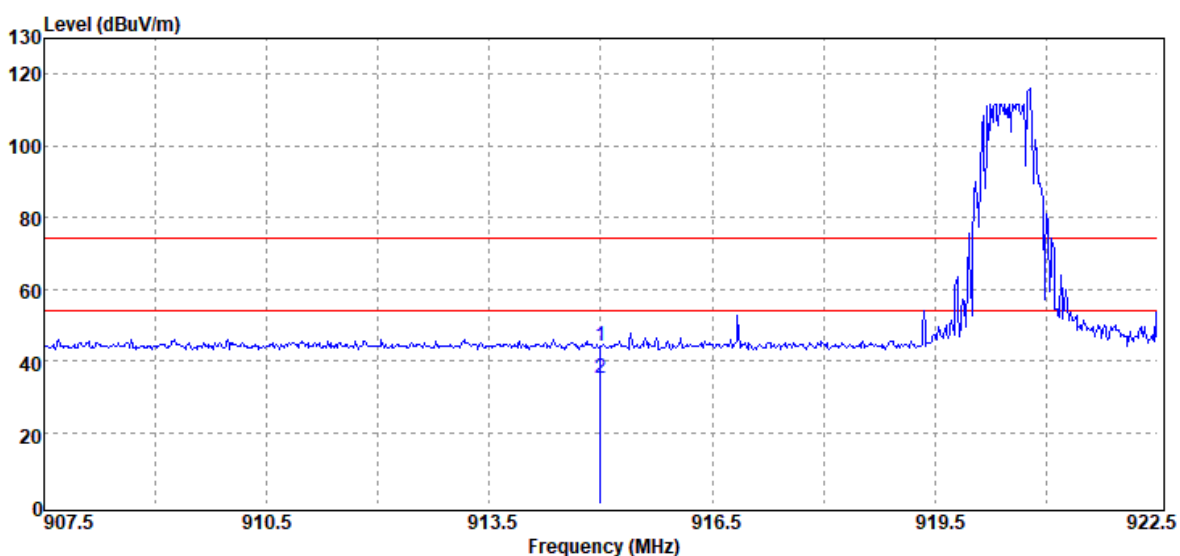

| Frequency (MHz) | Detector Mode (PK/QP/AV) | Spectrum Reading Level (dBμV) | Factor (dB) | Actual FS (dBμV/m) | Limit @3m (dBμV/m) | Margin (dB) |
|-----------------|--------------------------|-------------------------------|-------------|--------------------|--------------------|-------------|
| 915.00 | Peak | 40.60 | 3.26 | 43.86 | 74.00 | -30.14 |
| 915.00 | Average | 31.71 | 3.26 | 34.97 | 54.00 | -19.03 |

Report No.: T210115W01-RP

| | | | |
|-----------|---------------------|---------------|------------------|
| Test Mode | Low CH 920.5 MHz | Temp/Hum | 21.4(°C) / 60%RH |
| Test Item | Band Edge | Test Date | March 11, 2021 |
| Polarize | Horizontal | Test Engineer | Ray Li |
| Detector | Peak / Average | | |

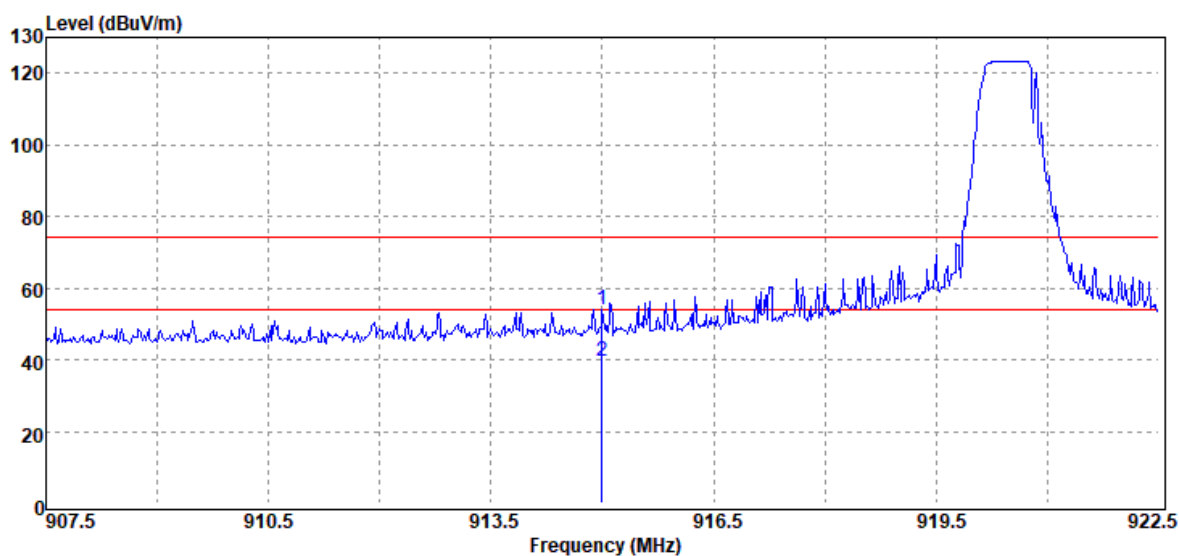

| Frequency (MHz) | Detector Mode (PK/QP/AV) | Spectrum Reading Level (dBμV) | Factor (dB) | Actual FS (dBμV/m) | Limit @3m (dBμV/m) | Margin (dB) |
|-----------------|--------------------------|-------------------------------|-------------|--------------------|--------------------|-------------|
| 915.00 | Peak | 50.57 | 3.26 | 53.83 | 74.00 | -20.17 |
| 915.00 | Average | 36.43 | 3.26 | 39.69 | 54.00 | -14.31 |

Report No.: T210115W01-RP

| | | | |
|-----------|----------------------|---------------|------------------|
| Test Mode | High CH 924.5 MHz | Temp/Hum | 21.4(°C) / 60%RH |
| Test Item | Band Edge | Test Date | March 11, 2021 |
| Polarize | Vertical | Test Engineer | Ray Li |
| Detector | Peak / Average | | |

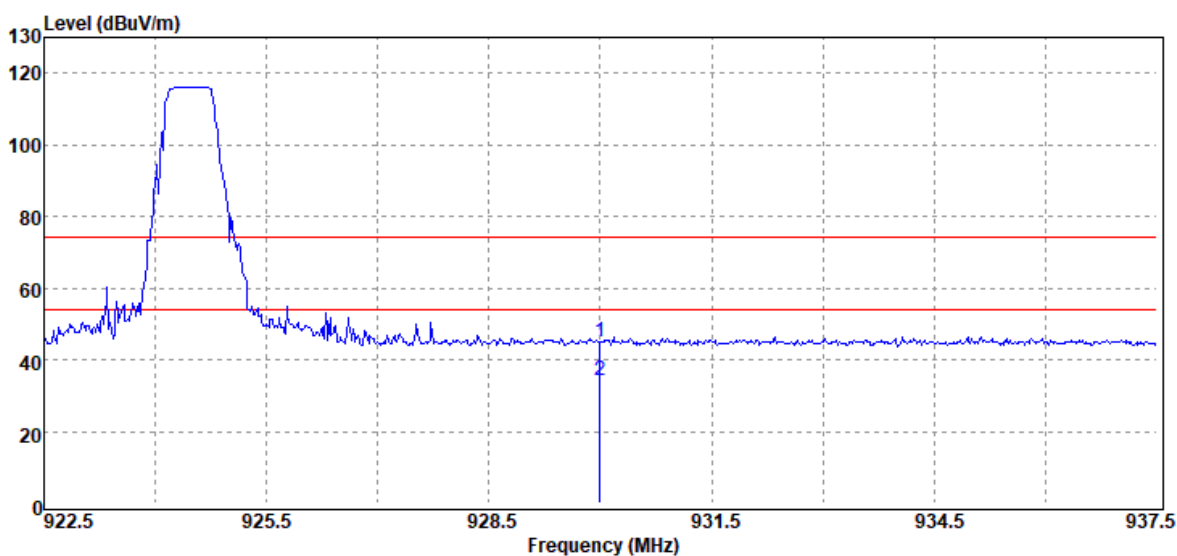

| Frequency (MHz) | Detector Mode (PK/QP/AV) | Spectrum Reading Level (dBμV) | Factor (dB) | Actual FS (dBμV/m) | Limit @3m (dBμV/m) | Margin (dB) |
|-----------------|--------------------------|-------------------------------|-------------|--------------------|--------------------|-------------|
| 930.00 | Peak | 41.25 | 3.56 | 44.81 | 74.00 | -29.19 |
| 930.00 | Average | 30.82 | 3.56 | 34.38 | 54.00 | -19.62 |

Report No.: T210115W01-RP

| | | | |
|-----------|----------------------|---------------|------------------|
| Test Mode | High CH 924.5 MHz | Temp/Hum | 21.4(°C) / 60%RH |
| Test Item | Band Edge | Test Date | March 11, 2021 |
| Polarize | Horizontal | Test Engineer | Ray Li |
| Detector | Peak / Average | | |

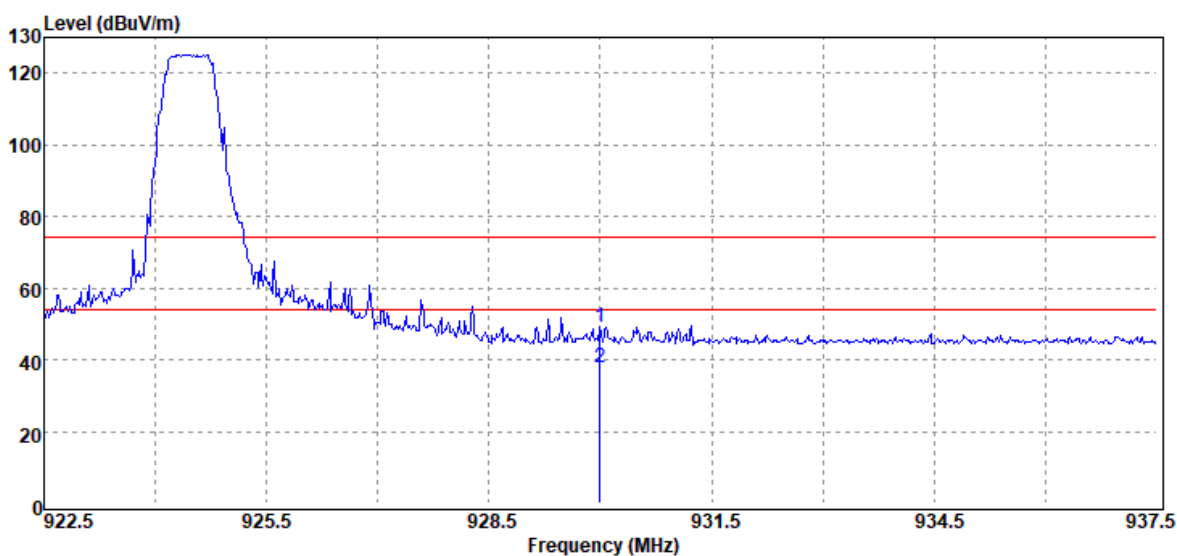

| Frequency (MHz) | Detector Mode (PK/QP/AV) | Spectrum Reading Level (dB μ V) | Factor (dB) | Actual FS (dB μ V/m) | Limit @3m (dB μ V/m) | Margin (dB) |
|-----------------|--------------------------|-------------------------------------|-------------|--------------------------|--------------------------|-------------|
| 930.00 | Peak | 45.36 | 3.56 | 48.92 | 74.00 | -25.08 |
| 930.00 | Average | 34.29 | 3.56 | 37.85 | 54.00 | -16.15 |

Noramal Link Test Data

| | | | |
|------------|--------------|---------------|------------------|
| Test Mode: | Noramal Link | Temp/Hum | 21.4(°C) / 60%RH |
| Test Item | 30MHz-1GHz | Test Date | March 11, 2021 |
| Polarize | Vertical | Test Engineer | Ray Li |
| Detector | Peak | | |

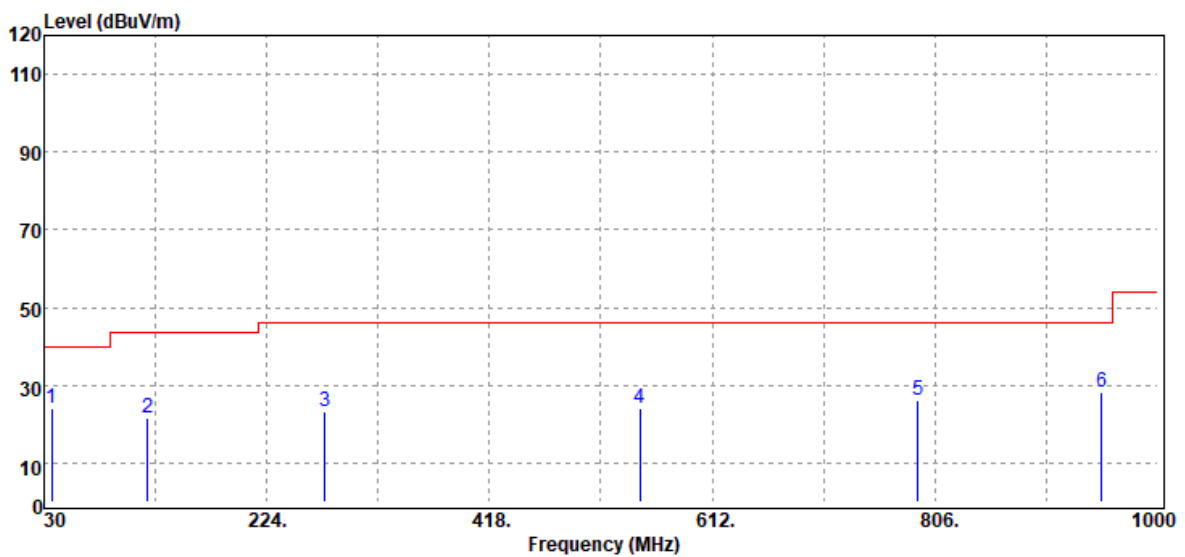

| Frequency (MHz) | Detector Mode (PK/QP/AV) | Spectrum Reading Level (dBμV) | Factor (dB) | Actual FS (dBμV/m) | Limit @3m (dBμV/m) | Margin (dB) |
|-----------------|--------------------------|-------------------------------|-------------|--------------------|--------------------|-------------|
| 36.79 | Peak | 31.54 | -7.36 | 24.18 | 40.00 | -15.82 |
| 120.21 | Peak | 30.56 | -9.11 | 21.45 | 43.50 | -22.05 |
| 274.44 | Peak | 31.96 | -8.80 | 23.16 | 46.00 | -22.84 |
| 548.95 | Peak | 26.42 | -2.44 | 23.98 | 46.00 | -22.02 |
| 791.45 | Peak | 24.92 | 1.39 | 26.31 | 46.00 | -19.69 |
| 951.50 | Peak | 24.03 | 4.30 | 28.33 | 46.00 | -17.67 |

Report No.: T210115W01-RP

| | | | |
|------------|--------------|---------------|------------------|
| Test Mode: | Noramal Link | Temp/Hum | 21.4(°C) / 60%RH |
| Test Item | 30MHz-1GHz | Test Date | March 11, 2021 |
| Polarize | Horizontal | Test Engineer | Ray Li |
| Detector | Peak | | |

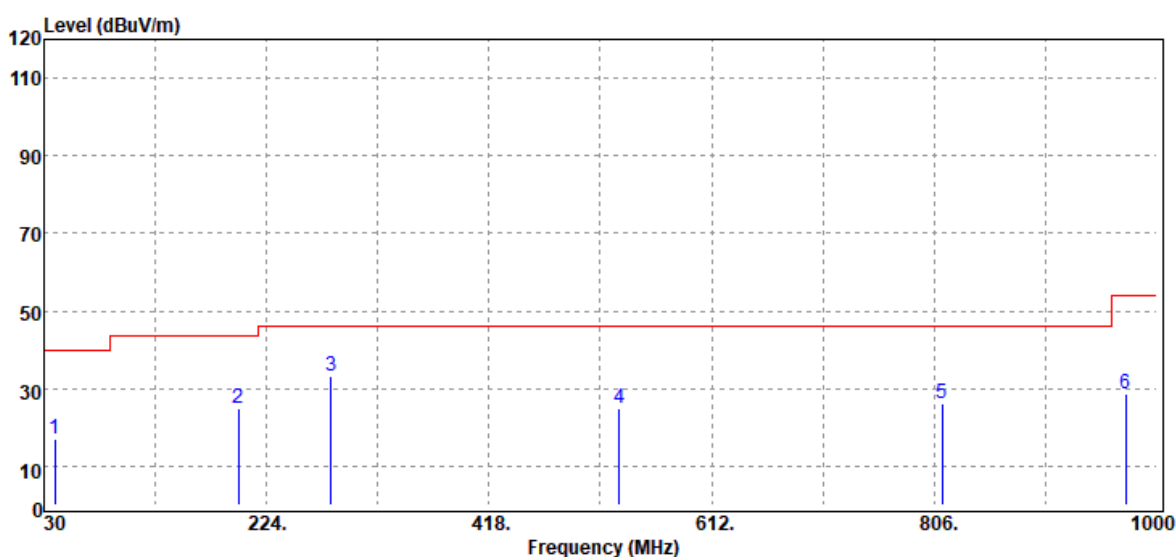

| Frequency (MHz) | Detector Mode (PK/QP/AV) | Spectrum Reading Level (dBμV) | Factor (dB) | Actual FS (dBμV/m) | Limit @3m (dBμV/m) | Margin (dB) |
|-----------------|--------------------------|-------------------------------|-------------|--------------------|--------------------|-------------|
| 39.70 | Peak | 26.80 | -9.65 | 17.15 | 40.00 | -22.85 |
| 199.75 | Peak | 34.19 | -9.48 | 24.71 | 43.50 | -18.79 |
| 280.26 | Peak | 42.02 | -8.67 | 33.35 | 46.00 | -12.65 |
| 531.49 | Peak | 27.56 | -2.70 | 24.86 | 46.00 | -21.14 |
| 812.79 | Peak | 24.34 | 1.91 | 26.25 | 46.00 | -19.75 |
| 972.84 | Peak | 24.61 | 3.99 | 28.60 | 54.00 | -25.40 |

Report No.: T210115W01-RP

Below 1G Test Data

| | | | |
|------------|------------|---------------|------------------|
| Test Mode: | Low CH | Temp/Hum | 21.4(°C) / 60%RH |
| Test Item | 30MHz-1GHz | Test Date | March 11, 2021 |
| Polarize | Vertical | Test Engineer | Ray Li |
| Detector | Peak | | |

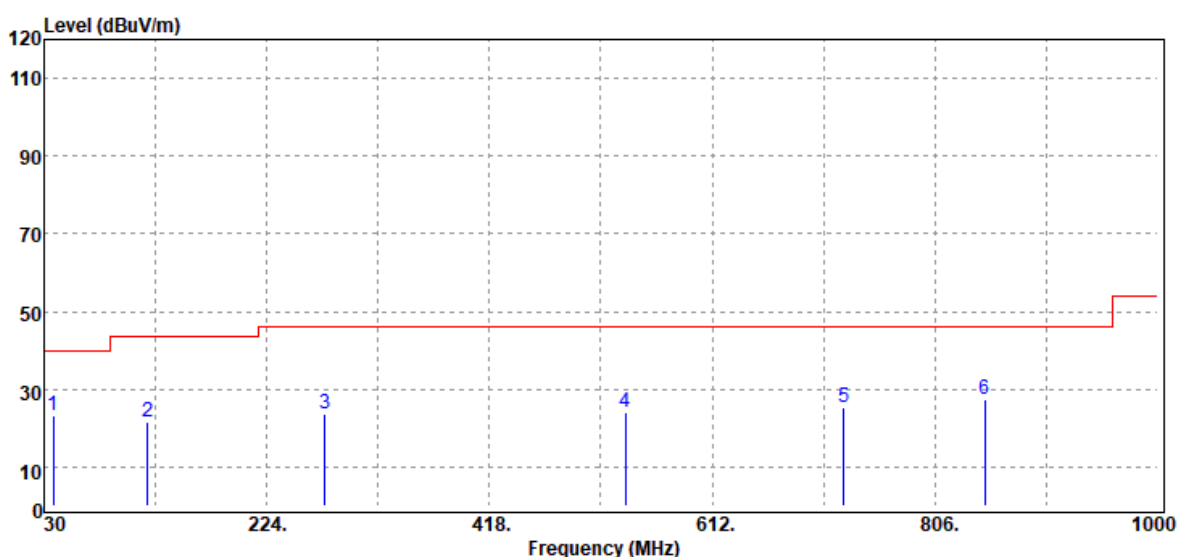

| Frequency (MHz) | Detector Mode (PK/QP/AV) | Spectrum Reading Level (dBμV) | Factor (dB) | Actual FS (dBμV/m) | Limit @3m (dBμV/m) | Margin (dB) |
|-----------------|--------------------------|-------------------------------|-------------|--------------------|--------------------|-------------|
| 37.76 | Peak | 31.22 | -8.16 | 23.06 | 40.00 | -16.94 |
| 120.21 | Peak | 30.51 | -9.11 | 21.40 | 43.50 | -22.10 |
| 274.44 | Peak | 32.49 | -8.80 | 23.69 | 46.00 | -22.31 |
| 536.34 | Peak | 26.40 | -2.51 | 23.89 | 46.00 | -22.11 |
| 726.46 | Peak | 25.06 | 0.42 | 25.48 | 46.00 | -20.52 |
| 849.65 | Peak | 24.87 | 2.52 | 27.39 | 46.00 | -18.61 |

Note: No emission found between lowest internal used/generated frequency to 30MHz (9kHz~30MHz).

Report No.: T210115W01-RP

| | | | |
|------------|------------|---------------|------------------|
| Test Mode: | Low CH | Temp/Hum | 21.4(°C) / 60%RH |
| Test Item | 30MHz-1GHz | Test Date | March 11, 2021 |
| Polarize | Horizontal | Test Engineer | Ray Li |
| Detector | Peak | | |

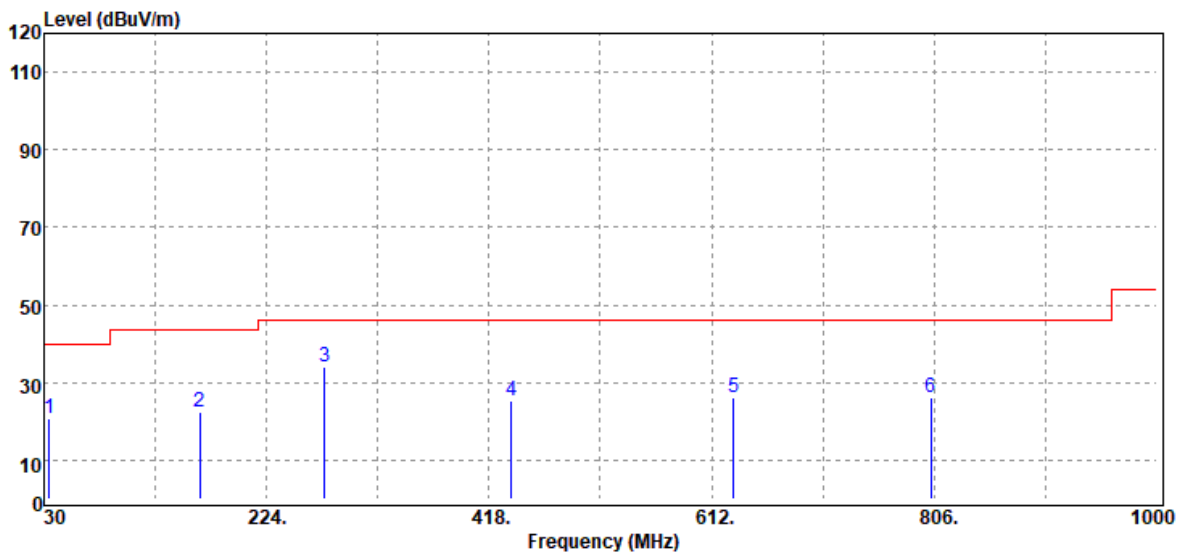

| Frequency (MHz) | Detector Mode (PK/QP/AV) | Spectrum Reading Level (dBμV) | Factor (dB) | Actual FS (dBμV/m) | Limit @3m (dBμV/m) | Margin (dB) |
|-----------------|--------------------------|-------------------------------|-------------|--------------------|--------------------|-------------|
| 34.85 | Peak | 26.74 | -6.07 | 20.67 | 40.00 | -19.33 |
| 165.80 | Peak | 33.15 | -10.71 | 22.44 | 43.50 | -21.06 |
| 274.44 | Peak | 42.66 | -8.80 | 33.86 | 46.00 | -12.14 |
| 437.40 | Peak | 30.10 | -4.57 | 25.53 | 46.00 | -20.47 |
| 631.40 | Peak | 26.78 | -0.68 | 26.10 | 46.00 | -19.90 |
| 803.09 | Peak | 24.40 | 1.69 | 26.09 | 46.00 | -19.91 |

Note: No emission found between lowest internal used/generated frequency to 30MHz (9kHz~30MHz).

Report No.: T210115W01-RP

| | | | |
|------------|------------|---------------|------------------|
| Test Mode: | High CH | Temp/Hum | 21.4(°C) / 60%RH |
| Test Item | 30MHz-1GHz | Test Date | March 11, 2021 |
| Polarize | Vertical | Test Engineer | Ray Li |
| Detector | Peak | | |

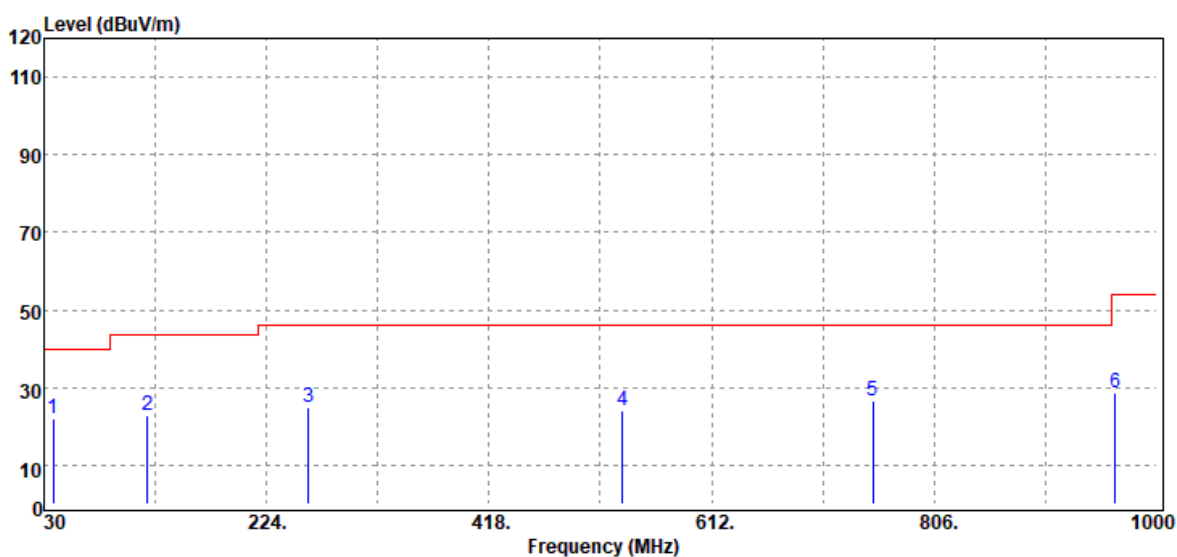

| Frequency (MHz) | Detector Mode (PK/QP/AV) | Spectrum Reading Level (dBμV) | Factor (dB) | Actual FS (dBμV/m) | Limit @3m (dBμV/m) | Margin (dB) |
|-----------------|--------------------------|-------------------------------|-------------|--------------------|--------------------|-------------|
| 37.76 | Peak | 30.16 | -8.16 | 22.00 | 40.00 | -18.00 |
| 120.21 | Peak | 31.96 | -9.11 | 22.85 | 43.50 | -20.65 |
| 260.86 | Peak | 34.94 | -9.99 | 24.95 | 46.00 | -21.05 |
| 534.40 | Peak | 26.67 | -2.57 | 24.10 | 46.00 | -21.90 |
| 752.65 | Peak | 25.68 | 0.83 | 26.51 | 46.00 | -19.49 |
| 964.11 | Peak | 24.98 | 3.65 | 28.63 | 54.00 | -25.37 |

Note: No emission found between lowest internal used/generated frequency to 30MHz (9kHz~30MHz).

Report No.: T210115W01-RP

| | | | |
|------------|------------|---------------|------------------|
| Test Mode: | High CH | Temp/Hum | 21.4(°C) / 60%RH |
| Test Item | 30MHz-1GHz | Test Date | March 11, 2021 |
| Polarize | Horizontal | Test Engineer | Ray Li |
| Detector | Peak | | |

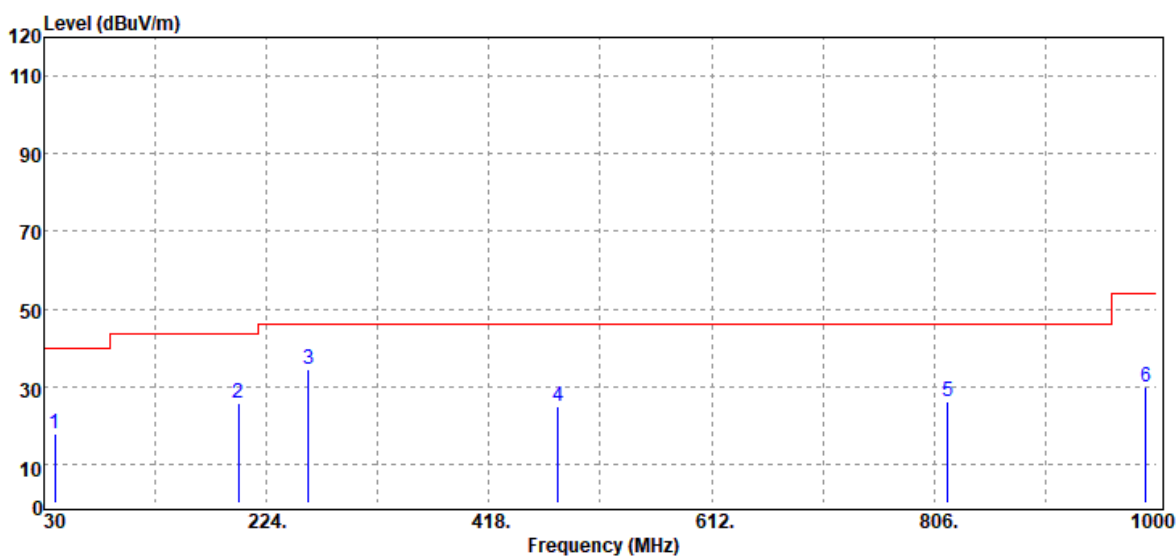

| Frequency (MHz) | Detector Mode (PK/QP/AV) | Spectrum Reading Level (dB μ V) | Factor (dB) | Actual FS (dB μ V/m) | Limit @3m (dB μ V/m) | Margin (dB) |
|-----------------|--------------------------|-------------------------------------|-------------|--------------------------|--------------------------|-------------|
| 39.70 | Peak | 27.70 | -9.65 | 18.05 | 40.00 | -21.95 |
| 199.75 | Peak | 35.38 | -9.48 | 25.90 | 43.50 | -17.60 |
| 260.86 | Peak | 44.66 | -9.99 | 34.67 | 46.00 | -11.33 |
| 478.14 | Peak | 28.43 | -3.40 | 25.03 | 46.00 | -20.97 |
| 817.64 | Peak | 24.23 | 1.98 | 26.21 | 46.00 | -19.79 |
| 990.30 | Peak | 25.43 | 4.29 | 29.72 | 54.00 | -24.28 |

Note: No emission found between lowest internal used/generated frequency to 30MHz (9kHz~30MHz).

Report No.: T210115W01-RP

Above 1G Test Data

| | | | |
|------------|----------|---------------|------------------|
| Test Mode: | Low CH | Temp/Hum | 21.4(°C) / 60%RH |
| Test Item | Harmonic | Test Date | March 11, 2021 |
| Polarize | Vertical | Test Engineer | Ray Li |
| Detector | Peak | | |

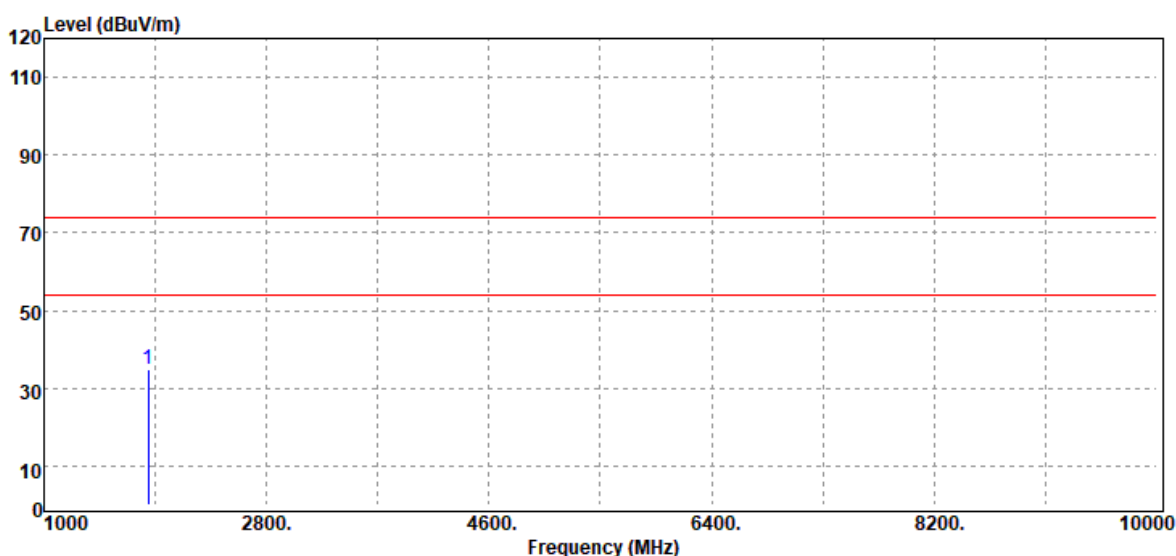

| Frequency (MHz) | Detector Mode (PK/QP/AV) | Spectrum Reading Level (dBµV) | Factor (dB) | Actual FS (dBµV/m) | Limit @3m (dBµV/m) | Margin (dB) |
|-----------------|--------------------------|-------------------------------|-------------|--------------------|--------------------|-------------|
| 1841.00 | Peak | 38.64 | -3.70 | 34.94 | 74.00 | -39.06 |
| N/A | | | | | | |
| | | | | | | |

Remark:

1. Measuring frequencies from 1 GHz to the 10th harmonic of highest fundamental frequency.
2. For above 1GHz, the EUT peak value was under average limit, therefore the Average value compliance with the average limit.

Report No.: T210115W01-RP

| | | | |
|------------|------------|---------------|------------------|
| Test Mode: | Low CH | Temp/Hum | 21.4(°C) / 60%RH |
| Test Item | Harmonic | Test Date | March 11, 2021 |
| Polarize | Horizontal | Test Engineer | Ray Li |
| Detector | Peak | | |

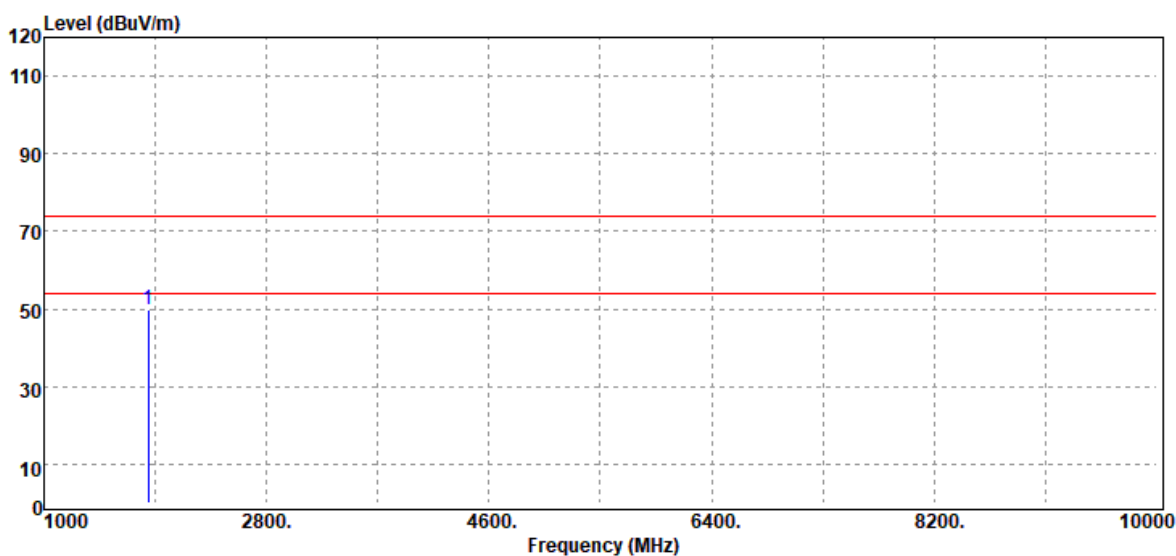

| Frequency (MHz) | Detector Mode (PK/QP/AV) | Spectrum Reading Level (dB μ V) | Factor (dB) | Actual FS (dB μ V/m) | Limit @3m (dB μ V/m) | Margin (dB) |
|-----------------|--------------------------|-------------------------------------|-------------|--------------------------|--------------------------|-------------|
| 1841.00 | Peak | 53.51 | -3.70 | 49.81 | 74.00 | -24.19 |
| N/A | | | | | | |
| | | | | | | |

Remark:

1. Measuring frequencies from 1 GHz to the 10th harmonic of highest fundamental frequency.

Report No.: T210115W01-RP

| | | | |
|------------|----------|---------------|------------------|
| Test Mode: | High CH | Temp/Hum | 21.4(°C) / 60%RH |
| Test Item | Harmonic | Test Date | March 11, 2021 |
| Polarize | Vertical | Test Engineer | Ray Li |
| Detector | Peak | | |

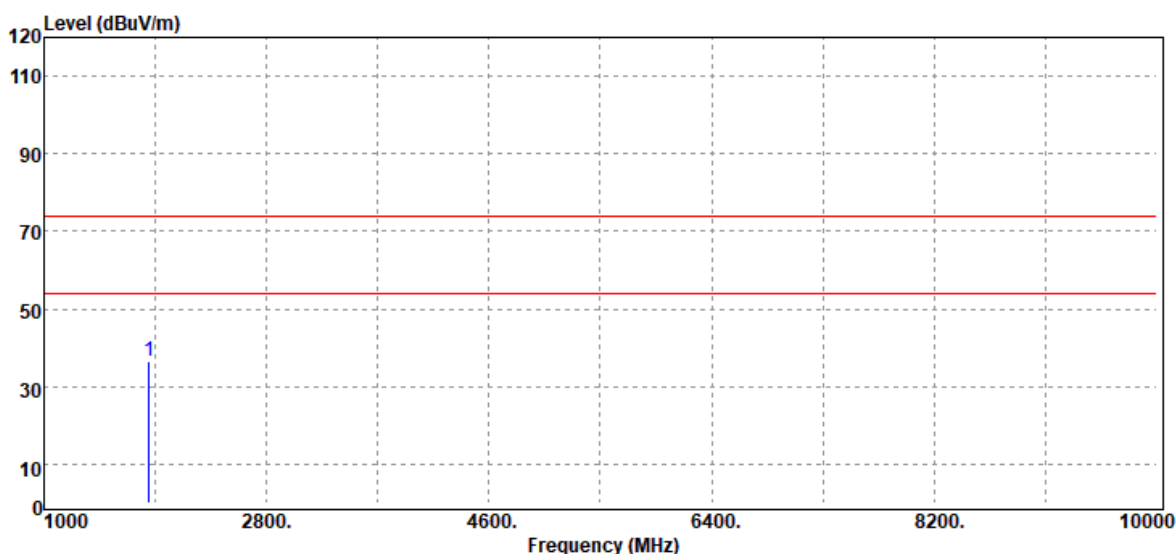

| Frequency (MHz) | Detector Mode (PK/QP/AV) | Spectrum Reading Level (dB μ V) | Factor (dB) | Actual FS (dB μ V/m) | Limit @3m (dB μ V/m) | Margin (dB) |
|-----------------|--------------------------|-------------------------------------|-------------|--------------------------|--------------------------|-------------|
| 1849.00 | Peak | 40.13 | -3.63 | 36.50 | 74.00 | -37.50 |
| N/A | | | | | | |
| | | | | | | |

Remark:

1. Measuring frequencies from 1 GHz to the 10th harmonic of highest fundamental frequency.
2. For above 1GHz, the EUT peak value was under average limit, therefore the Average value compliance with the average limit.

Report No.: T210115W01-RP

| | | | |
|------------|------------|---------------|------------------|
| Test Mode: | High CH | Temp/Hum | 21.4(°C) / 60%RH |
| Test Item | Harmonic | Test Date | March 11, 2021 |
| Polarize | Horizontal | Test Engineer | Ray Li |
| Detector | Peak | | |

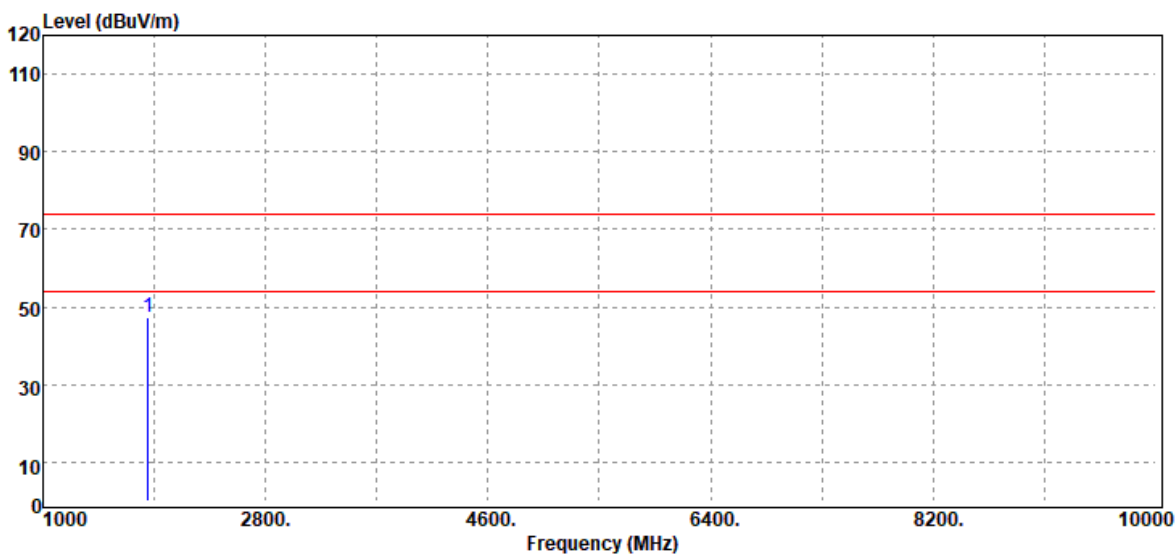

| Frequency (MHz) | Detector Mode (PK/QP/AV) | Spectrum Reading Level (dB μ V) | Factor (dB) | Actual FS (dB μ V/m) | Limit @3m (dB μ V/m) | Margin (dB) |
|-----------------|--------------------------|-------------------------------------|-------------|--------------------------|--------------------------|-------------|
| 1849.00 | Peak | 50.78 | -3.63 | 47.15 | 74.00 | -26.85 |
| N/A | | | | | | |
| | | | | | | |

Remark:

1. Measuring frequencies from 1 GHz to the 10th harmonic of highest fundamental frequency.

--End of Test Report--