



# Shenzhen HTT Technology Co., Ltd.

## FCC PART 15 SUBPART C TEST REPORT

### FCC PART 15.231

Report Reference No.....: HTT202305351F01

FCC ID.....: 2AR95-WF001

Compiled by  
( position+printed name+signature)...: File administrators

*Heber He*

Supervised by  
( position+printed name+signature)...: Project Engineer

*Bruce Zhu*

Approved by  
( position+printed name+signature)...: RF Manager

*Kevin Yang*

Date of issue.....: May.26,2023

**Testing Laboratory Name .....: Shenzhen HTT Technology Co.,Ltd.**

Address.....: 1F, Building B, Huafeng International Robotics Industrial Park,  
Hangcheng Road,Nanchang Community, Xixiang Street, Bao'an  
District, Shenzhen, Guangdong, China

**Applicant's name.....: Shenzhen Wenhui Technology Development Co., Ltd.**

Address .....: 401, No.7, Xingye 3rd Road, Fenghuang Community, Fuyong  
Street, Bao'an District, Shenzhen

**Test specification .....**

Standard.....: **FCC Part 15.231**

**Shenzhen HTT Technology Co.,Ltd. All rights reserved.**

This publication may be reproduced in whole or in part for non-commercial purposes as long as the Shenzhen HTT Technology Co.,Ltd. is acknowledged as copyright owner and source of the material. Shenzhen HTT Technology Co.,Ltd. takes no responsibility for and will not assume liability for damages resulting from the reader's interpretation of the reproduced material due to its placement and context.

**Test item description .....** Video doorbell

Trade Mark .....

Manufacturer .....

Model/Type reference.....

Listed Models .....

Ratings .....

Modulation .....

Frequency.....

Result.....: **PASS**

# TEST REPORT

Equipment under Test : Video doorbell

Model /Type : WF001

Listed Models : WF002, WF003, WF004, WF005,  
WF006, WF007, WF008, WF009, WF010

Model Declaration : PCB board, structure and internal of these model(s) are the same,  
So no additional models were tested.

**Applicant** : **Shenzhen Wenhui Technology Development Co., Ltd.**

Address : 401, No.7, Xingye 3rd Road, Fenghuang Community, Fuyong Street, Bao'an District, Shenzhen

**Manufacturer** : **Shenzhen Wenhui Technology Development Co., Ltd.**

Address : 401, No.7, Xingye 3rd Road, Fenghuang Community, Fuyong Street, Bao'an District, Shenzhen

<b>Test Result:</b>	<b>PASS</b>
---------------------	-------------

The test report merely corresponds to the test sample.  
It is not permitted to copy extracts of these test result without the written permission of the test laboratory.

# Contents

<b><u>1</u></b>	<b><u>TEST STANDARDS .....</u></b>	<b><u>4</u></b>
<b><u>2</u></b>	<b><u>SUMMARY .....</u></b>	<b><u>5</u></b>
2.1	General Remarks	5
2.2	Product Description	5
2.3	Equipment Under Test	5
2.4	Short description of the Equipment under Test (EUT)	5
2.5	Block Diagram of Test Setup	5
2.6	Special Accessories	5
2.7	Related Submittal(s) / Grant (s)	6
2.8	Modifications	6
<b><u>3</u></b>	<b><u>TEST ENVIRONMENT .....</u></b>	<b><u>7</u></b>
3.1	Address of the test laboratory	7
3.2	Test Facility	7
3.3	Environmental conditions	7
3.4	Summary of measurement results	8
3.5	Statement of the measurement uncertainty	8
3.6	Equipments Used during the Test	9
<b><u>4</u></b>	<b><u>TEST CONDITIONS AND RESULTS.....</u></b>	<b><u>10</u></b>
4.1	AC Power Conducted Emission	10
4.2	Radiated Emission	13
4.3	20dB Bandwidth	17
4.4	Deactivation Time	18
4.5	Antenna Requirement	19
<b><u>5</u></b>	<b><u>TEST SETUP PHOTOS OF THE EUT .....</u></b>	<b><u>20</u></b>
<b><u>6</u></b>	<b><u>PHOTOS OF THE EUT .....</u></b>	<b><u>20</u></b>

## 1 TEST STANDARDS

The tests were performed according to following standards:

[FCC Rules Part 15.231](#): Periodic operation in the band 40.66-40.70 MHz and above 70 MHz.  
[ANSI C63.10:2013](#) : American National Standard for Testing Unlicensed Wireless Devices

## 2 SUMMARY

### 2.1 General Remarks

Date of receipt of test sample	:	May.22,2023
Testing commenced on	:	May.22,2023
Testing concluded on	:	May.26,2023

### 2.2 Product Description

Product Name:	Video doorbell
Model/Type reference:	WF001
Testing sample ID:	HTT202305351-1# (Engineer sample), HTT202305351-2#(Normal sample)
Power supply:	DC 3.7V From Battery and DC 5V From External Circuit
Modulation:	ASK
Operation frequency:	433.9200MHz
Channel number:	1
Antenna type:	Internal antenna
Antenna gain:	1.0dBi

### 2.3 Equipment Under Test

#### Power supply system utilised

Power supply voltage	:	<input type="radio"/> 230V / 50 Hz	<input type="radio"/> 120V / 60Hz
		<input type="radio"/> 12 V DC	<input type="radio"/> 24 V DC
		<input checked="" type="radio"/> Other (specified in blank below)	

DC 3.7V From Battery

### 2.4 Short description of the Equipment under Test (EUT)

This is a Video doorbell.

For more details, refer to the user's manual of the EUT.

### 2.5 Block Diagram of Test Setup

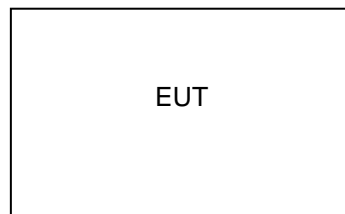

### 2.6 Special Accessories

Follow auxiliary equipment(s) test with EUT that provided by the manufacturer or laboratory is listed as follow:

Description	Manufacturer	Model	Technical Parameters	Certificate	Provided by
/	/	/	/	/	/
/	/	/	/	/	/

## **2.7 Related Submittal(s) / Grant (s)**

This submittal(s) (test report) is intended for the device filing to comply with Section 15.231 of the FCC Part 15, Subpart C Rules.

## **2.8 Modifications**

No modifications were implemented to meet testing criteria.

### 3 TEST ENVIRONMENT

#### 3.1 Address of the test laboratory

**Shenzhen HTT Technology Co.,Ltd.**

1F, Building B, Huafeng International Robotics Industrial Park, Hangcheng Road, Nanchang Community, Xixiang Street, Bao'an District, Shenzhen, Guangdong, China

#### 3.2 Test Facility

The test facility is recognized, certified, or accredited by the following organizations:

**FCC-Registration No.: 779513 Designation Number: CN1319**

Shenzhen HTT Technology Co.,Ltd. has been listed on the US Federal Communications Commission list of test facilities recognized to perform electromagnetic emissions measurements.

**A2LA-Lab Cert. No.: 6435.01**

Shenzhen HTT Technology Co.,Ltd. has been listed by American Association for Laboratory Accreditation to perform electromagnetic emission measurement.

The 3m-Semi anechoic test site fulfils CISPR 16-1-4 according to ANSI C63.10 and CISPR 16-1-4:2010.

#### 3.3 Environmental conditions

During the measurement the environmental conditions were within the listed ranges:

Radiated Emission:

Temperature:	25 ° C
Humidity:	45 %
Atmospheric pressure:	950-1050mbar

Conducted testing:

Temperature:	25 ° C
Humidity:	44 %
Atmospheric pressure:	950-1050mbar

### 3.4 Summary of measurement results

FCC and IC Requirements		
FCC Part 15.207	Conducted Emission	PASS
FCC Part 15.231(a)(2)	Automatically Deactivate	PASS
FCC Part 15.231(b)	Electric Field Strength of Fundamental Emission	PASS
FCC Part 15.205 & 15.209 & 15.231(b)	Electric Field Strength of Spurious Emission	PASS
FCC Part 15.231(c)	-20dB bandwidth	PASS

Remark: The measurement uncertainty is not included in the test result.

### 3.5 Statement of the measurement uncertainty

The data and results referenced in this document are true and accurate. The reader is cautioned that there may be errors within the calibration limits of the equipment and facilities. The measurement uncertainty was calculated for all measurements listed in this test report acc. to TR-100028-01 "Electromagnetic compatibility and Radio spectrum Matters (ERM); Uncertainties in the measurement of mobile radio equipment characteristics; Part 1" and TR-100028-02 "Electromagnetic compatibility and Radio spectrum Matters (ERM); Uncertainties in the measurement of mobile radio equipment characteristics; Part 2" and is documented in the Shenzhen HTT Technology Co., Ltd. quality system acc. to DIN EN ISO/IEC 17025. Furthermore, component and process variability of devices similar to that tested may result in additional deviation. The manufacturer has the sole responsibility of continued compliance of the device. Hereafter the best measurement capability for Shenzhen HTT Technology Co., Ltd. :

Test	Range	Measurement Uncertainty	Notes
Radiated Emission	30~1000MHz	4.10 dB	(1)
Radiated Emission	1~18GHz	4.32 dB	(1)
Radiated Emission	18-40GHz	5.54 dB	(1)
Conducted Disturbance	0.15~30MHz	3.12 dB	(1)

- (1) This uncertainty represents an expanded uncertainty expressed at approximately the 95% confidence level using a coverage factor of  $k=2$ .



### 3.6 Equipments Used during the Test

Item	Test Equipment	Manufacturer	Model No.	Inventory No.	Cal.Date (mm-dd-yy)	Cal.Due date (mm-dd-yy)
1	3m Semi- Anechoic Chamber	Shenzhen C.R.T technology co., LTD	9*6*6	HTT-E028	Aug. 10 2021	Aug. 09 2024
2	Control Room	Shenzhen C.R.T technology co., LTD	4.8*3.5*3.0	HTT-E030	Aug. 10 2021	Aug. 09 2024
3	EMI Test Receiver	Rohde&Schwar	ESCI7	HTT-E022	Apr. 26 2023	Apr. 25 2024
4	Spectrum Analyzer	Rohde&Schwar	FSP	HTT-E037	Apr. 26 2023	Apr. 25 2024
5	Coaxial Cable	ZDecl	ZT26-NJ-NJ-0.6M	HTT-E018	Apr. 26 2023	Apr. 25 2024
6	Coaxial Cable	ZDecl	ZT26-NJ-SMAJ-2M	HTT-E019	Apr. 26 2023	Apr. 25 2024
7	Coaxial Cable	ZDecl	ZT26-NJ-SMAJ-0.6M	HTT-E020	Apr. 26 2023	Apr. 25 2024
8	Coaxial Cable	ZDecl	ZT26-NJ-SMAJ-8.5M	HTT-E021	Apr. 26 2023	Apr. 25 2024
9	Composite logarithmic antenna	Schwarzbeck	VULB 9168	HTT-E017	May. 21 2023	May. 20 2024
10	Horn Antenna	Schwarzbeck	BBHA9120D	HTT-E016	May. 20 2023	May. 19 2024
11	Loop Antenna	Zhinan	ZN30900C	HTT-E039	Apr. 26 2023	Apr. 25 2024
12	Horn Antenna	Beijing Hangwei Dayang	OBH100400	HTT-E040	Apr. 26 2023	Apr. 25 2024
13	low frequency Amplifier	Sonoma Instrument	310	HTT-E015	Apr. 26 2023	Apr. 25 2024
14	high-frequency Amplifier	HP	8449B	HTT-E014	Apr. 26 2023	Apr. 25 2024
15	Variable frequency power supply	Shenzhen Anbiao Instrument Co., Ltd	ANB-10VA	HTT-082	Apr. 26 2023	Apr. 25 2024
16	EMI Test Receiver	Rohde & Schwarz	ESCS30	HTT-E004	Apr. 26 2023	Apr. 25 2024
17	Artificial Mains	Rohde & Schwarz	ESH3-Z5	HTT-E006	May. 23 2023	May. 22 2024
18	Artificial Mains	Rohde & Schwarz	ENV-216	HTT-E038	May. 23 2023	May. 22 2024
19	Cable Line	Robinson	Z302S-NJ-BNCJ-1.5M	HTT-E001	Apr. 26 2023	Apr. 25 2024
20	Attenuator	Robinson	6810.17A	HTT-E007	Apr. 26 2023	Apr. 25 2024
21	Variable frequency power supply	Shenzhen Yanghong Electric Co., Ltd	YF-650 (5KVA)	HTT-E032	Apr. 26 2023	Apr. 25 2024
22	Control Room	Shenzhen C.R.T technology co., LTD	8*4*3.5	HTT-E029	Aug. 10 2021	Aug. 09 2024
23	DC power supply	Agilent	E3632A	HTT-E023	Apr. 26 2023	Apr. 25 2024
24	EMI Test Receiver	Agilent	N9020A	HTT-E024	Apr. 26 2023	Apr. 25 2024
25	Analog signal generator	Agilent	N5181A	HTT-E025	Apr. 26 2023	Apr. 25 2024
26	Vector signal generator	Agilent	N5182A	HTT-E026	Apr. 26 2023	Apr. 25 2024
27	Power sensor	Keysight	U2021XA	HTT-E027	Apr. 26 2023	Apr. 25 2024
28	Temperature and humidity meter	Shenzhen Anbiao Instrument Co., Ltd	TH10R	HTT-074	Apr. 28 2023	Apr. 27 2024
29	Radiated Emission Test Software	Farad	EZ-EMC	N/A	N/A	N/A
30	Conducted Emission Test Software	Farad	EZ-EMC	N/A	N/A	N/A
31	RF Test Software	panshanrf	TST	N/A	N/A	N/A

Note: The Cal.Interval was one year.

## 4 TEST CONDITIONS AND RESULTS

### 4.1 AC Power Conducted Emission

#### TEST CONFIGURATION

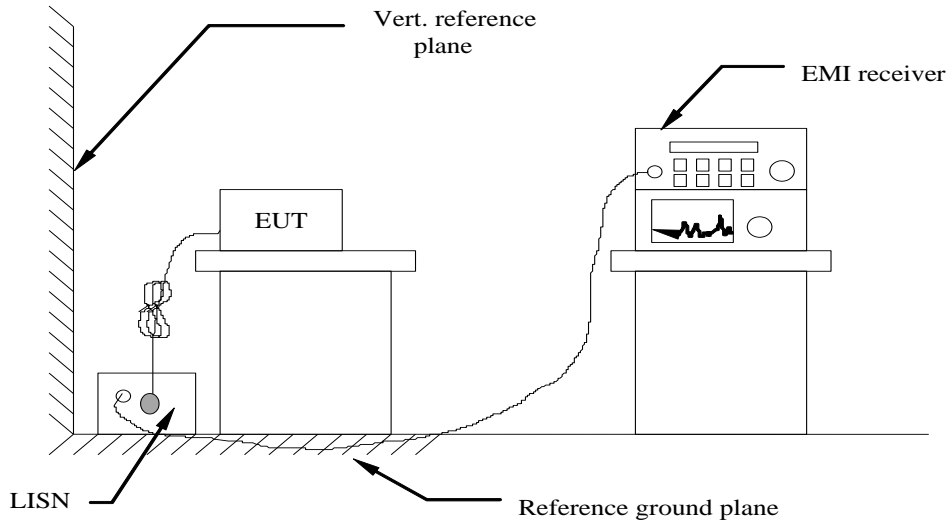

#### TEST PROCEDURE

- 1 The equipment was set up as per the test configuration to simulate typical actual usage per the user's manual. The EUT is a tabletop system, a wooden table with a height of 0.8 meters is used and is placed on the ground plane as per ANSI C63.10-2013.
- 2 Support equipment, if needed, was placed as per ANSI C63.10-2013
- 3 All I/O cables were positioned to simulate typical actual usage as per ANSI C63.10-2013
- 4 The EUT received DC 12V power from adapter, the adapter received AC120V/60Hz and AC 240V/60Hz power through a Line Impedance Stabilization Network (LISN) which supplied power source and was grounded to the ground plane.
- 5 All support equipments received AC power from a second LISN, if any.
- 6 The EUT test program was started. Emissions were measured on each current carrying line of the EUT using a spectrum Analyzer / Receiver connected to the LISN powering the EUT. The LISN has two monitoring points: Line 1 (Hot Side) and Line 2 (Neutral Side). Two scans were taken: one with Line 1 connected to Analyzer / Receiver and Line 2 connected to a 50 ohm load; the second scan had Line 1 connected to a 50 ohm load and Line 2 connected to the Analyzer / Receiver.
- 7 Analyzer / Receiver scanned from 150 KHz to 30MHz for emissions in each of the test modes.
- 8 During the above scans, the emissions were maximized by cable manipulation.

#### AC Power Conducted Emission Limit

For intentional device, according to § 15.207(a) AC Power Conducted Emission Limits is as following :

Frequency range (MHz)	Limit (dBuV)	
	Quasi-peak	Average
0.15-0.5	66 to 56*	56 to 46*
0.5-5	56	46
5-30	60	50

\* Decreases with the logarithm of the frequency.

#### TEST RESULTS

Remark: Both high and low voltages have been tested to show only the worst low voltage test data.

Measurement data:

Line:

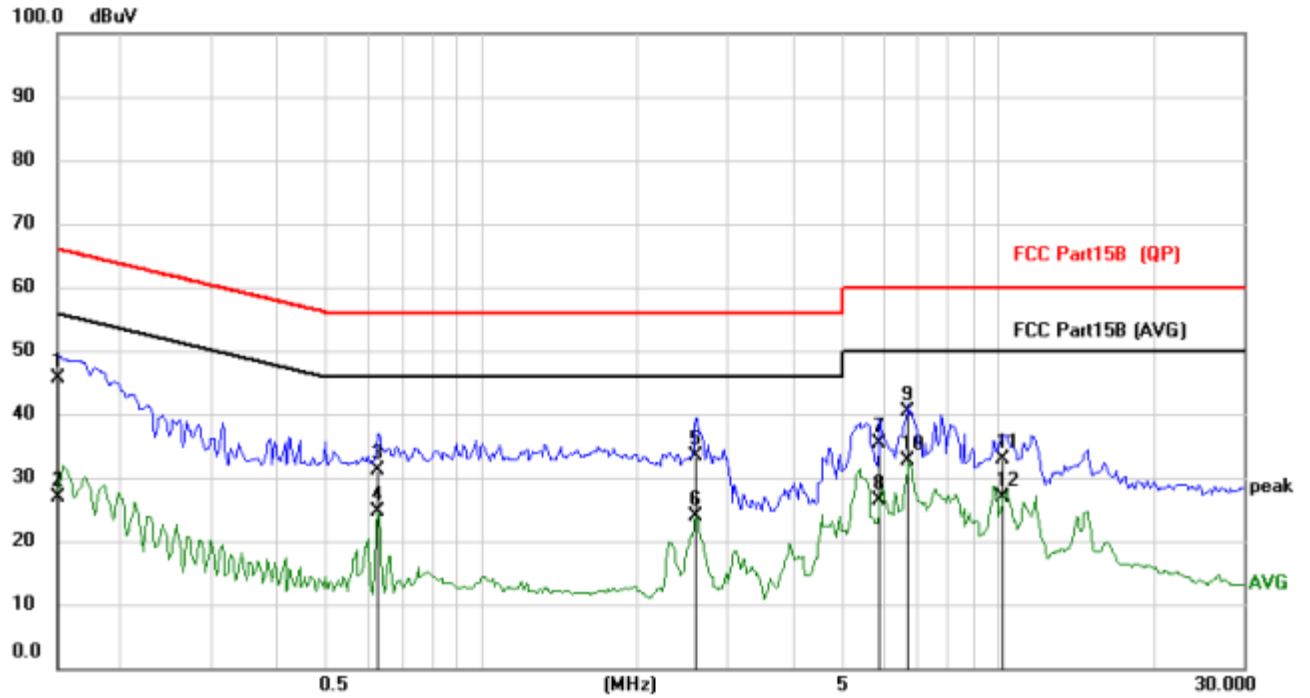

No.	Mk.	Freq. MHz	Reading Level dBuV	Correct Factor dB	Measure- ment dBuV	Limit dBuV	Over dB	Detector
1		0.1500	35.15	10.37	45.52	66.00	-20.48	QP
2		0.1500	16.63	10.37	27.00	56.00	-29.00	AVG
3		0.6297	20.58	10.64	31.22	56.00	-24.78	QP
4		0.6297	14.08	10.64	24.72	46.00	-21.28	AVG
5		2.6070	22.54	10.84	33.38	56.00	-22.62	QP
6		2.6070	13.07	10.84	23.91	46.00	-22.09	AVG
7		5.9055	24.12	11.23	35.35	60.00	-24.65	QP
8		5.9055	15.12	11.23	26.35	50.00	-23.65	AVG
9		6.7050	28.95	11.38	40.33	60.00	-19.67	QP
10	*	6.7050	21.32	11.38	32.70	50.00	-17.30	AVG
11		10.2852	21.39	11.53	32.92	60.00	-27.08	QP
12		10.2852	15.25	11.53	26.78	50.00	-23.22	AVG

Neutral:

100.0 dBuV

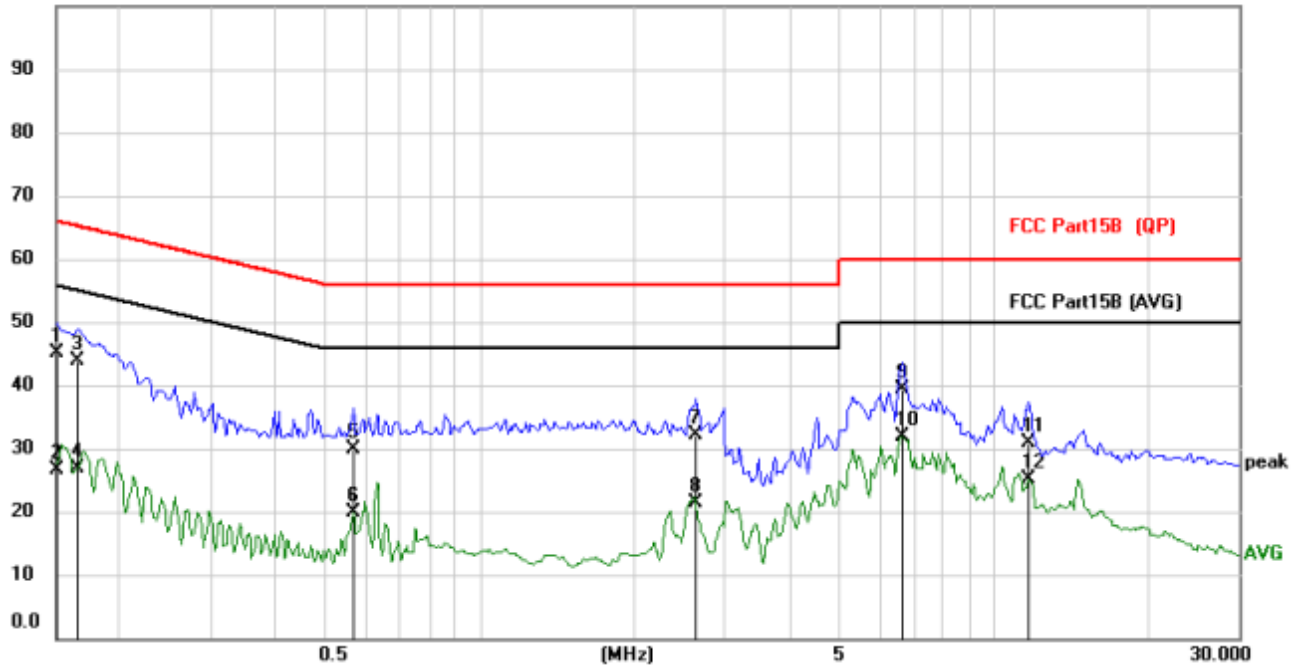

No.	Mk.	Freq.	Reading Level	Correct Factor	Measurement	Limit	Over	Detector
		MHz	dBuV	dB	dBuV	dBuV	dB	
1		0.1500	34.91	10.27	45.18	66.00	-20.82	QP
2		0.1500	16.46	10.27	26.73	56.00	-29.27	AVG
3		0.1655	33.71	10.25	43.96	65.18	-21.22	QP
4		0.1655	16.71	10.25	26.96	55.18	-28.22	AVG
5		0.5673	19.45	10.45	29.90	56.00	-26.10	QP
6		0.5673	9.54	10.45	19.99	46.00	-26.01	AVG
7		2.6460	21.32	10.84	32.16	56.00	-23.84	QP
8		2.6460	10.45	10.84	21.29	46.00	-24.71	AVG
9		6.6387	28.45	10.93	39.38	60.00	-20.62	QP
10	*	6.6387	20.90	10.93	31.83	50.00	-18.17	AVG
11		11.7165	19.24	11.74	30.98	60.00	-29.02	QP
12		11.7165	13.27	11.74	25.01	50.00	-24.99	AVG

Notes:

1. An initial pre-scan was performed on the line and neutral lines with peak detector.
2. Quasi-Peak and Average measurement were performed at the frequencies with maximized peak emission.
3. Final Level =Receiver Read level + LISN Factor + Cable Los

### 4.2 Radiated Emission

#### Limit

For intentional device, according to 15.209(a) the general requirement of field strength of radiated emission from intentional radiators at a distance of 3 meters shall not exceed the following table.

Frequency (MHz)	Distance (Meters)	Radiated (dBµV/m)	Radiated (µV/m)
0.009-0.49	3	$20\log(2400/F(\text{KHz}))+40\log(300/3)$	$2400/F(\text{KHz})$
0.49-1.705	3	$20\log(24000/F(\text{KHz}))+ 40\log(30/3)$	$24000/F(\text{KHz})$
1.705-30	3	$20\log(30)+ 40\log(30/3)$	30
30-88	3	40.0	100
88-216	3	43.5	150
216-960	3	46.0	200
Above 960	3	54.0	500

In addition to the provisions of 15.231(b), the field strength of emissions from intentional radiators operated under this section shall not exceed the following:

Funda-mental fre- quency (MHz)	Field strength of funda- mental (microvolts/ meter)	Field strength of spurious emissions (microvolts/meter)
40.66– 40.70.	2,250 .....	225
70–130 .....	1,250 .....	125
130–174 ....	<sup>1</sup> 1,250 to 3,750 .....	<sup>1</sup> 125 to 375
174–260 ....	3,750 .....	375
260–470 ....	<sup>1</sup> 3,750 to 12,500 .....	<sup>1</sup> 375 to 1,250
Above 470	12,500 .....	1,250

<sup>1</sup> Linear interpolations.

[Where F is the frequency in MHz, the formulas for calculating the maximum permitted fundamental field strengths are as follows: for the band 260-470 MHz,  $20*\log(41.6667*433.890-7083.3333)=80.82\text{dBuV/m}$  The maximum permitted unwanted emission level is 20 dB below the maximum permitted fundamental level.]

#### TEST CONFIGURATION

(A) Radiated Emission Test Set-Up, Frequency Below 30MHz

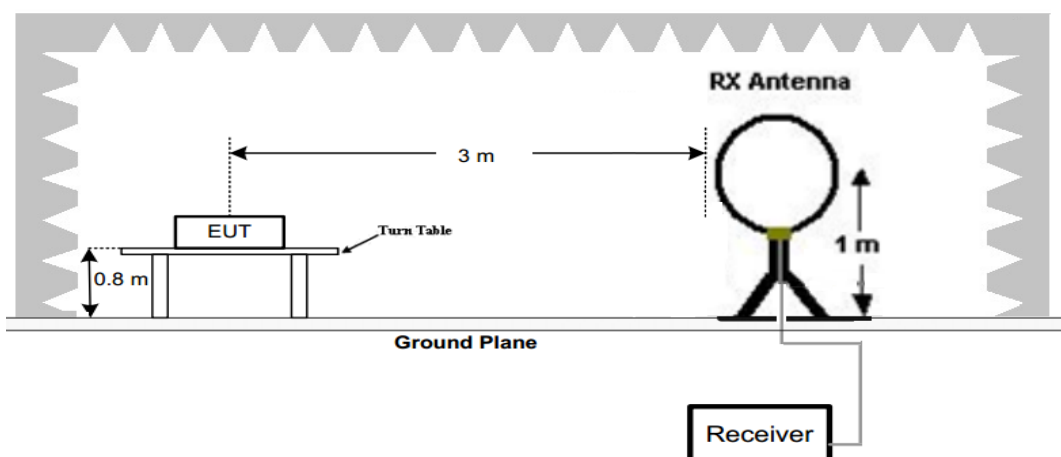

(B) Radiated Emission Test Set-Up, Frequency below 1000MHz

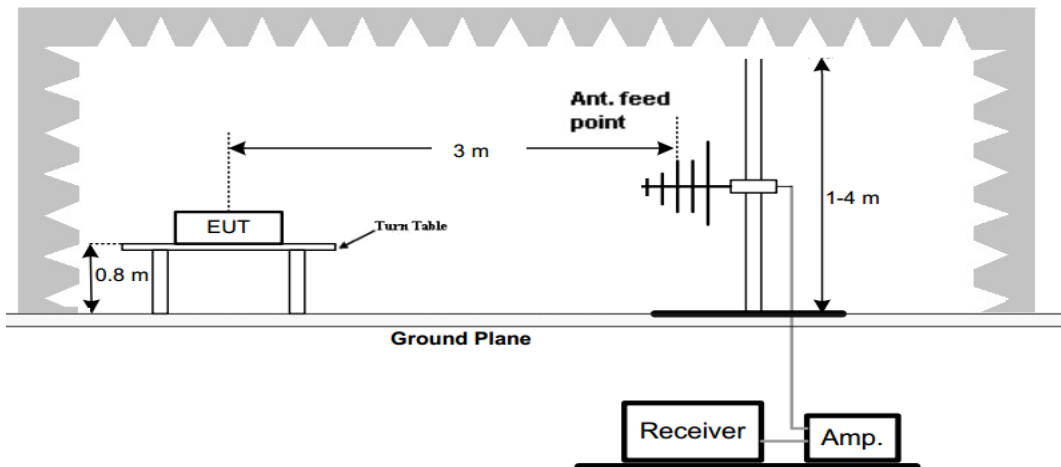

(C) Radiated Emission Test Set-Up, Frequency above 1000MHz

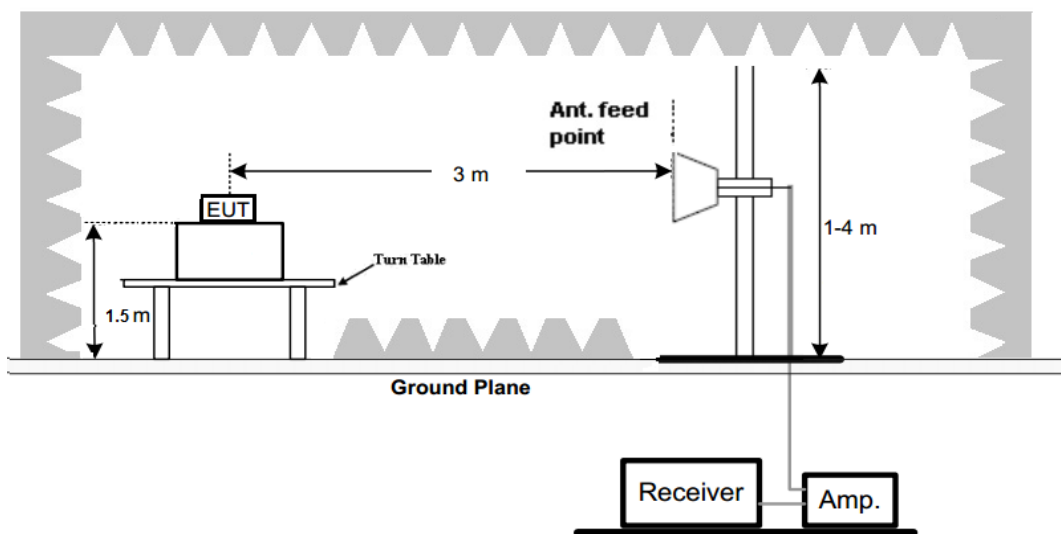

### Test Procedure

1. Below 1GHz measurement the EUT is placed on a turntable which is 0.8m above ground plane, and above 1GHz measurement EUT was placed on a low permittivity and low loss tangent turn table which is 1.5m above ground plane.
2. Maximum procedure was performed by raising the receiving antenna from 1m to 4m and rotating the turn table from 0°C to 360°C to acquire the highest emissions from EUT
3. And also, each emission was to be maximized by changing the polarization of receiving antenna both horizontal and vertical.
4. Repeat above procedures until all frequency measurements have been completed.

### TEST RESULTS

The emissions from 30MHz to 5GHz are measured peak and average level, below 1 GHz measured QP level, detailed test data please see below. Besides, we tested 3 directions and recorded the worst data.

Emission Styles	Frequency (MHz)	Reading (dBuV)	Factor (dB/m)	Level (dBuV/m)	Limit (dBuV/m)	Margin (dB)	Detector	Direction (H/V)
Fundamental	433.92	98.67	-11.32	87.35	100.83	13.48	PK	H
Spurious	434.59	44.54	-12.39	32.15	46.00	13.85	PK	H
Harmonics	867.84	73.31	-17.65	55.66	80.83	25.17	PK	H
Harmonics	1301.76	48.72	5.38	54.10	74.00	19.90	PK	H
--	--	--	--	--	--	--	--	--
Fundamental	433.92	94.99	-11.32	83.67	100.83	30.00	PK	V
Spurious	434.59	46.34	-12.39	33.95	46.00	15.31	PK	V
Harmonics	867.84	72.01	-17.65	54.36	80.83	24.12	PK	V
Harmonics	1301.76	48.57	5.38	53.95	74.00	26.26	PK	V
--	--	--	--	--	--	--	--	--

Emission Styles	Frequency (MHz)	PK Level (dBuV/m)	AV Factor (dB/m)	AV Level (dBuV/m)	Limit (dBuV/m)	Margin (dB)	Direction (H/V)
Fundamental	433.92	87.35	-9.91	77.44	80.83	3.39	H
Harmonics	867.84	55.66	-9.91	45.75	60.83	15.08	H
Harmonics	1301.76	54.10	-9.91	44.19	54.00	9.81	H
--	--	--	--	--	--	--	--
Fundamental	433.92	83.67	-9.91	73.76	80.83	7.07	V
Harmonics	867.84	54.36	-9.91	44.45	60.83	16.38	V
Harmonics	1301.76	53.95	-9.91	44.04	54.00	9.96	V
--	--	--	--	--	--	--	--

Note:

- Level (dBuV/m)= Reading (dBuV)+Factor(dB/m)
- AV Level (dBuV/m)= PK Level (dBuV/m)+ AV Factor(dB)
- In a transmit cycle 100ms period found burst 25pcs, the Duty Cycle can calculate as below:  
 Duty Cycle= (0.61\*9+0.19\*16)/ 26.70=(5.49+3.04)/26.70=0.3195  
 AV Factor=20\*log(Duty Cycle)=20\*log(0.3195)=-9.91

(The plot of Duty Cycle See the follow page)

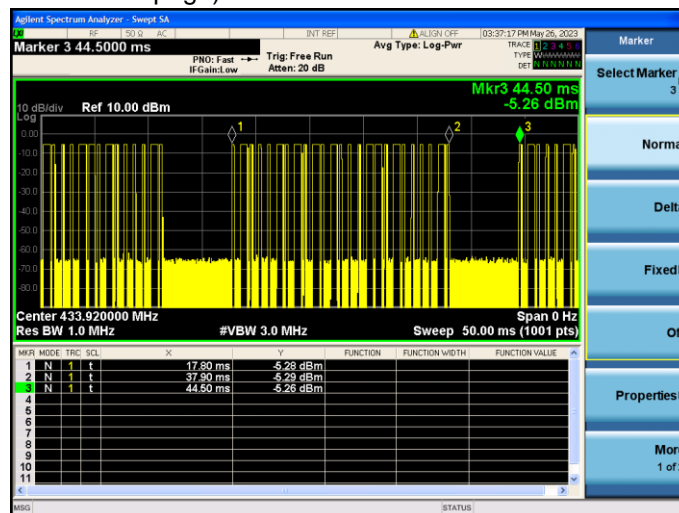

(Transmit cycle 26.70ms)

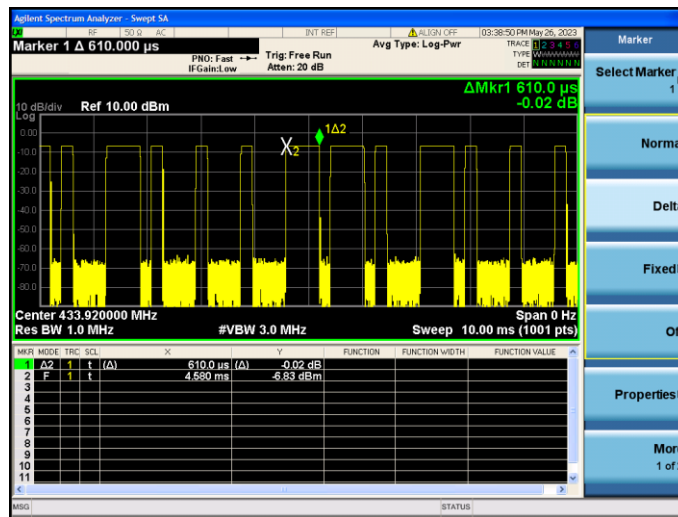

(Time per burst: 0.61ms\*9pcs)

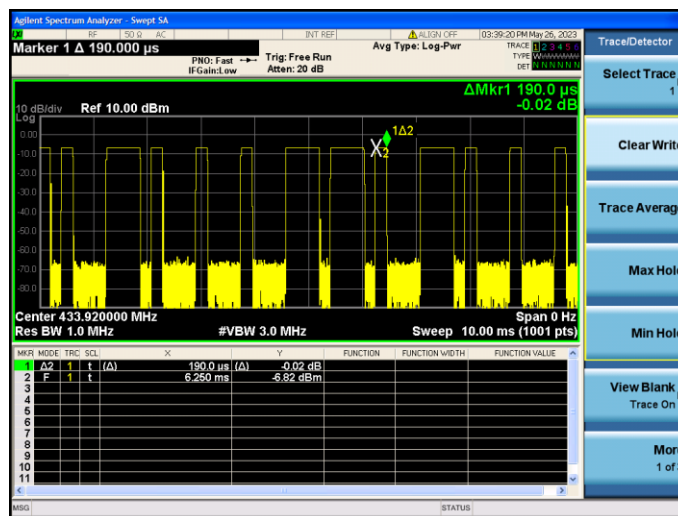

(Time per burst: 0.19ms\*16pcs)



### 4.3 20dB Bandwidth

#### Limit

According to 47 CFR 15.231(c) The bandwidth of the emission shall be no wider than 0.25% of the centre frequency for devices operating above 70MHz and below 900MHz. Bandwidth is determined at the points 20dB down from the modulated carrier.

#### Test Configuration

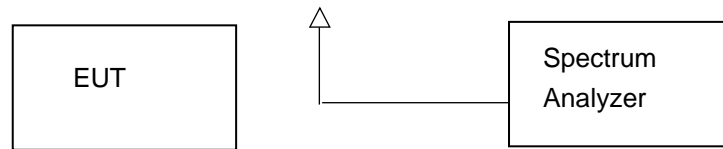

#### Test Procedure

The 20dB bandwidth and 99% bandwidth is measured with a spectrum analyzer connected via a receive antenna placed near the EUT while the EUT is operating in transmission mode.

The 20dB bandwidth is defined as the total spectrum the power of which is higher than peak power minus 20dB.

The occupied bandwidth (OBW), that is the frequency bandwidth such that, below its lower and above its upper frequency limits, the mean powers radiated are each equal to 0.5 percent of the total mean power radiated by a given emission.

#### Test Results

Modulation	Channel Frequency (MHz)	99% OBW (KHz)	20dB bandwidth (KHz)	Limit (KHz)	Result
ASK	433.9200	210.29	52.41	0.25%*433.9200=1084.8	Pass

Test plot as follows:

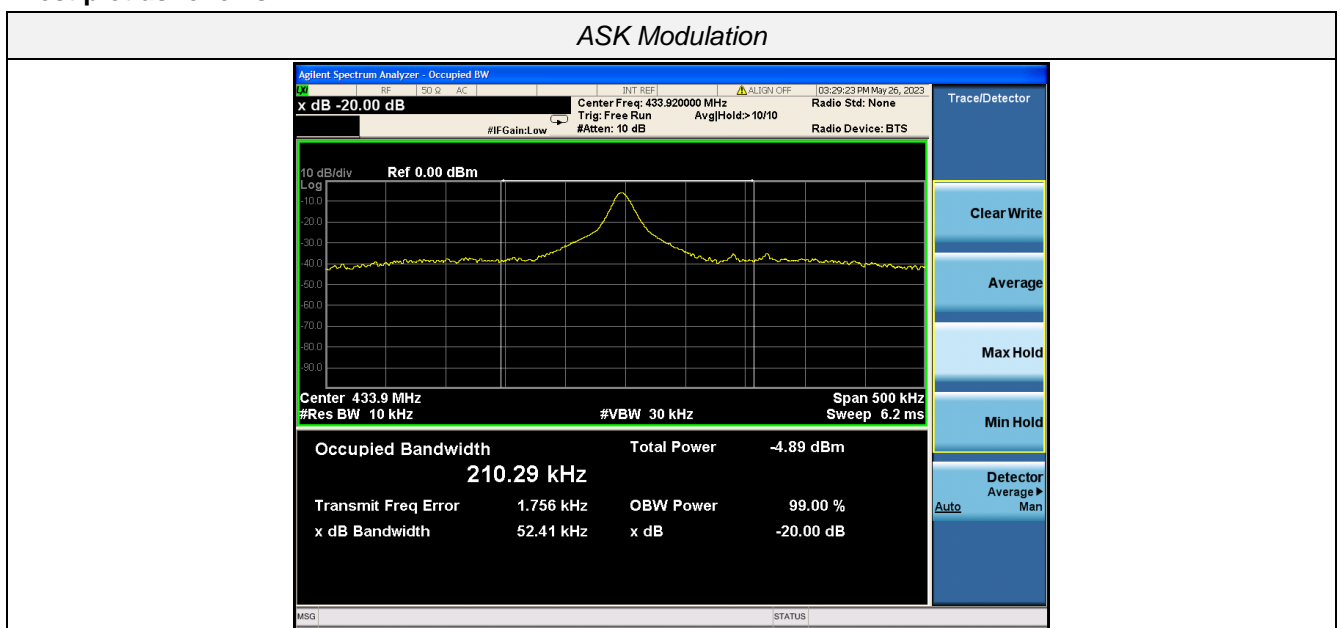

### 4.4 Deactivation Time

#### Limit

According to FCC §15.231(a)(2), A transmitter activated automatically shall cease transmission within 5 seconds after activation.

#### Test Configuration

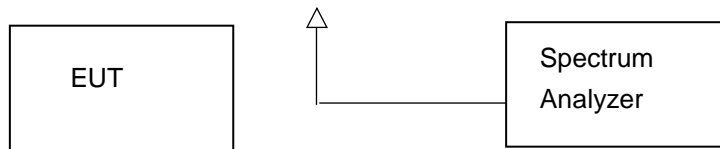

#### Test Procedure

1. The EUT was placed on a wooded table which is 0.8m height and close to receiver antenna of spectrum analyzer.
2. The spectrum analyzer resolution bandwidth was set to 1 MHz and video bandwidth was set to 1 MHz to encompass all significant spectral components during the test. The spectrum analyzer was operated in linear scale and zero span mode after tuning to the transmitter carrier frequency.

### TEST RESULTS

Note: The transmitter was automatically activated, and the carrier frequency 433.7817MHz:

Frequency (MHz)	One transmission time (S)	Limit(S)	Result
433.9200	0.270	5	Pass

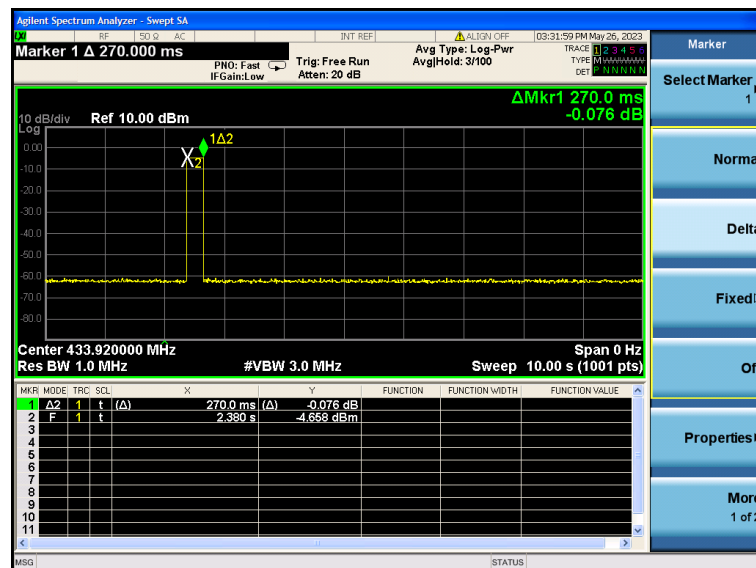

## 4.5 Antenna Requirement

### Standard Applicable

According to FCC Part 15C 15.203

- a) An intentional radiator shall be de-signed to ensure that no antenna other than that furnished by the responsible party shall be used with the device.
- b) The manufacturer may design the unit so that a broken antenna can be replaced by the user, but the use of a standard antenna jack or electrical connector is prohibited.

### **Refer to statement below for compliance.**

The manufacturer may design the unit so that the user can replace a broken antenna, but the use of a standard antenna jack or electrical connector is prohibited. Further, this requirement does not apply to intentional radiators that must be professionally installed.

### Antenna Connected Construction

The antenna used in this product is an Internal Antenna, The directional gains of antenna used for transmitting is 1.0 dBi.

Remark:The antenna gain is provided by the customer , if the data provided by the customer is not accurate, Shenzhen HTT Technology Co.,Ltd. does not assume any responsibility.

## **5 Test Setup Photos of the EUT**

Reference to the **appendix I** for details

## **6 Photos of the EUT**

Reference to the **appendix II** for details.

**\*\*\*\*\* End of Report \*\*\*\*\***