

TEST REPORT

Product Name : Storm Gaming Controller
Model Number : STORM CONTROLLER
FCC ID : 2AR8X-CMSCBT
IC : 24668-CMSCBT

Prepared for : Cooler Master Technology Inc.
Address : 7F., No. 398, Xinhua 1st Rd., Neihu Dist., Taipei City
114065 , Taiwan

Prepared by : EMTEK (SHENZHEN) CO., LTD.
Address : Building 69, Majialong Industry Zone, Nanshan District,
Shenzhen, Guangdong, China

Tel: (0755) 26954280
Fax: (0755) 26954282

Report Number : ENS2208310269W00601R
Date(s) of Tests : September 23, 2022 to October 18, 2022
Date of issue : October 20, 2022

Table of Contents

1	TEST RESULT CERTIFICATION	3
2	EUT TECHNICAL DESCRIPTION	5
3	SUMMARY OF TEST RESULT	6
4	TEST METHODOLOGY	7
4.1	GENERAL DESCRIPTION OF APPLIED STANDARDS	7
4.2	MEASUREMENT EQUIPMENT USED	7
4.3	DESCRIPTION OF TEST MODES.....	8
5	FACILITIES AND ACCREDITATIONS	9
5.1	FACILITIES	9
5.2	EQUIPMENT.....	9
5.3	LABORATORY ACCREDITATIONS AND LISTINGS.....	9
6	TEST SYSTEM UNCERTAINTY	10
7	SETUP OF EQUIPMENT UNDER TEST	11
7.1	RADIO FREQUENCY TEST SETUP 1.....	11
7.2	RADIO FREQUENCY TEST SETUP 2.....	11
7.3	CONDUCTED EMISSION TEST SETUP.....	13
7.4	BLOCK DIAGRAM CONFIGURATION OF TEST SYSTEM.....	14
7.5	SUPPORT EQUIPMENT	14
8	FREQUENCY HOPPING SYSTEM REQUIREMENTS	15
8.1	STANDARD APPLICABLE	15
8.2	EUT PSEUDORANDOM FREQUENCY HOPPING SEQUENCE.....	15
8.3	EQUAL HOPPING FREQUENCY USE	16
8.4	FREQUENCY HOPPING SYSTEM.....	16
9	TEST REQUIREMENTS	17
9.1	20DB&99% BANDWIDTH.....	17
9.2	CARRIER FREQUENCY SEPARATION.....	23
9.3	NUMBER OF HOPPING FREQUENCIES	26
9.4	AVERAGE TIME OF OCCUPANCY (DWELL TIME).....	28
9.5	MAXIMUM PEAK CONDUCTED OUTPUT POWER.....	31
9.6	CONDUCTED SUPRIOUS EMISSION.....	34
9.7	RADIATED SPURIOUS EMISSION	42
9.8	CONDUCTED EMISSION TEST	57
9.9	ANTENNA APPLICATION	60

1 TEST RESULT CERTIFICATION

Applicant : Cooler Master Technology Inc.

Address : 7F., No. 398, Xinhu 1st Rd., Neihu Dist., Taipei City 114065 , Taiwan

Manufacturer : Dongguan Togran Electronics Technology Co.,Ltd.

Address : No. 110, Shidan Mid Rd, Shijie Town, Dongguan City, Guangdong Province, China 523290

EUT : Storm Gaming Controller

Model Name : STORM CONTROLLER

Trademark : 

Measurement Procedure Used:

APPLICABLE STANDARDS	
STANDARD	TEST RESULT
FCC 47 CFR Part 2, Subpart J FCC 47 CFR Part 15, Subpart C	PASS
IC RSS-GEN, Issue 5(04-2018)+A1(03-2019)+A2(02-2021) IC RSS-247 Issue 2(02-2017)	PASS

The above equipment was tested by EMTEK(SHENZHEN) CO., LTD. The test data, data evaluation, test procedures, and equipment configurations shown in this report were made in accordance with the procedures given in ANSI C63.10 (2013) and the energy emitted by the sample EUT tested as described in this report is in compliance with the requirements of FCC Rules Part 2, Part 15.247, IC RSS-247 Issue 2 and IC RSS-GEN, Issue 5.

The test results of this report relate only to the tested sample identified in this report

Date of Test : September 23, 2022 to October 18, 2022

Prepared by : 
Una Yu /Editor

Reviewer : 
Joe Xia/Supervisor

Approve & Authorized Signer : 
Lisa Wang/Manager



Modified History

Version	Report No.	Revision Date	Summary
V1.0	ENS2208310269W00601R	/	Original Report



2 EUT TECHNICAL DESCRIPTION

Characteristics	Description
Product:	Storm Gaming Controller
Model Number:	STORM CONTROLLER
Sample:	2#
Device Type:	Bluetooth V5.0
Data Rate:	1Mbps for GFSK modulation
Modulation:	GFSK
Operating Frequency Range(s) :	2402-2480MHz
Number of Channels:	79 channels
Transmit Power Max:	3.02 dBm
EIRP	1.52 dBm
Antenna Type:	PCB Antenna
Antenna Gain:	-1.5 dBi
HW	V1.1
SW	V1.4
Power supply:	DC 5V from USB Port DC 3.7V from Battery
Date of Received:	September 1, 2022
Temperature Range:	-20°C ~ +55°C

Note: for more details, please refer to the User's manual of the EUT.

3 SUMMARY OF TEST RESULT

FCC Part Clause	IC Part Clause	Test Parameter	Verdict	Remark
15.247(a)(1)	RSS-247.5.1 RSS-Gen.6.7	Emission Bandwidth	PASS	
15.247(a)(1)	RSS-247.5.1	Carrier Frequency Separation	PASS	
15.247(a)(1)	RSS-247.5.1	Number of Hopping Frequencies	PASS	
15.247(a)(1)	RSS-247.5.1	Average Time of Occupancy (Dwell Time)	PASS	
15.247(b)(1)	RSS-247.5.4 RSS-Gen 6.12	Maximum Peak Conducted Output Power	PASS	
15.247(d)	RSS-247 5.5	Conducted Spurious Emissions	PASS	
15.247(d) 15.209 15.205	RSS-Gen 8.9 RSS-Gen 8.10 RSS-Gen 6.13 RSS-247 3.3 RSS-247 5.5	Radiated Spurious Emissions	PASS	
15.207	RSS-Gen 8.8	Conducted Emission	PASS	
15.203 15.247(b)	RSS-Gen 6.8 RSS-247 5.4	Antenna Application	PASS	
15.247 (a) (1)/g/h	-	Frequency Hopping System	PASS	
NOTE1: N/A (Not Applicable)				
NOTE2: According to FCC OET KDB 558074, the report use radiated measurements in the restricted frequency bands. In addition, the radiated test is also performed to ensure the emissions emanating from the device cabinet also comply with the applicable limits.				

RELATED SUBMITTAL(S) / GRANT(S):

This submittal(s) (test report) is intended for **FCC ID: 2AR8X-CMSCBT** filing to comply with Section 15.247 of the FCC Part 15, Subpart C Rules.

This submittal(s) (test report) is intended for **IC: 24668-CMSCBT** filing to comply with RSS-247 Rules.

4 TEST METHODOLOGY

4.1 GENERAL DESCRIPTION OF APPLIED STANDARDS

According to its specifications, the EUT must comply with the requirements of the following standards:

FCC 47 CFR Part 2, Subpart J
 FCC 47 CFR Part 15, Subpart C
 IC RSS-GEN, Issue 5(04-2018)+A1(03-2019)+A2(02-2021)
 IC RSS-247 Issue 2(02-2017)
 FCC KDB 558074 D01 15.247 Meas Guidance v05r02

4.2 MEASUREMENT EQUIPMENT USED

Conducted Emission Test Equipment

Equipment	Manufacturer	Model No.	Serial No.	Last Cal.	Cal. Interval
Test Receiver	Rohde & Schwarz	ESCI	101384	May 14, 2022	1 Year
L.I.S.N.	Rohde & Schwarz	ENV216	5	May 14, 2022	1 Year
L.I.S.N.	Kyoritsu	KNW-407	8-1492-9	May 14, 2022	1 Year

For Spurious Emissions Test

Equipment	Manufacturer	Model No.	Serial No.	Last Cal.	Cal. Interval
EMI Test Receiver	Rohde & Schwarz	ESU 26	100154	May 14, 2022	1 Year
Pre-Amplifier	Lunar EM	LNA30M3G-25	J10100000070	May 14, 2022	1 Year
Bilog Antenna	Schwarzbeck	VULB9163	661	Aug. 22, 2021	2 Year
Horn antenna	Schwarzbeck	BBHA9120D	9120D-1177	Jun. 12, 2021	2 Year
Pre-Amplifier	SKET	LNPA_0118G-45	SK2019051801	May 14, 2022	1 Year
Loop Antenna	Schwarzbeck	FMZB1519	1519-012	Jun. 12, 2021	2 Year
Spectrum Analyzer	Rohde & Schwarz	FSV40	100967	May 14, 2022	1 Year
Horn antenna	Schwarzbeck	BBHA9120D	9120D-1178	Aug. 22, 2021	2 Year
Band reject Filter(50dB)	WI/DE	WRCGV-2400(2400-2485MHz)	2	May 14, 2022	1 Year

For other test items:

Equipment	Manufacturer	Model No.	Serial No.	Last Cal.	Cal. Interval
Wideband Radio Communication Tester	R&S	CMW500	171168	May. 3, 2022	1Year
Frequency Extender	R&S	CMW-Z800A	100430	May. 16, 2022	1Year
Signal Analyzer	R&S	FSV3044	MY60242456	Apr. 11, 2022	1Year
Analog Signal Generator	R&S	SMB100A	MY61252625	Apr. 22, 2022	1Year
Vector Signal Generator	R&S	SMM100A	MY61252674	May. 9, 2022	1Year
RF Control Unit	Tonscend	JS0806-2	22C8060567	Jul. 20, 2022	N/A
Temperature&Humidity Chamber	ESPEC	EL-02KA	12107166	Jul. 02, 2022	1 Year

4.3 DESCRIPTION OF TEST MODES

The EUT has been tested under its typical operating condition.

The EUT configuration for testing is installed on RF field strength measurement to meet the Commissions requirement and operating in a manner which intends to maximize its emission characteristics in a continuous normal application.

The Transmitter was operated in the normal operating mode. The TX frequency was fixed which was for the purpose of the measurements.

Test of channel included the lowest and middle and highest frequency to perform the test, then record on this report.

Those data rates (1Mbps for GFSK modulation(DH5))were used for all test.

Pre-defined engineering program for regulatory testing used to control the EUT for staying in continuous transmitting and receiving mode is programmed.

Frequency and Channel list for Bluetooth

Channel	Frequency (MHz)	Channel	Frequency (MHz)	Channel	Frequency (MHz)
0	2402	39	2441
1	2403	40	2442	76	2478
2	2404	41	2443	77	2479
...	78	2480

Note: $f_c = 2402\text{MHz} + (k-1) \times 1\text{MHz}$ k=1 to 79

Test Frequency and channel for Bluetooth

Lowest Frequency		Middle Frequency		Highest Frequency	
Channel	Frequency (MHz)	Channel	Frequency (MHz)	Channel	Frequency (MHz)
0	2402	39	2441	78	2480

5 FACILITIES AND ACCREDITATIONS

5.1 FACILITIES

All measurement facilities used to collect the measurement data are located at:

EMTEK (Shenzhen) Co., Ltd.

Building 69, Majialong Industry Zone District, Nanshan District, Shenzhen, China

The sites are constructed in conformance with the requirements of ANSI C63.7, ANSI C63.4 and CISPR Publication 22.

5.2 EQUIPMENT

Radiated emissions are measured with one or more of the following types of linearly polarized antennas: tuned dipole, biconical, log periodic, bi-log, and/or ridged waveguide, horn. Spectrum analyzers with preselectors and quasi-peak detectors are used to perform radiated measurements.

Conducted emissions are measured with Line Impedance Stabilization Networks and EMI Test Receivers.

Calibrated wideband preamplifiers, coaxial cables, and coaxial attenuators are also used for making measurements.

All receiving equipment conforms to CISPR Publication 16-1, "Radio Interference Measuring Apparatus and Measurement Methods."

5.3 LABORATORY ACCREDITATIONS AND LISTINGS

Site Description	
EMC Lab.	<p>Accredited by CNAS The Certificate Registration Number is L2291. The Laboratory has been assessed and proved to be in compliance with CNAS-CL01 (identical to ISO/IEC 17025:2017)</p> <p>Accredited by FCC Designation Number: CN1204 Test Firm Registration Number: 882943</p> <p>Accredited by A2LA The Certificate Number is 4321.01.</p> <p>Accredited by Industry Canada The Conformity Assessment Body Identifier is CN0008</p>
Name of Firm	: EMTEK (SHENZHEN) CO., LTD.
Site Location	: Building 69, Majialong Industry Zone, Nanshan District, Shenzhen, Guangdong, China

6 TEST SYSTEM UNCERTAINTY

The following measurement uncertainty levels have been estimated for tests performed on the apparatus:

Test Parameter	Measurement Uncertainty
Radio Frequency	$\pm 1 \times 10^{-5}$
Maximum Peak Output Power Test	$\pm 1.0\text{dB}$
Conducted Emissions Test	$\pm 2.0\text{dB}$
Radiated Emission Test	$\pm 2.0\text{dB}$
Power Density	$\pm 2.0\text{dB}$
Occupied Bandwidth Test	$\pm 1.0\text{dB}$
Band Edge Test	$\pm 3\text{dB}$
All emission, radiated	$\pm 3\text{dB}$
Antenna Port Emission	$\pm 3\text{dB}$
Temperature	$\pm 0.5^\circ\text{C}$
Humidity	$\pm 3\%$

Measurement Uncertainty for a level of Confidence of 95%

7 SETUP OF EQUIPMENT UNDER TEST

7.1 RADIO FREQUENCY TEST SETUP 1

The Bluetooth component's antenna ports(s) of the EUT are connected to the measurement instrument per an appropriate attenuator. The EUT is controlled by PC/software to emit the specified signals for the purpose of measurements.

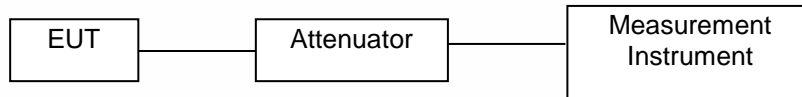

7.2 RADIO FREQUENCY TEST SETUP 2

The test site semi-anechoic chamber has met the requirement of NSA tolerance 4 dB according to the standards: ANSI C63.10. The test distance is 3m. The setup is according to the requirements in Section 13.1.4.1 of ANSI C63.10-2013 and CAN/CSA-CEI/IEC CISPR 22.

Below 30MHz:

The EUT is placed on a turntable 0.8meters above the ground in the chamber, 3 meter away from the antenna (loop antenna). The Antenna should be positioned with its plane vertical at the specified distance from the EUT and rotated about its vertical axis for maximum response at each azimuth about the EUT. The center of the loop shall be 1 m above the ground. For certain applications, the loop antenna plane may also need to be positioned horizontally at the specified distance from the EUT.

Above 30MHz:

The EUT is placed on a turntable 0.8meters above the ground in the chamber, 3 meter away from the antenna. The maximal emission value is acquired by adjusting the antenna height, polarisation and turntable azimuth. Normally, the height range of antenna is 1 m to 4 m, the azimuth range of turntable is 0° to 360°, and the receive antenna has two polarizations Vertical (V) and Horizontal (H).

Above 1GHz:

(Note: the FCC's permission to use 1.5m as an alternative per TCBC Conf call of Dec. 2, 2014.)

The EUT is placed on a turntable 1.5 meters above the ground in the chamber, 3 meter away from the antenna. The maximal emission value is acquired by adjusting the antenna height, polarisation and turntable azimuth. Normally, the height range of antenna is 1 m to 4 m, the azimuth range of turntable is 0° to 360°, and the receive antenna has two polarizations Vertical (V) and Horizontal (H).

(a) Radiated Emission Test Set-Up, Frequency Below 30MHz

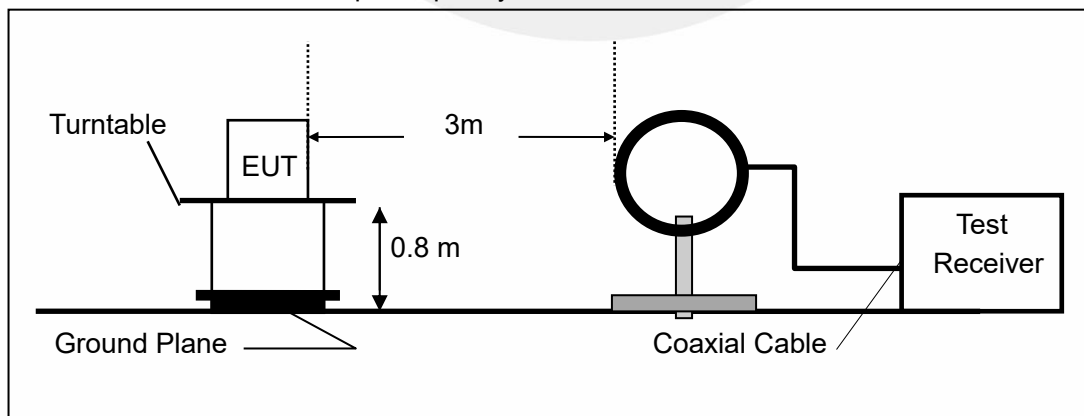

(b) Radiated Emission Test Set-Up, Frequency Below 1000MHz

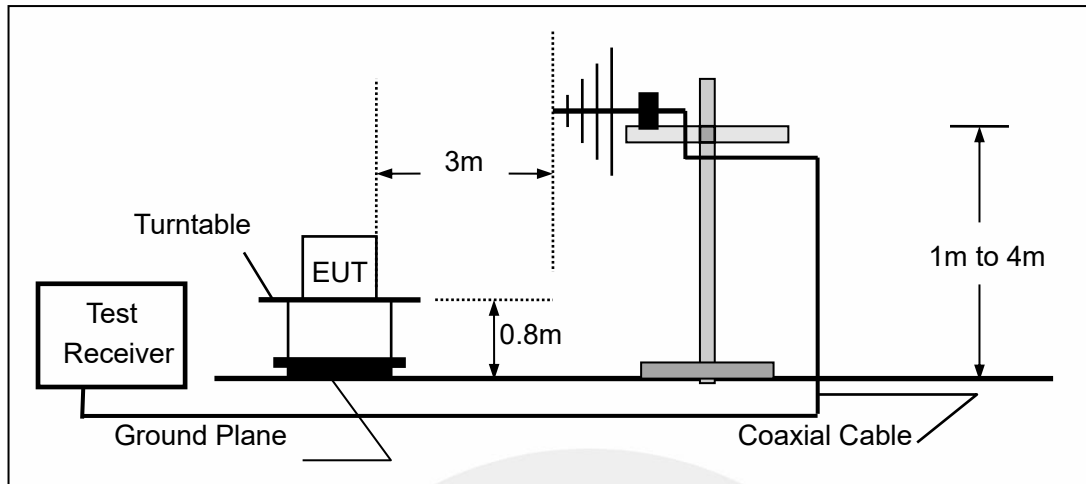

(c) Radiated Emission Test Set-Up, Frequency above 1000MHz

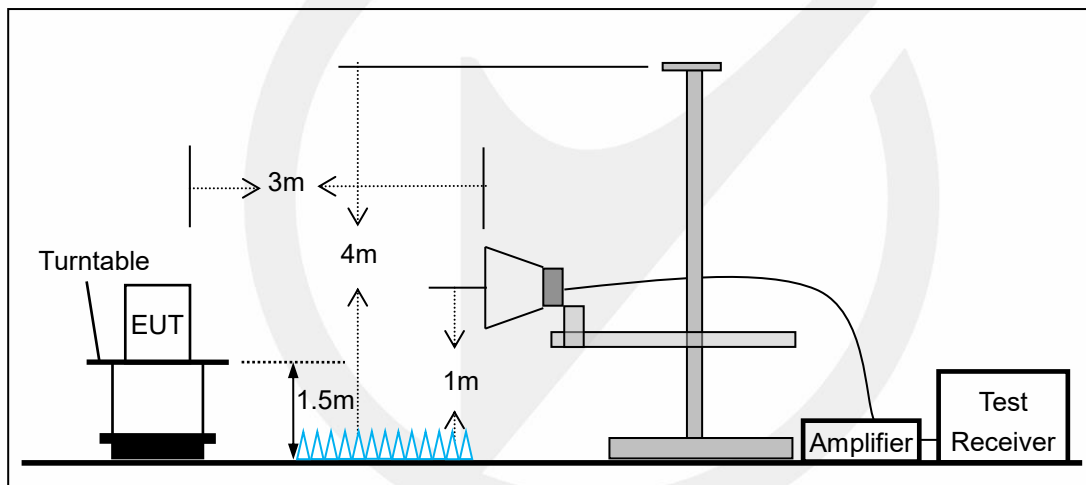

7.3 CONDUCTED EMISSION TEST SETUP

The mains cable of the EUT (Perfect Share Mini) must be connected to LISN. The LISN shall be placed 0.8m from the boundary of EUT and bonded to a ground reference plane for LISN mounted on top of the ground reference plane. This distance is between the closest points of the LISN and the EUT. All other units of the EUT and associated equipment shall be at least 0.8m from the LISN.

Ground connections, where required for safety purposes, shall be connected to the reference ground point of the LISN and, where not otherwise provided or specified by the manufacturer, shall be of same length as the mains cable and run parallel to the mains connection at a separation distance of not more than 0.8m.

According to the requirements in Section 13.1.4.1 of ANSI C63.10-2013 Conducted emissions from the EUT measured in the frequency range between 0.15 MHz and 30 MHz using CISPR Quasi-Peak and average detector mode.

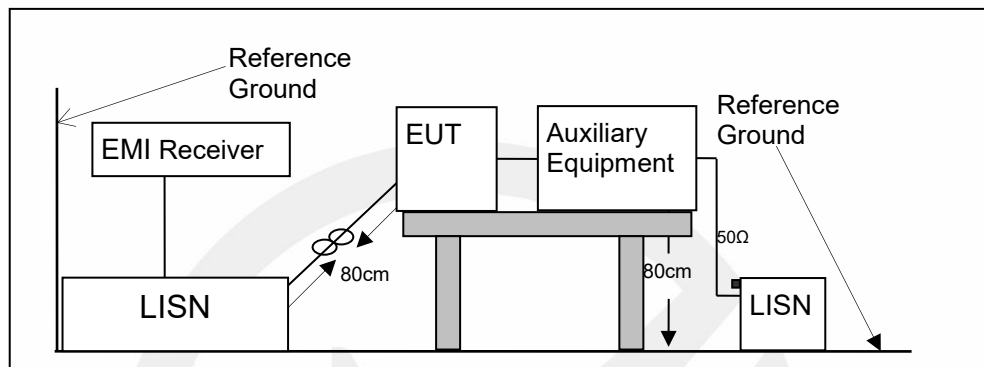

7.4 BLOCK DIAGRAM CONFIGURATION OF TEST SYSTEM

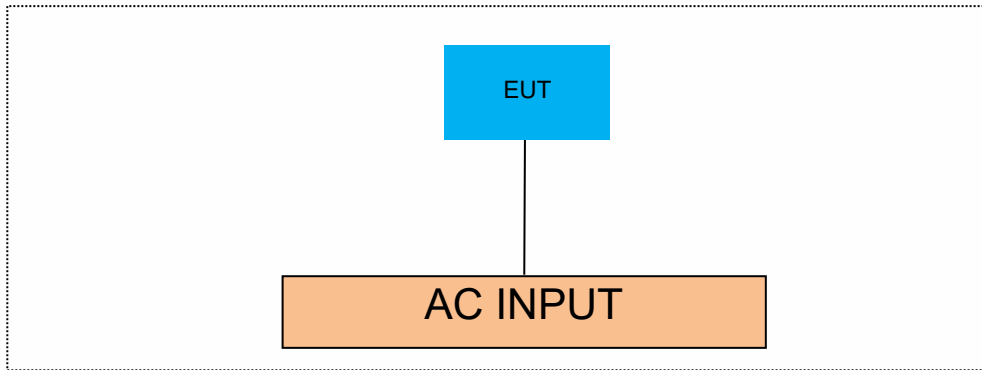

7.5 SUPPORT EQUIPMENT

EUT Cable List and Details			
Cable Description	Length (m)	Shielded/Unshielded	With / Without Ferrite
/	/	/	/

Auxiliary Cable List and Details			
Cable Description	Length (m)	Shielded/Unshielded	With / Without Ferrite
/	/	/	/

Auxiliary Equipment List and Details			
Description	Manufacturer	Model	Serial Number

Notes:

1. All the equipment/cables were placed in the worst-case configuration to maximize the emission during the test.
2. Grounding was established in accordance with the manufacturer’s requirements and conditions for the intended use.

8 FREQUENCY HOPPING SYSTEM REQUIREMENTS

8.1 Standard Applicable

According to FCC Part 15.247(a)(1), The system shall hop to channel frequencies that are selected at the system hopping rate from a pseudo randomly ordered list of hopping frequencies. Each frequency must be used equally on the average by each transmitter. The system receivers shall have input bandwidths that match the hopping channel bandwidths of their corresponding transmitters and shall shift frequencies in synchronization with the transmitted signals.

(g) Frequency hopping spread spectrum systems are not required to employ all available hopping channels during each transmission. However, the system, consisting of both the transmitter and the receiver, must be designed to comply with all of the regulations in this section should the transmitter be presented with a continuous data (or information) stream. In addition, a system employing short transmission bursts must comply with the definition of a frequency hopping system and must distribute its transmissions over the minimum number of hopping channels specified in this section.

(h) The incorporation of intelligence within a frequency hopping spread spectrum system that permits the system to recognize other users within the spectrum band so that it individually and independently chooses and adapts its hopsets to avoid hopping on occupied channels is permitted. The coordination of frequency hopping systems in any other manner for the express purpose of avoiding the simultaneous occupancy of individual hopping frequencies by multiple transmitters is not permitted.

8.2 EUT Pseudorandom Frequency Hopping Sequence

The channel is represented by a pseudo-random hopping sequence hopping through the 79 RF channels. The hopping sequence is unique for the piconet and is determined by the Bluetooth device address of the master; the phase in the hopping sequence is determined by the Bluetooth clock of the master. The channel is divide into time slots where each slot corresponds to an RF hop frequency. Consecutive hops correspond to different RF hop frequencies. The normal hop is 1 600 hops/s.

The pseudorandom sequence may be generated in a nine-stage shift register whose 5th and 9th stage outputs are added in a modulo-two addition stage, and the result is fed back to the input of the first stage. The sequence begins with the first ONE of 9 consecutive ONES; i.e. the shift register is initialized with nine ones. Number of shift register stages: 9

Length of pseudo-random sequence: $2^9 - 1 = 511$ bits

Longest sequence of zeros: 8 (non-inverted signal)

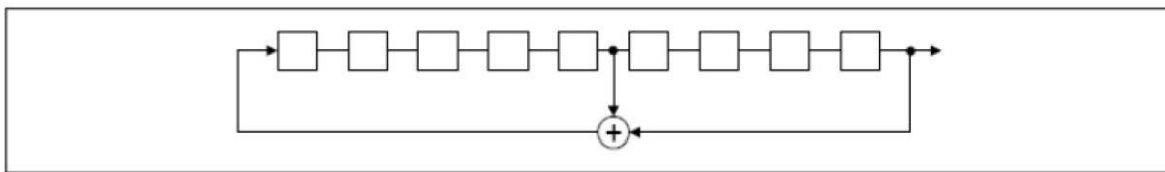

Linear Feedback Shift Register for Generation of the PRBS sequence

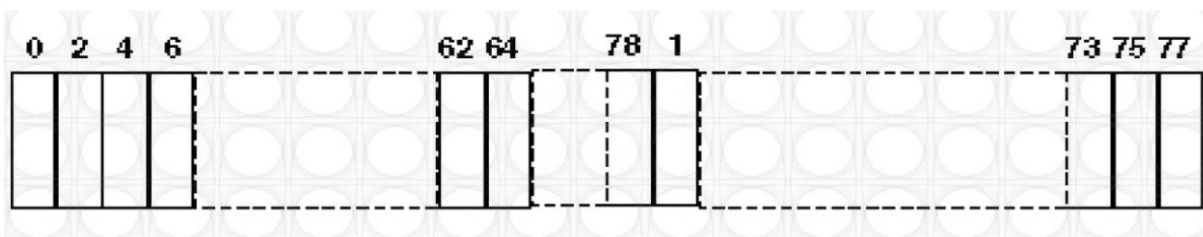

Each frequency used equally on the average by each transmitter.

The system receiver have input bandwidths that match the hopping channel bandwidths of their corresponding transmitters and shift frequencies in synchronization with the transmitted signals.

8.3 Equal Hopping Frequency Use

All Bluetooth units participating in the piconet are time and hop-synchronized to the channel.

Example of a 79 hopping sequence in data mode:

35, 27, 6, 44, 14, 61, 74, 32, 1, 11, 23, 2, 55, 65, 29, 3, 9, 52, 78, 58, 40, 25, 0, 7, 18, 26, 76, 60, 47, 50, 2, 5, 16, 37, 70, 63, 66, 54, 20, 13, 4, 8, 15, 21, 26, 10, 73, 77, 67, 69, 43, 24, 57, 39, 46, 72, 48, 33, 17, 31, 75, 19, 41, 62, 68, 28, 51, 66, 30, 56, 34, 59, 71, 22, 49, 64, 38, 45, 36, 42, 53

Each Frequency used equally on the average by each transmitter

8.4 Frequency Hopping System

This transmitter device is frequency hopping device, and complies with FCC part 15.247 rule.

This device uses Bluetooth radio which operates in 2400-2483.5 MHz band. Bluetooth uses a radio technology called frequency-hopping spread spectrum, which chops up the data being sent and transmits chunks of it on up to 79 bands (1 MHz each; centred from 2402 to 2480 MHz) in the range 2,400-2,483.5 MHz. The transmitter switches hop frequencies 1,600 times per second to assure a high degree of data security. All Bluetooth devices participating in a given piconet are synchronized to the frequency-hopping channel for the piconet. The frequency hopping sequence is determined by the master's device address and the phase of the hopping sequence (the frequency to hop at a specific time) is determined by the master's internal clock. Therefore, all slaves in a piconet must know the master's device address and must synchronize their clocks with the master's clock.

Adaptive Frequency Hopping (AFH) was introduced in the Bluetooth specification to provide an effective way for a Bluetooth radio to counteract normal interference. AFH identifies "bad" channels, where either other wireless devices are interfering with the Bluetooth signal or the Bluetooth signal is interfering with another device. The AFH-enabled Bluetooth device will then communicate with other devices within its piconet to share details of any identified bad channels. The devices will then switch to alternative available "good" channels, away from the areas of interference, thus having no impact on the bandwidth used.

9 TEST REQUIREMENTS

9.1 20DB&99% BANDWIDTH

9.1.1 Applicable Standard

According to FCC Part 15.247(a)(1)

According to RSS-247.5.1

According to RSS-Gen.6.7

According to 558074 D01 15.247 MEAS GUIDANCE v05r02 Section 9

According to ANSI C63.10 Section 6.9.2 and 6.9.3

9.1.2 Conformance Limit

No limit requirement.

9.1.3 Test Configuration

Test according to clause 7.1 radio frequency test setup 1

9.1.4 Test Procedure

The EUT was operating in Bluetooth mode and controlled its channel. Printed out the test result from the spectrum by hard copy function.

The RF output of EUT was connected to the spectrum analyzer by RF cable and attenuator. The path loss was compensated to the results for each measurement.

Set to the maximum power setting and enable the EUT transmit continuously

Set RBW = 30 kHz.

Set the video bandwidth (VBW) =100 kHz.

Set Span= approximately 2 to 3 times the 20 dB bandwidth

Set Detector = Peak.

Set Trace mode = max hold.

Set Sweep = auto couple.

The EUT should be transmitting at its maximum data rate. Allow the trace to stabilize. Use the marker-to-peak function to set the marker to the peak of the emission. Use the marker-delta function to measure 20 dB down one side of the emission. Reset the markerdelta function, and move the marker to the other side of the emission, until it is (as close as possible to) even with the reference marker level. The marker-delta reading at this point is the 20 dB bandwidth of the emission.

If this value varies with different modes of operation (e.g., data rate, modulation format, etc.), repeat this test for each variation.

Measure and record the results in the test report.

Test Results

Temperature:	25° C
Relative Humidity:	45%
ATM Pressure:	1011 mbar
Test Engineer:	XXH

Note: N/A

20dB Emission Bandwidth

TestMode	Antenna	Frequency[MHz]	20db EBW[MHz]	FL[MHz]	FH[MHz]	Limit[MHz]	Verdict
DH5	Ant1	2402	0.95	2401.52	2402.47	---	---
		2441	0.95	2440.52	2441.47	---	---
		2480	0.96	2479.51	2480.47	---	---

Occupied Channel Bandwidth

TestMode	Antenna	Frequency[MHz]	OCB [MHz]	FL[MHz]	FH[MHz]	Limit[MHz]	Verdict
DH5	Ant1	2402	0.867	2401.5469	2402.4138	---	---
		2441	0.871	2440.5451	2441.4163	---	---
		2480	0.877	2479.5427	2480.4192	---	---



20dB Emission Bandwidth

DH5_Ant1_2402



DH5_Ant1_2441

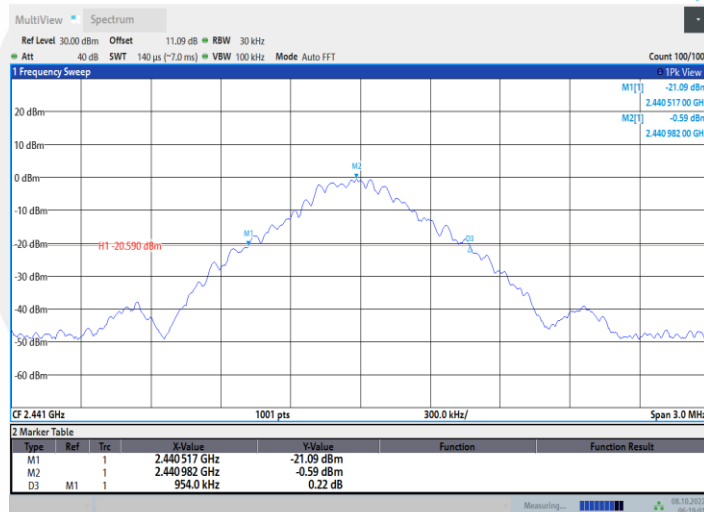

DH5_Ant1_2480

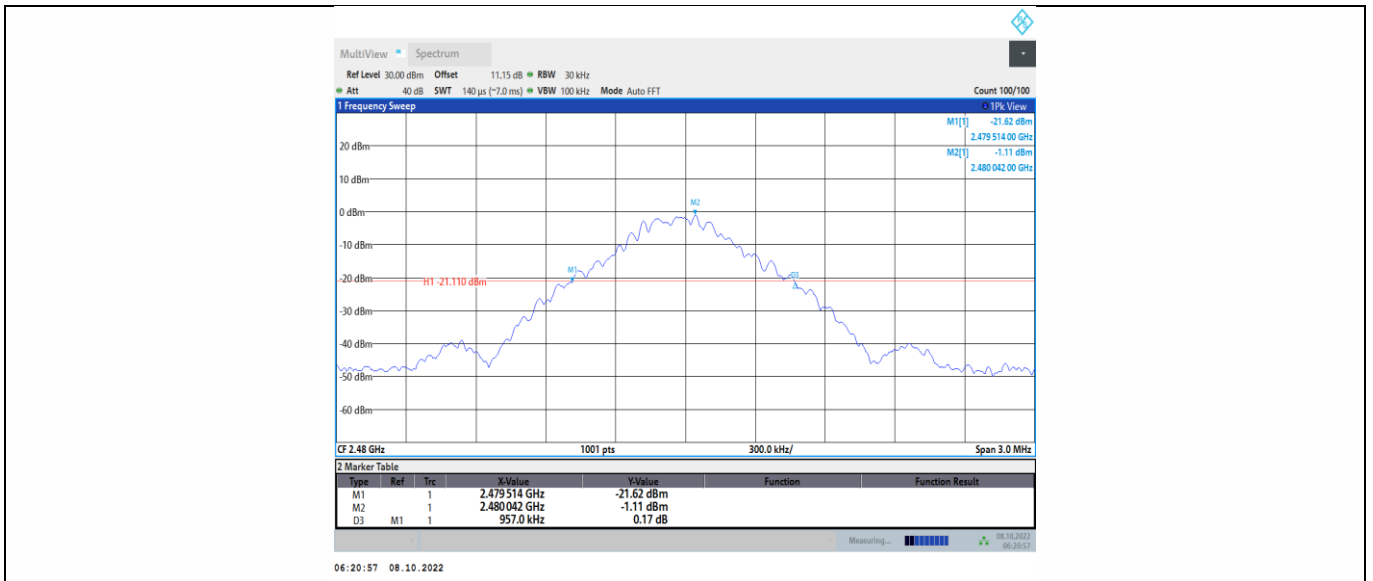

Occupied Channel Bandwidth

DH5_Ant1_2402

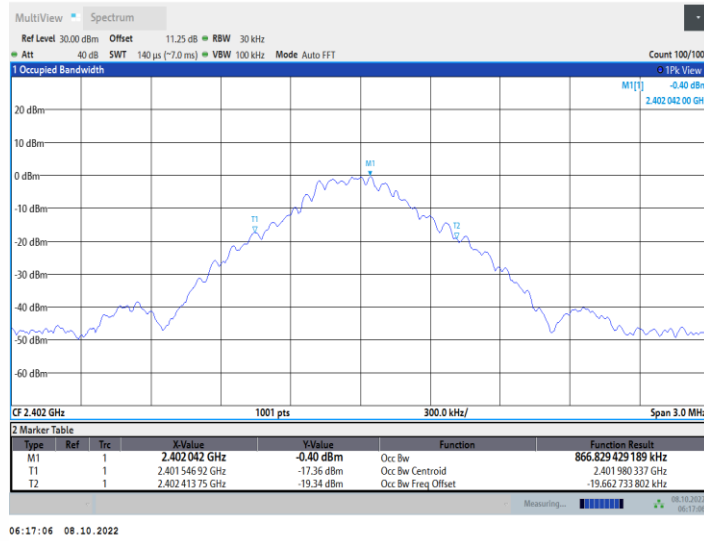

DH5_Ant1_2441

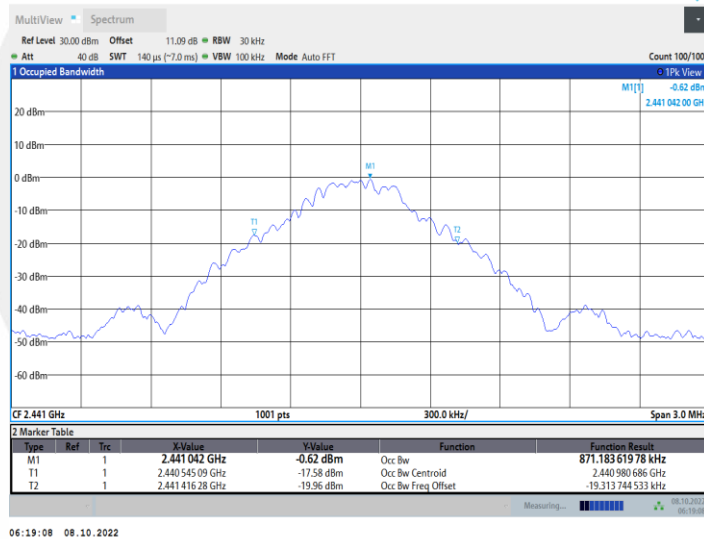

DH5_Ant1_2480

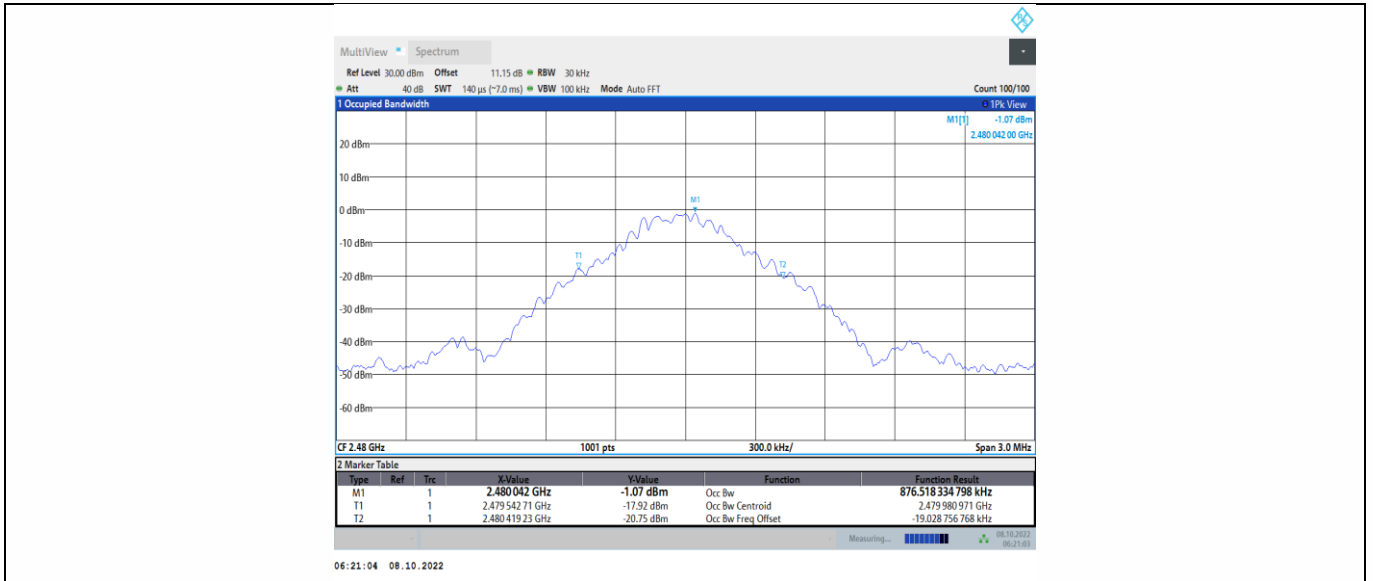

9.2 CARRIER FREQUENCY SEPARATION

9.2.1 Applicable Standard

According to FCC Part 15.247(a)(1)

According to IC RSS-247.5.1

According to 558074 D01 15.247 MEAS GUIDANCE v05r02 Section 9

According to ANSI C63.10 Section 7.8.2

9.2.2 Conformance Limit

Frequency hopping systems operating in the 2400-2483.5MHz band shall have hopping channel carrier frequencies separated by a minimum of 25kHz or the 20dB bandwidth of the hopping channel, whichever is greater.

In case of an output power less than 125mW, the frequency hopping system may have channels separated by a minimum of 25kHz or two-thirds of the 20dB bandwidth of the hopping channel, whichever is greater.

9.2.3 Test Configuration

Test according to clause 7.1 radio frequency test setup 1

9.2.4 Test Procedure

The EUT must have its hopping function enabled. Use the following spectrum analyzer settings:

Set the RBW =300kHz. Set VBW =300kHz.

Set the span = wide enough to capture the peaks of two adjacent channels

Set Sweep time = auto couple.

Set Detector = peak. Set Trace mode = max hold.

Allow the trace to stabilize. Use the marker-delta function to determine the separation between the peaks of the adjacent channels. The limit is specified in one of the subparagraphs of this Section. Submit this plot.

Test Results

Temperature:	25° C
Relative Humidity:	45%
ATM Pressure:	1011 mbar
Test Engineer:	XXH

Note: For Limit = 20dB bandwidth * 2/3

TestMode	Antenna	Frequency[MHz]	Result[MHz]	Limit[MHz]	Verdict
DH5	Ant1	Hop_2402	1	≥0.960	PASS
		Hop_2441	1.012	≥0.960	PASS
		Hop_2480	0.998	≥0.960	PASS

DH5_Ant1_Hop_2402

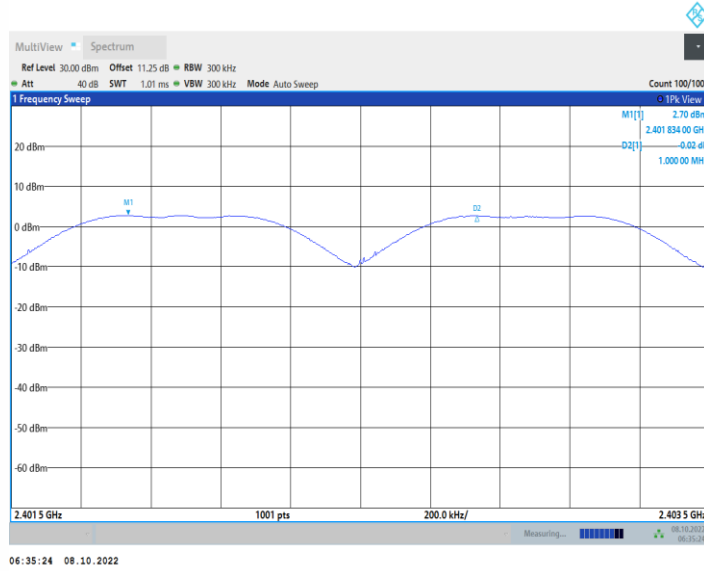

DH5_Ant1_Hop_2441

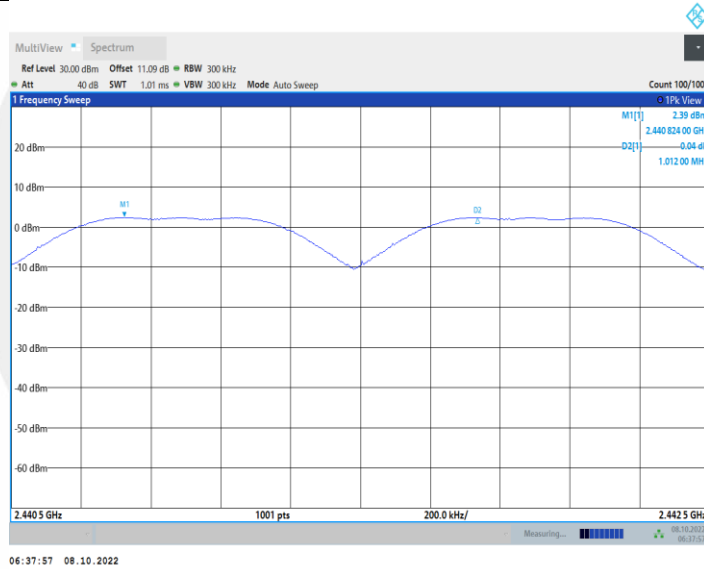

DH5_Ant1_Hop_2480

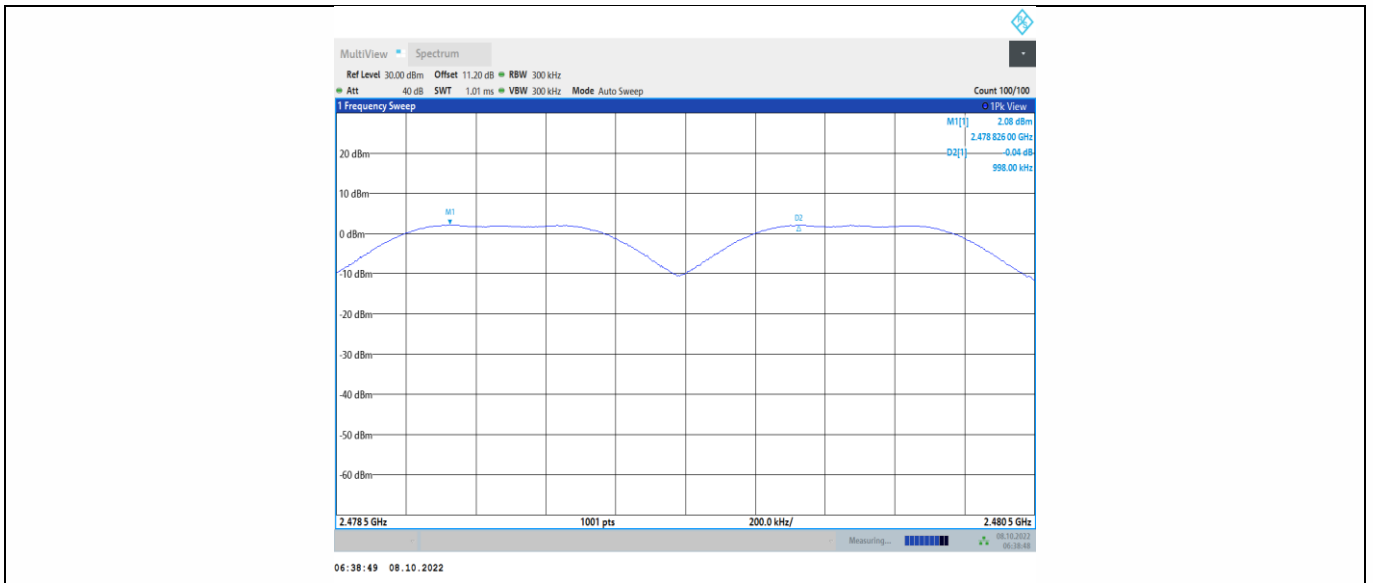

9.3 NUMBER OF HOPPING FREQUENCIES

9.3.1 Applicable Standard

According to FCC Part 15.247(a)(1)

According to IC RSS-247.5.1

According to 558074 D01 15.247 MEAS GUIDANCE v05r02 Section 9

According to ANSI C63.10 Section 7.8.3

9.3.2 Conformance Limit

Frequency hopping systems operating in the 2400-2483.5MHz band shall use at least 15 channels.

9.3.3 Test Configuration

Test according to clause 7.1 radio frequency test setup 1

9.3.4 Test Procedure

The EUT must have its hopping function enabled. Use the following spectrum analyzer settings:

Span = the frequency band of operation (2400-2483.5MHz)

RBW = 300KHz

VBW ≥ RBW

Sweep = auto

Detector function = peak

Trace = max hold

Allow the trace to stabilize. It may prove necessary to break the span up to sections, in order to clearly show all of the hopping frequencies.

Test Results

Temperature:	25° C
Relative Humidity:	45%
ATM Pressure:	1011 mbar
Test Engineer:	XXH

Note: N/A

TestMode	Antenna	Frequency[MHz]	Result[Num]	Limit[Num]	Verdict
DH5	Ant1	Hop	79	≥15	PASS

DH5_Ant1_Hop

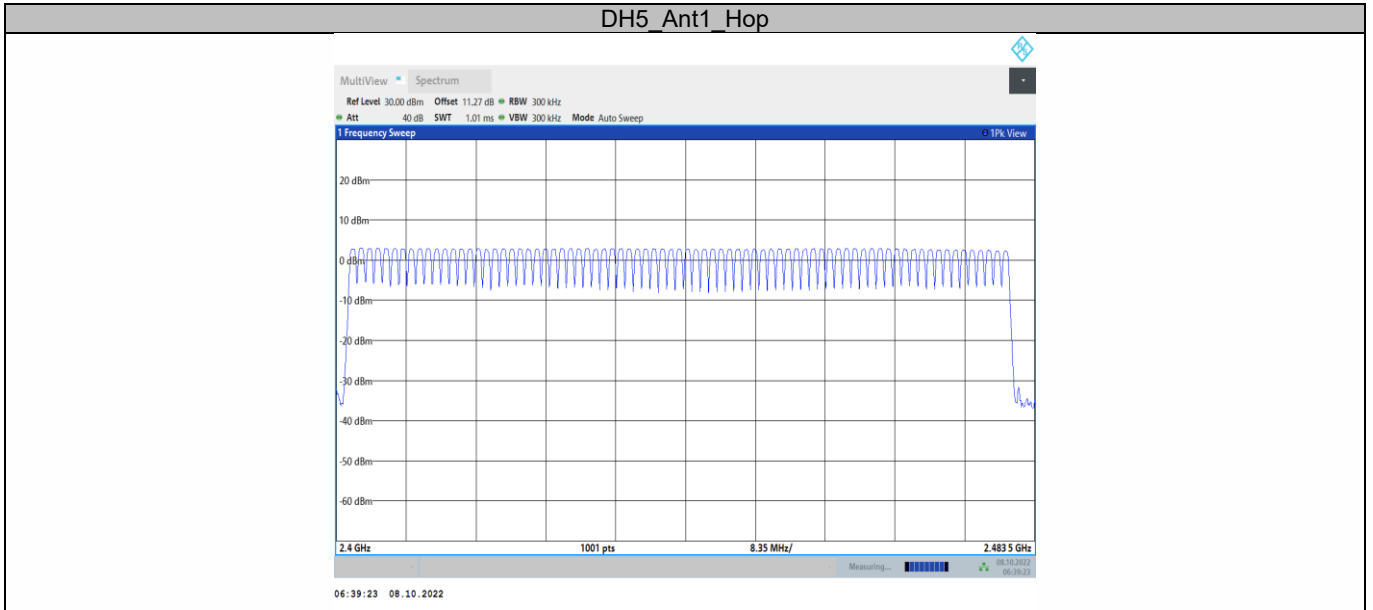

9.4 AVERAGE TIME OF OCCUPANCY (DWELL TIME)

9.4.1 Applicable Standard

According to FCC Part 15.247(a)(1)

According to IC RSS-247.5.1

According to 558074 D01 15.247 MEAS GUIDANCE v05r02 Section 9

According to ANSI C63.10 Section 7.8.4

9.4.2 Conformance Limit

For frequency hopping systems operating in the 2400-2483.5MHz band, the average time of occupancy on any channel shall not be greater than 0.4s within a period of 0.4s multiplied by the number of hopping channels employed.

9.4.3 Test Configuration

Test according to clause 7.1 radio frequency test setup 1

9.4.4 Test Procedure

The EUT must have its hopping function enabled. Use the following spectrum analyzer settings:

Span = zero span, centered on a hopping channel

RBW = 1 MHz

VBW ≥ RBW

Sweep = as necessary to capture the entire dwell time per hopping channel

Detector function = peak

Trace = max hold

If possible, use the marker-delta function to determine the dwell time. If this value varies with different modes of operation (e.g., data rate, modulation format, etc.), repeat this test for each variation. The limit is specified in one of the subparagraphs of this Section.

9.4.5 Test Results

Temperature:	25° C
Relative Humidity:	45%
ATM Pressure:	1011 mbar
Test Engineer:	XXH

Note: TotalHops(DH1)=(1600/2/79)*31.6

TotalHops(DH3)=(1600/4/79)*31.6

TotalHops(DH5)=(1600/6/79)*31.6

Dwell Time= BurstWidth* TotalHops

TestMode	Antenna	Frequency[MHz]	BurstWidth [ms]	TotalHops [Num]	Result[s]	Limit[s]	Verdict
DH1	Ant1	Hop	0.42	320	0.134	≤0.4	PASS
DH3	Ant1	Hop	1.68	160	0.269	≤0.4	PASS
DH5	Ant1	Hop	2.93	106.67	0.313	≤0.4	PASS

DH1_Ant1_Hop

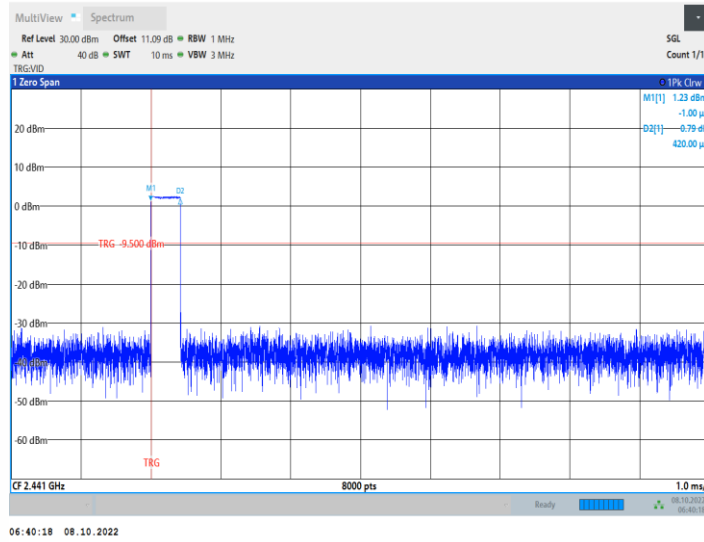

DH3_Ant1_Hop

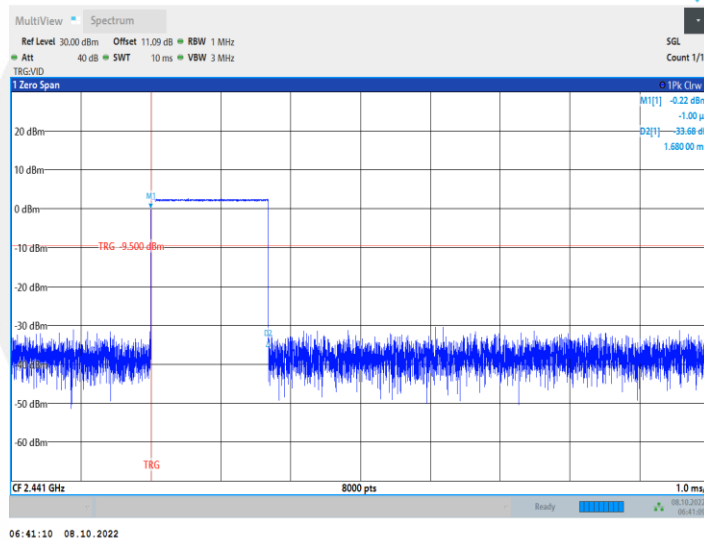

DH5_Ant1_Hop

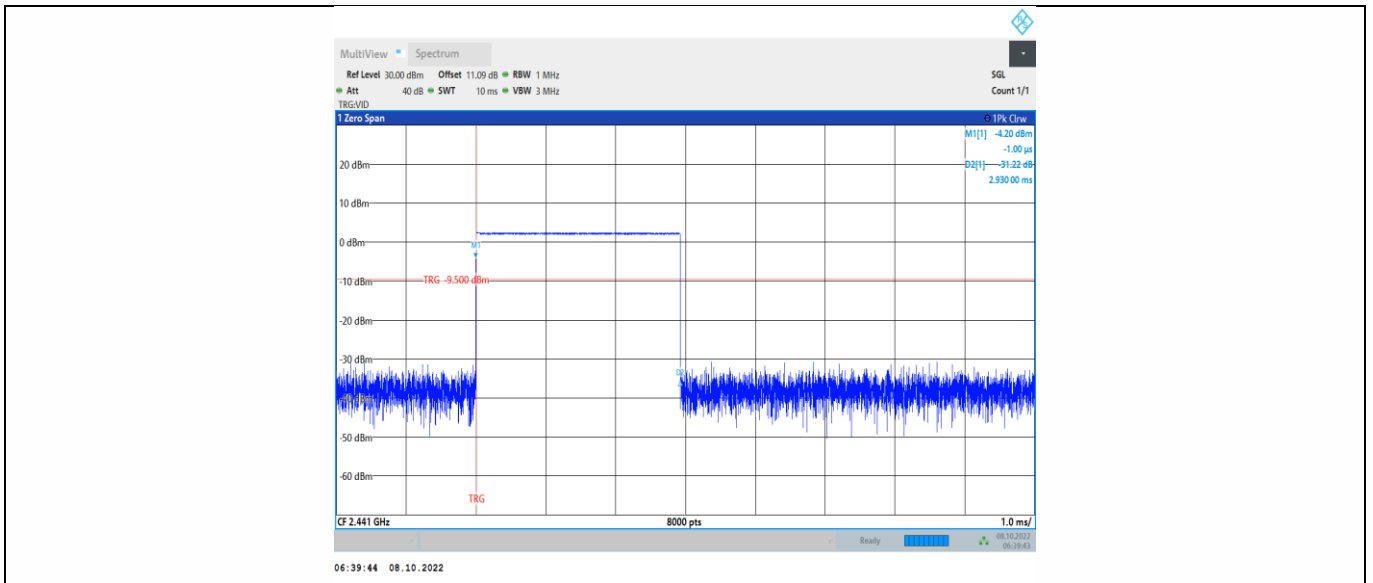

9.5 MAXIMUM PEAK CONDUCTED OUTPUT POWER

9.5.1 Applicable Standard

According to FCC Part 15.247(b)(1)

According to RSS-247.5.4

According to RSS-Gen 6.12

According to 558074 D01 15.247 MEAS GUIDANCE v05r02 Section 9

According to ANSI C63.10 Section 7.8.5

9.5.2 Conformance Limit

The max For frequency hopping systems operating in the 2400-2483.5 MHz band employing at least 75 non-overlapping hopping channels: 1 watt. For all other frequency hopping systems in the 2400-2483.5 MHz band: 0.125 watts.

9.5.3 Test Configuration

Test according to clause 7.1 radio frequency test setup 1

9.5.4 Test Procedure

As an alternative to a peak power measurement, compliance with the limit can be based on a measurement of the maximum conducted output power.

Use the following spectrum analyzer settings:

Set Span = approximately 5 times the 20 dB bandwidth, centered on a hopping channel (about 8MHz)

Set RBW > the 20 dB bandwidth of the emission being measured (about 3MHz)

Set VBW ≥ RBW

Set Sweep = auto

Set Detector function = peak

Set Trace = max hold

Allow the trace to stabilize. Use the marker-to-peak function to set the marker to the peak of the emission to determine the peak amplitude level.

Test Results

Temperature:	25° C
Relative Humidity:	45%
ATM Pressure:	1011 mbar
Test Engineer:	XXH

Note: N/A

Test Mode	Antenna	Frequency[MHz]	Conducted Peak Power[dBm]	Conducted Limit[dBm]	Verdict
DH5	Ant1	2402	3.02	≤20.97	PASS
		2441	2.67	≤20.97	PASS
		2480	2.3	≤20.97	PASS

DH5_Ant1_2402

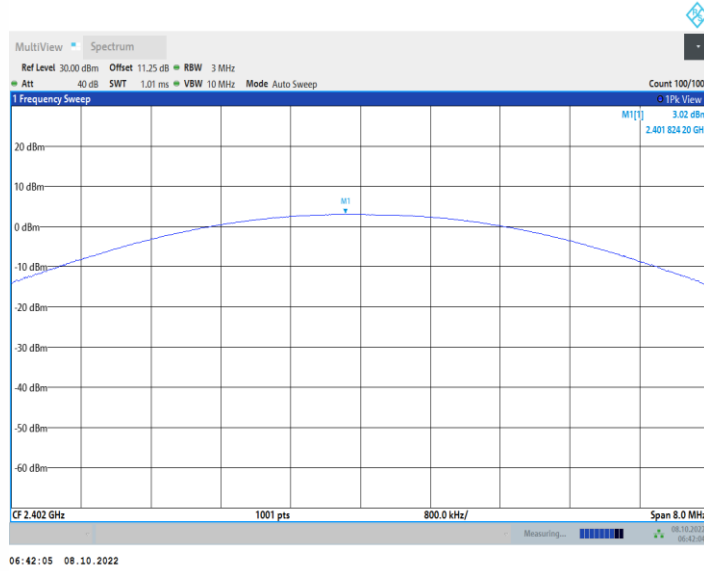

DH5_Ant1_2441

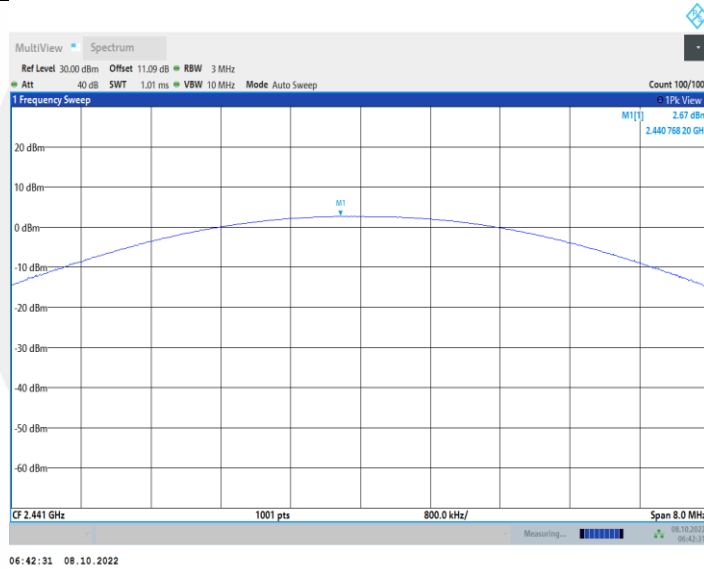

DH5_Ant1_2480

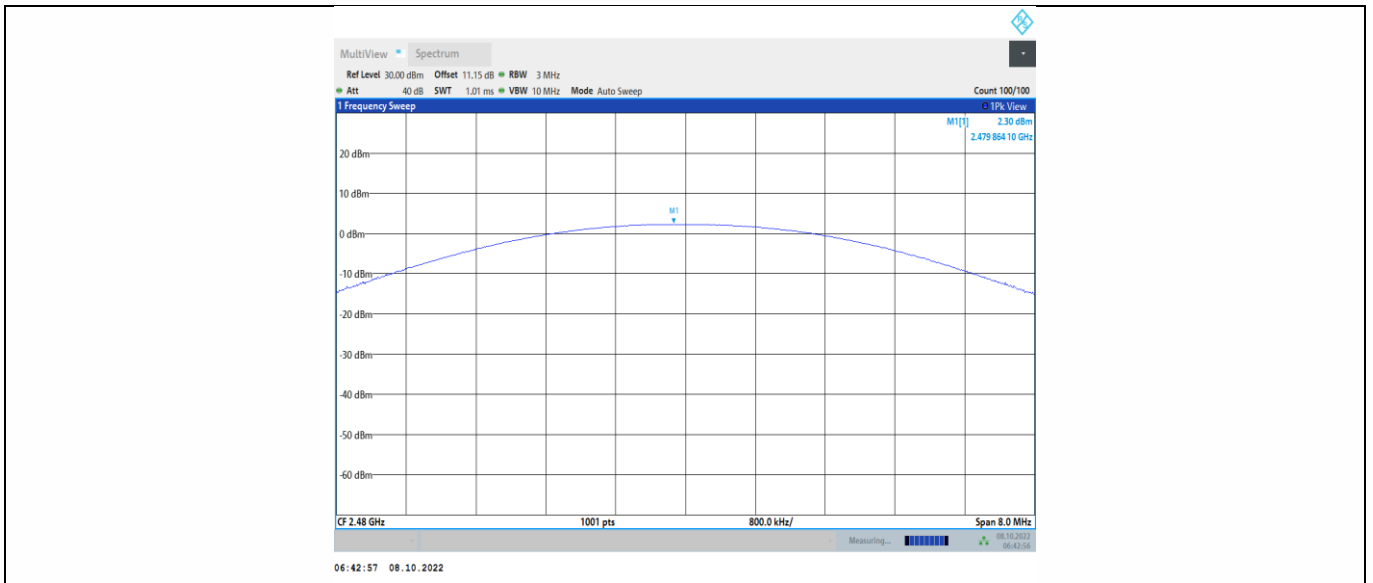

9.6 CONDUCTED SUPRIIOUS EMISSION

9.6.1 Applicable Standard

According to FCC Part 15.247(d)

According to IC RSS-247 5.5

According to 558074 D01 15.247 MEAS GUIDANCE v05r02 Section 9

According to ANSI C63.10 Section 7.8.8

9.6.2 Conformance Limit

In any 100 kHz bandwidth outside the frequency band in which the spread spectrum intentional radiator is operating, the radio frequency power that is produced by the intentional radiator shall be at least 20 dB below that in the 100 kHz bandwidth within the band that contains the highest level of the desired power, based on either an RF conducted, provided the transmitter demonstrates compliance with the peak conducted power limits.

9.6.3 Test Configuration

Test according to clause 7.1 radio frequency test setup 1

9.6.4 Test Procedure

The transmitter output (antenna port) was connected to the spectrum analyzer

■ Reference level measurement

Establish a reference level by using the following procedure:

Set instrument center frequency to DSS channel center frequency.

Set Span = approximately 5 times the 20 dB bandwidth, centered on a hopping channel.

Set the RBW = 100 kHz. Set the VBW $\geq 3 \times$ RBW.

Set Detector = peak. Set Sweep time = auto couple.

Set Trace mode = max hold. Allow trace to fully stabilize.

Use the peak marker function to determine the maximum Maximum conduceted level.

Note that the channel found to contain the maximum conduceted level can be used to establish the reference level.

■ Band-edge measurement

Use the following spectrum analyzer settings:

Span = wide enough to capture the peak level of the emission operating on the channel closest to the band-edge, as well as any modulation products which fall outside of the authorized band of operation

Set RBW $\geq 1\%$ of the span=100kHz Set VBW $\geq 3 \times$ RBW

Set Sweep = auto Set Detector function = peak Set Trace = max hold

Allow the trace to stabilize. Set the marker on the emission at the bandedge, or on the highest modulation product outside of the band, if this level is greater than that at the bandedge. Enable the marker-delta function, then use the marker-to-peak function to move the marker to the peak of the in-band emission. The marker-delta value now displayed must comply with the limit specified in this Section.

Now, using the same instrument settings, enable the hopping function of the EUT. Allow the trace to stabilize. Follow the same procedure listed above to determine if any spurious emissions caused by the hopping function also comply with the specified limit.

■ Emission level measurement

Use the following spectrum analyzer settings:

Span = wide enough to capture the peak level of the in-band emission and all spurious emissions (e.g., harmonics) from the lowest frequency generated in the EUT up through the 10th harmonic.(30MHz to 25GHz). Set RBW = 100 kHz Set VBW \geq RBW

Set Sweep = auto Set Detector function = peak Set Trace = max hold

Allow the trace to stabilize. Set the marker on the peak of any spurious emission recorded. The level displayed must comply with the limit specified in this Section.

9.6.5 Test Results

Temperature:	25° C
Relative Humidity:	45%
ATM Pressure:	1011 mbar
Test Engineer:	XXH

Note: N/A

Band edge measurements

TestMode	Antenna	ChName	Frequency[MHz]	RefLevel [dBm]	Result [dBm]	Limit [dBm]	Verdict
DH5	Ant1	Low	2402	2.62	-35.46	≤-17.38	PASS
		High	2480	1.86	-38.93	≤-18.14	PASS
		Low	Hop 2402	2.38	-49.33	≤-17.62	PASS
		High	Hop 2480	2.10	-48.93	≤-17.9	PASS

Conducted Spurious Emission

TestMode	Antenna	Frequency[MHz]	FreqRange [MHz]	RefLevel [dBm]	Result [dBm]	Limit [dBm]	Verdict
DH5	Ant1	2402	Reference	2.63	2.63	---	PASS
			30~1000	2.63	-56.57	≤-17.37	PASS
			1000~26500	2.63	-51.59	≤-17.37	PASS
		2441	Reference	2.29	2.29	---	PASS
			30~1000	2.29	-56.74	≤-17.71	PASS
			1000~26500	2.29	-51.57	≤-17.71	PASS
		2480	Reference	1.92	1.92	---	PASS
			30~1000	1.92	-55.62	≤-18.08	PASS
			1000~26500	1.92	-47.6	≤-18.08	PASS

Band edge measurements

DH5_Ant1_Low_2402

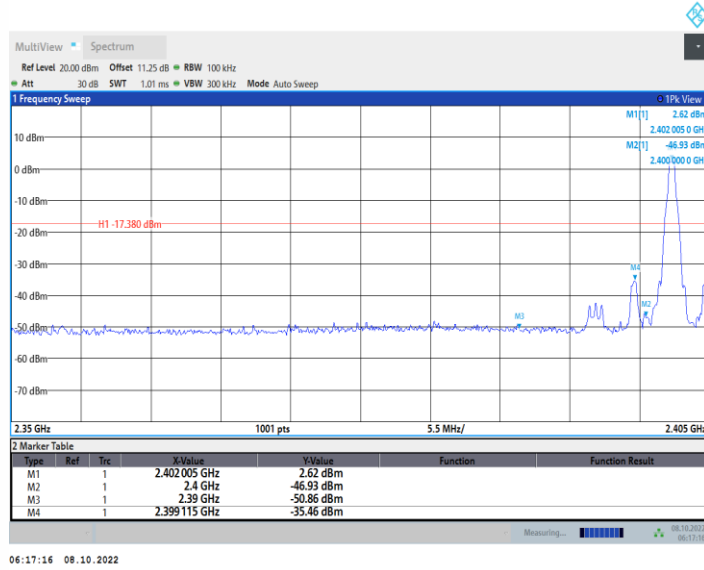

06:17:16 08.10.2022

DH5_Ant1_High_2480

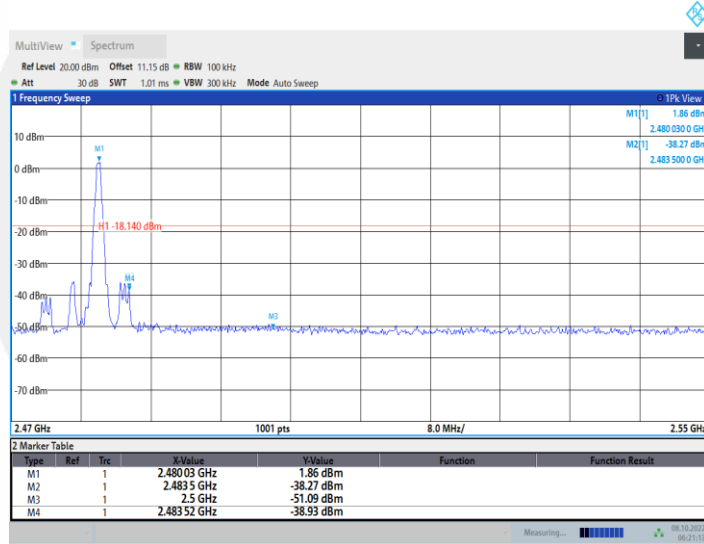

06:21:13 08.10.2022

DH5_Ant1_Low_Hop_2402

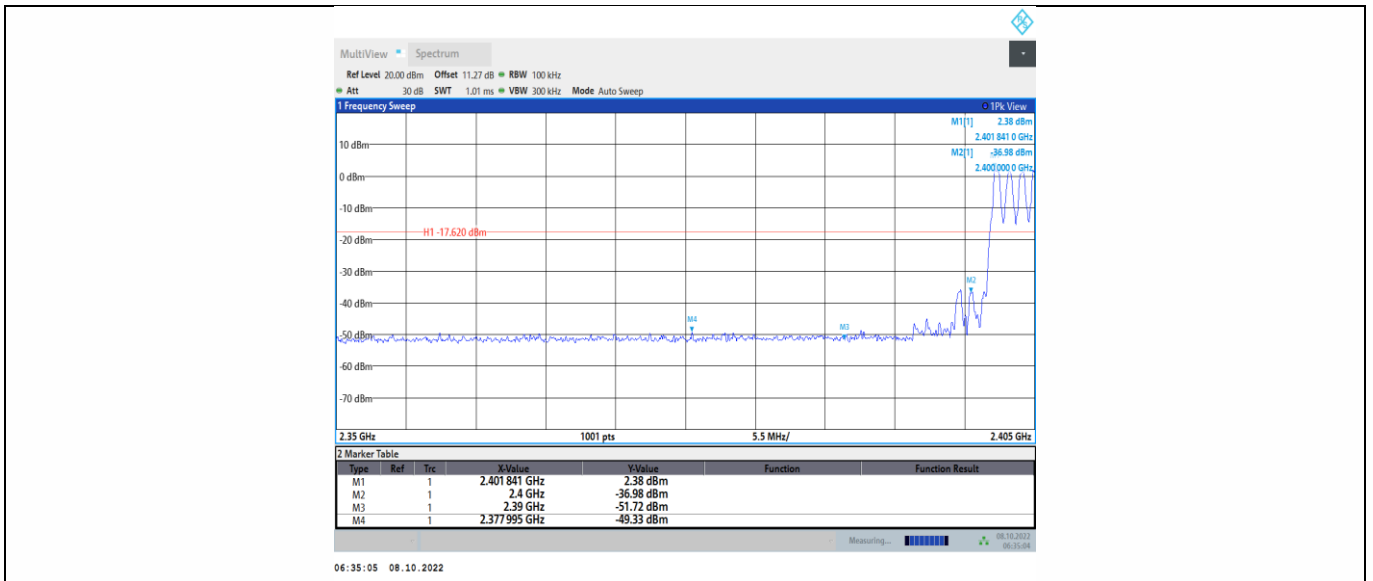

DH5_Ant1_High_Hop_2480

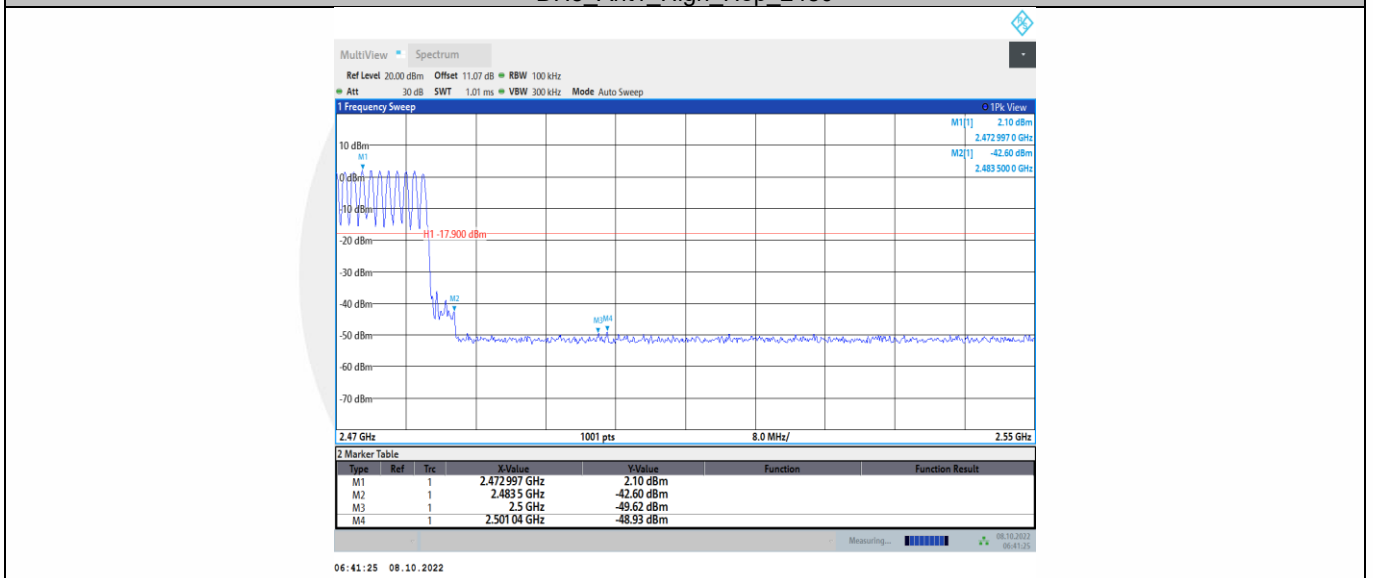

Conducted Spurious Emission

DH5_Ant1_2402_0~Reference

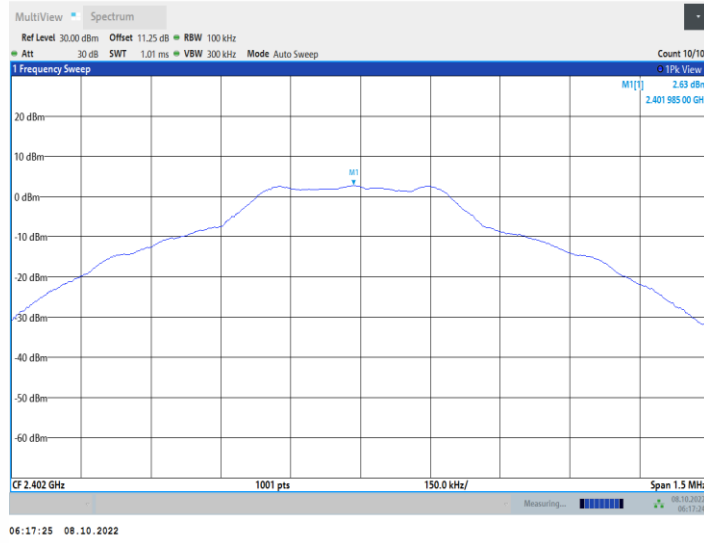

DH5_Ant1_2402_30~1000

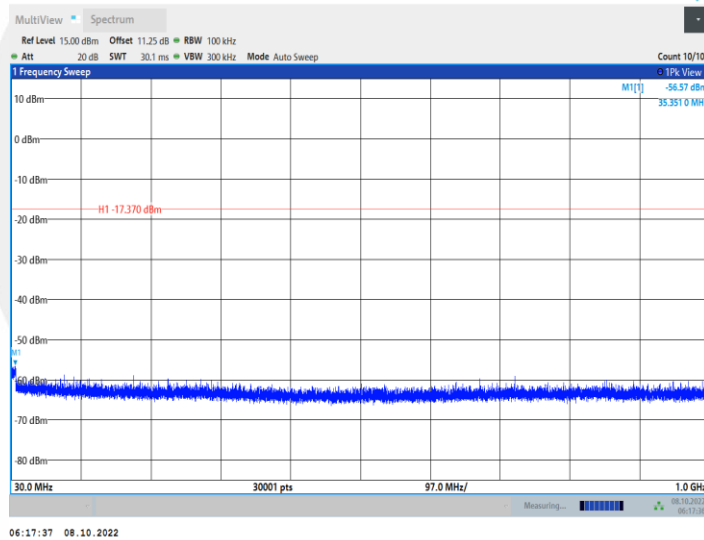

DH5_Ant1_2402_1000~26500

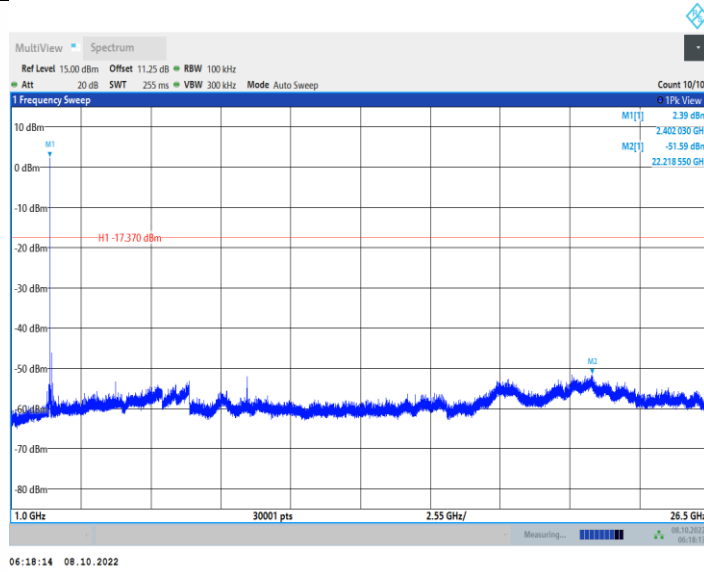

DH5_Ant1_2441_0~Reference

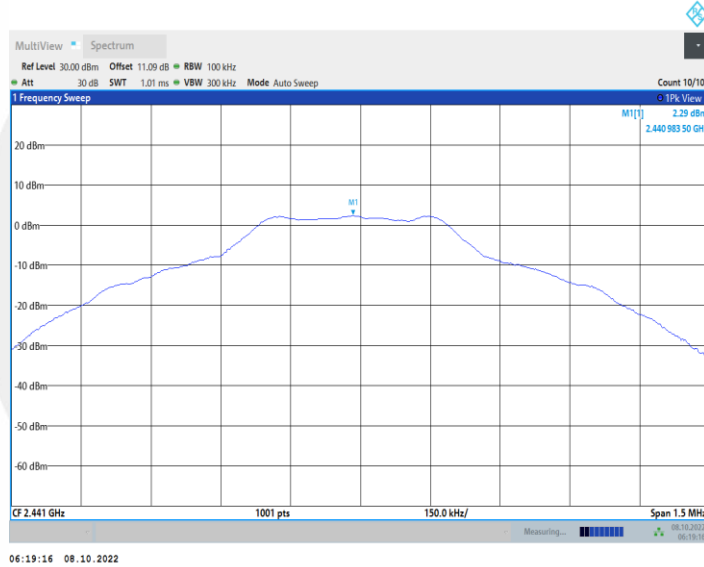

DH5_Ant1_2441_30~1000

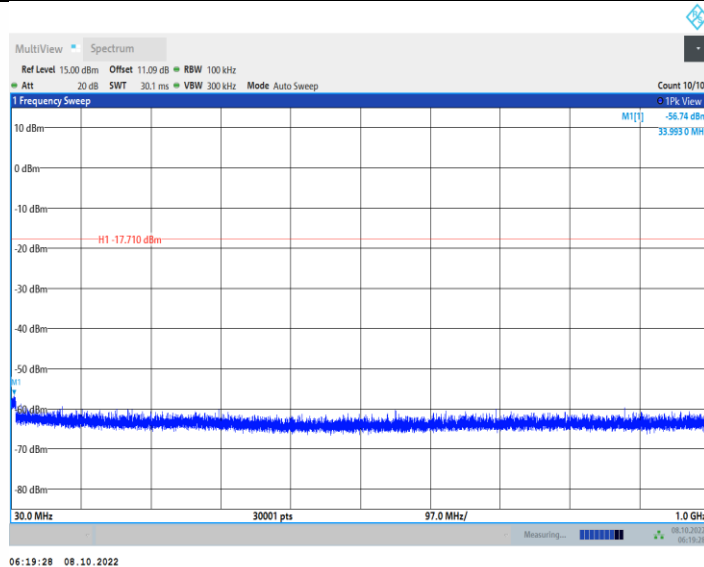

DH5_Ant1_2441_1000~26500

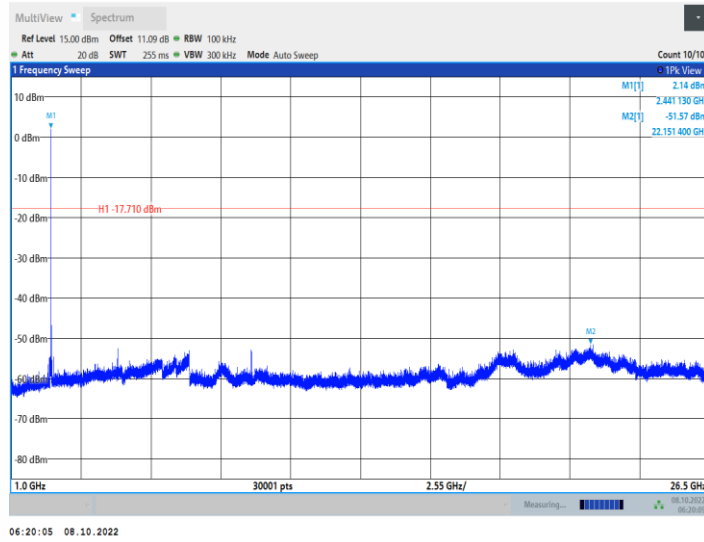

DH5_Ant1_2480_0~Reference

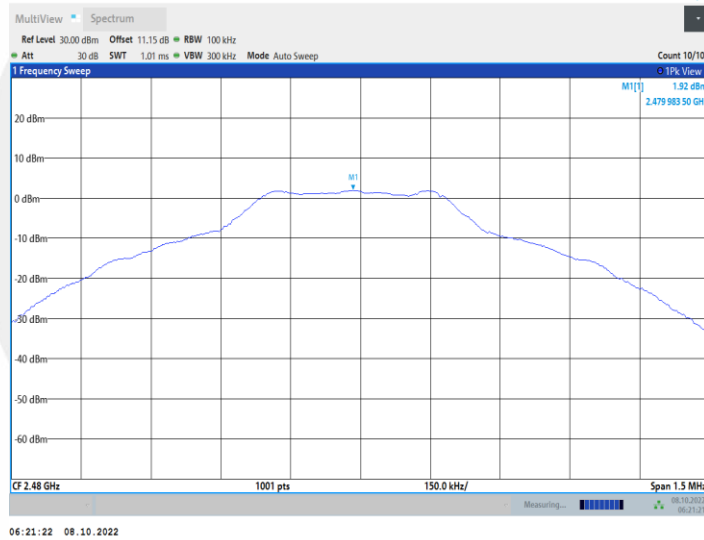

DH5_Ant1_2480_30~1000

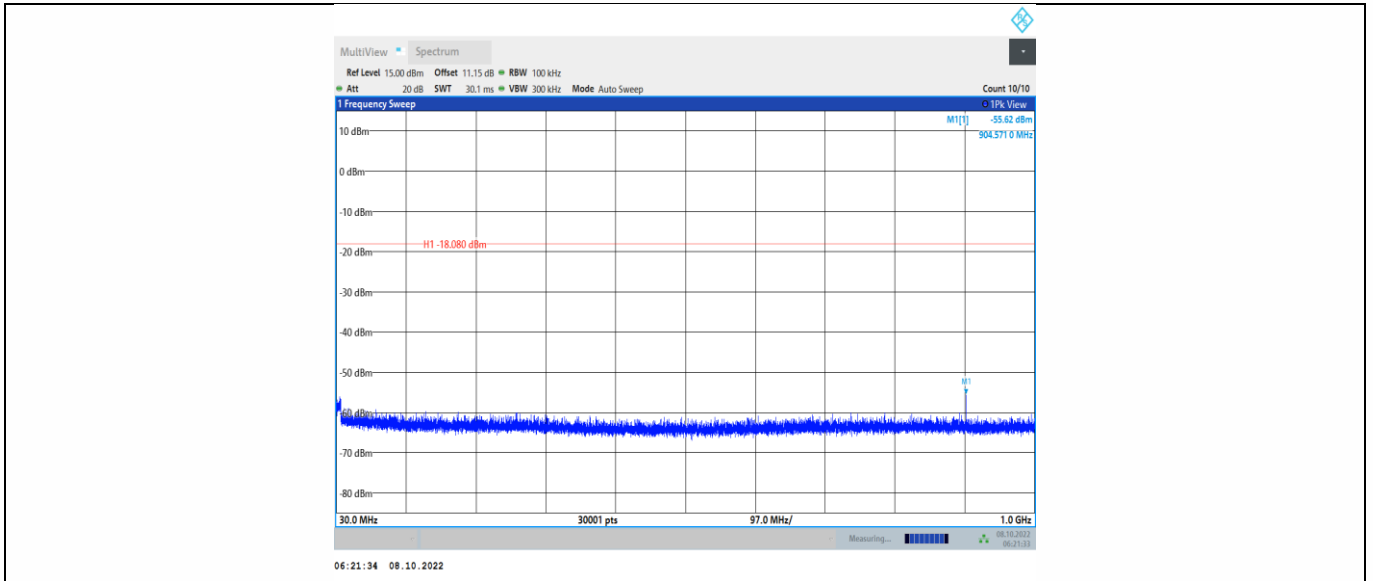

DH5_Ant1_2480_1000~26500

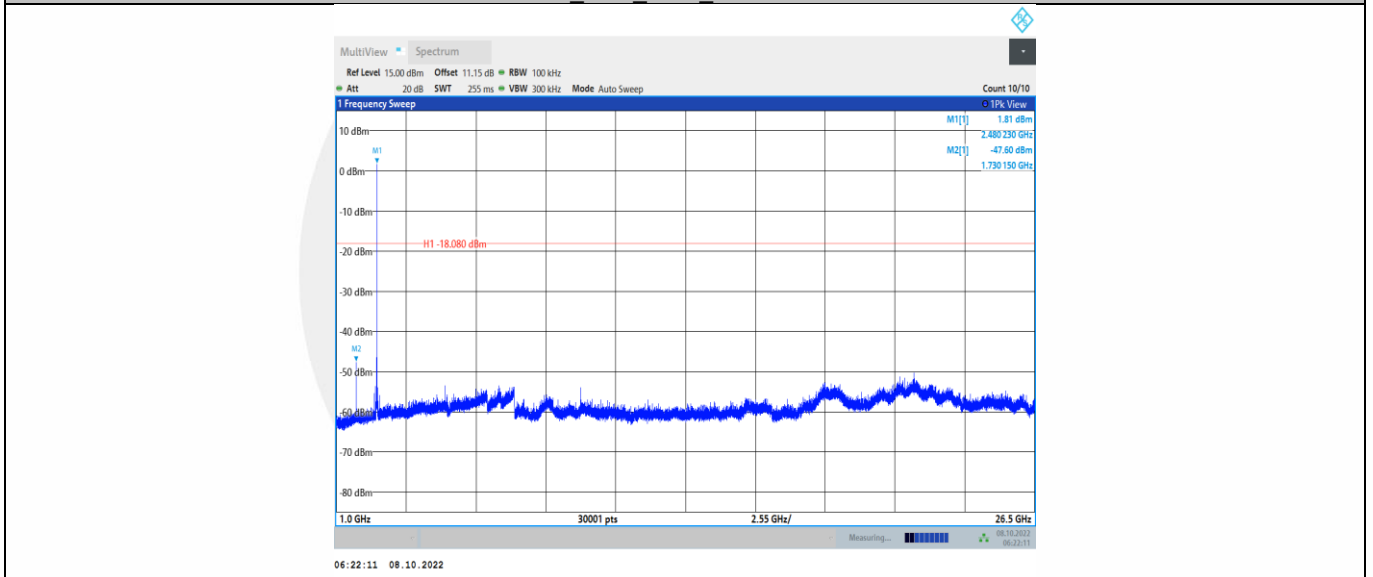

9.7 RADIATED SPURIOUS EMISSION

9.7.1 Applicable Standard

According to FCC Part 15.247(d), 15.205, 15.209

According to RSS-Gen and RSS-247

According to 558074 D01 15.247 MEAS GUIDANCE v05r02 Section 9

According to ANSI C63.10 Section 6.3, 6.4, 6.5, 6.6 and 6.10.5

9.7.2 Conformance Limit

According to FCC Part 15.247(d): radiated emissions which fall in the restricted bands, as defined in §15.205(a), must also comply with the radiated emission limits specified in §15.209(a) (see §15.205(c)).

According to FCC Part 15.205, Restricted bands

MHz	MHz	MHz	GHz
0.090-0.110	16.42-16.423	399.9-410	4.5-5.15
0.495-0.505	16.69475-16.69525	608-614	5.35-5.46
2.1735-2.1905	16.80425-16.80475	960-1240	7.25-7.75
4.125-4.128	25.5-25.67	1300-1427	8.025-8.5
4.17725-4.17775	37.5-38.25	1435-1626.5	9.0-9.2
4.20725-4.20775	73-74.6	1645.5-1646.5	9.3-9.5
6.215-6.218	74.8-75.2	1660-1710	10.6-12.7
6.26775-6.26825	123-138	2200-2300	14.47-14.5
8.291-8.294	149.9-150.05	2310-2390	15.35-16.2
8.362-8.366	156.52475-156.52525	2483.5-2500	17.7-21.4
8.37625-8.38675	156.7-156.9	2690-2900	22.01-23.12
8.41425-8.41475	162.0125-167.17	3260-3267	23.6-24.0
12.29-12.293	167.72-173.2	3332-3339	31.2-31.8
12.51975-12.52025	240-285	3345.8-3358	36.43-36.5
12.57675-12.57725	322-335.4	3600-4400	Above 38.6
13.36-13.41			

According to FCC Part 15.205, the level of any transmitter spurious emission in Restricted bands shall not exceed the level of the emission specified in the following table

Restricted Frequency(MHz)	Field Strength ($\mu\text{V}/\text{m}$)	Field Strength ($\text{dB}\mu\text{V}/\text{m}$)	Measurement Distance
0.009-0.490	2400/F(KHz)	20 log (uV/m)	300
0.490-1.705	24000/F(KHz)	20 log (uV/m)	30
1.705-30	30	29.5	30
30-88	100	40	3
88-216	150	43.5	3
216-960	200	46	3
Above 960	500	54	3

9.7.3 Test Configuration

Test according to clause 7.2 radio frequency test setup 2

9.7.4 Test Procedure

This test is required for any spurious emission that falls in a Restricted Band, as defined in Section 15.205. It must be performed with the highest gain of each type of antenna proposed for use with the EUT. Use the following spectrum analyzer settings:

For Above 1GHz:

The EUT was placed on a turn table which is 1.5m above ground plane.

Maximum procedure was performed on the highest emissions to ensure EUT compliance.

Span = wide enough to fully capture the emission being measured

RBW = 1 MHz

VBW ≥ RBW

Sweep = auto

Detector function = peak

Trace = max hold

For average measurements the resolution bandwidth of spectrum analyzer is 1 MHz with the video bandwidth is ≥ 1/T with peak detector.

For Below 1GHz:

The EUT was placed on a turn table which is 0.8m above ground plane.

Maximum procedure was performed on the highest emissions to ensure EUT compliance.

Span = wide enough to fully capture the emission being measured

RBW = 100 kHz for

VBW ≥ RBW

Sweep = auto

Detector function = peak

Trace = max hold

For Below 30MHz:

The EUT was placed on a turn table which is 0.8m above ground plane.

Maximum procedure was performed on the highest emissions to ensure EUT compliance.

Span = wide enough to fully capture the emission being measured

RBW = 9kHz

VBW ≥ RBW

Sweep = auto

Detector function = peak

Trace = max hold

For Below 150KHz:

The EUT was placed on a turn table which is 0.8m above ground plane.

Maximum procedure was performed on the highest emissions to ensure EUT compliance.

Span = wide enough to fully capture the emission being measured

RBW = 200Hz

VBW ≥ RBW

Sweep = auto

Detector function = peak

Trace = max hold

Follow the guidelines in ANSI C63.10 with respect to maximizing the emission by rotating the EUT, measuring the emission while the EUT is situated in three orthogonal planes (if appropriate), adjusting the measurement antenna height and polarization, etc. A pre-amp and a high pass filter are required for this test, in order to provide the measuring system with sufficient sensitivity. Allow the trace to stabilize. The peak reading of the emission, after being corrected by the antenna factor, cable loss, pre-amp gain, etc., is the peak field strength, which must comply with the limit. Submit this data.

9.7.5 Test Results

Temperature:	25 °C
Relative Humidity:	54%
ATM Pressure:	1011 mbar
Test Engineer:	XXH

■ Spurious Emission below 30MHz (9KHz to 30MHz)

For Spurious Emission below 30MHz (9KHz to 30MHz), was pre-scanned and the result which was 20dB lower than the limit line per 15.31(o) was not reported.

■ Spurious Emission Above 1GHz (1GHz to 25GHz)

Bluetooth (GFSK) mode have been tested, and the worst result was report as below:

Test mode: GFSK Frequency: Channel 0: 2402MHz

Freq. (MHz)	Ant.Pol.	Reading Level (dBuV/m)	Correct Factor (dB/m)	Corrected Reading (dBuV/m)	Limit 3m (dBuV/m)	Margin (dB)	Remark
7206.555	V	59.79	0.12	59.91	74.00	-14.09	peak
7206.555	V	51.07	0.12	51.19	54.00	-2.81	AVG
11291.04	V	51.01	6.12	57.13	74.00	-16.87	peak
11291.04	V	34.11	6.12	40.23	54.00	-13.77	AVG
17839.43	V	51.31	13.68	64.99	74.00	-9.01	peak
17839.43	V	32.56	13.68	46.24	54.00	-7.76	AVG
7205.514	H	57.40	0.12	57.52	74.00	-16.48	peak
7205.514	H	48.20	0.12	48.32	54.00	-5.68	AVG
9607.874	H	52.90	4.12	57.02	74.00	-16.98	peak
9607.874	H	43.01	4.12	47.13	54.00	-6.87	AVG
17888.48	H	50.68	13.94	64.62	74.00	-9.38	peak
17888.48	H	32.41	13.94	46.35	74.00	-27.65	peak

Note: (1) PeaK RBW = 1 MHz, VBW $\geq 3 \times$ RBW, Detector = Peak;
 (2) Avg RBW = 1 MHz, VBW = $1/T_{on}$, Detector = Peak, where: T_{on} is transmit duration;
 (3) Corrected Reading = Reading Level + Correct Factor;
 (4) Correct Factor = Ant_F + Cab_L - Preamp;
 (5) Margin = Limit - Corrected Reading;

Test mode: GFSK Frequency: Channel 39: 2441MHz

Freq. (MHz)	Ant.Pol.	Reading Level (dBuV/m)	Correct Factor (dB/m)	Corrected Reading (dBuV/m)	Limit 3m (dBuV/m)	Margin (dB)	Remark
7263.015	V	58.75	0.25	59.00	74.00	-15.00	peak
7263.015	V	50.57	0.25	50.82	54.00	-3.18	AVG
11486.90	V	50.49	6.18	56.67	74.00	-17.33	peak
11486.90	V	32.15	6.18	38.33	54.00	-15.67	AVG
17992.19	V	50.23	14.49	64.72	74.00	-9.28	peak
17992.19	V	32.25	14.49	46.74	54.00	-7.26	AVG
7261.965	H	53.21	0.24	53.45	74.00	-20.55	peak
7261.965	H	44.90	0.24	45.14	54.00	-8.86	AVG
13646.37	H	50.18	7.40	57.58	74.00	-16.42	peak
13646.37	H	32.63	7.40	40.03	54.00	-13.97	AVG
17942.86	H	50.55	14.23	64.78	74.00	-9.22	peak
17942.86	H	32.39	14.23	46.62	54.00	-7.38	AVG

Note: (1) PeaK RBW = 1 MHz, VBW $\geq 3 \times$ RBW, Detector = Peak;
 (2) Avg RBW = 1 MHz, VBW = $1/T_{on}$, Detector = Peak, where: T_{on} is transmit duration;
 (3) Corrected Reading = Reading Level + Correct Factor;
 (4) Correct Factor = Ant_F + Cab_L - Preamp;
 (5) Margin = Limit - Corrected Reading;

Test mode: GFSK Frequency: Channel 78: 2480MHz

Freq. (MHz)	Ant.Pol.	Reading Level (dBuV/m)	Correct Factor (dB/m)	Corrected Reading (dBuV/m)	Limit 3m (dBuV/m)	Margin (dB)	Remark
7440.437	V	52.44	0.69	53.13	74.00	-20.87	peak
7440.437	V	44.56	0.69	45.25	54.00	-8.75	AVG
12487.64	V	50.71	6.23	56.94	74.00	-17.06	peak
12487.64	V	32.76	6.23	38.99	54.00	-15.01	AVG
17906.59	V	50.59	14.04	64.63	74.00	-9.37	peak
17906.59	V	32.31	14.04	46.35	54.00	-7.65	AVG
5634.317	H	50.19	-5.57	44.62	74.00	-29.38	peak
5634.317	H	32.12	-5.57	26.55	54.00	-27.45	AVG
9799.997	H	50.54	4.68	55.22	74.00	-18.78	peak
9799.997	H	33.68	4.68	38.36	54.00	-15.64	AVG
17911.77	H	51.49	14.07	65.56	74.00	-8.44	peak
17911.77	H	34.17	14.07	48.24	54.00	-5.76	AVG

Note:

- (1) Peak RBW = 1 MHz, VBW $\geq 3 \times$ RBW, Detector = Peak;
- (2) Avg RBW = 1 MHz, VBW = $1/T_{on}$, Detector = Peak, where: T_{on} is transmit duration;
- (3) Corrected Reading = Reading Level + Correct Factor;
- (4) Correct Factor = Ant_F + Cab_L - Preamp;
- (5) Margin = Limit - Corrected Reading;

■ Spurious Emission in Restricted Band 2310-2390MHz and 2483.5-2500MHz Bluetooth (GFSK) mode have been tested, and the worst result was report as below:

Test mode: GFSK Frequency: Channel 0: 2402MHz

Freq. (MHz)	Ant.Pol.	Reading Level (dBuV/m)	Correct Factor (dB/m)	Corrected Reading (dBuV/m)	Limit 3m (dBuV/m)	Margin (dB)	Remark
2386.932	V	43.70	6.00	49.70	74.00	-24.30	peak
2386.932	V	25.64	6.00	31.64	54.00	-22.36	AVG
2385.716	H	43.81	6.00	49.81	74.00	-24.19	peak
2385.716	H	25.26	6.00	31.26	54.00	-22.74	AVG

Note: (1) Peak RBW = 1 MHz, VBW $\geq 3 \times$ RBW, Detector = Peak;
 (2) Avg RBW = 1 MHz, VBW = $1/T_{on}$, Detector = Peak, where: T_{on} is transmit duration;
 (3) Corrected Reading = Reading Level + Correct Factor;
 (4) Correct Factor = Ant_F + Cab_L - Preamp;
 (5) Margin = Limit - Corrected Reading;

Test mode: GFSK Frequency: Channel 78: 2480MHz

Freq. (MHz)	Ant.Pol.	Reading Level (dBuV/m)	Correct Factor (dB/m)	Corrected Reading (dBuV/m)	Limit 3m (dBuV/m)	Margin (dB)	Remark
2483.520	V	50.82	6.24	57.06	74.00	-16.94	peak
2483.52	V	33.99	6.24	40.23	54.00	-13.77	AVG
2483.502	H	51.01	6.24	57.25	74.00	-16.75	peak
2483.502	H	34.00	6.24	40.24	54.00	-13.76	AVG

Note: (1) Peak RBW = 1 MHz, VBW $\geq 3 \times$ RBW, Detector = Peak;
 (2) Avg RBW = 1 MHz, VBW = $1/T_{on}$, Detector = Peak, where: T_{on} is transmit duration;
 (3) Corrected Reading = Reading Level + Correct Factor;
 (4) Correct Factor = Ant_F + Cab_L - Preamp;
 (5) Margin = Limit - Corrected Reading;

Test mode: GFSK Frequency: Hopping

Freq. (MHz)	Ant.Pol.	Reading Level (dBuV/m)	Correct Factor (dB/m)	Corrected Reading (dBuV/m)	Limit 3m (dBuV/m)	Margin (dB)	Remark
2400.000	V	43.11	6.05	49.16	74.00	-24.84	peak
2400.000	V	25.20	6.05	31.25	54.00	-22.75	AVG
2483.500	V	43.23	6.24	49.47	74.00	-24.53	peak
2483.500	V	25.31	6.24	31.55	54.00	-22.45	AVG
2400.000	H	46.52	6.05	52.57	74.00	-21.43	peak
2400.000	H	28.07	6.05	34.12	54.00	-19.88	AVG
2483.500	H	48.91	6.24	55.15	74.00	-18.85	peak
2483.500	H	30.99	6.24	37.23	54.00	-16.77	AVG

Note: (1) Peak RBW = 1 MHz, VBW $\geq 3 \times$ RBW, Detector = Peak;
 (2) Avg RBW = 1 MHz, VBW = $1/T_{on}$, Detector = Peak, where: T_{on} is transmit duration;
 (3) Corrected Reading = Reading Level + Correct Factor;
 (4) Correct Factor = Ant_F + Cab_L - Preamp;
 (5) Margin = Limit - Corrected Reading;

Test Model Spurious Emission in Restricted Band 2310-2390MHz
 Channel 0: 2402MHz GFSK V

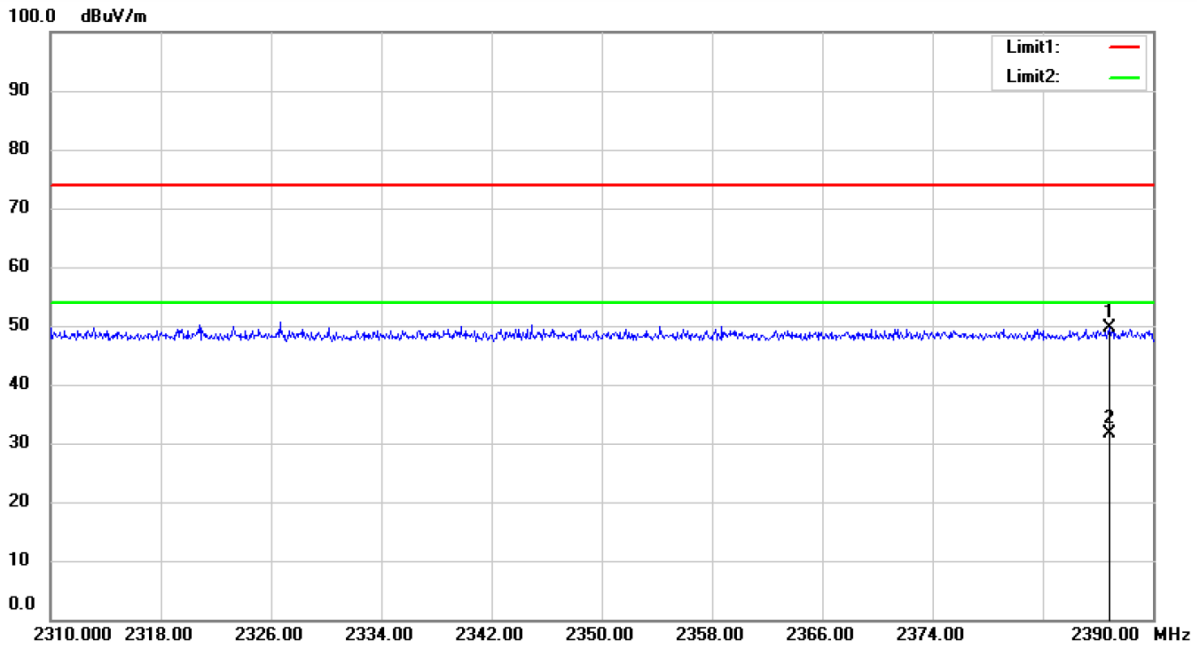

Site 3m Chamber #1 Polarization: **Vertical** Temperature: 28.1 C

Test Model Spurious Emission in Restricted Band 2310-2390MHz
 Channel 0: 2402MHz GFSK H

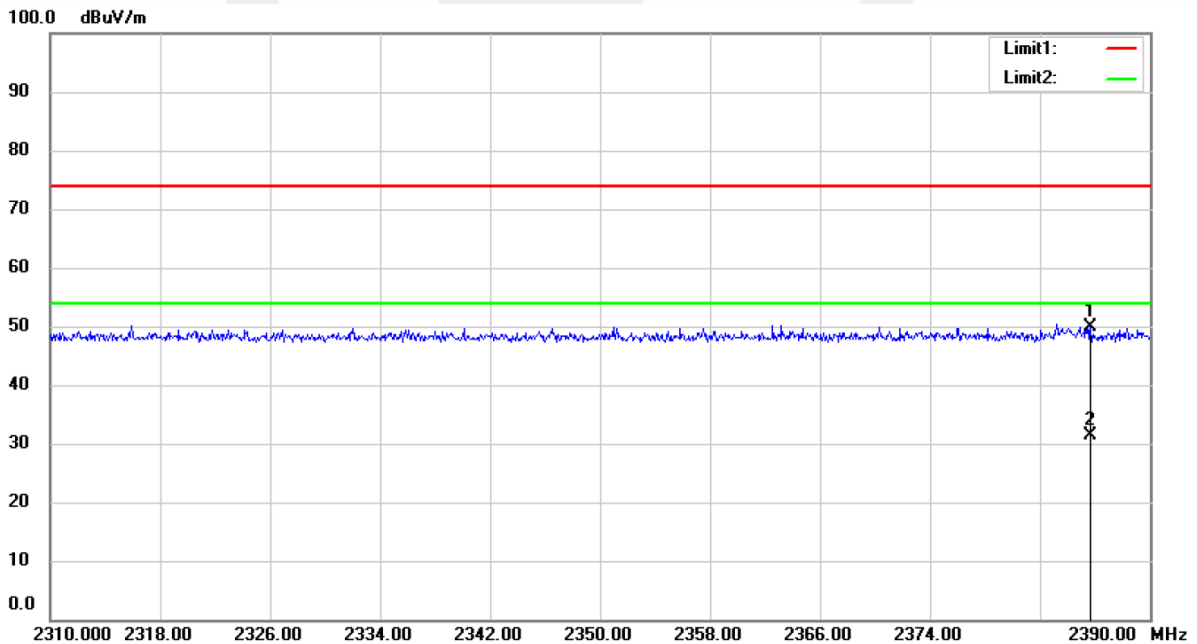

Site 3m Chamber #1 Polarization: **Horizontal** Temperature: 28.1 C

Test Model Spurious Emission in Restricted Band 2310-2390MHz and 2400-2483.5MHz Hopping GFSK V

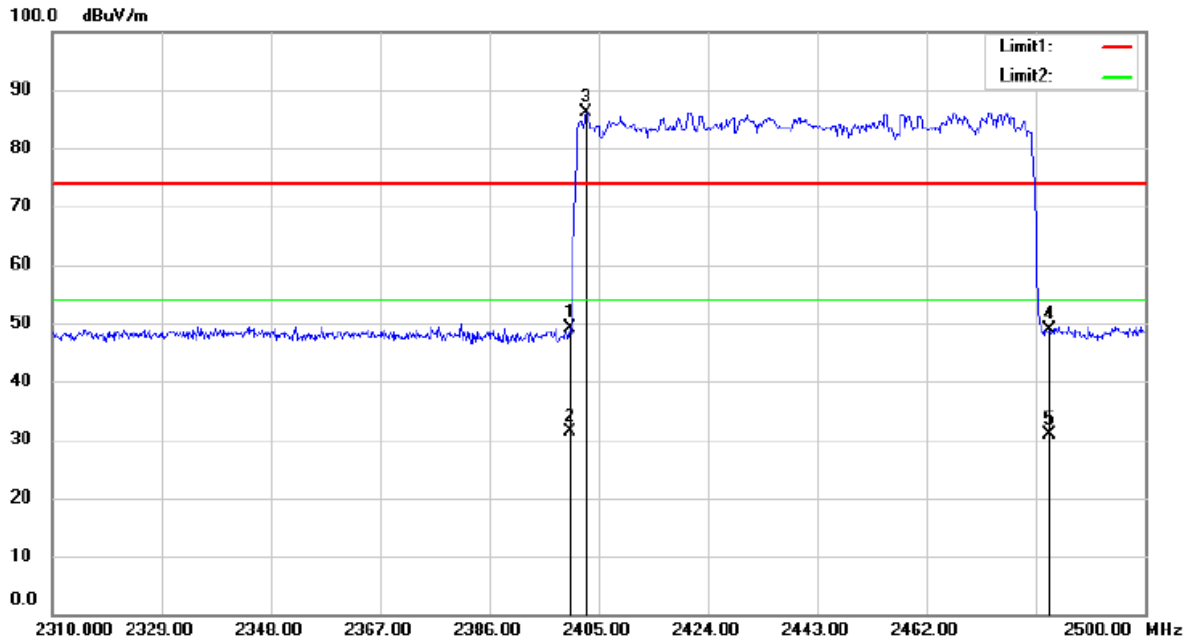

Site 3m Chamber #1

Polarization: **Vertical**

Temperature: 28.1 C

Test Model Spurious Emission in Restricted Band 2310-2390MHz and 2400-2483.5MHz Hopping GFSK H

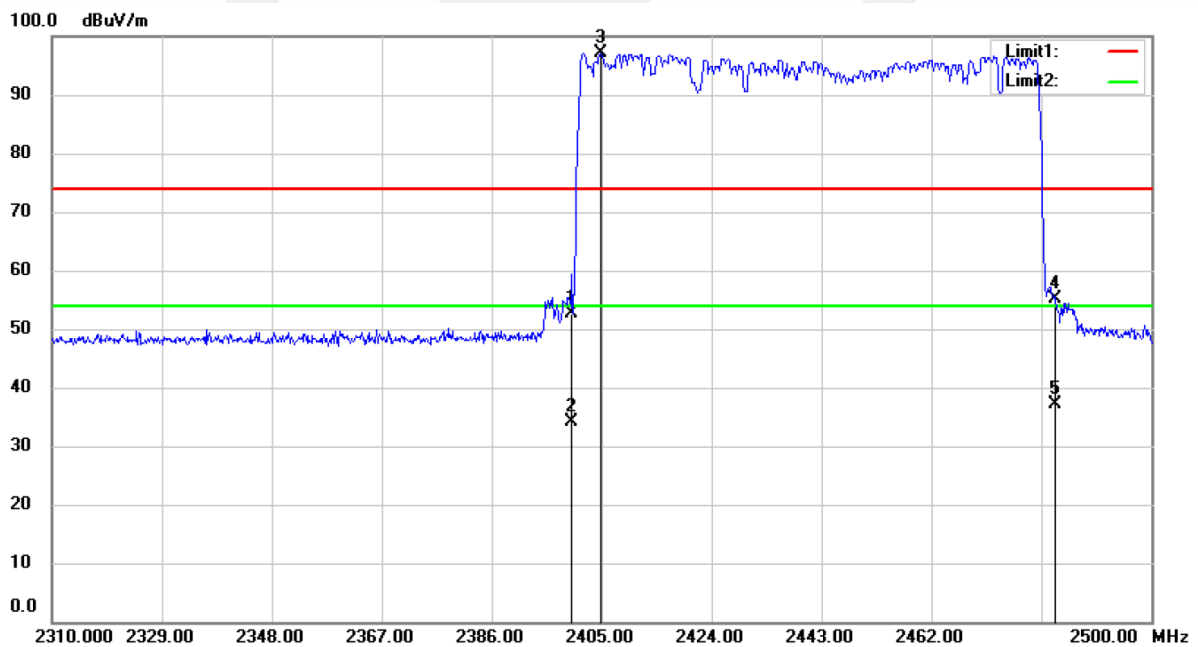

Site 3m Chamber #1

Polarization: **Horizontal**

Temperature: 28.1 C

■ Spurious Emission below 1GHz (30MHz to 1GHz)

Bluetooth (GFSK) mode have been tested, and the worst result was report as below:

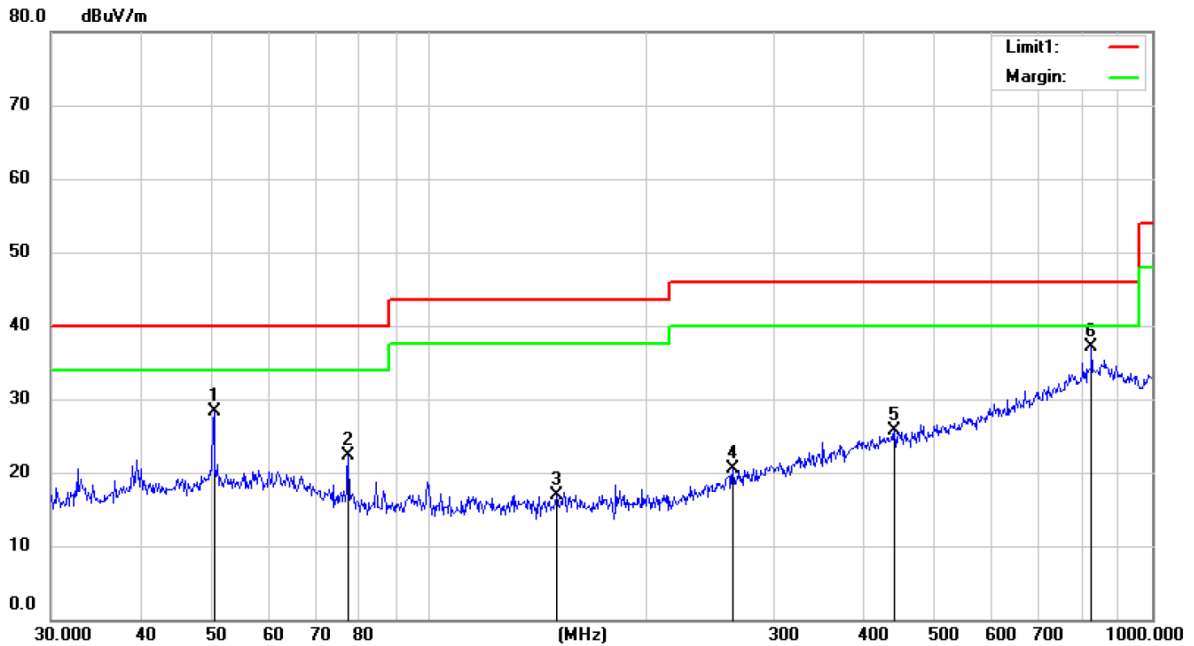

Site 3m Chamber #1

Polarization: **Vertical**

Temperature: 28.1 C

Limit: (RE)FCC PART 15 CLASS B

Power: DC 1.5V

Humidity: 43 %

Mode: BT 2402

Note:

No.	Mk.	Freq.	Reading Level	Correct Factor	Measurement	Limit	Over	Antenna Height	Table Degree	
		MHz	dBuV	dB	dBuV/m	dBuV/m	dB	cm	degree	Comment
1		50.4310	35.77	-7.49	28.28	40.00	-11.72	QP		
2		77.4230	32.30	-10.05	22.25	40.00	-17.75	QP		
3		150.1424	26.63	-9.69	16.94	43.50	-26.56	QP		
4		263.3570	27.14	-6.60	20.54	46.00	-25.46	QP		
5		440.3893	27.66	-2.00	25.66	46.00	-20.34	QP		
6	*	826.0440	30.94	6.15	37.09	46.00	-8.91	QP		

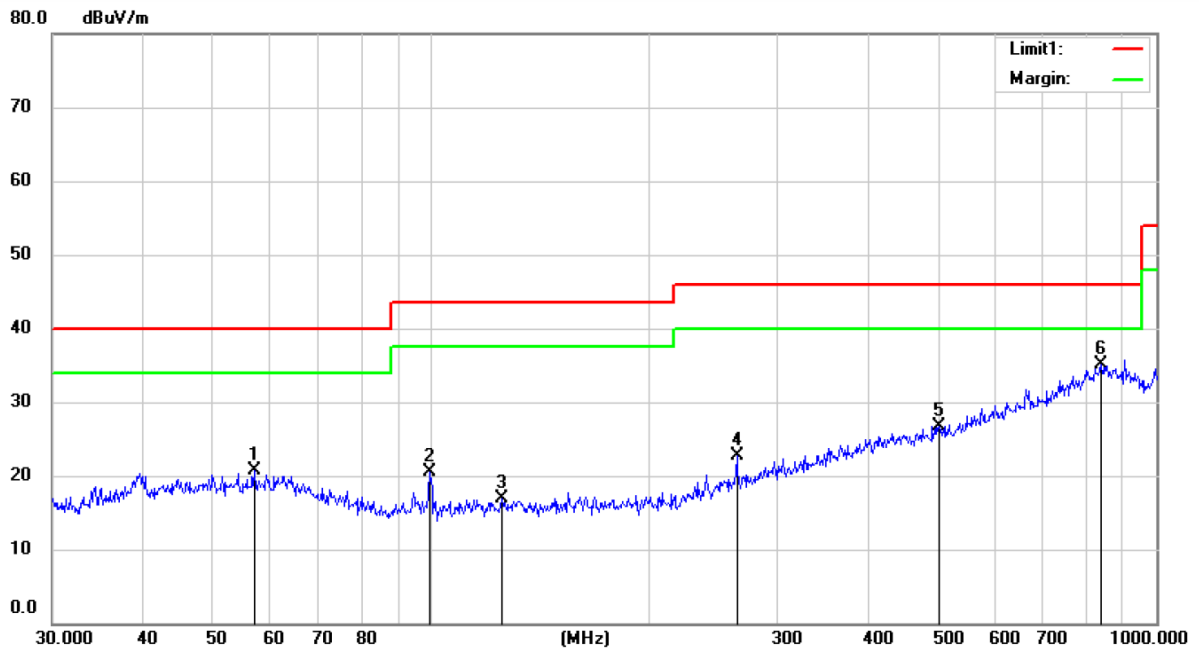

Site 3m Chamber #1

Polarization: *Horizontal*

Temperature: 28.1 C

Limit: (RE)FCC PART 15 CLASS B

Power: DC 1.5V

Humidity: 43 %

Mode:BT 2402

Note:

No.	Mk.	Freq.	Reading Level	Correct Factor	Measurement	Limit	Over	Antenna Height	Table Degree	
		MHz	dBuV	dB	dBuV/m	dBuV/m	dB	cm	degree	Comment
1		57.1163	28.19	-7.52	20.67	40.00	-19.33	QP		
2		99.8340	30.89	-10.42	20.47	43.50	-23.03	QP		
3		125.1162	27.00	-10.05	16.95	43.50	-26.55	QP		
4		264.0504	29.19	-6.56	22.63	46.00	-23.37	QP		
5		502.0585	27.77	-1.03	26.74	46.00	-19.26	QP		
6	*	839.5497	28.51	6.52	35.03	46.00	-10.97	QP		

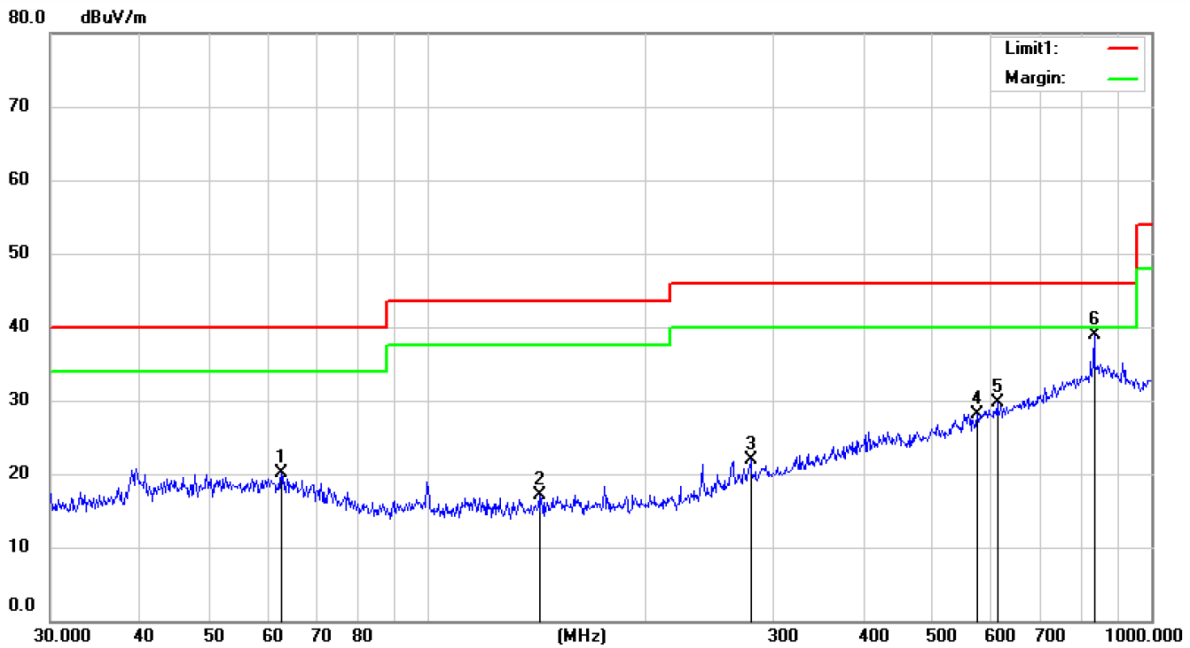

Site 3m Chamber #1 Polarization: **Horizontal** Temperature: 28.1 C
 Limit: (RE)FCC PART 15 CLASS B Power: DC 1.5V Humidity: 43 %
 Mode:BT 2441
 Note:

No.	Mk.	Freq.	Reading Level	Correct Factor	Measurement	Limit	Over	Antenna Height	Table Degree	
		MHz	dBuV	dB	dBuV/m	dBuV/m	dB	cm	degree	Comment
1		62.8157	27.59	-7.50	20.09	40.00	-19.91	QP		
2		142.5742	27.31	-10.20	17.11	43.50	-26.39	QP		
3		279.9011	27.79	-5.81	21.98	46.00	-24.02	QP		
4		574.8778	27.81	0.34	28.15	46.00	-17.85	QP		
5		612.8696	28.64	1.06	29.70	46.00	-16.30	QP		
6	*	834.0480	32.50	6.43	38.93	46.00	-7.07	QP		

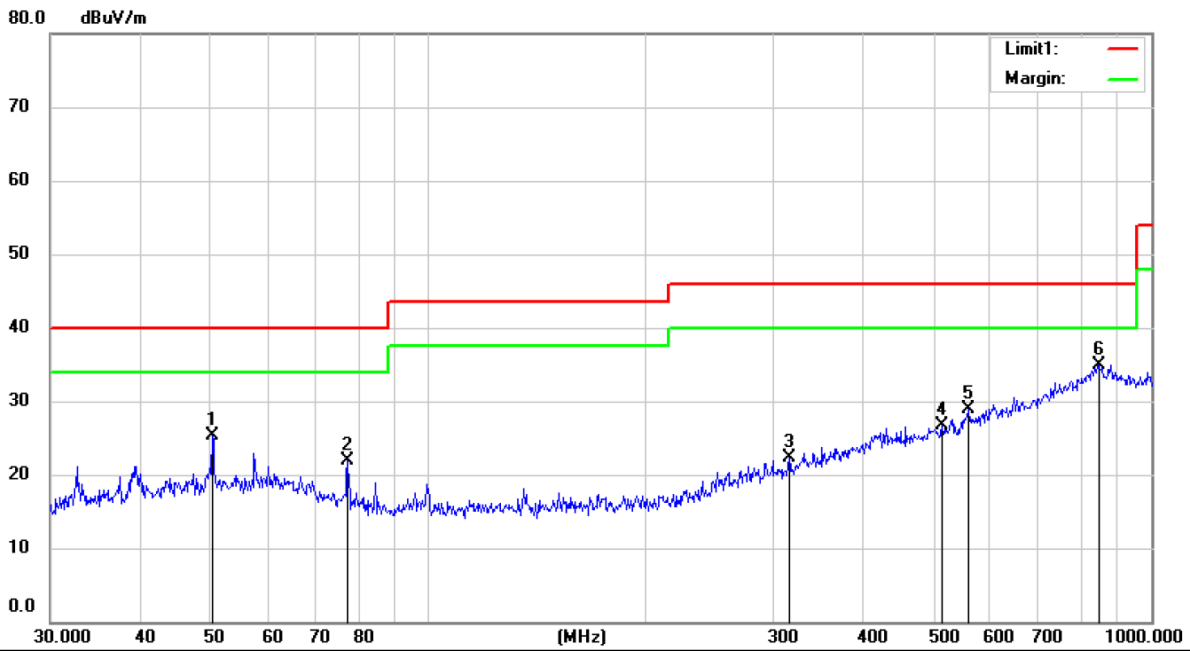

Site 3m Chamber #1

Polarization: **Vertical**

Temperature: 28.1 C

Limit: (RE)FCC PART 15 CLASS B

Power: DC 1.5V

Humidity: 43 %

Mode: BT 2441

Note:

No.	Mk.	Freq.	Reading Level	Correct Factor	Measurement	Limit	Over	Antenna Height	Table Degree	
		MHz	dBuV	dB	dBuV/m	dBuV/m	dB	cm	degree	Comment
1		50.3206	32.88	-7.49	25.39	40.00	-14.61	QP		
2		77.4570	31.98	-10.05	21.93	40.00	-18.07	QP		
3		315.6191	27.25	-4.93	22.32	46.00	-23.68	QP		
4		515.2115	27.96	-1.23	26.73	46.00	-19.27	QP		
5		560.2015	28.78	0.05	28.83	46.00	-17.17	QP		
6	*	847.6847	28.29	6.69	34.98	46.00	-11.02	QP		

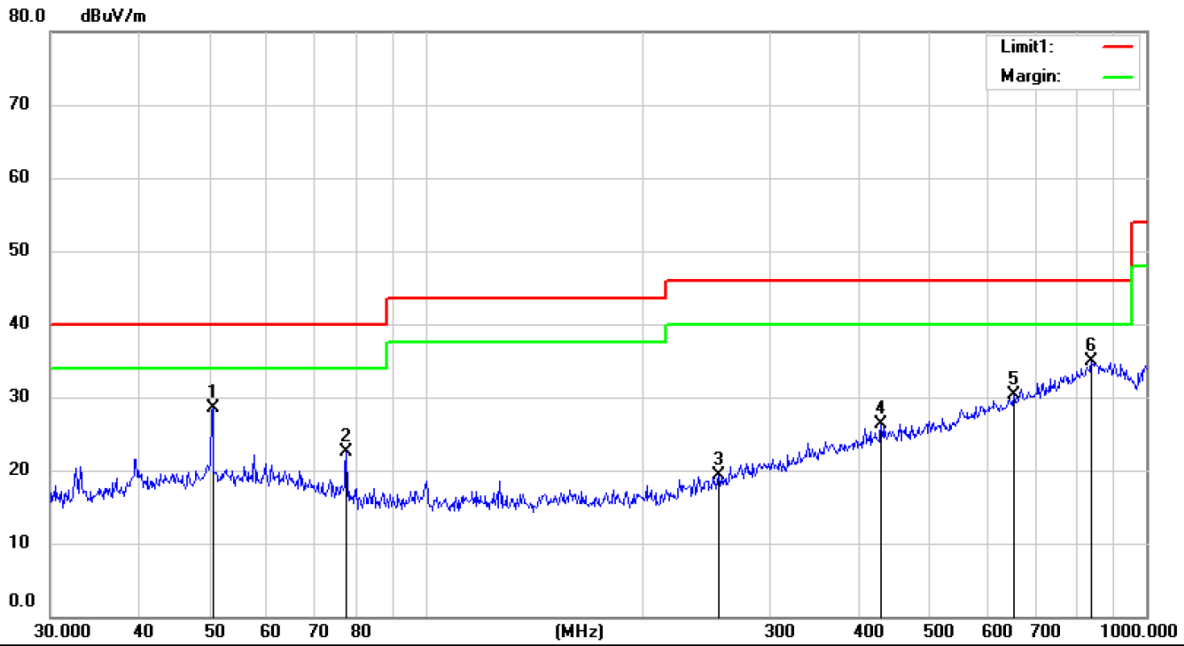

Site 3m Chamber #1 Polarization: **Vertical** Temperature: 28.1 C
 Limit: (RE)FCC PART 15 CLASS B Power: DC 1.5V Humidity: 43 %
 Mode: BT 2480
 Note:

No.	Mk.	Freq.	Reading Level	Correct Factor	Measurement	Limit	Over	Antenna Height	Table Degree	
		MHz	dBuV	dB	dBuV/m	dBuV/m	dB	cm	degree	Comment
1		50.4310	36.02	-7.49	28.53	40.00	-11.47	QP		
2		77.3890	32.49	-10.04	22.45	40.00	-17.55	QP		
3		255.3992	26.34	-6.97	19.37	46.00	-26.63	QP		
4		428.9584	28.16	-1.77	26.39	46.00	-19.61	QP		
5		655.3800	28.35	1.96	30.31	46.00	-15.69	QP		
6	*	840.2860	28.41	6.52	34.93	46.00	-11.07	QP		

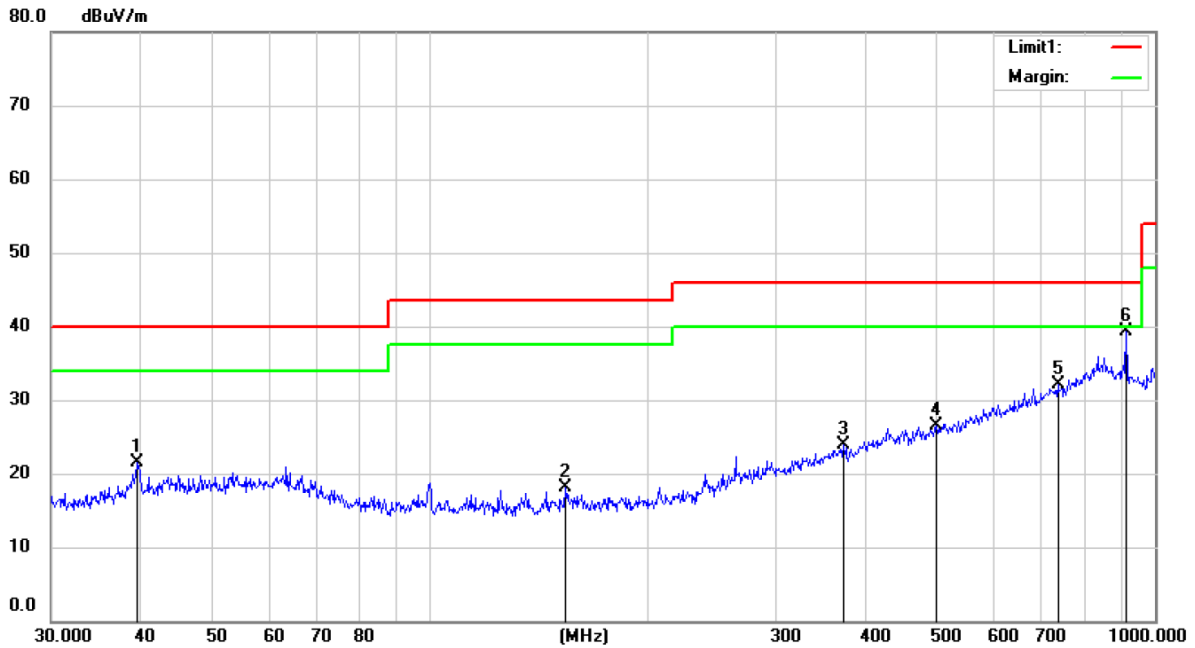

Site 3m Chamber #1 Polarization: **Horizontal** Temperature: 28.1 C
 Limit: (RE)FCC PART 15 CLASS B Power: DC 1.5V Humidity: 43 %
 Mode: BT 2480
 Note:

No.	Mk.	Freq.	Reading Level	Correct Factor	Measurement	Limit	Over	Antenna Height	Table Degree	
		MHz	dBuV	dB	dBuV/m	dBuV/m	dB	cm	degree	Comment
1		39.4545	29.96	-8.37	21.59	40.00	-18.41	QP		
2		153.7385	27.85	-9.72	18.13	43.50	-25.37	QP		
3		372.3308	27.33	-3.40	23.93	46.00	-22.07	QP		
4		500.0818	27.54	-0.99	26.55	46.00	-19.45	QP		
5		735.7802	28.30	3.75	32.05	46.00	-13.95	QP		
6	*	913.2623	34.01	5.32	39.33	46.00	-6.67	QP		

9.8 CONDUCTED EMISSION TEST

9.8.1 Applicable Standard

According to FCC Part 15.207

According to IC RSS-Gen 8.8

9.8.2 Conformance Limit

Conducted Emission Limit		
Frequency(MHz)	Quasi-peak	Average
0.15-0.5	66-56	56-46
0.5-5.0	56	46
5.0-30.0	60	50

Note: 1. The lower limit shall apply at the transition frequencies
 2. The limit decreases in line with the logarithm of the frequency in the range of 0.15 to 0.50MHz.

9.8.3 Test Configuration

Test according to clause 7.3 conducted emission test setup

9.8.4 Test Procedure

The EUT was placed on a table which is 0.8m above ground plane.
 Maximum procedure was performed on the highest emissions to ensure EUT compliance.
 Repeat above procedures until all frequency measured were complete.

9.8.5 Test Results

Pass

The AC120V &240V voltage have been tested, and the worst result recorded was report as below:

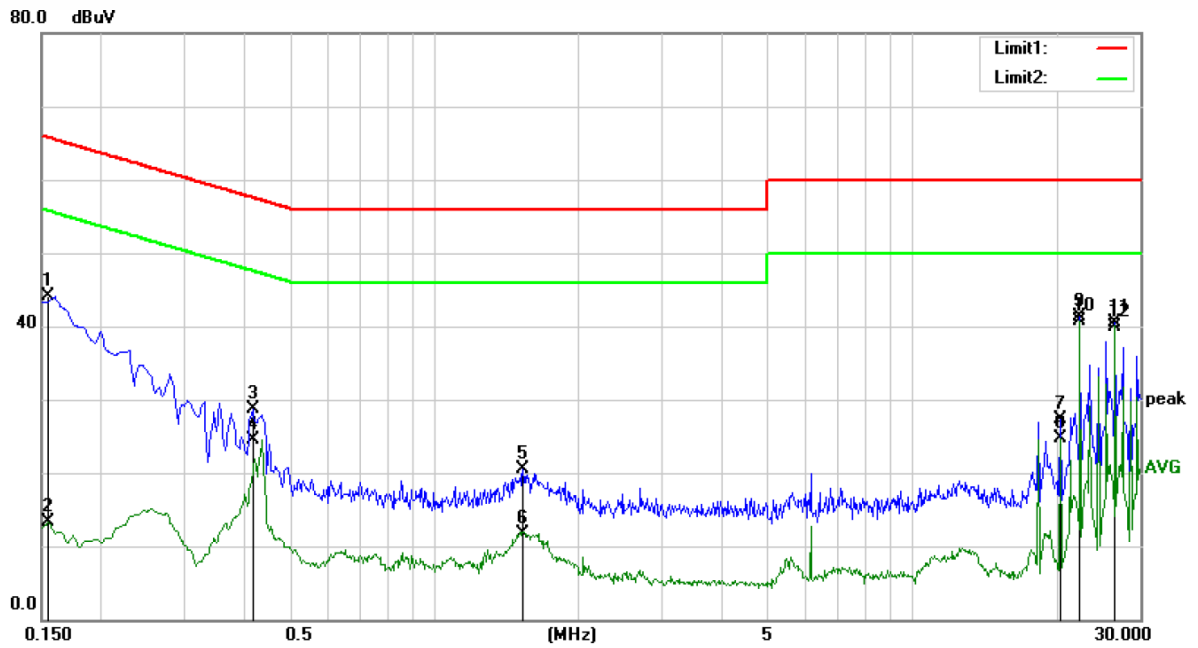

Site Conduction #1

Phase: **L1**

Temperature: 21.9

Limit: (CE)FCC PART 15 class B_QP

Power: DC 3.7V from BATTERY

Humidity: 58 %

No.	Mk.	Freq. MHz	Reading Level dBuV	Correct Factor dB	Measure- ment dBuV	Limit		Detector	Comment
						dBuV	dB		
1		0.1550	34.51	9.54	44.05	65.73	-21.68	QP	
2		0.1550	3.75	9.54	13.29	55.73	-42.44	AVG	
3		0.4150	19.08	9.53	28.61	57.55	-28.94	QP	
4		0.4150	14.91	9.53	24.44	47.55	-23.11	AVG	
5		1.5300	11.01	9.55	20.56	56.00	-35.44	QP	
6		1.5300	2.23	9.55	11.78	46.00	-34.22	AVG	
7		20.4550	17.37	9.90	27.27	60.00	-32.73	QP	
8		20.4550	14.76	9.90	24.66	50.00	-25.34	AVG	
9		22.5050	31.24	9.99	41.23	60.00	-18.77	QP	
10	*	22.5050	30.71	9.99	40.70	50.00	-9.30	AVG	
11		26.6050	30.29	10.17	40.46	60.00	-19.54	QP	
12		26.6050	29.83	10.17	40.00	50.00	-10.00	AVG	

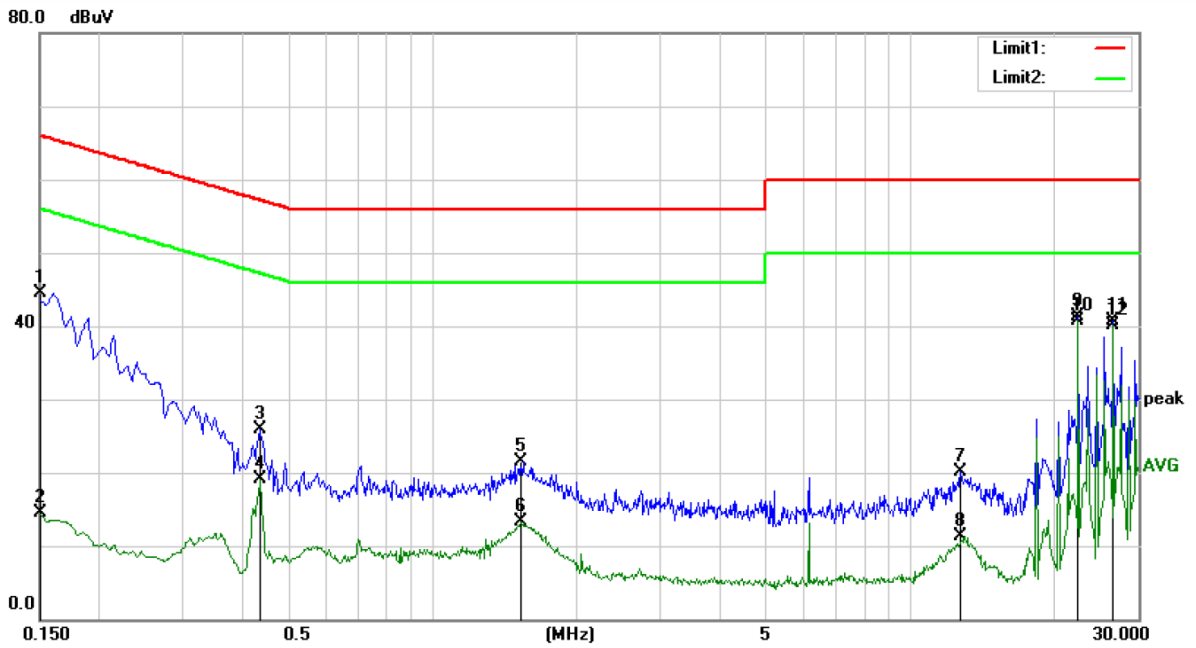

Site Conduction #1 Phase: **N** Temperature: 21.9
 Limit: (CE)FCC PART 15 class B_QP Power: DC 3.7V from BATTERY Humidity: 58 %

No.	Mk.	Freq.	Reading Level	Correct Factor	Measurement	Limit	Over	Detector	Comment
		MHz	dBuV	dB	dBuV	dBuV	dB		
1		0.1500	34.91	9.54	44.45	66.00	-21.55	QP	
2		0.1500	4.91	9.54	14.45	56.00	-41.55	AVG	
3		0.4350	16.28	9.53	25.81	57.16	-31.35	QP	
4		0.4350	9.55	9.53	19.08	47.16	-28.08	AVG	
5		1.5350	11.90	9.55	21.45	56.00	-34.55	QP	
6		1.5350	3.72	9.55	13.27	46.00	-32.73	AVG	
7		12.7550	10.27	9.75	20.02	60.00	-39.98	QP	
8		12.7550	1.48	9.75	11.23	50.00	-38.77	AVG	
9		22.5050	31.32	9.99	41.31	60.00	-18.69	QP	
10	*	22.5050	30.78	9.99	40.77	50.00	-9.23	AVG	
11		26.6050	30.47	10.17	40.64	60.00	-19.36	QP	
12		26.6050	29.96	10.17	40.13	50.00	-9.87	AVG	

9.9 ANTENNA APPLICATION

9.9.1 Antenna Requirement

Standard	Requirement
FCC CRF Part 15.203	An intentional radiator shall be designed to ensure that no antenna other than that furnished by the responsible party shall be used with the device. The use of a permanently attached antenna or of an antenna that uses a unique coupling to the intentional radiator shall be considered sufficient to comply with the provisions of this section. The manufacturer may design the unit so that a broken antenna can be replaced by the user, but the use of a standard antenna jack or electrical connector is prohibited.
FCC 47 CFR Part 15.247 (b)	If transmitting antennas of directional gain greater than 6dBi are used, the power shall be reduced by the amount in dB that the directional gain of the antenna exceeds 6dBi.
RSS-Gen Section 6.8	The applicant for equipment certification shall provide a list of all antenna types that may be used with the transmitter, where applicable (i.e. for transmitters with detachable antenna), indicating the maximum permissible antenna gain (in dBi) and the required impedance for each antenna. The test report shall demonstrate the compliance of the transmitter with the limit for maximum equivalent isotropically radiated power (e.i.r.p.) specified in the applicable RSS, when the transmitter is equipped with any antenna type, selected from this list.
RSS-247 Section 5.4	If the transmitter employs an antenna system that emits multiple directional beams, but does not emit multiple directional beams simultaneously, the total output power conducted to the array or arrays that comprise the device (i.e. the sum of the power supplied to all antennas, antenna elements, staves, etc., and summed across all carriers or frequency channels) shall not exceed the applicable output power limit. However, the total conducted output power shall be reduced by 1 dB below the specified limits for each 3 dB that the directional gain of the antenna/antenna array exceeds 6 dBi. The directional antenna gain shall be computed as the sum of 10 log (number of array elements or staves) plus the directional gain of the element or stave having the highest gain.

9.9.2 Result

PASS.

- Note:
- Antenna use a permanently attached antenna which is not replaceable.
 - Not using a standard antenna jack or electrical connector for antenna replacement
 - The antenna has to be professionally installed (please provide method of installation)

Please refer to the attached document Internal Photos to show the antenna connector.

----- END OF REPORT -----