









FCC AND ISCED CERTIFICATION TEST REPORT

Applicant:	Guangzhou Shikun Electronics Co., Ltd
Address:	NO.6 Liankun Road, Huangpu District, Guangzhou, China
Manufacturer:	Guangzhou Shikun Electronics Co., Ltd
Address:	NO.6 Liankun Road, Huangpu District, Guangzhou, China
Product Description:	IEEE 802.11b/g/n/a/ac/ax 2T2R USB WiFi Module Integrated BT 2.1+EDR/4.2/5.2
Brand Name:	NA
Tested Model:	SKO.WB920TU.3
FCC ID:	2AR82-SKOWB920TU3
IC:	24728-SKOWB920TU3
Report No.:	JCF231017201-004
Received Date:	Oct. 17, 2023
Tested Date:	Oct. 17, 2023 ~ Nov. 07, 2023
Issued Date:	Nov. 07, 2023
Test Standards:	FCC Rules and Regulations Part 15 Subpart E, RSS-247 Issue 3 August 2023
Test Procedure:	ANSI C63.10:2013, 789033 D02 General U-NII Test Procedures New Rules v02r01, 662911 D01 Multiple Transmitter Output v02r01
Test Result:	Pass
Prepared By:	
 <u>Roger Li/Engineer</u>	
Date: Nov. 07, 2023 	
Reviewed By:	
 <u>Kennys Zhang/Engineer</u>	
Date: Nov. 07, 2023 	
Approved By:	
 <u>Talent Zhang/Engineer</u>	
Date: Nov. 07, 2023 	

Note: The test results in this report apply exclusively to the tested model / sample. Without written approval of Guangzhou Jingce Testing Technology Co., Ltd. the test report shall not be reproduced except in full.

Report Revise Record

Report Version	Revise Time	Issued Date	Valid Version	Notes
V1.0	/	Nov. 07, 2023	Original Report	/

Table of Contents

1. Test Report Declare	5
2. Summary of test results	6
3. Test Laboratory	6
4. Equipment Under Test	7
4.1. Description of EUT	7
4.2. Channel List	7
4.3. Test Channel Configuration	10
4.4. Test Environment Conditions	11
4.5. The Worse Case Power Setting Parameter	11
4.6. Description of Available Antennas	14
5. Description of Test Setup	14
5.1. Accessory	14
5.2. Support Equipment	14
5.3. Test Setup	14
5.4. Setup Diagram for Tests	14
6. Measurement uncertainty	14
7. Measuring Instrument and Software Used	15
8. Duty Cycle	16
8.1. Block Diagram of Test Setup	16
8.2. Limits	16
8.3. Procedure	16
8.4. Results	16
8.5. Original Test Data	20
9. 26dB Bandwidth, 6dB Bandwidth and 99% Bandwidth	83
9.1. Block Diagram of Test Setup	83
9.2. Limits	83
9.3. Test Procedure	83
9.4. Test Result	84
9.5. Original Test Data	93
10. Maximum Output Power	233
10.1. Block Diagram of Test Setup	233
10.2. Limits	233
10.3. Test Procedure	233
10.4. Test Result	234
11. Power Spectral Density	245
11.1. Block Diagram of Test Setup	245
11.2. Limits	245
11.3. Test Procedure	246
11.4. Test Result	247
11.5. Original Test Data	252
12. Frequency Stability Measurement	321
12.1. Block Diagram of Test Setup	321
12.2. Limit of Frequency Stability	321
12.3. Test Procedures	321
12.4. Test Result	321
13. Radiated Emission	326
13.1. Block Diagram of Test Setup	326
13.2. Limit	327
13.3. Test Procedure	329
13.4. Test Result	331
13.5. Original Test Data	331
14. AC Power Line Conducted Emissions	344

14.1. Block Diagram of Test Setup	344
14.2. Limits	344
14.3. Test Procedure	344
14.4. Test Result	345
15. Dynamic Frequency Selection	346
15.1. Applicability of DFS Requirements	346
15.2. Limit	347
15.3. Parameters of Radar Test Waveform	347
15.4. Calibration of Radar Waveform	348
15.5. Channel Closing Transmission Time, Channel Move Time and Non-Occupancy Period	351
15.6. Test Setup	352
15.7. Test Result	352
16. Antenna Requirements	355
16.1. Applicable Requirements	355
16.2. Result	355
APPENDIX A - Radiated Emission Below 1GHz Test Data	356
APPENDIX B - Radiated Emission Above 1GHz Test Data	358

1. Test Report Declare

Applicant:	Guangzhou Shikun Electronics Co., Ltd
Address:	NO.6 Liankun Road, Huangpu District, Guangzhou, China
Manufacturer:	Guangzhou Shikun Electronics Co., Ltd
Address:	NO.6 Liankun Road, Huangpu District, Guangzhou, China
Product Name:	IEEE 802.11b/g/n/a/ac/ax 2T2R USB WiFi Module Integrated BT 2.1+EDR/4.2/5.2
Brand Name:	NA
Model Name:	SKO.WB920TU.3
Difference Description:	NA

We Declare:

The equipment described above is tested by Guangzhou Jingce Testing Technology Co., Ltd. and in the configuration tested the equipment complied with the standards specified above. The test results are contained in this test report and Guangzhou Jingce Testing Technology Co., Ltd. is assumed of full responsibility for the accuracy and completeness of these tests.

2. Summary of test results

The EUT have been tested according to the applicable standards as referenced below.			
Clause	Description of Test Item	Standard	Verdict
1	6/26dB Bandwidth	FCC 15.407 (a)&(e) RSS-247 Clause 6.2	Pass
2	99% Occupied Bandwidth	RSS-Gen Clause 6.6	Pass
3	Maximum Conducted Output Power	FCC 15.407 (a) RSS-247 Clause 6.2	Pass
4	Power Spectral Density	FCC 15.407 (a) RSS-247 Clause 6.2	Pass
5	Frequency Stability Measurement	FCC 15.407 (g)	Pass
6	Radiated Band edge and Spurious Emission	FCC 15.407 (b) FCC 15.209 FCC 15.205 RSS-247 Clause 6.2 RSS-GEN Clause 8.9	Pass
7	Power Line Conducted Emission	FCC 15.207 RSS-GEN Clause 8.8	NA
8	Antenna requirement	FCC 15.203 RSS-GEN Clause 8.3	Pass
9	Dynamic Frequency Selection	FCC 15.407 (h) RSS-247 Clause 6.3	Pass

3. Test Laboratory

Guangzhou Jingce Testing Technology Co., Ltd.

Add.: No.192, Kezhu Road, Huangpu District, Guangzhou, Guangdong, China

Association for Laboratory Accreditation(A2LA). Certificate Number: 6594.01

FCC Designation Number: CN1331. Test Firm Registration Number: 360543

IC Test Firm Registration Number: 28796

Conformity Assessment Body identifier: CN0138

4. Equipment Under Test

4.1. Description of EUT

EUT Name:	IEEE 802.11b/g/n/a/ac/ax 2T2R USB WiFi Module Integrated BT 2.1+EDR/4.2/5.2
Model Number:	SKO.WB920TU.3
EUT Function Description:	Please refer to user manual of this device
Power Supply:	DC 5V+/-0.3
Hardware Version:	NA
Software Version:	NA
Radio Shrapnelation:	IEEE 802.11a/n/ac/ax
Operation Frequency:	IEEE 802.11a: 5180MHz—5825MHz IEEE 802.11n HT20: 5180MHz—5825MHz IEEE 802.11n HT40: 5190MHz—5795MHz IEEE 802.11ac VHT20: 5180MHz—5825MHz IEEE 802.11ac VHT40: 5190MHz—5795MHz IEEE 802.11ac VHT80: 5210MHz—5775MHz IEEE 802.11ax HE20: 5180MHz—5825MHz IEEE 802.11ax HE40: 5190MHz—5795MHz IEEE 802.11ax HE80: 5210MHz—5775MHz
Modulation:	IEEE 802.11a: OFDM (64QAM, 16QAM, QPSK, BPSK) IEEE 802.11n HT20, HT40: OFDM (64QAM, 16QAM, QPSK, BPSK) IEEE 802.11ac (VHT20/40/80): OFDM (256QAM, 64QAM, 16QAM, QPSK, BPSK) IEEE 802.11ax (HE20/40/80): OFDMA (1024QAM, 256QAM, 64QAM, 16QAM, QPSK, BPSK)
Data Rate:	IEEE 802.11a: 6, 9, 12, 18, 24, 36, 48, 54Mbps IEEE 802.11n HT20: 14.4, 28.9, 43.3, 57.8, 86.7, 115.6, 130, 144.4 Mbps IEEE 802.11n HT40: 30, 60, 90, 120, 180, 240, 270, 300 Mbps IEEE 802.11ac VHT20: 14.4, 28.9, 43.3, 57.8, 86.7, 115.6, 130, 144.4, 173.3 Mbps IEEE 802.11ac VHT40: 30, 60, 90, 120, 180, 240, 270, 300, 360, 400 Mbps IEEE 802.11ac VHT80: 65, 130, 195, 260, 390, 520, 585, 650, 780, 866.7 Mbps IEEE 802.11ax HE20: 17.2, 34.4, 51.6, 68.8, 103.2, 137.6, 154.8, 172.1, 206.5, 229.4, 258.1, 286.8Mbps IEEE 802.11ax HE40: 34.4, 68.8, 103.2, 137.6, 206.4, 275.2, 309.7, 344.1, 412.9, 458.8, 516.1, 573.5Mbps IEEE 802.11ax HE80: 72, 144.1, 216.1, 288.2, 432.3, 576.4, 648.5, 720.5, 864.7, 960.7, 1080.8, 1200.9Mbps
Antenna Type:	Shrapnel Antenna0, MAX. Gain: 0.90 dBi Shrapnel Antenna1, MAX. Gain: 6.08 dBi

Note 1: EUT is the ab. of equipment under test.

Note 2: The antenna gain is declared by the customer and the laboratory is not responsible for the accuracy of the antenna gain.

4.2. Channel List

UNII-1 (For Bandwidth = 20 MHz)		UNII-1 (For Bandwidth = 40 MHz)	
Channel	Frequency (MHz)	Channel	Frequency (MHz)
36	5180	38	5190
40	5200	46	5230

44	5220	/	/
48	5240	/	/
UNII-1 (For Bandwidth = 80 MHz)			
Channel		Frequency (MHz)	
42		5210	

UNII-2A (For Bandwidth = 20 MHz)		UNII-2A (For Bandwidth = 40 MHz)	
Channel	Frequency (MHz)	Channel	Frequency (MHz)
52	5260	54	5270
56	5280	62	5310
60	5300	/	/
64	5320	/	/
UNII-2A (For Bandwidth = 80 MHz)			
Channel		Frequency (MHz)	
58		5290	

UNII-2C (For Bandwidth = 20 MHz)		UNII-2C (For Bandwidth = 40 MHz)	
Channel	Frequency (MHz)	Channel	Frequency (MHz)
100	5500	102	5510
104	5520	110	5550
108	5540	118	5590
112	5560	126	5630
116	5580	134	5670
120	5600	142	5710
124	5620	/	/
128	5640	/	/
132	5660	/	/
136	5680	/	/
140	5700	/	/
144	5720	/	/
UNII-2C (For Bandwidth = 80 MHz)			
Channel		Frequency (MHz)	

106	5530
122	5610
138	5690

UNII-3 (For Bandwidth = 20 MHz)		UNII-3 (For Bandwidth = 40 MHz)	
Channel	Frequency (MHz)	Channel	Frequency (MHz)
149	5745	151	5755
153	5765	159	5795
157	5785	/	/
161	5805	/	/
165	5825	/	/
UNII-3 (For Bandwidth = 80 MHz)			
Channel		Frequency (MHz)	
155		5775	

4.3. Test Channel Configuration

Mode	Data rate (Mbps) (see Note)	Test Channel and Frequency
802.11a TX Mode	6	CH36, 5180
	6	CH44, 5220
	6	CH48, 5240
	6	CH52, 5260
	6	CH60, 5300
	6	CH64, 5320
	6	CH100, 5500
	6	CH116, 5580
	6	CH140, 5700
	6	CH144, 5720
	6	CH149, 5745
802.11n HT20 TX Mode	MCS 0	CH36, 5180
	MCS 0	CH44, 5220
	MCS 0	CH48, 5240
	MCS 0	CH52, 5260
	MCS 0	CH60, 5300
	MCS 0	CH64, 5320
	MCS 0	CH100, 5500
	MCS 0	CH116, 5580
	MCS 0	CH140, 5700
	MCS 0	CH144, 5720
	MCS 0	CH149, 5745
802.11n HT40 TX Mode	MCS 0	CH38, 5190
	MCS 0	CH46, 5230
	MCS 0	CH54, 5270
	MCS 0	CH62, 5310
	MCS 0	CH102, 5510
	MCS 0	CH110, 5550
	MCS 0	CH134, 5670
	MCS 0	CH142, 5710
	MCS 0	CH151, 5755
802.11ac VHT20 TX Mode	MCS 0	CH36, 5180
	MCS 0	CH44, 5220
	MCS 0	CH48, 5240
	MCS 0	CH52, 5260
	MCS 0	CH60, 5300
	MCS 0	CH64, 5320
	MCS 0	CH100, 5500
	MCS 0	CH116, 5580
	MCS 0	CH140, 5700
	MCS 0	CH140, 5720
	MCS 0	CH149, 5745
802.11ac VHT40 TX Mode	MCS 0	CH157, 5785
	MCS 0	CH165, 5825
	MCS 0	CH38, 5190
	MCS 0	CH46, 5230
	MCS 0	CH54, 5270
	MCS 0	CH62, 5310

	MCS 0	CH142, 5710
	MCS 0	CH151, 5755
	MCS 0	CH159, 5795
802.11ac VHT80 TX Mode	MCS 0	CH42, 5210
	MCS 0	CH58, 5290
	MCS 0	CH106, 5530
	MCS 0	CH122, 5610
	MCS 0	CH138, 5690
	MCS 0	CH155, 5775
		MCS 0
802.11ax HE20 TX Mode	MCS 0	CH44, 5220
	MCS 0	CH48, 5240
	MCS 0	CH52, 5260
	MCS 0	CH60, 5300
	MCS 0	CH64, 5320
	MCS 0	CH100, 5500
	MCS 0	CH116, 5580
	MCS 0	CH140, 5700
	MCS 0	CH144, 5720
	MCS 0	CH149, 5745
	MCS 0	CH157, 5785
	MCS 0	CH165, 5825
802.11ax HE40 TX Mode	MCS 0	CH38, 5190
	MCS 0	CH46, 5230
	MCS 0	CH54, 5270
	MCS 0	CH62, 5310
	MCS 0	CH102, 5510
	MCS 0	CH110, 5550
	MCS 0	CH134, 5670
	MCS 0	CH142, 5710
	MCS 0	CH151, 5755
	MCS 0	CH159, 5795
802.11ax HE80 TX Mode	MCS 0	CH42, 5210
	MCS 0	CH58, 5290
	MCS 0	CH106, 5530
	MCS 0	CH122, 5610
	MCS 0	CH138, 5690
	MCS 0	CH155, 5775
RX Mode	MCS 0	/

4.4. Test Environment Conditions

During the measurement the environmental conditions were within the listed ranges:

	Normal Conditions	Extreme Conditions
Temperature range	21-25 °C	-10 °C to +70 °C
Humidity range	40-75%	N/A
Pressure range	86-106 kPa	N/A
Power supply	NV: DC 5V	N/A

Note: The Extreme temperature range and extreme voltages are declared by the manufacturer.

4.5. The Worse Case Power Setting Parameter

The Worse Case Power Setting Parameter				
Test Software	N/A			
Mode	Rate	Channel	Soft set value	
			ANT0	ANT1
802.11a	6 MHz	36	18	10

		44	18	10
		48	18	10
		52	18	10
		60	18	10
		64	14	10
		100	18	14
		116	18	14
		140	12	13
		144	18	13
		149	18	10
		157	18	10
		165	18	10
802.11n HT20	MCS 0	36	6	6
		44	6	6
		48	6	6
		52	6	6
		60	6	6
		64	8	8
		100	8	8
		116	8	8
		140	8	8
		144	8	8
		149	8	8
		157	8	8
802.11n HT40	MCS 0	38	8	8
		46	8	8
		54	8	8
		62	9	9
		102	9	9
		110	9	9
		134	9	9
		142	9	9
		151	9	9
159	9	9		
802.11ac VHT20	MCS 0	36	6	6
		44	6	6
		48	6	6
		52	6	6
		60	8	8
		64	8	8
		100	9	9
		116	10	10
		140	10	10
		144	9	9
		149	9	9
		157	9	9
802.11ac VHT40	MCS 0	38	8	8
		46	8	8
		54	8	8
		62	9	9
		102	9	9
		110	9	9
		134	9	9
		144	9	9
		151	9	9
159	9	9		
802.11ac VHT80	MCS 0	42	8	8
		58	8	8

		106	10	10
		122	10	10
		155	9	9
802.11ax HE20	MCS 0	36	8	8
		44	8	8
		48	8	8
		52	8	8
		60	8	8
		64	8	8
		100	8	8
		116	8	8
		140	9	9
		144	7	7
		149	9	9
		157	9	9
		165	9	9
		802.11ax HE40	MCS 0	38
46	8			8
54	8			8
62	9			9
102	9			9
110	9			9
134	9			9
142	9			9
151	9			9
159	9			9
802.11ax HE80	MCS 0	42	8	8
		58	8	8
		106	10	10
		122	10	10
		138	9	9
		155	9	9

4.6. Description of Available Antennas

Test Mode	Transmit and Receive Mode	Description
802.11a	☒ 2TX, 2RX	ANT 1 and ANT1 can be used as transmitting/receiving antenna.
802.11n HT20	☒ 2TX, 2RX	ANT 1 and ANT1 can be used as transmitting/receiving antenna.
802.11n HT40	☒ 2TX, 2RX	ANT 1 and ANT1 can be used as transmitting/receiving antenna.
802.11ac VHT20	☒ 2TX, 2RX	ANT 1 and ANT1 can be used as transmitting/receiving antenna.
802.11ac VHT40	☒ 2TX, 2RX	ANT 1 and ANT1 can be used as transmitting/receiving antenna.
802.11ac VHT80	☒ 2TX, 2RX	ANT 1 and ANT1 can be used as transmitting/receiving antenna.
802.11ax HE20	☒ 2TX, 2RX	ANT 1 and ANT1 can be used as transmitting/receiving antenna.
802.11ax HE40	☒ 2TX, 2RX	ANT 1 and ANT1 can be used as transmitting/receiving antenna.
802.11ax HE80	☒ 2TX, 2RX	ANT 1 and ANT1 can be used as transmitting/receiving antenna.

5. Description of Test Setup

5.1. Accessory

Description of Accessories	Manufacturer	Model Number	Description	Remark
/	/	/	/	/

5.2. Support Equipment

Equipment	Brand Name	Model Name	P/N
PC	Lenovo	T480	/

5.3. Test Setup

The EUT can work in Fixed Frequency mode.

5.4. Setup Diagram for Tests



6. Measurement uncertainty

Test Item	Uncertainty
AC Power Conduction emission	1.37 dB
All Radiated emissions	5.4dB
Conducted emissions	3.09 dB
Occupied Channel Bandwidth	1.1%
Conducted Output power	0.82dB
Power Spectral Density	0.82dB

Note: This uncertainty represents an expanded uncertainty expressed at approximately the 95 % confidence level using a coverage factor of $k = 2$.

7. Measuring Instrument and Software Used

TS Test System						
Used	Equipment	Manufacturer	Model No.	Serial No.	Last Cal.	Due. Date
p	Spectrum Analyzer	Keysight	N9030B	MY56320512	Sep. 12, 2023	Sep. 11, 2024
p	Vector Signal Generator	Keysight	N5182B	MY57300334	Sep. 12, 2023	Sep. 11, 2024
p	Signal Generator	Keysight	N5171B	MY57280639	Sep. 12, 2023	Sep. 11, 2024
p	DC POWER	Keysight	E342A	MY59020356	Jul. 14, 2023	Jul. 13, 2024
p	Incubator thermometer	GWS	EL-02JA	21107288	Sep. 12, 2023	Sep. 11, 2024
p	Control unit(Power sensor)	Tonscend	JS0806-2	/	Sep. 12, 2023	Sep. 11, 2024
p	Wideband radio communication tester	R&S	CMW500	163478	Jul. 11, 2023	Jul. 10, 2024
Software						
Used	Description	Manufacturer	Name		Version	
p	Test software	TS+	JS1120-3		V3.3.10	
RSE Test System						
Used	Equipment	Manufacturer	Model No.	Serial No.	Last Cal.	Due. Date
p	EMI Receiver	R&S	ESW	101685	Jul. 12, 2023	Jul. 11, 2024
p	Bilog Antenna	Schwarzbeck	VULB 9163	01416	Mar. 21, 2023	Mar. 20, 2024
p	Horn Antenna 1	Schwarzbeck	BBHA 9120 D	02411	May. 25, 2023	May. 24, 2024
p	Horn Antenna 2	ETS	BBHA 9170	1090	Sep. 04, 2023	Sep. 03, 2024
p	loop-antenna	Schwarzbeck	FMZB 1513-60	00030	Jan.14,2023	Jan.13,2024
p	Signal Pre-Amplifier	Tonscend	TAP01018050	AP21C806122	Jul. 10, 2023	Jul. 09, 2024
p	Signal Pre-Amplifier	Tonscend	TAP9K3G32	AP20K806104	Jul. 10, 2023	Jul. 09, 2024
p	Signal Pre-Amplifier	ETS	3116C-PA	00217677	Aug. 24, 2023	Aug. 23, 2024
p	3m Fully-anechoic Chamber	ETS	RFD-100	/	Apr. 24, 2021	Apr. 23, 2024
p	Temperature & Humidity	Temperature	HTC-1	/	Nov. 25, 2022	Nov. 24, 2023
Software						
Used	Description	Manufacturer	Name		Version	
p	Test software	TS+	TS+		V3.0.0.4	

8. Duty Cycle

8.1. Block Diagram of Test Setup

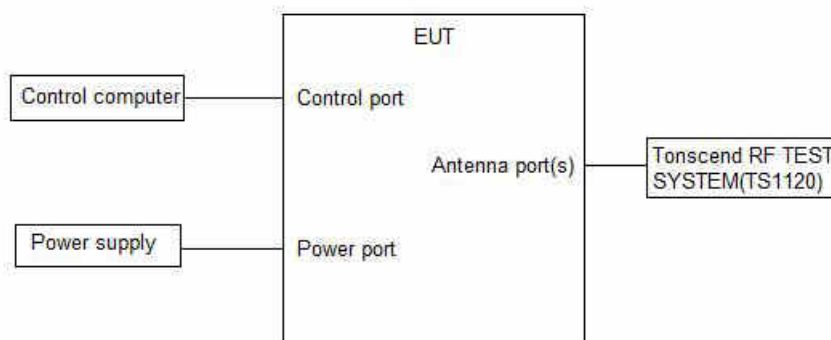

8.2. Limits

None; for reporting purposes only.

8.3. Procedure

Refer to KdB 789033 D02 General U-NII Test Procedures New Rules v02r01 section II.B.

The zero-span mode on a spectrum analyzer or EMI receiver, if the response time and spacing between bins on the sweep are sufficient to permit accurate measurements of the on and off times of the transmitted signal.

Set the center frequency of the instrument to the center frequency of the transmission.

Set RBW \geq EBW if possible; otherwise,

set RBW to the largest available value. Set VBW \geq RBW.

Set detector = peak or average. The zero-span measurement method shall not be used unless both RBW and VBW are $> 50/T$, where T is defined in II.B.1.a), and the number of sweep points across duration T exceeds 100. (For example, if VBW and/or RBW are limited to 3 MHz, then the zero-span method of measuring duty cycle shall not be used if $T \leq 16.7$ microseconds.)

8.4. Results

Test Mode	Ant.	Freq. (MHz)	Transmission Duration (ms)	Transmission Period (ms)	Duty Cycle (%)
11A	ANT0	5180	1.39	1.77	78.53
	ANT1	5180	1.39	1.77	78.53
	ANT0	5200	1.39	1.76	78.98
	ANT1	5200	1.39	1.77	78.53
	ANT0	5240	1.39	1.77	78.53
	ANT1	5240	1.39	1.77	78.53
	ANT0	5260	1.39	1.77	78.53
	ANT1	5260	1.40	1.77	79.10
	ANT0	5280	1.39	1.77	78.53
	ANT1	5280	1.39	1.76	78.98
	ANT0	5320	1.39	1.77	78.53
	ANT1	5320	1.39	1.76	78.98
	ANT0	5500	1.39	1.76	78.98
	ANT1	5500	1.39	1.77	78.53
	ANT0	5580	1.39	1.77	78.53
	ANT1	5580	1.39	1.77	78.53
	ANT0	5700	1.39	1.77	78.53
	ANT1	5700	1.39	1.77	78.53
	ANT0	5720	1.39	1.77	78.53
	ANT1	5720	1.39	1.77	78.53
ANT0	5745	1.39	1.77	78.53	
ANT1	5745	1.39	1.77	78.53	
ANT0	5785	1.39	1.77	78.53	

	ANT1	5785	1.39	1.77	78.53	
	ANT0	5825	1.39	1.77	78.53	
	ANT1	5825	1.39	1.77	78.53	
11N20MIMO	ANT0	5180	1.30	1.68	77.38	
	ANT1	5180	1.30	1.68	77.38	
	ANT0	5200	1.30	1.68	77.38	
	ANT1	5200	1.30	1.68	77.38	
	ANT0	5240	1.30	1.68	77.38	
	ANT1	5240	1.30	1.67	77.84	
	ANT0	5260	1.30	1.68	77.38	
	ANT1	5260	1.30	1.68	77.38	
	ANT0	5280	1.30	1.68	77.38	
	ANT1	5280	1.30	1.68	77.38	
	ANT0	5320	1.30	1.67	77.84	
	ANT1	5320	1.30	1.68	77.38	
	ANT0	5500	1.30	1.68	77.38	
	ANT1	5500	1.30	1.68	77.38	
	ANT0	5580	1.30	1.68	77.38	
	ANT1	5580	1.30	1.67	77.84	
	ANT0	5700	1.30	1.68	77.38	
	ANT1	5700	1.30	1.67	77.84	
	ANT0	5720	1.30	1.68	77.38	
	ANT1	5720	1.30	1.69	76.92	
	ANT0	5745	1.30	1.68	77.38	
	ANT1	5745	1.30	1.69	76.92	
	ANT0	5785	1.30	1.68	77.38	
	ANT1	5785	1.30	1.68	77.38	
	ANT0	5825	1.30	1.68	77.38	
	ANT1	5825	1.30	1.68	77.38	
	11N40MIMO	ANT0	5190	0.65	1.03	63.11
		ANT1	5190	0.64	1.03	62.14
ANT0		5230	0.64	1.00	64.00	
ANT1		5230	0.65	1.04	62.50	
ANT0		5270	0.64	1.00	64.00	
ANT1		5270	0.64	1.00	64.00	
ANT0		5310	0.65	1.01	64.36	
ANT1		5310	0.64	1.03	62.14	
ANT0		5510	0.65	1.03	63.11	
ANT1		5510	0.65	1.03	63.11	
ANT0		5550	0.65	1.03	63.11	
ANT1		5550	0.64	1.00	64.00	
ANT0		5670	0.65	1.03	63.11	
ANT1		5670	0.65	1.04	62.50	
ANT0		5710	0.64	1.00	64.00	
ANT1		5710	0.65	1.03	63.11	
ANT0		5755	0.65	1.01	64.36	
ANT1		5755	0.64	1.00	64.00	
ANT0	5795	0.64	1.00	64.00		
ANT1	5795	0.65	1.03	63.11		
11AC20MIMO	ANT0	5180	0.68	1.06	64.15	
	ANT1	5180	0.68	1.07	63.55	
	ANT0	5200	0.68	1.06	64.15	
	ANT1	5200	0.68	1.07	63.55	
	ANT0	5240	0.68	1.07	63.55	
	ANT1	5240	0.68	1.06	64.15	
	ANT0	5260	0.68	1.07	63.55	
	ANT1	5260	0.68	1.07	63.55	
	ANT0	5280	0.68	1.06	64.15	
	ANT1	5280	0.68	1.07	63.55	
ANT0	5320	0.68	1.08	62.96		

	ANT1	5320	0.68	1.06	64.15
	ANT0	5500	0.68	1.06	64.15
	ANT1	5500	0.68	1.07	63.55
	ANT0	5580	0.68	1.08	62.96
	ANT1	5580	0.68	1.06	64.15
	ANT0	5700	0.68	1.07	63.55
	ANT1	5700	0.68	1.06	64.15
	ANT0	5720	0.68	1.07	63.55
	ANT1	5720	0.68	1.07	63.55
	ANT0	5745	0.68	1.07	63.55
	ANT1	5745	0.68	1.07	63.55
	ANT0	5785	0.68	1.07	63.55
	ANT1	5785	0.68	1.07	63.55
	ANT0	5825	0.68	1.07	63.55
	ANT1	5825	0.68	1.07	63.55
11AC40MIMO	ANT0	5190	0.35	0.73	47.95
	ANT1	5190	0.35	0.79	44.30
	ANT0	5230	0.35	0.74	47.30
	ANT1	5230	0.35	0.74	47.30
	ANT0	5270	0.35	0.74	47.30
	ANT1	5270	0.35	0.74	47.30
	ANT0	5310	0.35	0.73	47.95
	ANT1	5310	0.35	0.74	47.30
	ANT0	5510	0.35	0.73	47.95
	ANT1	5510	0.35	0.73	47.95
	ANT0	5550	0.35	0.74	47.30
	ANT1	5550	0.35	0.73	47.95
	ANT0	5670	0.35	0.74	47.30
	ANT1	5670	0.35	0.74	47.30
	ANT0	5710	0.35	0.73	47.95
	ANT1	5710	0.35	0.73	47.95
	ANT0	5755	0.35	0.74	47.30
	ANT1	5755	0.35	0.73	47.95
ANT0	5795	0.35	0.74	47.30	
ANT1	5795	0.35	0.73	47.95	
11AC80MIMO	ANT0	5210	0.18	0.55	32.73
	ANT1	5210	0.19	0.56	33.93
	ANT0	5290	0.19	0.56	33.93
	ANT1	5290	0.18	0.55	32.73
	ANT0	5530	0.19	0.56	33.93
	ANT1	5530	0.18	0.55	32.73
	ANT0	5610	0.19	0.56	33.93
	ANT1	5610	0.00	0.04	100
	ANT0	5690	0.19	0.55	34.55
	ANT1	5690	0.19	0.56	33.93
	ANT0	5775	0.18	0.55	32.73
	ANT1	5775	0.18	0.55	32.73
11AX20MIMO	ANT0	5180	0.20	0.42	47.62
	ANT1	5180	0.20	0.40	50.00
	ANT0	5200	0.20	0.40	50.00
	ANT1	5200	0.20	0.40	50.00
	ANT0	5240	0.20	0.40	50.00
	ANT1	5240	0.20	0.40	50.00
	ANT0	5260	0.20	0.40	50.00
	ANT1	5260	0.20	0.40	50.00
	ANT0	5280	0.20	0.40	50.00
	ANT1	5280	0.20	0.40	50.00
	ANT0	5320	0.20	0.40	50.00
	ANT1	5320	0.20	0.40	50.00
ANT0	5500	0.20	0.40	50.00	

	ANT1	5500	0.20	0.40	50.00
	ANT0	5580	0.20	0.40	50.00
	ANT1	5580	0.20	0.40	50.00
	ANT0	5700	0.20	0.40	50.00
	ANT1	5700	0.20	0.40	50.00
	ANT0	5720	0.20	0.40	50.00
	ANT1	5720	0.20	0.40	50.00
	ANT0	5745	0.20	0.40	50.00
	ANT1	5745	0.20	0.40	50.00
	ANT0	5785	0.20	0.40	50.00
	ANT1	5785	0.20	0.40	50.00
	ANT0	5825	0.20	0.40	50.00
	ANT1	5825	0.20	0.57	35.09
11AX40MIMO	ANT0	5190	0.32	0.71	45.07
	ANT1	5190	0.32	0.77	41.56
	ANT0	5230	0.32	0.71	45.07
	ANT1	5230	0.32	0.71	45.07
	ANT0	5270	0.32	0.71	45.07
	ANT1	5270	0.32	0.76	42.11
	ANT0	5310	0.32	0.71	45.07
	ANT1	5310	0.32	0.71	45.07
	ANT0	5510	0.32	0.70	45.71
	ANT1	5510	0.32	0.71	45.07
	ANT0	5550	0.32	0.71	45.07
	ANT1	5550	0.32	0.71	45.07
	ANT0	5670	0.32	0.71	45.07
	ANT1	5670	0.32	0.70	45.71
	ANT0	5710	0.32	0.76	42.11
	ANT1	5710	0.32	0.71	45.07
	ANT0	5755	0.32	0.71	45.07
	ANT1	5755	0.32	0.71	45.07
	ANT0	5795	0.32	0.71	45.07
	ANT1	5795	0.32	0.71	45.07
11AX80MIMO	ANT0	5210	0.19	0.42	45.24
	ANT1	5210	0.19	0.43	44.19
	ANT0	5290	0.19	0.42	45.24
	ANT1	5290	0.19	0.42	45.24
	ANT0	5530	0.19	0.43	44.19
	ANT1	5530	0.20	0.45	44.44
	ANT0	5610	0.19	0.44	43.18
	ANT1	5610	0.19	0.42	45.24
	ANT0	5690	0.19	0.43	44.19
	ANT1	5690	0.19	0.43	44.19
	ANT0	5775	0.19	0.43	44.19
	ANT1	5775	0.19	0.42	45.24

8.5. Original Test Data



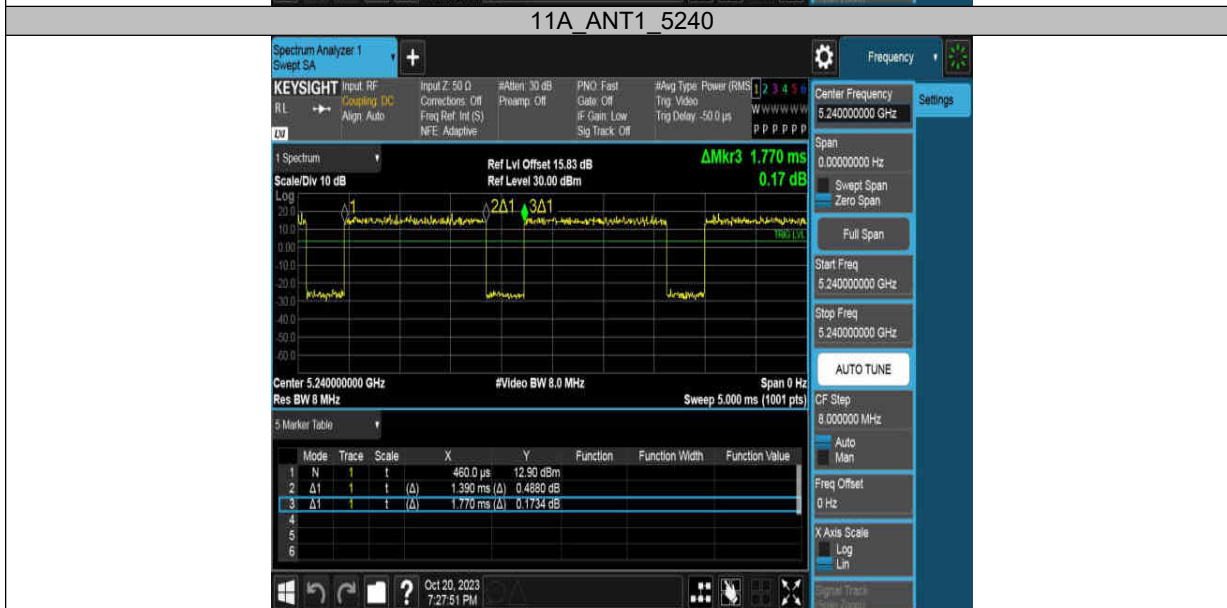
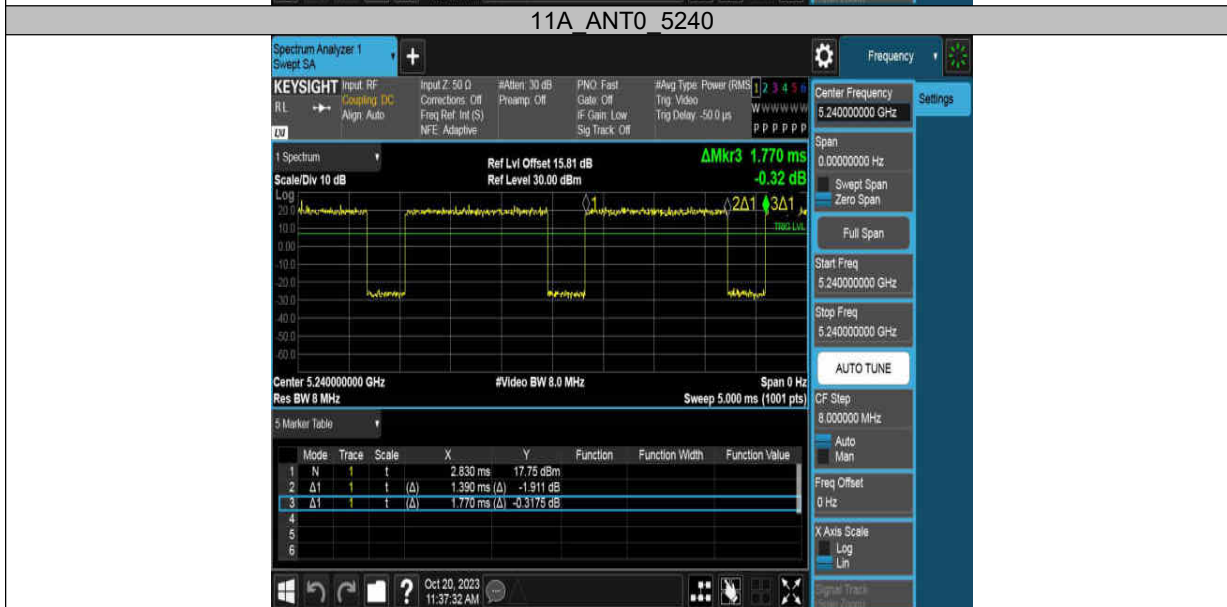

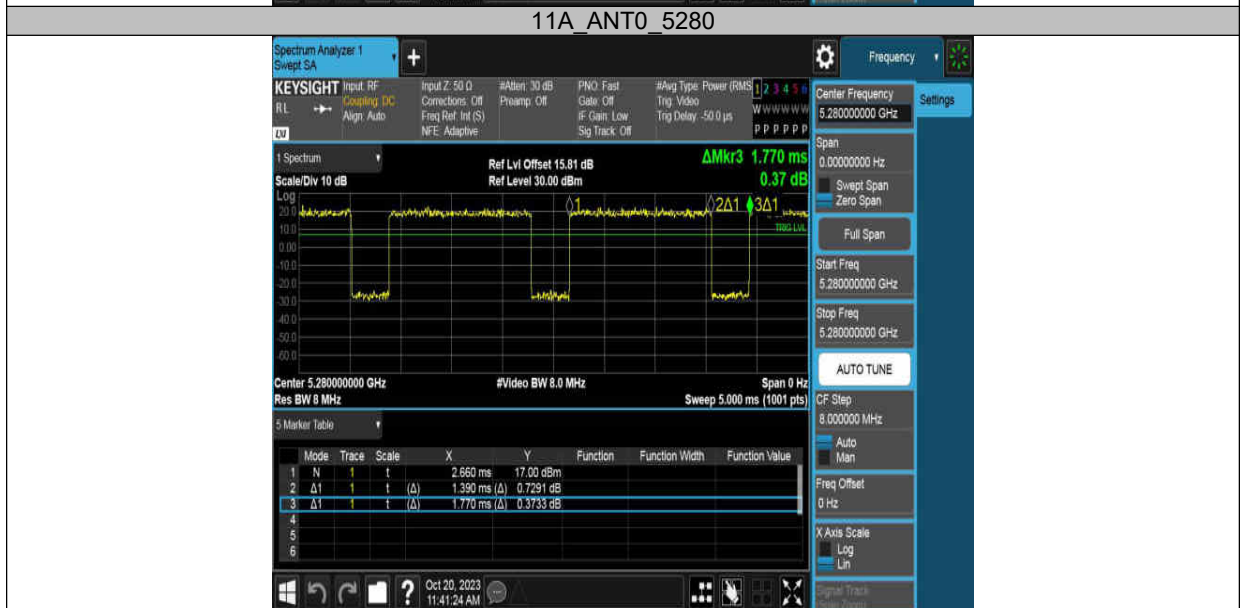





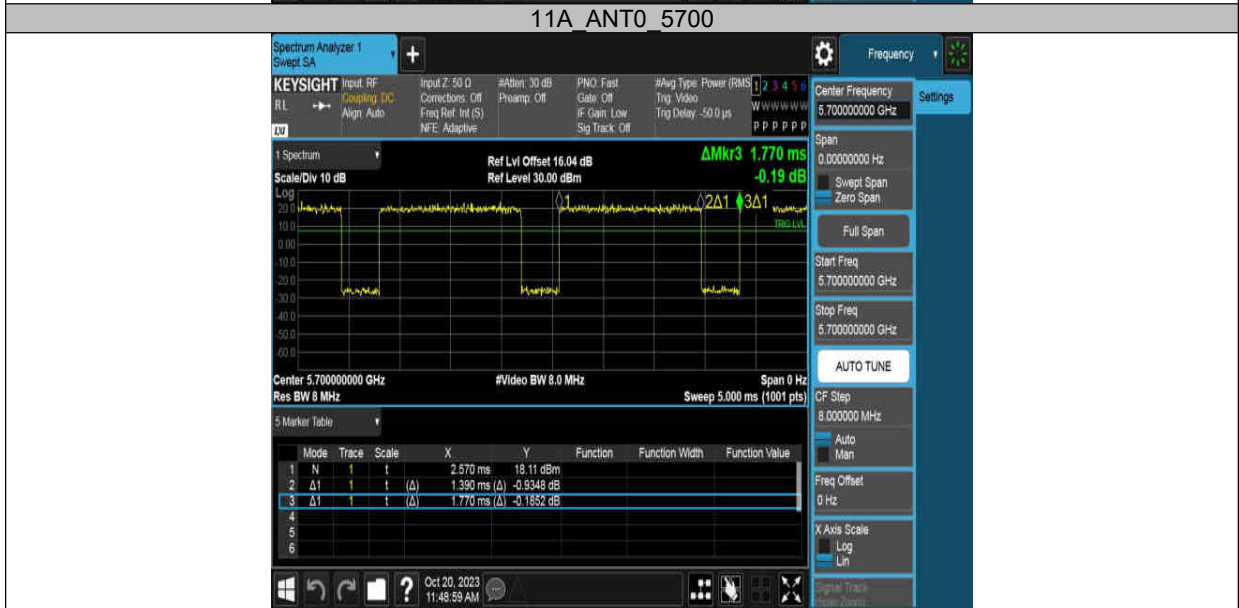

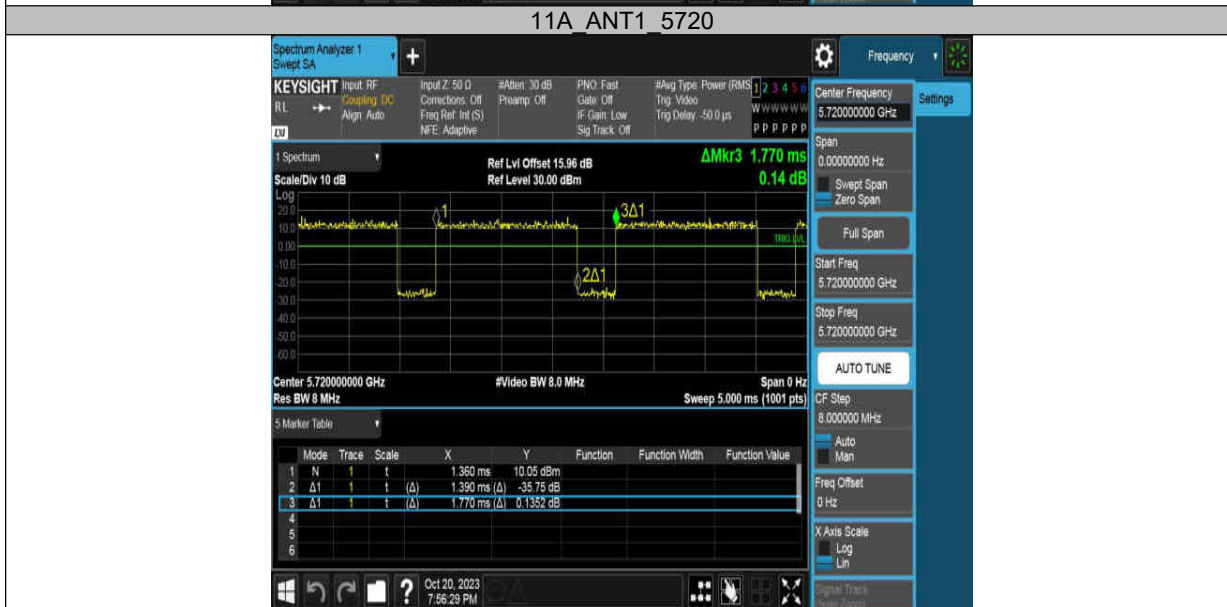
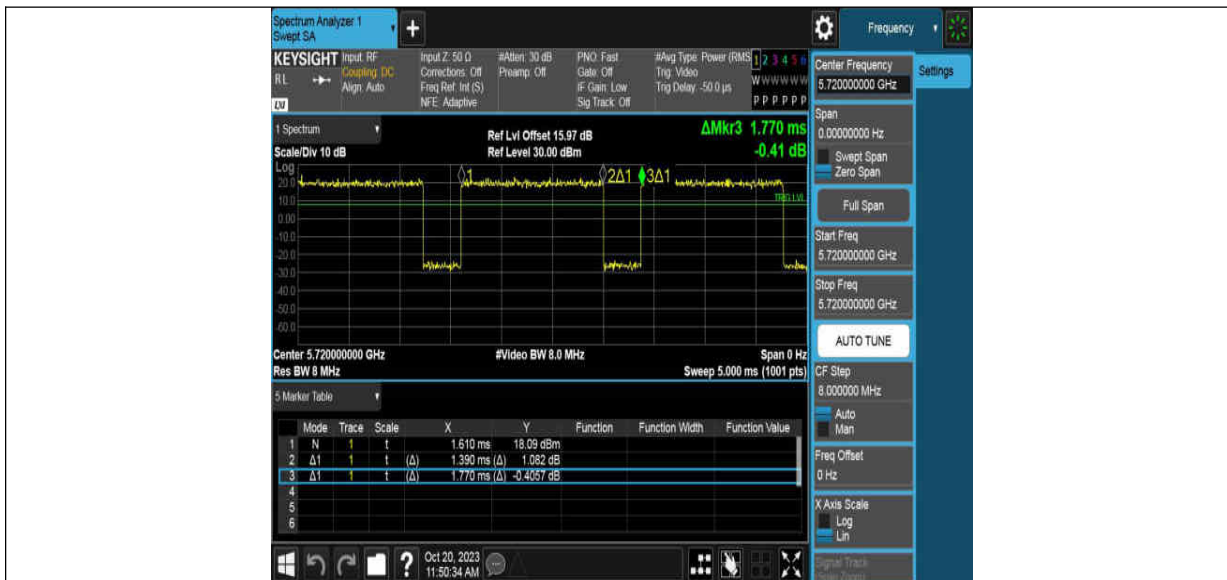



11A ANT0_5785



11A ANT1_5785



11A ANT0_5825





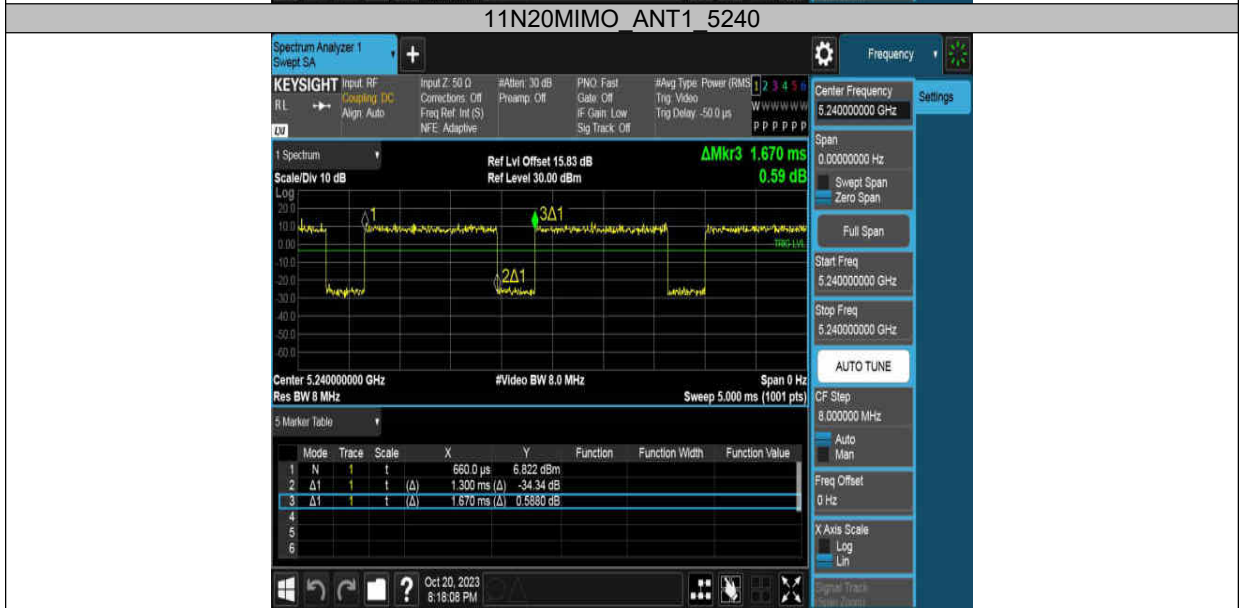

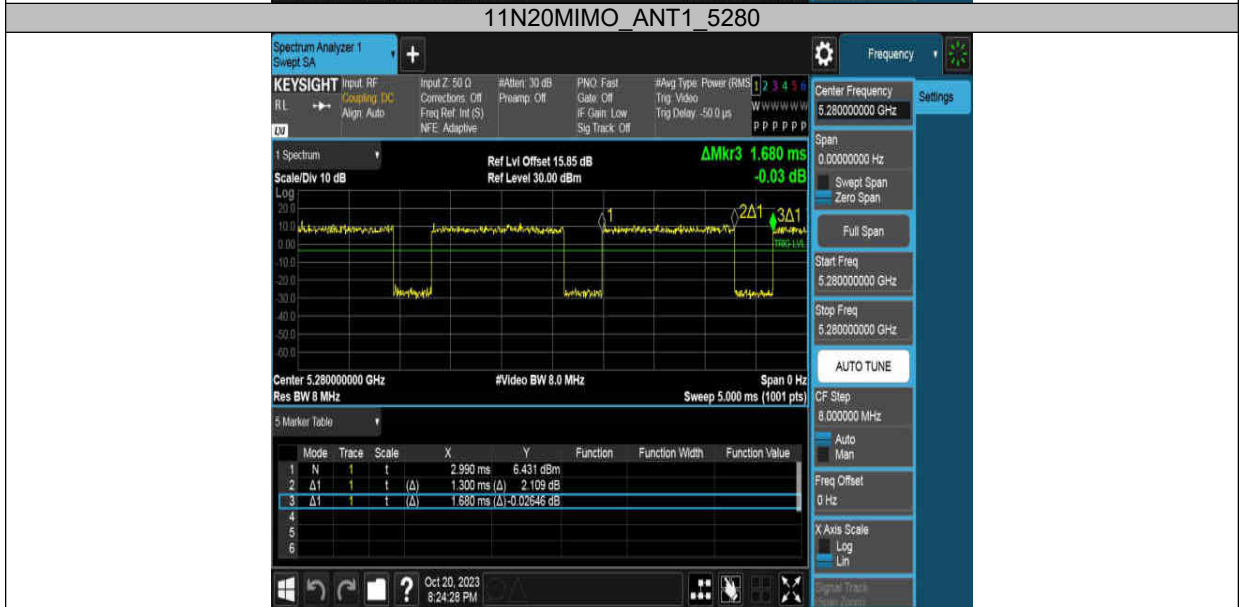

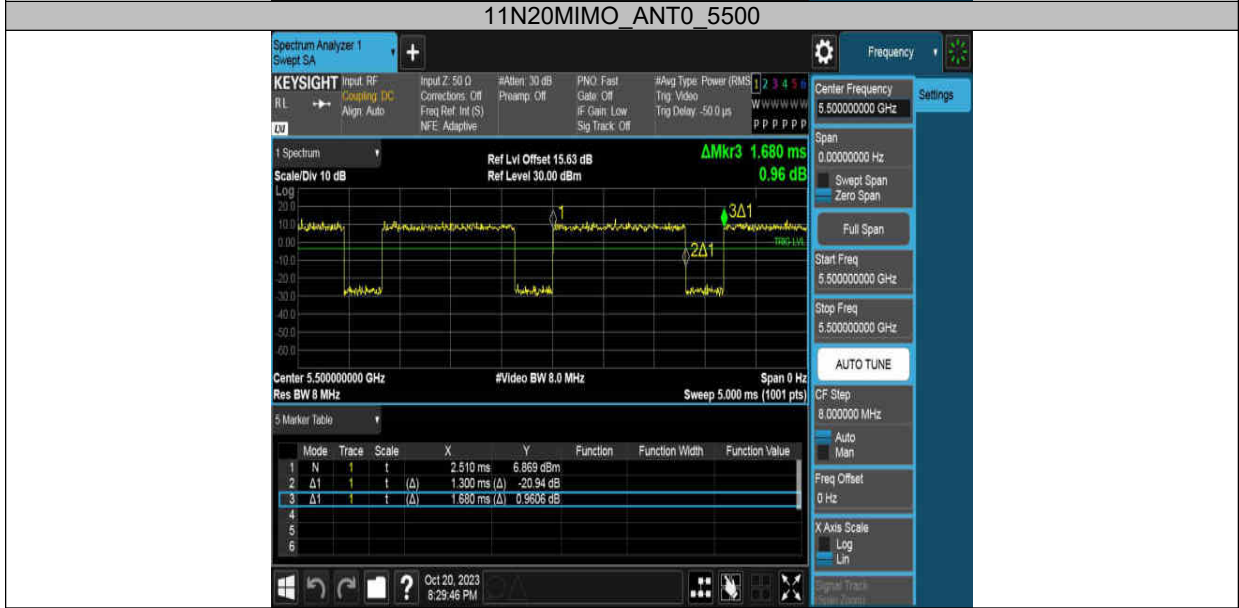
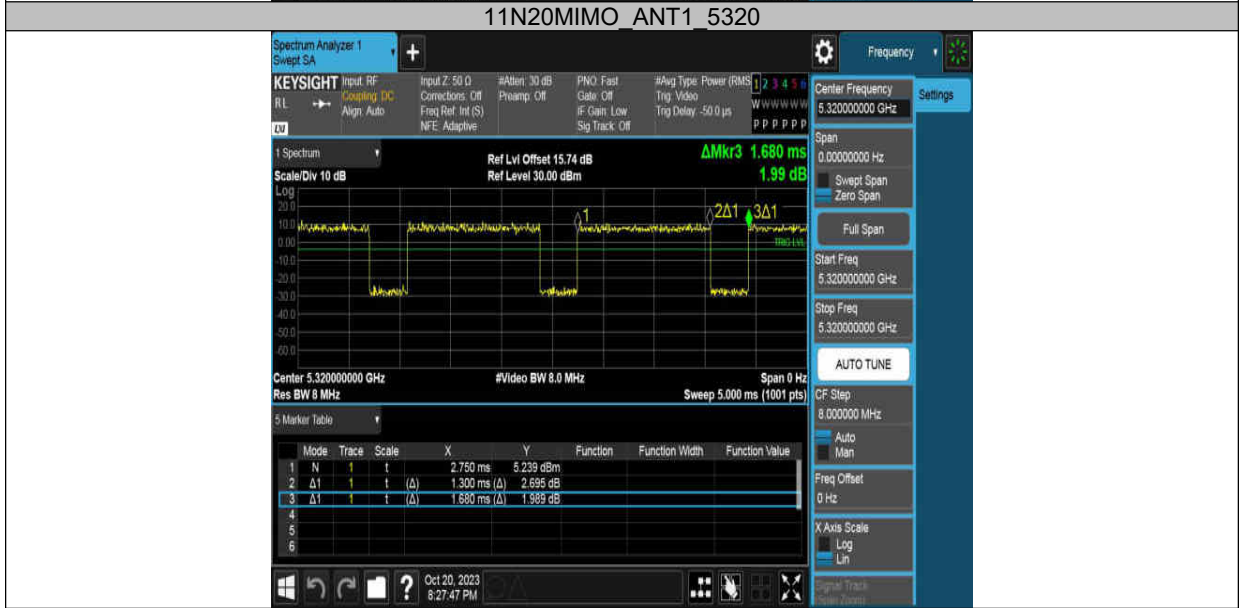

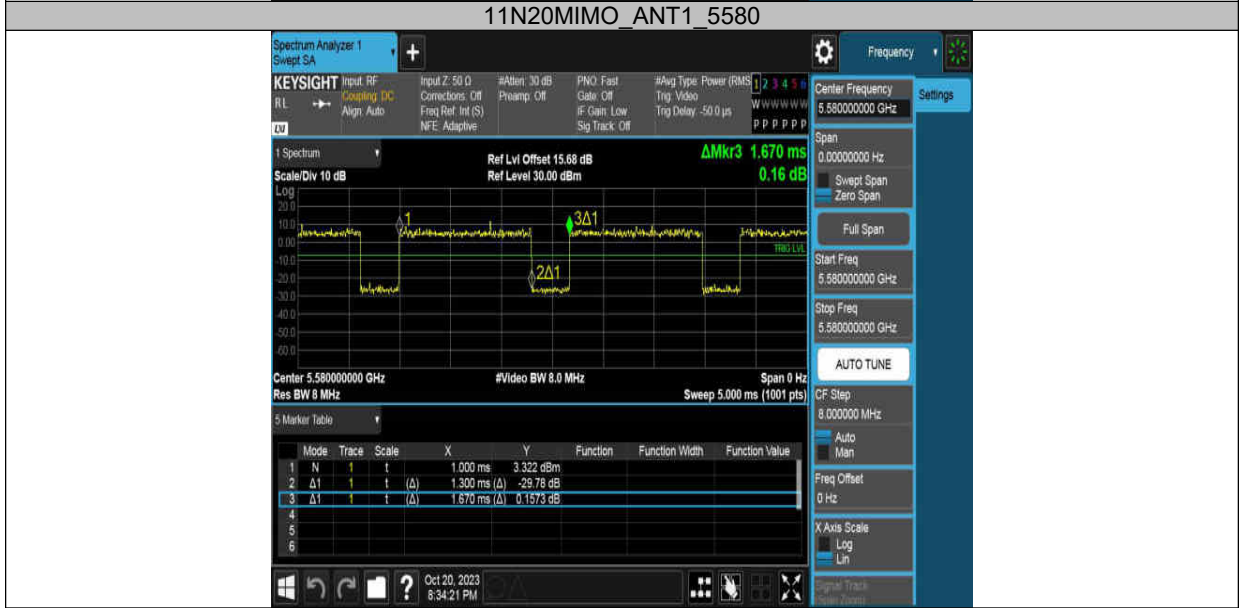

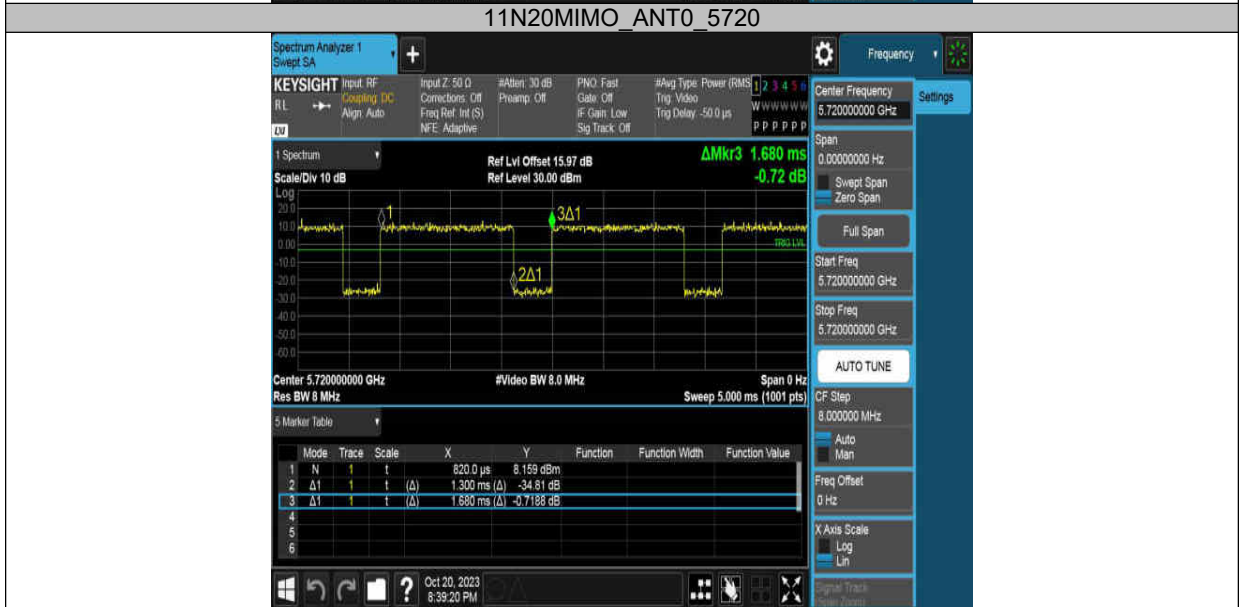
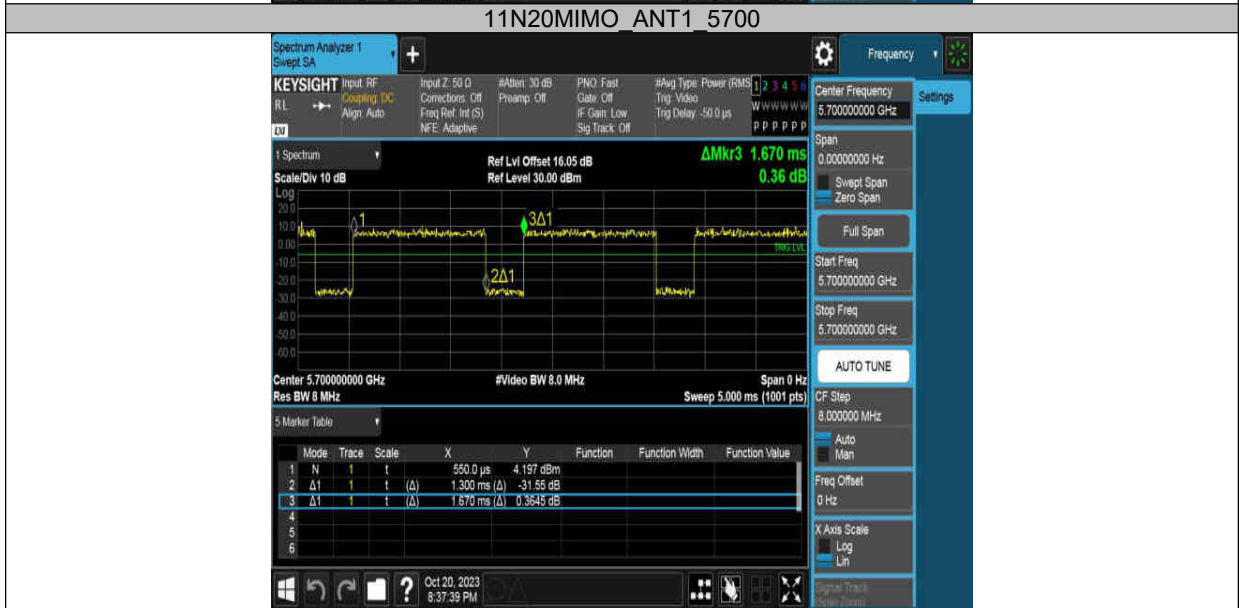

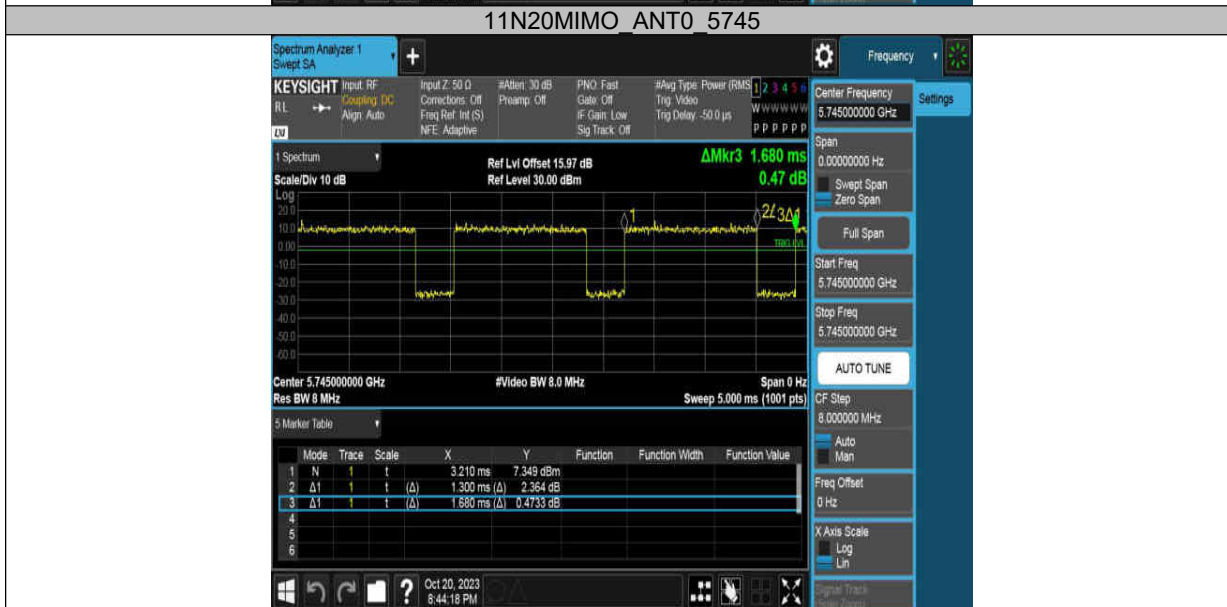



11N20MIMO ANT1_5785



11N20MIMO ANT0_5825



11N20MIMO ANT1_5825

