







## FCC AND ISED CERTIFICATION TEST REPORT

<b>Applicant:</b>	Guangzhou Shikun Electronics Co., Ltd
<b>Address:</b>	NO.6 Liankun Road, Huangpu District, Guangzhou, China
<b>Manufacturer:</b>	Guangzhou Shikun Electronics Co., Ltd
<b>Address:</b>	NO.6 Liankun Road, Huangpu District, Guangzhou, China
<b>Product Description:</b>	IEEE 802.11b/g/n/a/ac/ax 2T2R USB WiFi Module Integrated BT 2.1+EDR/4.2/5.2
<b>Brand Name:</b>	NA
<b>Tested Model:</b>	SKO.WB920TU.3
<b>FCC ID:</b>	2AR82-SKOWB920TU3
<b>IC:</b>	24728-SKOWB920TU3
<b>Report No.:</b>	JCF231017201-001
<b>Received Date:</b>	Oct. 17, 2023
<b>Tested Date:</b>	Oct. 17, 2023 ~ Nov. 07, 2023
<b>Issued Date:</b>	Nov. 07, 2023
<b>Test Standards:</b>	FCC Rules and Regulations Part 15 Subpart C, RSS-247 Issue 3 August 2023
<b>Test Procedure:</b>	ANSI C63.10:2013, RSS-Gen Issue 5 A2, Feb. 2021
<b>Test Result:</b>	Pass
<b>Prepared By:</b>  <u>Roger Li/Engineer</u>	
<b>Date:</b> Nov 07, 2023 	
<b>Reviewed By:</b>  <u>Kennys Zhang/Engineer</u>	
<b>Date:</b> Nov 07, 2023	
<b>Approved By:</b>  <u>Talent Zhang/Engineer</u>	
<b>Date:</b> Nov. 07, 2023	

Note: The test results in this report apply exclusively to the tested model / sample. Without written approval of Guangzhou Jingce Testing Technology Co., Ltd. the test report shall not be reproduced except in full.

**Report Revise Record**

Report Version	Revise Time	Issued Date	Valid Version	Notes
V1.0	/	Nov. 07, 2023	Original Report	/

## TABLE OF CONTENTS

<b>1. Test Report Declare .....</b>	<b>5</b>
<b>2. Summary of Test Results .....</b>	<b>6</b>
<b>3. Test Laboratory .....</b>	<b>6</b>
<b>4. Equipment Under Test .....</b>	<b>7</b>
4.1. Description of EUT .....	7
4.2. Channel List .....	7
4.3. Test Channel Configuration .....	7
4.4. Test environment conditions .....	8
4.5. The Worse Case Power Setting Parameter .....	8
4.6. Description of Available Antennas .....	8
<b>5. Description of Test Setup .....</b>	<b>8</b>
5.1. Accessory .....	8
5.2. Support Equipment .....	8
5.3. Test Setup .....	8
5.4. Setup Diagram for Tests .....	8
<b>6. Measurement Uncertainty .....</b>	<b>9</b>
<b>7. Measuring Instrument and Software Used .....</b>	<b>9</b>
<b>8. On Time and Duty Cycle .....</b>	<b>11</b>
8.1. Block diagram of test setup .....	11
8.2. Limits .....	11
8.3. Procedure .....	11
8.4. Results .....	11
8.5. Original test data .....	12
<b>9. 6 dB DTS Bandwidth and 99 % Bandwidth .....</b>	<b>14</b>
9.1. Block diagram of test setup .....	14
9.2. Limits .....	14
9.3. Test Procedure .....	14
9.4. Results .....	14
9.5. Original test data .....	15
<b>10. Peak Conducted Output Power .....</b>	<b>19</b>
10.1. Block diagram of test setup .....	19
10.2. Limits .....	19
10.3. Test Procedure .....	19
10.4. Results .....	19
10.5. Original test data .....	20
<b>11. Power Spectral Density .....</b>	<b>22</b>
11.1. Block diagram of test setup .....	22
11.2. Limits .....	22
11.3. Test Procedure .....	22
11.4. Results .....	22
11.5. Original test data .....	23
<b>12. Conducted Bandedge and Spurious Emissions .....</b>	<b>25</b>
12.1. Block diagram of test setup .....	25
12.2. Limits .....	25
12.3. Test Procedure .....	25
12.4. Results .....	25
12.5. Original test data .....	27
<b>13. Radiated Emission .....</b>	<b>35</b>
13.1. Block diagram of test setup .....	35
13.2. Limit .....	36
13.3. Test Procedure .....	38
13.4. Results .....	41

- 13.5. Original test data ..... 41
- 14. AC Power Line Conducted Emissions ..... 42**
  - 14.1. Block diagram of test setup ..... 42
  - 14.2. Limits ..... 42
  - 14.3. Test procedure ..... 42
  - 14.4. Test result ..... 43
- 15. Antenna Requirements ..... 44**
  - 15.1. Limits ..... 44
  - 15.2. Result ..... 44
- APPENDIX A – Radiated Emission Below 1GHz Test Data ..... 45**
- APPENDIX B – Radiated Emission Above 1GHz Test Data ..... 47**

## 1. Test Report Declare

<b>Applicant:</b>	Guangzhou Shikun Electronics Co., Ltd
<b>Address:</b>	NO.6 Liankun Road, Huangpu District, Guangzhou, China
<b>Manufacturer:</b>	Guangzhou Shikun Electronics Co., Ltd
<b>Address:</b>	NO.6 Liankun Road, Huangpu District, Guangzhou, China
<b>Product Name:</b>	IEEE 802.11b/g/n/a/ac/ax 2T2R USB WiFi Module Integrated BT 2.1+EDR/4.2/5.2
<b>Brand Name:</b>	NA
<b>Model Name:</b>	SKO.WB920TU.3
<b>Difference Description:</b>	NA

### We Declare:

The equipment described above is tested by Guangzhou Jingce Testing Technology Co., Ltd. and in the configuration tested the equipment complied with the standards specified above. The test results are contained in this test report and Guangzhou Jingce Testing Technology Co., Ltd. is assumed of full responsibility for the accuracy and completeness of these tests.

## 2. Summary of Test Results

Summary of Test Results			
Clause	Test Items	FCC/ISED Rules	Test Results
1	6 dB Bandwidth and 99 % Occupied Bandwidth	FCC Part 15.247 (a) (2) RSS-247 Clause 5.2 (a) ISED RSS-Gen Clause 6.7	Pass
2	Peak Conducted Output Power	FCC Part 15.247 (b) (3) RSS-247 Clause 5.4 (d)	Pass
3	Power Spectral Density	FCC Part 15.247 (e) RSS-247 Clause 5.2 (b)	Pass
4	Conducted Bandedge and Spurious Emission	FCC Part 15.247 (d) RSS-247 Clause 5.5	Pass
5	Radiated Bandedge and Spurious Emission	FCC Part 15.247 (d) FCC Part 15.209 FCC Part 15.205 RSS-247 Clause 5.5 RSS-GEN Clause 8.9	Pass
6	Conducted Emission Test For AC Power Port	FCC Part 15.207 RSS-GEN Clause 8.8	NA
7	Antenna Requirement	FCC Part 15.203 RSS-GEN Clause 6.8	Pass

## 3. Test Laboratory

Guangzhou Jingce Testing Technology Co., Ltd.

Add.: No.192, Kezhu Road, Huangpu District, Guangzhou, Guangdong, China

Association for Laboratory Accreditation(A2LA). Certificate Number: 6594.01

FCC Designation Number: CN1331. Test Firm Registration Number: 360543

IC Test Firm Registration Number: 28796

Conformity Assessment Body identifier: CN0138

## 4. Equipment Under Test

### 4.1. Description of EUT

<b>EUT Name:</b>	IEEE 802.11b/g/n/a/ac/ax 2T2R USB WiFi Module Integrated BT 2.1+EDR/4.2/5.2
<b>Model Number:</b>	SKO.WB920TU.3
<b>EUT Function Description:</b>	Please refer to user manual of this device
<b>Power Supply:</b>	DC 5V+/-0.3
<b>Hardware Version:</b>	NA
<b>Software Version:</b>	NA
<b>Radio Specification:</b>	Bluetooth V5.2
<b>Operation Frequency:</b>	2402 MHz - 2480 MHz
<b>Modulation:</b>	GFSK
<b>Data Rate:</b>	1Mbps, 2Mbps,
<b>Antenna Type:</b>	PCB Antenna, MAX. Gain: 1.81 dBi

Note 1: EUT is the ab. of equipment under test.

Note 2: The antenna gain is declared by the customer and the laboratory is not responsible for the accuracy of the antenna gain.

### 4.2. Channel List

Channel	Frequency (MHz)	Channel	Frequency (MHz)	Channel	Frequency (MHz)	Channel	Frequency (MHz)
0	2402	11	2424	22	2446	33	2468
1	2404	12	2426	23	2448	34	2470
2	2406	13	2428	24	2450	35	2472
3	2408	14	2430	25	2452	36	2474
4	2410	15	2432	26	2454	37	2476
5	2412	16	2434	27	2456	38	2478
6	2414	17	2436	28	2458	39	2480
7	2416	18	2438	29	2460	/	/
8	2418	19	2440	30	2462	/	/
9	2420	20	2442	31	2464	/	/
10	2422	21	2444	32	2468	/	/

### 4.3. Test Channel Configuration

Tested mode, channel, information		
Mode	Channel	Frequency (MHz)
GFSK	LCH:CH0	2402
	MCH:CH19	2440
	HCH:CH39	2480

#### 4.4. Test environment conditions

During the measurement the environmental conditions were within the listed ranges:

Temperature range:	21-25 °C
Humidity range:	40-75%
Pressure range:	86-106 kPa

#### 4.5. The Worse Case Power Setting Parameter

The Worse Case Power Setting Parameter under 2400 ~ 2483.5MHz Band				
Test Software		WCN_Combo_Tool		
Modulation Type	Transmit Antenna Number	Test Software Setting Value		
		CH 00	CH 39	CH 78
GFSK 1MHz	1	Default	Default	Default
GFSK 2MHz	1	Default	Default	Default

#### 4.6. Description of Available Antennas

Test Mode	Transmit and Receive Mode	Description
GFSK	<input checked="" type="checkbox"/> 1TX, 1RX	Antenna 1 can be used as transmitting/receiving antenna.

### 5. Description of Test Setup

#### 5.1. Accessory

Description of Accessories	Manufacturer	Model Number	Description	Remark
N/A	N/A	N/A	N/A	N/A

#### 5.2. Support Equipment

Equipment	Brand Name	Model Name	P/N
PC	Lenovo	T480	/

#### 5.3. Test Setup

The EUT can work in Fixed Frequency mode.

#### 5.4. Setup Diagram for Tests





## 6. Measurement Uncertainty

Where relevant, the following measurement uncertainty levels have been estimated for tests performed on the apparatus:

Test Item	Uncertainty
AC Power Conduction emission	1.37 dB
All Radiated emissions	5.4dB
Conducted emissions	3.09 dB
Occupied Channel Bandwidth	1.1%
Conducted Output power	0.82dB
Power Spectral Density	0.82dB

Note: This uncertainty represents an expanded uncertainty expressed at approximately the 95 % confidence level using a coverage factor of  $k = 2$ .

## 7. Measuring Instrument and Software Used

TS Test System						
Used	Equipment	Manufacturer	Model No.	Serial No.	Last Cal.	Due. Date
<input checked="" type="checkbox"/>	Spectrum Analyzer	Keysight	N9030B	MY56320512	Sep. 12, 2023	Sep. 11, 2024
<input checked="" type="checkbox"/>	Vector Signal Generator	Keysight	N5182B	MY57300334	Sep. 12, 2023	Sep. 11, 2024
<input checked="" type="checkbox"/>	Signal Generator	Keysight	N5171B	MY57280639	Sep. 12, 2023	Sep. 11, 2024
<input checked="" type="checkbox"/>	DC POWER	Keysight	E342A	MY59020356	Jul. 14, 2023	Jul. 13, 2024
<input checked="" type="checkbox"/>	Incubator thermometer	GWS	EL-02JA	21107288	Sep. 12, 2023	Sep. 11, 2024
<input checked="" type="checkbox"/>	Control unit(Power sensor)	Tonscend	JS0806-2	/	Sep. 12, 2023	Sep. 11, 2024
<input checked="" type="checkbox"/>	Wideband radio communication tester	R&S	CMW500	163478	Jul. 11, 2023	Jul. 10, 2024
Software						
Used	Description	Manufacturer	Name		Version	
<input checked="" type="checkbox"/>	Test software	TS+	JS1120-3		V3.3.10	
RSE Test System						
Used	Equipment	Manufacturer	Model No.	Serial No.	Last Cal.	Due. Date
<input checked="" type="checkbox"/>	EMI Receiver	R&S	ESW	101685	Jul. 12, 2023	Jul. 11, 2024
<input checked="" type="checkbox"/>	Bilog Antenna	Schwarzbeck	VULB 9163	01416	Mar. 21, 2023	Mar. 20, 2024
<input checked="" type="checkbox"/>	Horn Antenna 1	Schwarzbeck	BBHA 9120 D	02411	May. 25, 2023	May. 24, 2024
<input checked="" type="checkbox"/>	Horn Antenna 2	ETS	BBHA 9170	1090	Sep. 04, 2023	Sep. 03, 2024
<input checked="" type="checkbox"/>	loop-antenna	Schwarzbeck	FMZB 1513-60	00030	Jan.14,2023	Jan.13,2024
<input checked="" type="checkbox"/>	Signal Pre-Amplifier	Tonscend	TAP01018050	AP21C806122	Jul. 10, 2023	Jul. 09, 2024
<input checked="" type="checkbox"/>	Signal Pre-Amplifier	Tonscend	TAP9K3G32	AP20K806104	Jul. 10, 2023	Jul. 09, 2024

<input checked="" type="checkbox"/>	Signal Pre-Amplifier	ETS	3116C-PA	00217677	Aug. 24, 2023	Aug. 23, 2024
<input checked="" type="checkbox"/>	3m Fully-anechoic Chamber	ETS	RFD-100	/	Apr. 24, 2021	Apr. 23, 2024
<input checked="" type="checkbox"/>	Temperature & Humidity	Temperature	HTC-1	/	Nov. 25, 2022	Nov. 24, 2023
Software						
Used	Description	Manufacturer	Name		Version	
<input checked="" type="checkbox"/>	Test software	TS+	TS+		V3.0.0.4	

## 8. On Time and Duty Cycle

### 8.1. Block diagram of test setup

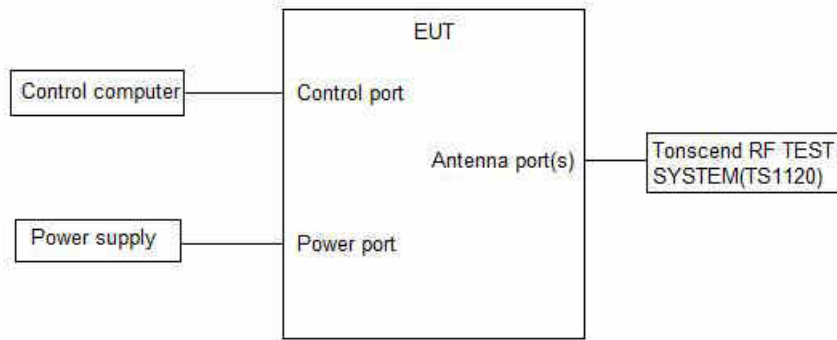

### 8.2. Limits

None; for reporting purposes only

### 8.3. Procedure

KDB 558074 Zero-Span Spectrum Analyzer Method

### 8.4. Results

Test Mode	Ant.	Freq. (MHz)	ON Time (ms)	Period (ms)	Duty Cycle (%)	Duty Cycle Factor(dB)
BLE_1M	Ant1	2402	2.13	2.50	85.20	0.70
		2440	2.13	2.50	85.20	0.70
		2480	2.13	2.50	85.20	0.70
BLE_2M	Ant1	2402	1.07	1.87	57.22	2.42
		2440	1.07	1.87	57.22	2.42
		2480	1.07	1.87	57.22	2.42

Note: Duty Cycle Correction Factor =  $10\log(1/x)$ .

Where: x is Duty Cycle(Linear)

Where: T is On Time (transmit duration)

If that calculated VBW is not available on the analyzer, then the next higher value should be used.

8.5. Original test data



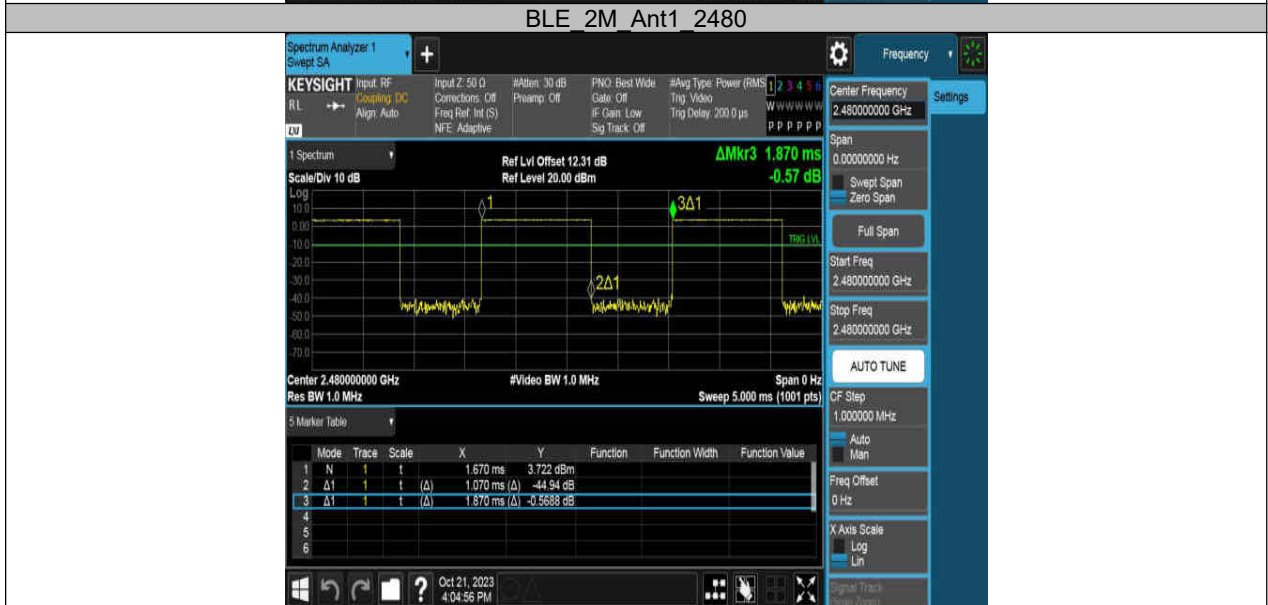

## 9. 6 dB DTS Bandwidth and 99 % Bandwidth

### 9.1. Block diagram of test setup

Same as section 8.1

### 9.2. Limits

CFR 47FCC Part15 (15.247) Subpart C ISED RSS-247 ISSUE 3			
Section	Test Item	Limit	Frequency Range (MHz)
CFR 47 FCC 15.247(a)(2) ISED RSS-247 5.2 (a)	6 dB Bandwidth	>= 500 kHz	2400-2483.5
ISED RSS-Gen Clause 6.7	99 % Occupied Bandwidth	For reporting purposes only.	2400-2483.5

### 9.3. Test Procedure

Connect the UUT to the spectrum analyzer and use the following settings:

Center Frequency	The center frequency of the channel under test
Detector	Peak
RBW	For 6 dB Bandwidth :100 kHz For 99 % Occupied Bandwidth :1 % to 5 % of the occupied bandwidth
VBW	For 6 dB Bandwidth : $\geq 3 \times$ RBW For 99 % Occupied Bandwidth : $\geq 3 \times$ RBW
Trace	Max hold
Sweep	Auto couple

Allow the trace to stabilize and measure the maximum width of the emission that is constrained by the frequencies associated with the two outermost amplitude points (upper and lower frequencies) that are attenuated by 6 dB/99 % relative to the maximum level measured in the fundamental emission.

### 9.4. Results

Test Mode	Ant.	Freq. (MHz)	DTS BW (MHz)	FL (MHz)	FH (MHz)	Limit (MHz)	Verdict
BLE_1M	Ant1	2402	0.672	2401.676	2402.348	0.5	PASS
		2440	0.704	2439.652	2440.356	0.5	PASS
		2480	0.708	2479.648	2480.356	0.5	PASS
BLE_2M	Ant1	2402	1.212	2401.380	2402.592	0.5	PASS
		2440	1.072	2439.540	2440.612	0.5	PASS
		2480	1.304	2479.348	2480.652	0.5	PASS

Test Mode	Antenna	Frequency (MHz)	OCB (MHz)	FL(MHz)	FH(MHz)	Limit(MHz)	Verdict
BLE_1M	Ant1	2402	1.0395	2401.4920	2402.5315	---	---
		2440	1.0496	2439.4875	2440.5371	---	---
		2480	1.0567	2479.4832	2480.5399	---	---
BLE_2M	Ant1	2402	2.0693	2400.9870	2403.0563	---	---
		2440	2.0707	2438.9890	2441.0597	---	---
		2480	2.0703	2478.9810	2481.0513	---	---

### 9.5. Original test data

6 dB bandwidth:





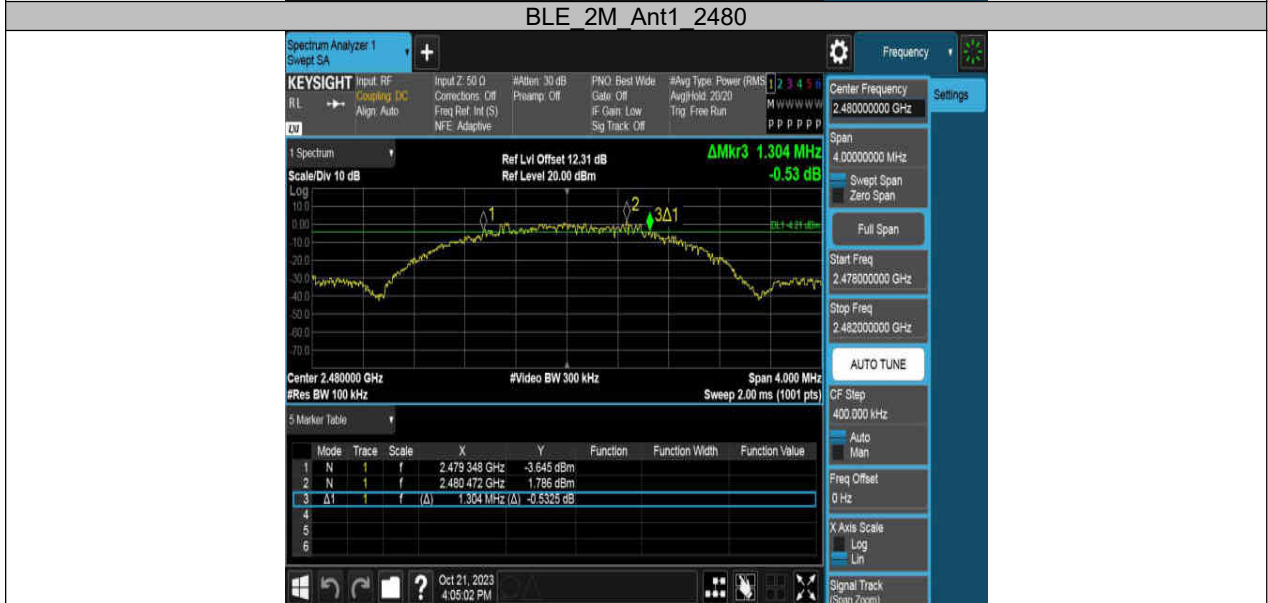
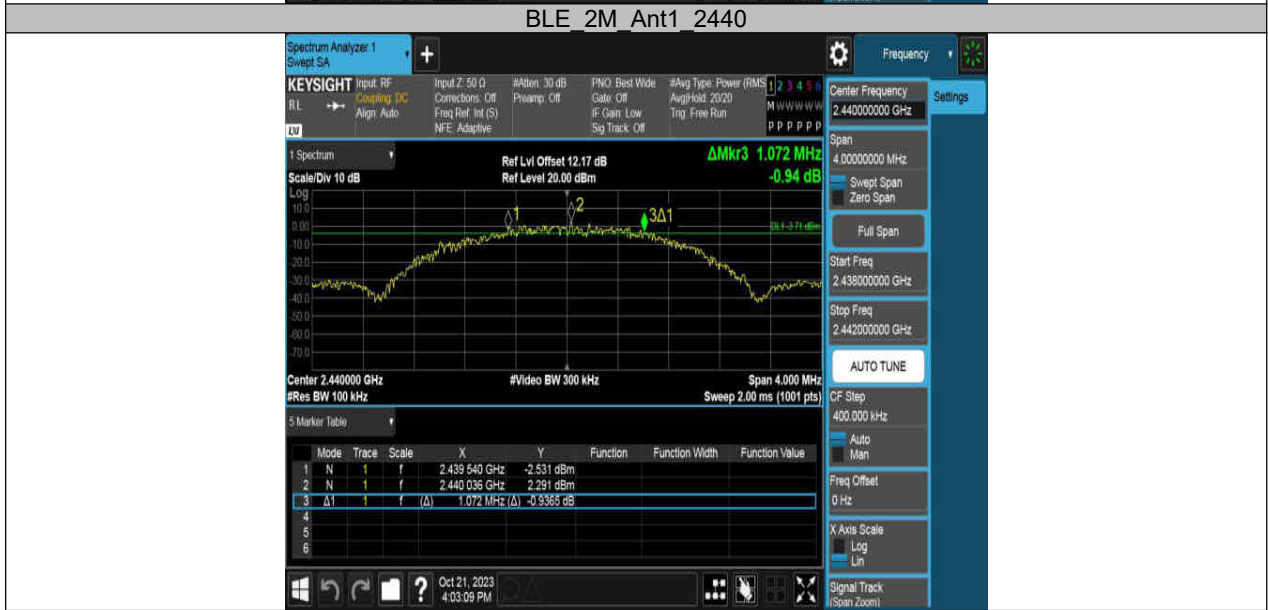



99% bandwidth



BLE\_2M\_Ant1\_2402

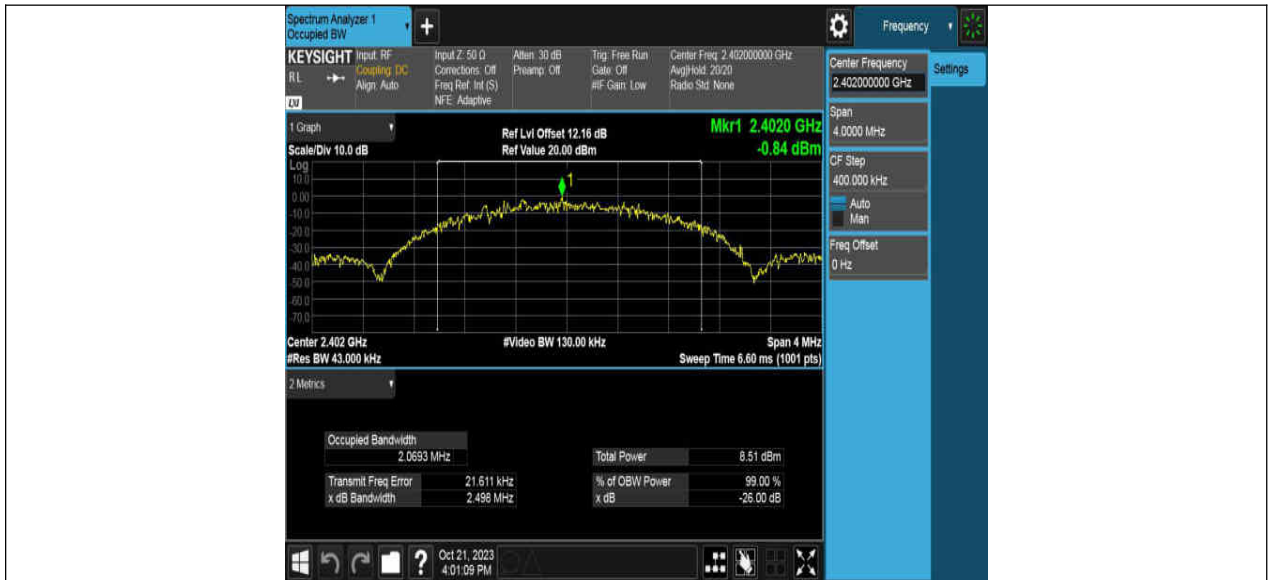

## 10. Peak Conducted Output Power

### 10.1. Block diagram of test setup

Same as section 8.1

### 10.2. Limits

CFR 47 FCC Part15 (15.247) Subpart C ISED RSS-247 ISSUE 3			
Section	Test Item	Limit	Frequency Range (MHz)
CFR 47 FCC 15.247(b)(3) ISED RSS-247 5.4 (d)	Peak Output Power	1 watt or 30 dBm	2400 - 2483.5

### 10.3. Test Procedure

Connect EUT's antenna output to spectrum analyzer by RF cable.

99% Bandwidth set the spectrum analyzer as follows:

RBW:	30 kHz
VBW:	100 kHz
Detector Mode:	Peak
Sweep time:	auto
Trace mode	Max hold

6 dB Bandwidth set the spectrum analyzer as follows:

RBW:	100 kHz
VBW:	300 kHz
Detector Mode:	Peak
Sweep time:	auto
Trace mode	Max hold

Allow the trace to stabilize, measure the 6 dB and 99% bandwidth of signal.

### 10.4. Results

Test Mode	Ant.	Freq (MHz)	Conducted Peak Power (dBm)	Conducted Limit (dBm)	EIRP (dBm)	EIRP Limit (dBm)	Verdict
BLE_1M	Ant1	2402	4.16	≤30	5.97	≤36	PASS
		2440	4.45	≤30	6.26	≤36	PASS
		2480	4.39	≤30	6.20	≤36	PASS
BLE_2M	Ant1	2402	4.19	≤30	6.00	≤36	PASS
		2440	4.52	≤30	6.33	≤36	PASS
		2480	4.42	≤30	6.23	≤36	PASS

### 10.5. Original test data

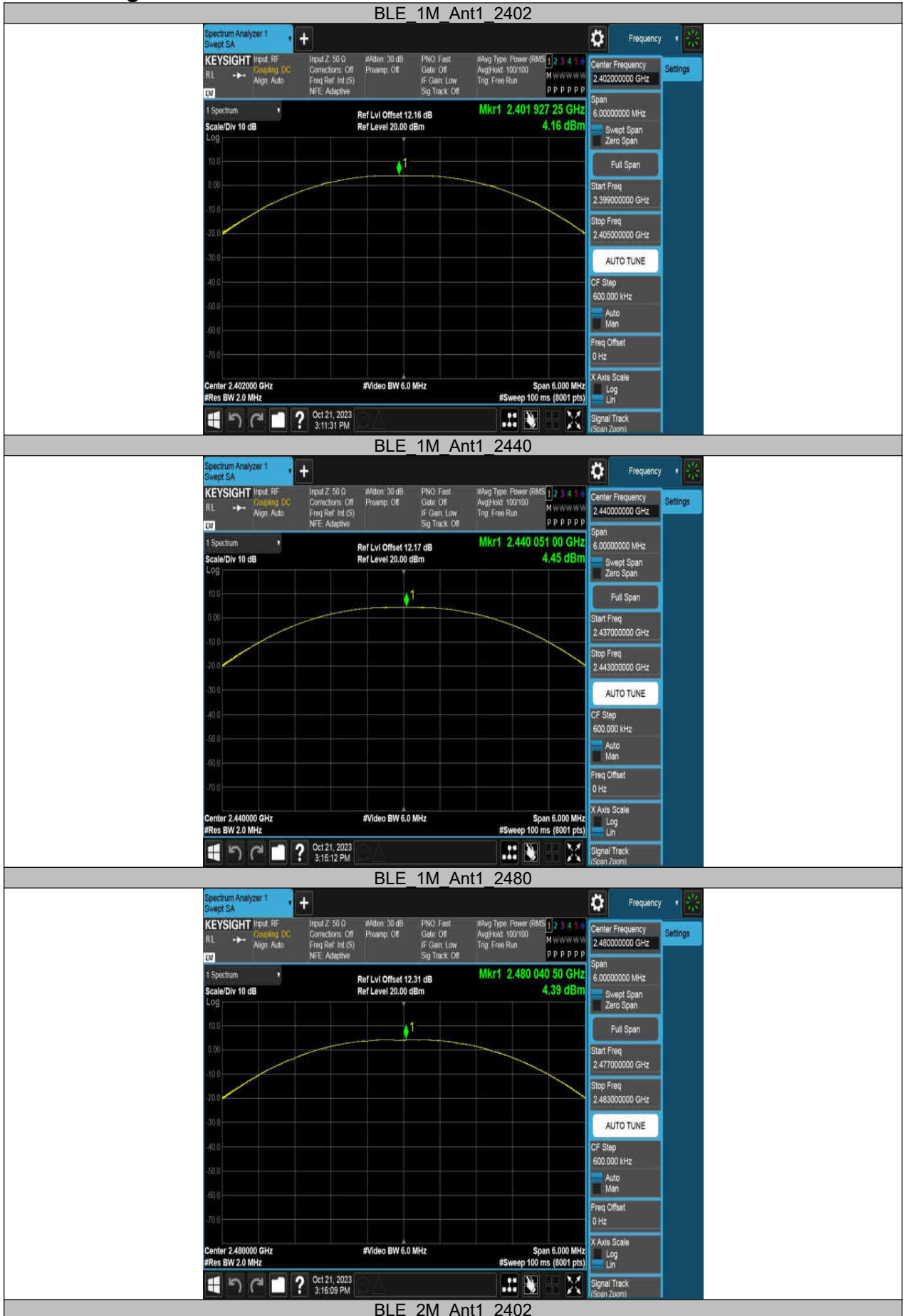

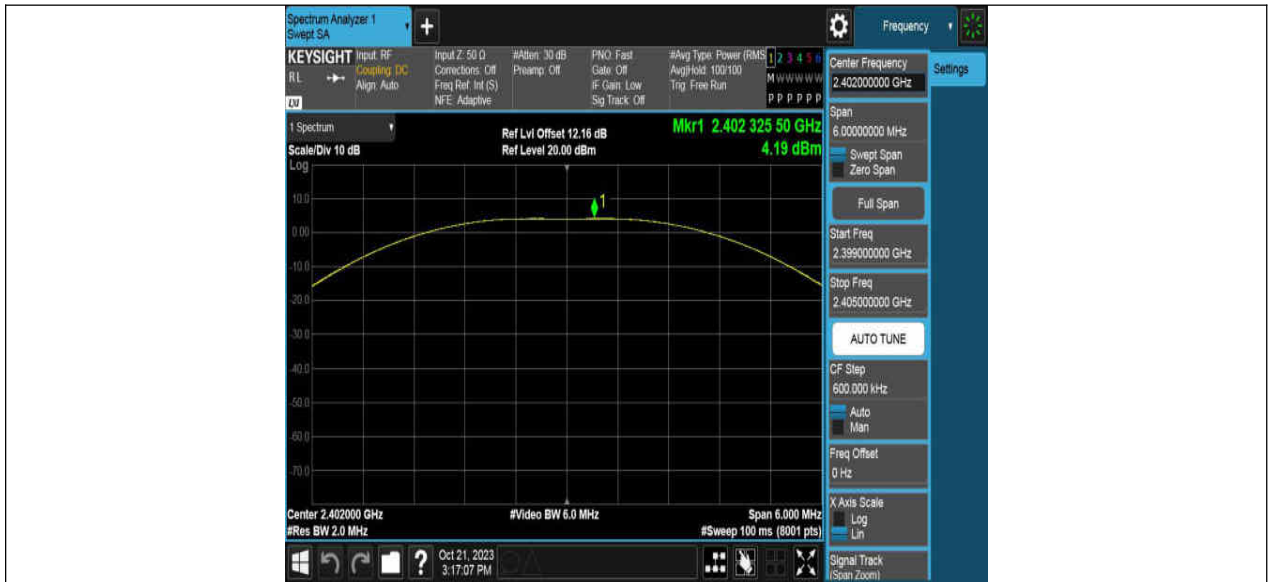

## 11. Power Spectral Density

### 11.1. Block diagram of test setup

Same as section 8.1

### 11.2. Limits

CFR 47 FCC Part15 (15.247) Subpart C ISED RSS-247 ISSUE 3			
Section	Test Item	Limit	Frequency Range (MHz)
CFR 47 FCC §15.247 (e) ISED RSS-247 5.2 (b)	Power Spectral Density	8 dBm in any 3 kHz band	2400 - 2483.5

### 11.3. Test Procedure

Connect the UUT to the spectrum analyzer and use the following settings:

Center Frequency	The center frequency of the channel under test
Detector	Peak
RBW	$3 \text{ kHz} \leq \text{RBW} \leq 100 \text{ kHz}$
VBW	$\geq 3 \times \text{RBW}$
Span	1.5 x DTS bandwidth
Trace	Max hold
Sweep time	Auto couple.

Allow trace to fully stabilize and use the peak marker function to determine the maximum amplitude level within the RBW.

If measured value exceeds limit, reduce RBW (no less than 3 kHz) and repeat.

### 11.4. Results

Test Mode	Ant.	Freq. (MHz)	Result (dBm/3kHz)	Limit (dBm/3kHz)	Verdict
BLE_1M	Ant1	2402	-12.77	$\leq 8.00$	PASS
		2440	-12.63	$\leq 8.00$	PASS
		2480	-12.79	$\leq 8.00$	PASS
BLE_2M	Ant1	2402	-14.70	$\leq 8.00$	PASS
		2440	-14.61	$\leq 8.00$	PASS
		2480	-14.70	$\leq 8.00$	PASS



### 11.5. Original test data







## 12. Conducted Bandedge and Spurious Emissions

### 12.1. Block diagram of test setup

Same as section 8.1

### 12.2. Limits

CFR 47 FCC Part15 (15.247) Subpart C ISED RSS-247 ISSUE 3		
Section	Test Item	Limit
CFR 47 FCC §15.247 (d) ISED RSS-247 5.5	Conducted Band edge and Spurious Emissions	at least 20 dB below that in the 100 kHz bandwidth within the band that contains the highest level of the desired power

### 12.3. Test Procedure

Center Frequency	The center frequency of the channel under test
Detector	Peak
RBW	100 kHz
VBW	$\geq 3 \times \text{RBW}$
Span	$\geq 1.5 \times \text{DTS bandwidth}$
Trace	Max hold
Sweep time	Auto couple

Connect the UUT to the spectrum analyzer and use the following settings:

Use the peak marker function to determine the maximum peak power level to establish the reference level.

Span	Set the center frequency and span to encompass frequency range to be measured
Detector	Peak
RBW	100 kHz
VBW	$\geq 3 \times \text{RBW}$
measurement points	$\geq \text{span}/\text{RBW}$
Trace	Max hold
Sweep time	Auto couple

Use the peak marker function to determine the maximum amplitude level.

### 12.4. Results

Band edge

Test Mode	Ant.	Ch Name	Freq. (MHz)	Ref Level (dBm)	Result (dBm)	Limit (dBm)	Verdict
BLE_1M	Ant1	Low	2402	3.97	-48.06	$\leq -16.03$	PASS
		High	2480	4.01	-48.22	$\leq -15.99$	PASS
BLE_2M	Ant1	Low	2402	2.89	-30.93	$\leq -17.11$	PASS
		High	2480	2.89	-48.7	$\leq -17.11$	PASS

## Spurious Emissions

Test Mode	Ant.	Freq. (MHz)	Freq Range (MHz)	Ref Level (dBm)	Result (dBm)	Limit (dBm)	Verdict
BLE_1M	Ant1	2402	30~1000	3.97	-59.98	≤-16.03	PASS
			1000~26500	3.97	-51.03	≤-16.03	PASS
		2440	30~1000	4.15	-59.92	≤-15.85	PASS
			1000~26500	4.15	-51.46	≤-15.85	PASS
		2480	30~1000	4.01	-60.87	≤-15.99	PASS
			1000~26500	4.01	-50.65	≤-15.99	PASS
BLE_2M	Ant1	2402	30~1000	2.89	-60.81	≤-17.11	PASS
			1000~26500	2.89	-51.16	≤-17.11	PASS
		2440	30~1000	2.72	-60.78	≤-17.28	PASS
			1000~26500	2.72	-50.78	≤-17.28	PASS
		2480	30~1000	2.89	-60.48	≤-17.11	PASS
			1000~26500	2.89	-51.25	≤-17.11	PASS

### 12.5. Original test data

Reference level





Band edge:

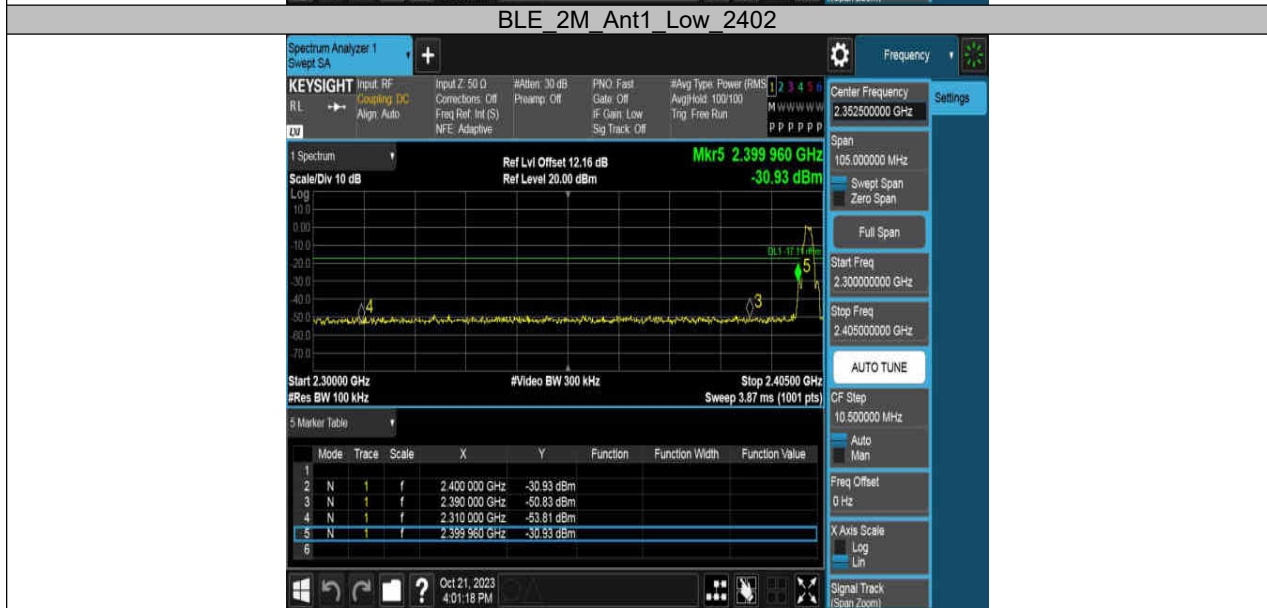
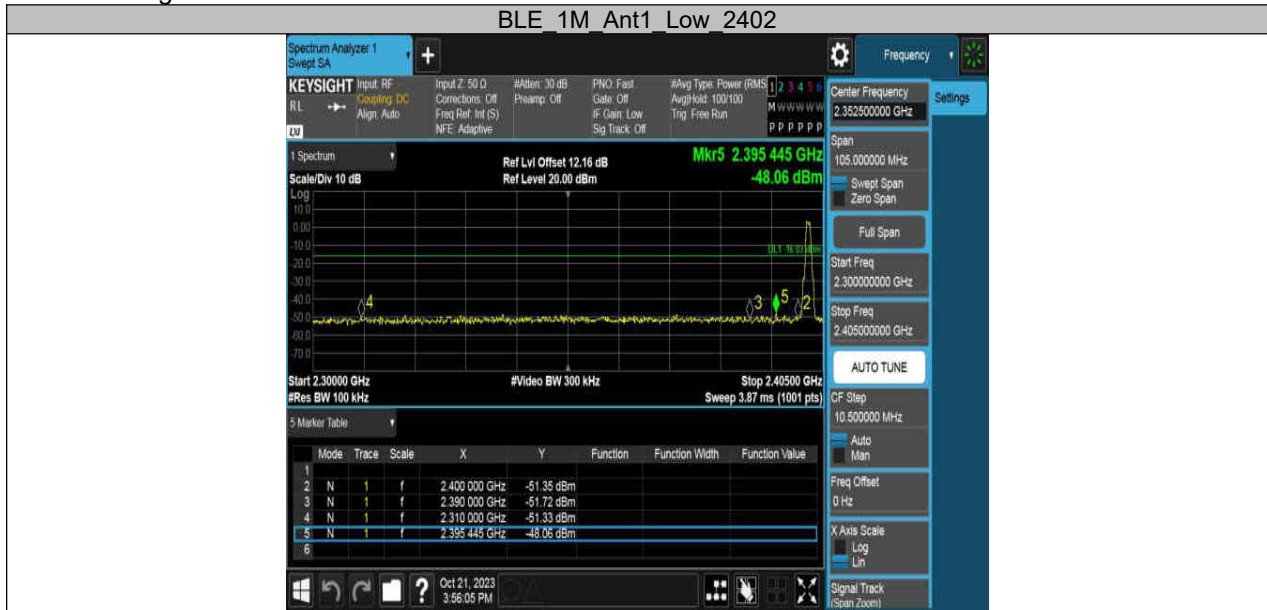





Spurious Emissions:

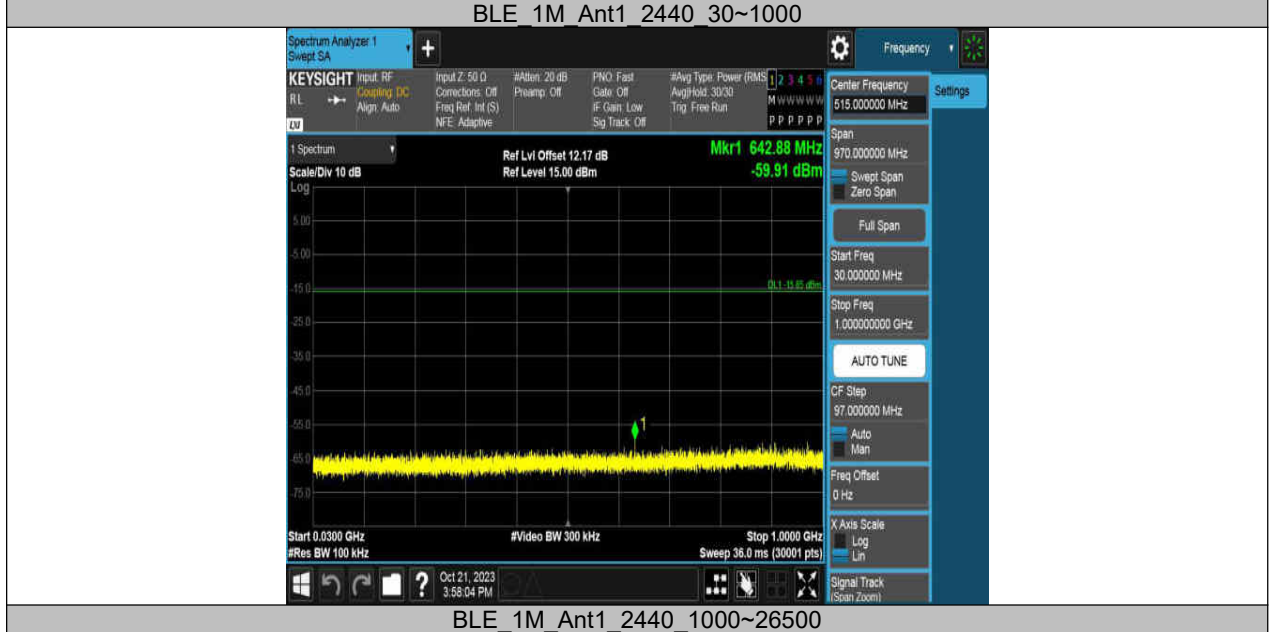
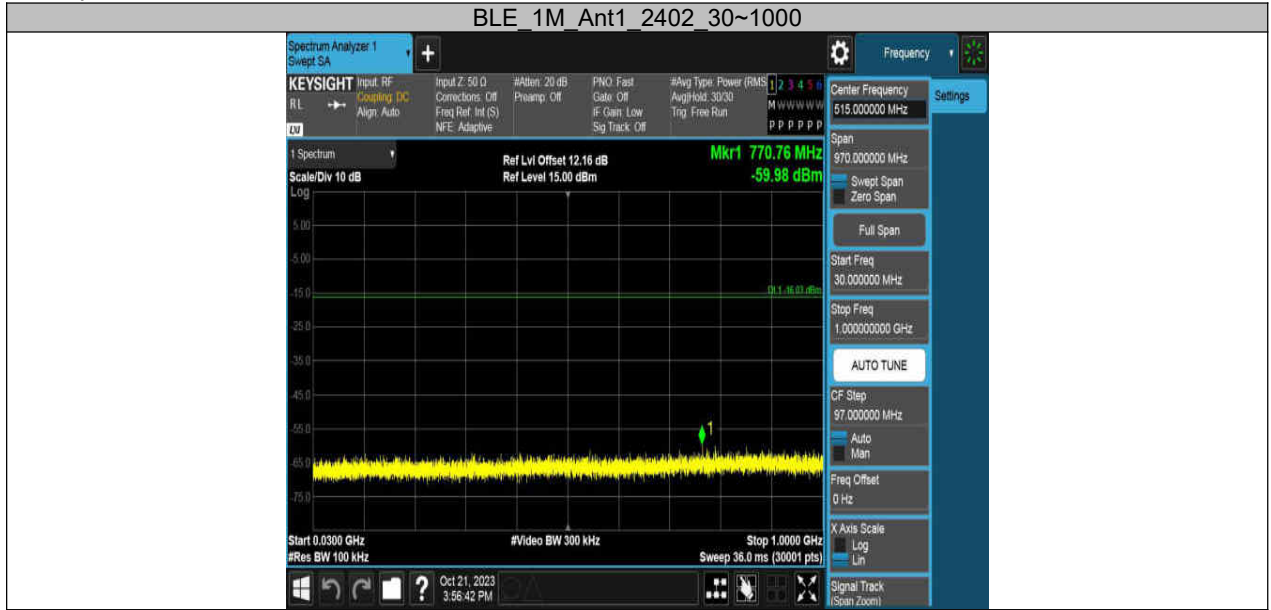



BLE 1M Ant1 2480 30~1000



BLE 1M Ant1 2480 1000~26500



BLE 2M Ant1 2402 30~1000



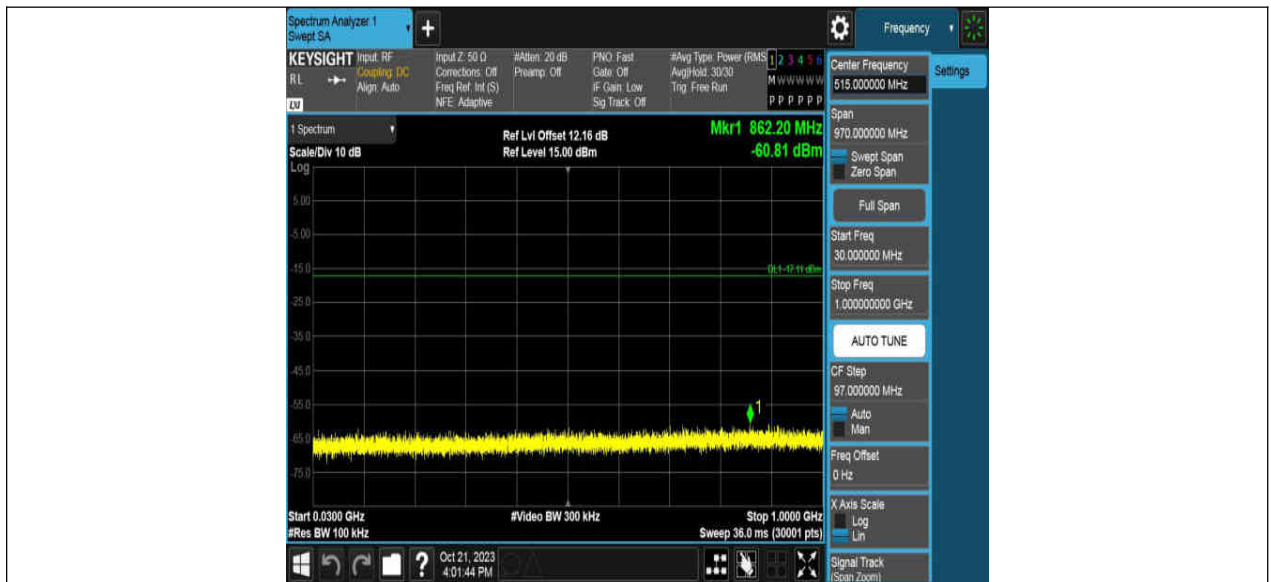

BLE 2M Ant1 2402 1000~26500



BLE 2M Ant1 2440 30~1000



BLE 2M Ant1 2440 1000~26500

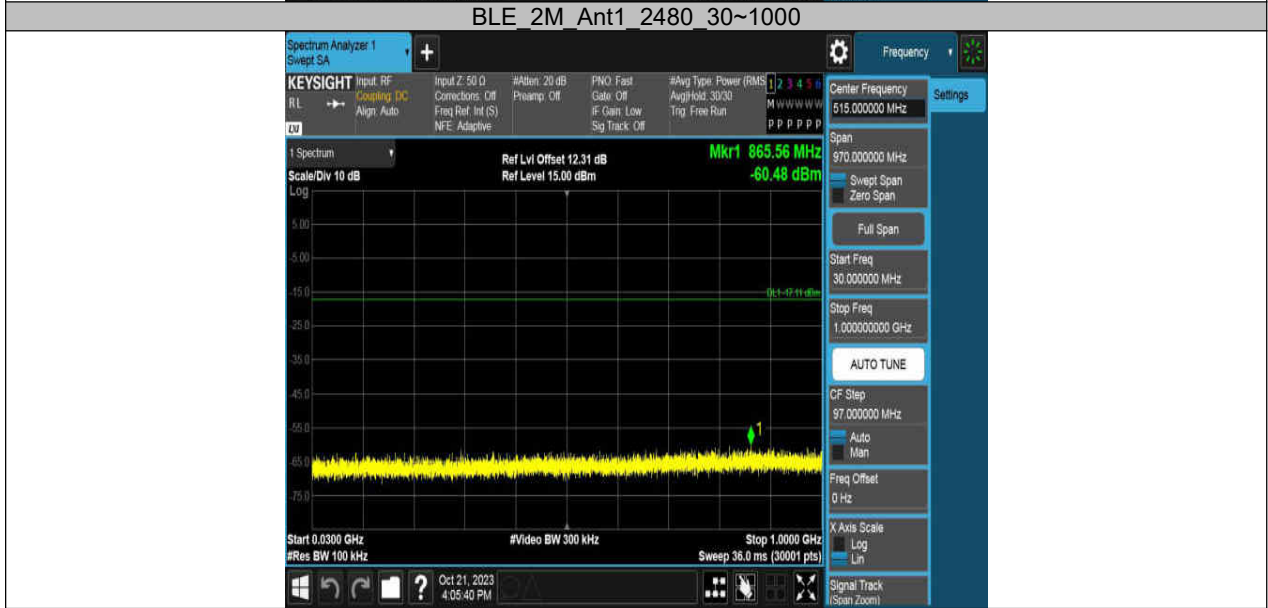
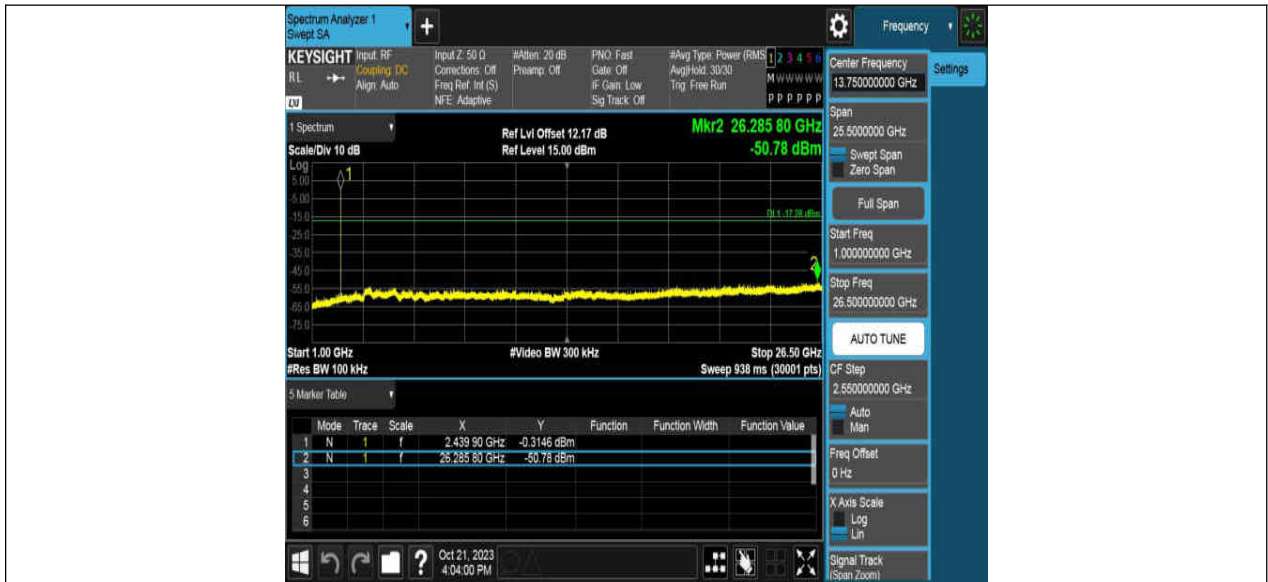

### 13. Radiated Emission

#### 13.1. Block diagram of test setup

In 3 m Anechoic Chamber, test setup diagram for 9 kHz - 30 MHz:

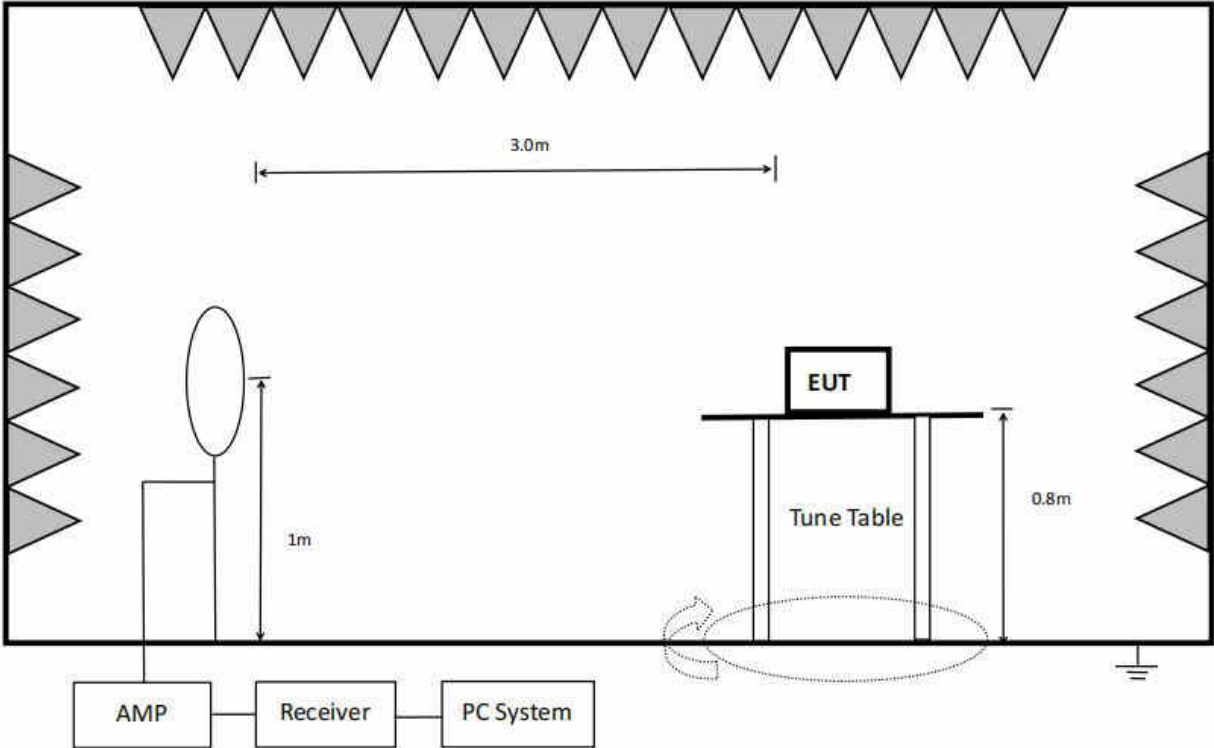

In 3 m Anechoic Chamber, test setup diagram for 30 MHz - 1 GHz:

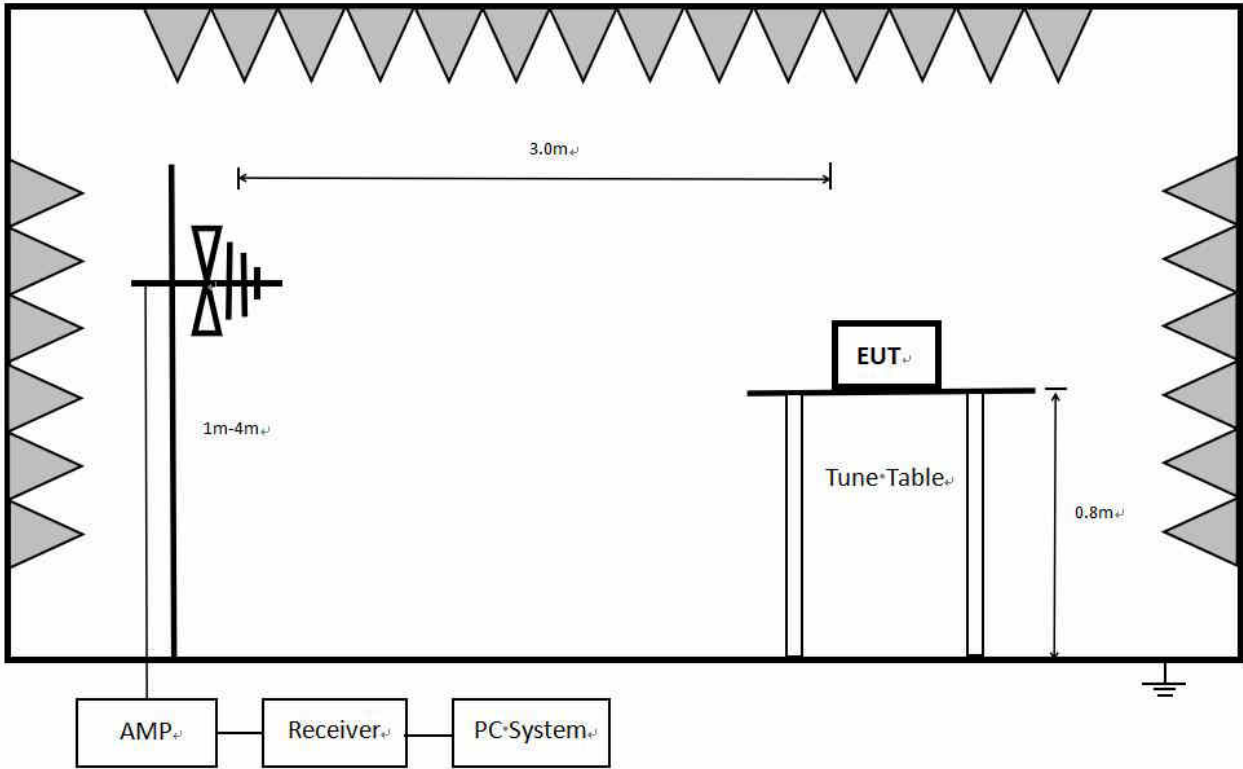

In 3 m Anechoic Chamber, test setup diagram for frequency above 1 GHz:

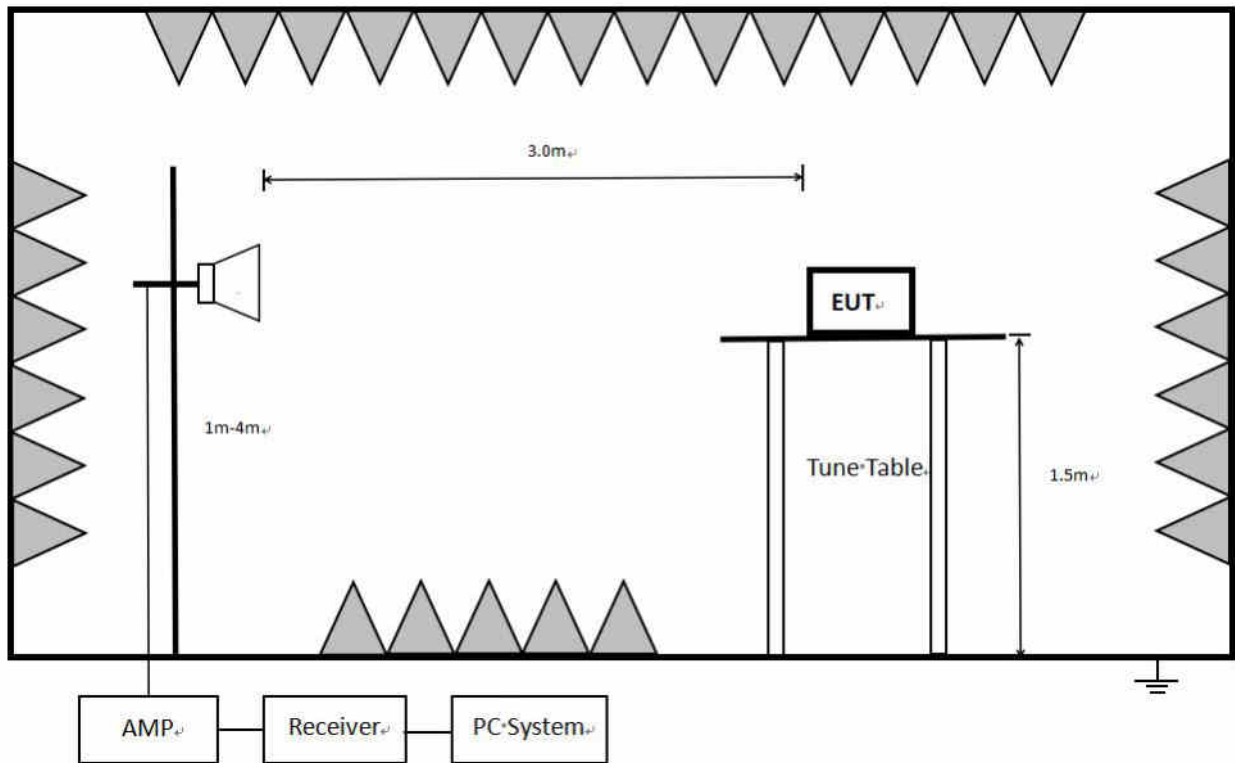

Note: For harmonic emissions test an appropriate high pass filter was inserted in the input port of AMP.

### 13.2. Limit

(1) FCC 15.205 Restricted frequency band

MHz	MHz	MHz	GHz
0.090-0.110	16.42-16.423	399.9-410	4.5-5.15
10.495-0.505	16.69475-16.69525	608-614	5.35-5.46
2.1735-2.1905	16.80425-16.80475	960-1240	7.25-7.75
4.125-4.128	25.5-25.67	1300-1427	8.025-8.5
4.1772&4.17775	37.5-38.25	1435-1626.5	9.0-9.2
4.2072&4.20775	73-74.6	1645.5-1646.5	9.3-9.5
6.215-6.218	74.8-75.2	1660-1710	10.6-12.7
6.26775-6.26825	108-121.94	1718.8-1722.2	13.25-13.4
6.31175-6.31225	123-138	2200-2300	14.47-14.5
8.291-8.294	149.9-150.05	2310-2390	15.35-16.2
8.362-8.366	156.52475-156.52525	2483.5-2500	17.7-21.4
8.37625-8.38675	156.7-156.9	2690-2900	22.01-23.12
8.41425-8.41475	162.0125-167.17	3260-3267	23.6-24.0
12.29-12.293	167.72-173.2	3332-3339	31.2-31.8
12.51975-12.52025	240-285	3345.8-3358	36.43-36.5
12.57675-12.57725	322-335.4	3600-4400	( <sup>2</sup> )
13.36-13.41			

<sup>1</sup>Until February 1, 1999, this restricted band shall be 0.490-0.510 MHz.

<sup>2</sup>Above 38.6

## (2) FCC 15.209 Limit.

Frequency MHz	Distance Meters	Field Strengths Limit	
		$\mu\text{V}/\text{m}$	$\text{dB}(\mu\text{V})/\text{m}$
0.009 ~ 0.490	300	2400/F(kHz)	67.6-20log(F)
0.490 ~ 1.705	30	24000/F(kHz)	87.6-20log(F)
1.705 ~ 30.0	30	30	29.54
30 ~ 88	3	100	40.0
88 ~ 216	3	150	43.5
216~960	3	200	46.0
960~1000	3	500	54.0
Above 1000	3	74.0 dB( $\mu\text{V}$ )/m (Peak) 54.0 dB( $\mu\text{V}$ )/m (Average)	

Note: (1) At frequencies at or above 30 MHz, measurements may be performed at a distance other than what is specified provided: measurements are not made in the near field except where it can be shown that near field measurements are appropriate due to the characteristics of the device; and it can be demonstrated that the signal levels needed to be measured at the distance employed can be detected by the measurement equipment. Measurements shall not be performed at a distance greater than 30 meters unless it can be further demonstrated that measurements at a distance of 30 meters or less are impractical. When performing measurements at a distance other than that specified, the results shall be extrapolated to the specified distance using an extrapolation factor of 20 dB/decade (inverse linear-distance for field strength measurements; inverse-linear-distance-squared for power density measurements).

(2) At frequencies below 30 MHz, measurements may be performed at a distance closer than that specified in the regulations; however, an attempt should be made to avoid making measurements in the near field. Pending the development of an appropriate measurement procedure for measurements performed below 30 MHz, when performing measurements at a closer distance than specified, the results shall be extrapolated to the specified distance by either making measurements at a minimum of two distances on at least one radial to determine the proper extrapolation factor or by using the square of an inverse linear distance extrapolation factor (40 dB/decade). This paragraph (f) shall not apply to Access BPL devices operating below 30 MHz.

About Restricted bands of operation please refer to RSS-Gen section 8.10 and FCC § 15.205(a),

### 13.3. Test Procedure

Below 30 MHz:

The setting of the spectrum Analyzer

RBW	300 Hz (From 9 kHz to 0.15 MHz)/ 10 kHz (From 0.15 MHz to 30 MHz)
VBW	1 kHz (From 9 kHz to 0.15 MHz)/ 30 kHz (From 0.15 MHz to 30 MHz)
Sweep	Auto
Trace	Max hold

1. The testing follows the guidelines in ANSI C63.10-2013
2. The EUT was arranged to its worst case and then turntable (from 0 degree to 360 degrees) to find the maximum reading. A pre-amp and a high pass filter are used for the test in order to get better signal level. Both Horizontal, Face-on and Face-off polarizations of the antenna are set to make the measurement.
3. The EUT was placed on a turntable with 80 cm meter above ground.
4. The EUT was set 3 meters from the interference receiving antenna, which was mounted on the top of 1 meter height antenna tower.
5. The radiated emission limits are based on measurements employing a CISPR quasi-peak detector except for the frequency bands 9-90 kHz, 110-490 kHz and above 1000 MHz. Radiated emission limits in these three bands are based on measurements employing an average detector.
6. For measurement below 1 GHz, the initial step in collecting conducted emission data is a spectrum analyzer peak detector mode pre-scanning the measurement frequency range. Significant peaks are then marked and then Quasi Peak detector mode re-measured. If the emission level of the EUT measured by the peak detector is 3 dB lower than the applicable limit, the peak emission level will be reported. Otherwise, the emission measurement will be repeated using the quasi-peak detector and reported.
7. Although these tests were performed other than open field site, adequate comparison measurements were confirmed against 30m open field site. Therefore, sufficient tests were made to demonstrate that the alternative site produces results that correlate with the ones of tests made in an open field site based on KDB 414788.

Below 1 GHz and above 30 MHz:

The setting of the spectrum Analyzer

RBW	100 kHz
VBW	300 kHz
Sweep	Auto
Trace	Max hold

1. The testing follows the guidelines in ANSI C63.10-2013.
2. The EUT was arranged to its worst case and then tune the antenna tower (from 1 m to 4 m) and turntable (from 0 degree to 360 degrees) to find the maximum reading. A pre-amp and a high pass filter are used for the test in order to get better signal level. Both horizontal and vertical polarizations of the antenna are set to make the measurement.
3. The EUT was placed on a turntable with 80 cm above ground.
4. The EUT was set 3 meters from the interference receiving antenna, which was mounted on the top of a variable height antenna tower.
5. For measurement below 1GHz, the initial step in collecting conducted emission data is a spectrum analyzer peak detector mode pre-scanning the measurement frequency range. Significant peaks are then marked and then Quasi Peak detector mode re-measured. If the emission level of the EUT measured by the peak detector is 3 dB lower than the applicable limit, the peak emission level will be reported. Otherwise, the emission measurement will be repeated using the quasi-peak detector and reported.

Above 1 GHz:

RBW	1 MHz
VBW	PEAK: 3 MHz AVG: see note 6
Sweep	Auto
Detector	Peak
Trace	Max hold

1. The testing follows the guidelines in ANSI C63.10-2013.

2. The EUT was arranged to its worst case and then tune the antenna tower (from 1 m to 4 m) and turntable (from 0 degree to 360 degrees) to find the maximum reading. A pre-amp and a high pass filter are used for the test in order to get better signal level. Both horizontal and vertical polarizations of the antenna are set to make the measurement.

3. The EUT was placed on a turntable with 1.5m above ground.

4. The EUT was set 3 meters from the interference receiving antenna, which was mounted on the top of a variable height antenna tower.

5. For measurement above 1GHz, the emission measurement will be measured by the peak detector. This peak level, once corrected, must comply with the limit specified in Section 15.209.

6. For measurements above 1 GHz the resolution bandwidth is set to 1 MHz, then the video bandwidth is set to 3 MHz for peak measurements and 1 MHz resolution bandwidth with 1/T video bandwidth with peak detector for AVG measurements. For the Duty Cycle please refer to clause 8.1.ON TIME AND DUTY CYCLE.

7. Restriction band: Investigated frequency range from 2310 MHz to 2410 MHz and 2470MHz to 2500 MHz.

All restriction band should comply with 15.209, other emission should be at least 20 dB below the fundamental.

Note 1: For all radiated test, EUT in each of three orthogonal axis emissions had been tested, but only the worst case (X axis) data recorded in the report.

Note 2: The EUT does not support simultaneous transmission.

Note 3: The EUT was fully exercised with external accessories during the test. In the case of multiple accessory external ports, an external accessory shall be connected to one of each type of port.



### **13.4. Results**

Pass. (See below detailed test result)

All the emissions except fundamental emission from 9 kHz to 25 GHz were comply with 15.209 limits.

Note1: According exploratory test, the emission levels are 20 dB below the limit detected from 9 kHz to 30 MHz, so the final test was performed with frequency range from 30 MHz to 26 GHz and recorded in below.

Note2: For emissions below 1 GHz, according exploratory explorer test, when change Tx mode and channel, have no distinct influence on emissions level, so for emissions below 1 GHz, the final test was only performed with EUT working in BLE 2MHz mode.

Note3: For emissions above 1 GHz. If peak results comply with AV limit, AV Result is deemed to comply with AV limit.

### **13.5. Original test data**

Below 1 GHz and above 30 MHz test data Refer to appendix A

Above 1 GHz test data Refer to appendix B

## 14. AC Power Line Conducted Emissions

### 14.1. Block diagram of test setup

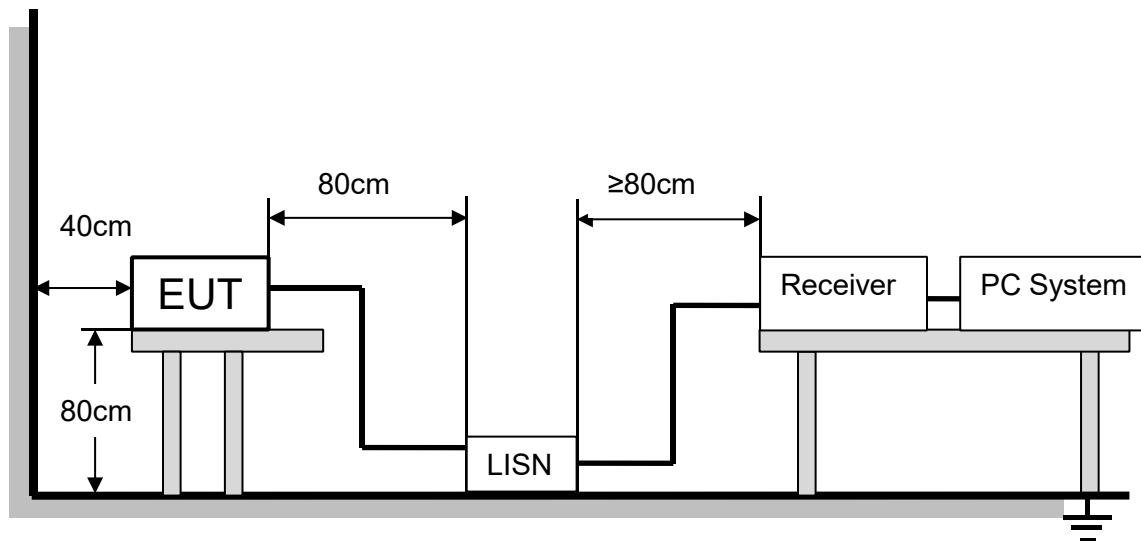

The EUT is put on a table of non-conducting material that is 80 cm high. The vertical conducting wall of shielding is located 40 cm to the rear of the EUT. The power line of the EUT is connected to the AC mains through an Artificial Mains Network (A.M.N.). A EMI Measurement Receiver (R&S Test Receiver ESR3) is used to test the emissions from both sides of AC line. According to the requirements in Section 6.2 of ANSI C63.10-2013. Conducted emissions from the EUT measured in the frequency range between 0.15 MHz and 30 MHz using CISPR Quasi-Peak and average detector mode. The bandwidth of EMI test receiver is set at 9 kHz.

The arrangement of the equipment is installed to meet the standards and operating in a manner, which tends to maximize its emission characteristics in a normal application.

### 14.2. Limits

Please refer to CFR 47 FCC § 15.207 (a) and ISED RSS-Gen Clause 8.8.

Frequency (MHz)	Quasi-peak	Average
0.15 -0.5	66 - 56 *	56 - 46 *
0.50 -5.0	56.00	46.00
5.0 -30.0	60.00	50.00

Note 1: \* Decreasing linearly with logarithm of frequency.

Note 2: The lower limit shall apply at the transition frequencies.

### 14.3. Test procedure

The EUT and Support equipment, if needed, were put placed on a non-metallic table, 80cm above the ground plane.

Configuration EUT to simulate typical usage as described in clause 2.4 and test equipment as described in clause 10.2 of this report.

All I/O cables were positioned to simulate typical actual usage as per ANSI C63.10.

All support equipment power received from a second LISN.

Emissions were measured on each current carrying line of the EUT using an EMI Test Receiver connected to the LISN powering the EUT.

The Receiver scanned from 150 kHz to 30 MHz for emissions in each of the test modes.

During the above scans, the emissions were maximized by cable manipulation.

The test mode(s) described in clause 2.4 were scanned during the preliminary test.

After the preliminary scan, we found the test mode producing the highest emission level.

The EUT configuration and worse cable configuration of the above highest emission levels were recorded for reference of the final test.

EUT and support equipment were set up on the test bench as per the configuration with highest emission level in the preliminary test.

A scan was taken on both power lines, Neutral and Line, recording at least the six highest emissions.

Emission frequency and amplitude were recorded into a computer in which correction factors were used to calculate the emission level and compare reading to the applicable limit.

The test data of the worst-case condition(s) was recorded.

The bandwidth of test receiver is set at 9 kHz.

#### **14.4. Test result**

According to 15.207, power Line Conducted Emission is not required for devices which only employ battery power for operation and which do not operate from the AC power lines or contain provisions for operation while connected to the AC power lines.

## 15. Antenna Requirements

### 15.1. Limits

Please refer to FCC § 15.203

An intentional radiator shall be designed to ensure that no antenna other than that furnished by the responsible party shall be used with the device. The use of a permanently attached antenna or of an antenna that uses a unique coupling to the intentional radiator shall be considered sufficient to comply with the provisions of this section. The manufacturer may design the unit so that a broken antenna can be replaced by the user, but the use of a standard antenna jack or electrical connector is prohibited.

Please refer to FCC § 15.247(b)(4)

The conducted output power limit specified in paragraph (b) of this section is based on the use of antennas with directional gains that do not exceed 6 dBi. Except as shown in paragraph (c) of this section, if transmitting antennas of directional gain greater than 6 dBi are used, the conducted output power from the intentional radiator shall be reduced below the stated values in paragraphs (b)(1), (b)(2), and (b)(3) of this section, as appropriate, by the amount in dB that the directional gain of the antenna exceeds 6 dBi.

### 15.2. Result

The antenna used for this product is PCB antenna and that no antenna other than that furnished by the responsible party shall be used with the device, the maximum peak gain of the transmit antenna is 1.81 dBi

# APPENDIX A – Radiated Emission Below 1GHz Test Data

## Test Report

Project Information			
EUT:	WiFi Module	Environment:	23.6°C 52%
Model:	SKO.WB920TU.3	SN:	
Mode:	2M_2480	Voltage:	DC 5V+/-0.3
Customer:		Engineer:	Soho Liu
Remark:			

Start of Test: 2023-11-01 10:05:13

### Test Graph

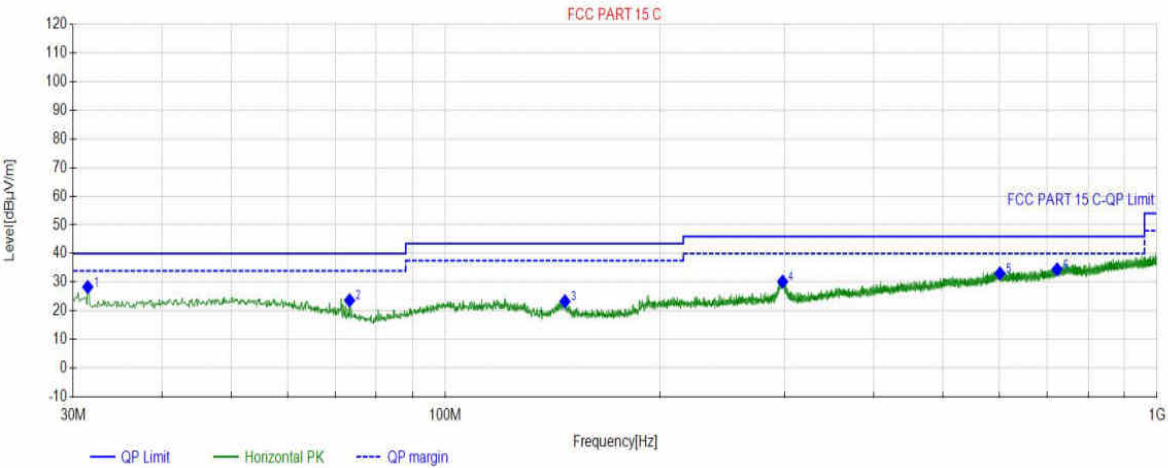

Final Data List								
NO.	Freq. (MHz)	Factor (dB)	QP Value (dBµV/m)	QP Limit (dBµV/m)	QP Margin (dB)	Height (cm)	Angle (°)	Polarity
1	31.4551	19.17	28.33	40.00	11.67	100	27	Horizontal
2	73.3633	17.41	23.67	40.00	16.33	100	27	Horizontal
3	147.2847	17.04	23.33	43.50	20.17	100	87	Horizontal
4	297.8438	21.83	30.22	46.00	15.78	100	192	Horizontal
5	601.5812	30.22	33.09	46.00	12.91	100	249	Horizontal
6	723.7164	31.60	34.50	46.00	11.50	100	240	Horizontal

# Test Report

Project Information			
EUT:	WiFi Module	Environment:	23.6°C 52%
Model:	SKO.WB920TU.3	SN:	
Mode:	2M_2480	Voltage:	DC 5V+/-0.3
Customer:		Engineer:	Soho Liu
Remark:			

Start of Test: 2023-11-01 10:05:57

### Test Graph

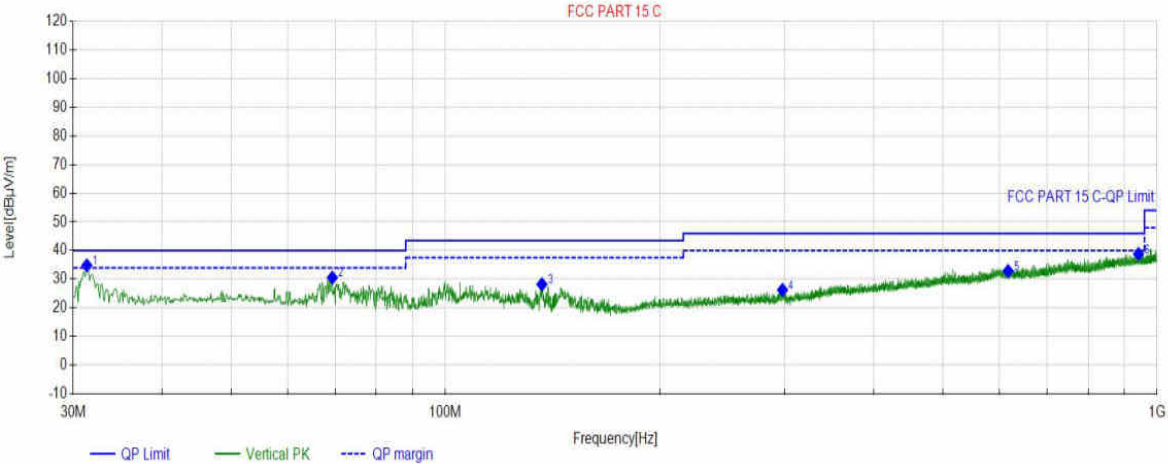

Final Data List								
NO.	Freq. (MHz)	Factor (dB)	QP Value (dBµV/m)	QP Limit (dBµV/m)	QP Margin (dB)	Height (cm)	Angle (°)	Polarity
1	31.3581	19.15	34.82	40.00	5.18	100	103	Vertical
2	69.3859	18.45	30.56	40.00	9.44	100	37	Vertical
3	136.7107	17.23	28.22	43.50	15.28	100	175	Vertical
4	297.7468	21.83	26.26	46.00	19.74	100	351	Vertical
5	617.5878	30.33	32.86	46.00	13.14	100	72	Vertical
6	941.8912	34.92	38.83	46.00	7.17	100	212	Vertical

# APPENDIX B – Radiated Emission Above 1GHz Test Data

## Test Report

Project Information			
EUT:	WiFi Module	Environment:	23.6°C 52%
Model:	SKO.WB920TU.3	SN:	
Mode:	BLE_2M_2402	Voltage:	DC 5V+/-0.3
Customer:		Engineer:	Soho Liu
Remark:			

Start of Test: 2023-11-01 10:51:09

### Test Graph

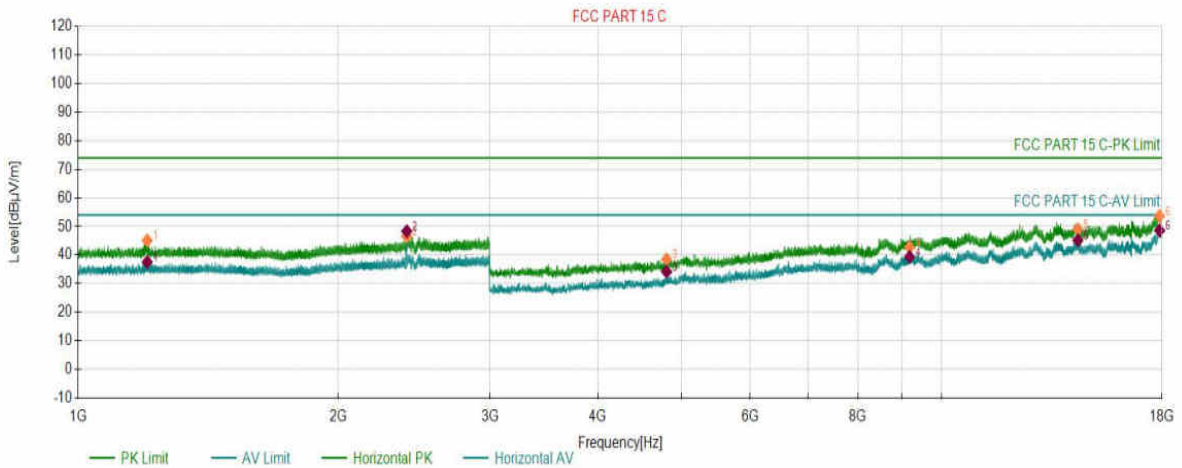

PK Final Data List								
NO.	Freq. (MHz)	Factor (dB)	PK Value (dBµV/m)	PK Limit (dBµV/m)	PK Margin (dB)	Height (cm)	Angle (°)	Polarity
1	1202.2101	2.29	45.11	74.00	28.89	150	129	Horizontal
2	2401.9701	7.43	46.52	74.00	27.48	150	139	Horizontal
3	4803.0902	-9.85	38.52	74.00	35.48	150	111	Horizontal
4	9181.8091	3.10	42.74	74.00	31.26	150	6	Horizontal
5	14380.3190	11.34	48.98	74.00	25.02	150	134	Horizontal
6	17882.9942	17.30	53.61	74.00	20.39	150	100	Horizontal

AV Final Data List								
NO.	Freq. (MHz)	Factor (dB)	AV Value (dBµV/m)	AV Limit (dBµV/m)	AV Margin (dB)	Height (cm)	Angle (°)	Polarity
1	1202.2101	2.29	37.59	54.00	16.41	150	129	Horizontal
2	2401.9701	7.43	48.33	54.00	5.67	150	139	Horizontal
3	4803.0902	-9.85	34.19	54.00	19.81	150	111	Horizontal
4	9181.8091	3.10	39.34	54.00	14.66	150	6	Horizontal
5	14380.3190	11.34	45.18	54.00	8.82	150	134	Horizontal
6	17882.9942	17.30	48.62	54.00	5.38	150	100	Horizontal

# Test Report

Project Information			
EUT:	WiFi Module	Environment:	23.6°C 52%
Model:	SKO.WB920TU.3	SN:	
Mode:	BLE_2M_2402	Voltage:	DC 5V+/-0.3
Customer:		Engineer:	Soho Liu
Remark:			

Start of Test: 2023-11-01 10:55:35

## Test Graph

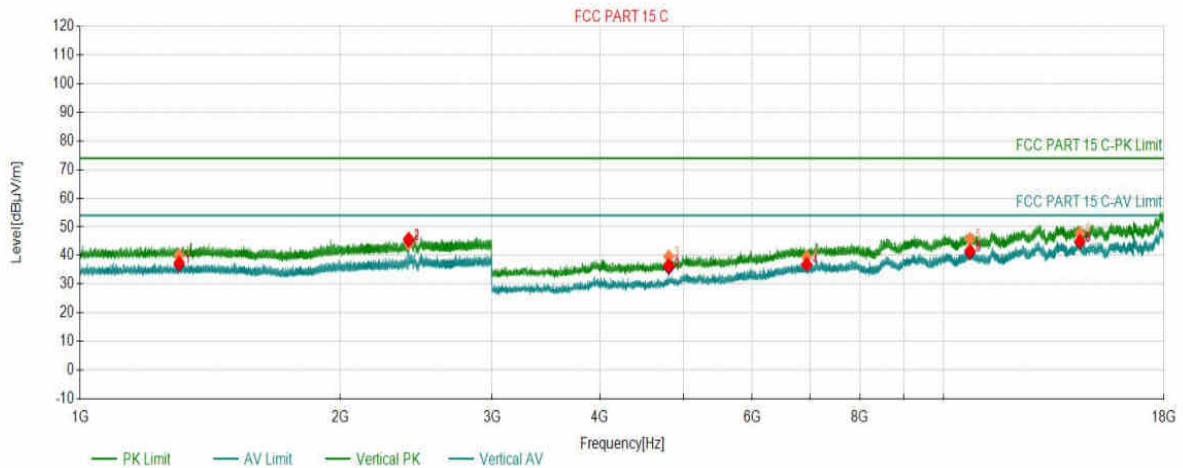

## PK Final Data List

NO.	Freq. (MHz)	Factor (dB)	PK Value (dBµV/m)	PK Limit (dBµV/m)	PK Margin (dB)	Height (cm)	Angle (°)	Polarity
1	1302.4151	2.72	40.19	74.00	33.81	150	130	Vertical
2	2401.7701	7.43	44.20	74.00	29.80	150	26	Vertical
3	4804.5902	-9.85	39.66	74.00	34.34	150	329	Vertical
4	6941.4471	-2.63	39.50	74.00	34.50	150	130	Vertical
5	10727.6364	5.18	45.81	74.00	28.19	150	319	Vertical
6	14378.8189	11.34	47.83	74.00	26.17	150	130	Vertical

## AV Final Data List

NO.	Freq. (MHz)	Factor (dB)	AV Value (dBµV/m)	AV Limit (dBµV/m)	AV Margin (dB)	Height (cm)	Angle (°)	Polarity
1	1302.4151	2.72	36.75	54.00	17.25	150	130	Vertical
2	2401.7701	7.43	45.32	54.00	8.68	150	26	Vertical
3	4804.5902	-9.85	35.66	54.00	18.34	150	329	Vertical
4	6941.4471	-2.63	36.79	54.00	17.21	150	130	Vertical
5	10727.6364	5.18	40.98	54.00	13.02	150	319	Vertical
6	14378.8189	11.34	44.61	54.00	9.39	150	130	Vertical



# Test Report

Project Information			
EUT:	WiFi Module	Environment:	23.6°C 52%
Model:	SKO.WB920TU.3	SN:	
Mode:	BLE_2M_2440	Voltage:	DC 5V+/-0.3
Customer:		Engineer:	Soho Liu
Remark:			

Start of Test: 2023-11-01 11:03:50

## Test Graph

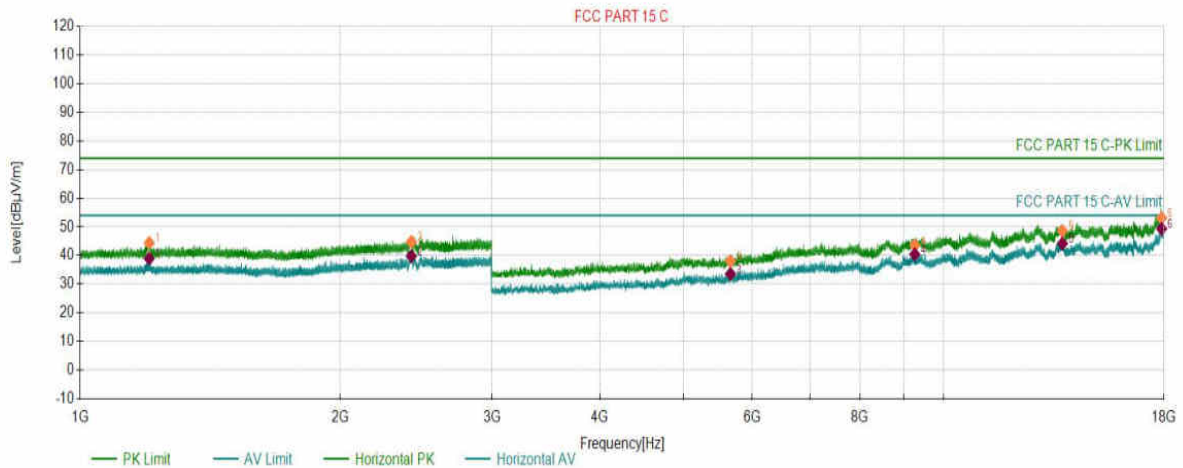

## PK Final Data List

NO.	Freq. (MHz)	Factor (dB)	PK Value (dBµV/m)	PK Limit (dBµV/m)	PK Margin (dB)	Height (cm)	Angle (°)	Polarity
1	1202.3101	2.29	44.44	74.00	29.56	150	98	Horizontal
2	2418.7709	7.52	44.82	74.00	29.18	150	144	Horizontal
3	5664.8832	-7.33	38.10	74.00	35.90	150	311	Horizontal
4	9259.0630	3.10	43.54	74.00	30.46	150	78	Horizontal
5	13729.2865	10.64	48.60	74.00	25.40	150	300	Horizontal
6	17887.4944	17.33	53.09	74.00	20.91	150	311	Horizontal

## AV Final Data List

NO.	Freq. (MHz)	Factor (dB)	AV Value (dBµV/m)	AV Limit (dBµV/m)	AV Margin (dB)	Height (cm)	Angle (°)	Polarity
1	1202.3101	2.29	38.96	54.00	15.04	150	98	Horizontal
2	2418.7709	7.52	39.80	54.00	14.20	150	144	Horizontal
3	5664.8832	-7.33	33.60	54.00	20.40	150	311	Horizontal
4	9259.0630	3.10	40.42	54.00	13.58	150	78	Horizontal
5	13729.2865	10.64	44.21	54.00	9.79	150	300	Horizontal
6	17887.4944	17.33	49.36	54.00	4.64	150	311	Horizontal

# Test Report

Project Information			
EUT:	WiFi Module	Environment:	23.6°C 52%
Model:	SKO.WB920TU.3	SN:	
Mode:	BLE_2M_2440	Voltage:	DC 5V+/-0.3
Customer:		Engineer:	Soho Liu
Remark:			

Start of Test: 2023-11-01 11:05:31

## Test Graph

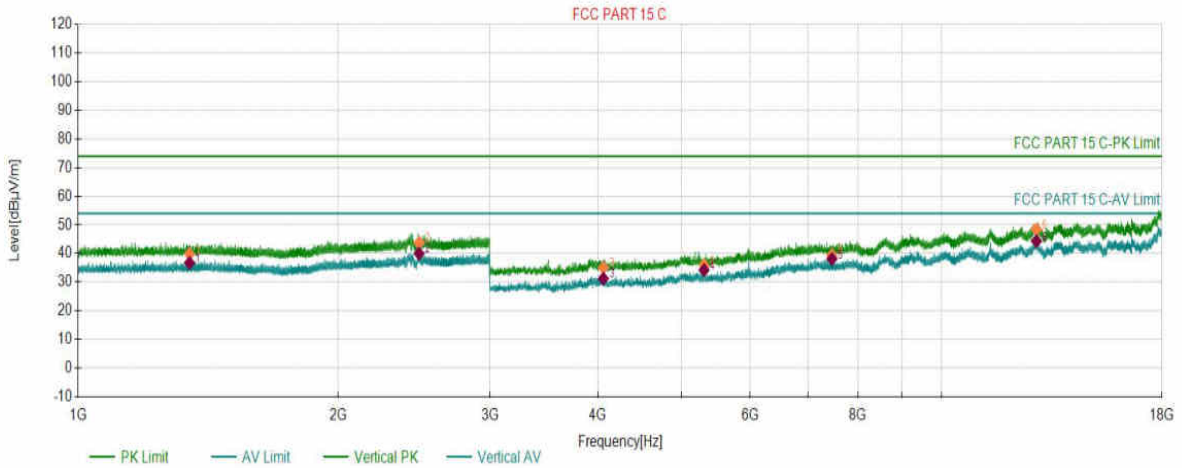

### PK Final Data List

NO.	Freq. (MHz)	Factor (dB)	PK Value (dBµV/m)	PK Limit (dBµV/m)	PK Margin (dB)	Height (cm)	Angle (°)	Polarity
1	1345.8173	3.00	39.85	74.00	34.15	150	3	Vertical
2	2482.7741	7.87	43.78	74.00	30.22	150	50	Vertical
3	4057.5529	-12.64	35.06	74.00	38.94	150	60	Vertical
4	5307.8654	-8.08	35.99	74.00	38.01	150	240	Vertical
5	7463.4732	-1.45	39.43	74.00	34.57	150	296	Vertical
6	12876.4938	9.14	48.44	74.00	25.56	150	50	Vertical

### AV Final Data List

NO.	Freq. (MHz)	Factor (dB)	AV Value (dBµV/m)	AV Limit (dBµV/m)	AV Margin (dB)	Height (cm)	Angle (°)	Polarity
1	1345.8173	3.00	36.73	54.00	17.27	150	3	Vertical
2	2482.7741	7.87	39.99	54.00	14.01	150	50	Vertical
3	4057.5529	-12.64	31.25	54.00	22.75	150	60	Vertical
4	5307.8654	-8.08	34.26	54.00	19.74	150	240	Vertical
5	7463.4732	-1.45	38.13	54.00	15.87	150	296	Vertical
6	12876.4938	9.14	44.37	54.00	9.63	150	50	Vertical

# Test Report

Project Information			
EUT:	WiFi Module	Environment:	23.6°C 52%
Model:	SKO.WB920TU.3	SN:	
Mode:	BLE_2M_2480	Voltage:	DC 5V+/-0.3
Customer:		Engineer:	Soho Liu
Remark:			

Start of Test: 2023-11-01 11:10:47

## Test Graph

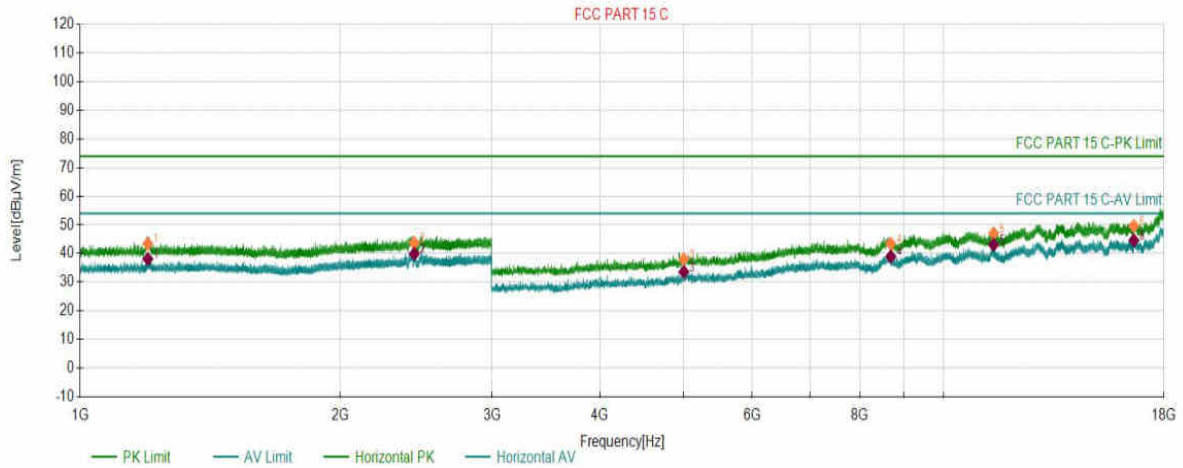

## PK Final Data List

NO.	Freq. (MHz)	Factor (dB)	PK Value (dBµV/m)	PK Limit (dBµV/m)	PK Margin (dB)	Height (cm)	Angle (°)	Polarity
1	1197.8099	2.26	43.40	74.00	30.60	150	137	Horizontal
2	2437.7719	7.63	43.71	74.00	30.29	150	281	Horizontal
3	5002.6001	-8.69	37.98	74.00	36.02	150	98	Horizontal
4	8686.7843	1.84	43.43	74.00	30.57	150	98	Horizontal
5	11428.1714	5.81	47.04	74.00	26.96	150	174	Horizontal
6	16608.6804	12.19	49.59	74.00	24.41	150	155	Horizontal

## AV Final Data List

NO.	Freq. (MHz)	Factor (dB)	AV Value (dBµV/m)	AV Limit (dBµV/m)	AV Margin (dB)	Height (cm)	Angle (°)	Polarity
1	1197.8099	2.26	38.14	54.00	15.86	150	137	Horizontal
2	2437.7719	7.63	39.92	54.00	14.08	150	281	Horizontal
3	5002.6001	-8.69	33.62	54.00	20.38	150	98	Horizontal
4	8686.7843	1.84	38.96	54.00	15.04	150	98	Horizontal
5	11428.1714	5.81	43.10	54.00	10.90	150	174	Horizontal
6	16608.6804	12.19	44.64	54.00	9.36	150	155	Horizontal

# Test Report

Project Information			
EUT:	WiFi Module	Environment:	23.6°C 52%
Model:	SKO.WB920TU.3	SN:	
Mode:	BLE_2M_2480	Voltage:	DC 5V+/-0.3
Customer:		Engineer:	Soho Liu
Remark:			

Start of Test: 2023-11-01 11:12:28

## Test Graph

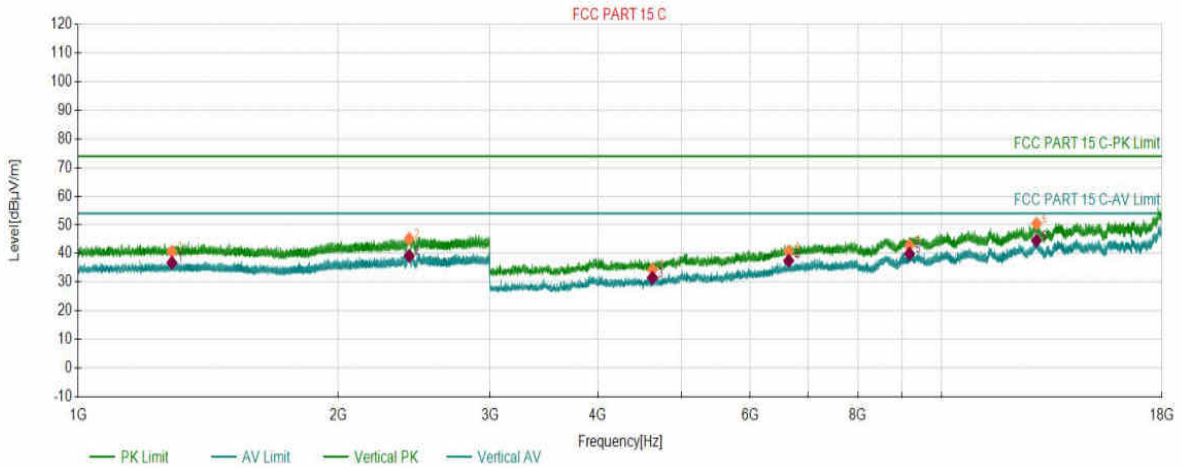

### PK Final Data List

NO.	Freq. (MHz)	Factor (dB)	PK Value (dBµV/m)	PK Limit (dBµV/m)	PK Margin (dB)	Height (cm)	Angle (°)	Polarity
1	1284.1142	2.63	40.64	74.00	33.36	150	318	Vertical
2	2417.3709	7.51	45.13	74.00	28.87	150	300	Vertical
3	4625.3313	-11.00	34.33	74.00	39.67	150	178	Vertical
4	6651.1826	-3.37	40.77	74.00	33.23	150	99	Vertical
5	9176.5588	3.04	42.82	74.00	31.18	150	282	Vertical
6	12880.2440	9.14	50.43	74.00	23.57	150	22	Vertical

### AV Final Data List

NO.	Freq. (MHz)	Factor (dB)	AV Value (dBµV/m)	AV Limit (dBµV/m)	AV Margin (dB)	Height (cm)	Angle (°)	Polarity
1	1284.1142	2.63	36.80	54.00	17.20	150	318	Vertical
2	2417.3709	7.51	39.20	54.00	14.80	150	300	Vertical
3	4625.3313	-11.00	31.57	54.00	22.43	150	178	Vertical
4	6651.1826	-3.37	37.51	54.00	16.49	150	99	Vertical
5	9176.5588	3.04	39.96	54.00	14.04	150	282	Vertical
6	12880.2440	9.14	44.56	54.00	9.44	150	22	Vertical

# Test Report

Project Information			
EUT:	WiFi Module	Environment:	23.6°C 52%
Model:	SKO.WB920TU.3	SN:	
Mode:	BLE_1M_2402	Voltage:	DC 5V+/-0.3
Customer:		Engineer:	Soho Liu
Remark:			

Start of Test: 2023-10-31 14:38:23

## Test Graph

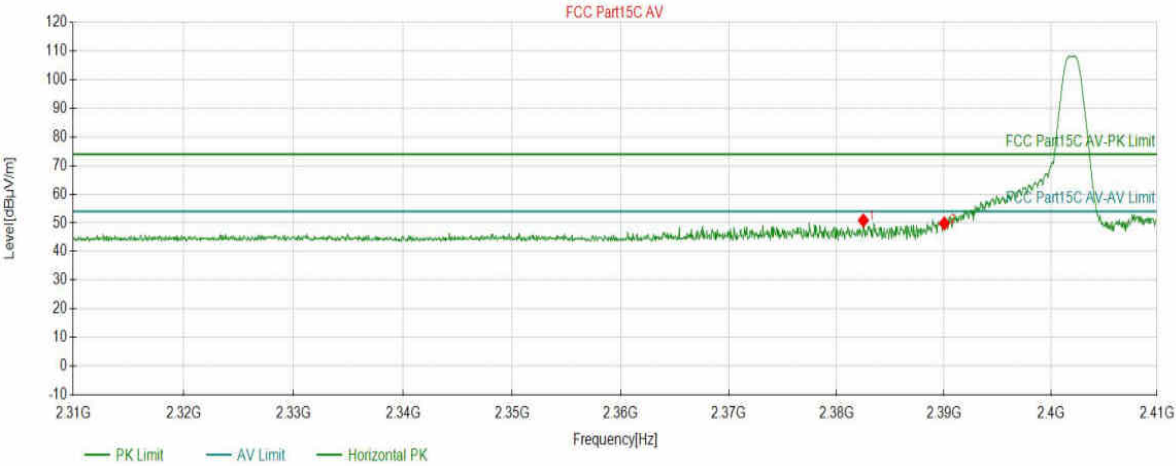

Suspected Data List									
NO.	Freq. (MHz)	Level (dBµV/m)	Factor (dB)	Limit (dBµV/m)	Margin (dB)	Height (cm)	Angle (°)	Detector	Polarity
1	2382.4862	50.88	5.96	74.00	23.12	150	194	PK	Horizontal
2	2390.0400	49.84	5.95	74.00	24.16	150	186	PK	Horizontal

# Test Report

Project Information			
EUT:	WiFi Module	Environment:	23.6°C 52%
Model:	SKO.WB920TU.3	SN:	
Mode:	BLE_1M_2402	Voltage:	DC 5V+/-0.3
Customer:		Engineer:	Soho Liu
Remark:			

Start of Test: 2023-10-31 14:39:12

## Test Graph

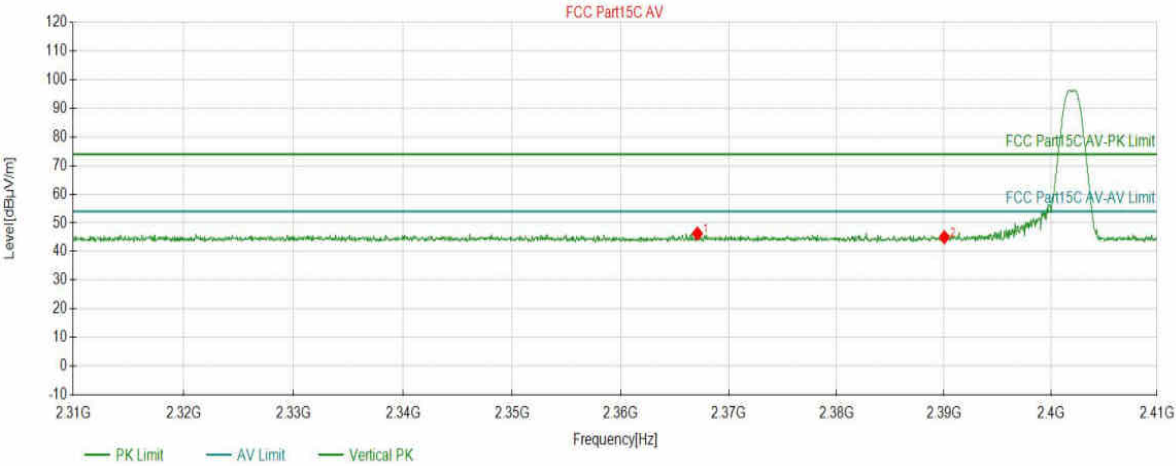

## Suspected Data List

NO.	Freq. (MHz)	Level (dBµV/m)	Factor (dB)	Limit (dBµV/m)	Margin (dB)	Height (cm)	Angle (°)	Detector	Polarity
1	2367.0785	46.29	5.97	74.00	27.71	150	359	PK	Vertical
2	2390.0400	45.01	5.95	74.00	28.99	150	308	PK	Vertical

# Test Report

Project Information			
EUT:	WiFi Module	Environment:	23.6°C 52%
Model:	SKO.WB920TU.3	SN:	
Mode:	BLE_1M_2480	Voltage:	DC 5V+/-0.3
Customer:		Engineer:	Soho Liu
Remark:			

Start of Test: 2023-10-31 14:41:46

## Test Graph

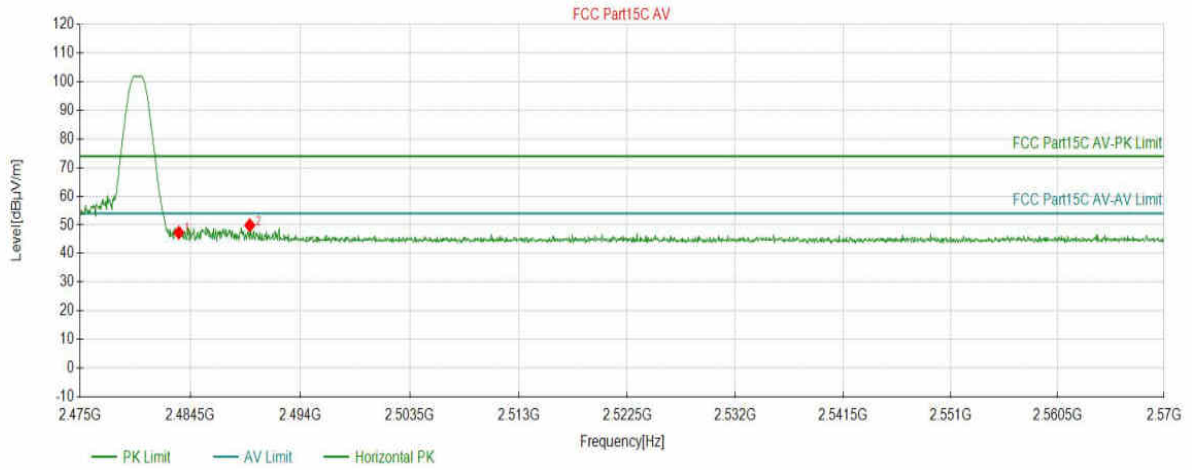

## Suspected Data List

NO.	Freq. (MHz)	Level (dBµV/m)	Factor (dB)	Limit (dBµV/m)	Margin (dB)	Height (cm)	Angle (°)	Detector	Polarity
1	2483.5068	47.29	6.50	74.00	26.71	150	203	PK	Horizontal
2	2489.6373	49.85	6.54	74.00	24.15	150	299	PK	Horizontal

# Test Report

Project Information			
EUT:	WiFi Module	Environment:	23.6°C 52%
Model:	SKO.WB920TU.3	SN:	
Mode:	BLE_1M_2480	Voltage:	DC 5V+/-0.3
Customer:		Engineer:	Soho Liu
Remark:			

Start of Test: 2023-10-31 14:42:34

### Test Graph

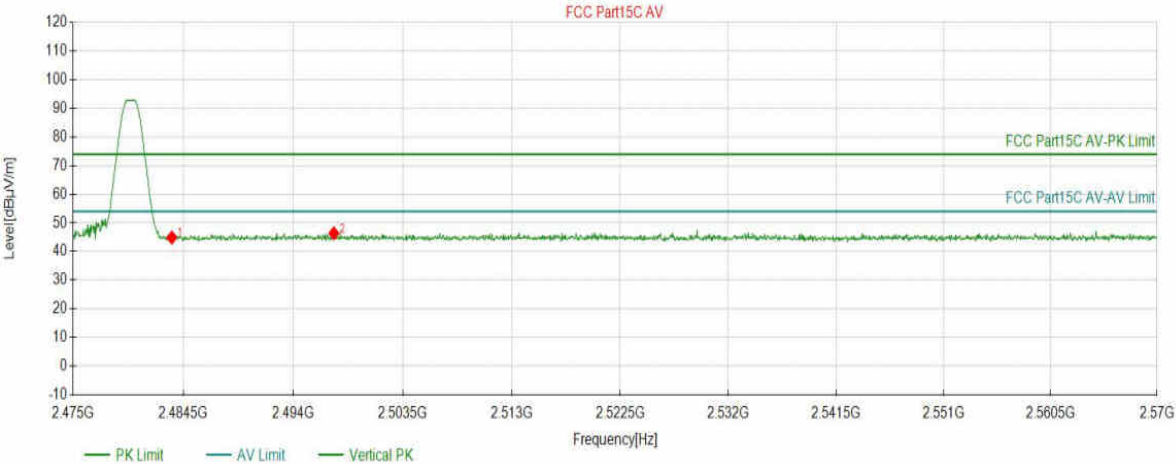

Suspected Data List									
NO.	Freq. (MHz)	Level (dBµV/m)	Factor (dB)	Limit (dBµV/m)	Margin (dB)	Height (cm)	Angle (°)	Detector	Polarity
1	2483.5068	44.88	6.50	74.00	29.12	150	318	PK	Vertical
2	2497.5263	46.36	6.59	74.00	27.64	150	131	PK	Vertical



# Test Report

Project Information			
EUT:	WiFi Module	Environment:	23.6°C 52%
Model:	SKO.WB920TU.3	SN:	
Mode:	BLE_2M_2402	Voltage:	DC 5V+/-0.3
Customer:		Engineer:	Soho Liu
Remark:			

Start of Test: 2023-10-31 14:44:52

## Test Graph

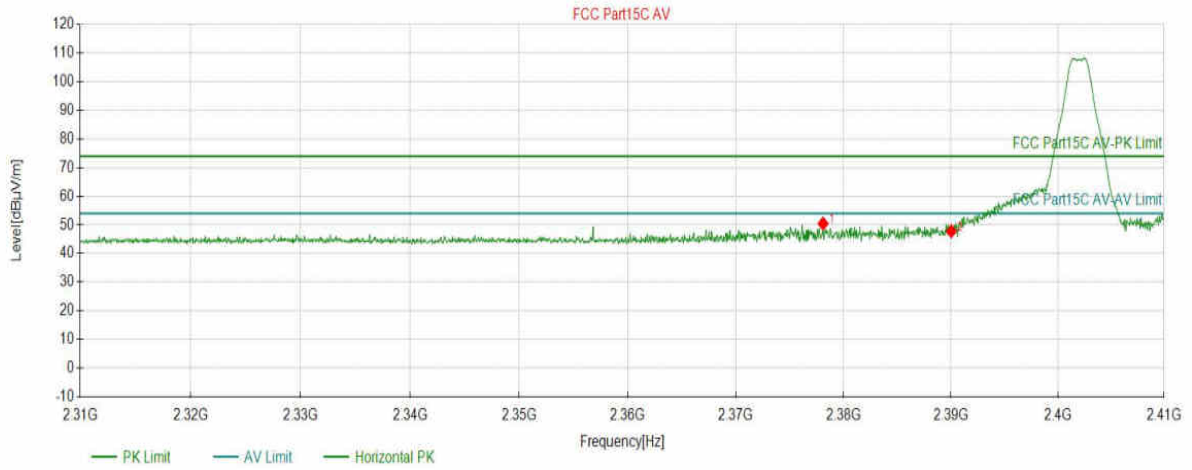

Suspected Data List									
NO.	Freq. (MHz)	Level (dBµV/m)	Factor (dB)	Limit (dBµV/m)	Margin (dB)	Height (cm)	Angle (°)	Detector	Polarity
1	2378.0840	50.46	5.96	74.00	23.54	150	191	PK	Horizontal
2	2390.0400	47.79	5.95	74.00	26.21	150	194	PK	Horizontal

# Test Report

Project Information			
EUT:	WiFi Module	Environment:	23.6°C 52%
Model:	SKO.WB920TU.3	SN:	
Mode:	BLE_2M_2402	Voltage:	DC 5V+/-0.3
Customer:		Engineer:	Soho Liu
Remark:			

Start of Test: 2023-10-31 14:45:41

## Test Graph

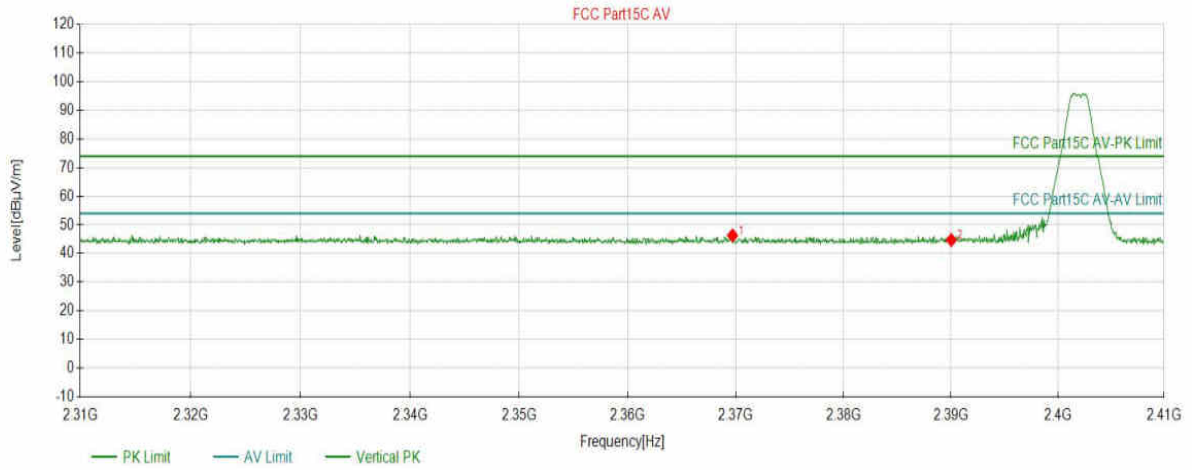

## Suspected Data List

NO.	Freq. (MHz)	Level (dBµV/m)	Factor (dB)	Limit (dBµV/m)	Margin (dB)	Height (cm)	Angle (°)	Detector	Polarity
1	2369.6798	46.33	5.97	74.00	27.67	150	122	PK	Vertical
2	2390.0400	44.73	5.95	74.00	29.27	150	106	PK	Vertical

# Test Report

Project Information			
EUT:	WiFi Module	Environment:	23.6°C 52%
Model:	SKO.WB920TU.3	SN:	
Mode:	BLE_2M_2480	Voltage:	DC 5V+/-0.3
Customer:		Engineer:	Soho Liu
Remark:			

Start of Test: 2023-10-31 14:47:56

## Test Graph

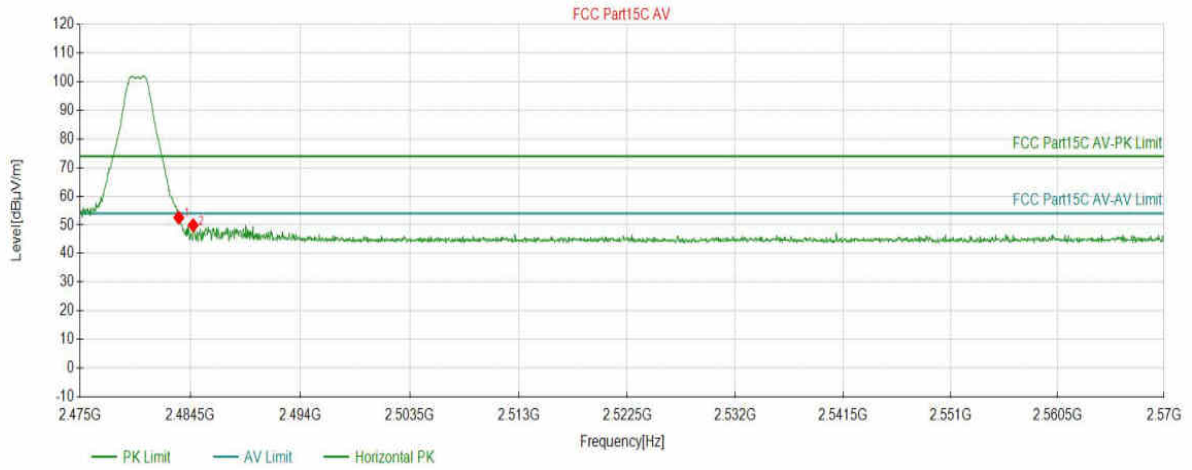

Suspected Data List									
NO.	Freq. (MHz)	Level (dBµV/m)	Factor (dB)	Limit (dBµV/m)	Margin (dB)	Height (cm)	Angle (°)	Detector	Polarity
1	2483.5068	52.53	6.50	74.00	21.47	150	306	PK	Horizontal
2	2484.7424	49.89	6.51	74.00	24.11	150	326	PK	Horizontal

# Test Report

Project Information			
EUT:	WiFi Module	Environment:	23.6°C 52%
Model:	SKO.WB920TU.3	SN:	
Mode:	BLE_2M_2480	Voltage:	DC 5V+/-0.3
Customer:		Engineer:	Soho Liu
Remark:			

Start of Test: 2023-10-31 14:48:44

## Test Graph

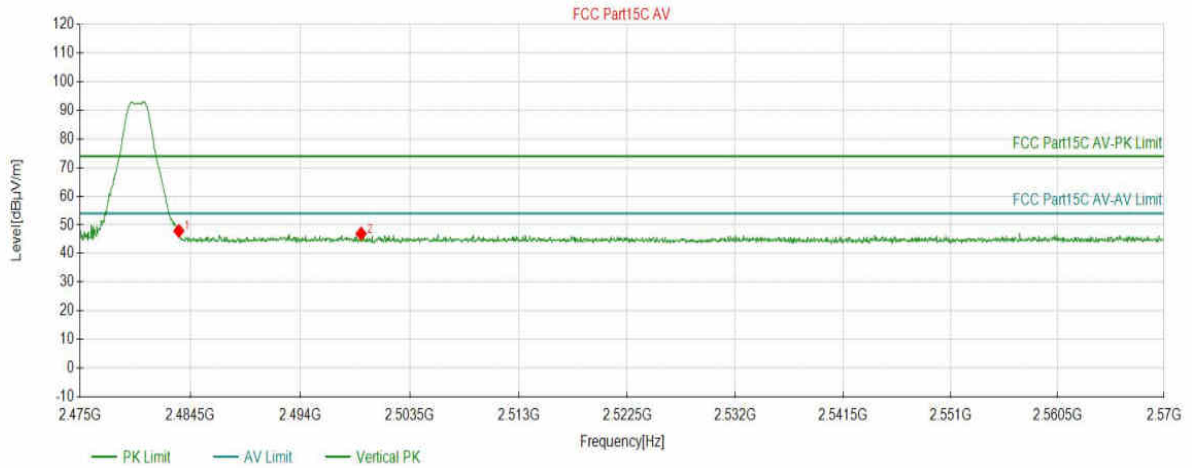

Suspected Data List									
NO.	Freq. (MHz)	Level (dBµV/m)	Factor (dB)	Limit (dBµV/m)	Margin (dB)	Height (cm)	Angle (°)	Detector	Polarity
1	2483.5068	47.90	6.50	74.00	26.10	150	302	PK	Vertical
2	2499.2846	46.95	6.61	74.00	27.05	150	344	PK	Vertical

**END OF REPORT**