



**CFR 47 FCC PART 15 SUBPART C
ISED RSS-247 ISSUE 2**

TEST REPORT

For

IEEE 802.11a/b/g/n/ac 2T2R USB WiFi Module

MODEL NUMBER: SKO.W7612U.2

**FCC ID: 2AR82-SKOW7612U21
IC: 24728-SKOW7612U21**

REPORT NUMBER: 4788955528-2

ISSUE DATE: April 28, 2019

Prepared for

**Guangzhou Shikun Electronics Co., Ltd
NO.192 KEZHU ROAD,SCIENCE PARK GUANGZHOU,GUANGDONG,CHINA**

Prepared by

**UL Verification Services (Guangzhou) Co., Ltd, Song Shan Lake Branch
Building 10, Innovation Technology Park, No. 1, Li Bin Road, Song Shan Lake
Hi-Tech Development Zone Dongguan, People's Republic of China
Tel: +86 769 22038881
Fax: +86 769 33244054
Website: www.ul.com**



Revision History

<u>Rev.</u>	<u>Issue Date</u>	<u>Revisions</u>	<u>Revised By</u>
V0	4/26/2019	Initial Issue	



Summary of Test Results			
Clause	Test Items	FCC/IC Rules	Test Results
1	6dB Bandwidth and 99% Occupied Bandwidth	FCC Part 15.247 (a) (2) RSS-247 Clause 5.2 (a) ISED RSS-Gen Clause 6.7	Pass
2	Peak Conducted Output Power	FCC Part 15.247 (b) (3) RSS-247 Clause 5.4 (e)	Pass
3	Power Spectral Density	FCC Part 15.247 (e) RSS-247 Clause 5.2 (b)	Pass
4	Conducted Bandedge and Spurious Emission	FCC Part 15.247 (d) RSS-247 Clause 5.5	Pass
5	Radiated Bandedge and Spurious Emission	FCC Part 15.247 (d) FCC Part 15.209 FCC Part 15.205 RSS-247 Clause 5.5 RSS-GEN Clause 8.9	Pass
6	Conducted Emission Test For AC Power Port	FCC Part 15.207 RSS-GEN Clause 8.8	Pass
7	Antenna Requirement	FCC Part 15.203 RSS-GEN Clause 8.3	Pass



TABLE OF CONTENTS

1. ATTESTATION OF TEST RESULTS	6
2. TEST METHODOLOGY	7
3. FACILITIES AND ACCREDITATION	7
4. CALIBRATION AND UNCERTAINTY	8
4.1. <i>MEASURING INSTRUMENT CALIBRATION</i>	8
4.2. <i>MEASUREMENT UNCERTAINTY</i>	8
5. EQUIPMENT UNDER TEST	9
5.1. <i>DESCRIPTION OF EUT</i>	9
5.2. <i>MAXIMUM OUTPUT POWER</i>	9
5.3. <i>CHANNEL LIST</i>	10
5.4. <i>TEST CHANNEL CONFIGURATION</i>	10
5.5. <i>THE WORSE CASE CONFIGURATIONS</i>	10
5.6. <i>DESCRIPTION OF AVAILABLE ANTENNAS</i>	11
5.7. <i>THE WORSE CASE CONFIGURATIONS</i>	11
5.8. <i>DESCRIPTION OF TEST SETUP</i>	12
6. MEASURING INSTRUMENT AND SOFTWARE USED	13
7. MEASUREMENT METHODS	14
8. ANTENNA PORT TEST RESULTS	15
8.1. <i>ON TIME AND DUTY CYCLE</i>	15
8.2. <i>6 dB DTS BANDWIDTH AND 99% OCCUPIED BANDWIDTH</i>	18
8.2.1. 802.11b SISO MODE.....	19
8.2.2. 802.11g SISO MODE.....	23
8.2.3. 802.11n HT20 MIMO MODE	27
8.2.4. 802.11n HT40 MIMO MODE	35
8.3. <i>PEAK CONDUCTED OUTPUT POWER</i>	43
8.3.1. 802.11b SISO MODE.....	44
8.3.2. 802.11g SISO MODE.....	44
8.3.3. 802.11n HT20 MIMO MODE	45
8.3.4. 802.11n HT40 MIMO MODE	45
8.4. <i>POWER SPECTRAL DENSITY</i>	46
8.4.1. 802.11b SISO MODE.....	48
8.4.2. 802.11g SISO MODE.....	50
8.4.3. 802.11n HT20 MIMO MODE	52
8.4.4. 802.11n HT40 MIMO MODE	56
8.5. <i>CONDUCTED BANDEDGE AND SPURIOUS EMISSIONS</i>	60
8.5.1. 802.11b SISO MODE.....	62



8.5.2.	802.11g SISO MODE.....	65
8.5.3.	802.11n HT20 MIMO MODE	68
8.5.4.	802.11n HT40 MIMO MODE	74
9.	RADIATED TEST RESULTS.....	80
9.1.	<i>RESTRICTED BANDEDGE</i>	86
9.1.1.	802.11b SISO MODE.....	86
9.1.2.	802.11g SISO MODE.....	92
9.1.3.	802.11n HT20 MIMO MODE	100
9.1.4.	802.11n HT40 MIMO MODE	108
9.2.	<i>SPURIOUS EMISSIONS (3~18GHz)</i>	116
9.2.1.	802.11b SISO MODE.....	116
9.2.2.	802.11g SISO MODE.....	122
9.2.3.	802.11n HT20 MIMO MODE	128
9.2.4.	802.11n HT40 MIMO MODE	134
9.3.	<i>SPURIOUS EMISSIONS (1~3GHz)</i>	140
9.3.1.	802.11b MODE.....	140
9.3.2.	802.11g MODE.....	146
9.3.3.	802.11n HT20 MODE	152
9.3.4.	802.11n HT40 MODE	158
9.4.	<i>SPURIOUS EMISSIONS (18~26GHz)</i>	164
9.4.1.	802.11n HT20 MIMO MODE	164
9.5.	<i>SPURIOUS EMISSIONS (0.03 ~ 1 GHz)</i>	166
9.5.1.	802.11n HT20 MIMO MODE	166
9.6.	<i>SPURIOUS EMISSIONS BELOW 30M</i>	168
9.6.1.	802.11n HT20 MIMO MODE	168
10.	AC POWER LINE CONDUCTED EMISSIONS	174
10.1.	802.11n HT20 MIMO MODE.....	175
11.	ANTENNA REQUIREMENTS	177



1. ATTESTATION OF TEST RESULTS

Applicant Information

Company Name: Guangzhou Shikun Electronics Co., Ltd
Address: NO.192 KEZHU ROAD,SCIENCE PARK
GUANGZHOU,GUANGDONG,CHINA

Manufacturer Information

Company Name: Guangzhou Shikun Electronics Co., Ltd
Address: NO.192 KEZHU ROAD,SCIENCE PARK
GUANGZHOU,GUANGDONG,CHINA

EUT Description

EUT Name: IEEE 802.11a/b/g/n/ac 2T2R USB WiFi Module
Model: SKO.W7612U.2
Sample Status: Normal
Sample Received Date: April 21, 2019
Date of Tested: April 22~ 28, 2019

APPLICABLE STANDARDS	
STANDARD	TEST RESULTS
CFR 47 FCC PART 15 SUBPART C	PASS
ISED RSS-247 Issue 2	PASS
ISED RSS-GEN Issue 5	PASS

Prepared By:

Checked By:

Kebo Zhang
Engineer Project Associate
Approved By:

Shawn Wen
Laboratory Leader

Stephen Guo
Laboratory Manager



2. TEST METHODOLOGY

The tests documented in this report were performed in accordance with KDB 558074 D01 15.247 Meas Guidance v05r02, KDB 414788 D01 Radiated Test Site v01r01, CFR 47 FCC Part 2, CFR 47 FCC Part 15, ANSI C63.10-2013, ISED RSS-247 Issue 2 and ISED RSS-GEN Issue 5.

3. FACILITIES AND ACCREDITATION

Accreditation Certificate	<p>A2LA (Certificate No.: 4102.01) UL Verification Services (Guangzhou) Co., Ltd. Song Shan Lake Branch. has been assessed and proved to be in compliance with A2LA.</p> <p>FCC (FCC Designation No.: CN1187) UL Verification Services (Guangzhou) Co., Ltd. Song Shan Lake Branch. Has been recognized to perform compliance testing on equipment subject to the Commission's Declaration of Conformity (DoC) and Certification rules</p> <p>IC(Company No.: 21320) UL Verification Services (Guangzhou) Co., Ltd. Song Shan Lake Branch. has been registered and fully described in a report filed with ISED. The Company Number is 21320.</p> <p>VCCI (Registration No.: G-20019, R-20004, C-20012 and T-20011) UL Verification Services (Guangzhou) Co., Ltd. Song Shan Lake Branch. has been assessed and proved to be in compliance with VCCI, the Membership No. is 3793. Facility Name: Chamber D, the VCCI registration No. is G-20019 and R-20004 Shielding Room B , the VCCI registration No. is C-20012 and T-20011</p>
---------------------------	---

Note 1: All tests measurement facilities use to collect the measurement data are located at Building 10, Innovation Technology Park, Song Shan Lake Hi tech Development Zone, Dongguan, 523808, China

Note 2: The test anechoic chamber in UL Verification Services (Guangzhou) Co., Ltd. Song Shan Lake Branch had been calibrated and compared to the open field sites and the test anechoic chamber is shown to be equivalent to or worst case from the open field site.

Note 3: For below 30MHz, lab had performed measurements at test anechoic chamber and comparing to measurements obtained on an open field site. And these measurements below 30MHz had been correlated to measurements performed on an OFS.



4. CALIBRATION AND UNCERTAINTY

4.1. MEASURING INSTRUMENT CALIBRATION

The measuring equipment utilized to perform the tests documented in this report has been calibrated in accordance with the manufacturer's recommendations, and is traceable to recognize national standards.

4.2. MEASUREMENT UNCERTAINTY

Where relevant, the following measurement uncertainty levels have been estimated for tests performed on the apparatus:

Test Item	Uncertainty
Conduction emission	3.62dB
Radiation Emission test(include Fundamental emission) (9kHz-30MHz)	2.2dB
Radiation Emission test(include Fundamental emission) (30MHz-1GHz)	4.00dB
Radiation Emission test (1GHz to 26GHz)(include Fundamental emission)	5.78dB (1GHz-18Gz)
	5.23dB (18GHz-26Gz)
Note: This uncertainty represents an expanded uncertainty expressed at approximately the 95% confidence level using a coverage factor of k=2.	



5. EQUIPMENT UNDER TEST

5.1. DESCRIPTION OF EUT

EUT Name	IEEE 802.11a/b/g/n/ac 2T2R USB WiFi Module
Model	SKO.W7612U.2
Radio Technology	IEEE802.11b/g/n HT20/HT40
Operation frequency	IEEE 802.11b: 2412MHz—2462MHz IEEE 802.11g: 2412MHz—2462MHz IEEE 802.11n HT20: 2412MHz—2462MHz IEEE 802.11n HT40: 2422MHz—2452MHz
Modulation	IEEE 802.11b: DSSS(CCK) IEEE 802.11g: OFDM(64QAM, 16QAM, QPSK, BPSK) IEEE 802.11n HT20: OFDM (64QAM, 16QAM, QPSK,BPSK) IEEE 802.11n HT40: OFDM (64QAM, 16QAM, QPSK,BPSK)
Rated Input	DC 5V

5.2. MAXIMUM OUTPUT POWER

Number of Transmit Chains (NTX)	IEE Std. 802.11	Frequency (MHz)	Channel Number	Max PK Conducted Power (dBm)
2	IEEE 802.11b SISO	2412-2462	1-11[11]	18.199
2	IEEE 802.11g SISO	2412-2462	1-11[11]	23.723
2	IEEE 802.11nHT20 MIMO	2412-2462	1-11[11]	26.47
2	IEEE 802.11nHT40 MIMO	2422-2452	3-9[7]	26.81



5.3. CHANNEL LIST

Channel List for 802.11b/g/n (20 MHz)							
Channel	Frequency (MHz)	Channel	Frequency (MHz)	Channel	Frequency (MHz)	Channel	Frequency (MHz)
1	2412	4	2427	7	2442	10	2457
2	2417	5	2432	8	2447	11	2462
3	2422	6	2437	9	2452	/	/

Channel List for 802.11n (40 MHz)							
Channel	Frequency (MHz)	Channel	Frequency (MHz)	Channel	Frequency (MHz)	Channel	Frequency (MHz)
3	2422	5	2432	7	2442	9	2452
4	2427	6	2437	8	2447	/	/

5.4. TEST CHANNEL CONFIGURATION

Test Mode	Test Channel	Frequency
WiFi TX(802.11b)	CH 1, CH 6, CH 11	2412MHz, 2437MHz, 2462MHz
WiFi TX(802.11g)	CH 1, CH 6, CH 11	2412MHz, 2437MHz, 2462MHz
WiFi TX(802.11n HT20)	CH 1, CH 6, CH 11	2412MHz, 2437MHz, 2462MHz
WiFi TX(802.11n HT40)	CH 3, CH 6, CH 9	2422MHz, 2437MHz, 2452MHz

5.5. THE WORSE CASE CONFIGURATIONS

The Worst Case Power Setting Parameter under 2400 ~ 2483.5MHz Band										
Test Software		MT7662 QAV1.0.2.8								
Modulation Mode	Transmit Antenna Number	Test Channel								
		NCB: 20MHz			NCB: 40MHz					
		CH 1	CH 6	CH 11	CH 3	CH 6	CH 9			
802.11b	1	default	default	default	/					
	2	default	default	default						
802.11g	1	default	default	default						
	2	default	default	default						
802.11n HT20	1	default	default	default						
	2	default	default	default						
802.11n HT40	1	/						default	default	default
	2	/						default	default	default



5.6. DESCRIPTION OF AVAILABLE ANTENNAS

Antenna	Frequency (MHz)	Antenna Type	MAX Antenna Gain (dBi)
1	2412-2462	PCB Antenna	2.00
2	2412-2462	PCB Antenna	1.45

Note: Directional gain= $10\log[(10^{G1/20} + 10^{G2/20})^2 / N_{ANT}] = 3.74 < 6\text{dBi}$
 N_{ANT} : the number of Antenna

Test Mode	Transmit and Receive Mode	Description
IEEE 802.11b	<input checked="" type="checkbox"/> 2TX, 2RX	ANT 1, 2 can be used as transmitting/receiving antenna.
IEEE 802.11g	<input checked="" type="checkbox"/> 2TX, 2RX	ANT 1, 2 can be used as transmitting/receiving antenna.
IEEE 802.11n HT20	<input checked="" type="checkbox"/> 2TX, 2RX	ANT 1, 2 can be used as transmitting/receiving antenna.
IEEE 802.11n HT40	<input checked="" type="checkbox"/> 2TX, 2RX	ANT 1, 2 can be used as transmitting/receiving antenna.
Note: 1. Only 802.11n HT20/HT40 support MIMO mode 2. WLAN 2.4G & WLAN 5G can't transmit simultaneously. (declared by client)		

5.7. THE WORSE CASE CONFIGURATIONS

For SISO modes, there are two transmission antennas. The antenna used in any given time can be either ANTENNA 1 or ANTENNA 2. All antenna ports have the same power; so only the worst data for antenna1 are recorded in the report.

For 2TX MIMO modes, ANTENNA 1 and ANTENNA 2, used at the same time and have the same power setting, so only the worst MIMO mode test data were recorded in the report.

Worst-case data rates as provided by the client were:

- 802.11b mode: 1 Mbps
- 802.11b mode: 6 Mbps
- 802.11n HT20 mode: MCS0
- 802.11n HT40 mode: MCS0



5.8. DESCRIPTION OF TEST SETUP

SUPPORT EQUIPMENT

Item	Equipment	Brand Name	Model Name	P/N
1	PC	Dell	Vostro 3902	8KNDDDB2
2	Debug	N/A	N/A	N/A

I/O CABLES

Cable No	Port	Connector Type	Cable Type	Cable Length(m)	Remarks
1	PCIEX	N/A	N/A	0.1	N/A
2	USB	N/A	N/A	0.5	N/A

ACCESSORIES

Item	Accessory	Brand Name	Model Name	Description
1	Power Adapter	N/A	HW-120150E2W	INPUT:100-240V~50/60Hz, 0.5A OUTPUT:12.0V, 1.5A

TEST SETUP

The EUT can work in engineering mode with a software through a Laptop.

SETUP DIAGRAM FOR TESTS

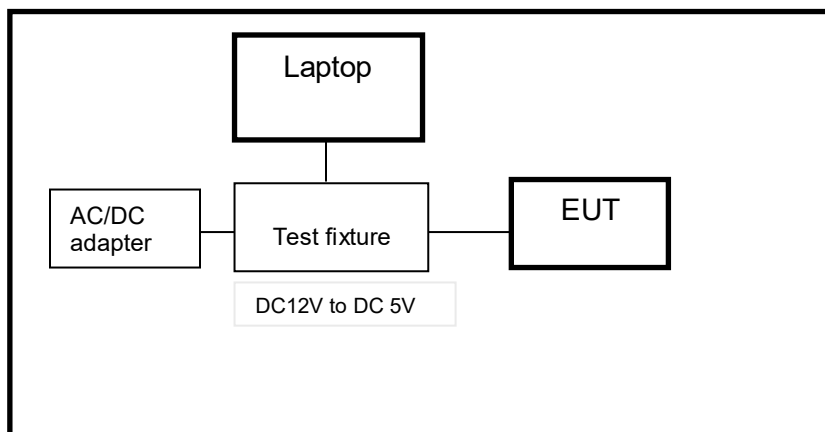



6. MEASURING INSTRUMENT AND SOFTWARE USED

Conducted Emissions						
Instrument						
Used	Equipment	Manufacturer	Model No.	Serial No.	Last Cal.	Next Cal.
<input checked="" type="checkbox"/>	EMI Test Receiver	R&S	ESR3	101961	Dec.10,2018	Dec.10,2019
<input checked="" type="checkbox"/>	Two-Line V-Network	R&S	ENV216	101983	Dec.10,2018	Dec.10,2019
<input checked="" type="checkbox"/>	Artificial Mains Networks	Schwarzbeck	NSLK 8126	8126465	Dec.10,2018	Dec.10,2019
Software						
Used	Description	Manufacturer	Name	Version		
<input checked="" type="checkbox"/>	Test Software for Conducted disturbance	Farad	EZ-EMC	Ver. UL-3A1		
Radiated Emissions						
Instrument						
Used	Equipment	Manufacturer	Model No.	Serial No.	Last Cal.	Next Cal.
<input checked="" type="checkbox"/>	MXE EMI Receiver	KESIGHT	N9038A	MY56400036	Dec.10,2018	Dec.10,2019
<input checked="" type="checkbox"/>	Hybrid Log Periodic Antenna	TDK	HLP-3003C	130960	Sep.17, 2018	Sep.17, 2021
<input checked="" type="checkbox"/>	Preamplifier	HP	8447D	2944A09099	Dec.10,2018	Dec.10,2019
<input checked="" type="checkbox"/>	EMI Measurement Receiver	R&S	ESR26	101377	Dec.10,2018	Dec.10,2019
<input checked="" type="checkbox"/>	Horn Antenna	TDK	HRN-0118	130939	Sep.17, 2018	Sep.17, 2021
<input checked="" type="checkbox"/>	High Gain Horn Antenna	Schwarzbeck	BBHA-9170	691	Aug.11, 2018	Aug.11, 2021
<input checked="" type="checkbox"/>	Preamplifier	TDK	PA-02-0118	TRS-305-00066	Dec.10,2018	Dec.10,2019
<input checked="" type="checkbox"/>	Preamplifier	TDK	PA-02-2	TRS-307-00003	Dec.10,2018	Dec.10,2019
<input checked="" type="checkbox"/>	Loop antenna	Schwarzbeck	1519B	00008	Mar.26,2016	Mar.25, 2019
<input checked="" type="checkbox"/>	Band Reject Filter	Wainwright	WRCJV8-2350-2400-2483.5-2533.5-40SS	4	Dec.10,2018	Dec.10,2019
<input checked="" type="checkbox"/>	High Pass Filter	Wi	WHKX10-2700-3000-18000-40SS	23	Dec.10,2018	Dec.10,2019
Software						
Used	Description	Manufacturer	Name	Version		
<input checked="" type="checkbox"/>	Test Software for Radiated disturbance	Farad	EZ-EMC	Ver. UL-3A1		



Other instruments						
Used	Equipment	Manufacturer	Model No.	Serial No.	Last Cal.	Next Cal.
<input checked="" type="checkbox"/>	Spectrum Analyzer	Keysight	N9030A	MY55410512	Dec.10,2018	Dec.10,2019
<input checked="" type="checkbox"/>	Power Meter	Keysight	N1911A	MY55416024	Dec.10,2018	Dec.10,2019
<input checked="" type="checkbox"/>	Power Sensor	Keysight	U2021XA	MY5100022	Dec.10,2018	Dec.10,2019

7. MEASUREMENT METHODS

No.	Test Item	KDB Name	Section
1	6dB Bandwidth	KDB 558074 D01 15.247 Meas Guidance v05r02	8.2
2	Peak Output Power	KDB 558074 D01 15.247 Meas Guidance v05r02	8.3.1.3/8.3.2.3
3	Power Spectral Density	KDB 558074 D01 15.247 Meas Guidance v05r02	8.4
4	Out-of-band emissions in non-restricted bands	KDB 558074 D01 15.247 Meas Guidance v05r02	8.5
5	Out-of-band emissions in restricted bands	KDB 558074 D01 15.247 Meas Guidance v05r02	8.6
6	Band-edge	KDB 558074 D01 15.247 Meas Guidance v05r02	8.7
7	Conducted Emission Test For AC Power Port	ANSI C63.10-2013	6.2
8	99% Bandwidth	ANSI C63.10-2013	6.9.3



8. ANTENNA PORT TEST RESULTS

8.1. ON TIME AND DUTY CYCLE

LIMITS

None; for reporting purposes only

PROCEDURE

KDB 558074 Zero-Span Spectrum Analyzer Method

TEST SETUP

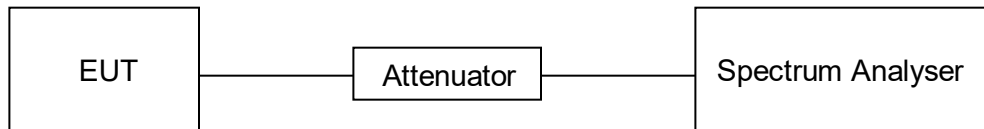

TEST ENVIRONMENT

Temperature	24.6°C	Relative Humidity	56%
Atmosphere Pressure	101kPa	Test Voltage	AC 120V,60Hz

RESULTS

ANTENNA1

Mode	On Time (msec)	Period (msec)	Duty Cycle x (Linear)	Duty Cycle (%)	Duty Cycle Correction Factor (dB)	1/T Minimum VBW (KHz)	Final setting For VBW (KHz)
11b 1TX	120.3	120.3	1	100	0	0.008	0.01
11g 1TX	120.8	120.8	1	100	0	0.008	0.01
11n20 CDD	119.7	119.7	1	100	0	0.008	0.01
11n40 CDD	120.2	120.2	1	100	0	0.008	0.01

Note:

Duty Cycle Correction Factor=10log (1/x).

Where: x is Duty Cycle (Linear)

Where: T is On Time

If that calculated VBW is not available on the analyzer then the next higher value should be used.

Antenna 1 and Antenna 2 has the same duty cycle, only ANT 1 data show here.

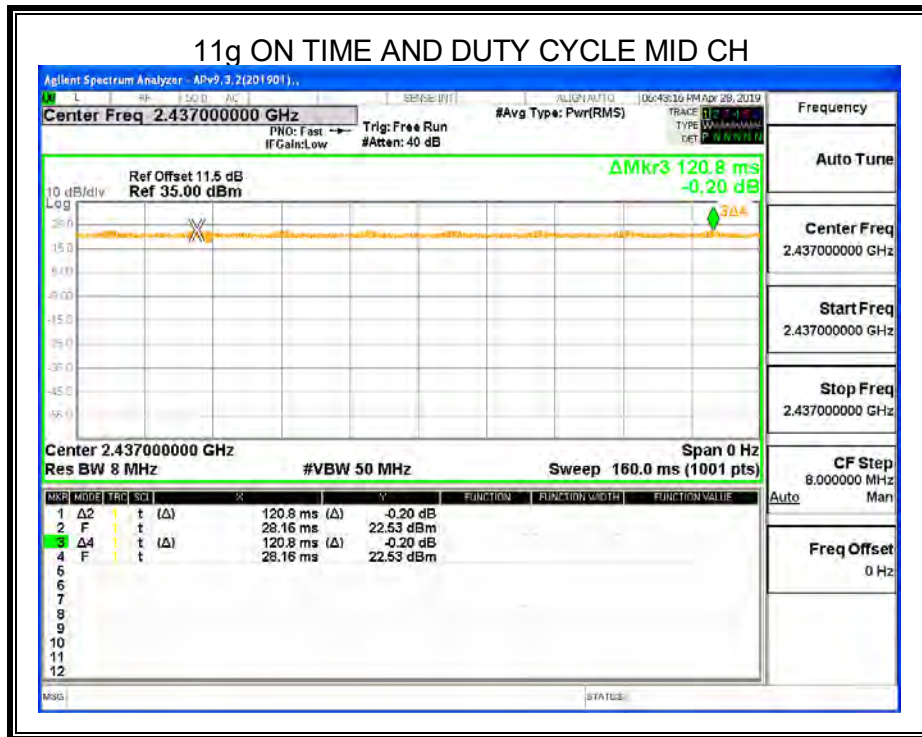
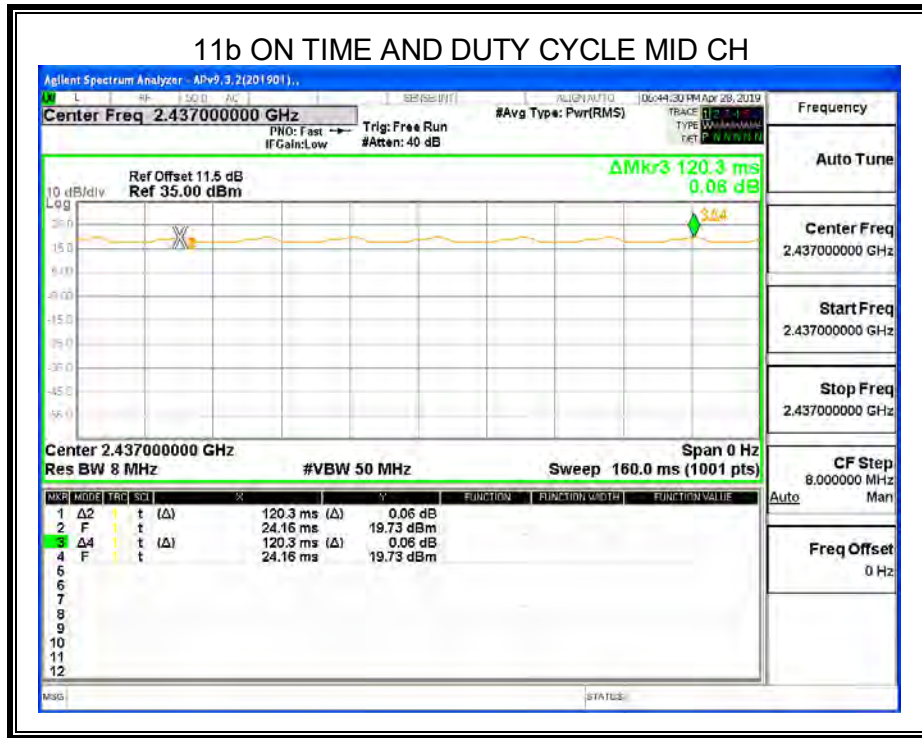

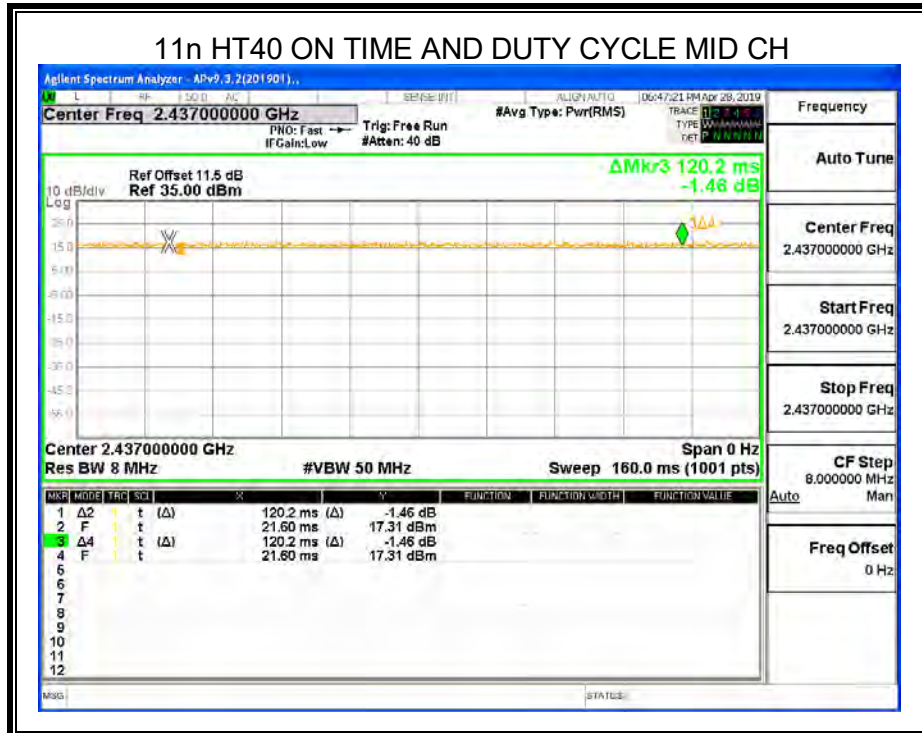
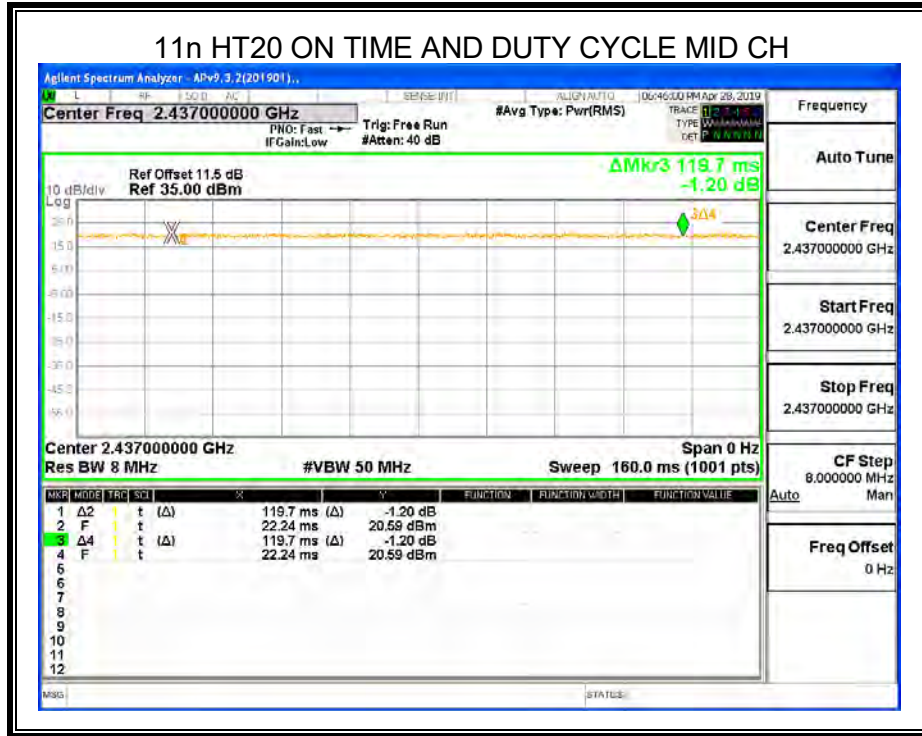

8.2. 6 dB DTS BANDWIDTH AND 99% OCCUPIED BANDWIDTH

LIMITS

CFR 47 FCC Part15 (15.247) Subpart C ISED RSS-247 ISSUE 2			
Section	Test Item	Limit	Frequency Range (MHz)
CFR 47 FCC 15.247(a)(2) ISED RSS-247 5.2 (a)	6 dB Bandwidth	≥ 500KHz	2400-2483.5
ISED RSS-Gen Clause 6.7	99% Occupied Bandwidth	For reporting purposes only.	2400-2483.5

TEST PROCEDURE

Connect the UUT to the spectrum analyser and use the following settings:

Center Frequency	The centre frequency of the channel under test
Detector	Peak
RBW	For 6dB Bandwidth :100K For 99% Occupied Bandwidth :1% to 5% of the occupied bandwidth
VBW	For 6dB Bandwidth : ≥3 × RBW For 99% Occupied Bandwidth : approximately 3×RBW
Trace	Max hold
Sweep	Auto couple

Allow the trace to stabilize and measure the maximum width of the emission that is constrained by the frequencies associated with the two outermost amplitude points (upper and lower frequencies) that are attenuated by 6 dB and 99% relative to the maximum level measured in the fundamental emission.

TEST SETUP

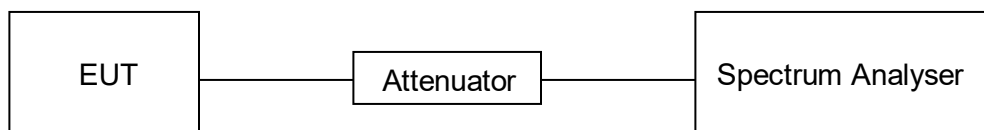



TEST ENVIRONMENT

Temperature	24.6°C	Relative Humidity	56%
Atmosphere Pressure	101kPa	Test Voltage	AC 120V,60Hz

RESULTS

8.2.1. 802.11b SISO MODE

ANTENNA1

Channel	6dB bandwidth (MHz)	99% bandwidth (MHz)	Limit (kHz)	Result
Low	10.04	12.216	≥500	Pass
Middle	9.80	12.213	≥500	Pass
High	9.84	12.200	≥500	Pass

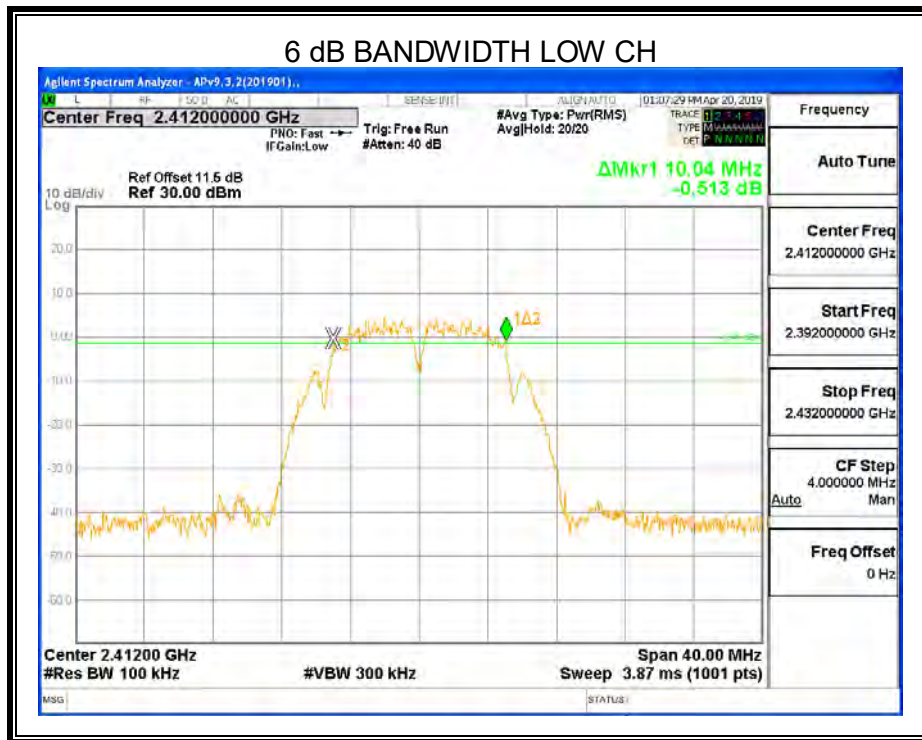

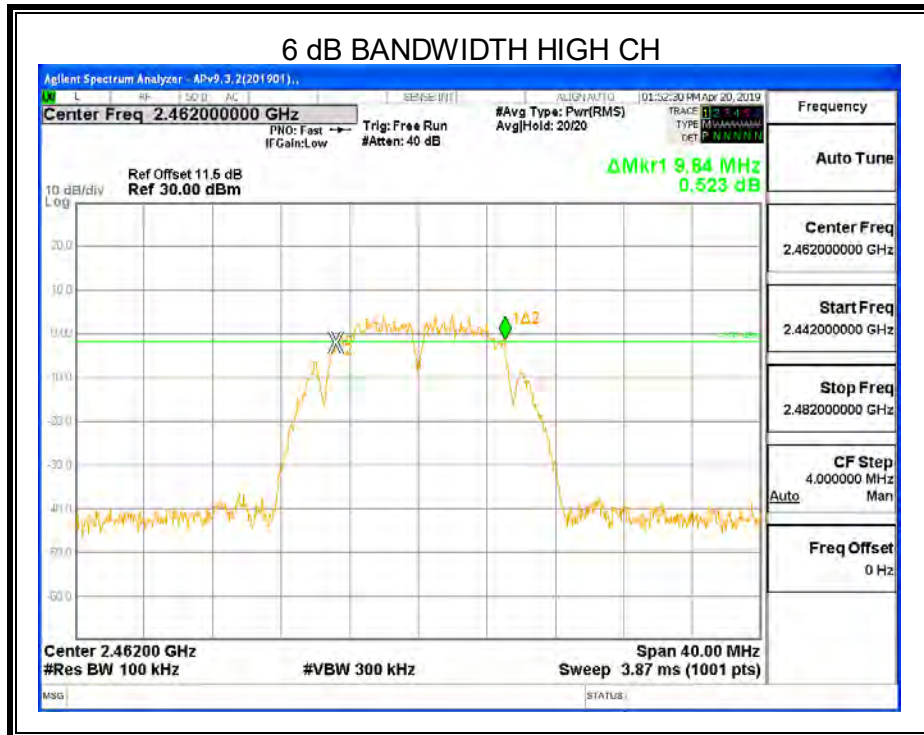
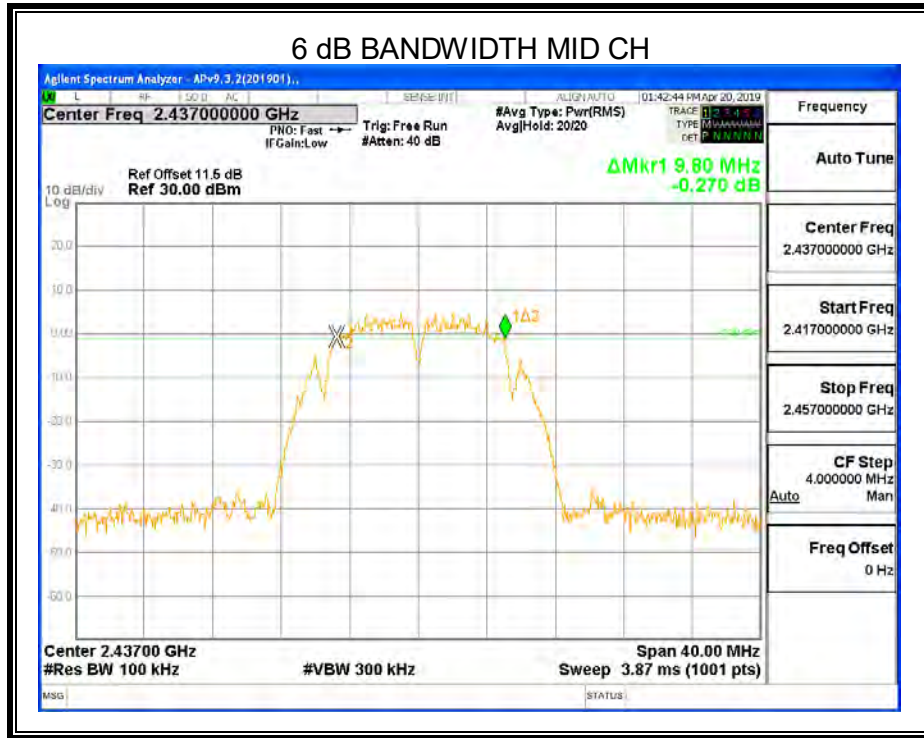

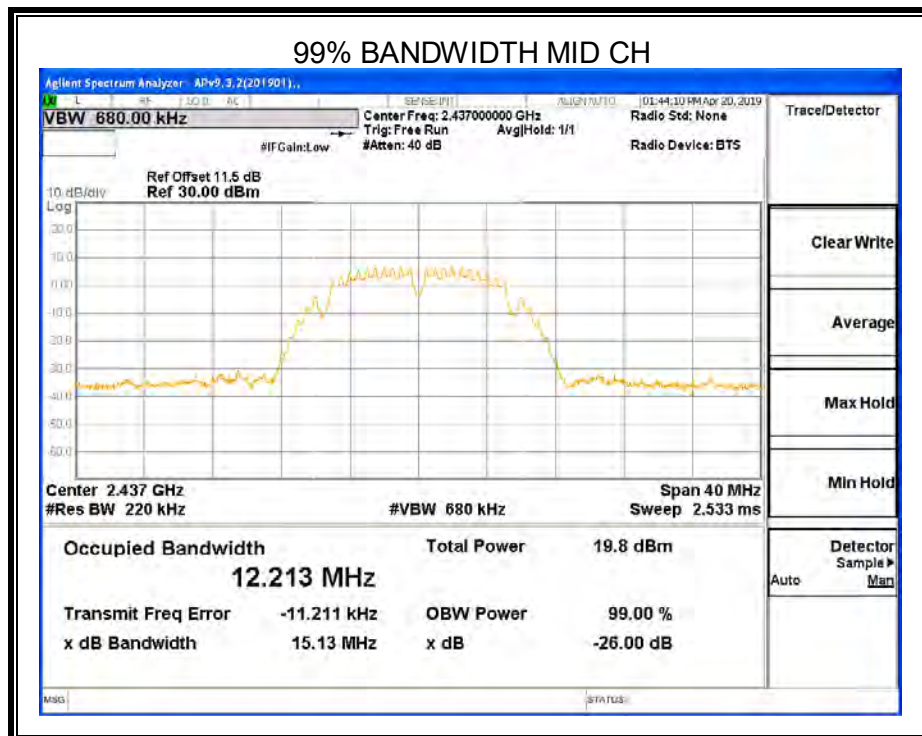
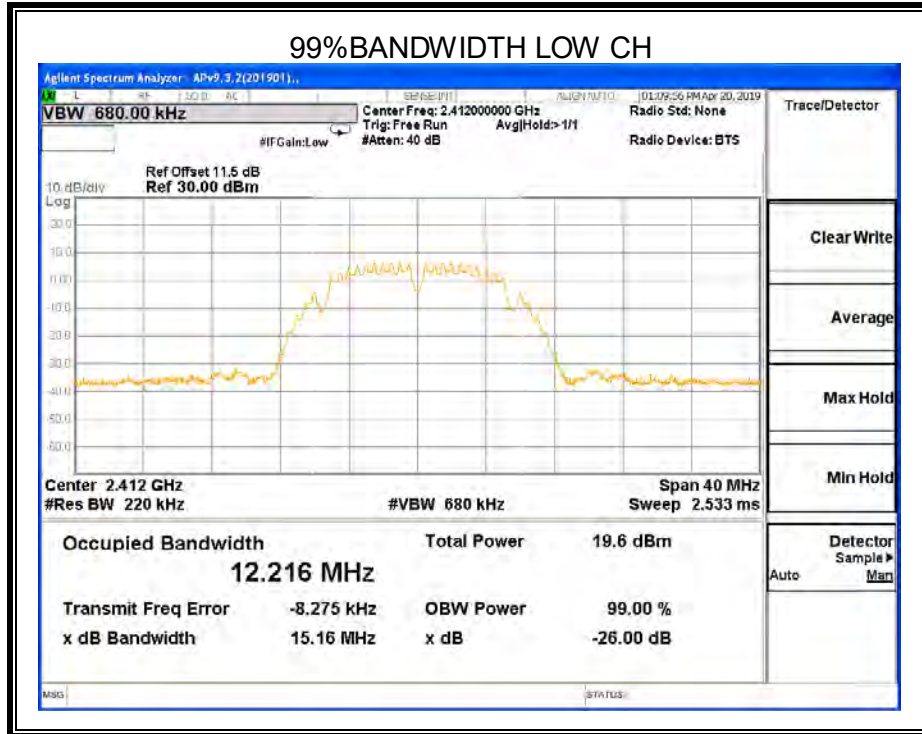

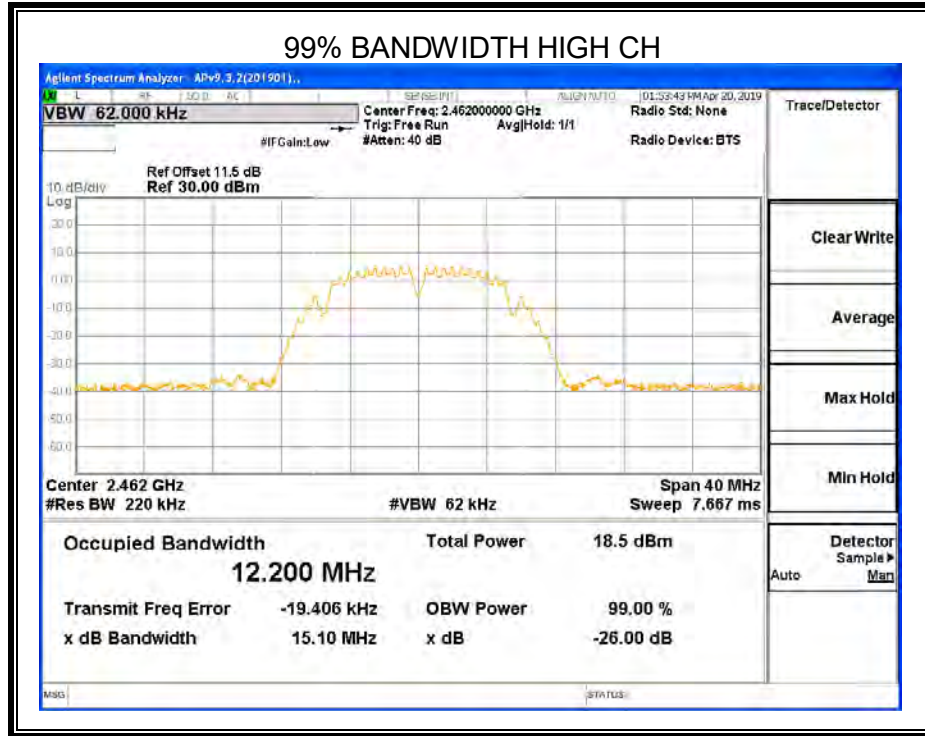

Note: All the modes and antenna ports had been tested, only the worst data recorded in the report.



8.2.2. 802.11g SISO MODE

ANTENNA1

Channel	6dB bandwidth (MHz)	99% bandwidth (MHz)	Limit (kHz)	Result
Low	16.48	17.072	≥500	Pass
Middle	17.56	17.518	≥500	Pass
High	17.56	17.525	≥500	Pass

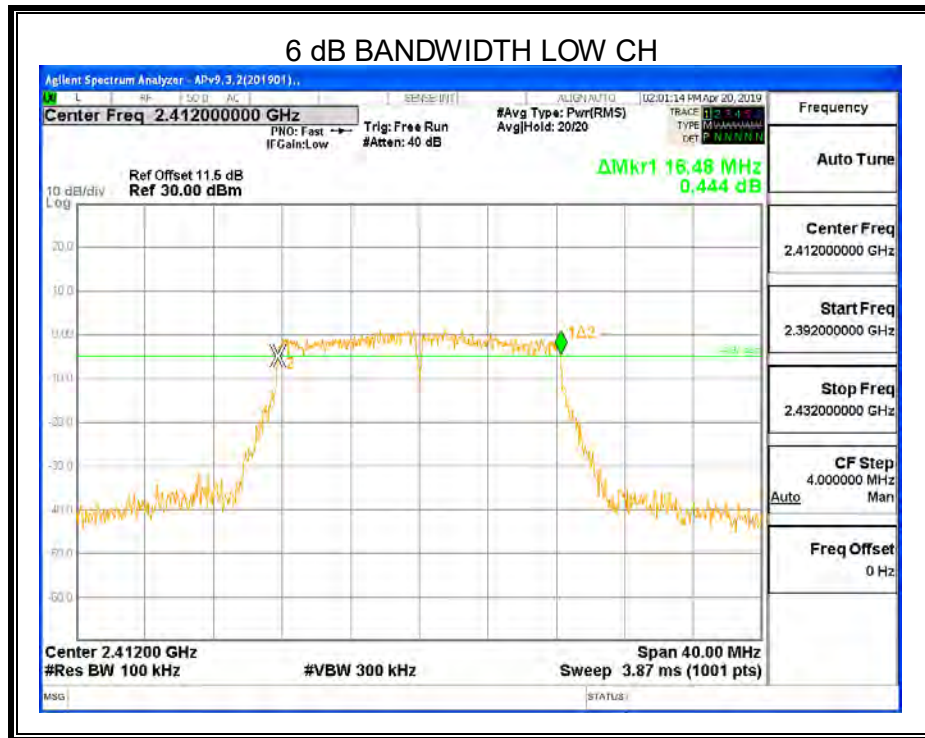

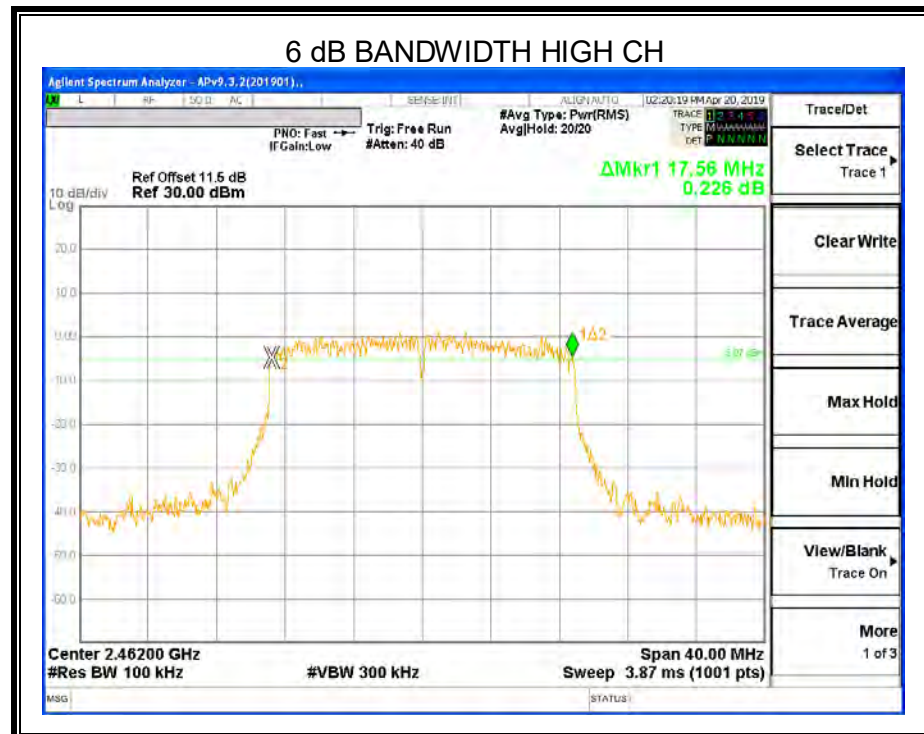
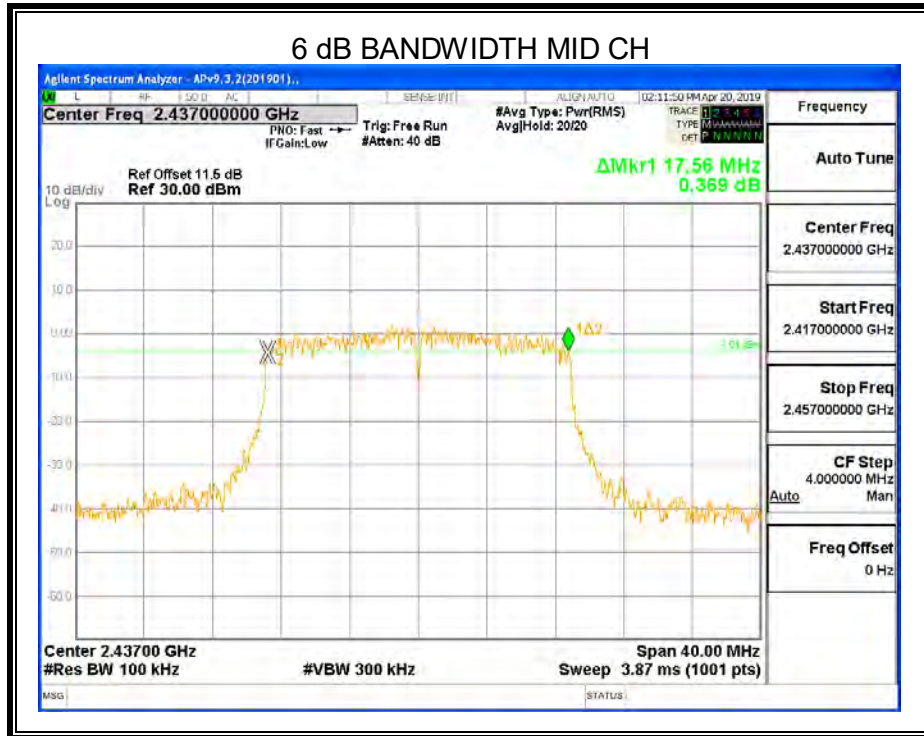

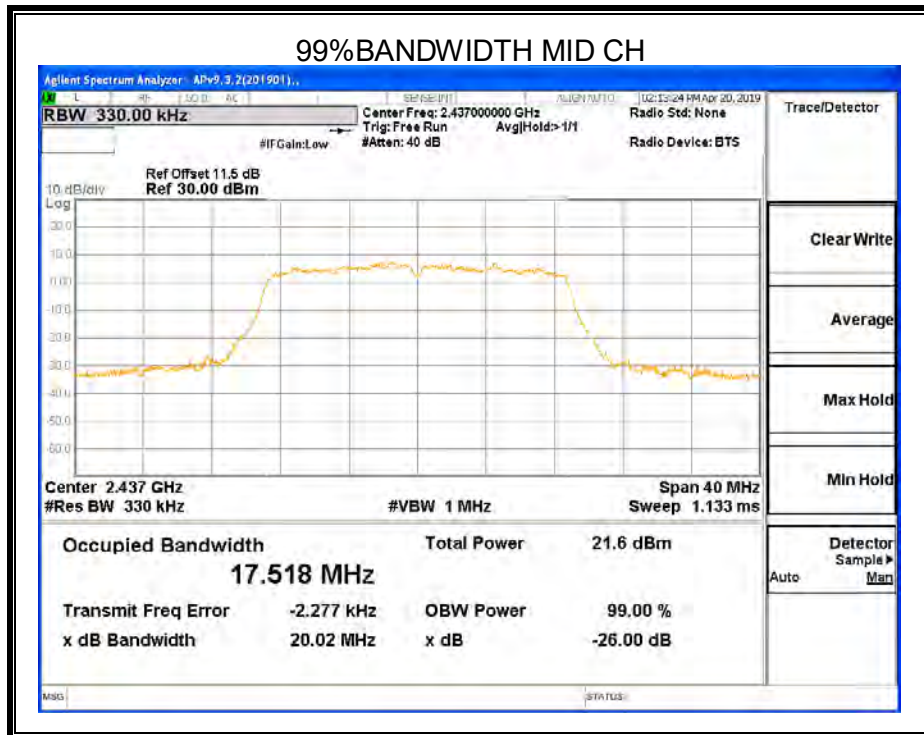
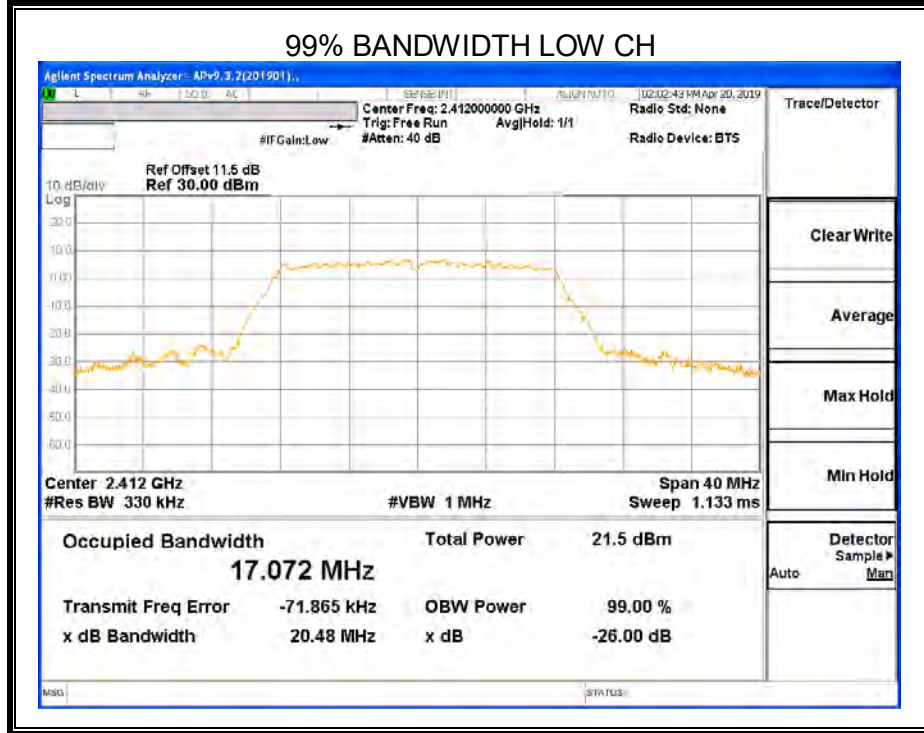

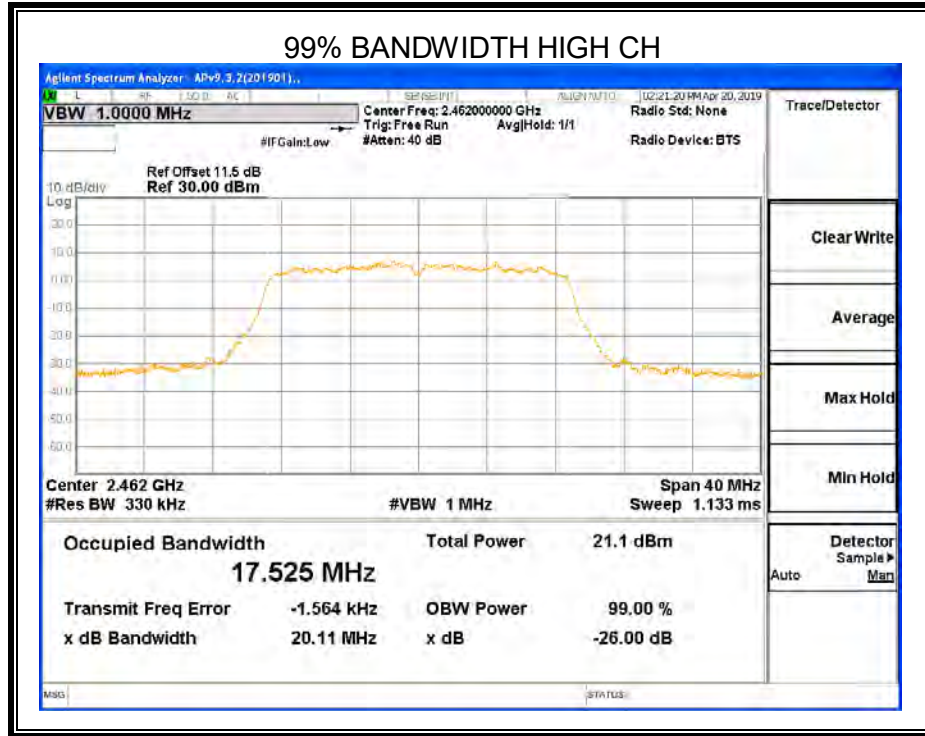

Note: All the modes and antenna ports had been tested, only the worst data recorded in the report.



8.2.3. 802.11n HT20 MIMO MODE

ANTENNA1

Channel	6dB bandwidth (MHz)	99% bandwidth (MHz)	Limit (kHz)	Result
Low	17.64	17.757	≥500	Pass
Middle	17.64	17.696	≥500	Pass
High	17.64	17.700	≥500	Pass

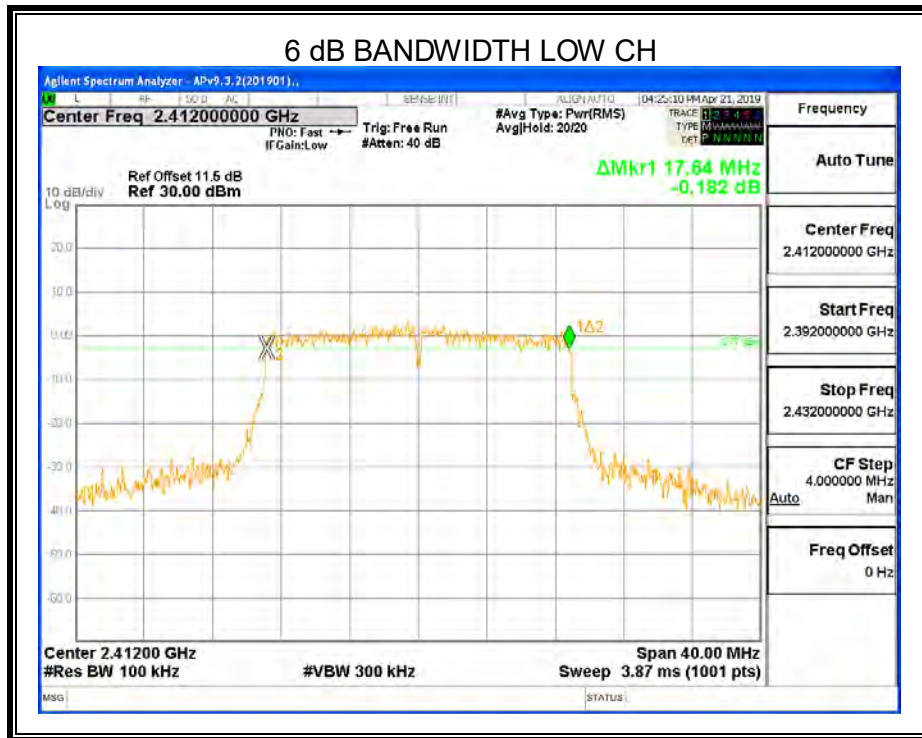

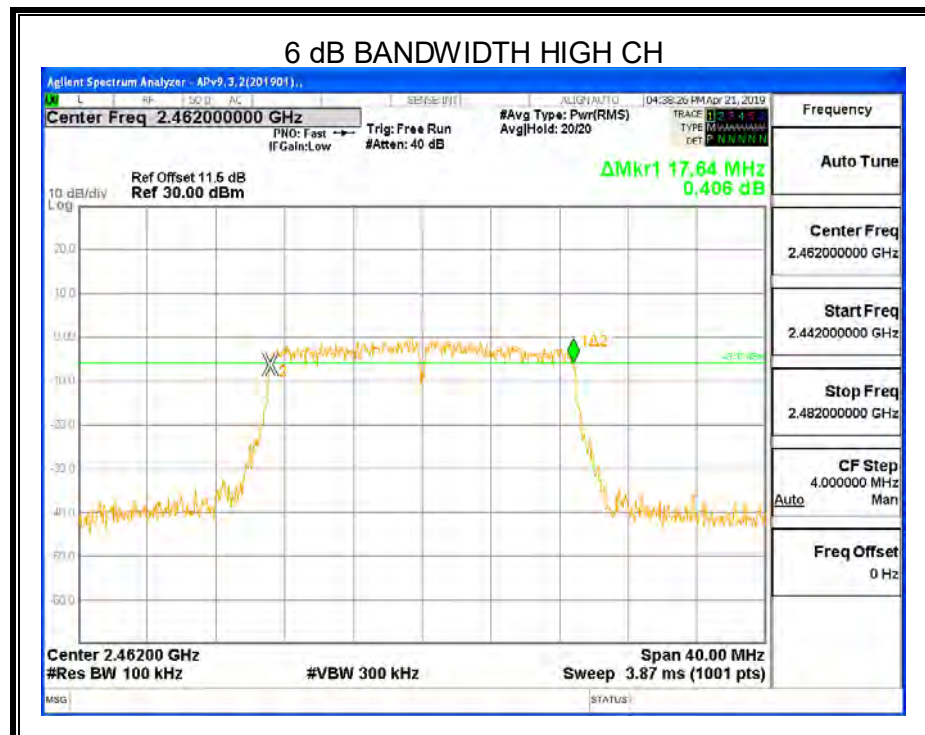
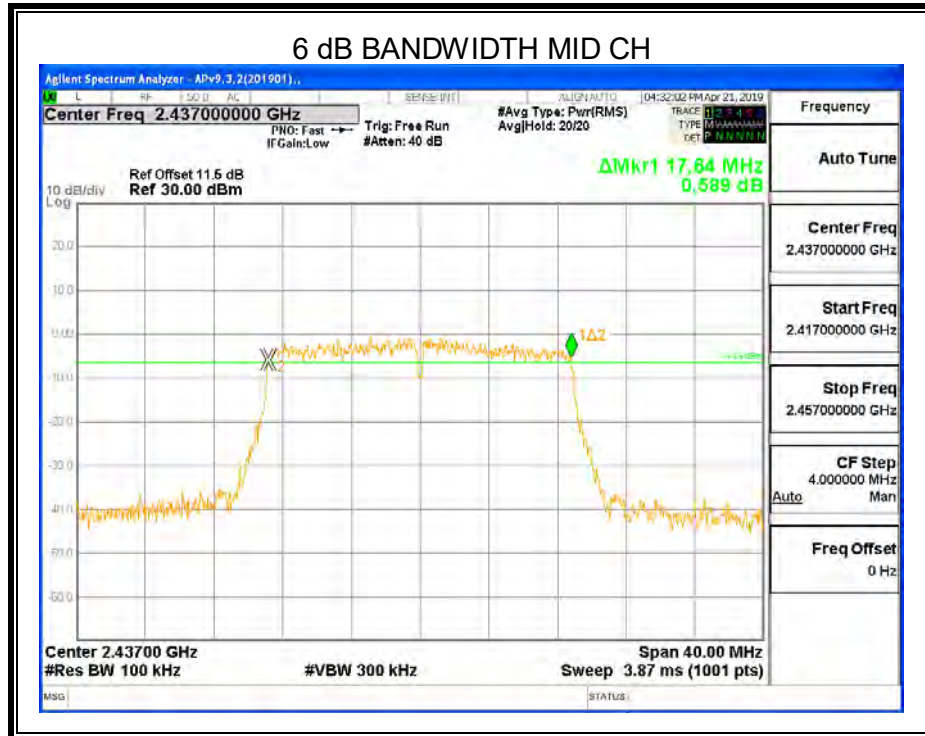

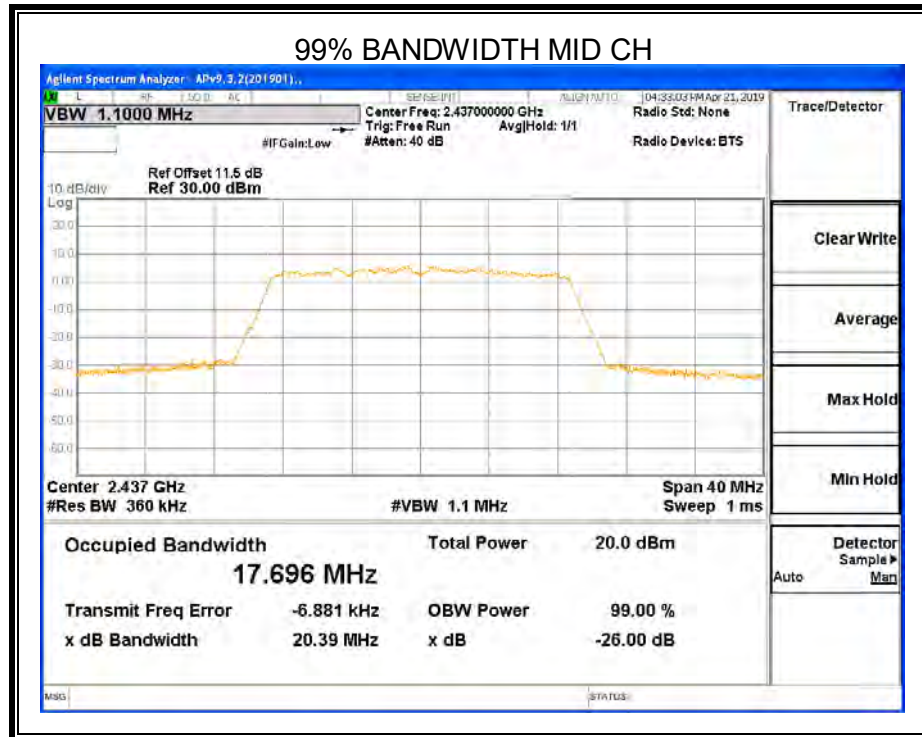
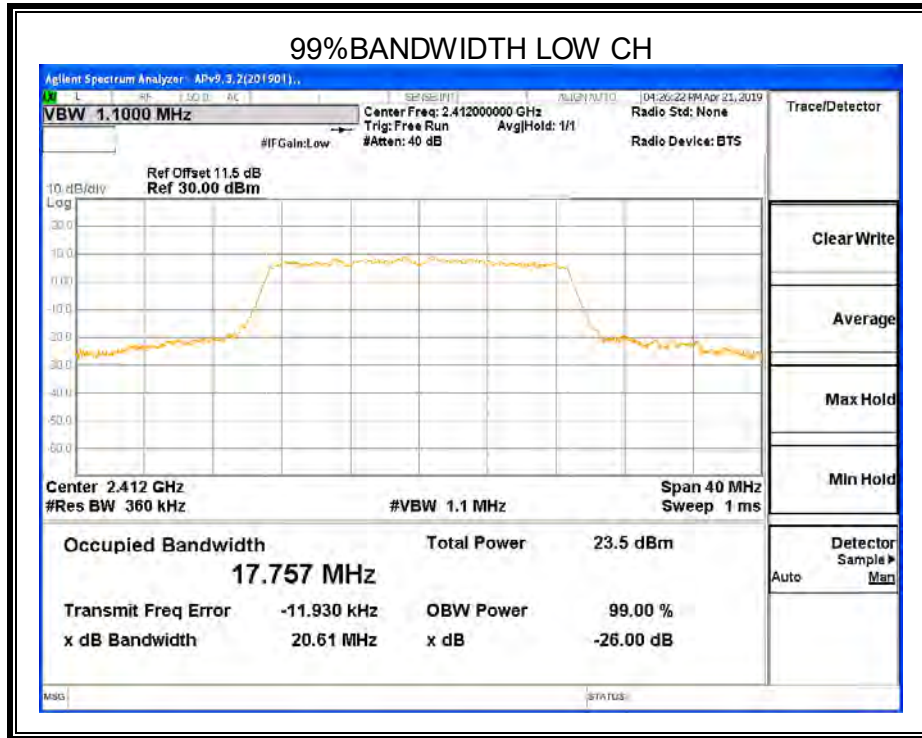

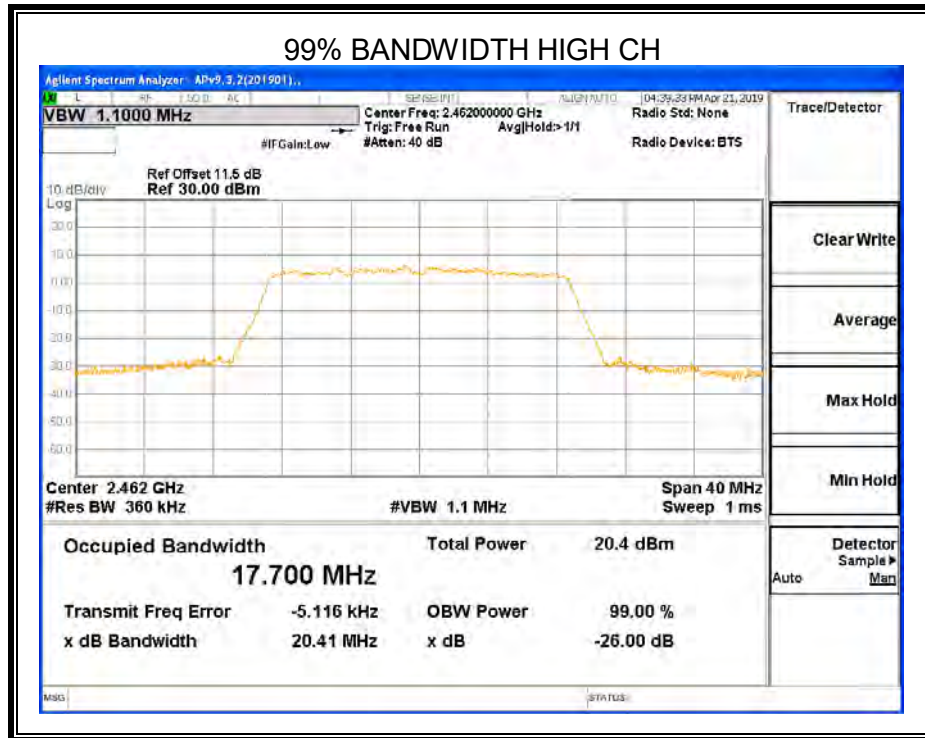



ANTENNA2

Channel	6dB bandwidth (MHz)	99% bandwidth (MHz)	Limit (kHz)	Result
Low	17.68	17.710	≥500	Pass
Middle	17.60	17.701	≥500	Pass
High	17.68	17.702	≥500	Pass

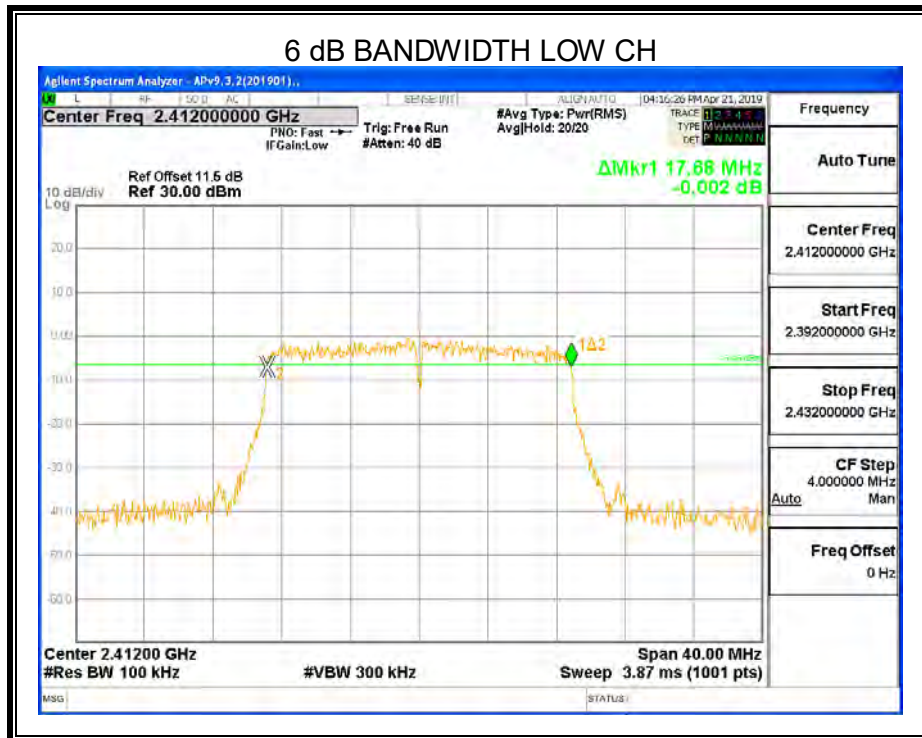

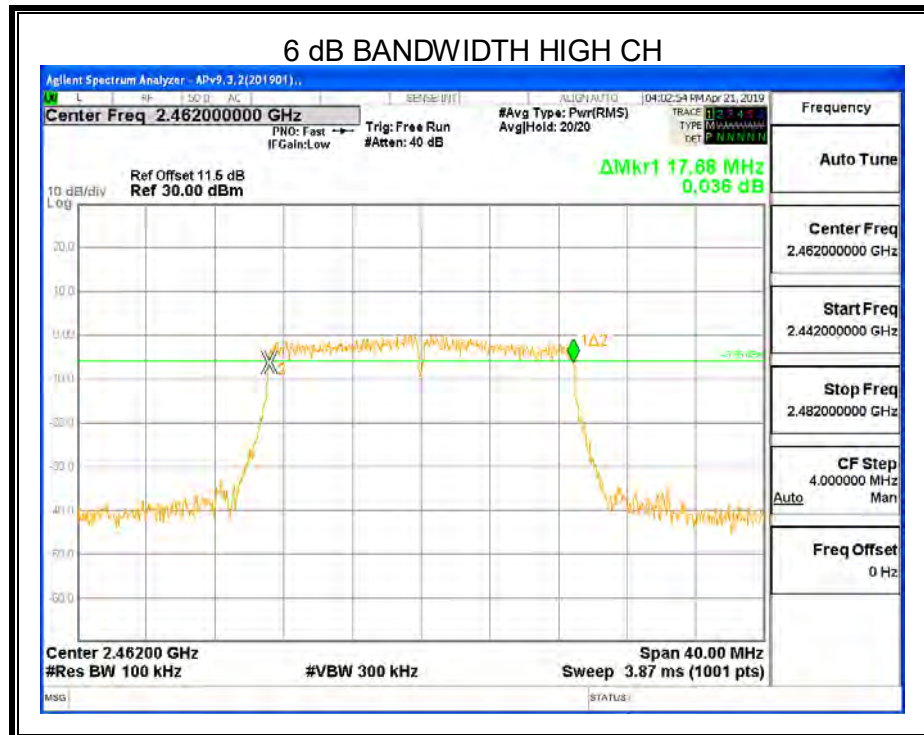
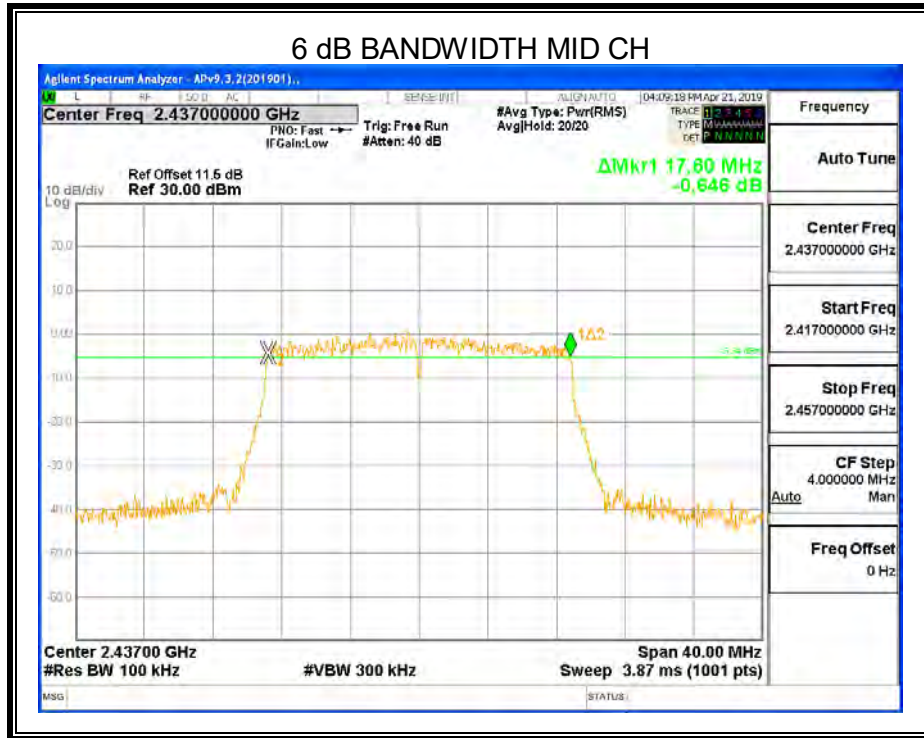

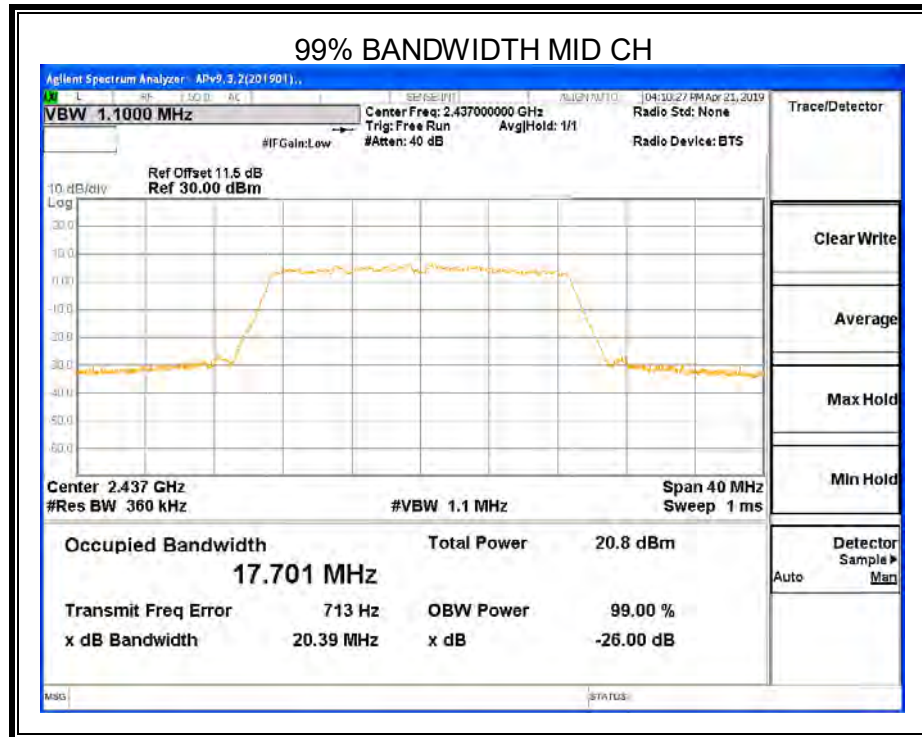
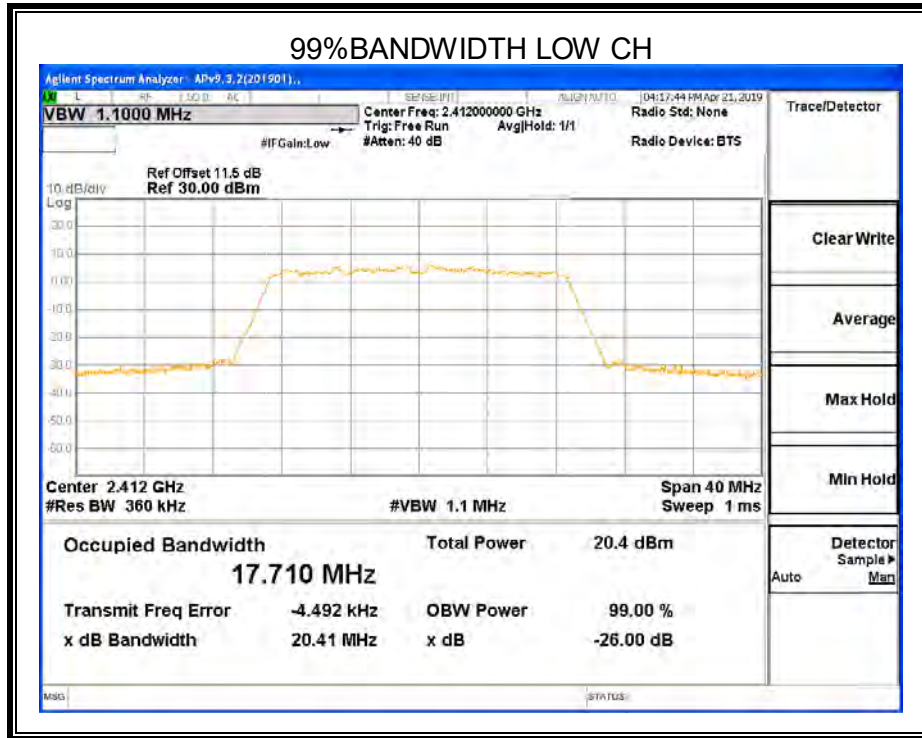

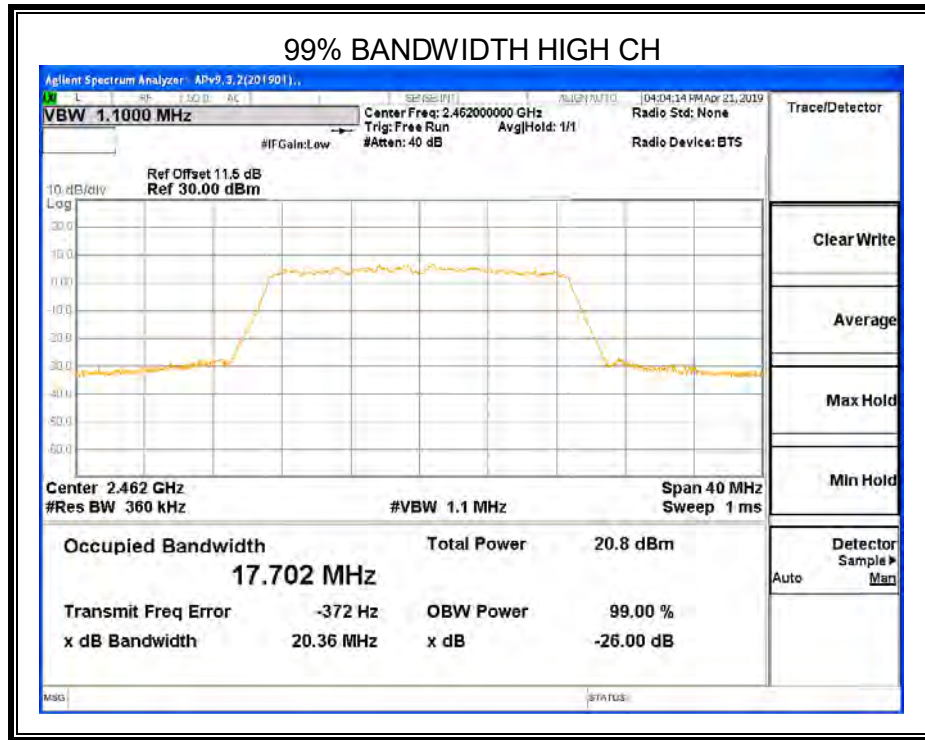

Note: All the modes and antenna ports had been tested, only the worst data recorded in the report.



8.2.4. 802.11n HT40 MIMO MODE

ANTENNA1

Channel	6dB bandwidth (MHz)	99% bandwidth (MHz)	Limit (kHz)	Result
Low	36.40	36.354	≥500	Pass
Middle	36.40	36.332	≥500	Pass
High	36.40	36.251	≥500	Pass

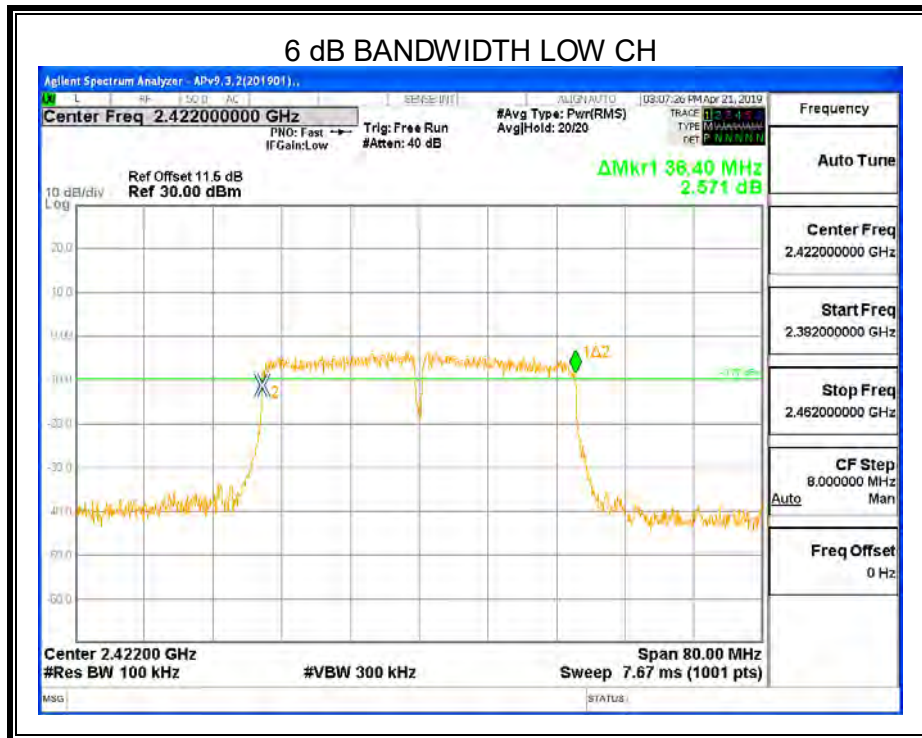

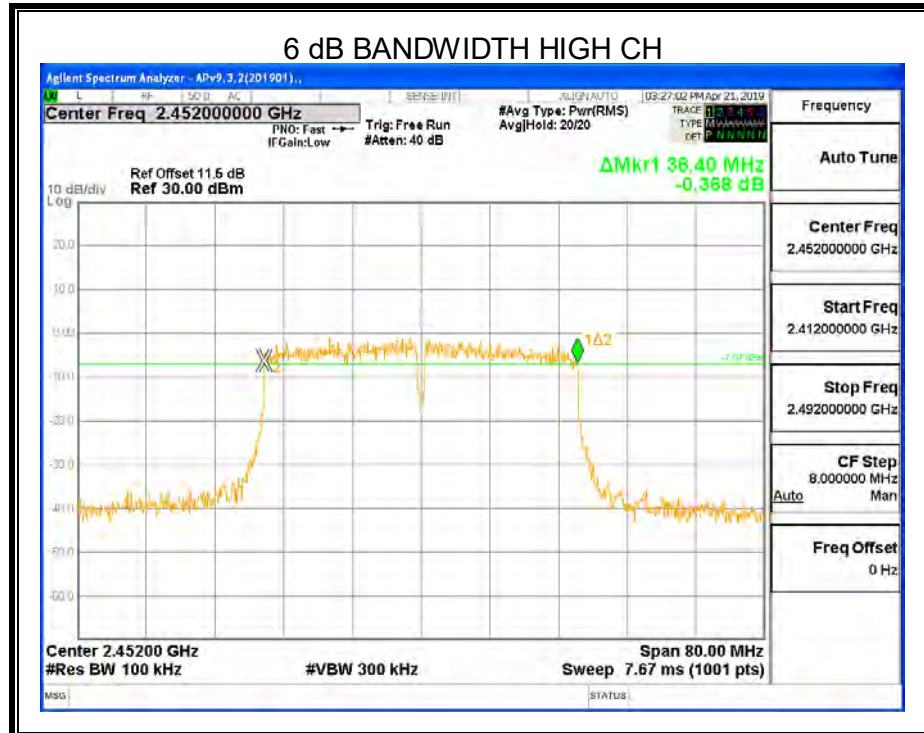
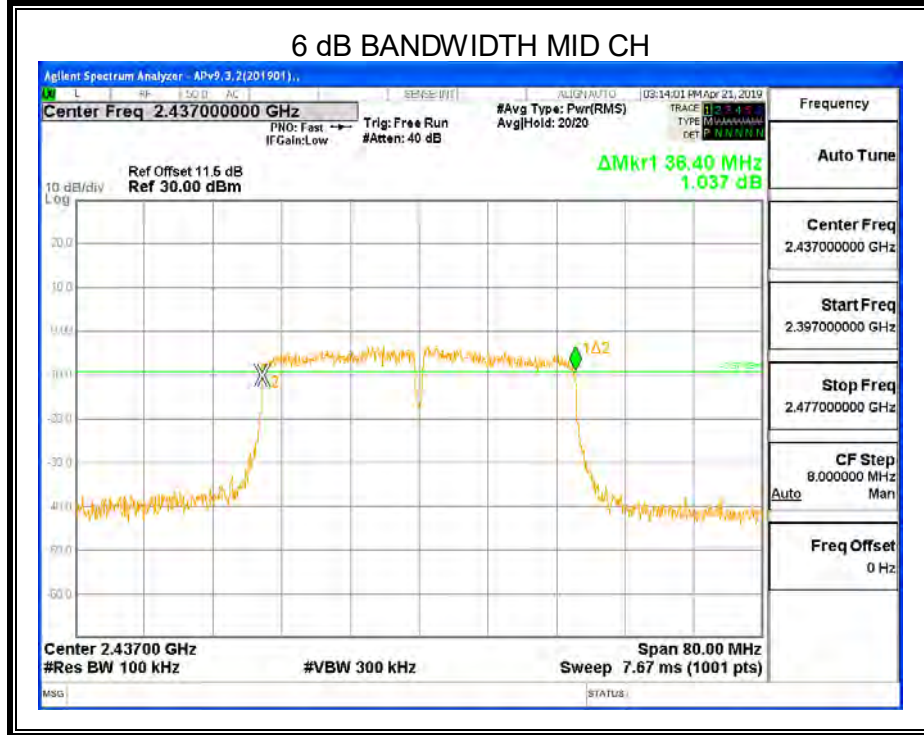

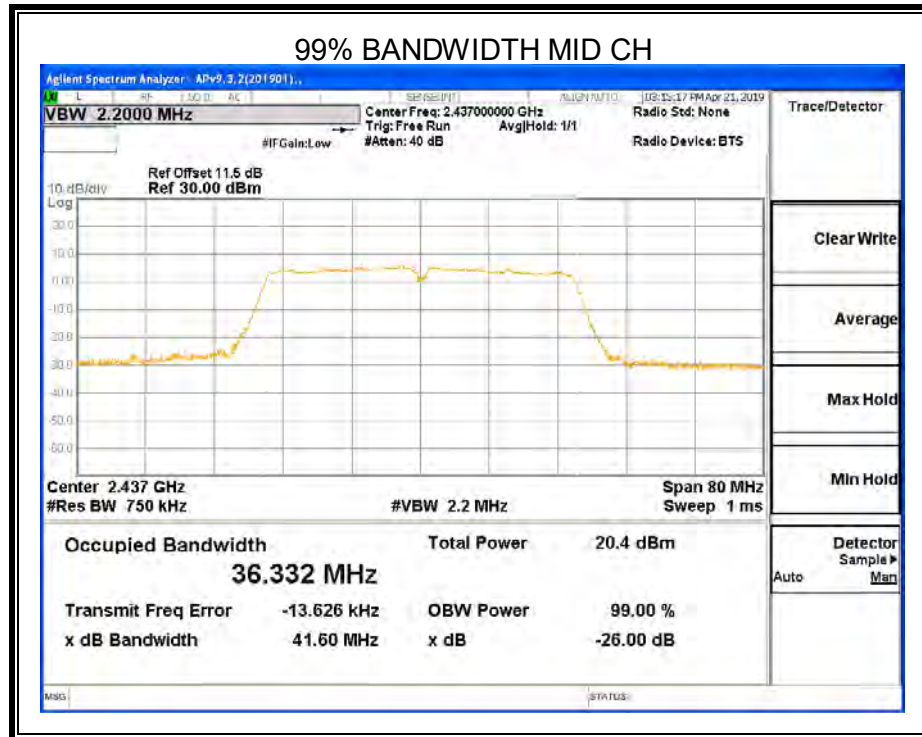
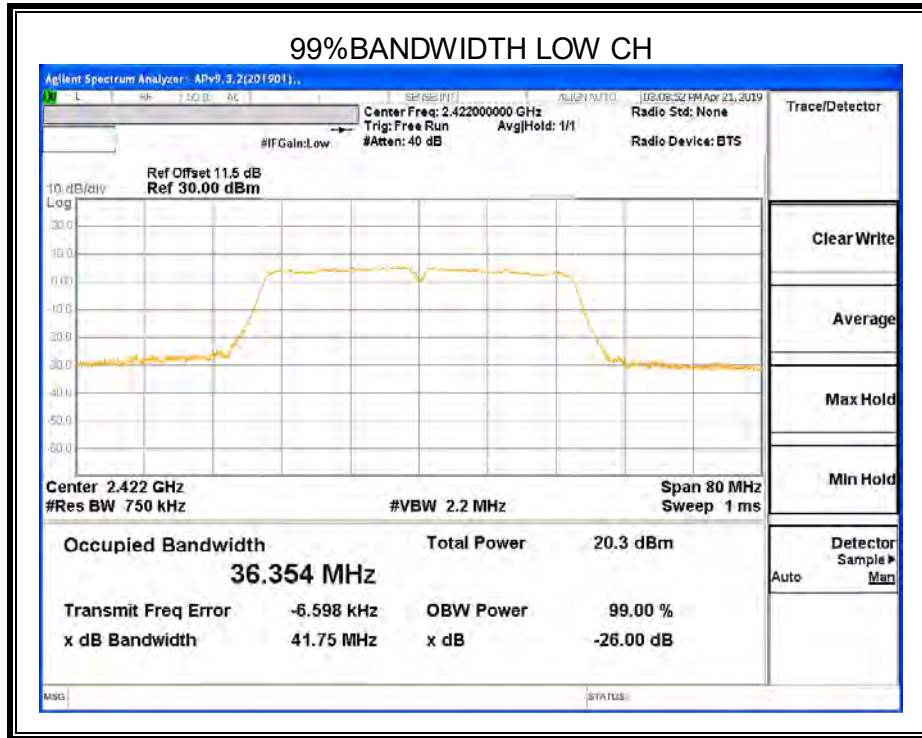

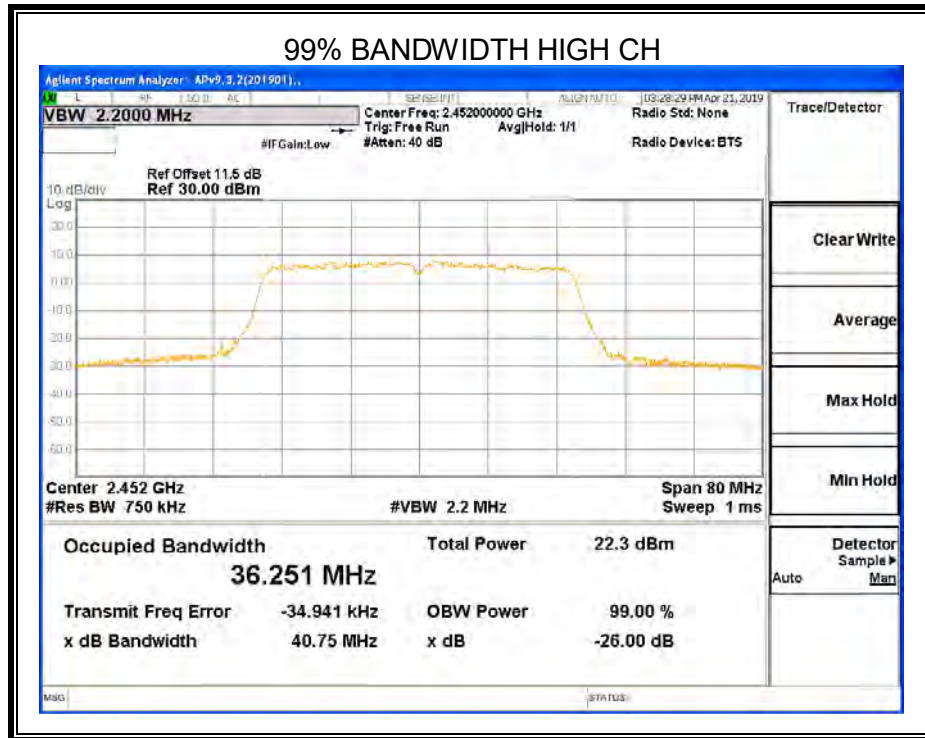



ANTENNA2

Channel	6dB bandwidth (MHz)	99% bandwidth (MHz)	Limit (kHz)	Result
Low	36.40	36.324	≥500	Pass
Middle	36.24	36.361	≥500	Pass
High	35.84	36.198	≥500	Pass

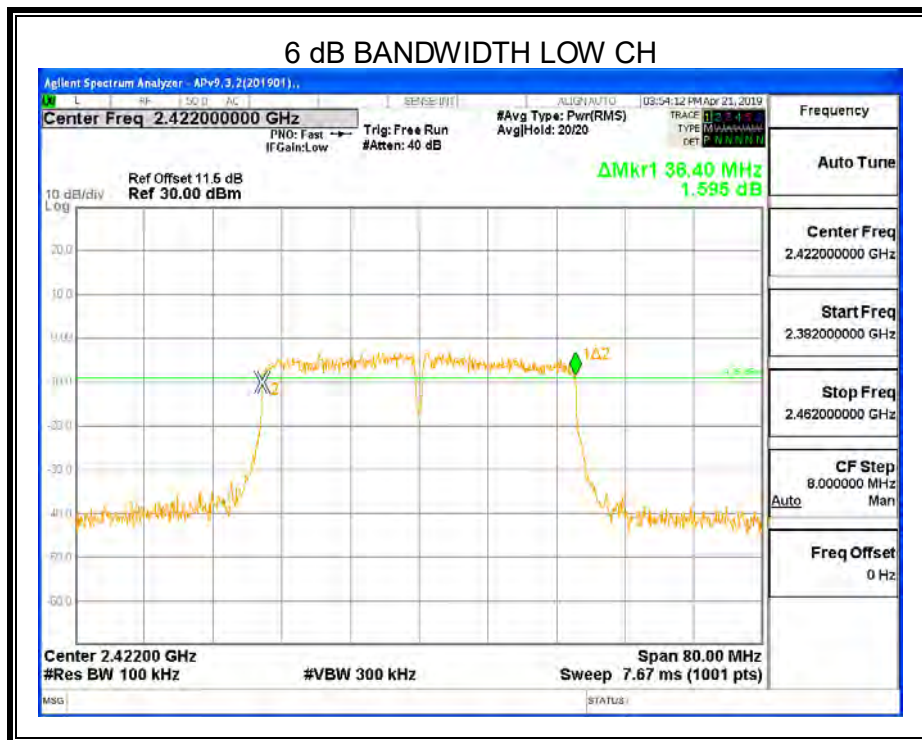

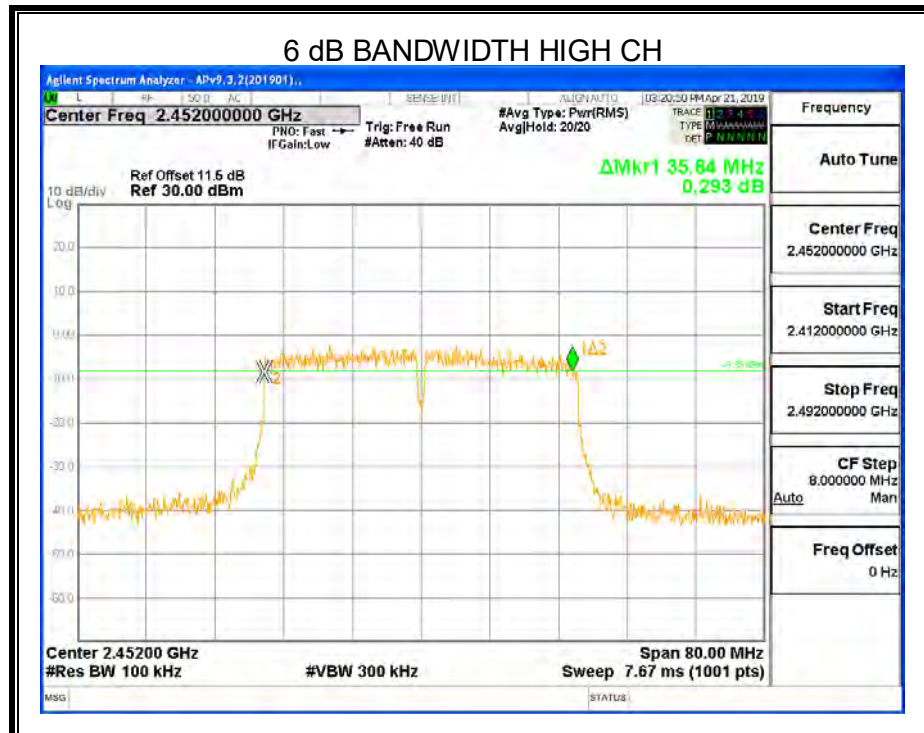
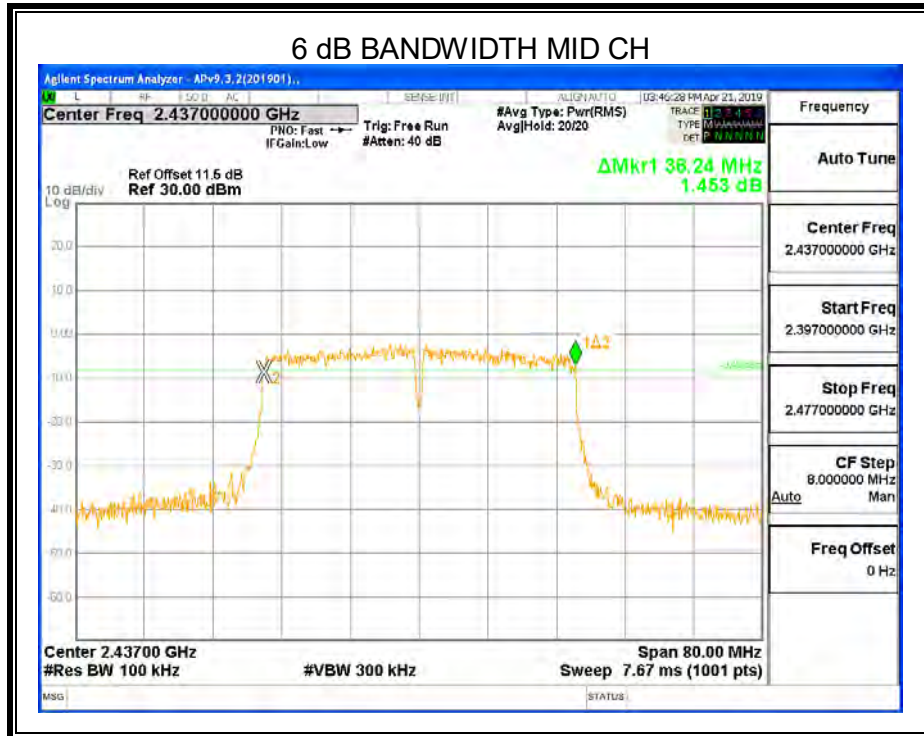

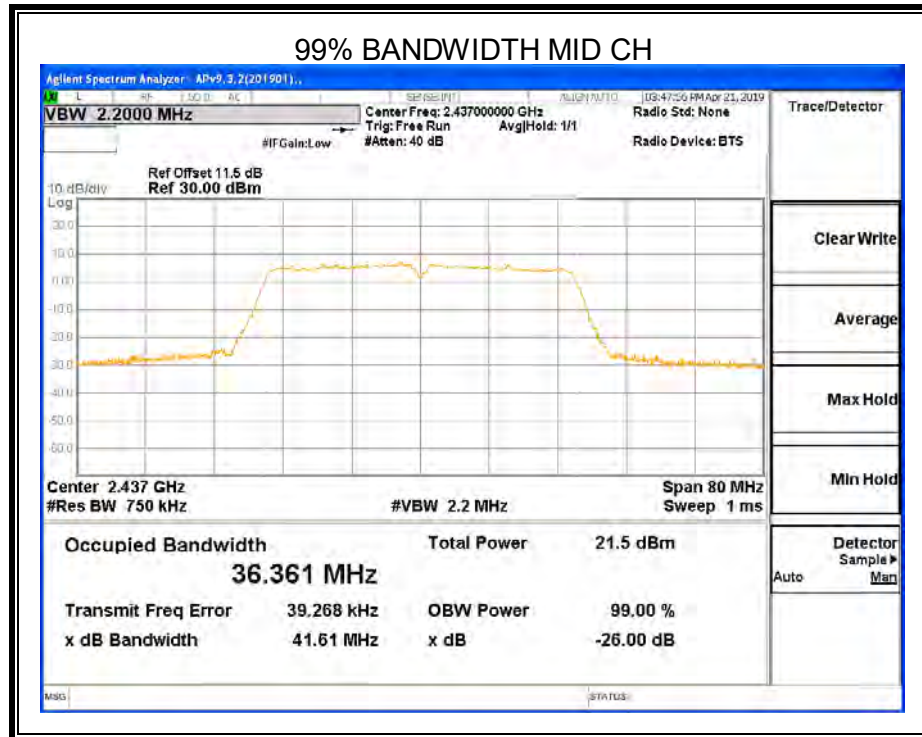
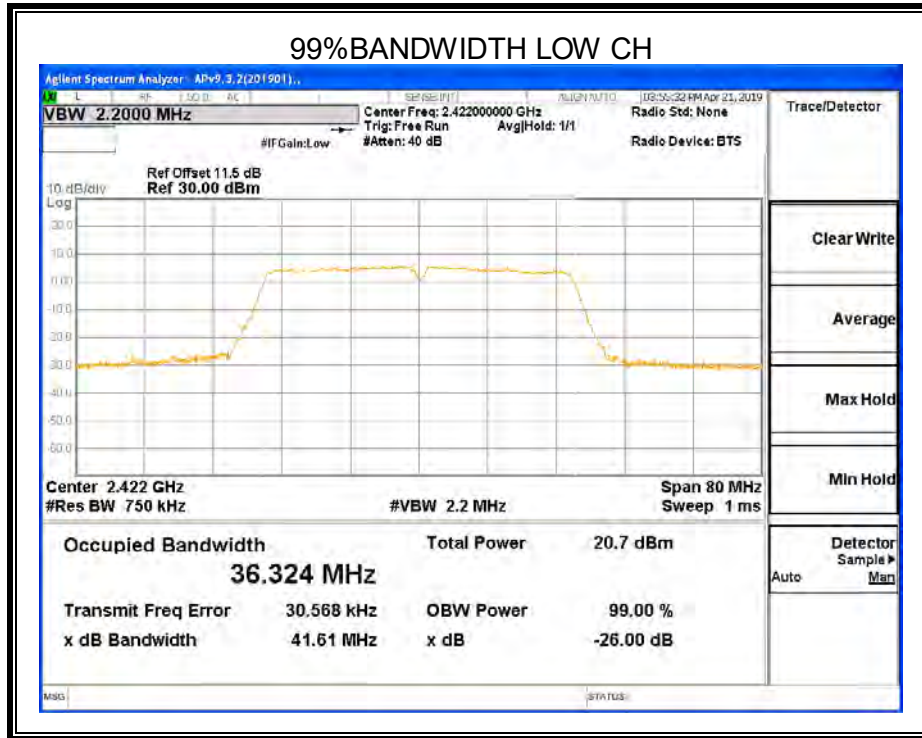

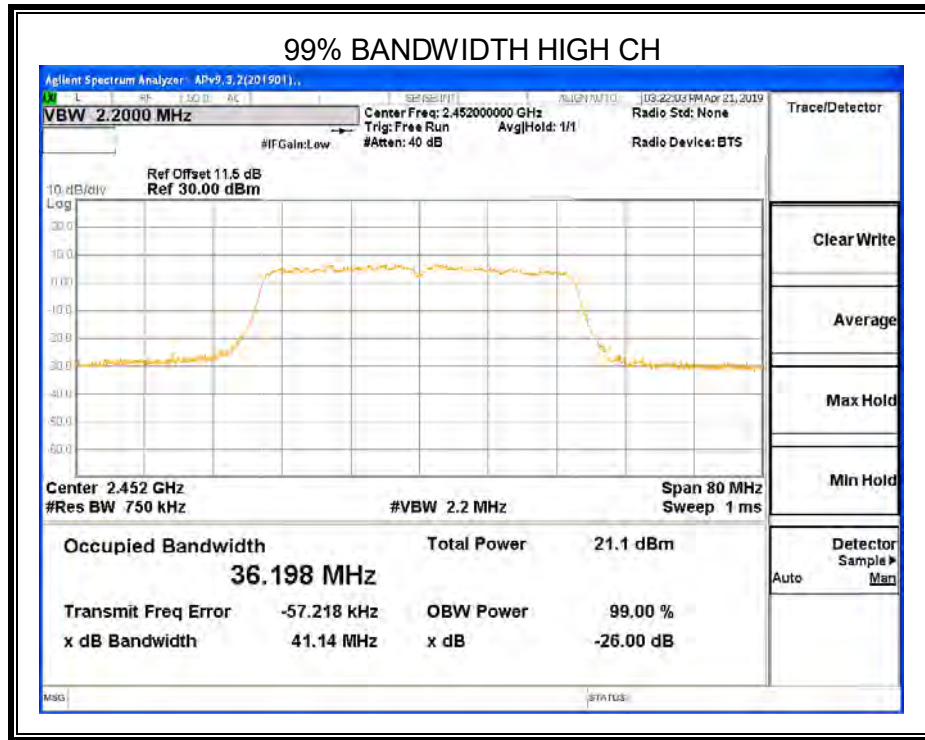

Note: All the modes and antenna ports had been tested, only the worst data recorded in the report.



8.3. PEAK CONDUCTED OUTPUT POWER

LIMITS

CFR 47 FCC Part15 (15.247) Subpart C ISED RSS-247 ISSUE 2			
Section	Test Item	Limit	Frequency Range (MHz)
CFR 47 FCC 15.247(b)(3) ISED RSS-247 5.4 (e)	Peak Output Power	1 watt or 30dBm	2400-2483.5
<p>Note:</p> <p>1. If transmitting antennas of directional gain greater than 6 dBi are used, both the maximum conducted output power and the maximum power spectral density shall be reduced by the amount in dB that the directional gain of the antenna exceeds 6dBi.</p> <p>2. Directional gain = $10\log[(10^{G_{1/20}} + 10^{G_{2/20}})^2 / N_{ANT}] = 3.74 < 6\text{dBi}$, where N_{ANT} is the number of outputs, $G_{1/2}$ is the Antenna gain.</p>			

TEST PROCEDURE

Place the EUT on the table and set it in the transmitting mode.
Remove the antenna from the EUT and then connect a low loss RF cable from the antenna port to the Power sensor.

Measure the power of each channel.
Peak Detector use for Peak result.
AVG Detector use for AVG result.

TEST SETUP

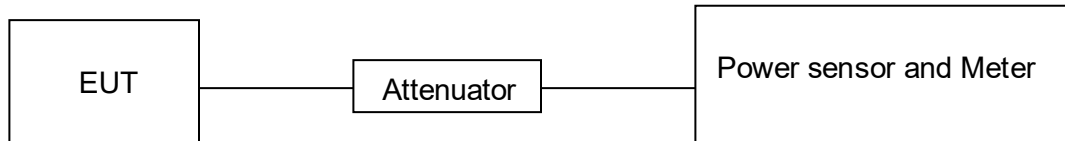

TEST ENVIRONMENT

Temperature	24.6°C	Relative Humidity	56%
Atmosphere Pressure	101kPa	Test Voltage	AC 120V,60Hz



RESULTS

8.3.1. 802.11b SISO MODE

Test Channel	ANT.	Maximum Conducted Output Power(PK)	Maximum Conducted Output Power(AV)	LIMIT
		(dBm)	(dBm)	dBm
Low	1	18.199	15.142	30
	2	17.237	14.183	
Middle	1	18.185	15.180	30
	2	17.335	14.273	
High	1	17.716	14.678	30
	2	17.490	14.406	

8.3.2. 802.11g SISO MODE

Test Channel	ANT.	Maximum Conducted Output Power(PK)	Maximum Conducted Output Power(AV)	LIMIT
		(dBm)	(dBm)	dBm
Low	1	23.723	15.000	30
	2	22.953	14.157	
Middle	1	23.525	14.340	30
	2	23.126	14.142	
High	1	23.105	14.307	30
	2	23.722	14.783	



8.3.3. 802.11n HT20 MIMO MODE

Test Channel	ANT.	Maximum Conducted Output Power(PK) (dBm)		Maximum Conducted Output Power(AV) (dBm)		LIMIT dBm
		Single	Total	Single	Total	
Low	1	22.966	26.04	13.478	16.55	30
	2	23.092		13.605		
Middle	1	22.898	26.22	13.331	16.72	30
	2	23.494		14.051		
High	1	23.348	26.47	13.747	16.91	30
	2	23.575		14.047		

8.3.4. 802.11n HT40 MIMO MODE

Test Channel	ANT.	Maximum Conducted Output Power(PK) (dBm)		Maximum Conducted Output Power(AV) (dBm)		LIMIT dBm
		Single	Total	Single	Total	
Low	1	23.236	26.44	13.467	16.69	30
	2	23.622		13.875		
Middle	1	23.294	26.81	13.553	17.11	30
	2	24.261		14.577		
High	1	24.109	26.52	14.798	17.21	30
	2	22.813		13.502		

8.4. POWER SPECTRAL DENSITY

LIMITS

CFR 47 FCC Part15 (15.247) Subpart C ISED RSS-247 ISSUE 2			
Section	Test Item	Limit	Frequency Range (MHz)
CFR 47 FCC §15.247 (e) ISED RSS-247 5.2 (b)	Power Spectral Density	8 dBm/3 kHz	2400-2483.5
<p>Note:</p> <p>1. If transmitting antennas of directional gain greater than 6 dBi are used, both the maximum conducted output power and the maximum power spectral density shall be reduced by the amount in dB that the directional gain of the antenna exceeds 6dBi.</p> <p>2. Directional gain = $10\log[(10^{G_{1/20}} + 10^{G_{2/20}})^2 / N_{ANT}] = 3.74 < 6\text{dBi}$, where N_{ANT} is the number of outputs, $G_{1/2}$ is the Antenna gain.</p>			

TEST PROCEDURE

Connect the UUT to the spectrum analyser and use the following settings:

Center Frequency	The centre frequency of the channel under test
Detector	Peak
RBW	$3 \text{ kHz} \leq \text{RBW} \leq 100 \text{ kHz}$
VBW	$\geq 3 \times \text{RBW}$
Span	1.5 x DTS bandwidth
Trace	Max hold
Sweep time	Auto couple.

Allow trace to fully stabilize and use the peak marker function to determine the maximum amplitude level within the RBW.

If measured value exceeds limit, reduce RBW (no less than 3 kHz) and repeat.

TEST SETUP

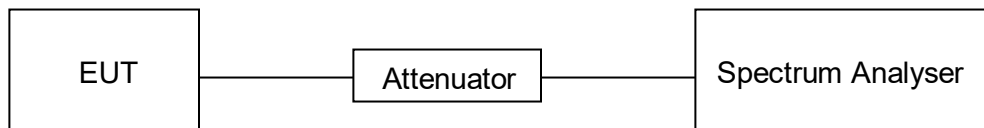



TEST ENVIRONMENT

Temperature	24.6°C	Relative Humidity	56%
Atmosphere Pressure	101kPa	Test Voltage	AC 120V,60Hz



RESULTS

8.4.1. 802.11b SISO MODE

ANTENNA1

Test Channel	Power Spectral Density (dBm/3kHz)	Limit (dBm/3kHz)	Result
Low	-14.357	8	PASS
Middle	-14.331	8	PASS
High	-14.821	8	PASS

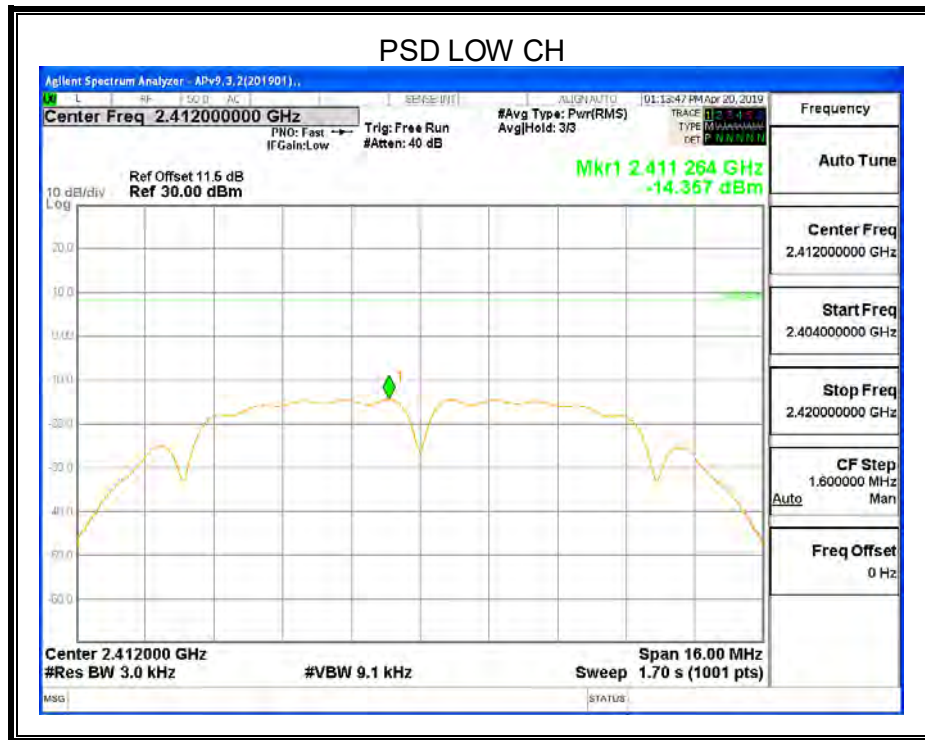

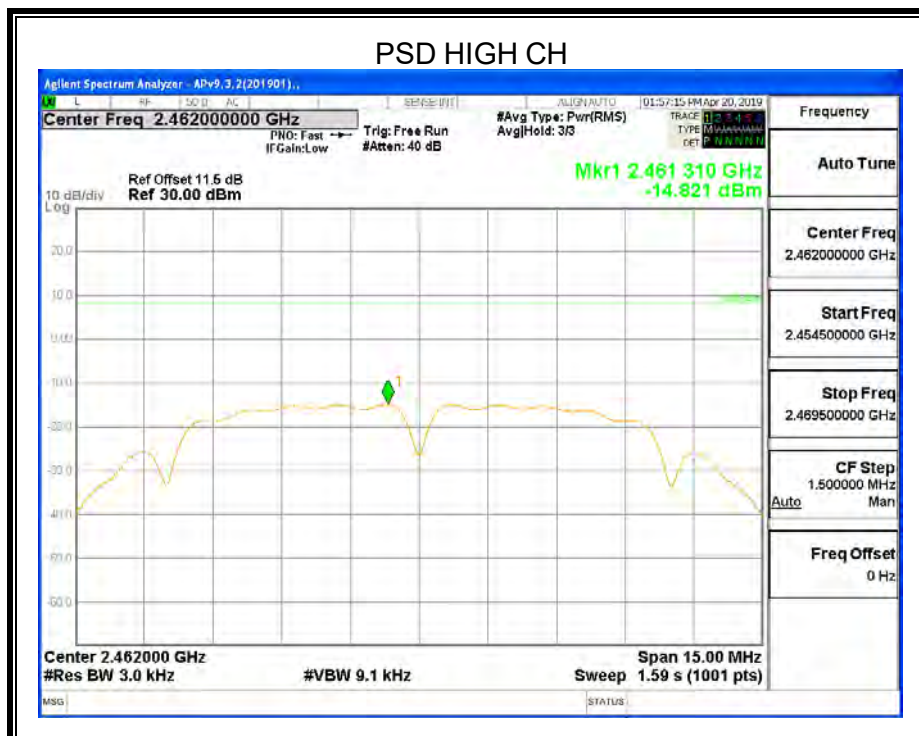
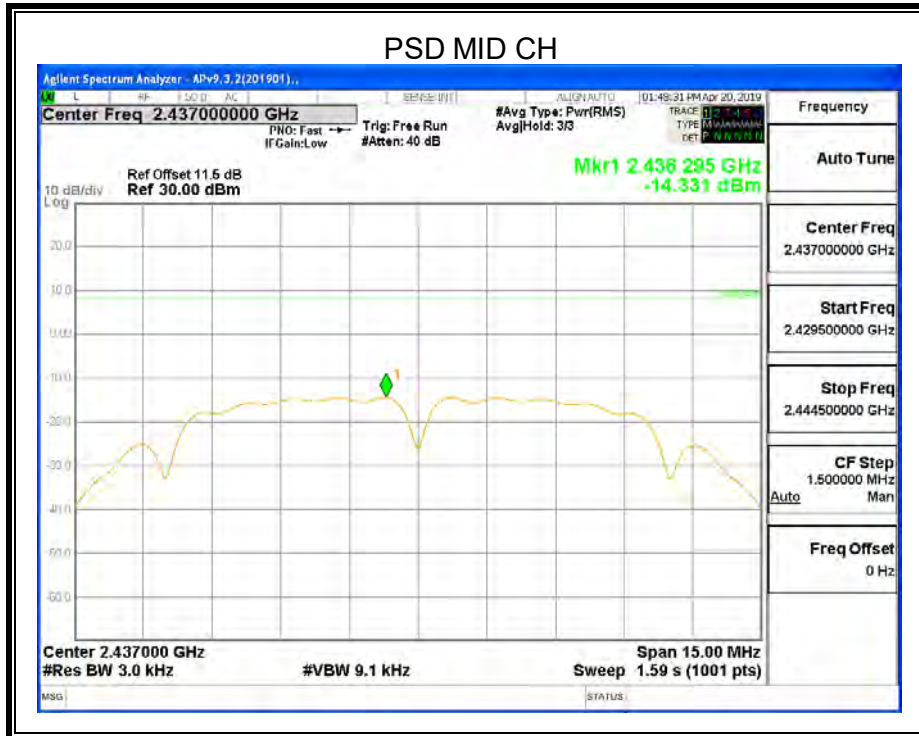

Note: All the modes and antenna ports had been tested, only the worst data recorded in the report.



8.4.2. 802.11g SISO MODE

ANTENNA1

Test Channel	Power Spectral Density (dBm/3kHz)	Limit (dBm/3kHz)	Result
Low	-12.668	8	PASS
Middle	-11.868	8	PASS
High	-9.804	8	PASS

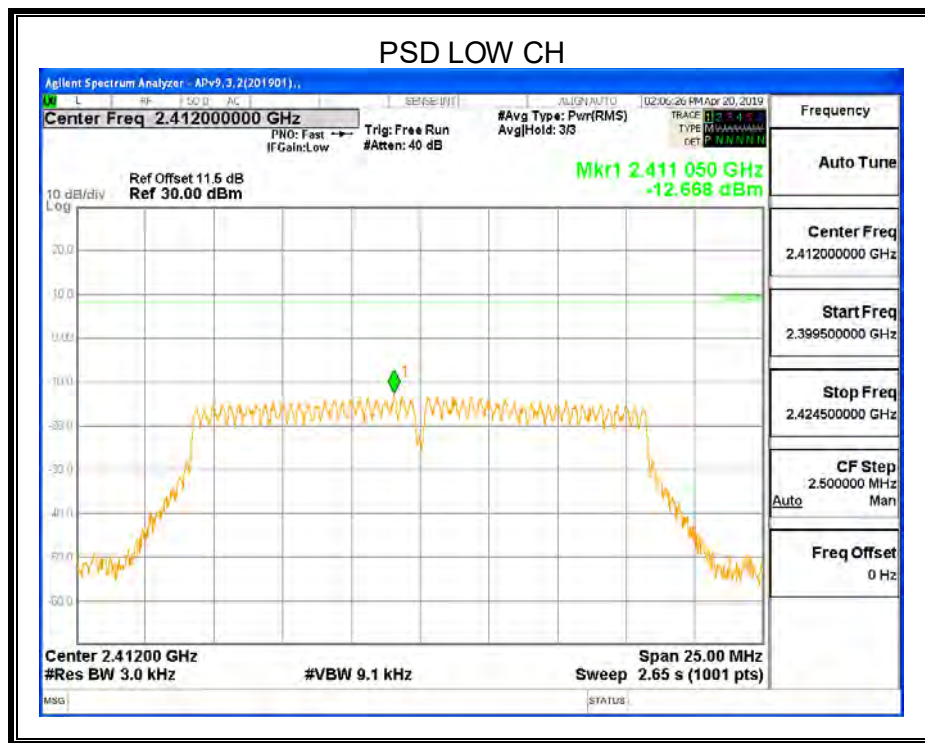

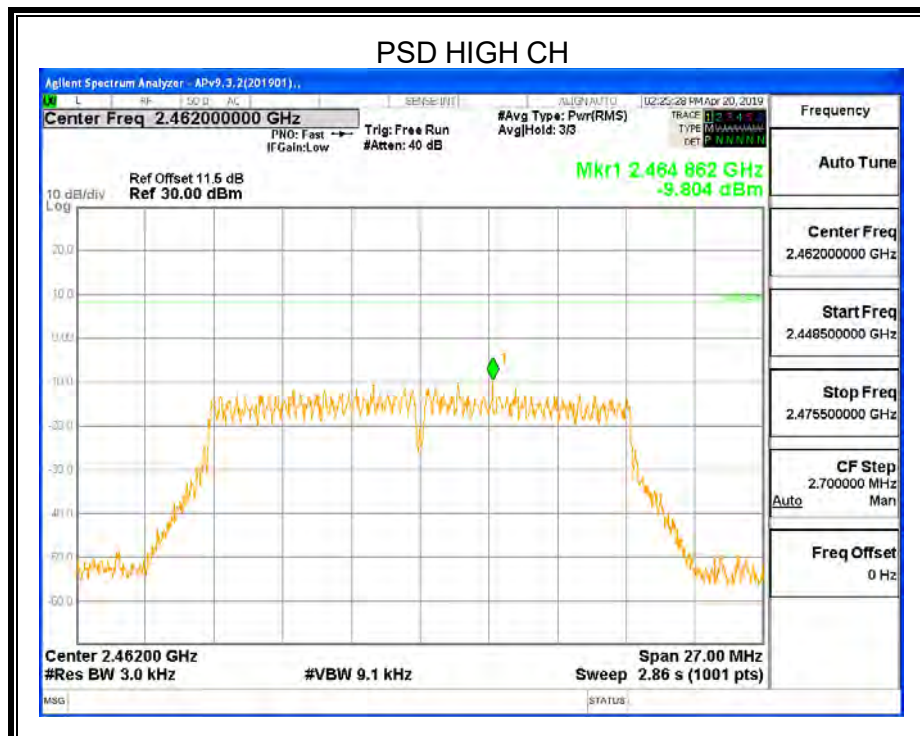
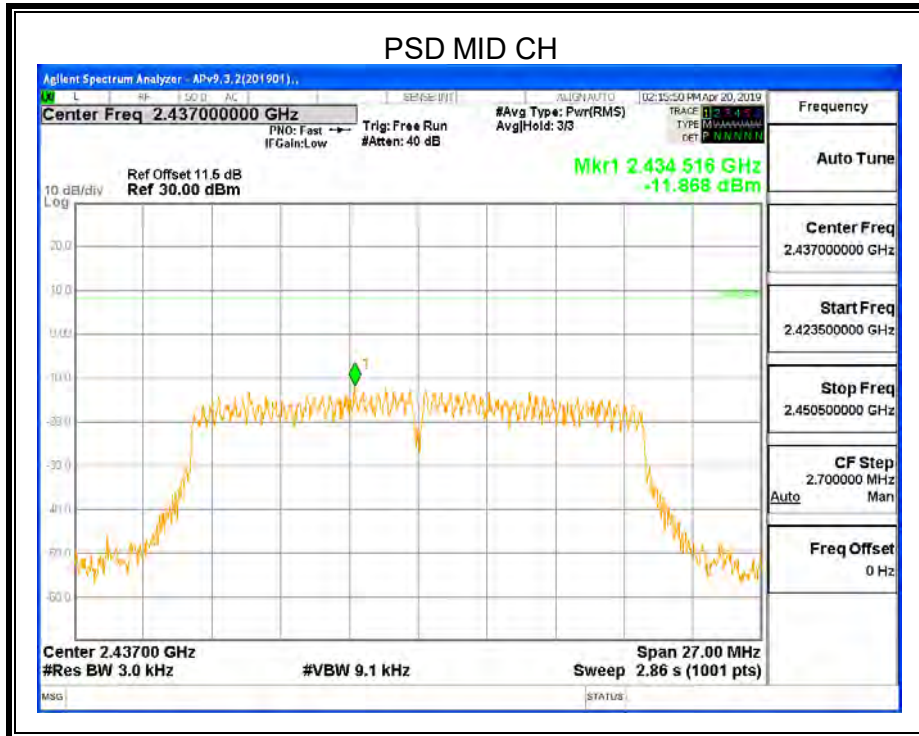

Note: All the modes and antenna ports had been tested, only the worst data recorded in the report.



8.4.3. 802.11n HT20 MIMO MODE

Test Channel	ANT	Power Spectral Density (dBm/3kHz)		Limit (dBm/3kHz)
		Single	Total	
Low	1	-13.846	-10.83	8
	2	-13.830		
Middle	1	-14.169	-10.94	
	2	-13.748		
High	1	-13.399	-10.46	
	2	-13.540		

ANTENNA1

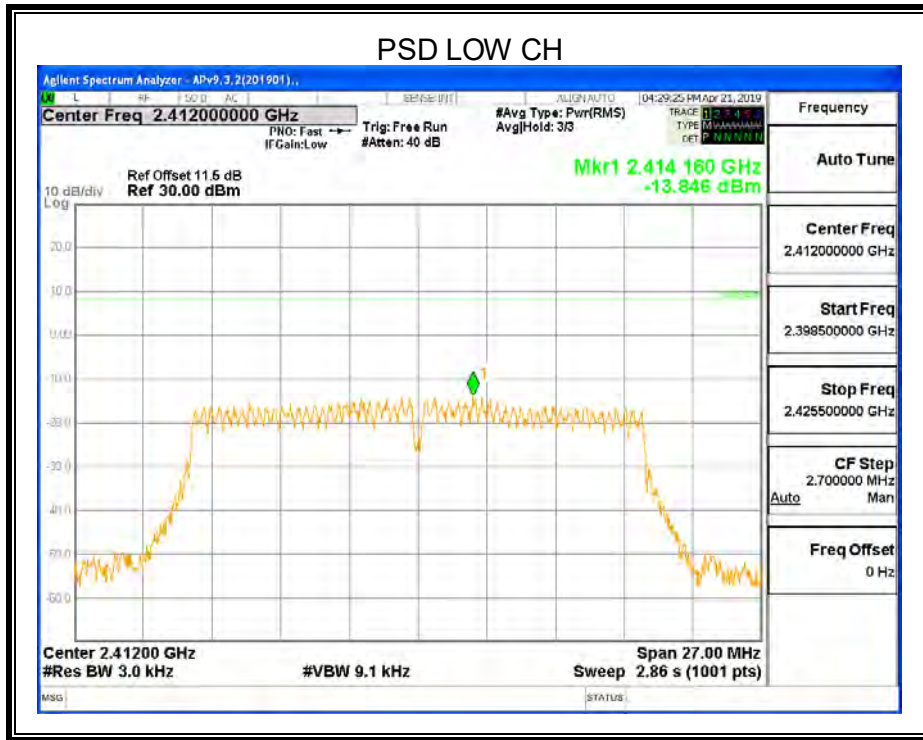

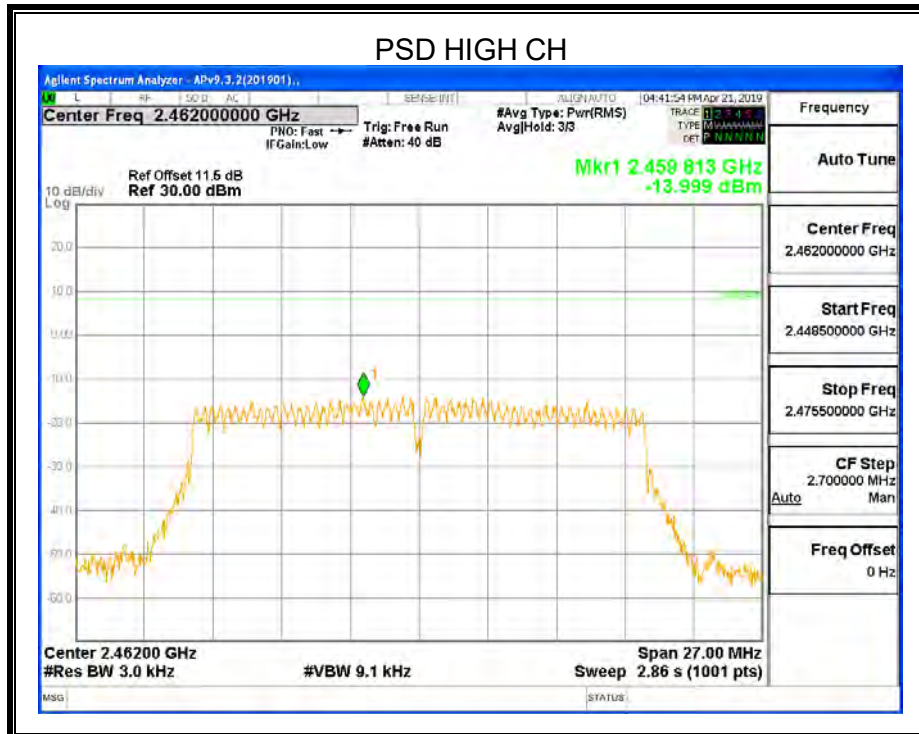
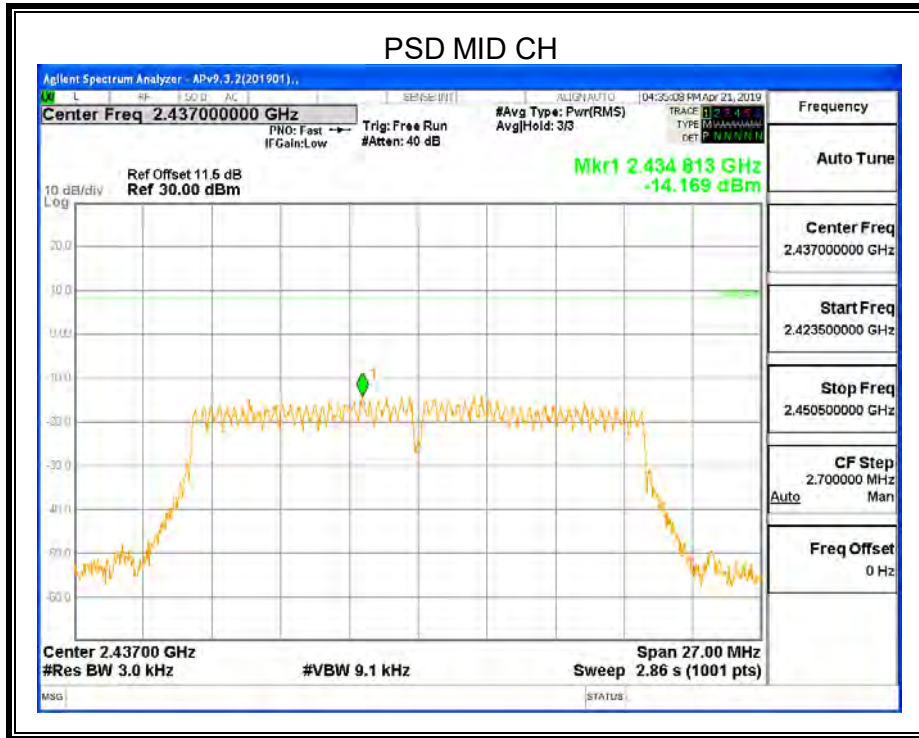



ANTENNA2

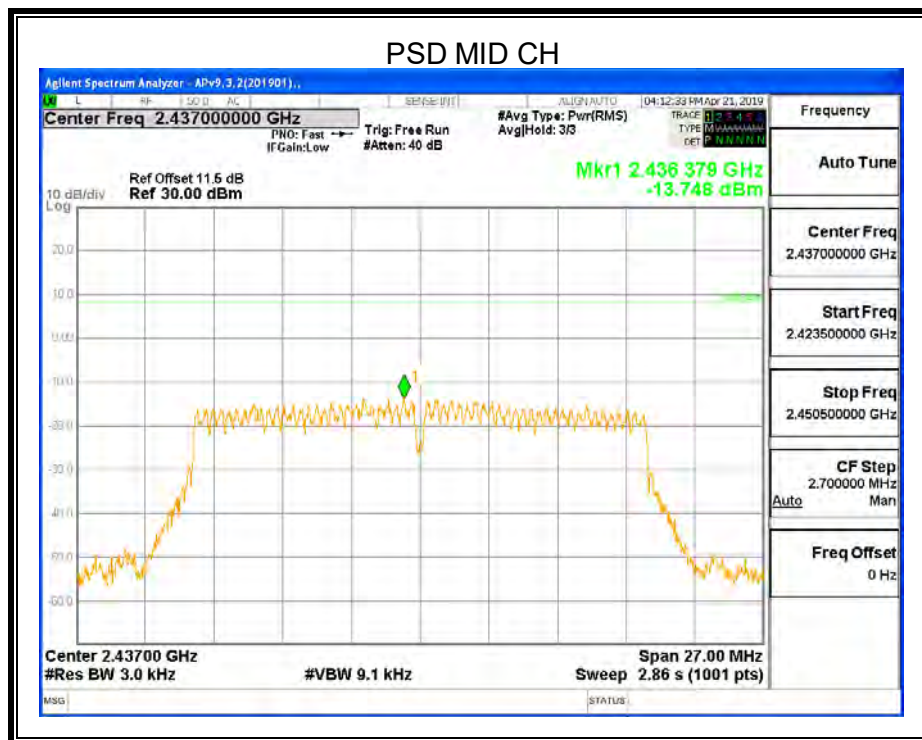
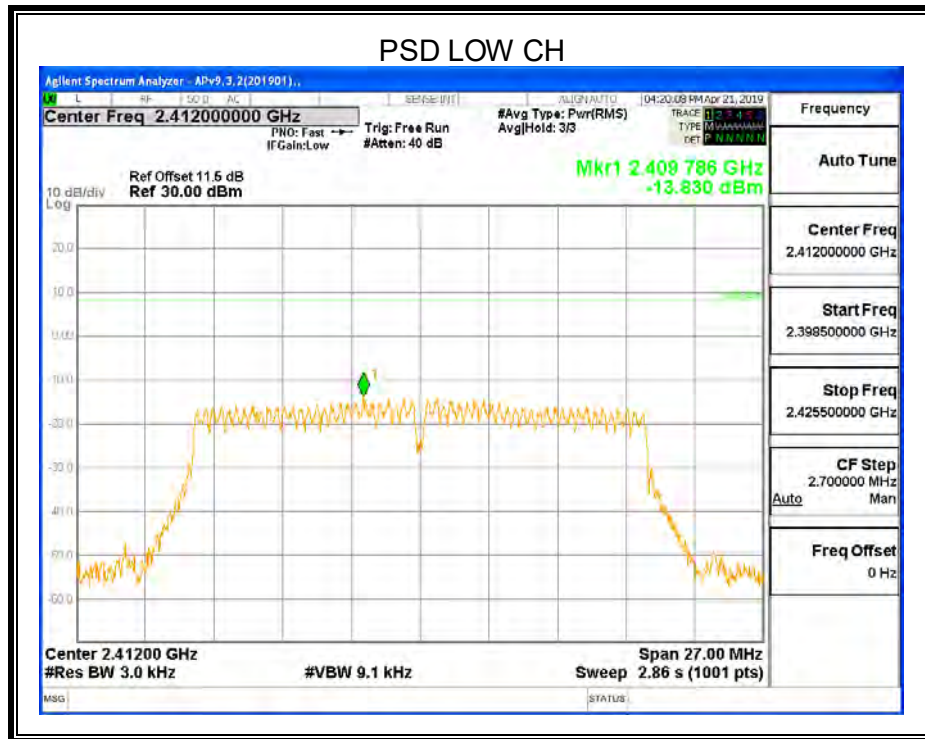

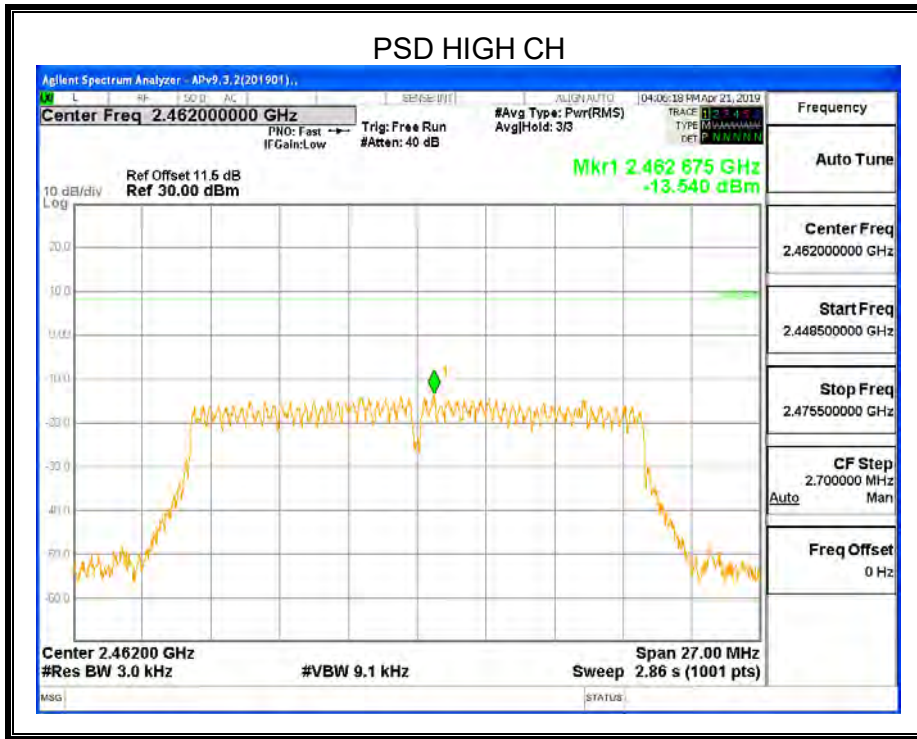

Note: All the modes and antenna ports had been tested, only the worst data recorded in the report.



8.4.4. 802.11n HT40 MIMO MODE

Test Channel	ANT	Power Spectral Density (dBm/3kHz)		Limit (dBm/3kHz)
		Single	Total	
Low	1	-16.186	-12.98	8
	2	-15.812		
Middle	1	-16.502	-13.24	
	2	-16.011		
High	1	-14.154	-11.69	
	2	-15.333		

ANTENNA1

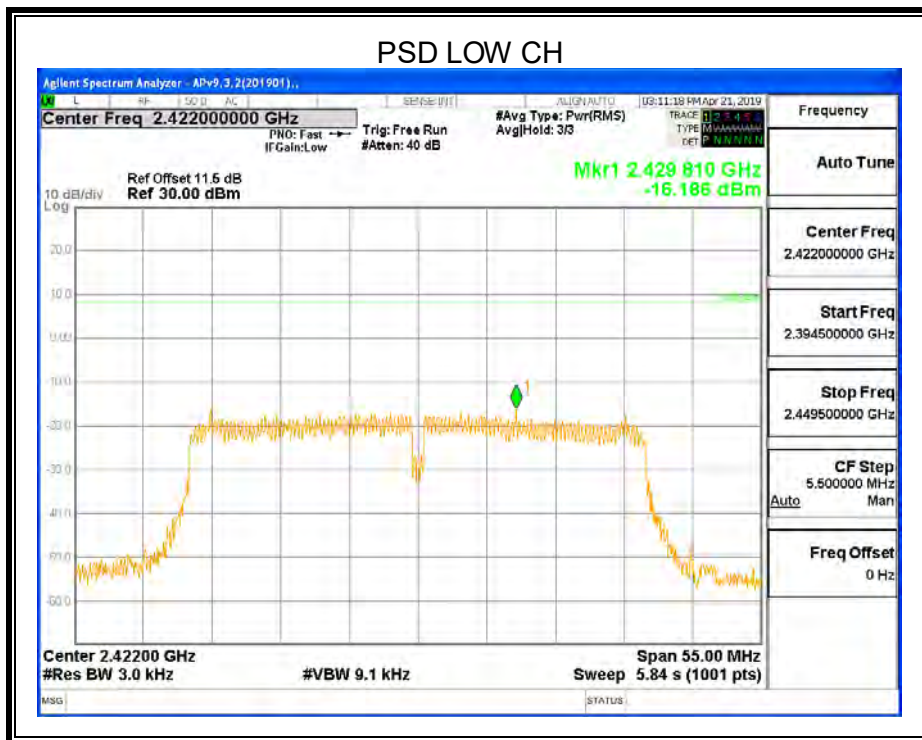

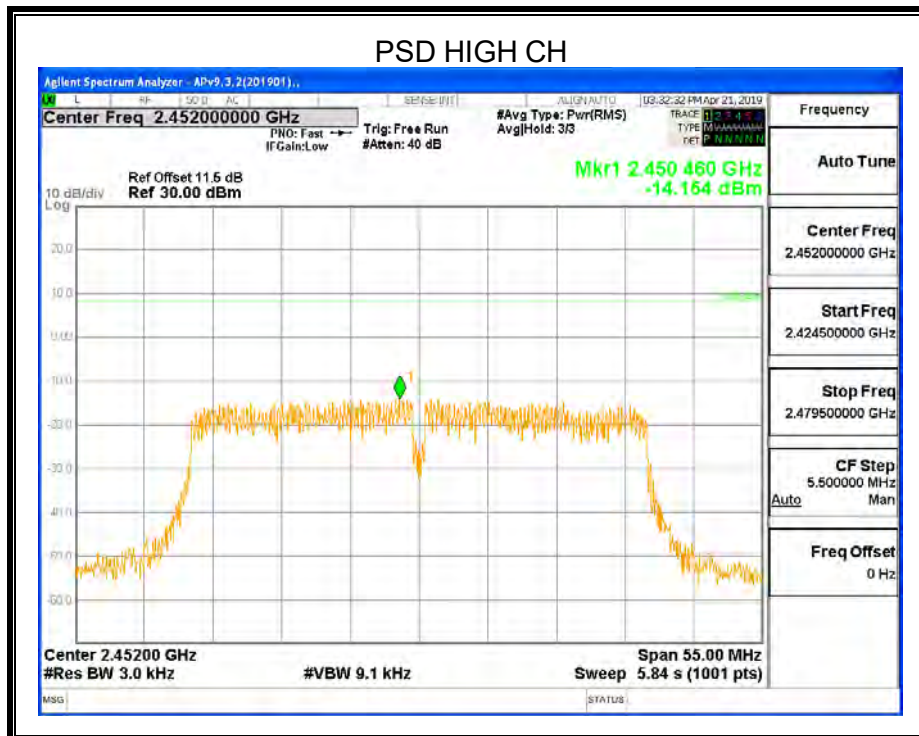
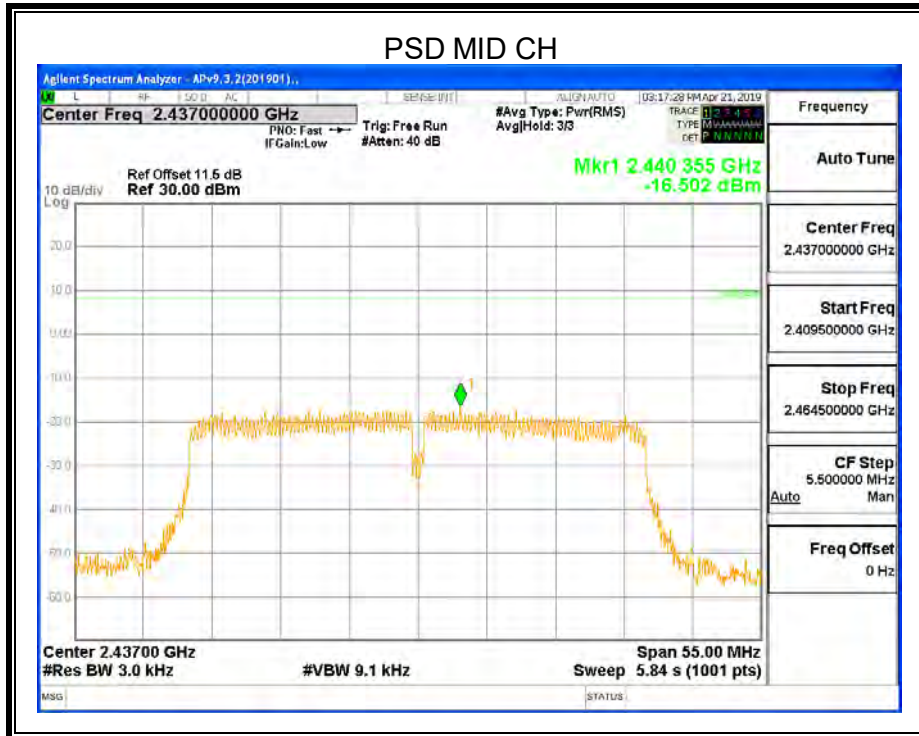

Note: All the modes and antenna ports had been tested, only the worst data recorded in the report.



ANTENNA2

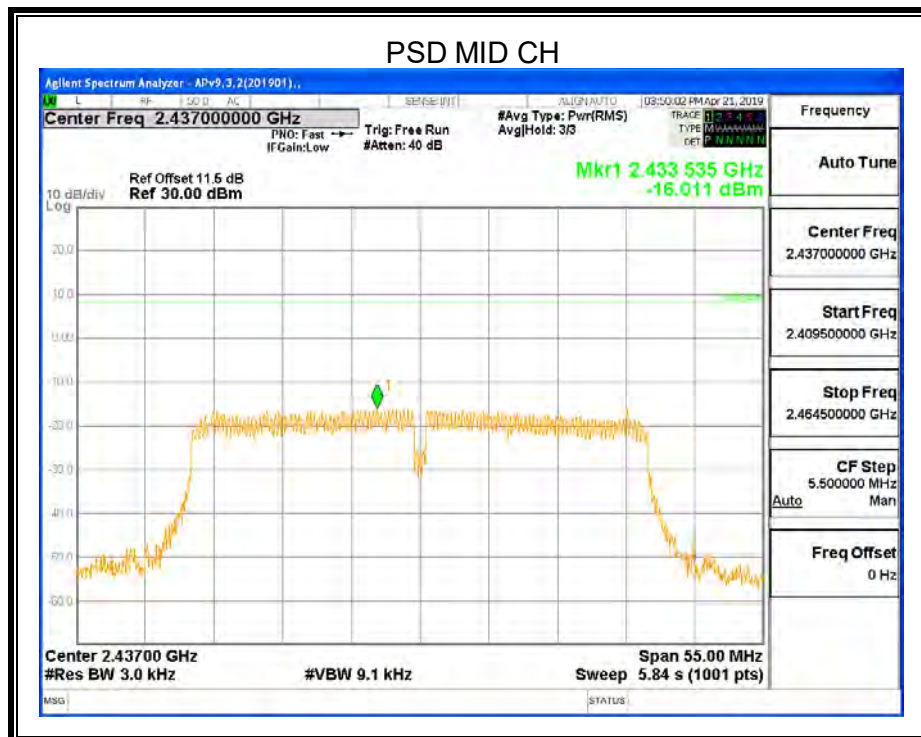
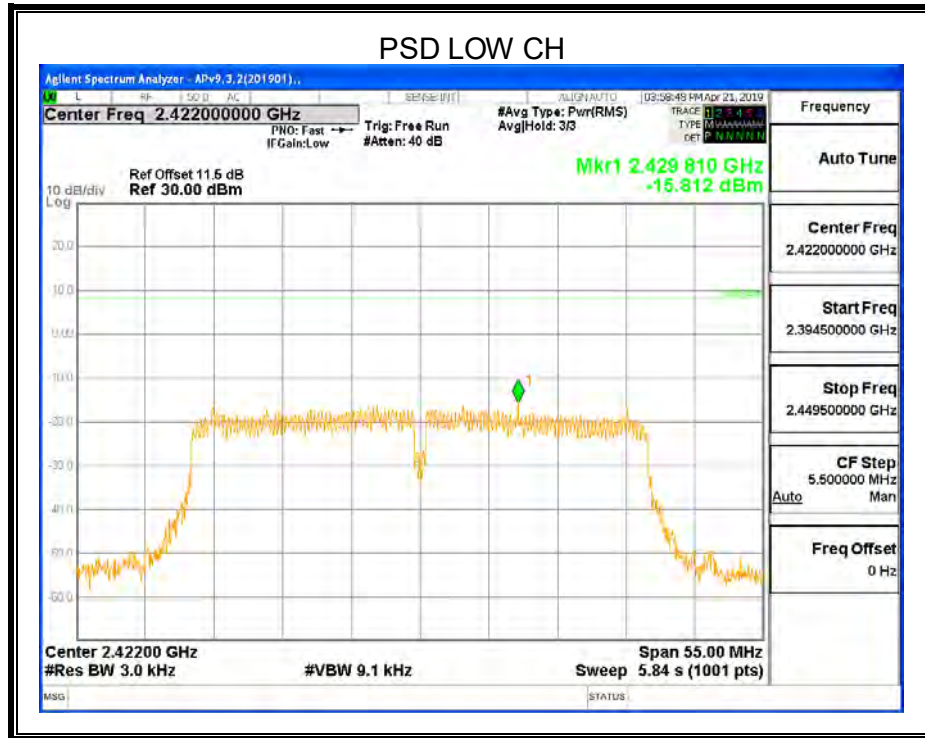

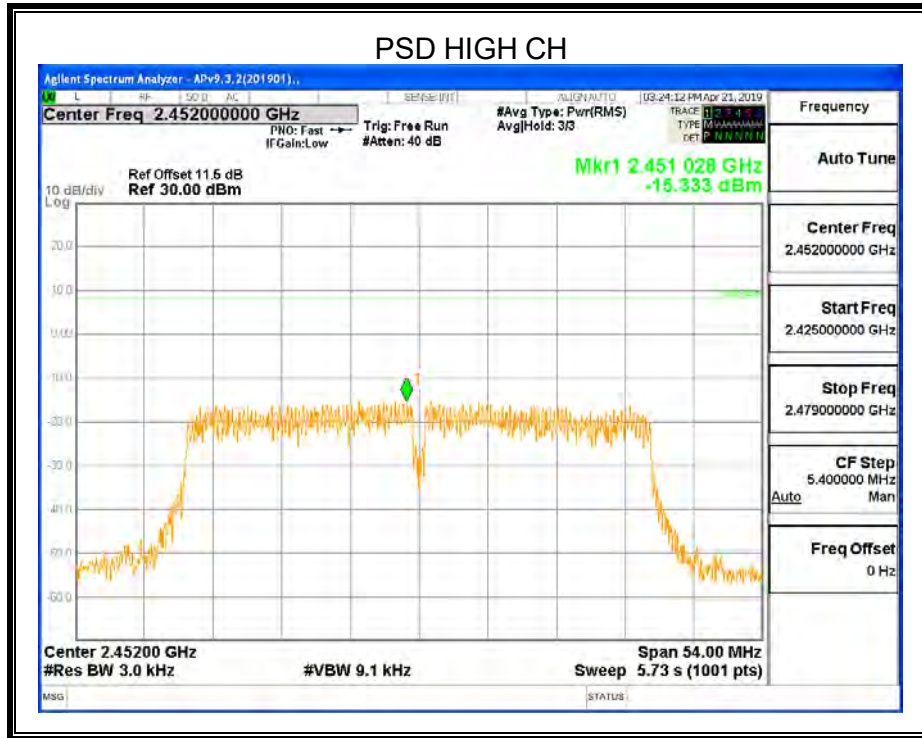

Note: All the modes and antenna ports had been tested, only the worst data recorded in the report.

8.5. CONDUCTED BANDEGE AND SPURIOUS EMISSIONS

LIMITS

CFR 47 FCC Part15 (15.247) Subpart C ISED RSS-247 ISSUE 2		
Section	Test Item	Limit
CFR 47 FCC §15.247 (d) ISED RSS-247 5.5	Conducted Bandedge and Spurious Emissions	at least 20 dB below that in the 100 kHz bandwidth within the band that contains the highest level of the desired power

TEST PROCEDURE

Connect the UUT to the spectrum analyser and use the following settings:

Center Frequency	The centre frequency of the channel under test
Detector	Peak
RBW	100K
VBW	$\geq 3 \times \text{RBW}$
Span	1.5 x DTS bandwidth
Trace	Max hold
Sweep time	Auto couple.

Use the peak marker function to determine the maximum PSD level.

Span	Set the center frequency and span to encompass frequency range to be measured
Detector	Peak
RBW	100K
VBW	$\geq 3 \times \text{RBW}$
measurement points	$\geq \text{span}/\text{RBW}$
Trace	Max hold
Sweep time	Auto couple.

Use the peak marker function to determine the maximum amplitude level.



TEST SETUP

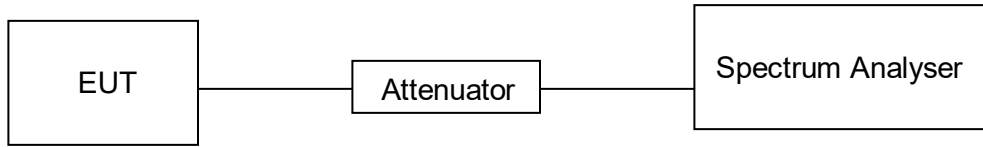

TEST ENVIRONMENT

Temperature	24.6°C	Relative Humidity	56%
Atmosphere Pressure	101kPa	Test Voltage	AC 120V,60Hz



RESULTS

8.5.1. 802.11b SISO MODE

ANTENNA1

LOW CH BANDEDGE

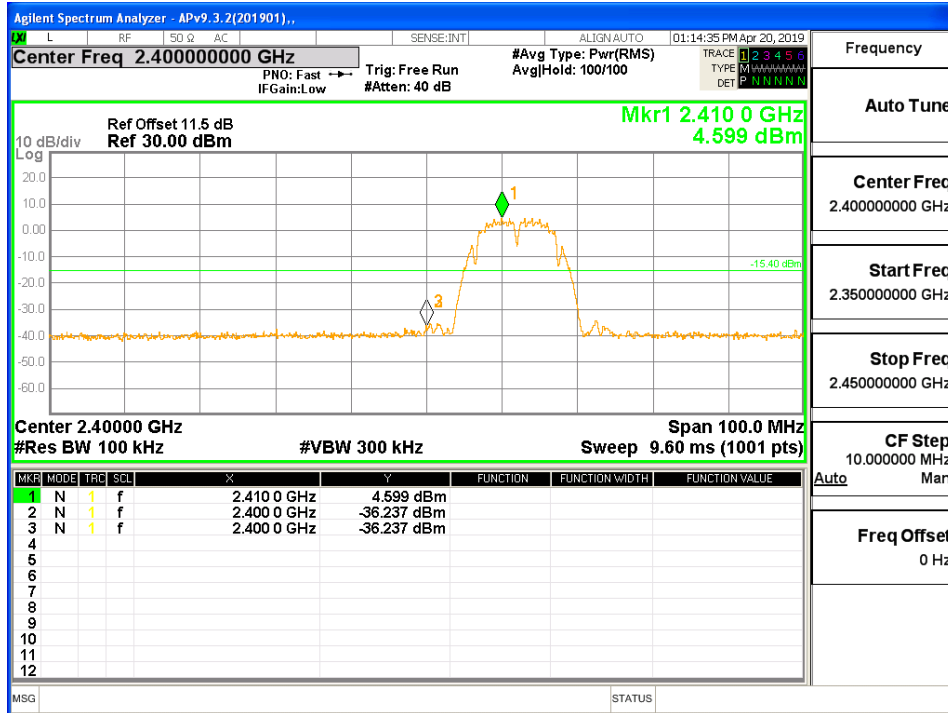

LOW CH SPURIOUS EMISSIONS 30M-26G

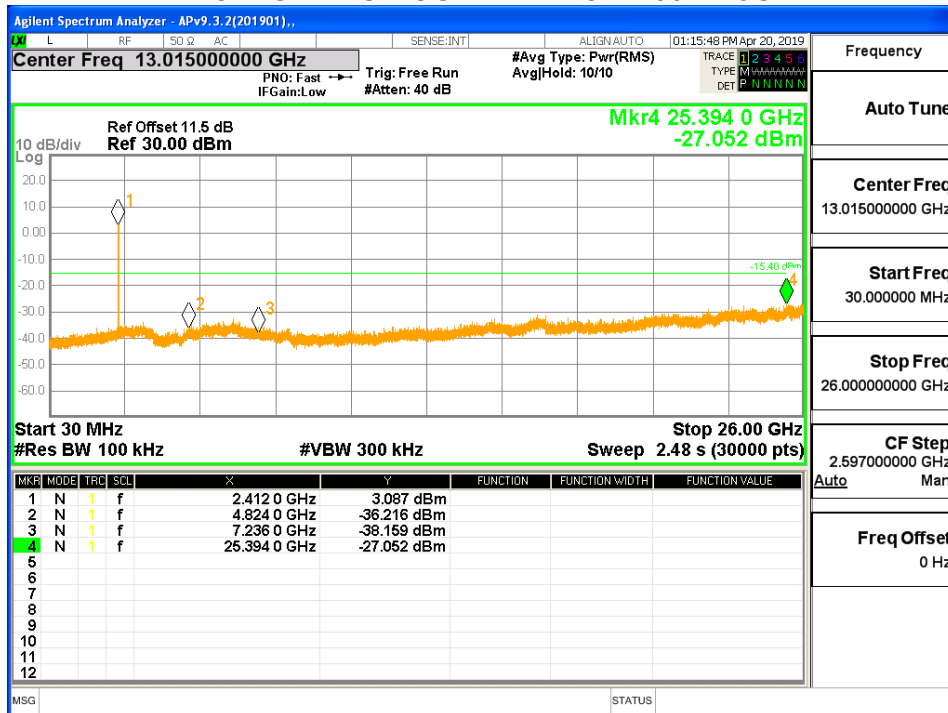



MID CH BANDEDGE

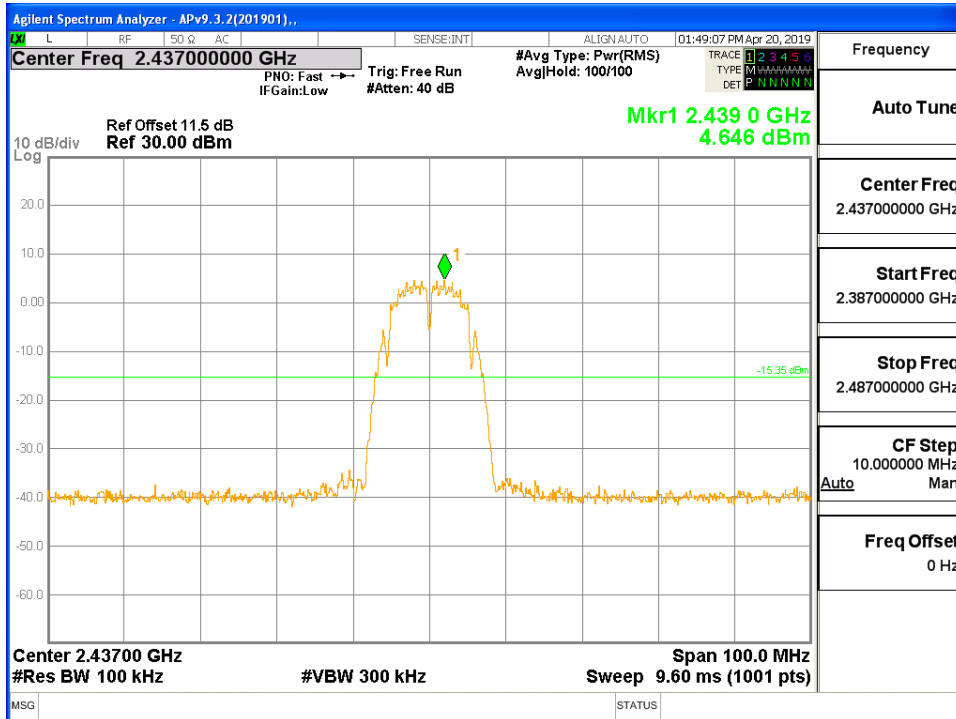

MID CH SPURIOUS EMISSIONS 30M-26G

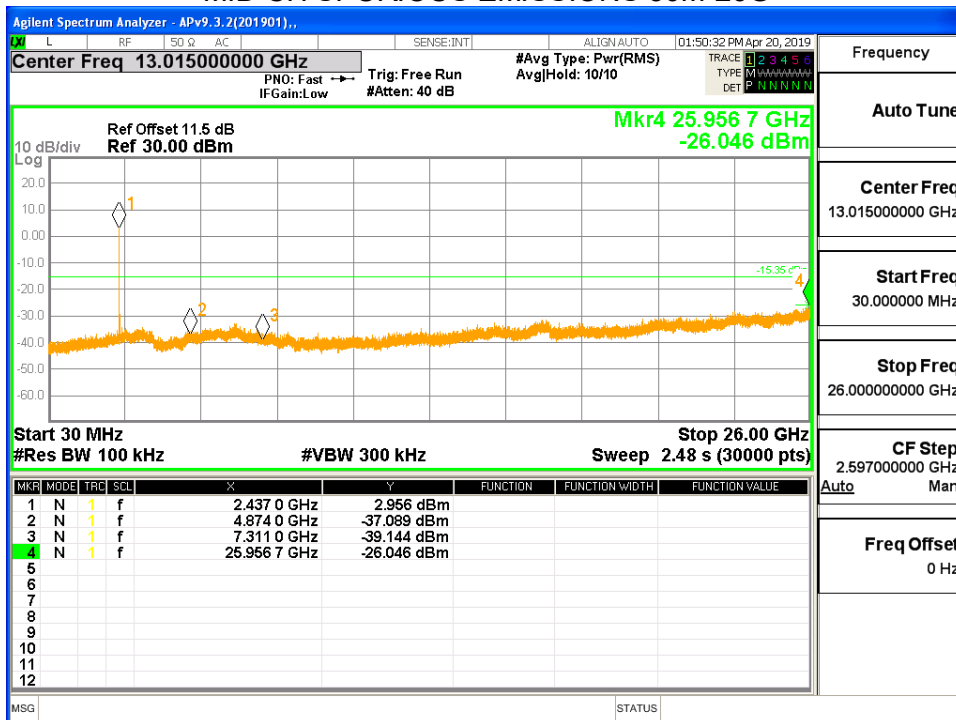



HIGH CH BANDEDGE

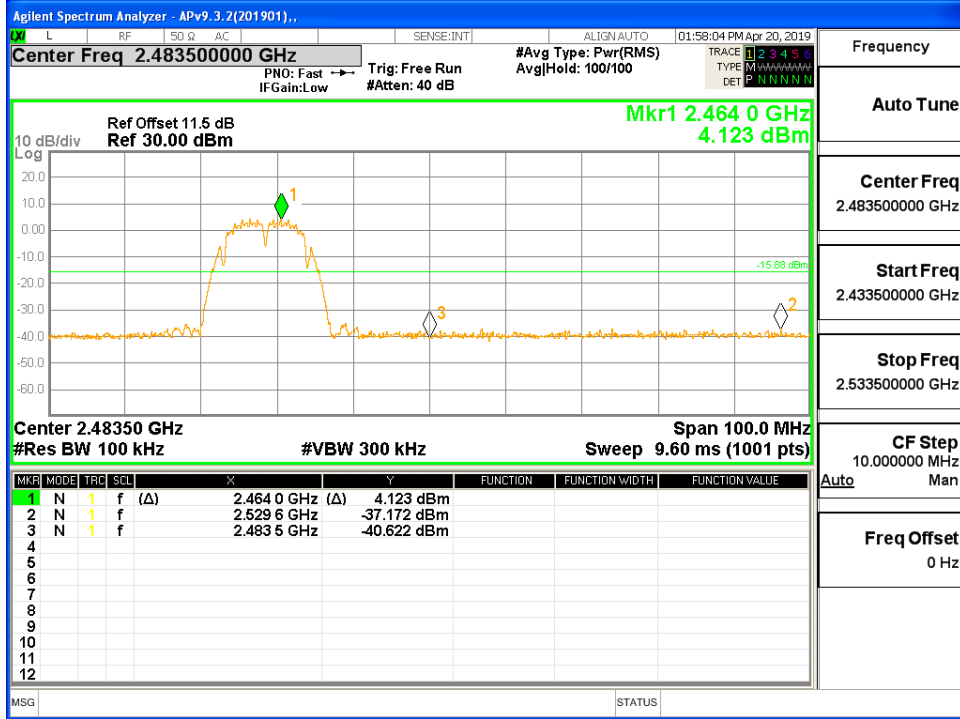

HIGH CH SPURIOUS EMISSIONS 30M-26G

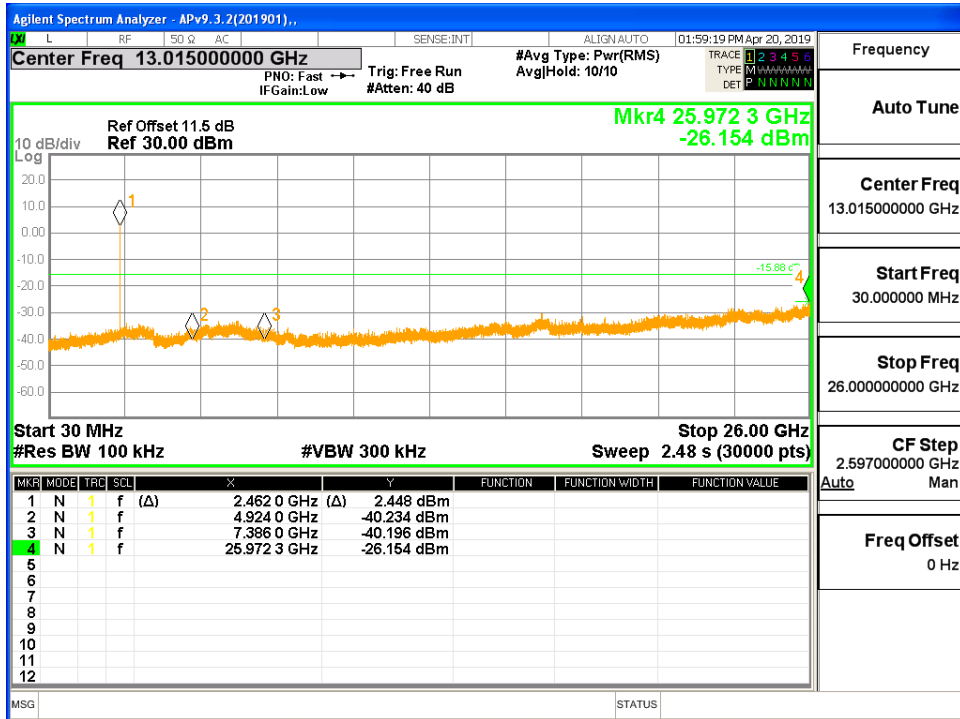

Note: All the modes and antenna ports had been tested, only the worst data recorded in the report.



8.5.2. 802.11g SISO MODE

ANTENNA1

LOW CH BANDEDGE

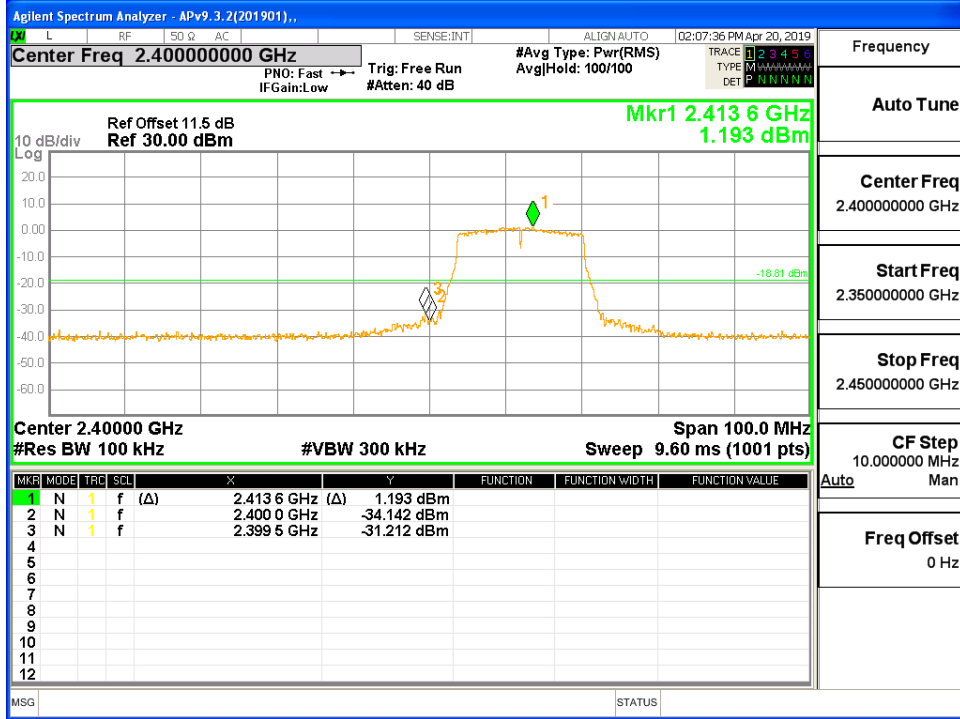

LOW CH SPURIOUS EMISSIONS 30M-26G

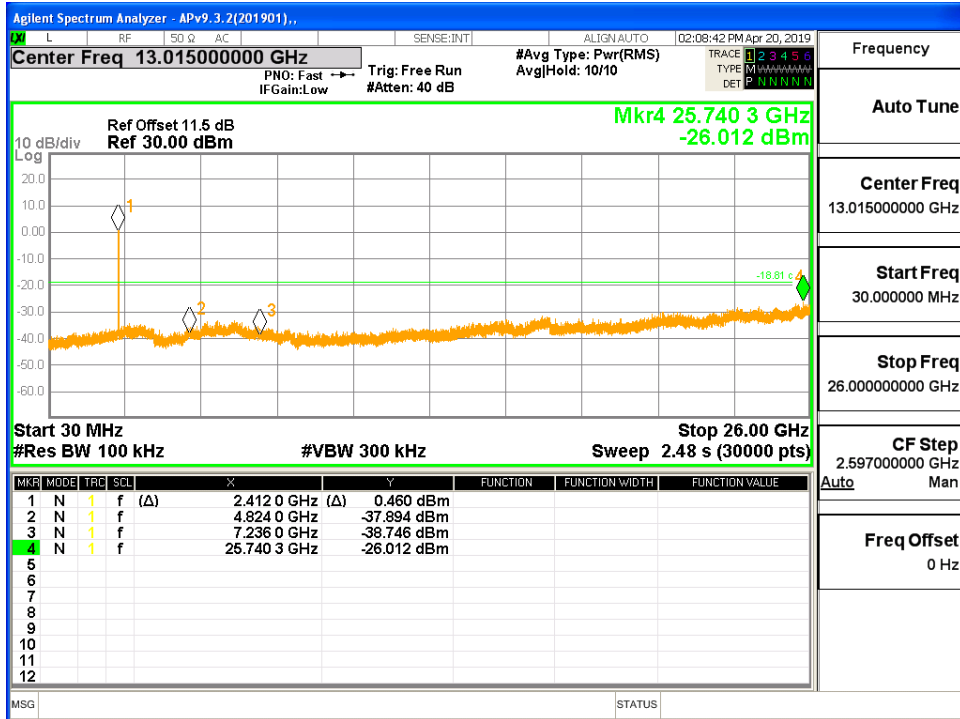



MID CH BANDEDGE

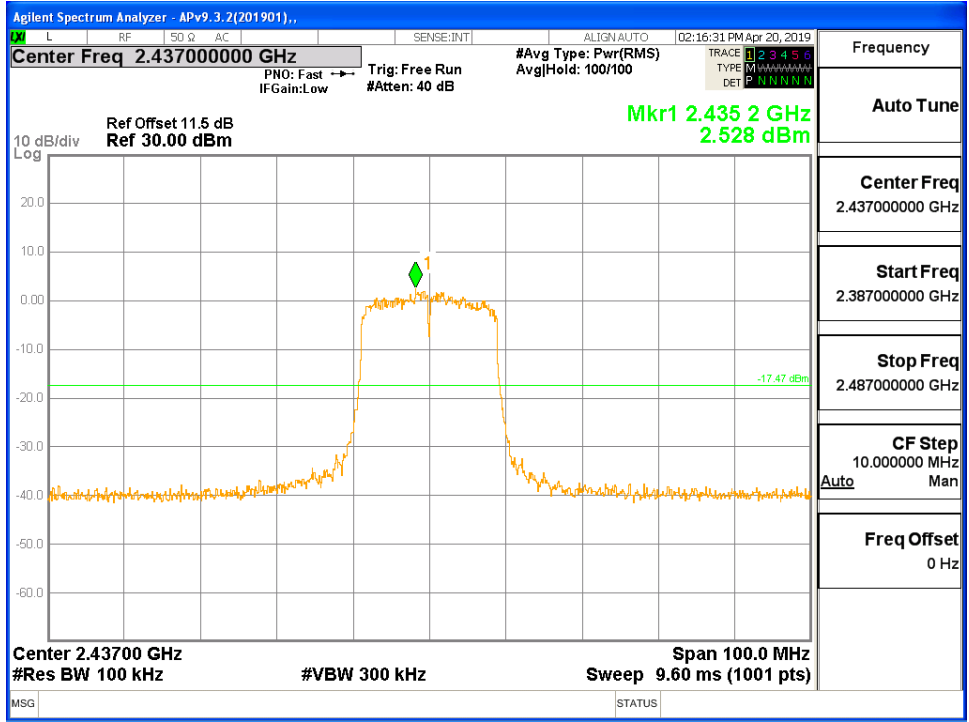

MID CH SPURIOUS EMISSIONS 30M-26G

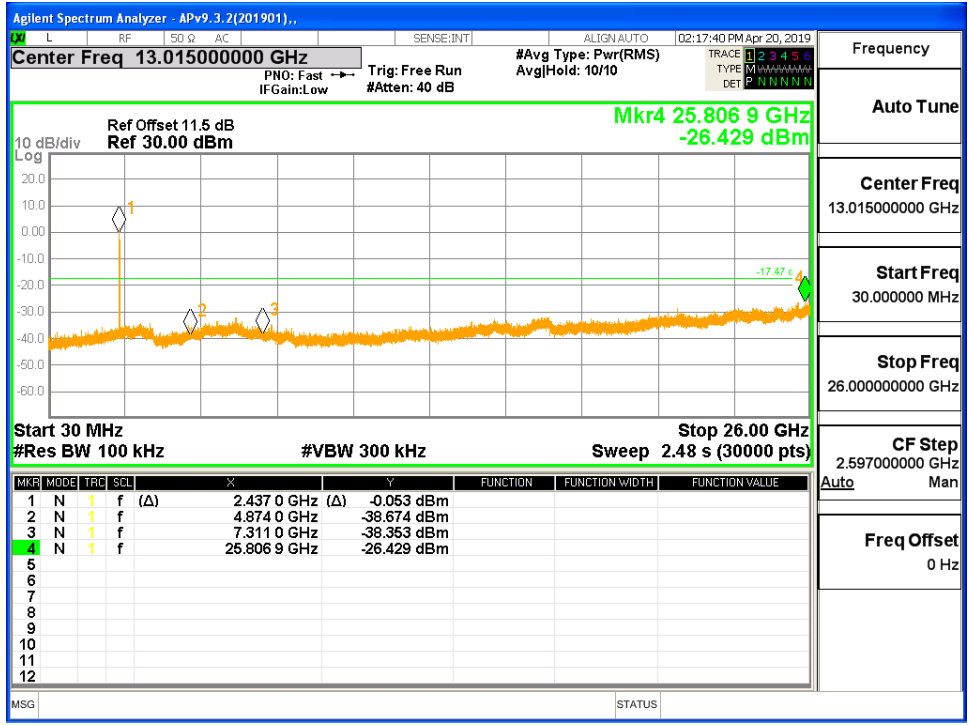



HIGH CH BANDEDGE

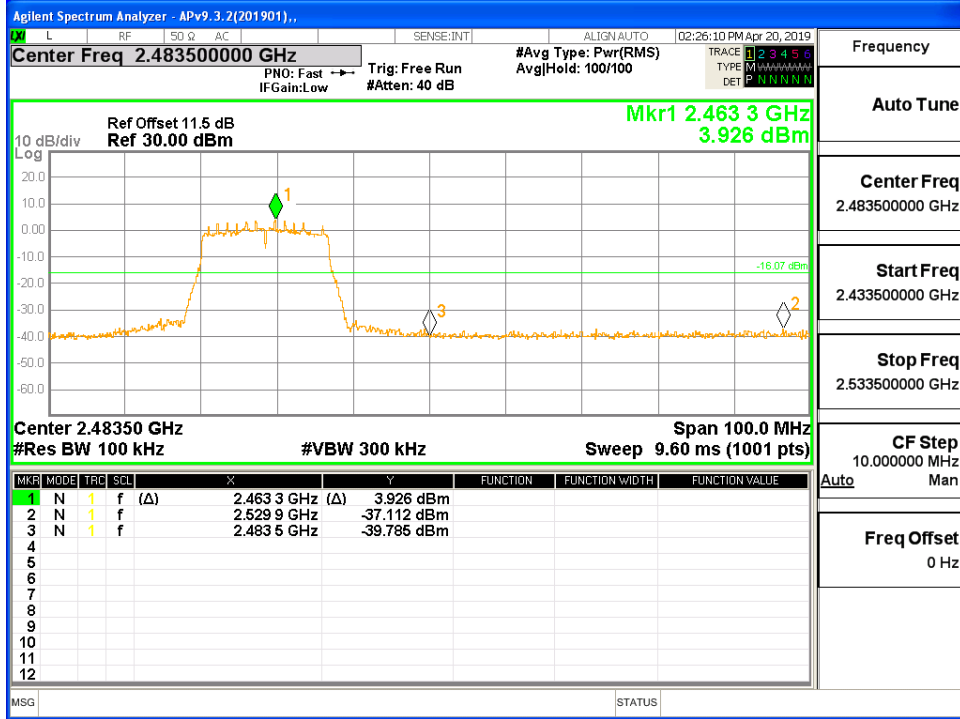

HIGH CH SPURIOUS EMISSIONS 30M-26G

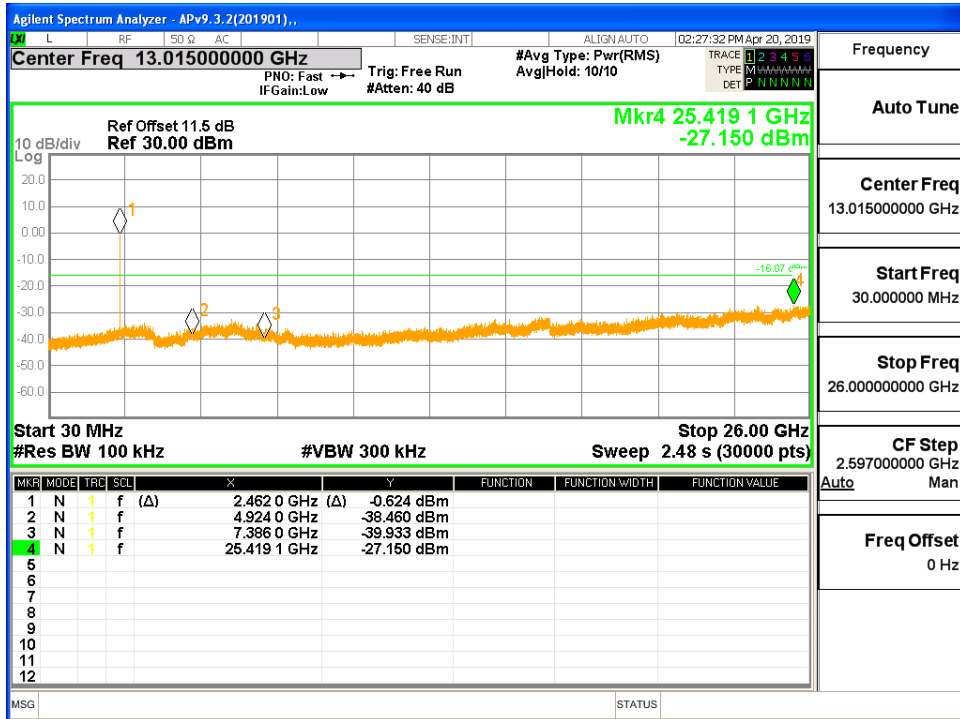

Note: All the modes and antenna ports had been tested, only the worst data recorded in the report.



8.5.3. 802.11n HT20 MIMO MODE

ANTENNA1

LOW CH BANDEDGE

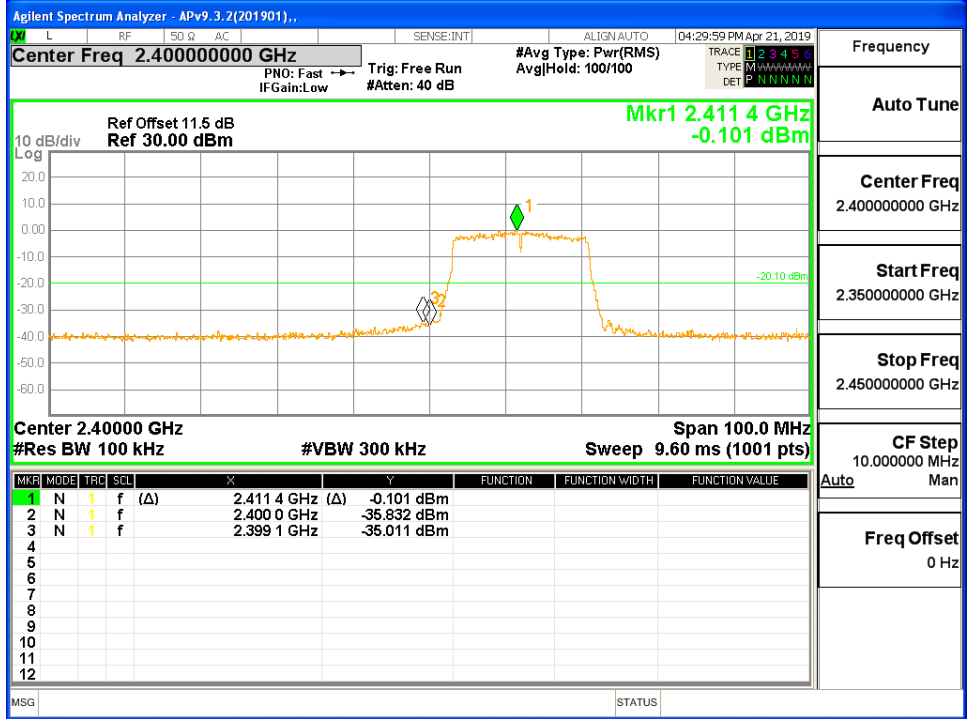

LOW CH SPURIOUS EMISSIONS 30M-26G

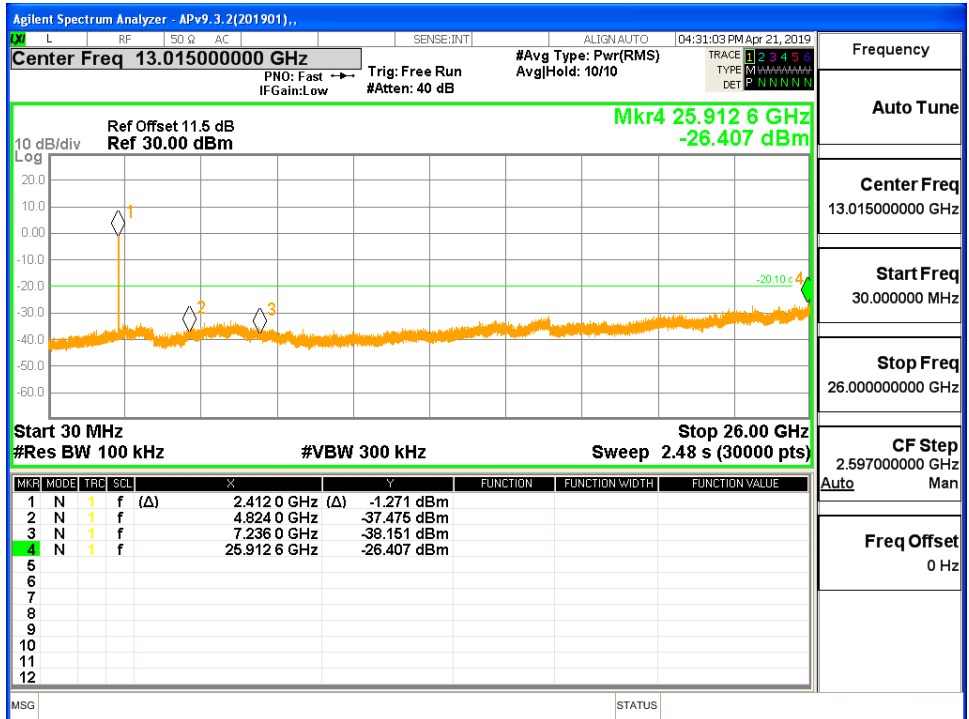



MID CH BANDEDGE

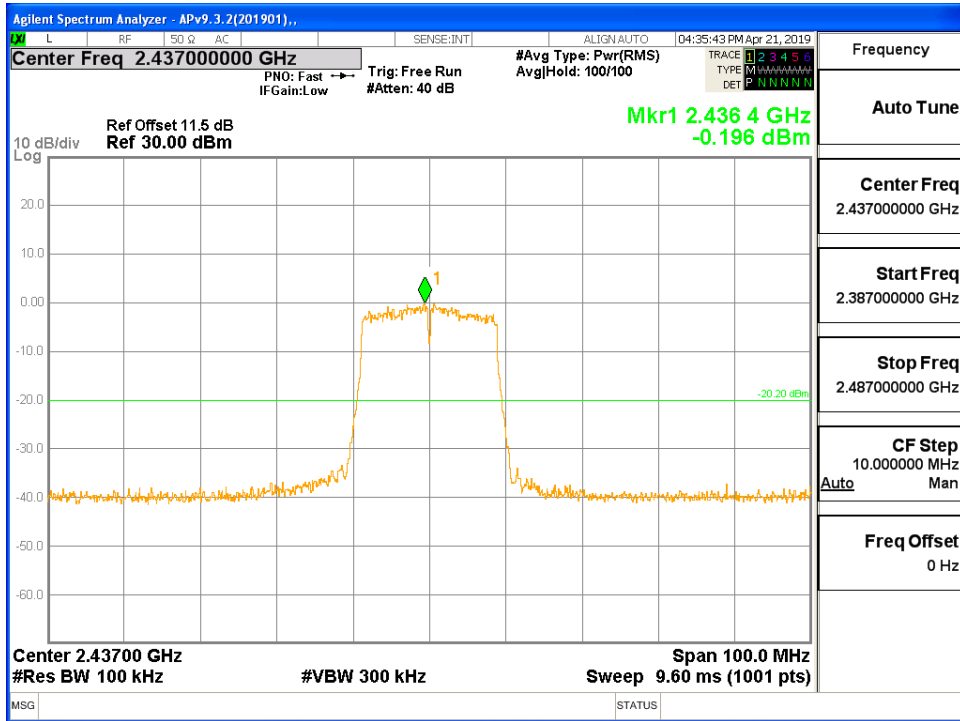

MID CH SPURIOUS EMISSIONS 30M-26G

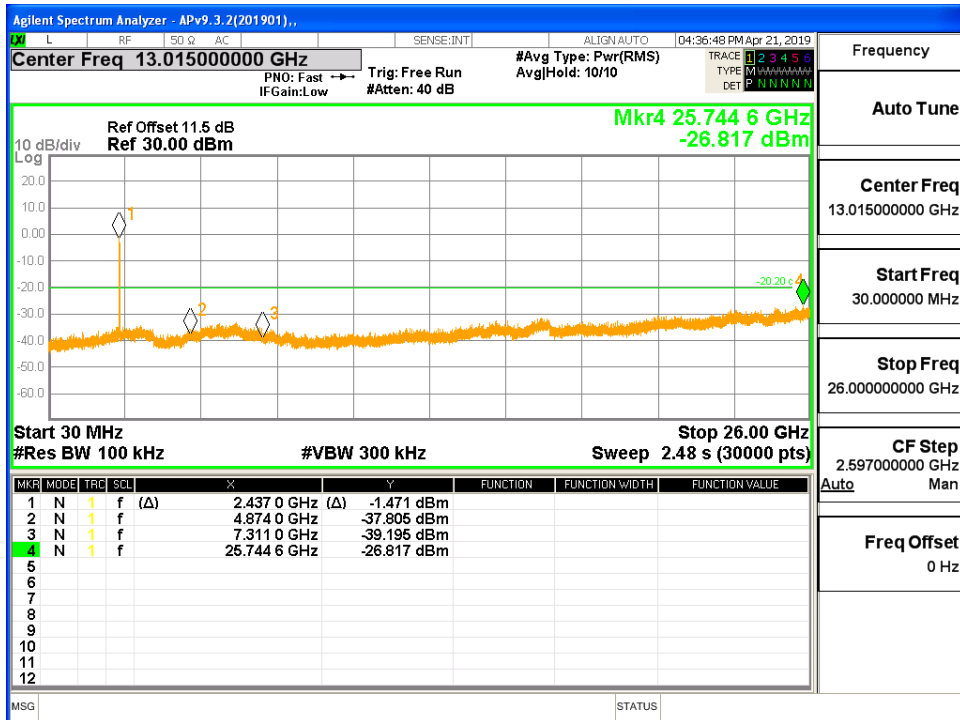



HIGH CH BANDEDGE

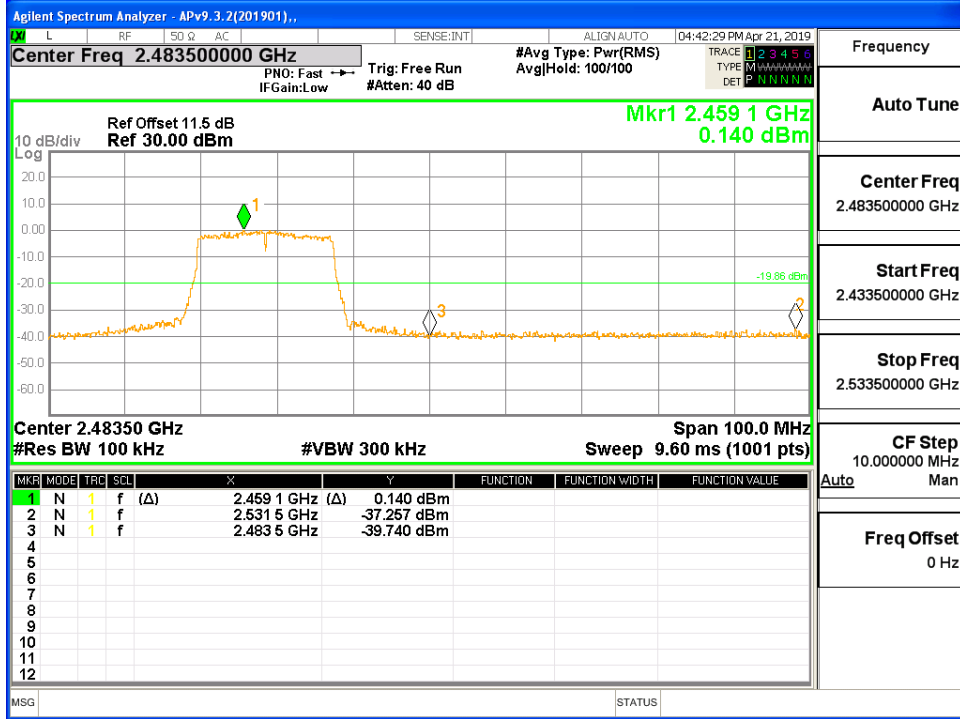

HIGH CH SPURIOUS EMISSIONS 30M-26G

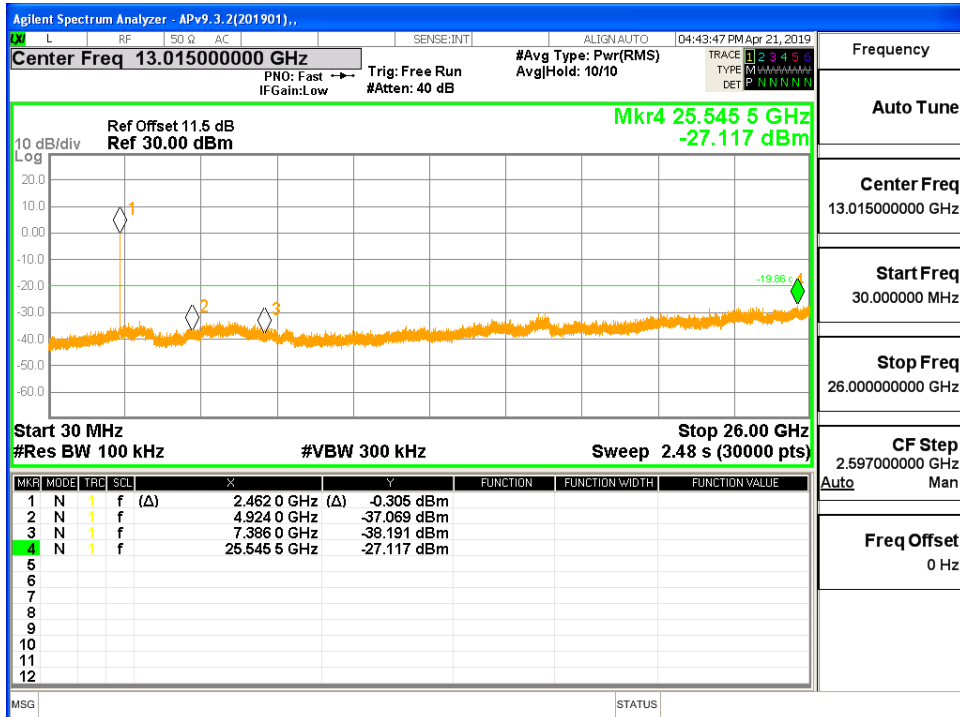



ANTENNA2

LOW CH BANDEDGE

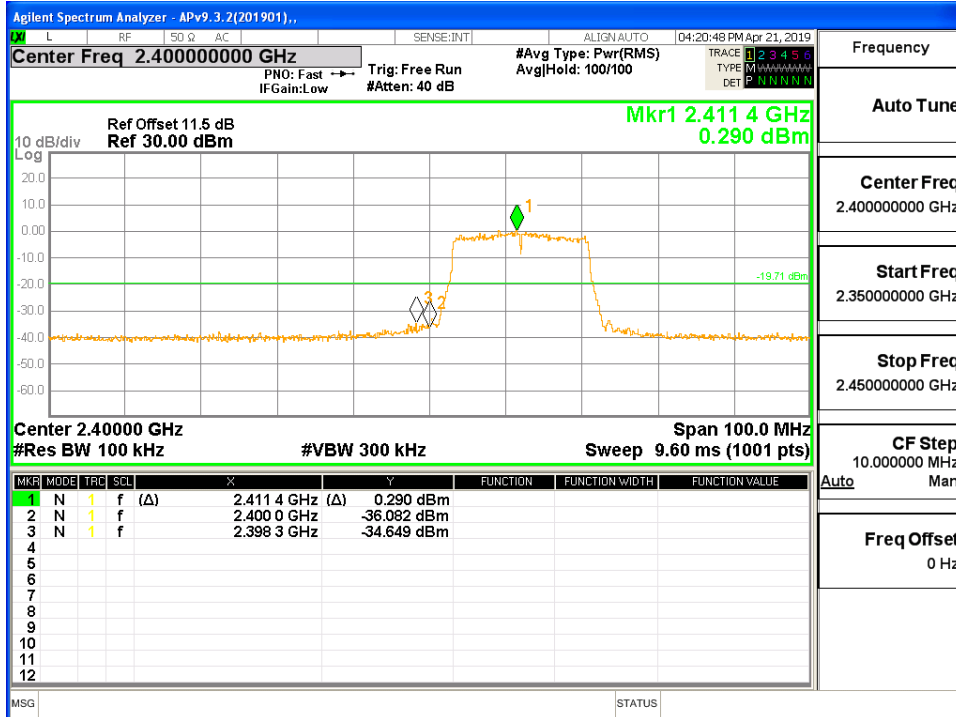

LOW CH SPURIOUS EMISSIONS 30M-26G

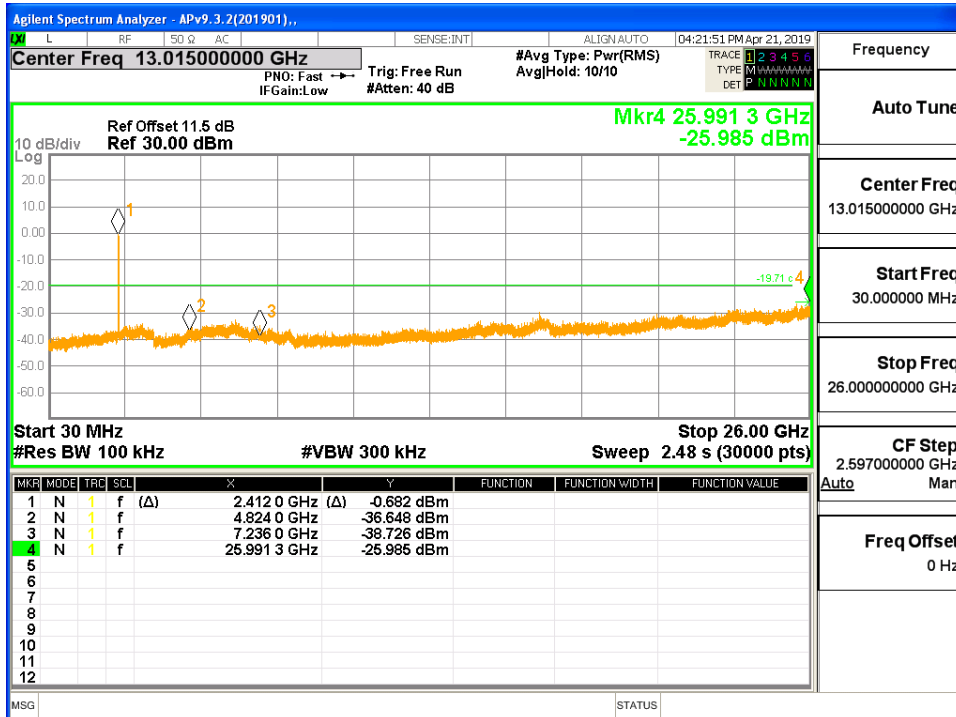



MID CH BANDEDGE

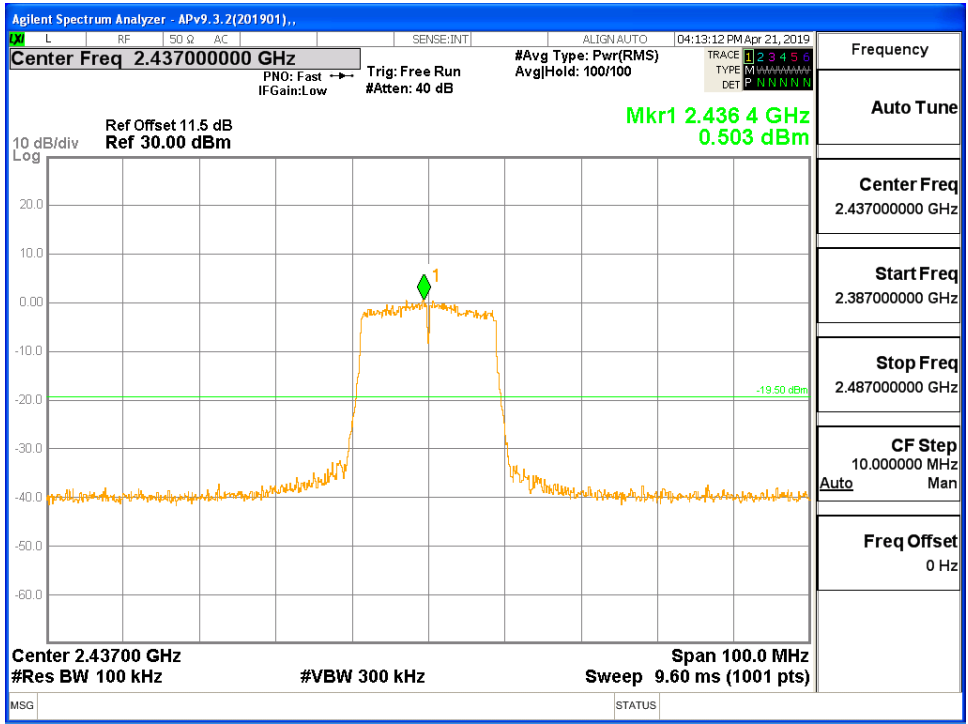

MID CH SPURIOUS EMISSIONS 30M-26G

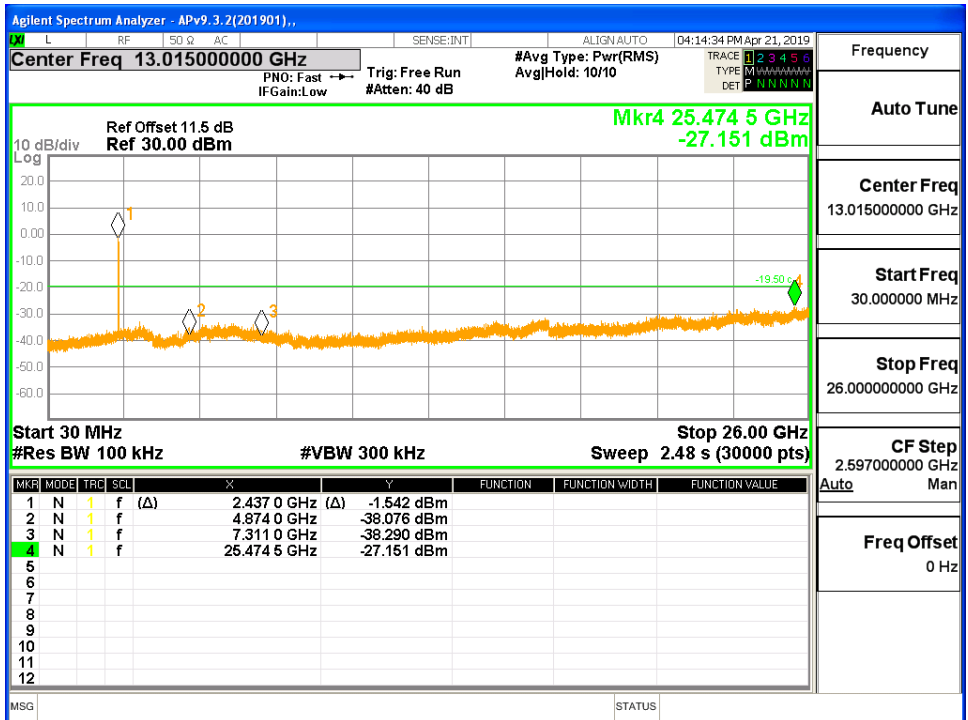



HIGH CH BANDEDGE

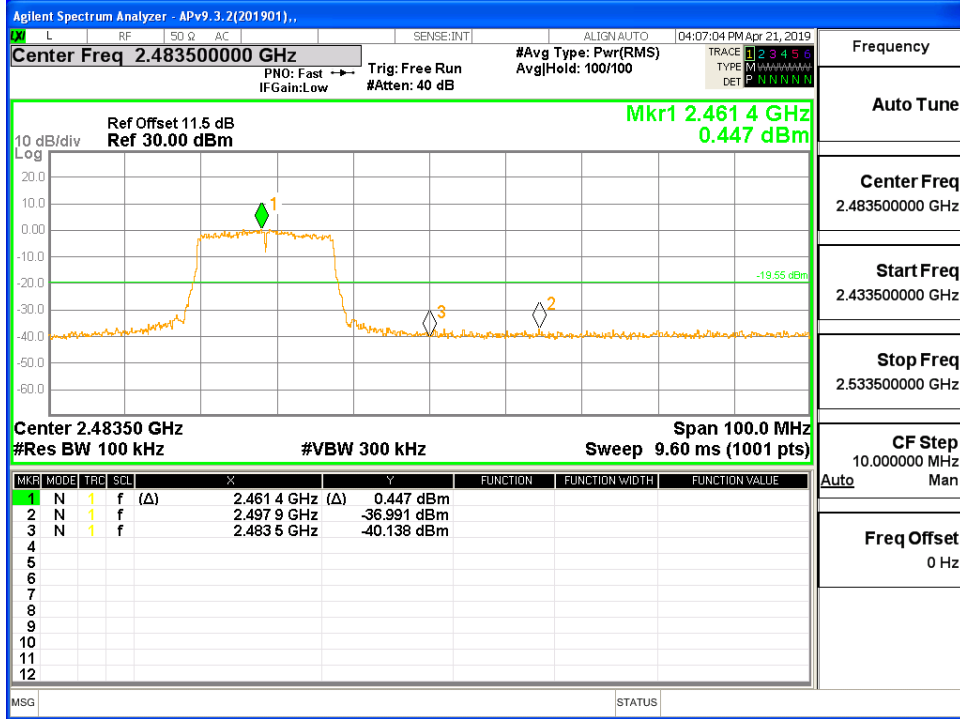

HIGH CH SPURIOUS EMISSIONS 30M-26G

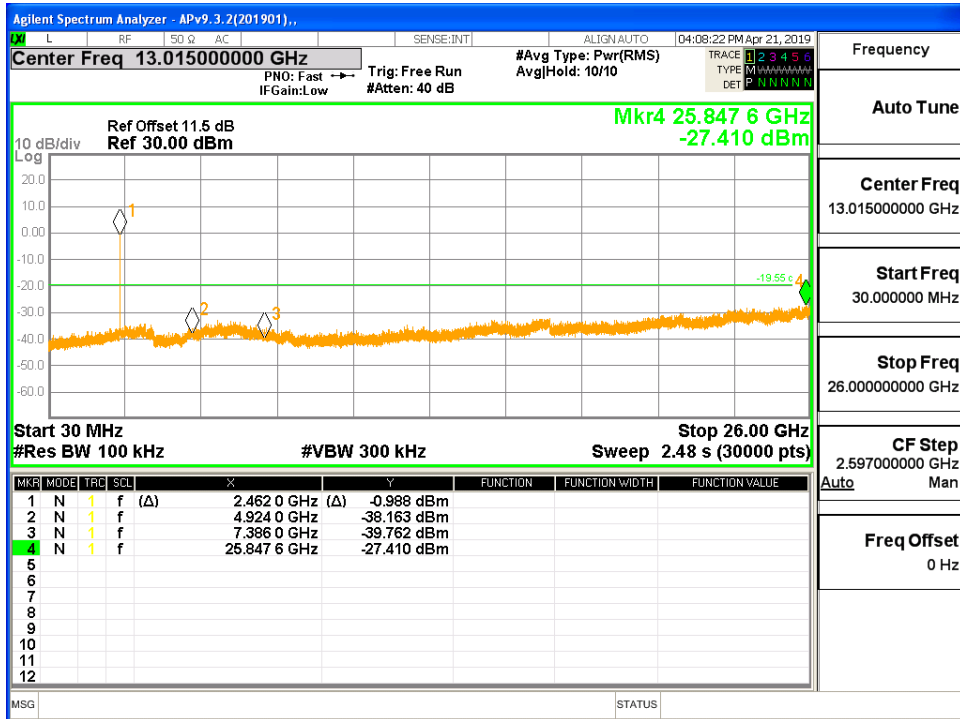

Note: All the modes and antenna ports had been tested, only the worst data recorded in the report.



8.5.4. 802.11n HT40 MIMO MODE

ANTENNA1

LOW CH BANDEDGE

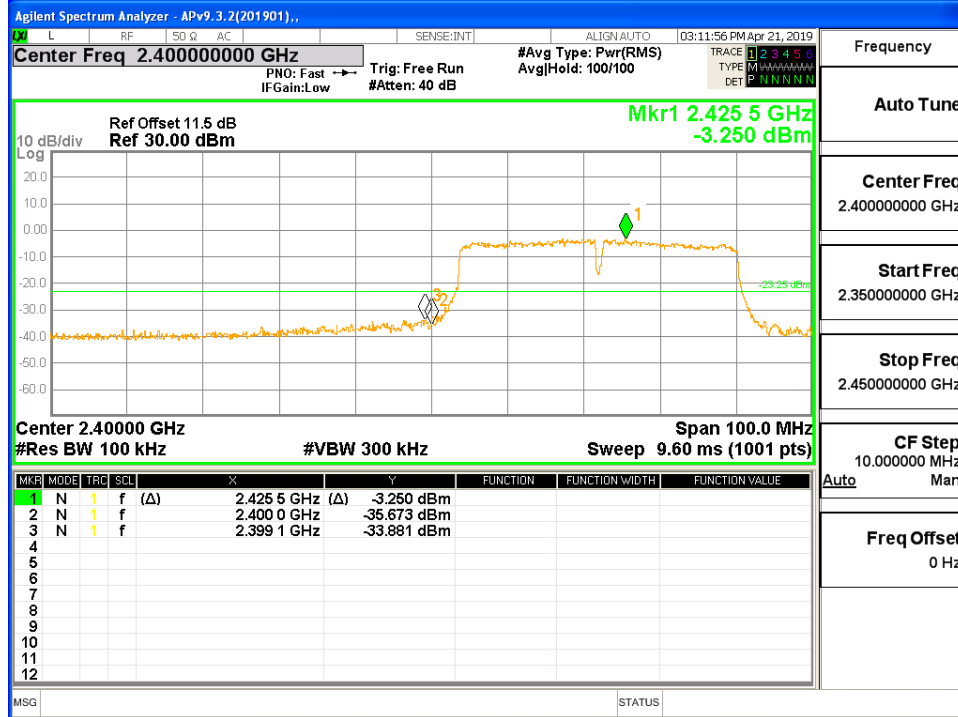

LOW CH SPURIOUS EMISSIONS 30M-26G

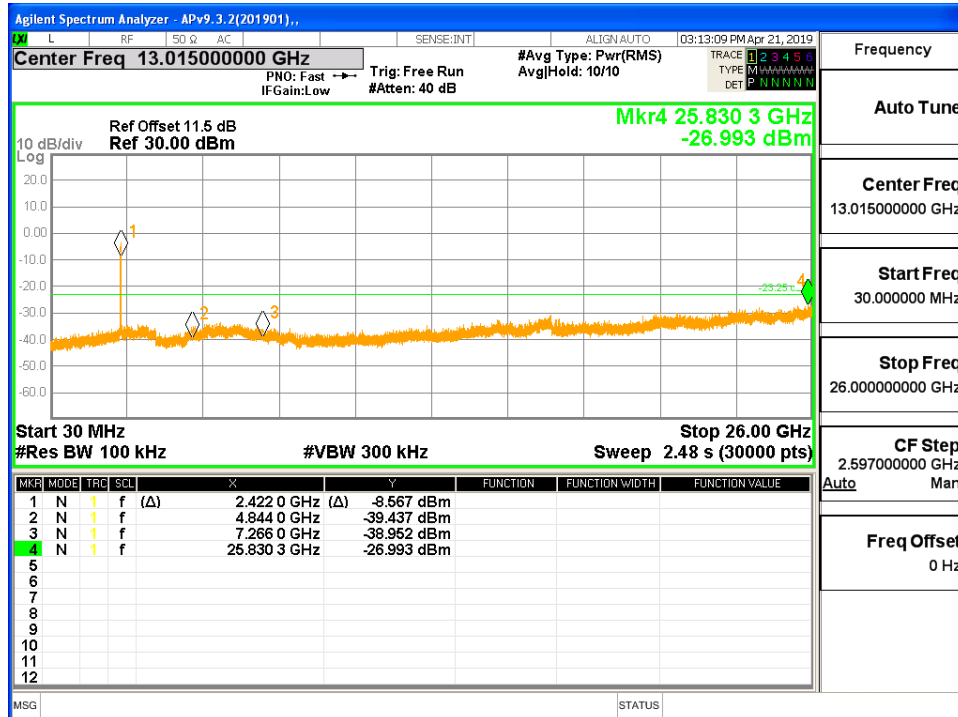



MID CH BANDEDGE

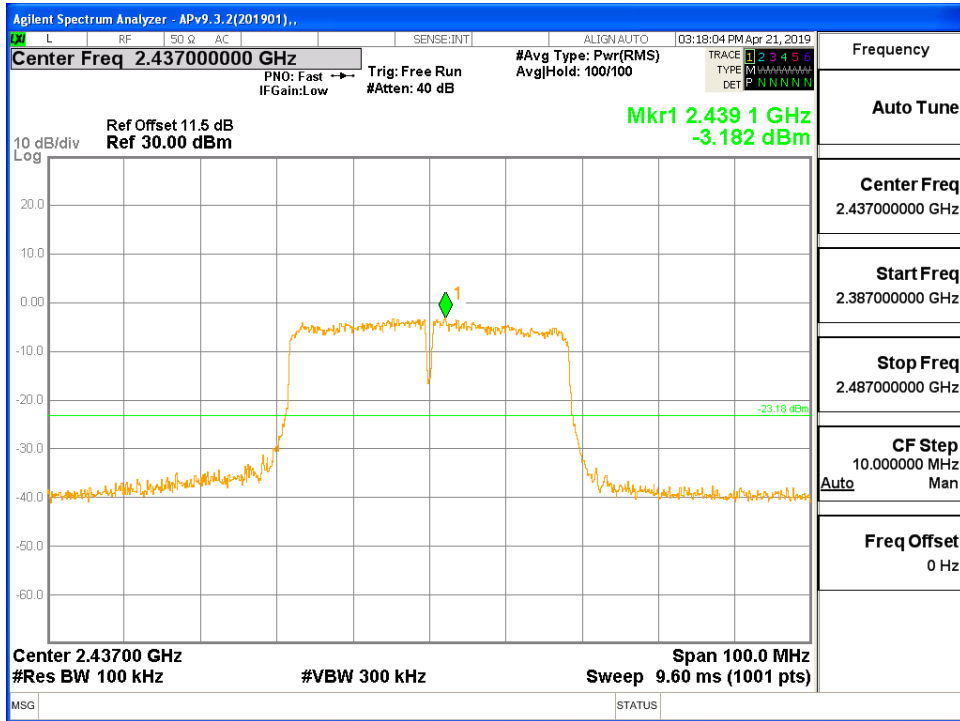

MID CH SPURIOUS EMISSIONS 30M-26G

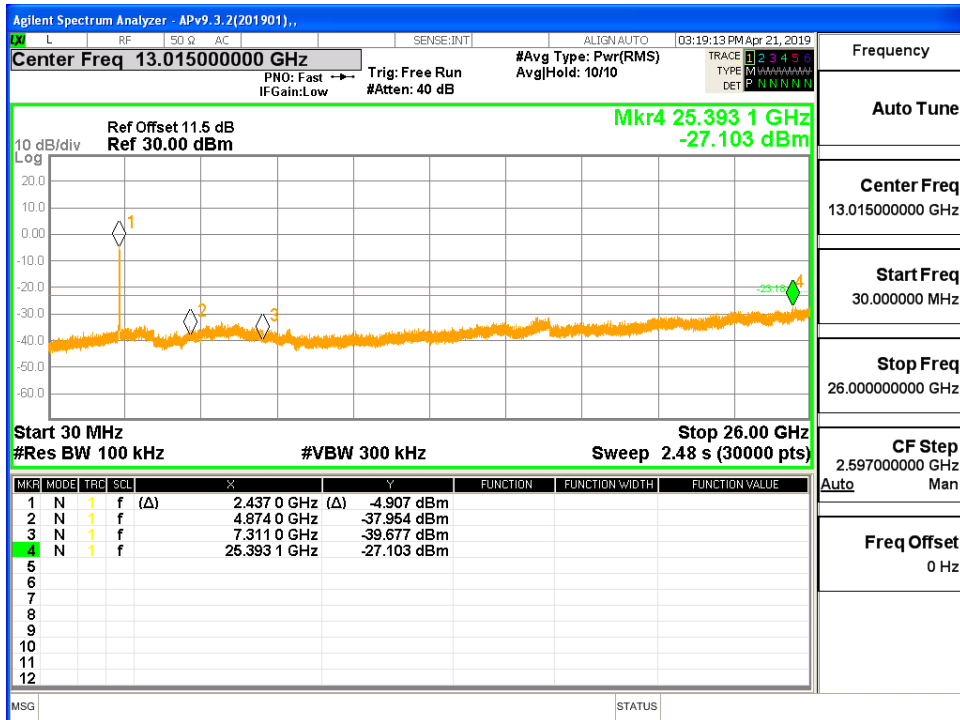



HIGH CH BANDEDGE

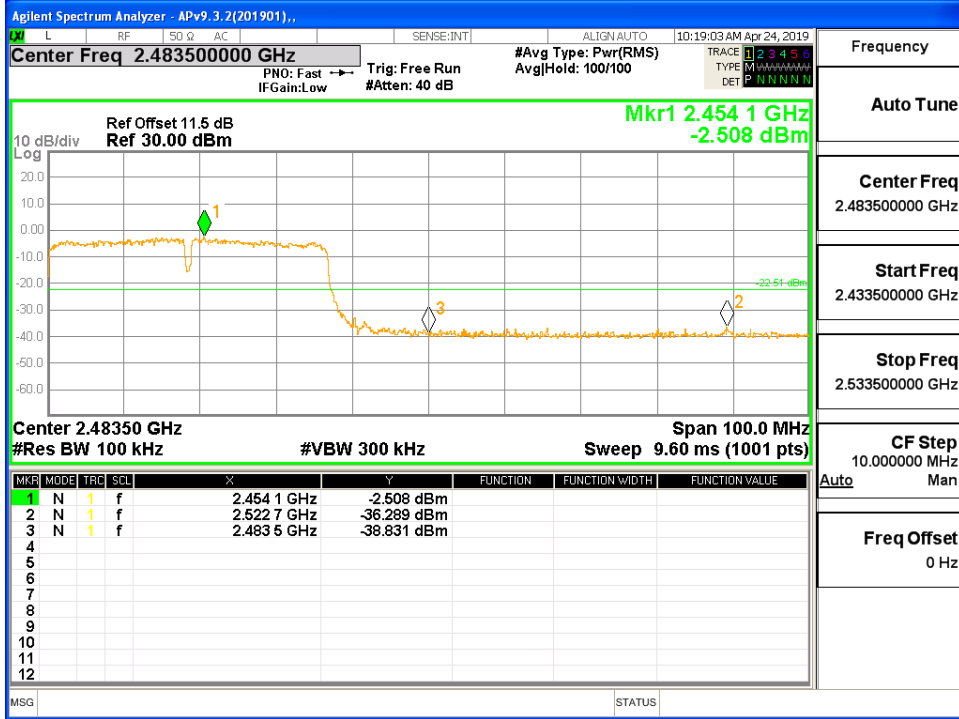

HIGH CH SPURIOUS EMISSIONS 30M-26G

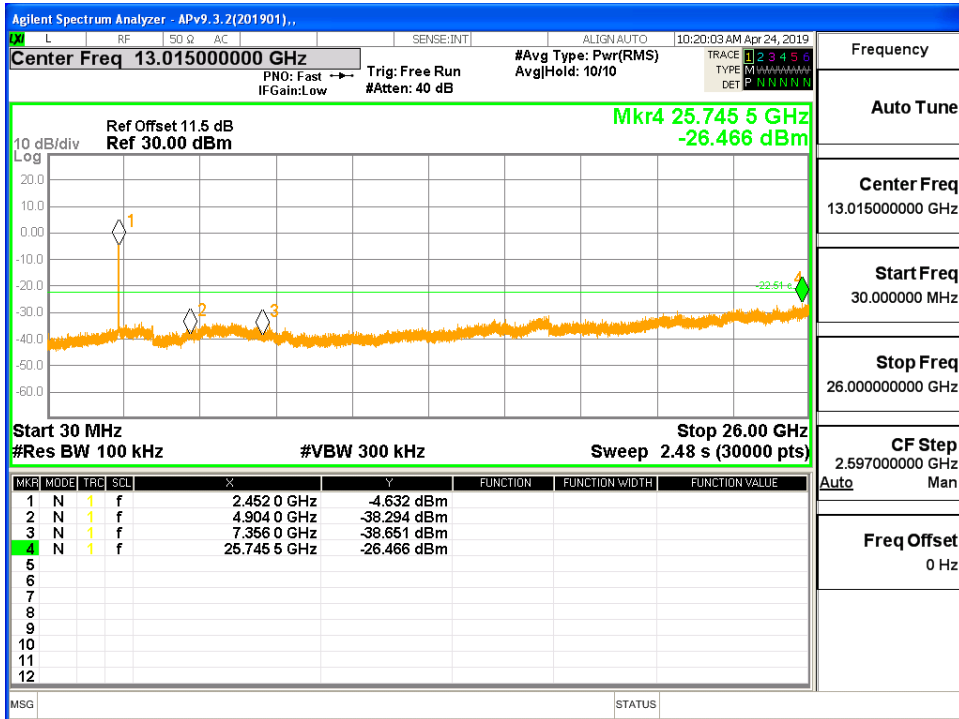



ANTENNA2

LOW CH BANDEDGE

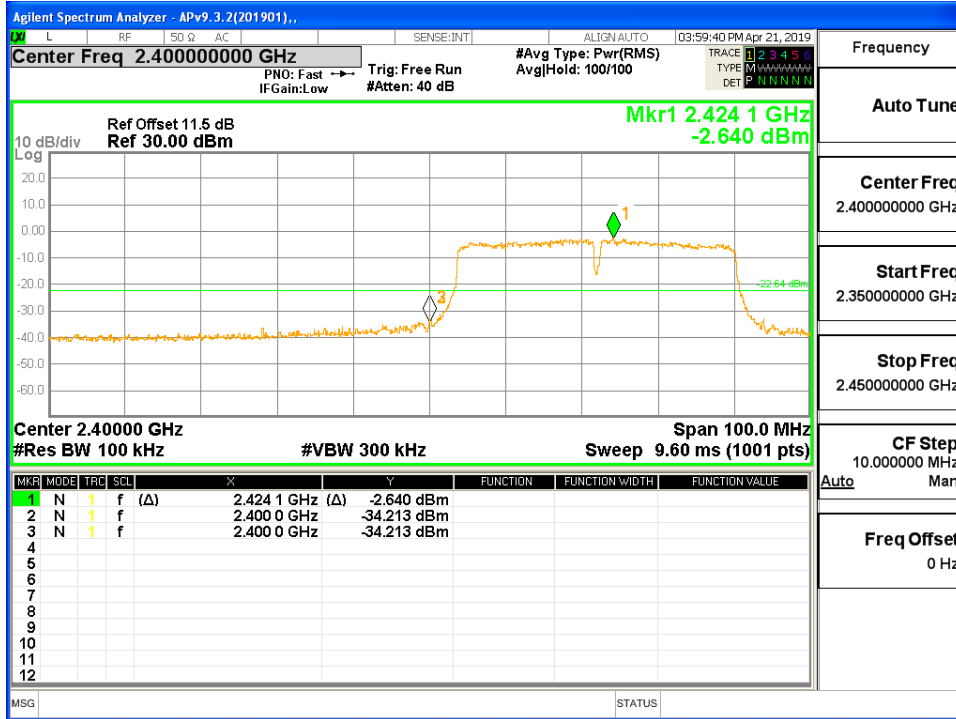

LOW CH SPURIOUS EMISSIONS 30M-26G

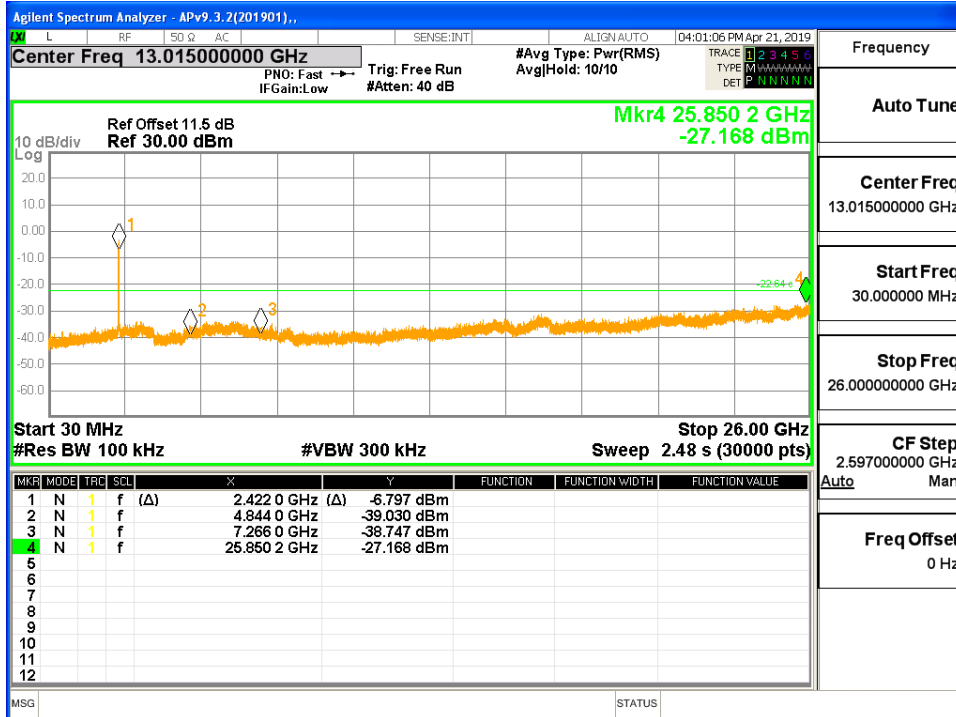



MID CH BANDEDGE

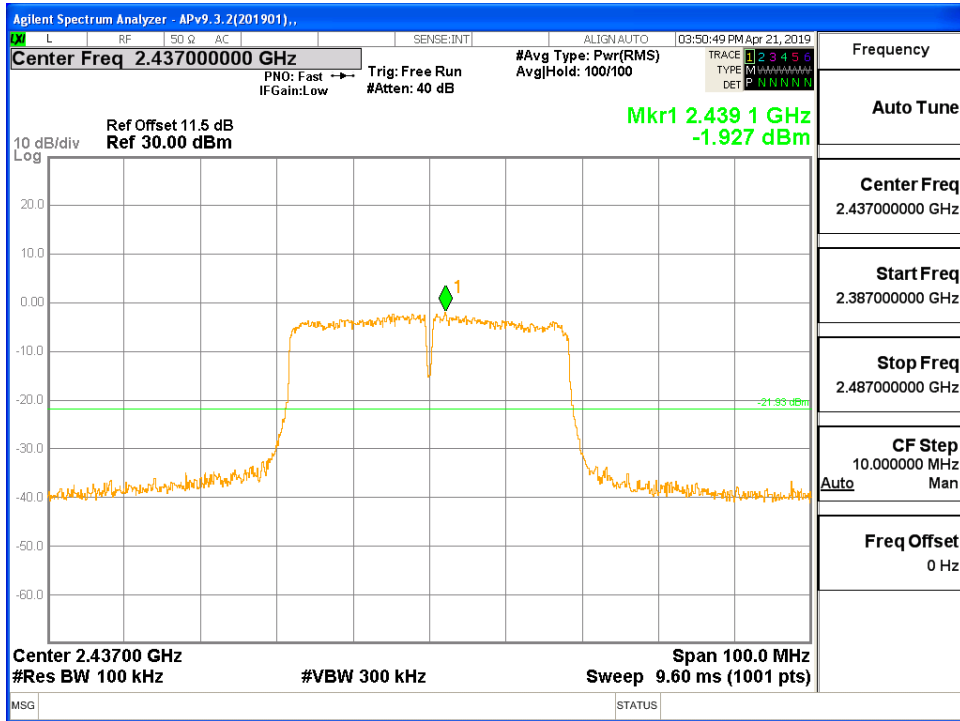

MID CH SPURIOUS EMISSIONS 30M-26G

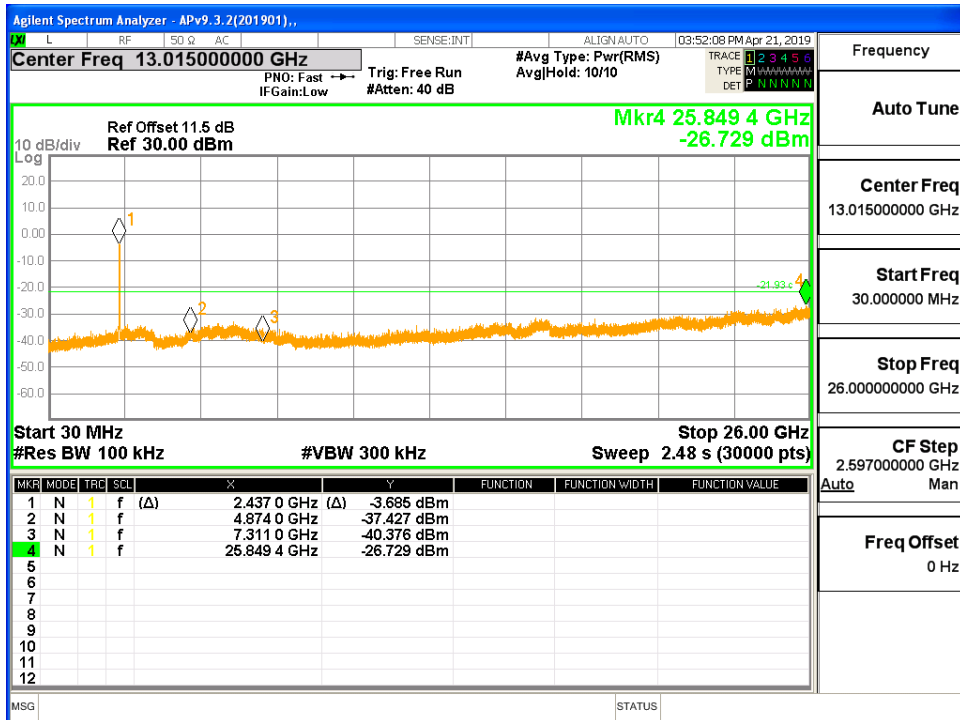



HIGH CH BANDEDGE

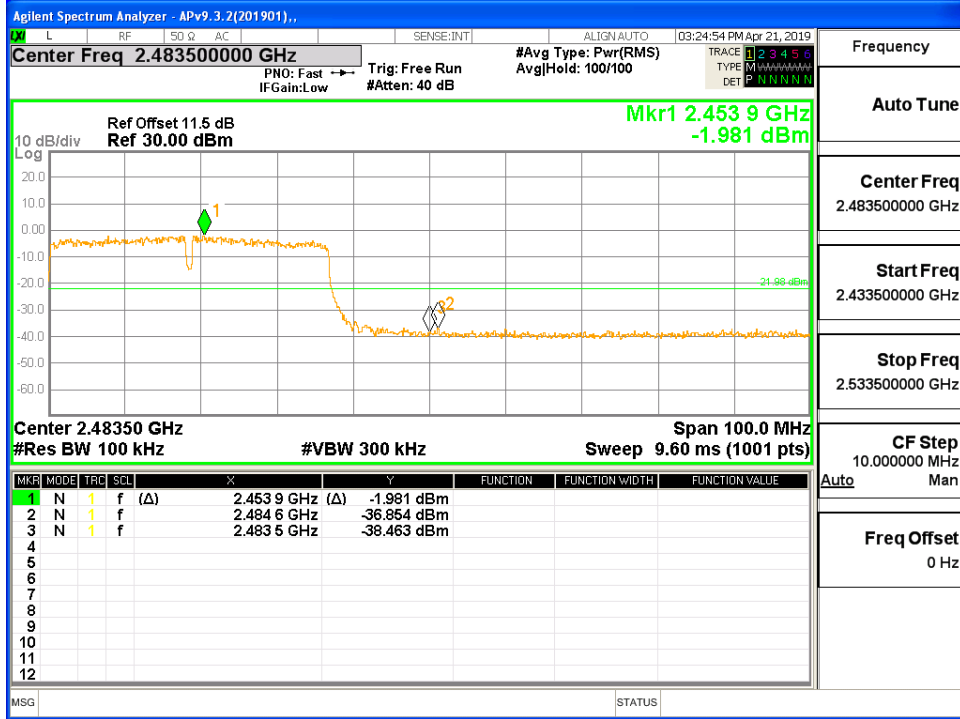

HIGH CH SPURIOUS EMISSIONS 30M-26G

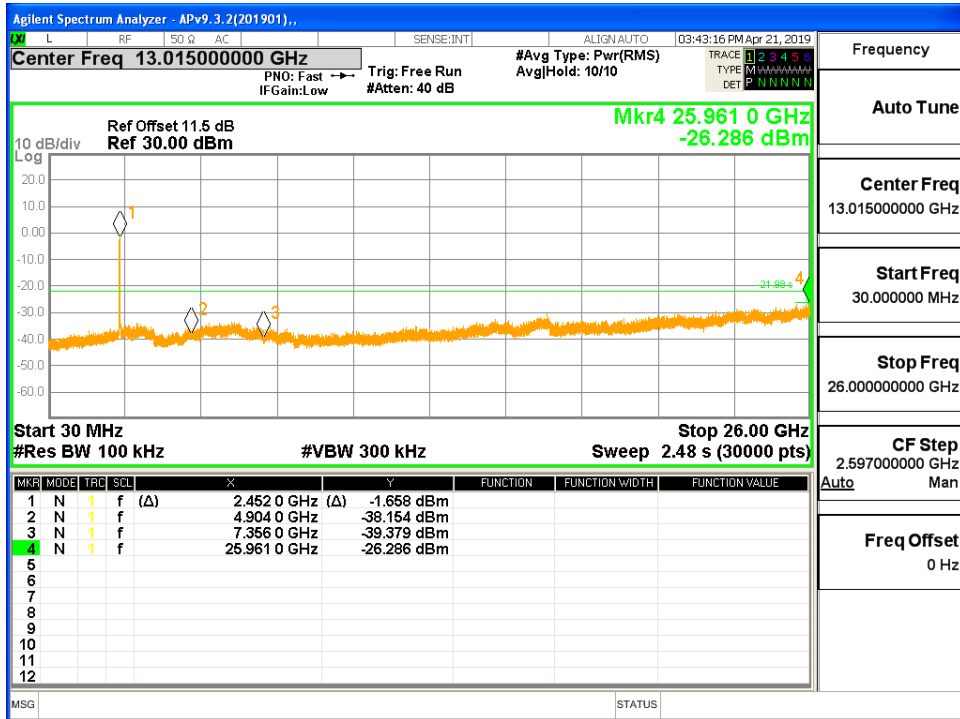

Note: All the modes and antenna ports had been tested, only the worst data recorded in the report.



9. RADIATED TEST RESULTS

LIMITS

Please refer to CFR 47 FCC §15.205 and §15.209

Please refer to ISED RSS-GEN Clause 8.9 (Transmitter)

Radiation Disturbance Test Limit for FCC (Class B)(9KHz-1GHz)

Frequency (MHz)	Field Strength (microvolts/meter)	Measurement Distance (meters)
0.009~0.490	2400/F(KHz)	300
0.490~1.705	24000/F(KHz)	30
1.705~30.0	30	30
30~88	100	3
88~216	150	3
216~960	200	3
960~1000	500	3

Note: 1) At frequencies at or above 30 MHz, measurements may be performed at a distance other than what is specified provided: measurements are not made in the near field except where it can be shown that near field measurements are appropriate due to the characteristics of the device; and it can be demonstrated that the signal levels needed to be measured at the distance employed can be detected by the measurement equipment. Measurements shall not be performed at a distance greater than 30 meters unless it can be further demonstrated that measurements at a distance of 30 meters or less are impractical. When performing measurements at a distance other than that specified, the results shall be extrapolated to the specified distance using an extrapolation factor of 20 dB/decade (inverse linear-distance for field strength measurements; inverse-linear-distance-squared for power density measurements).

(2) At frequencies below 30 MHz, measurements may be performed at a distance closer than that specified in the regulations; however, an attempt should be made to avoid making measurements in the near field. Pending the development of an appropriate measurement procedure for measurements performed below 30 MHz, when performing measurements at a closer distance than specified, the results shall be extrapolated to the specified distance by either making measurements at a minimum of two distances on at least one radial to determine the proper extrapolation factor or by using the square of an inverse linear distance extrapolation factor (40 dB/decade). This paragraph (f) shall not apply to Access BPL devices operating below 30 MHz.



Radiation Disturbance Test Limit for FCC (Above 1G)

Frequency (MHz)	dB(uV/m) (at 3 meters)	
	Peak	Average
Above 1000	74	54

IC Restricted bands please refer to ISED RSS-GEN Clause 8.10

FCC Restricted bands of operation:

MHz	MHz	MHz	GHz
0.090-0.110	16.42-16.423	399.9-410	4.5-5.15
¹ 0.495-0.505	16.69475-16.69525	608-614	5.35-5.46
2.1735-2.1905	16.80425-16.80475	960-1240	7.25-7.75
4.125-4.128	25.5-25.67	1300-1427	8.025-8.5
4.17725-4.17775	37.5-38.25	1435-1626.5	9.0-9.2
4.20725-4.20775	73-74.6	1645.5-1646.5	9.3-9.5
6.215-6.218	74.8-75.2	1660-1710	10.6-12.7
6.26775-6.26825	108-121.94	1718.8-1722.2	13.25-13.4
6.31175-6.31225	123-138	2200-2300	14.47-14.5
8.291-8.294	149.9-150.05	2310-2390	15.35-16.2
8.362-8.366	156.52475-156.52525	2483.5-2500	17.7-21.4
8.37625-8.38675	156.7-156.9	2690-2900	22.01-23.12
8.41425-8.41475	162.0125-167.17	3260-3267	23.6-24.0
12.29-12.293	167.72-173.2	3332-3339	31.2-31.8
12.51975-12.52025	240-285	3345.8-3358	36.43-36.5
12.57675-12.57725	322-335.4	3600-4400	(²)
13.36-13.41			

Note: ¹Until February 1, 1999, this restricted band shall be 0.490-0.510 MHz.

²Above 38.6c

TEST SETUP AND PROCEDURE

Below 30MHz

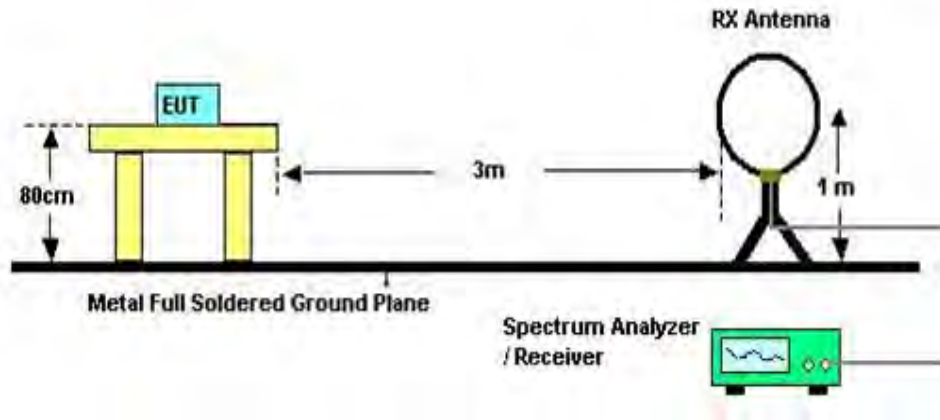

The setting of the spectrum analyser

RBW	200Hz (From 9kHz to 0.15MHz)/ 9KHz (From 0.15MHz to 30MHz)
VBW	200Hz (From 9kHz to 0.15MHz)/ 9KHz (From 0.15MHz to 30MHz)
Sweep	Auto
Detector	Peak/QP/ Average
Trace	Max hold

1. The testing follows the guidelines in ANSI C63.10-2013
2. The EUT was arranged to its worst case and then turntable (from 0 degree to 360 degrees) to find the maximum reading. A pre-amp and a high pass filter are used for the test in order to get better signal level. Both horizontal and vertical polarizations of the antenna are set to make the measurement.
3. The EUT was placed on a turntable with 0.8 meter above ground.
4. The EUT was set 3 meters from the interference receiving antenna, which was mounted on the top of a variable height antenna tower.
5. For measurement below 1GHz, the initial step in collecting conducted emission data is a spectrum analyzer peak detector mode pre-scanning the measurement frequency range. Significant peaks are then marked and then Quasi Peak detector mode re-measured. If the emission level of the EUT measured by the peak detector is 3 dB lower than the applicable limit, the peak emission level will be reported. Otherwise, the emission measurement will be repeated using the quasi-peak detector and reported.
6. Although these tests were performed other than open field site, adequate comparison measurements were confirmed against 30m open field site. Therefore sufficient tests were made to demonstrate that the alternative site produces results that correlate with the ones of tests made in an open field site based on KDB 414788.

Below 1G

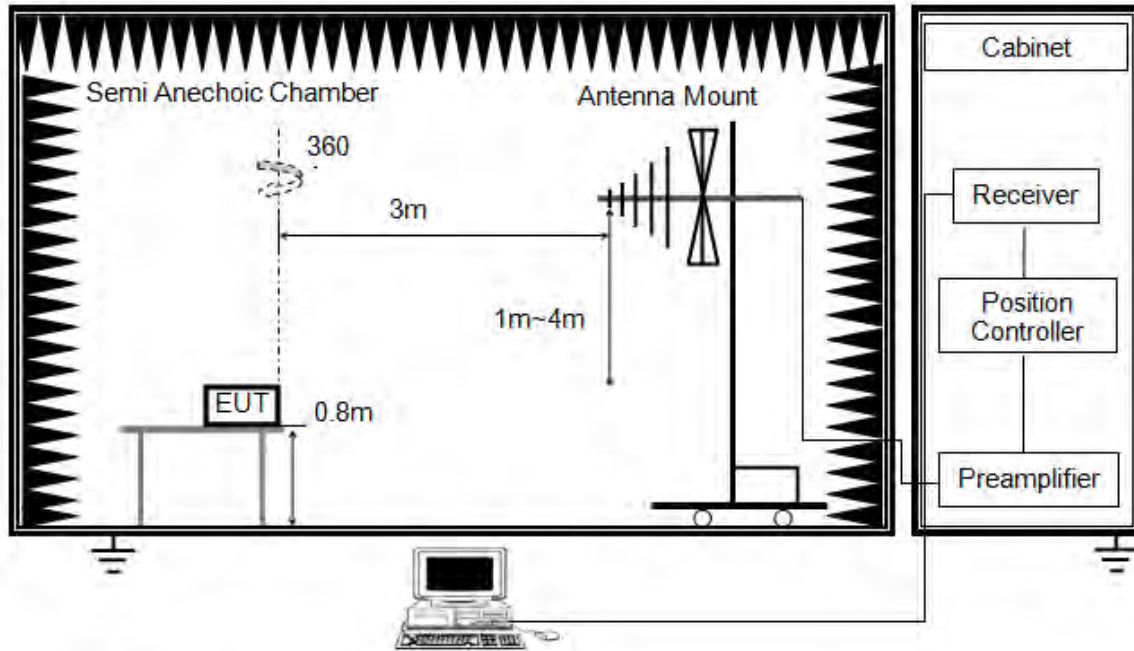

The setting of the spectrum analyser

RBW	120K
VBW	300K
Sweep	Auto
Detector	Peak/QP
Trace	Max hold

1. The testing follows the guidelines in ANSI C63.10-2013.
2. The EUT was arranged to its worst case and then tune the antenna tower (from 1 m to 4 m) and turntable (from 0 degree to 360 degrees) to find the maximum reading. A pre-amp and a high pass filter are used for the test in order to get better signal level. Both horizontal and vertical polarizations of the antenna are set to make the measurement.
3. The EUT was placed on a turntable with 0.8 meter above ground.
4. The EUT was set 3 meters from the interference receiving antenna, which was mounted on the top of a variable height antenna tower.
5. For measurement below 1GHz, the initial step in collecting conducted emission data is a spectrum analyzer peak detector mode pre-scanning the measurement frequency range. Significant peaks are then marked and then Quasi Peak detector mode re-measured. If the emission level of the EUT measured by the peak detector is 3 dB lower than the applicable limit, the peak emission level will be reported. Otherwise, the emission measurement will be repeated using the quasi-peak detector and reported.

ABOVE 1G

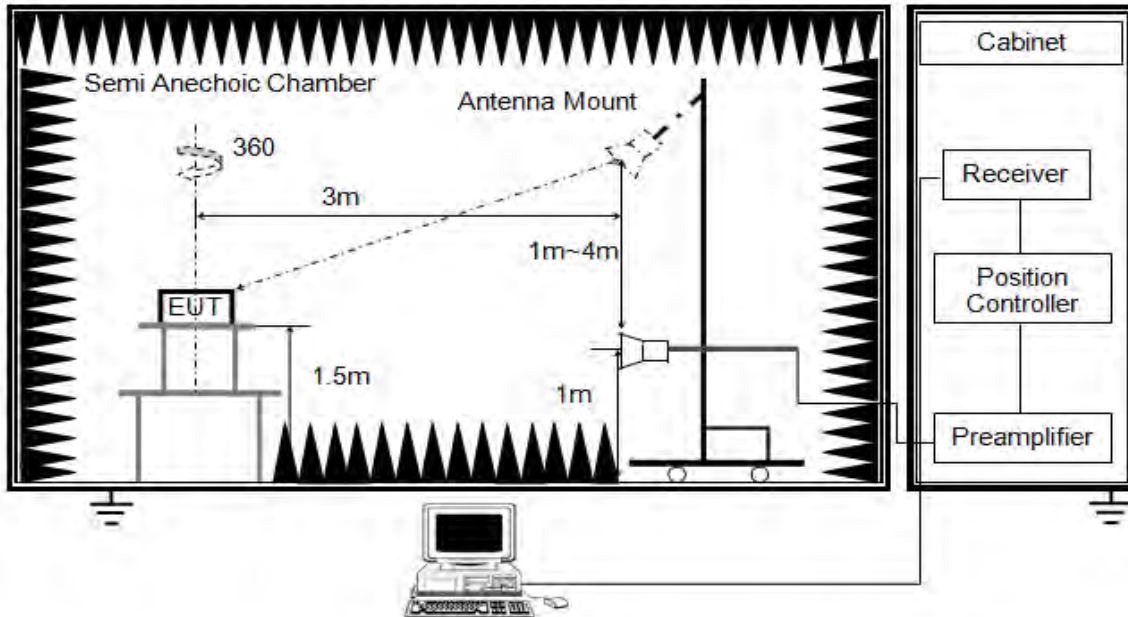

The setting of the spectrum analyser

RBW	1M
VBW	PEAK: 3M AVG: see note 6
Sweep	Auto
Detector	Peak
Trace	Max hold

1. The testing follows the guidelines in ANSI C63.10-2013.
2. The EUT was arranged to its worst case and then tune the antenna tower (from 1 m to 4 m) and turntable (from 0 degree to 360 degrees) to find the maximum reading. A pre-amp and a high pass filter are used for the test in order to get better signal level. Both horizontal and vertical polarizations of the antenna are set to make the measurement.
3. The EUT was placed on a turntable with 1.5m above ground.
4. The EUT was set 3 meters from the interference receiving antenna, which was mounted on the top of a variable height antenna tower.
5. For measurement above 1GHz, the emission measurement will be measured by the peak detector. This peak level, once corrected, must comply with the limit specified in Section 15.209.
6. For measurements above 1 GHz the resolution bandwidth is set to 1 MHz, then the video bandwidth is set to 3 MHz for peak measurements and 1 MHz resolution bandwidth with 1/T video bandwidth with peak detector for average measurements. For the Duty Cycle please refer to clause 8.1.ON TIME AND DUTY CYCLE.

X axis, Y axis, Z axis positions:

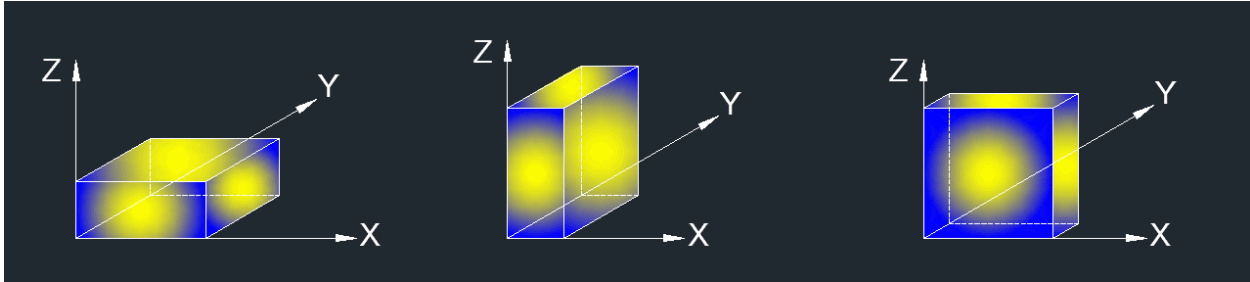

Note : For all radiated test, EUT in each of three orthogonal axis emissions had been tested, but only the worst case (X axis) data recorded in the report.

TEST ENVIRONMENT

Temperature	24.4°C	Relative Humidity	58%
Atmosphere Pressure	101kPa	Test Voltage	AC 120V,60Hz



9.1. RESTRICTED BANDEDGE

9.1.1. 802.11b SISO MODE

ANTENNA1

RESTRICTED BANDEDGE (LOW CHANNEL, HORIZONTAL)

PEAK

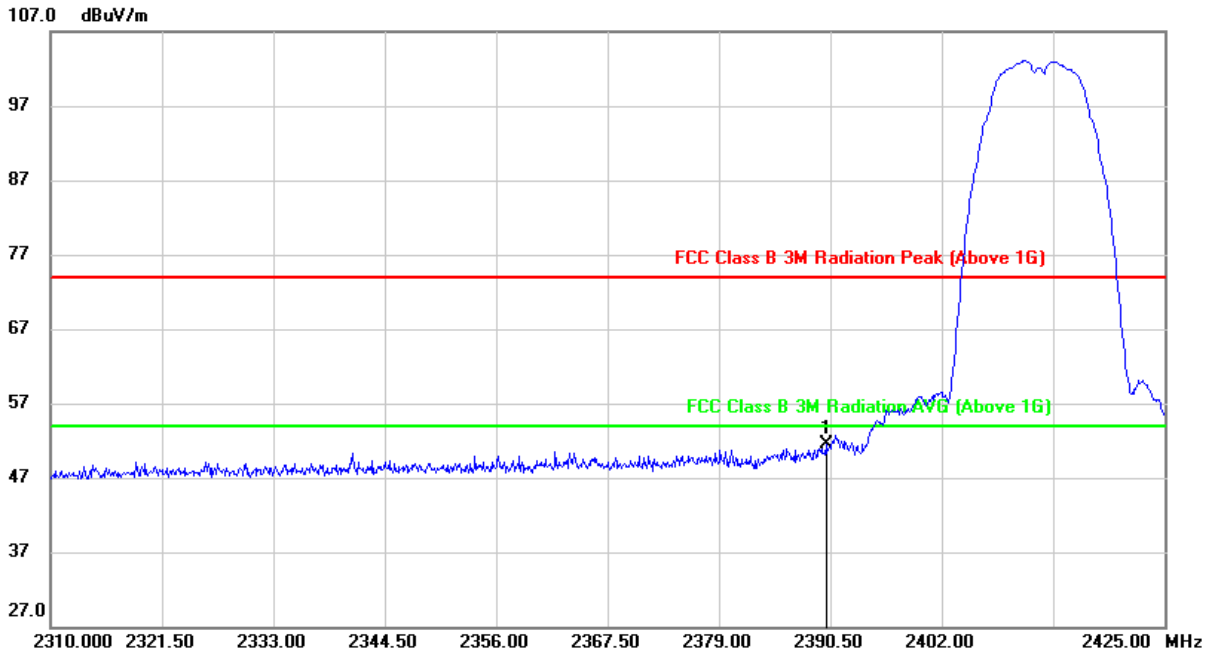

No.	Frequency (MHz)	Reading (dBuV)	Correct (dB/m)	Result (dBuV/m)	Limit (dBuV/m)	Margin (dB)	Remark
1	2390.000	18.52	32.94	51.46	74.00	-22.54	peak

- Note:
1. Measurement = Reading Level + Correct Factor.
 2. If Peak Result complies with AV limit, AV Result is deemed to comply with AV limit.
 3. Peak: Peak detector.
 4. Only the worst case emission was recorded, if it complies with the limit, the other emissions deemed to comply with the limit.



RESTRICTED BANDEDGE (LOW CHANNEL, VERTICAL)

PEAK

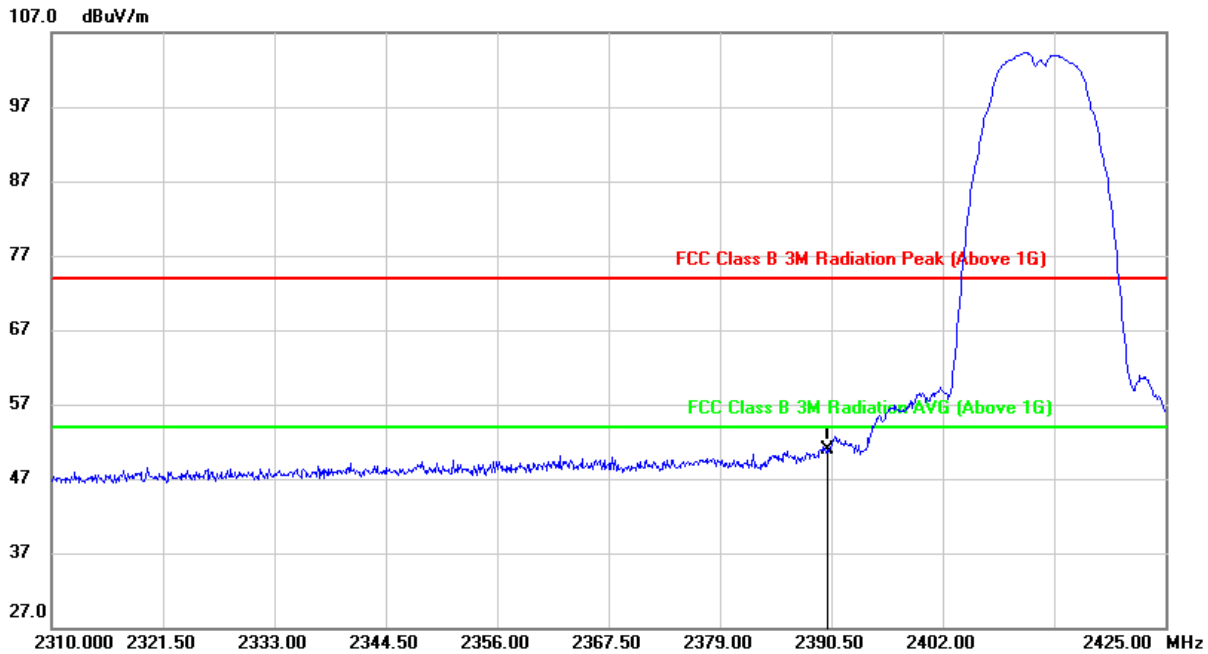

No.	Frequency (MHz)	Reading (dBuV)	Correct (dB/m)	Result (dBuV/m)	Limit (dBuV/m)	Margin (dB)	Remark
1	2390.000	18.02	32.94	50.96	74.00	-23.04	peak

- Note:
1. Measurement = Reading Level + Correct Factor.
 2. If Peak Result complies with AV limit, AV Result is deemed to comply with AV limit.
 3. AVG: $VBW=1/Ton$ where: ton is transmit duration.
 4. For transmit duration, please refer to clause 8.1.
 5. Only the worst case emission was recorded, if it complies with the limit, the other emissions deemed to comply with the limit.



RESTRICTED BANDEDGE (HIGH CHANNEL, HORIZONTAL)

PEAK

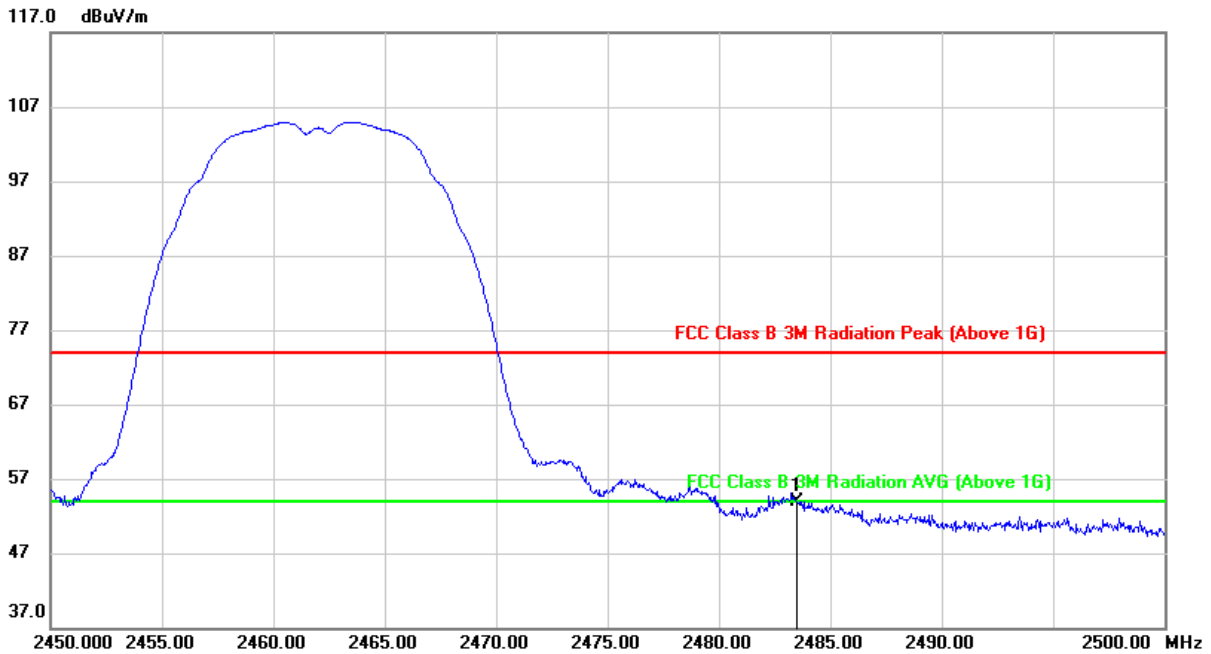

No.	Frequency (MHz)	Reading (dBuV)	Correct (dB/m)	Result (dBuV/m)	Limit (dBuV/m)	Margin (dB)	Remark
1	2483.500	20.41	33.58	53.99	74.00	-20.01	peak

- Note:
1. Measurement = Reading Level + Correct Factor.
 2. If Peak Result complies with AV limit, AV Result is deemed to comply with AV limit.
 3. Peak: Peak detector.
 4. Only the worst case emission was recorded, if it complies with the limit, the other emissions deemed to comply with the limit.



AVG

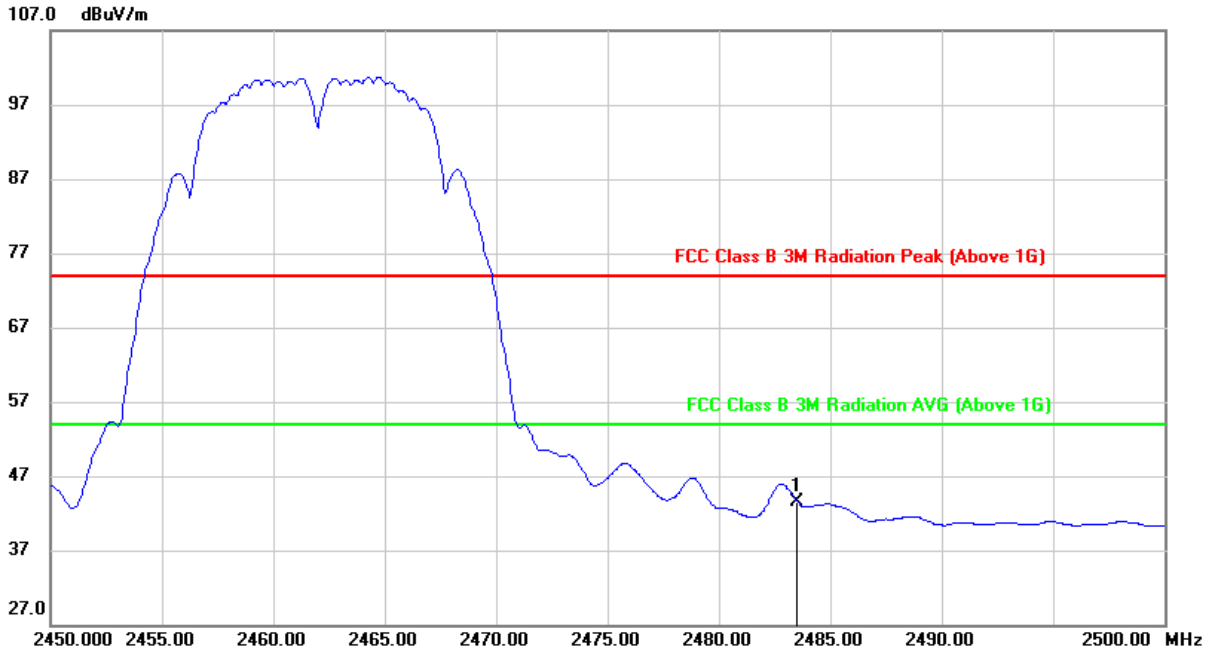

No.	Frequency (MHz)	Reading (dBuV)	Correct (dB/m)	Result (dBuV/m)	Limit (dBuV/m)	Margin (dB)	Remark
1	2483.500	10.02	33.58	43.60	54.00	-10.40	AVG

- Note:
1. Measurement = Reading Level + Correct Factor.
 2. If Peak Result complies with AV limit, AV Result is deemed to comply with AV limit.
 3. AVG: $VBW=1/T_{on}$ where: t_{on} is transmit duration.
 4. For transmit duration, please refer to clause 8.1.
 5. Only the worst case emission was recorded, if it complies with the limit, the other emissions deemed to comply with the limit.



RESTRICTED BANDEDGE (HIGH CHANNEL, VERTICAL)

PEAK

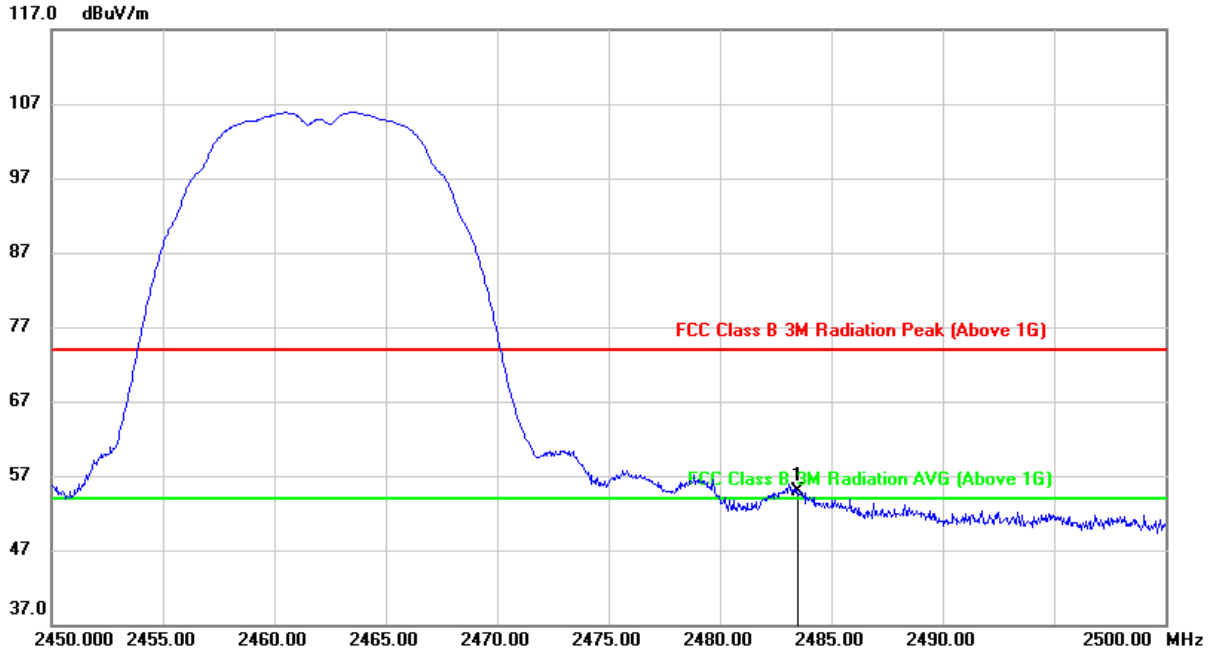

No.	Frequency (MHz)	Reading (dBuV)	Correct (dB/m)	Result (dBuV/m)	Limit (dBuV/m)	Margin (dB)	Remark
1	2483.500	21.39	33.58	54.97	74.00	-19.03	peak

- Note:
1. Measurement = Reading Level + Correct Factor.
 2. If Peak Result complies with AV limit, AV Result is deemed to comply with AV limit.
 3. Peak: Peak detector.
 4. Only the worst case emission was recorded, if it complies with the limit, the other emissions deemed to comply with the limit.



AVG

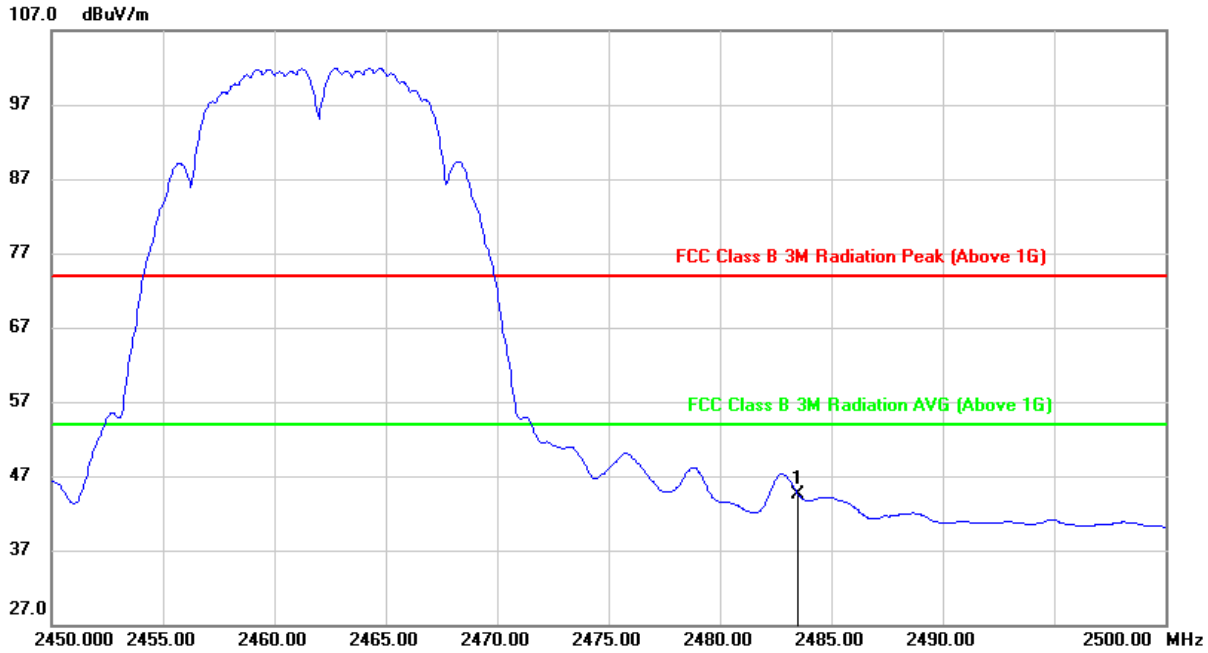

No.	Frequency (MHz)	Reading (dBuV)	Correct (dB/m)	Result (dBuV/m)	Limit (dBuV/m)	Margin (dB)	Remark
1	2483.500	10.99	33.58	44.57	54.00	-9.43	AVG

- Note:
1. Measurement = Reading Level + Correct Factor.
 2. If Peak Result complies with AV limit, AV Result is deemed to comply with AV limit.
 3. AVG: $VBW=1/Ton$ where: ton is transmit duration.
 4. For transmit duration, please refer to clause 8.1.
 5. Only the worst case emission was recorded, if it complies with the limit, the other emissions deemed to comply with the limit.

Note: All antennas have been tested, only the worst data record in the report.



9.1.2. 802.11g SISO MODE

ANTENNA1

RESTRICTED BANDEDGE (LOW CHANNEL, HORIZONTAL)

PEAK

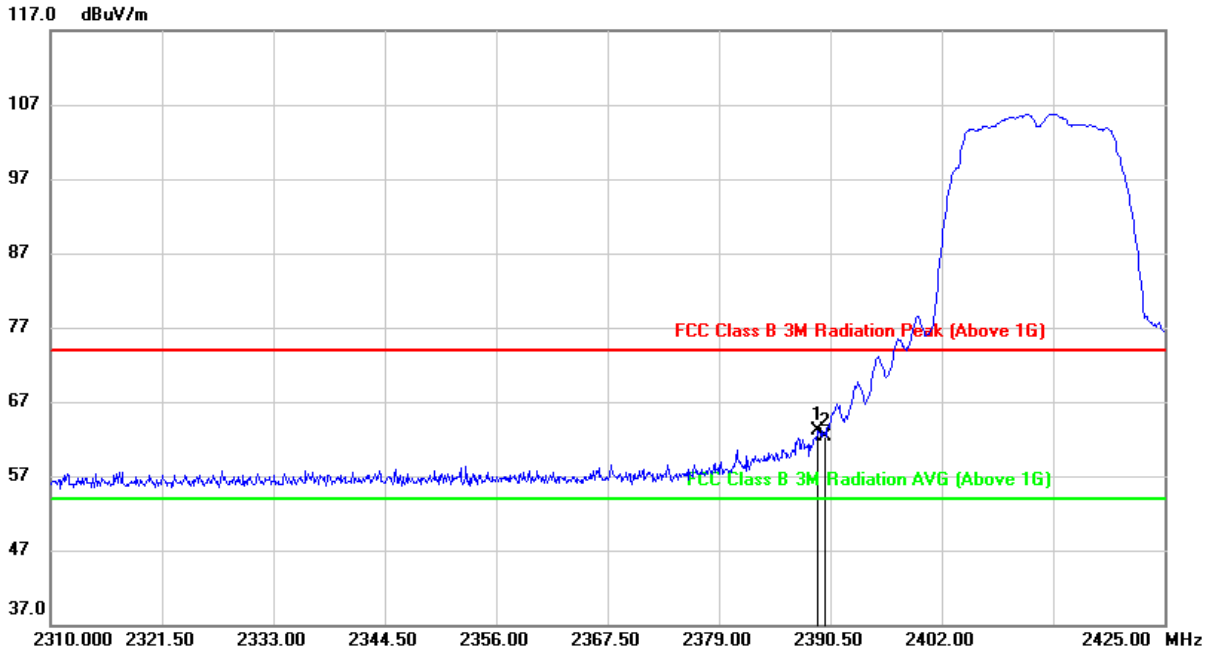

No.	Frequency (MHz)	Reading (dBuV)	Correct (dB/m)	Result (dBuV/m)	Limit (dBuV/m)	Margin (dB)	Remark
1	2389.235	30.14	32.94	63.08	74.00	-10.92	peak
2	2390.000	29.39	32.94	62.33	74.00	-11.67	peak

- Note:
1. Measurement = Reading Level + Correct Factor.
 2. If Peak Result complies with AV limit, AV Result is deemed to comply with AV limit.
 3. Peak: Peak detector.
 4. Only the worst case emission was recorded, if it complies with the limit, the other emissions deemed to comply with the limit.



AVG

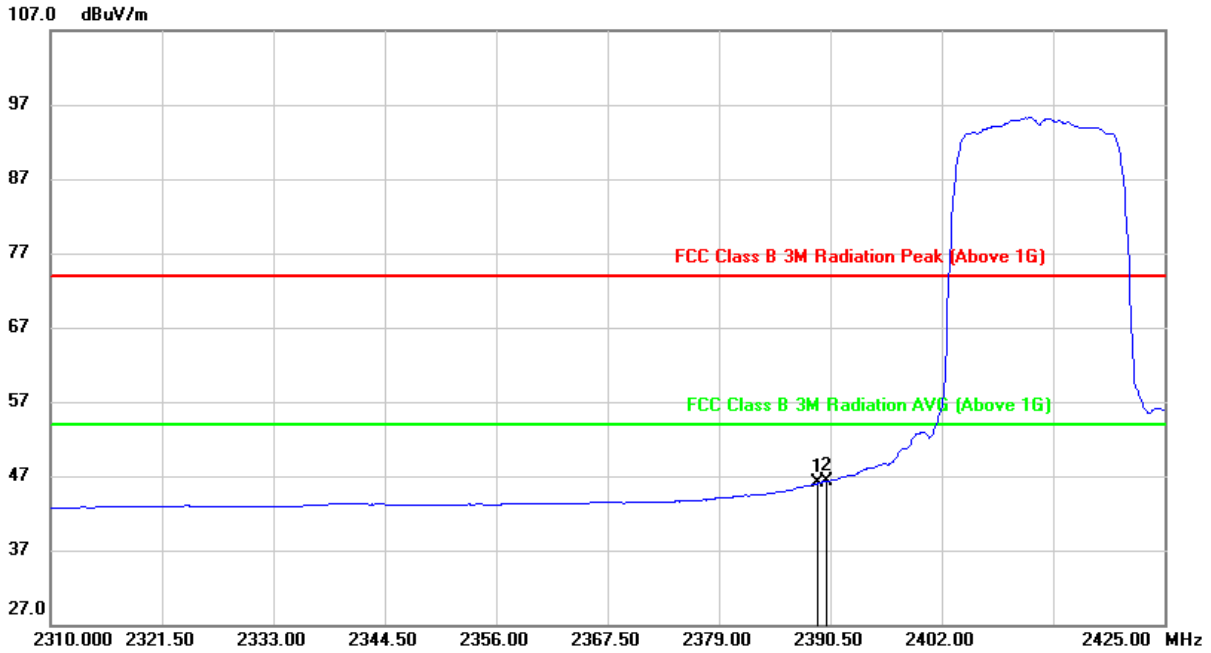

No.	Frequency (MHz)	Reading (dBuV)	Correct (dB/m)	Result (dBuV/m)	Limit (dBuV/m)	Margin (dB)	Remark
1	2389.235	13.09	32.94	46.03	54.00	-7.97	AVG
2	2390.000	13.37	32.94	46.31	54.00	-7.69	AVG

- Note:
1. Measurement = Reading Level + Correct Factor.
 2. If Peak Result complies with AV limit, AV Result is deemed to comply with AV limit.
 3. AVG: $VBW=1/Ton$ where: ton is transmit duration.
 4. For transmit duration, please refer to clause 8.1.
 5. Only the worst case emission was recorded, if it complies with the limit, the other emissions deemed to comply with the limit.



RESTRICTED BANDEDGE (LOW CHANNEL, VERTICAL)

PEAK

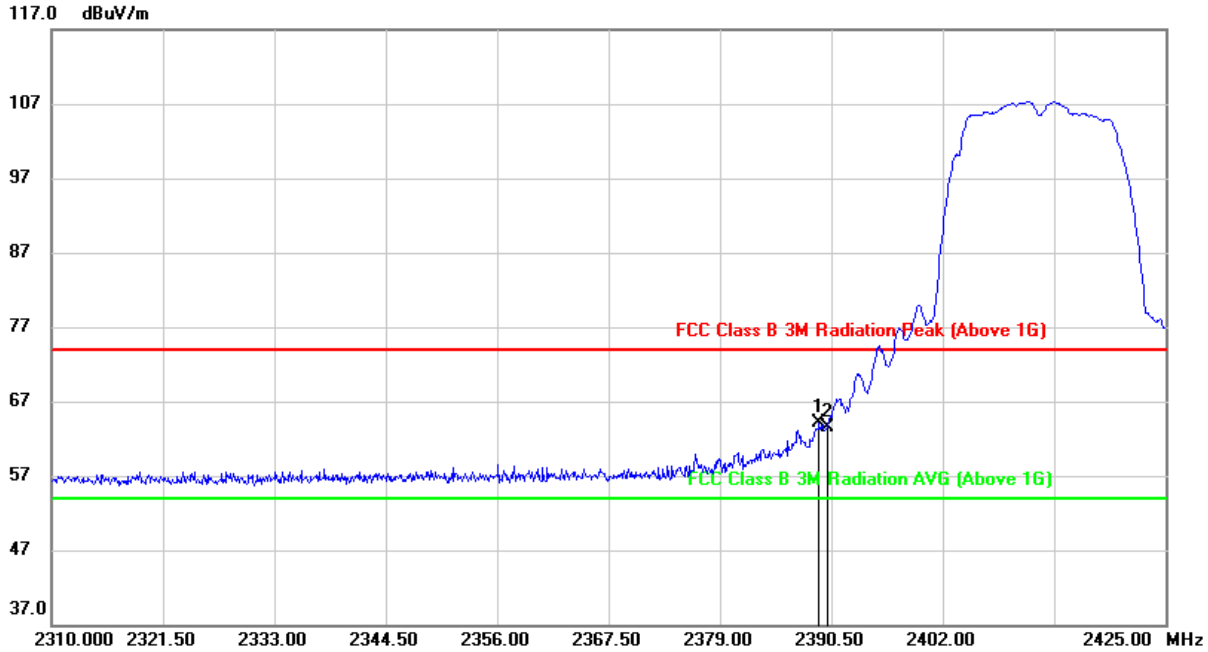

No.	Frequency (MHz)	Reading (dBuV)	Correct (dB/m)	Result (dBuV/m)	Limit (dBuV/m)	Margin (dB)	Remark
1	2389.235	31.08	32.94	64.02	74.00	-9.98	peak
2	2390.000	30.54	32.94	63.48	74.00	-10.52	peak

- Note:
1. Measurement = Reading Level + Correct Factor.
 2. If Peak Result complies with AV limit, AV Result is deemed to comply with AV limit.
 3. Peak: Peak detector.
 4. Only the worst case emission was recorded, if it complies with the limit, the other emissions deemed to comply with the limit.



AVG

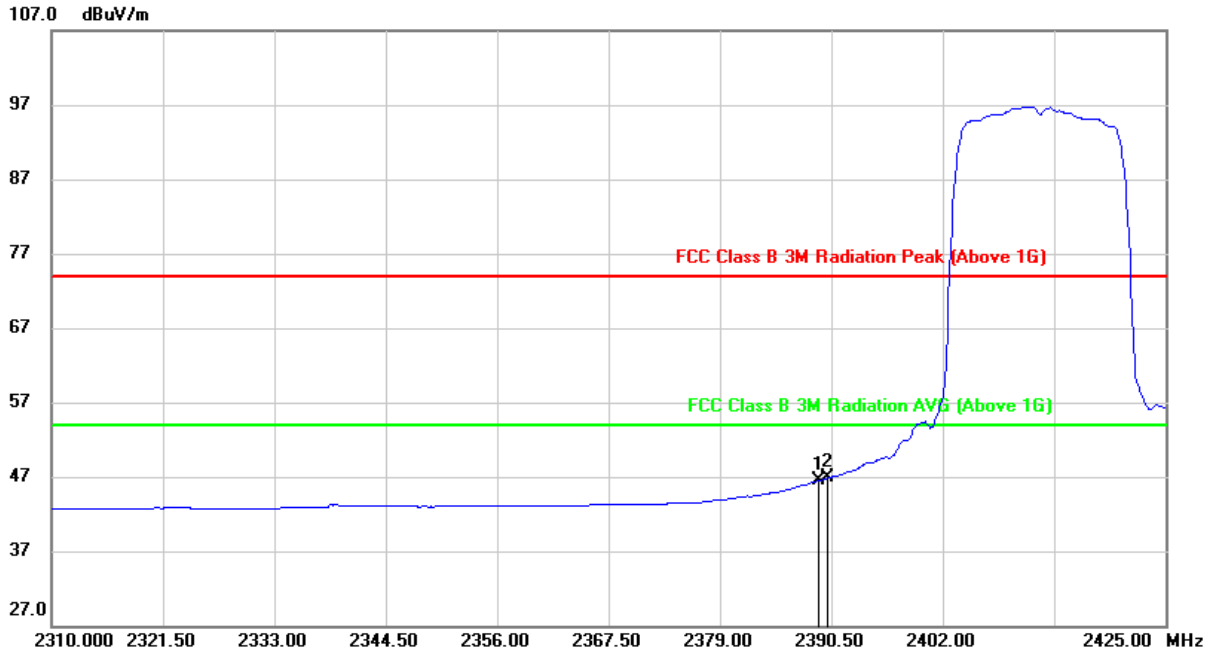

No.	Frequency (MHz)	Reading (dBuV)	Correct (dB/m)	Result (dBuV/m)	Limit (dBuV/m)	Margin (dB)	Remark
1	2389.235	13.56	32.94	46.50	54.00	-7.50	AVG
2	2390.000	13.88	32.94	46.82	54.00	-7.18	AVG

- Note:
1. Measurement = Reading Level + Correct Factor.
 2. If Peak Result complies with AV limit, AV Result is deemed to comply with AV limit.
 3. AVG: $VBW=1/Ton$ where: ton is transmit duration.
 4. For transmit duration, please refer to clause 8.1.
 5. Only the worst case emission was recorded, if it complies with the limit, the other emissions deemed to comply with the limit.



RESTRICTED BANDEDGE (HIGH CHANNEL, HORIZONTAL)

PEAK

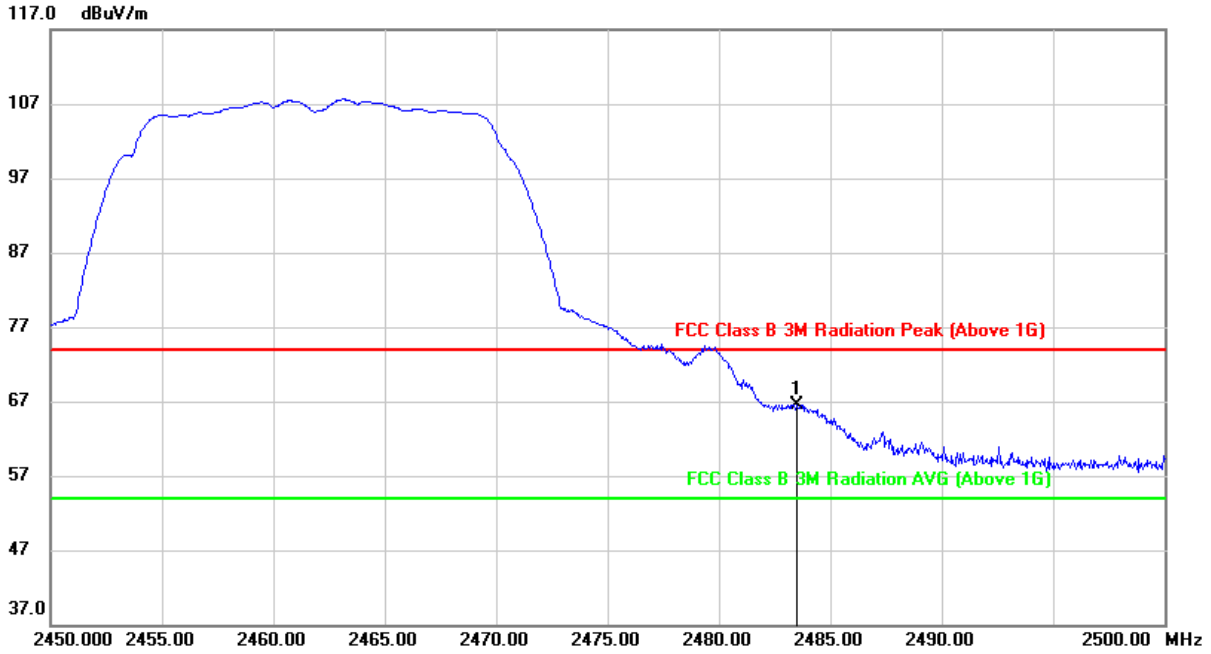

No.	Frequency (MHz)	Reading (dBuV)	Correct (dB/m)	Result (dBuV/m)	Limit (dBuV/m)	Margin (dB)	Remark
1	2483.500	32.88	33.58	66.46	74.00	-7.54	peak

- Note:
1. Measurement = Reading Level + Correct Factor.
 2. If Peak Result complies with AV limit, AV Result is deemed to comply with AV limit.
 3. Peak: Peak detector.
 4. Only the worst case emission was recorded, if it complies with the limit, the other emissions deemed to comply with the limit.



AVG

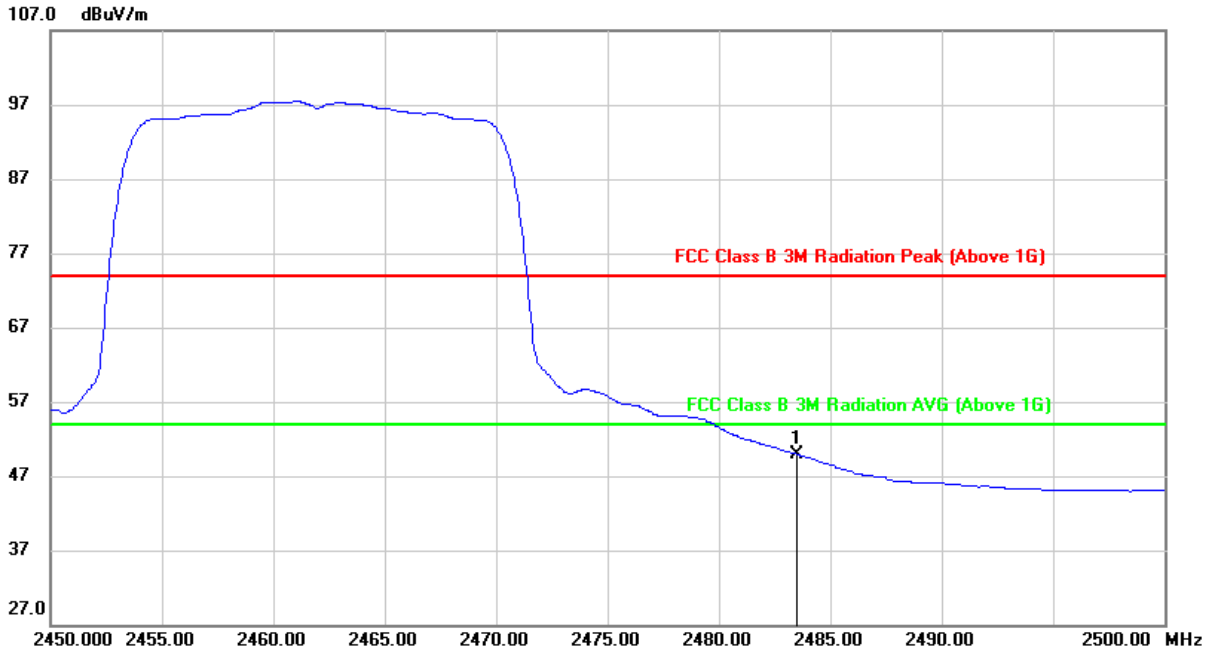

No.	Frequency (MHz)	Reading (dBuV)	Correct (dB/m)	Result (dBuV/m)	Limit (dBuV/m)	Margin (dB)	Remark
1	2483.500	16.36	33.58	49.94	54.00	-4.06	AVG

- Note:
1. Measurement = Reading Level + Correct Factor.
 2. If Peak Result complies with AV limit, AV Result is deemed to comply with AV limit.
 3. AVG: $VBW=1/T_{on}$ where: t_{on} is transmit duration.
 4. For transmit duration, please refer to clause 8.1.
 5. Only the worst case emission was recorded, if it complies with the limit, the other emissions deemed to comply with the limit.



RESTRICTED BANDEGE (HIGH CHANNEL, VERTICAL)

PEAK

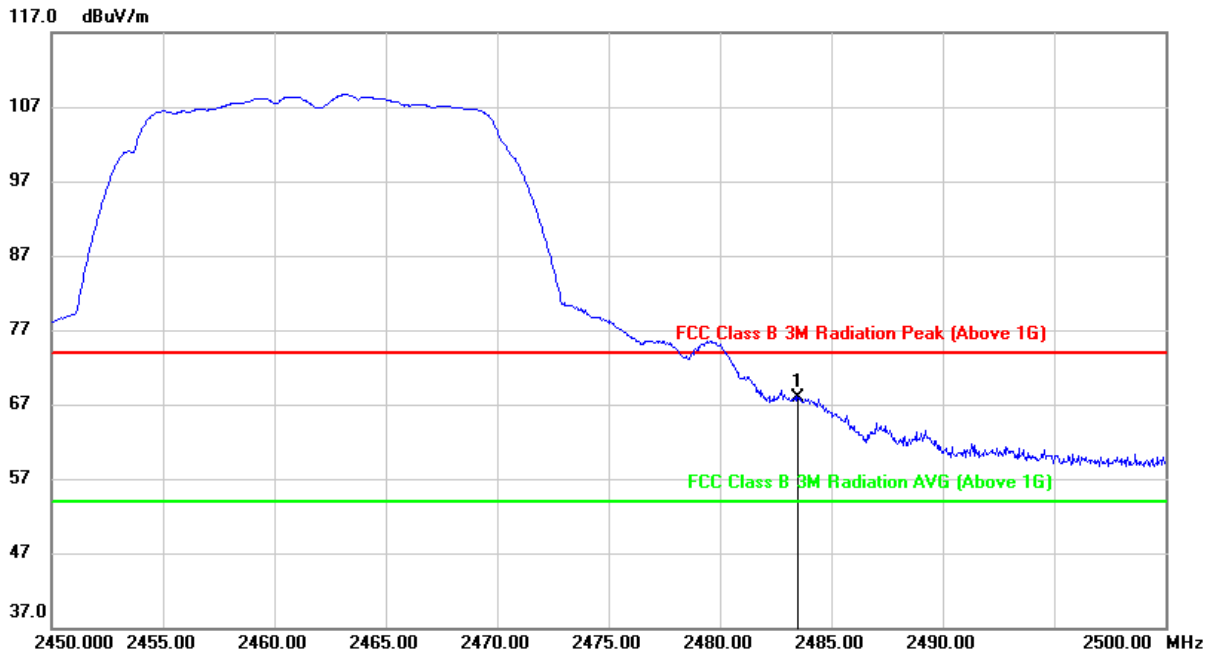

No.	Frequency (MHz)	Reading (dBuV)	Correct (dB/m)	Result (dBuV/m)	Limit (dBuV/m)	Margin (dB)	Remark
1	2483.500	34.24	33.58	67.82	74.00	-6.18	peak

- Note:
1. Measurement = Reading Level + Correct Factor.
 2. If Peak Result complies with AV limit, AV Result is deemed to comply with AV limit.
 3. Peak: Peak detector.
 4. Only the worst case emission was recorded, if it complies with the limit, the other emissions deemed to comply with the limit.



AVG

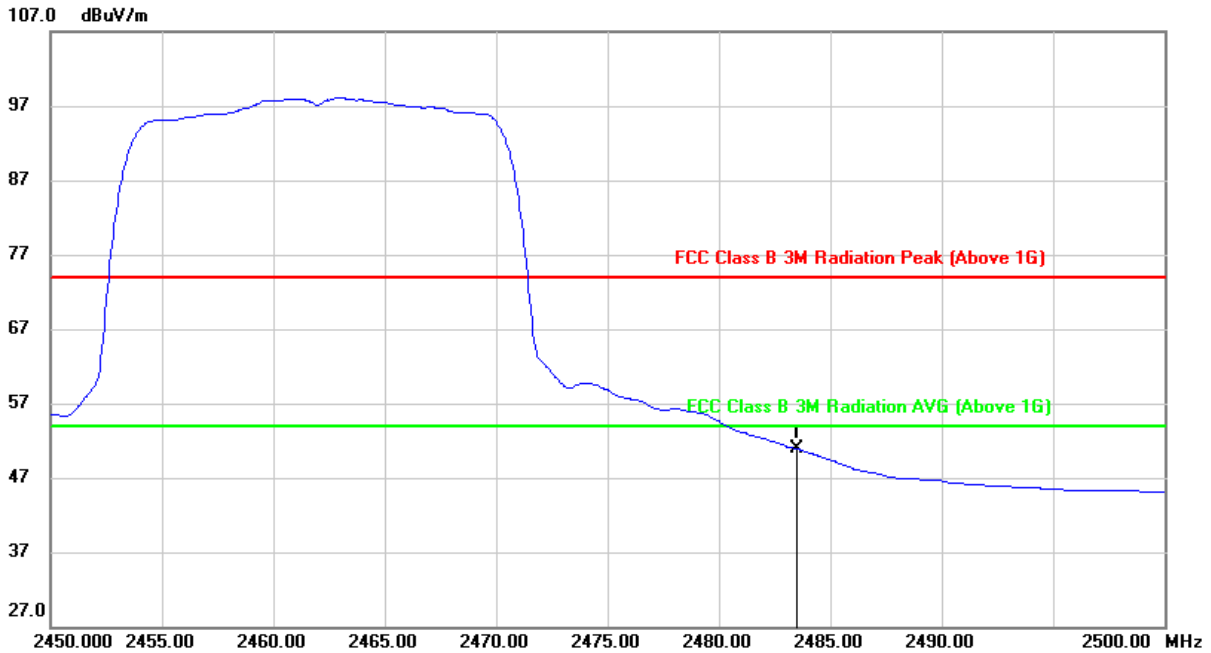

No.	Frequency (MHz)	Reading (dBuV)	Correct (dB/m)	Result (dBuV/m)	Limit (dBuV/m)	Margin (dB)	Remark
1	2483.500	17.28	33.58	50.86	54.00	-3.14	AVG

- Note:
1. Measurement = Reading Level + Correct Factor.
 2. If Peak Result complies with AV limit, AV Result is deemed to comply with AV limit.
 3. AVG: $VBW=1/T_{on}$ where: t_{on} is transmit duration.
 4. For transmit duration, please refer to clause 8.1.
 5. Only the worst case emission was recorded, if it complies with the limit, the other emissions deemed to comply with the limit.

Note: All antennas have been tested, only the worst data record in the report.



9.1.3. 802.11n HT20 MIMO MODE

RESTRICTED BANDEDGE (LOW CHANNEL, HORIZONTAL)

PEAK

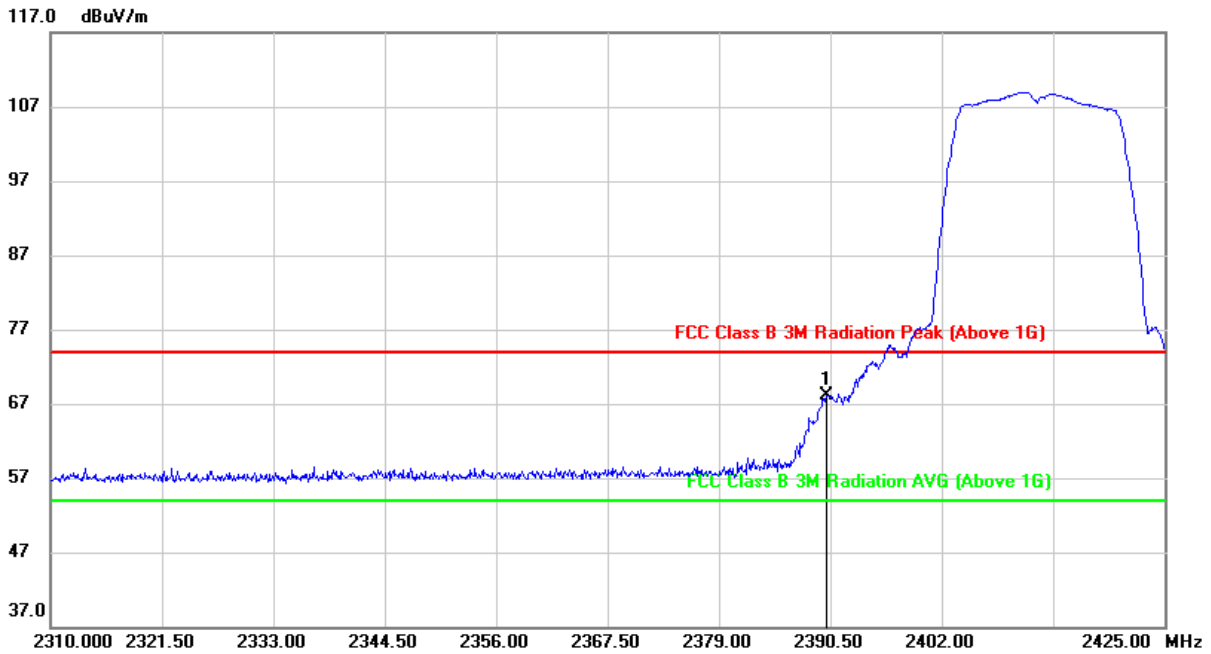

No.	Frequency (MHz)	Reading (dBuV)	Correct (dB/m)	Result (dBuV/m)	Limit (dBuV/m)	Margin (dB)	Remark
1	2390.000	35.11	32.94	68.05	74.00	-5.95	peak

- Note:
1. Measurement = Reading Level + Correct Factor.
 2. If Peak Result complies with AV limit, AV Result is deemed to comply with AV limit.
 3. Peak: Peak detector.
 4. Only the worst case emission was recorded, if it complies with the limit, the other emissions deemed to comply with the limit.



AVG

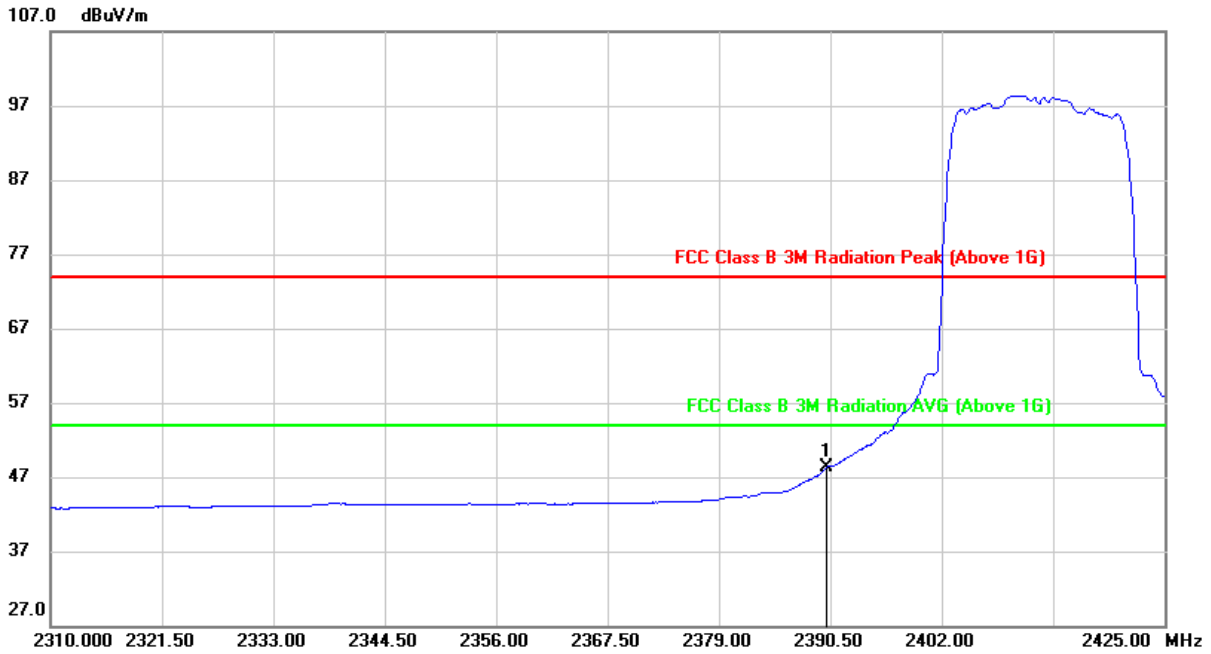

No.	Frequency (MHz)	Reading (dBuV)	Correct (dB/m)	Result (dBuV/m)	Limit (dBuV/m)	Margin (dB)	Remark
1	2390.000	15.27	32.94	48.21	54.00	-5.79	AVG

- Note:
1. Measurement = Reading Level + Correct Factor.
 2. If Peak Result complies with AV limit, AV Result is deemed to comply with AV limit.
 3. AVG: $VBW=1/Ton$ where: ton is transmit duration.
 4. For transmit duration, please refer to clause 8.1.
 5. Only the worst case emission was recorded, if it complies with the limit, the other emissions deemed to comply with the limit.



RESTRICTED BANDEDGE (LOW CHANNEL, VERTICAL)

PEAK

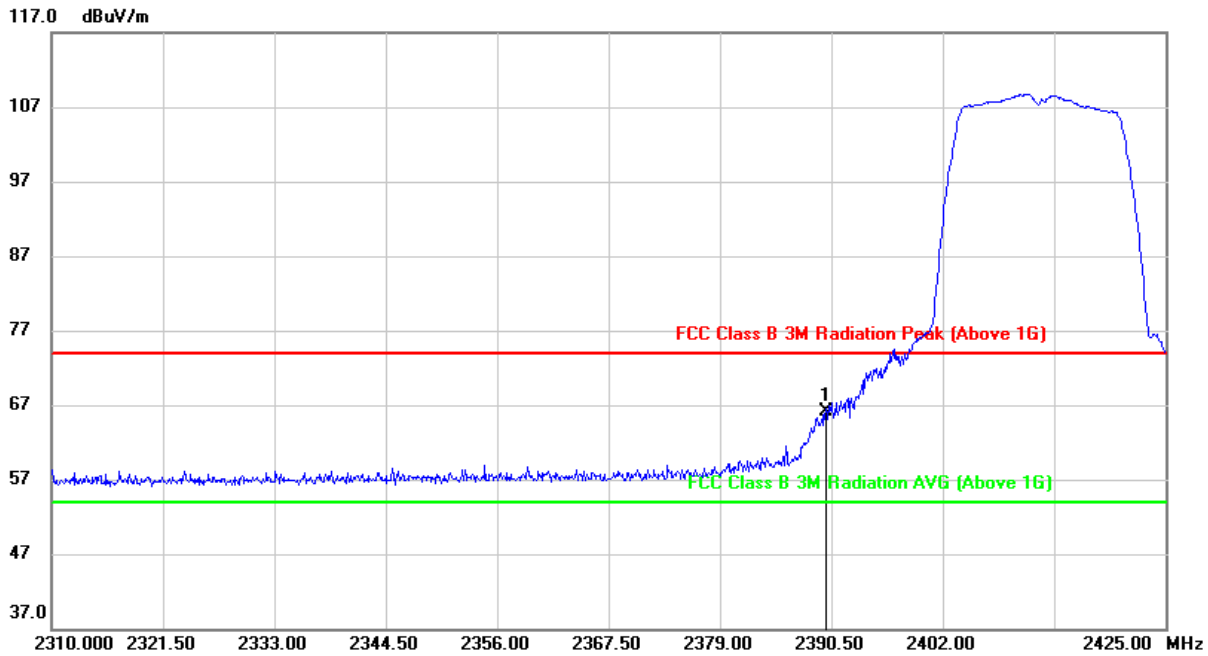

No.	Frequency (MHz)	Reading (dBuV)	Correct (dB/m)	Result (dBuV/m)	Limit (dBuV/m)	Margin (dB)	Remark
1	2390.000	33.08	32.94	66.02	74.00	-7.98	peak

- Note:
1. Measurement = Reading Level + Correct Factor.
 2. If Peak Result complies with AV limit, AV Result is deemed to comply with AV limit.
 3. Peak: Peak detector.
 4. Only the worst case emission was recorded, if it complies with the limit, the other emissions deemed to comply with the limit.



AVG

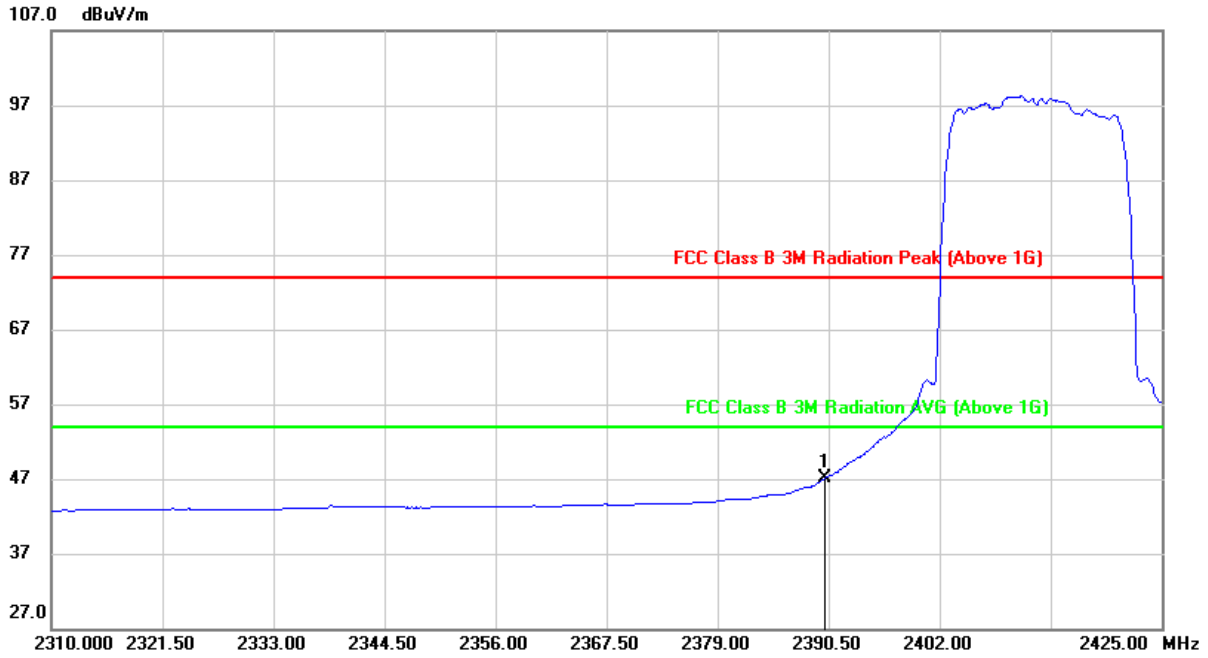

No.	Frequency (MHz)	Reading (dBuV)	Correct (dB/m)	Result (dBuV/m)	Limit (dBuV/m)	Margin (dB)	Remark
1	2390.000	14.13	32.94	47.07	54.00	-6.93	AVG

- Note:
1. Measurement = Reading Level + Correct Factor.
 2. If Peak Result complies with AV limit, AV Result is deemed to comply with AV limit.
 3. AVG: $VBW=1/T_{on}$ where: t_{on} is transmit duration.
 4. For transmit duration, please refer to clause 8.1.
 5. Only the worst case emission was recorded, if it complies with the limit, the other emissions deemed to comply with the limit.



RESTRICTED BANDEDGE (HIGH CHANNEL, HORIZONTAL)

PEAK

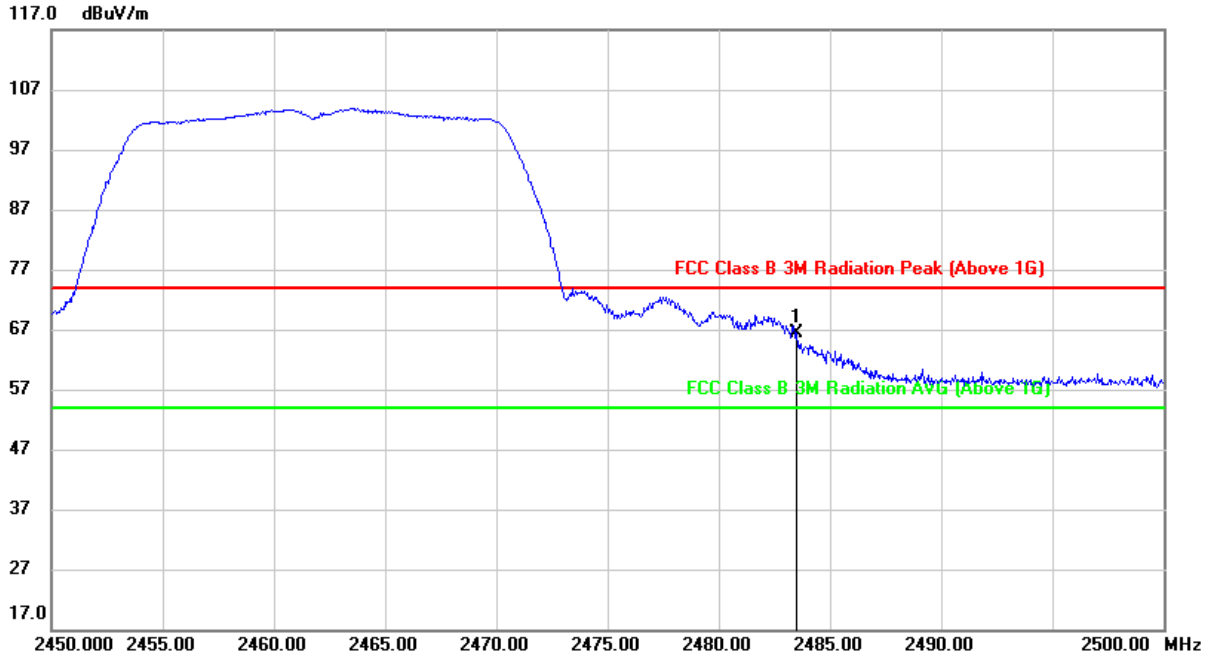

No.	Frequency (MHz)	Reading (dBuV)	Correct (dB/m)	Result (dBuV/m)	Limit (dBuV/m)	Margin (dB)	Remark
1	2483.500	32.78	33.58	66.36	74.00	-7.64	peak

- Note: 1. Measurement = Reading Level + Correct Factor.
 2. If Peak Result complies with AV limit, AV Result is deemed to comply with AV limit.
 3. Peak: Peak detector.
 4. Only the worst case emission was recorded, if it complies with the limit, the other emissions deemed to comply with the limit.



AVG

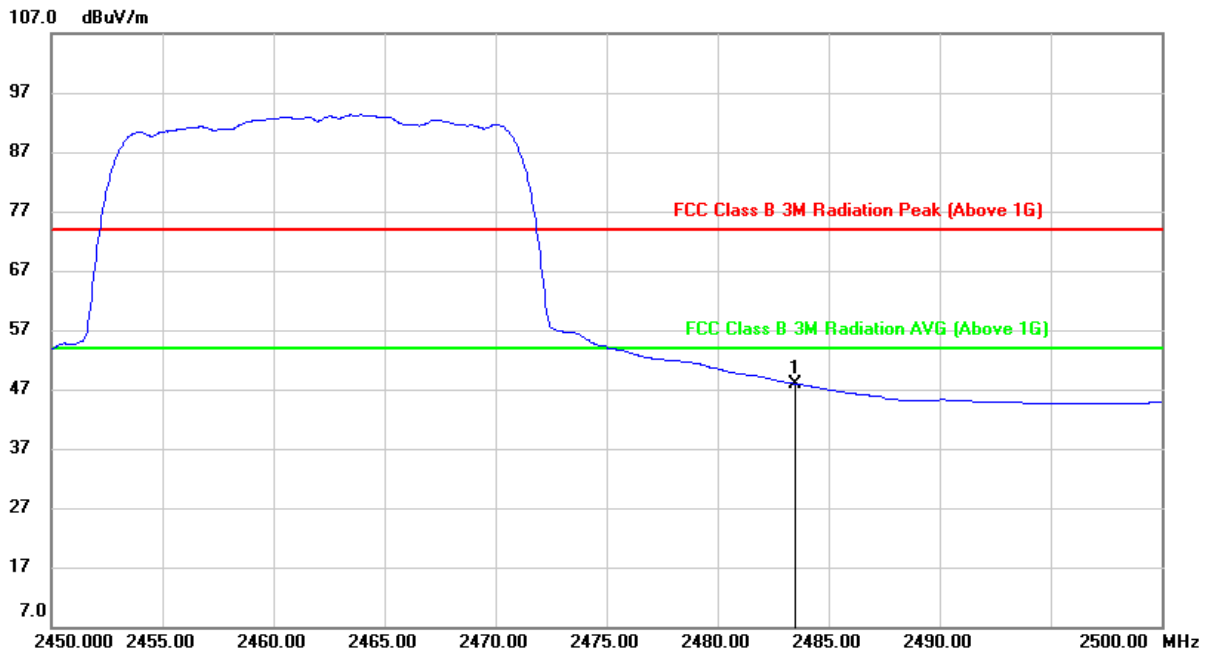

No.	Frequency (MHz)	Reading (dBuV)	Correct (dB/m)	Result (dBuV/m)	Limit (dBuV/m)	Margin (dB)	Remark
1	2483.500	14.28	33.58	47.86	54.00	-6.14	AVG

- Note:
1. Measurement = Reading Level + Correct Factor.
 2. If Peak Result complies with AV limit, AV Result is deemed to comply with AV limit.
 3. AVG: $VBW=1/Ton$ where: ton is transmit duration.
 4. For transmit duration, please refer to clause 8.1.
 5. Only the worst case emission was recorded, if it complies with the limit, the other emissions deemed to comply with the limit.



RESTRICTED BANDEDGE (HIGH CHANNEL, VERTICAL)

PEAK

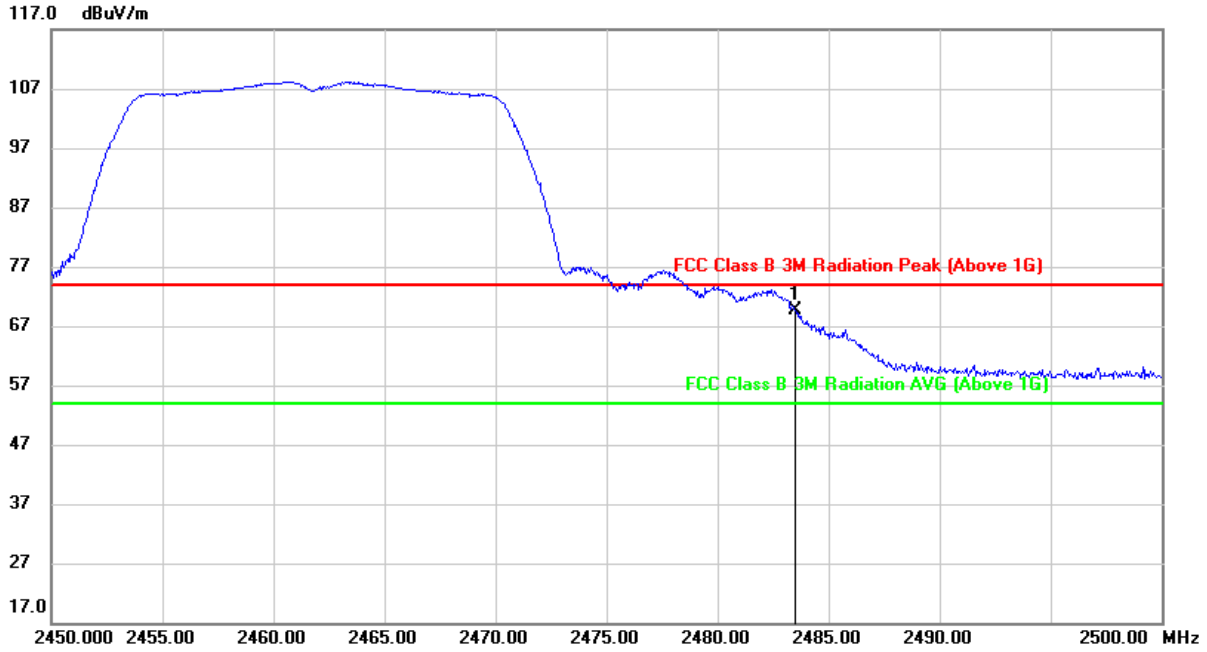

No.	Frequency (MHz)	Reading (dBuV)	Correct (dB/m)	Result (dBuV/m)	Limit (dBuV/m)	Margin (dB)	Remark
1	2483.500	36.00	33.58	69.58	74.00	-4.42	peak

- Note:
1. Measurement = Reading Level + Correct Factor.
 2. If Peak Result complies with AV limit, AV Result is deemed to comply with AV limit.
 3. Peak: Peak detector.
 4. Only the worst case emission was recorded, if it complies with the limit, the other emissions deemed to comply with the limit.



AVG

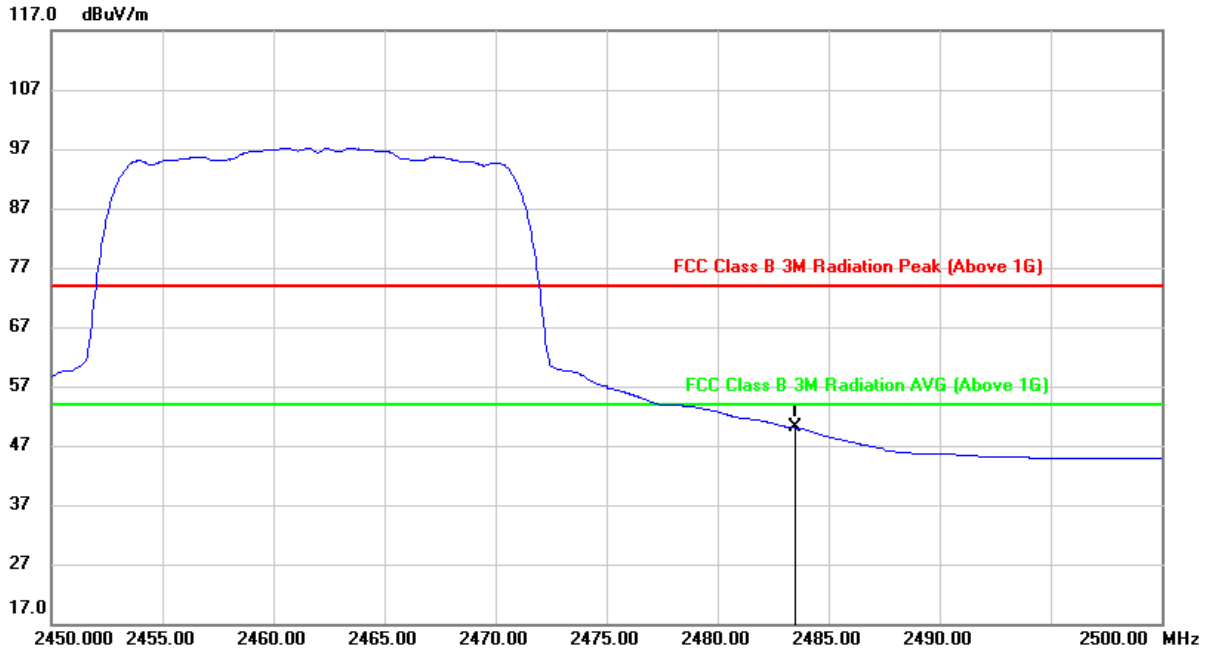

No.	Frequency (MHz)	Reading (dBuV)	Correct (dB/m)	Result (dBuV/m)	Limit (dBuV/m)	Margin (dB)	Remark
1	2483.500	16.44	33.58	50.02	54.00	-3.98	AVG

- Note:
1. Measurement = Reading Level + Correct Factor.
 2. If Peak Result complies with AV limit, AV Result is deemed to comply with AV limit.
 3. AVG: $VBW=1/T_{on}$ where: t_{on} is transmit duration.
 4. For transmit duration, please refer to clause 8.1.
 5. Only the worst case emission was recorded, if it complies with the limit, the other emissions deemed to comply with the limit.

Note: All constructions have been tested, only the worst data record in the report



9.1.4. 802.11n HT40 MIMO MODE

RESTRICTED BANDEDGE (LOW CHANNEL, HORIZONTAL)

PEAK

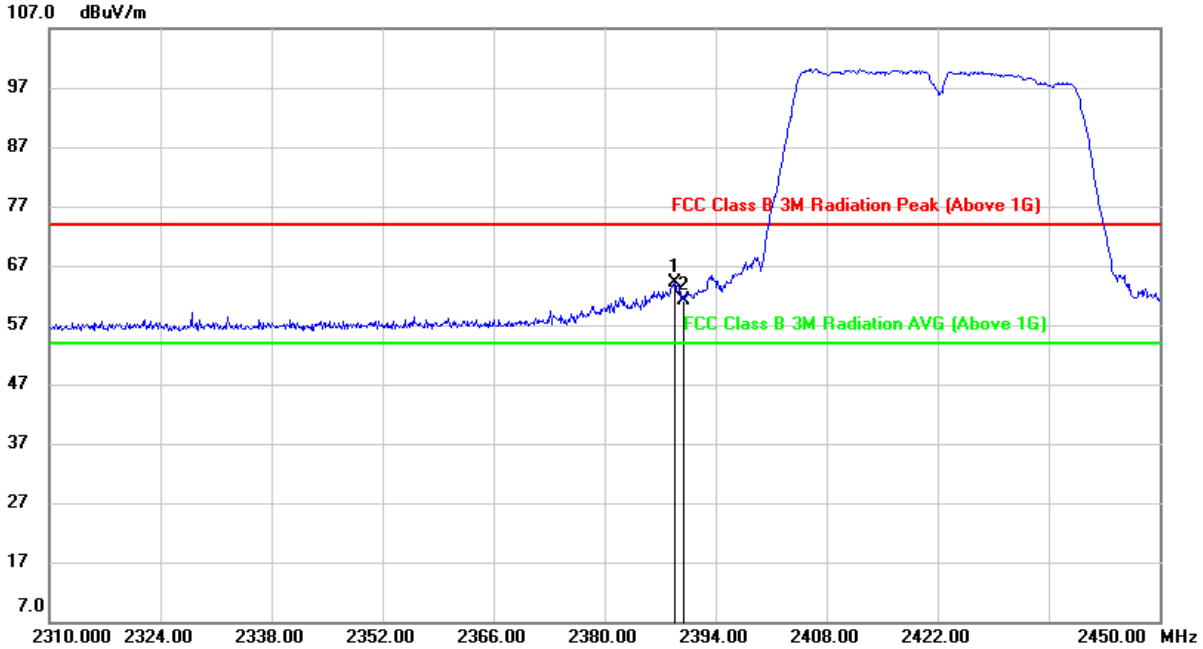

No.	Frequency (MHz)	Reading (dBuV)	Correct (dB/m)	Result (dBuV/m)	Limit (dBuV/m)	Margin (dB)	Remark
1	2388.820	31.19	32.94	64.13	74.00	-9.87	peak
2	2390.000	28.29	32.94	61.23	74.00	-12.77	peak

- Note:
1. Measurement = Reading Level + Correct Factor.
 2. If Peak Result complies with AV limit, AV Result is deemed to comply with AV limit.
 3. Peak: Peak detector.
 4. Only the worst case emission was recorded, if it complies with the limit, the other emissions deemed to comply with the limit.



AVG

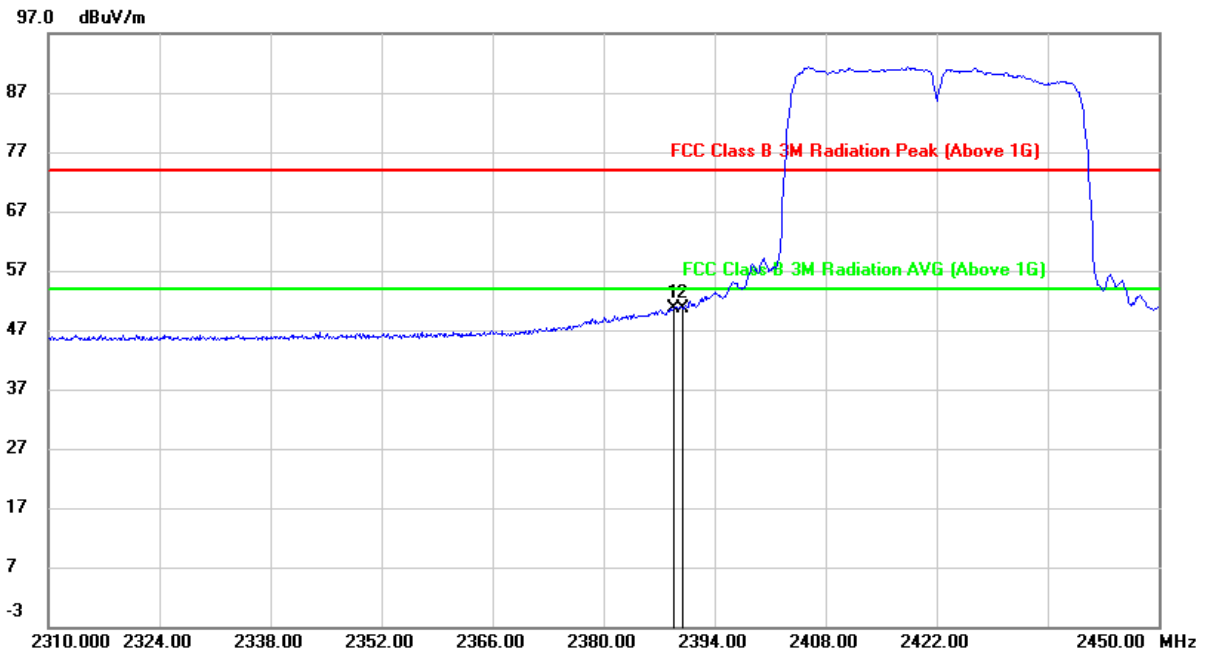

No.	Frequency (MHz)	Reading (dBuV)	Correct (dB/m)	Result (dBuV/m)	Limit (dBuV/m)	Margin (dB)	Remark
1	2388.820	17.78	32.94	50.72	54.00	-3.28	AVG
2	2390.000	17.76	32.94	50.70	54.00	-3.30	AVG

- Note:
1. Measurement = Reading Level + Correct Factor.
 2. If Peak Result complies with AV limit, AV Result is deemed to comply with AV limit.
 3. AVG: $VBW=1/Ton$ where: ton is transmit duration.
 4. For transmit duration, please refer to clause 8.1.
 5. Only the worst case emission was recorded, if it complies with the limit, the other emissions deemed to comply with the limit.



RESTRICTED BANDEGE (LOW CHANNEL, VERTICAL)

PEAK

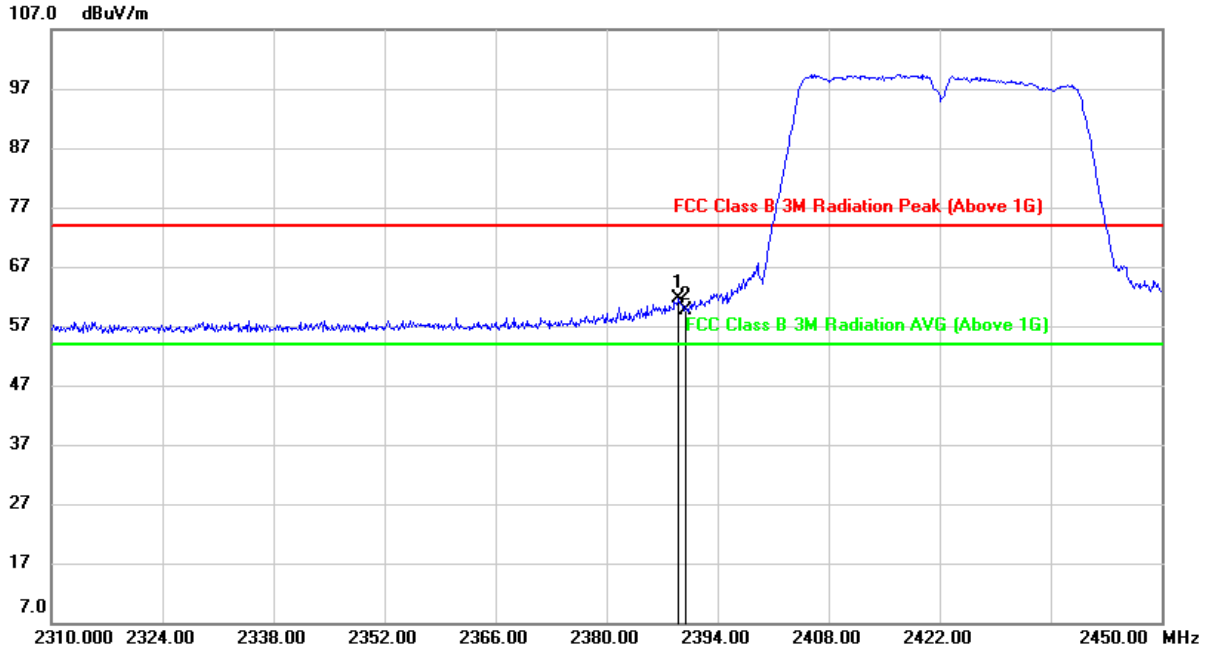

No.	Frequency (MHz)	Reading (dBuV)	Correct (dB/m)	Result (dBuV/m)	Limit (dBuV/m)	Margin (dB)	Remark
1	2389.100	28.75	32.94	61.69	74.00	-12.31	peak
2	2390.000	26.79	32.94	59.73	74.00	-14.27	peak

Note: 1. Measurement = Reading Level + Correct Factor.
 2. If Peak Result complies with AV limit, AV Result is deemed to comply with AV limit.
 3. Peak: Peak detector.
 4. Only the worst case emission was recorded, if it complies with the limit, the other emissions deemed to comply with the limit.



AVG

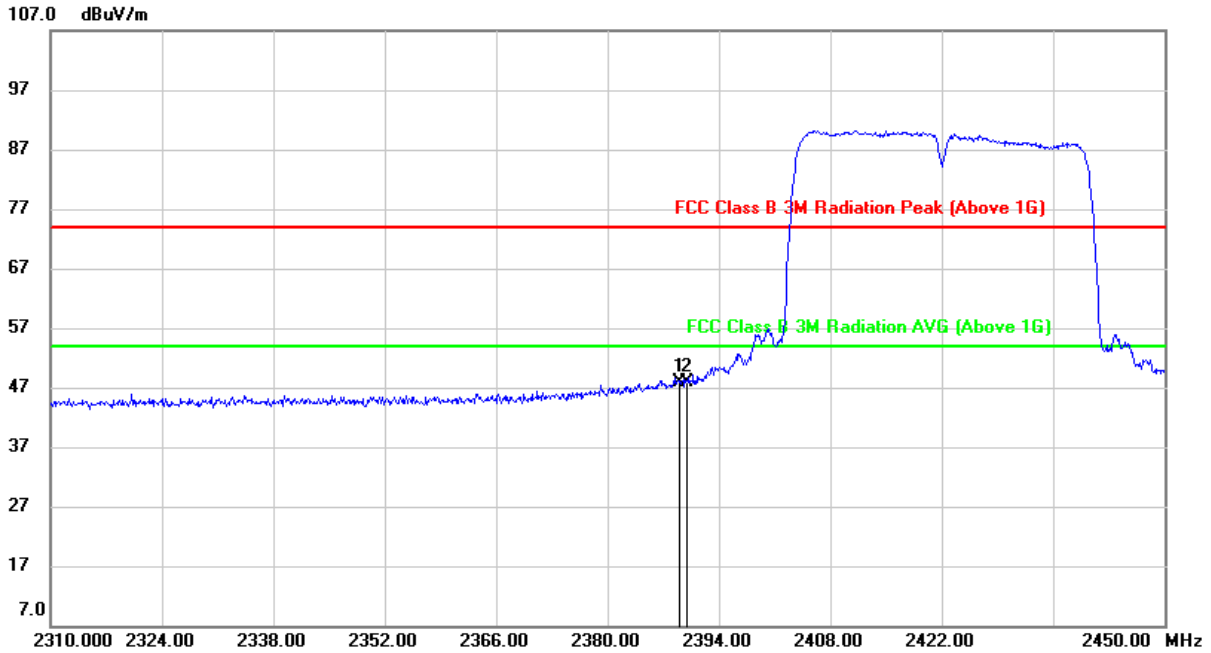

No.	Frequency (MHz)	Reading (dBuV)	Correct (dB/m)	Result (dBuV/m)	Limit (dBuV/m)	Margin (dB)	Remark
1	2389.100	14.92	32.94	47.86	54.00	-6.14	AVG
2	2390.000	14.85	32.94	47.79	54.00	-6.21	AVG

- Note:
1. Measurement = Reading Level + Correct Factor.
 2. If Peak Result complies with AV limit, AV Result is deemed to comply with AV limit.
 3. AVG: $VBW=1/Ton$ where: ton is transmit duration.
 4. For transmit duration, please refer to clause 8.1.
 5. Only the worst case emission was recorded, if it complies with the limit, the other emissions deemed to comply with the limit.



RESTRICTED BANDEDGE (HIGH CHANNEL, HORIZONTAL)

PEAK

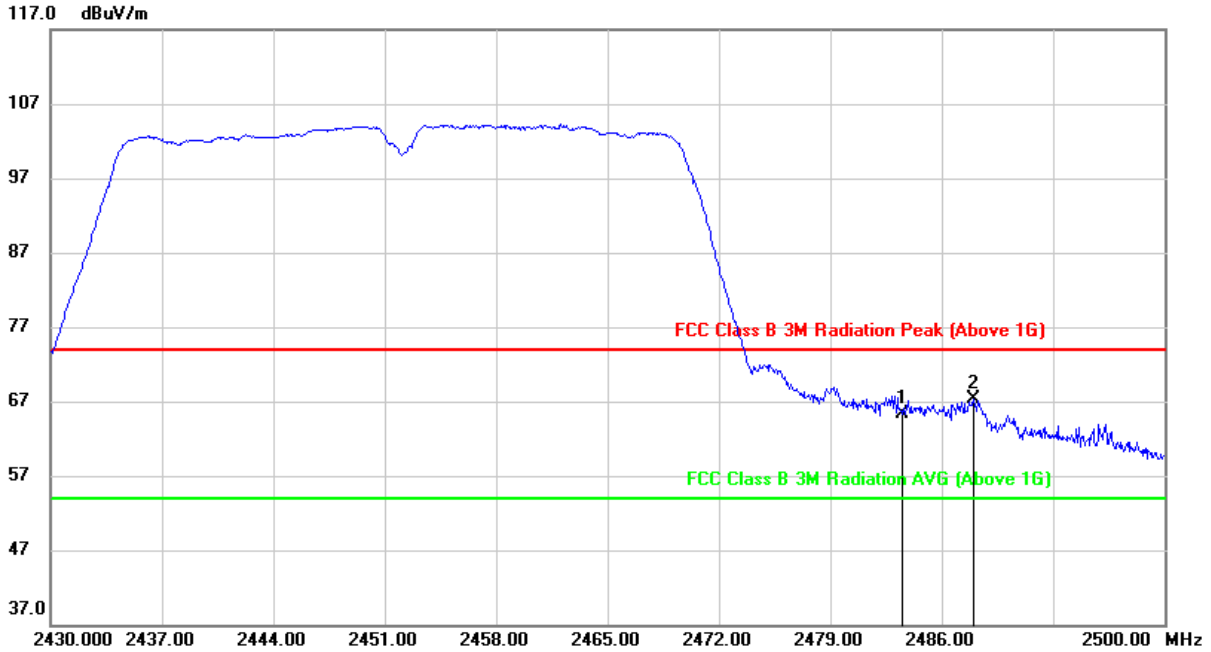

No.	Frequency (MHz)	Reading (dBuV)	Correct (dB/m)	Result (dBuV/m)	Limit (dBuV/m)	Margin (dB)	Remark
1	2483.500	31.68	33.58	65.26	74.00	-8.74	peak
2	2487.960	33.66	33.61	67.27	74.00	-6.73	peak

Note: 1. Measurement = Reading Level + Correct Factor.
 2. If Peak Result complies with AV limit, AV Result is deemed to comply with AV limit.
 3. Peak: Peak detector.
 4. Only the worst case emission was recorded, if it complies with the limit, the other emissions deemed to comply with the limit.



AVG

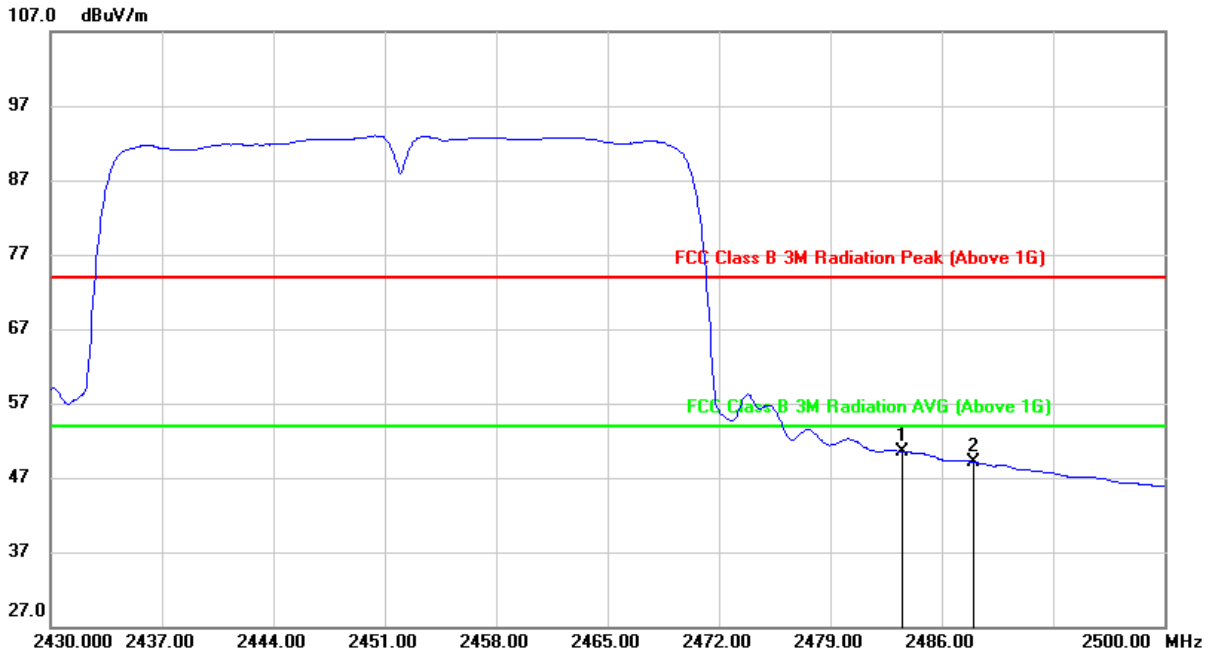

No.	Frequency (MHz)	Reading (dBuV)	Correct (dB/m)	Result (dBuV/m)	Limit (dBuV/m)	Margin (dB)	Remark
1	2483.500	16.95	33.58	50.53	54.00	-3.47	AVG
2	2487.960	15.47	33.61	49.08	54.00	-4.92	AVG

- Note:
1. Measurement = Reading Level + Correct Factor.
 2. If Peak Result complies with AV limit, AV Result is deemed to comply with AV limit.
 3. AVG: $VBW=1/T_{on}$ where: t_{on} is transmit duration.
 4. For transmit duration, please refer to clause 8.1.
 5. Only the worst case emission was recorded, if it complies with the limit, the other emissions deemed to comply with the limit.



RESTRICTED BANDEGE (HIGH CHANNEL, VERTICAL)

PEAK

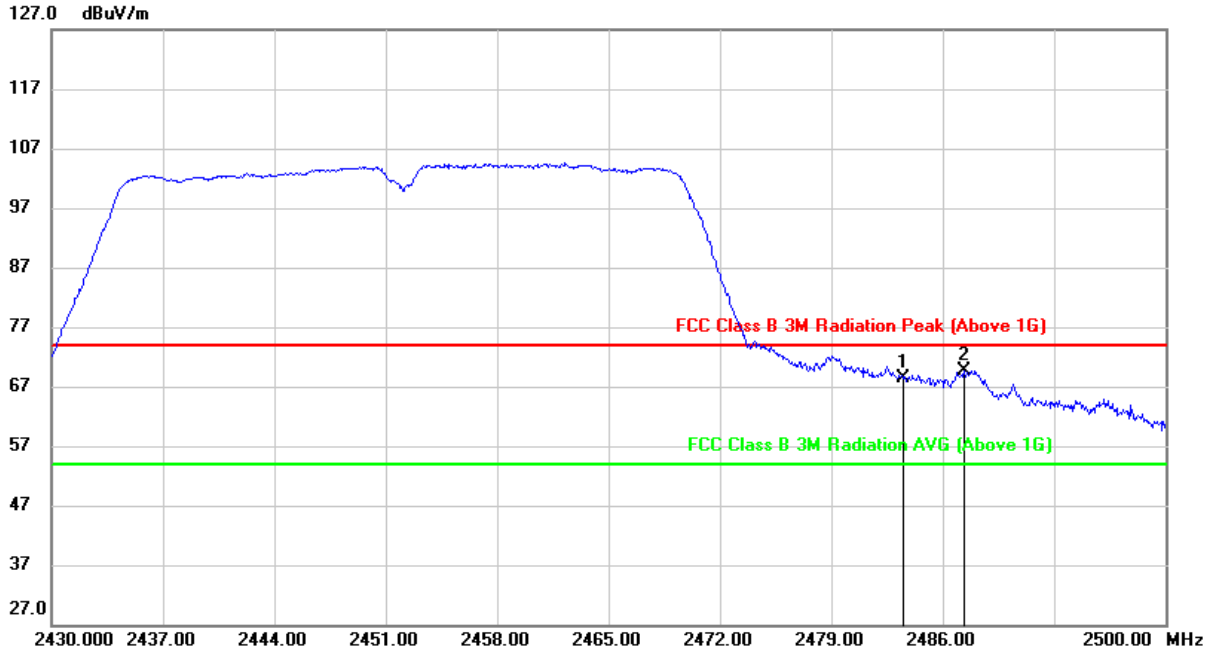

No.	Frequency (MHz)	Reading (dBuV)	Correct (dB/m)	Result (dBuV/m)	Limit (dBuV/m)	Margin (dB)	Remark
1	2483.500	34.89	33.58	68.47	74.00	-5.53	peak
2	2487.330	36.06	33.61	69.67	74.00	-4.33	peak

Note: 1. Measurement = Reading Level + Correct Factor.
 2. If Peak Result complies with AV limit, AV Result is deemed to comply with AV limit.
 3. Peak: Peak detector.
 4. Only the worst case emission was recorded, if it complies with the limit, the other emissions deemed to comply with the limit.



AVG

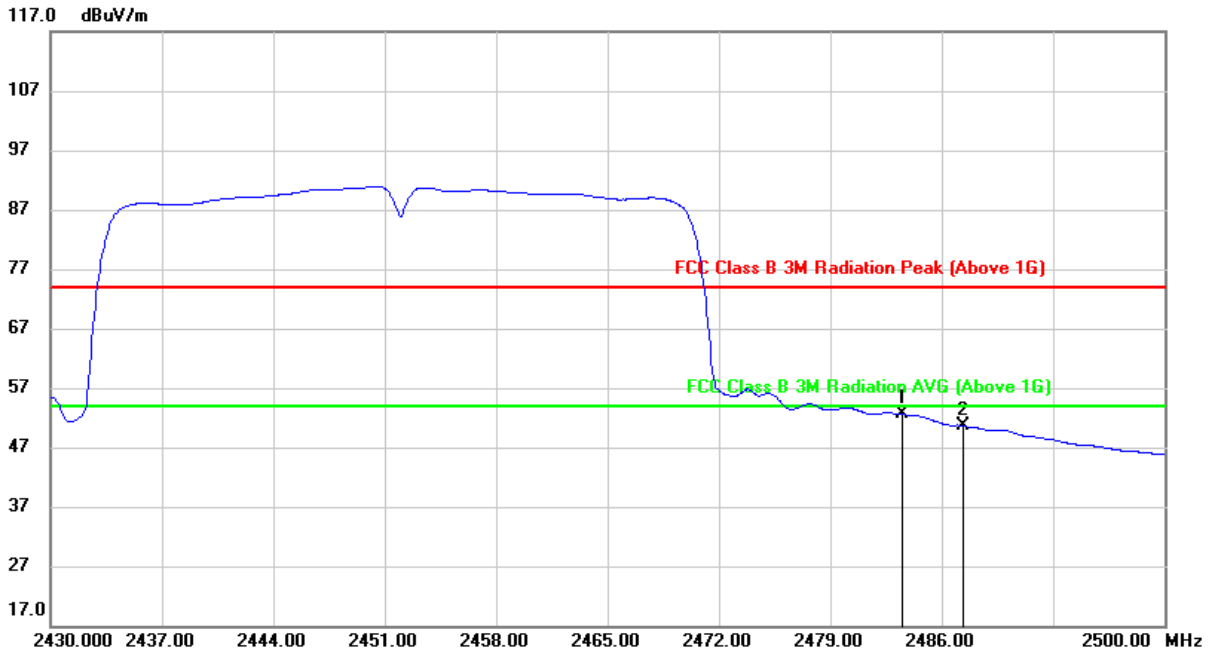

No.	Frequency (MHz)	Reading (dBuV)	Correct (dB/m)	Result (dBuV/m)	Limit (dBuV/m)	Margin (dB)	Remark
1	2483.500	18.95	33.58	52.53	54.00	-1.47	AVG
2	2487.330	17.10	33.61	50.71	54.00	-3.29	AVG

- Note:
1. Measurement = Reading Level + Correct Factor.
 2. If Peak Result complies with AV limit, AV Result is deemed to comply with AV limit.
 3. AVG: $VBW=1/T_{on}$ where: t_{on} is transmit duration.
 4. For transmit duration, please refer to clause 8.1.
 5. Only the worst case emission was recorded, if it complies with the limit, the other emissions deemed to comply with the limit.



9.2. SPURIOUS EMISSIONS (3~18GHz)

9.2.1. 802.11b SISO MODE

ANTENNA1

HARMONICS AND SPURIOUS EMISSIONS (LOW CHANNEL, HORIZONTAL)

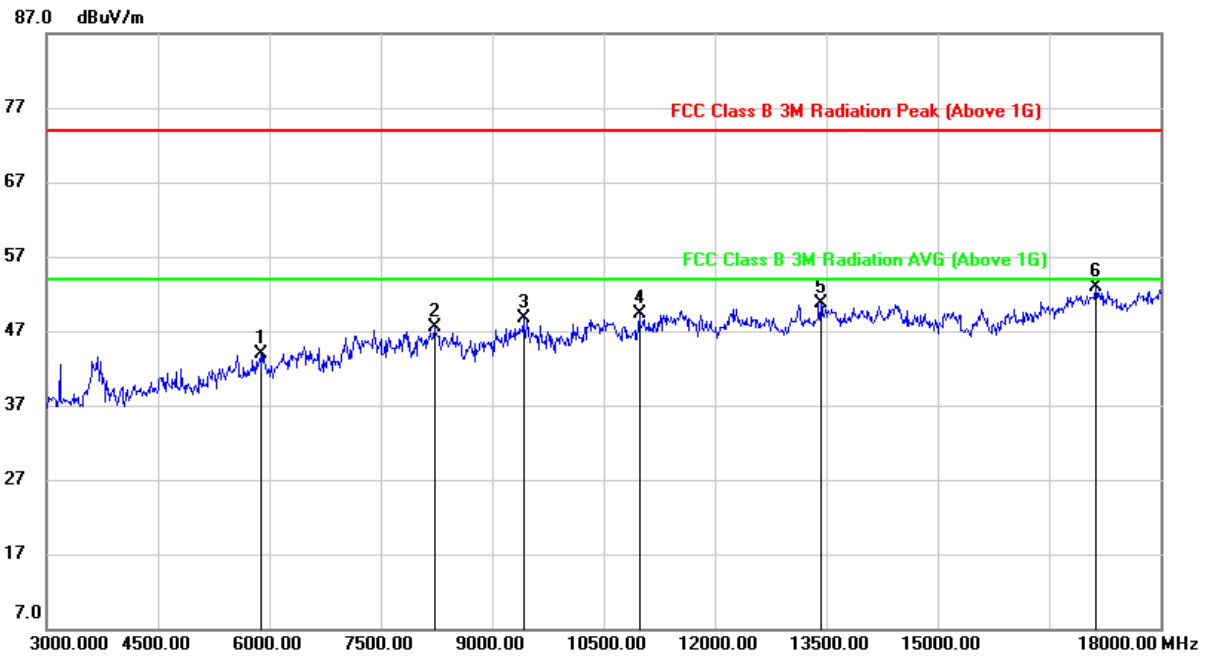

No.	Frequency (MHz)	Reading (dBuV)	Correct (dB/m)	Result (dBuV/m)	Limit (dBuV/m)	Margin (dB)	Remark
1	5880.000	39.05	4.90	43.95	74.00	-30.05	peak
2	8220.000	38.16	9.40	47.56	74.00	-26.44	peak
3	9420.000	38.30	10.34	48.64	74.00	-25.36	peak
4	10980.000	36.34	13.06	49.40	74.00	-24.60	peak
5	13425.000	34.79	15.83	50.62	74.00	-23.38	peak
6	17130.000	32.05	20.84	52.89	74.00	-21.11	peak

- Note:
1. Measurement = Reading Level + Correct Factor.
 2. If Peak Result complies with AV limit, AV Result is deemed to comply with AV limit.
 3. Peak: Peak detector.
 4. The High Pass filter loss factor already add into the correct factor.
 5. Proper operation of the transmitter prior to adding the filter to the measurement chain.



HARMONICS AND SPURIOUS EMISSIONS (LOW CHANNEL, VERTICAL)

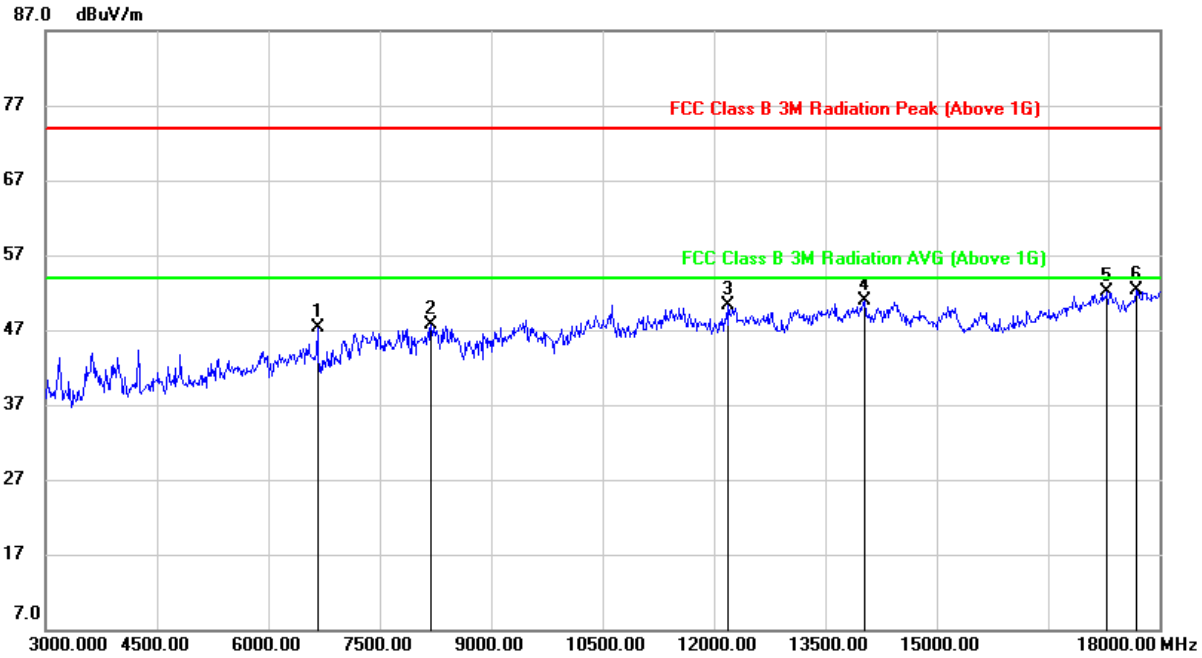

No.	Frequency (MHz)	Reading (dBuV)	Correct (dB/m)	Result (dBuV/m)	Limit (dBuV/m)	Margin (dB)	Remark
1	6660.000	41.31	6.00	47.31	74.00	-26.69	peak
2	8190.000	38.06	9.56	47.62	74.00	-26.38	peak
3	12195.000	36.11	14.24	50.35	74.00	-23.65	peak
4	14025.000	34.61	16.31	50.92	74.00	-23.08	peak
5	17295.000	30.31	21.86	52.17	74.00	-21.83	peak
6	17685.000	30.19	22.11	52.30	74.00	-21.70	peak

- Note: 1. Measurement = Reading Level + Correct Factor.
 2. If Peak Result complies with AV limit, AV Result is deemed to comply with AV limit.
 3. Peak: Peak detector.
 4. The High Pass filter loss factor already add into the correct factor.
 5. Proper operation of the transmitter prior to adding the filter to the measurement chain.



HARMONICS AND SPURIOUS EMISSIONS (MID CHANNEL, HORIZONTAL)

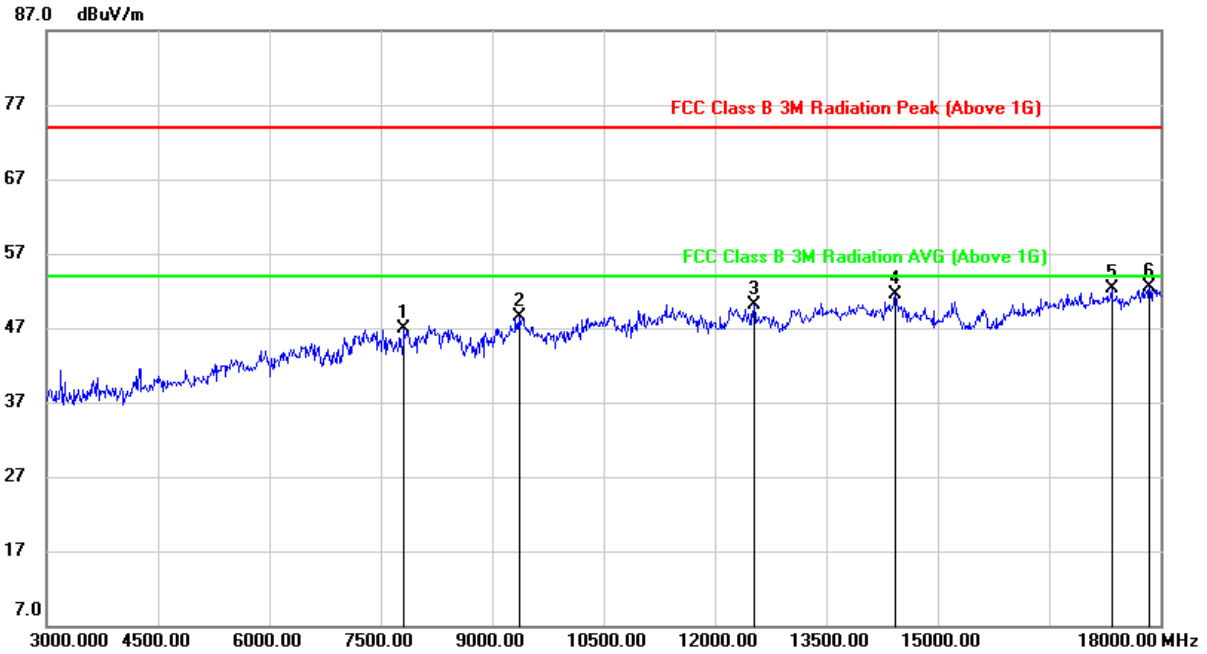

No.	Frequency (MHz)	Reading (dBuV)	Correct (dB/m)	Result (dBuV/m)	Limit (dBuV/m)	Margin (dB)	Remark
1	7815.000	38.11	8.81	46.92	74.00	-27.08	peak
2	9360.000	38.40	10.05	48.45	74.00	-25.55	peak
3	12525.000	35.45	14.65	50.10	74.00	-23.90	peak
4	14430.000	35.12	16.39	51.51	74.00	-22.49	peak
5	17340.000	30.51	21.73	52.24	74.00	-21.76	peak
6	17850.000	29.25	23.19	52.44	74.00	-21.56	peak

- Note:
1. Measurement = Reading Level + Correct Factor.
 2. If Peak Result complies with AV limit, AV Result is deemed to comply with AV limit.
 3. Peak: Peak detector.
 4. The High Pass filter loss factor already add into the correct factor.
 5. Proper operation of the transmitter prior to adding the filter to the measurement chain.



HARMONICS AND SPURIOUS EMISSIONS (MID CHANNEL, VERTICAL)

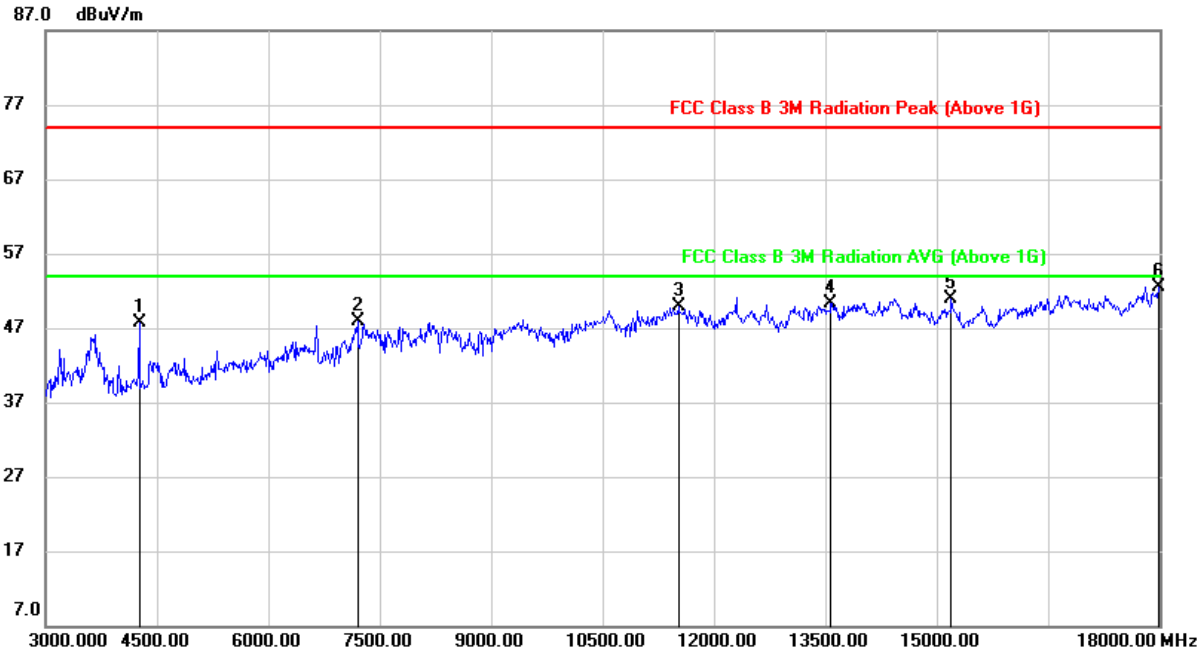

No.	Frequency (MHz)	Reading (dBuV)	Correct (dB/m)	Result (dBuV/m)	Limit (dBuV/m)	Margin (dB)	Remark
1	4260.000	49.84	-2.09	47.75	74.00	-26.25	peak
2	7200.000	40.94	6.88	47.82	74.00	-26.18	peak
3	11520.000	35.80	14.10	49.90	74.00	-24.10	peak
4	13575.000	34.35	15.98	50.33	74.00	-23.67	peak
5	15195.000	35.42	15.56	50.98	74.00	-23.02	peak
6	17985.000	29.22	23.25	52.47	74.00	-21.53	peak

- Note: 1. Measurement = Reading Level + Correct Factor.
 2. If Peak Result complies with AV limit, AV Result is deemed to comply with AV limit.
 3. Peak: Peak detector.
 4. The High Pass filter loss factor already add into the correct factor.
 5. Proper operation of the transmitter prior to adding the filter to the measurement chain.



HARMONICS AND SPURIOUS EMISSIONS (HIGH CHANNEL, HORIZONTAL)

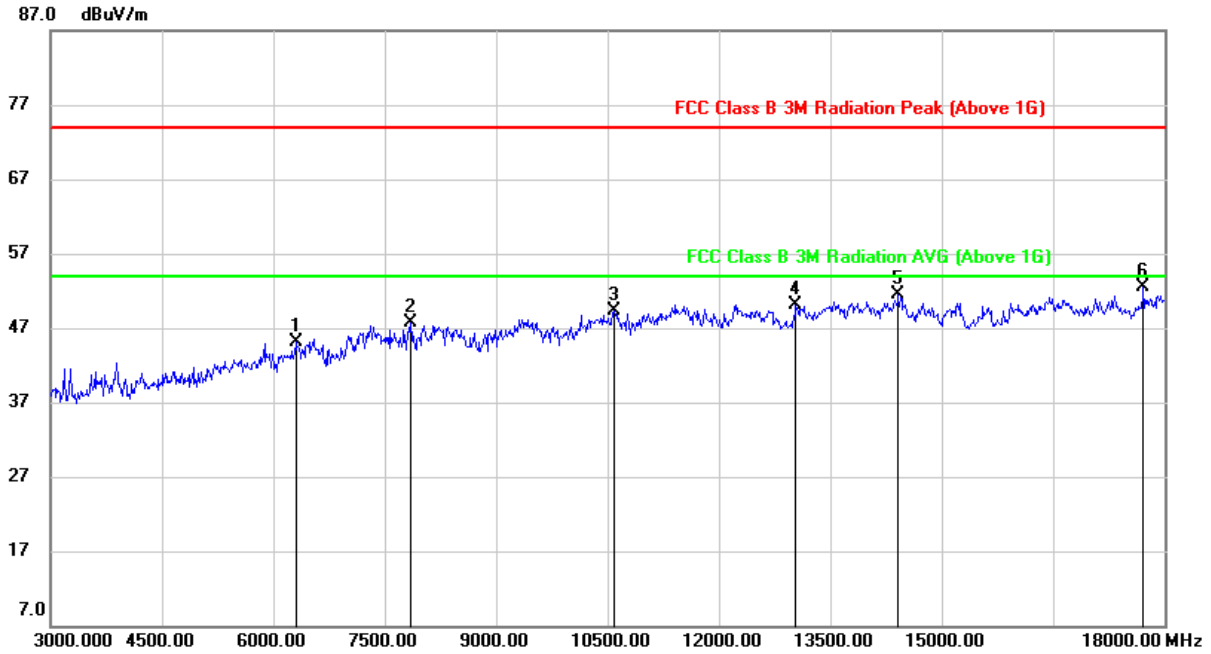

No.	Frequency (MHz)	Reading (dBuV)	Correct (dB/m)	Result (dBuV/m)	Limit (dBuV/m)	Margin (dB)	Remark
1	6300.000	40.63	4.55	45.18	74.00	-28.82	peak
2	7845.000	39.10	8.68	47.78	74.00	-26.22	peak
3	10590.000	36.63	12.68	49.31	74.00	-24.69	peak
4	13035.000	35.22	14.81	50.03	74.00	-23.97	peak
5	14415.000	35.18	16.41	51.59	74.00	-22.41	peak
6	17715.000	30.06	22.39	52.45	74.00	-21.55	peak

- Note:
1. Measurement = Reading Level + Correct Factor.
 2. If Peak Result complies with AV limit, AV Result is deemed to comply with AV limit.
 3. Peak: Peak detector.
 4. The High Pass filter loss factor already add into the correct factor.
 5. Proper operation of the transmitter prior to adding the filter to the measurement chain.



HARMONICS AND SPURIOUS EMISSIONS (HIGH CHANNEL, VERTICAL)

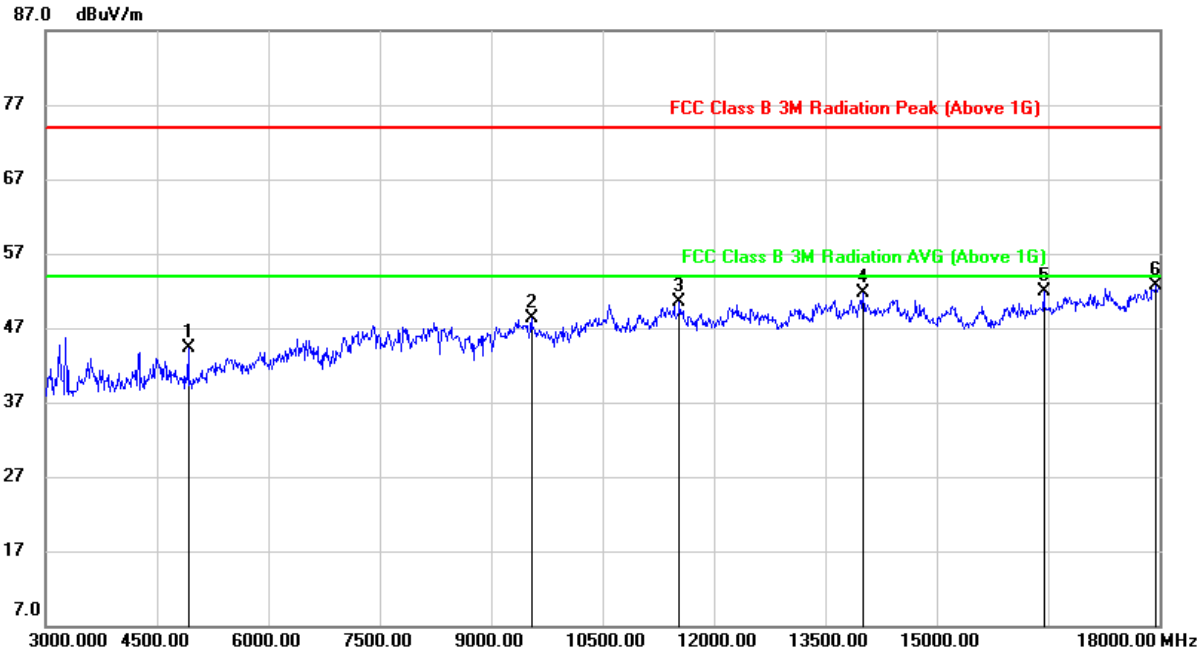

No.	Frequency (MHz)	Reading (dBuV)	Correct (dB/m)	Result (dBuV/m)	Limit (dBuV/m)	Margin (dB)	Remark
1	4920.000	44.20	0.02	44.22	74.00	-29.78	peak
2	9540.000	37.95	10.28	48.23	74.00	-25.77	peak
3	11535.000	36.39	14.10	50.49	74.00	-23.51	peak
4	14010.000	35.37	16.34	51.71	74.00	-22.29	peak
5	16440.000	33.28	18.69	51.97	74.00	-22.03	peak
6	17955.000	29.40	23.23	52.63	74.00	-21.37	peak

- Note: 1. Measurement = Reading Level + Correct Factor.
 2. If Peak Result complies with AV limit, AV Result is deemed to comply with AV limit.
 3. Peak: Peak detector.
 4. The High Pass filter loss factor already add into the correct factor.
 5. Proper operation of the transmitter prior to adding the filter to the measurement chain.

Note: All antennas have been tested, only the worst data record in the report.



9.2.2. 802.11g SISO MODE

ANTENNA1

HARMONICS AND SPURIOUS EMISSIONS (LOW CHANNEL, HORIZONTAL)

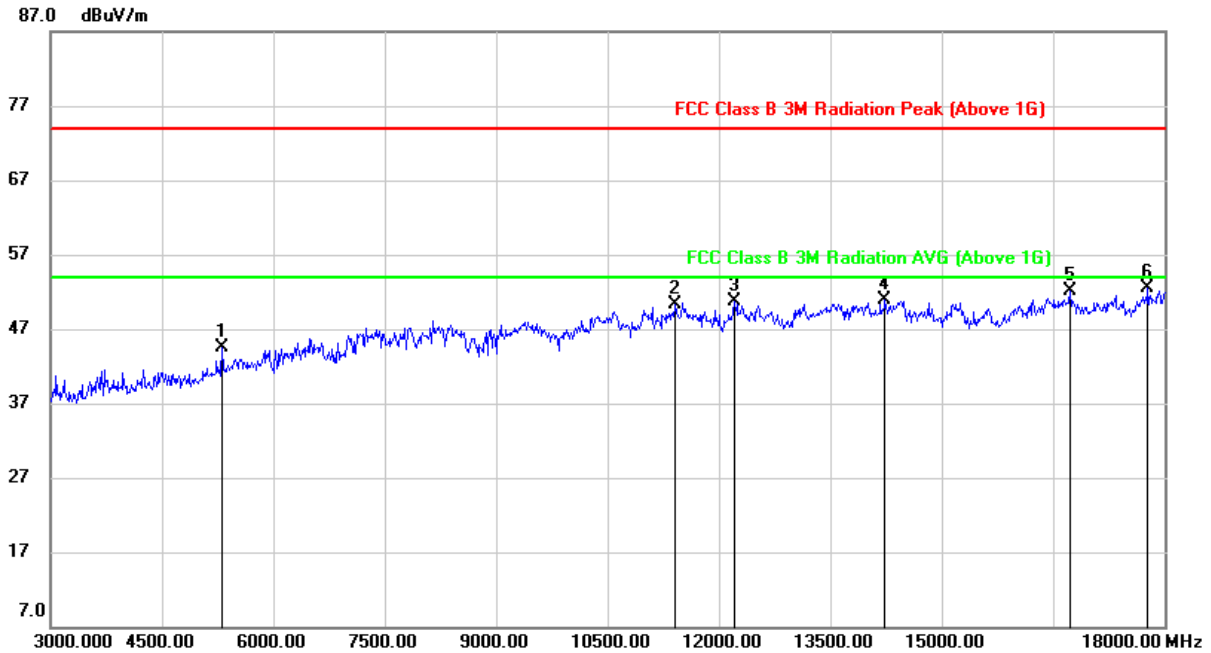

No.	Frequency (MHz)	Reading (dBuV)	Correct (dB/m)	Result (dBuV/m)	Limit (dBuV/m)	Margin (dB)	Remark
1	5310.000	42.95	1.60	44.55	74.00	-29.45	peak
2	11415.000	36.89	13.46	50.35	74.00	-23.65	peak
3	12210.000	36.43	14.25	50.68	74.00	-23.32	peak
4	14235.000	34.46	16.42	50.88	74.00	-23.12	peak
5	16725.000	32.17	19.85	52.02	74.00	-21.98	peak
6	17775.000	29.62	22.97	52.59	74.00	-21.41	peak

- Note: 1. Measurement = Reading Level + Correct Factor.
 2. If Peak Result complies with AV limit, AV Result is deemed to comply with AV limit.
 3. Peak: Peak detector.
 4. The High Pass filter loss factor already add into the correct factor.
 5. Proper operation of the transmitter prior to adding the filter to the measurement chain.



HARMONICS AND SPURIOUS EMISSIONS (LOW CHANNEL, VERTICAL)

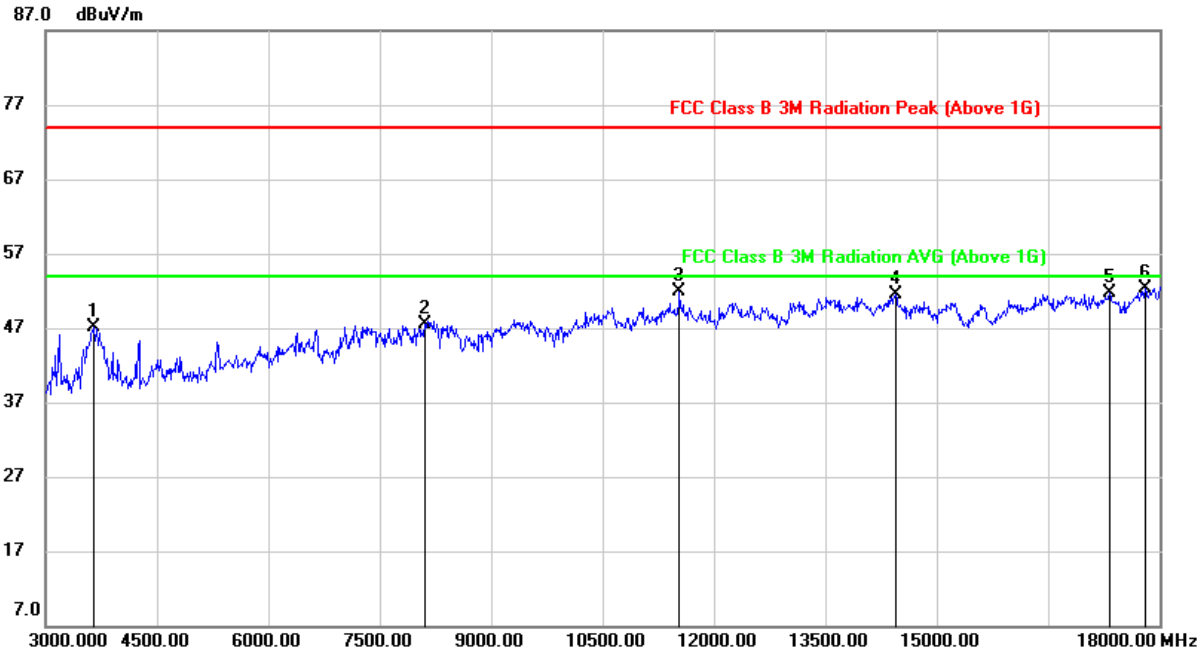

No.	Frequency (MHz)	Reading (dBuV)	Correct (dB/m)	Result (dBuV/m)	Limit (dBuV/m)	Margin (dB)	Remark
1	3645.000	50.32	-3.31	47.01	74.00	-26.99	peak
2	8100.000	38.57	9.03	47.60	74.00	-26.40	peak
3	11535.000	37.71	14.10	51.81	74.00	-22.19	peak
4	14445.000	35.21	16.37	51.58	74.00	-22.42	peak
5	17325.000	29.88	21.80	51.68	74.00	-22.32	peak
6	17805.000	29.12	23.22	52.34	74.00	-21.66	peak

- Note: 1. Measurement = Reading Level + Correct Factor.
 2. If Peak Result complies with AV limit, AV Result is deemed to comply with AV limit.
 3. Peak: Peak detector.
 4. The High Pass filter loss factor already add into the correct factor.
 5. Proper operation of the transmitter prior to adding the filter to the measurement chain.



HARMONICS AND SPURIOUS EMISSIONS (MID CHANNEL, HORIZONTAL)

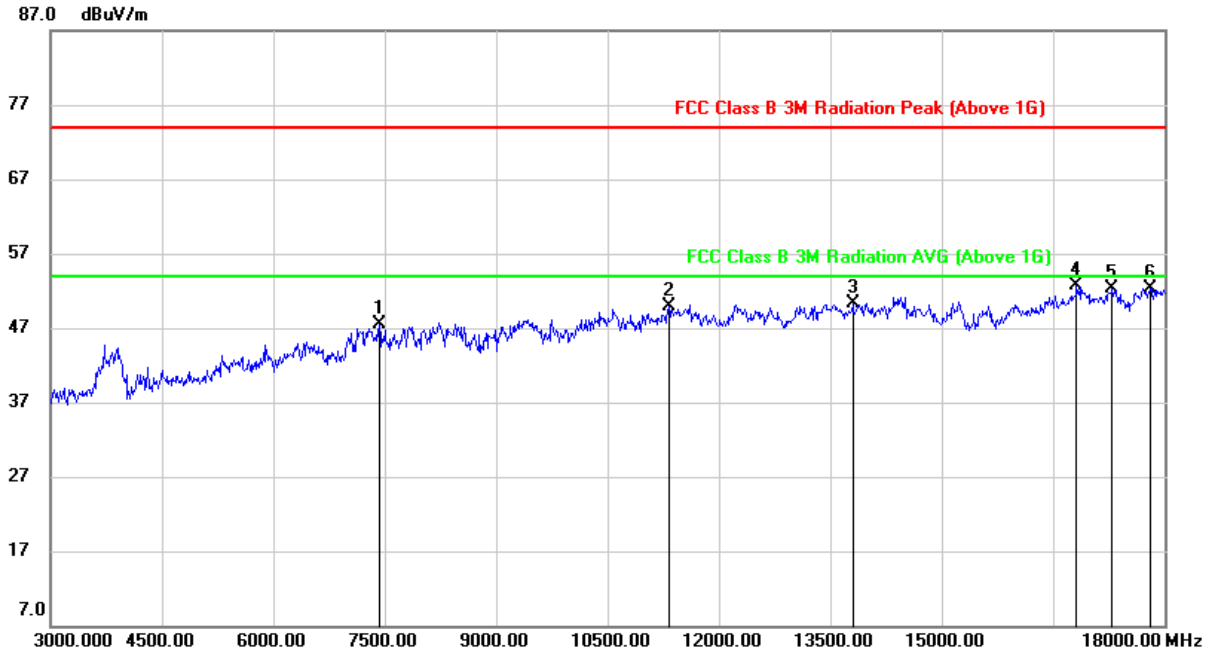

No.	Frequency (MHz)	Reading (dBuV)	Correct (dB/m)	Result (dBuV/m)	Limit (dBuV/m)	Margin (dB)	Remark
1	7425.000	40.04	7.42	47.46	74.00	-26.54	peak
2	11325.000	36.86	13.02	49.88	74.00	-24.12	peak
3	13800.000	33.49	16.81	50.30	74.00	-23.70	peak
4	16815.000	32.70	19.92	52.62	74.00	-21.38	peak
5	17295.000	30.47	21.86	52.33	74.00	-21.67	peak
6	17805.000	29.18	23.22	52.40	74.00	-21.60	peak

- Note:
1. Measurement = Reading Level + Correct Factor.
 2. If Peak Result complies with AV limit, AV Result is deemed to comply with AV limit.
 3. Peak: Peak detector.
 4. The High Pass filter loss factor already add into the correct factor.
 5. Proper operation of the transmitter prior to adding the filter to the measurement chain.



HARMONICS AND SPURIOUS EMISSIONS (MID CHANNEL, VERTICAL)

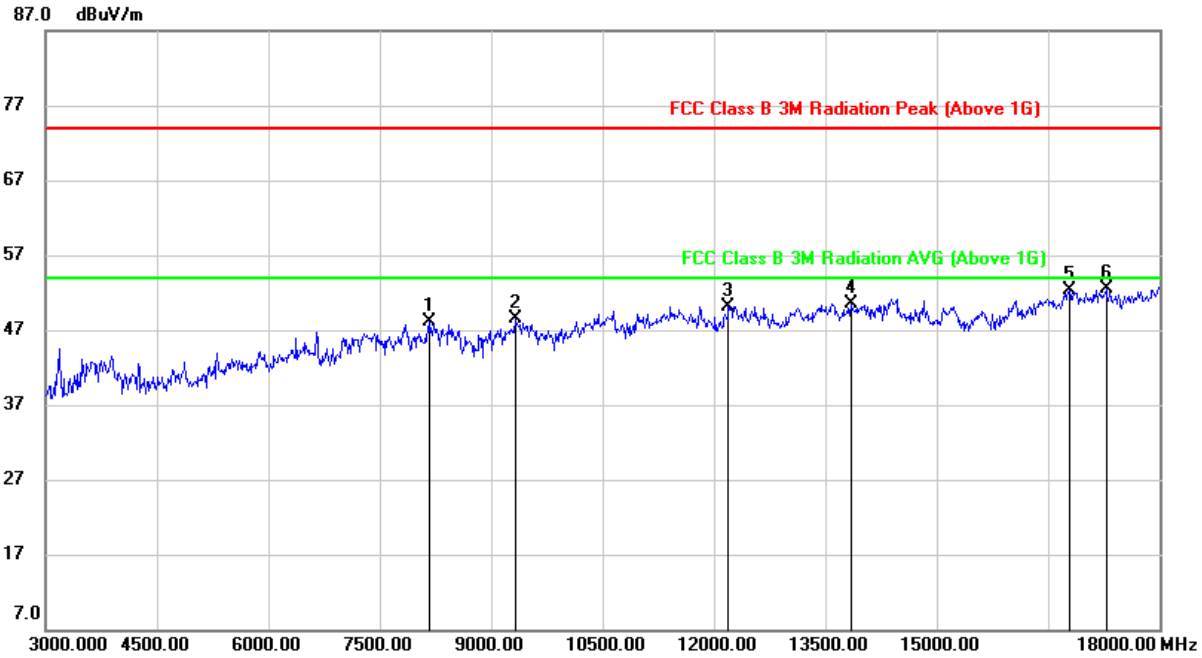

No.	Frequency (MHz)	Reading (dBuV)	Correct (dB/m)	Result (dBuV/m)	Limit (dBuV/m)	Margin (dB)	Remark
1	8175.000	38.53	9.48	48.01	74.00	-25.99	peak
2	9330.000	38.58	9.85	48.43	74.00	-25.57	peak
3	12195.000	35.96	14.24	50.20	74.00	-23.80	peak
4	13845.000	34.07	16.52	50.59	74.00	-23.41	peak
5	16785.000	32.38	19.90	52.28	74.00	-21.72	peak
6	17280.000	30.87	21.72	52.59	74.00	-21.41	peak

- Note:
1. Measurement = Reading Level + Correct Factor.
 2. If Peak Result complies with AV limit, AV Result is deemed to comply with AV limit.
 3. Peak: Peak detector.
 4. The High Pass filter loss factor already add into the correct factor.
 5. Proper operation of the transmitter prior to adding the filter to the measurement chain.



HARMONICS AND SPURIOUS EMISSIONS (HIGH CHANNEL, HORIZONTAL)

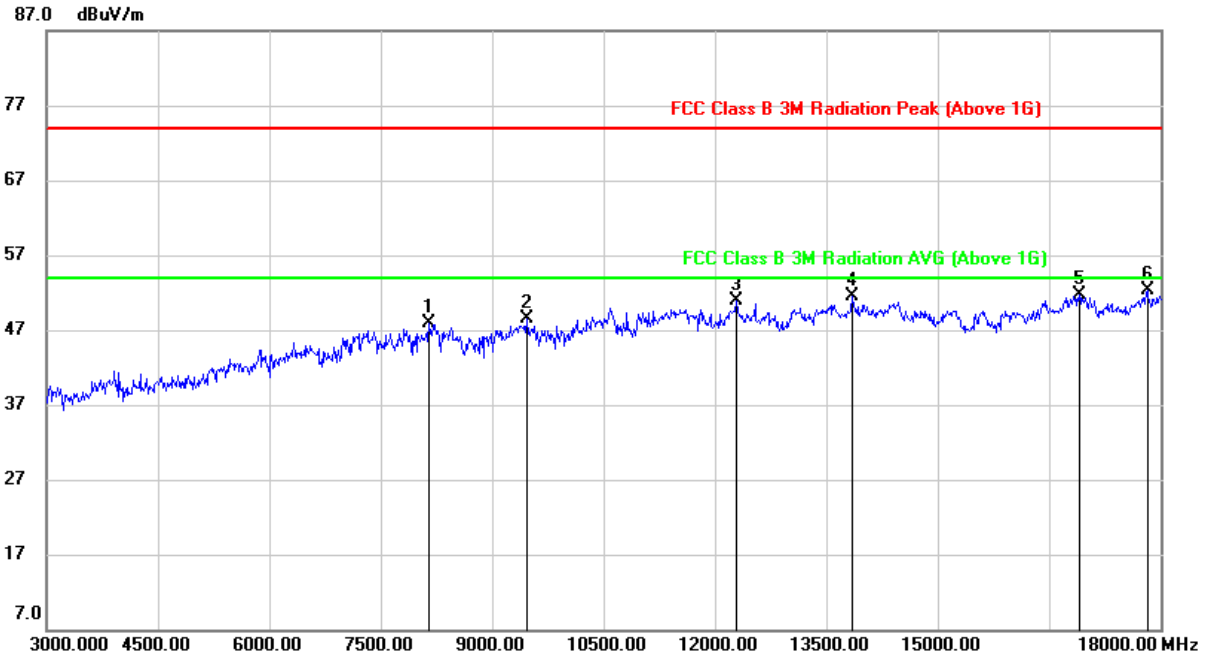

No.	Frequency (MHz)	Reading (dBuV)	Correct (dB/m)	Result (dBuV/m)	Limit (dBuV/m)	Margin (dB)	Remark
1	8145.000	38.60	9.30	47.90	74.00	-26.10	peak
2	9465.000	38.00	10.41	48.41	74.00	-25.59	peak
3	12285.000	36.49	14.37	50.86	74.00	-23.14	peak
4	13845.000	34.95	16.52	51.47	74.00	-22.53	peak
5	16905.000	31.69	19.95	51.64	74.00	-22.36	peak
6	17820.000	29.06	23.21	52.27	74.00	-21.73	peak

- Note:
1. Measurement = Reading Level + Correct Factor.
 2. If Peak Result complies with AV limit, AV Result is deemed to comply with AV limit.
 3. Peak: Peak detector.
 4. The High Pass filter loss factor already add into the correct factor.
 5. Proper operation of the transmitter prior to adding the filter to the measurement chain.



HARMONICS AND SPURIOUS EMISSIONS (HIGH CHANNEL, VERTICAL)

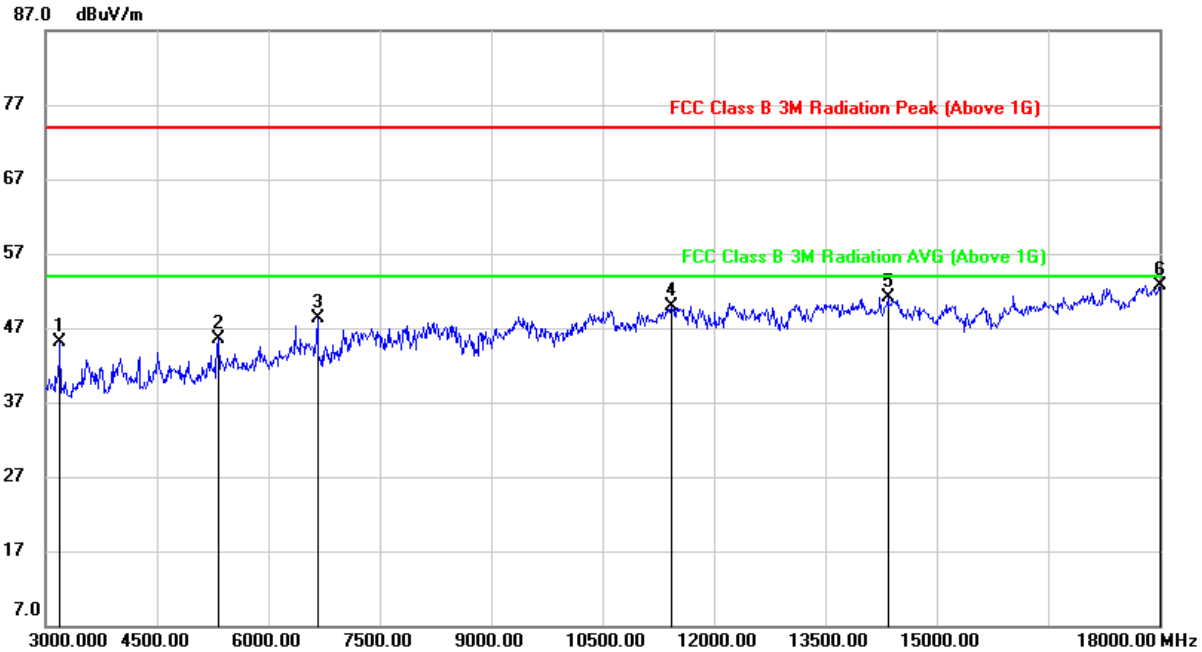

No.	Frequency (MHz)	Reading (dBuV)	Correct (dB/m)	Result (dBuV/m)	Limit (dBuV/m)	Margin (dB)	Remark
1	3195.000	49.62	-4.51	45.11	74.00	-28.89	peak
2	5325.000	43.84	1.57	45.41	74.00	-28.59	peak
3	6660.000	42.36	6.00	48.36	74.00	-25.64	peak
4	11430.000	36.30	13.57	49.87	74.00	-24.13	peak
5	14340.000	34.82	16.36	51.18	74.00	-22.82	peak
6	18000.000	29.51	23.27	52.78	74.00	-21.22	peak

- Note: 1. Measurement = Reading Level + Correct Factor.
 2. If Peak Result complies with AV limit, AV Result is deemed to comply with AV limit.
 3. Peak: Peak detector.
 4. The High Pass filter loss factor already add into the correct factor.
 5. Proper operation of the transmitter prior to adding the filter to the measurement chain.

Note: All antennas have been tested, only the worst data record in the report.



9.2.3. 802.11n HT20 MIMO MODE

HARMONICS AND SPURIOUS EMISSIONS (LOW CHANNEL, HORIZONTAL)

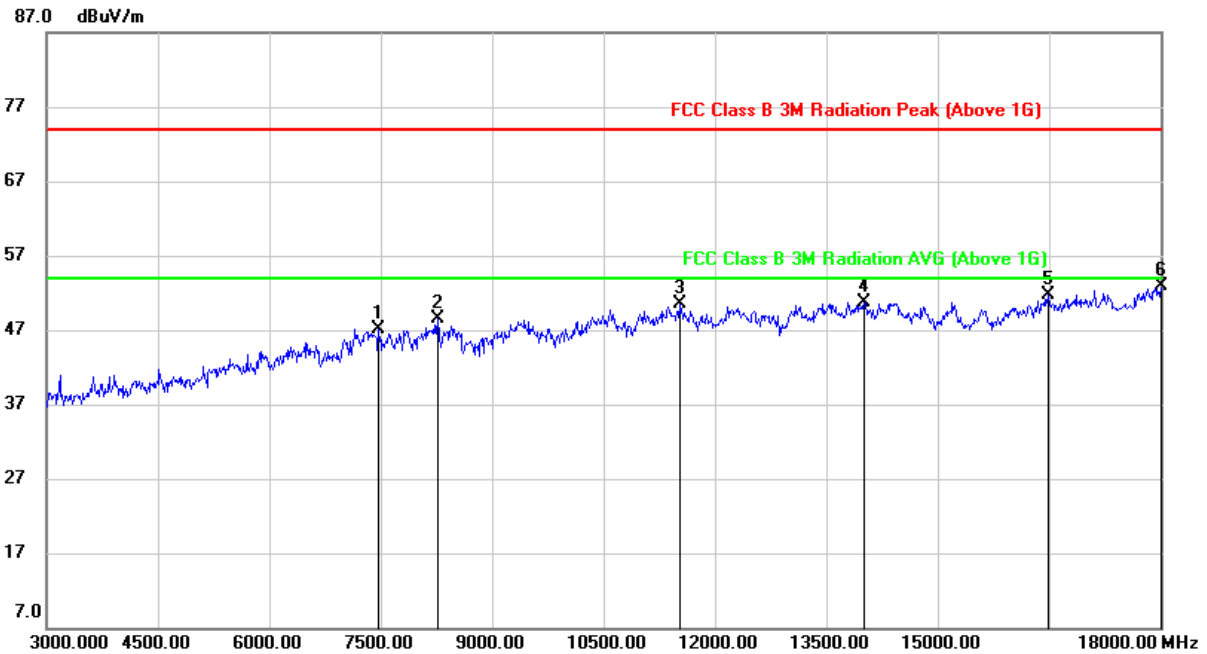

No.	Frequency (MHz)	Reading (dBuV)	Correct (dB/m)	Result (dBuV/m)	Limit (dBuV/m)	Margin (dB)	Remark
1	7470.000	39.81	7.33	47.14	74.00	-26.86	peak
2	8265.000	39.51	8.91	48.42	74.00	-25.58	peak
3	11520.000	36.38	14.10	50.48	74.00	-23.52	peak
4	14010.000	34.44	16.34	50.78	74.00	-23.22	peak
5	16485.000	32.81	18.84	51.65	74.00	-22.35	peak
6	18000.000	29.54	23.27	52.81	74.00	-21.19	peak

- Note: 1. Measurement = Reading Level + Correct Factor.
 2. If Peak Result complies with AV limit, AV Result is deemed to comply with AV limit.
 3. Peak: Peak detector.
 4. The High Pass filter loss factor already add into the correct factor.
 5. Proper operation of the transmitter prior to adding the filter to the measurement chain.



HARMONICS AND SPURIOUS EMISSIONS (LOW CHANNEL, VERTICAL)

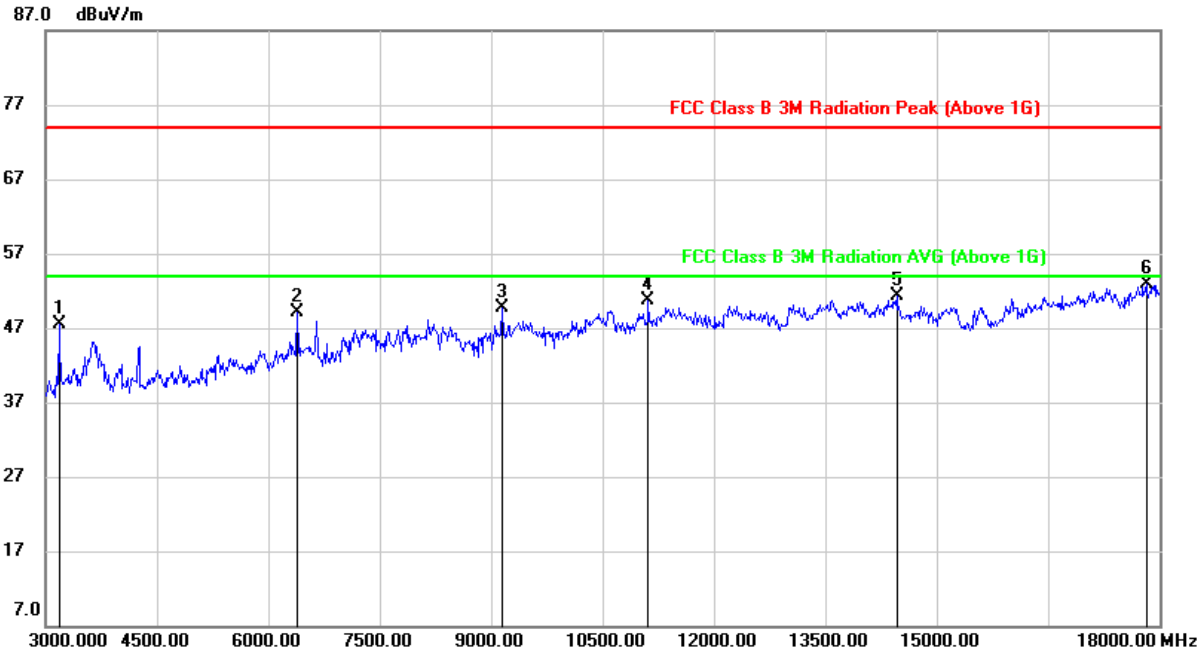

No.	Frequency (MHz)	Reading (dBuV)	Correct (dB/m)	Result (dBuV/m)	Limit (dBuV/m)	Margin (dB)	Remark
1	3180.000	51.87	-4.44	47.43	74.00	-26.57	peak
2	6390.000	44.19	4.97	49.16	74.00	-24.84	peak
3	9150.000	40.05	9.70	49.75	74.00	-24.25	peak
4	11115.000	37.44	13.24	50.68	74.00	-23.32	peak
5	14460.000	34.88	16.35	51.23	74.00	-22.77	peak
6	17820.000	29.61	23.21	52.82	74.00	-21.18	peak

- Note:
1. Measurement = Reading Level + Correct Factor.
 2. If Peak Result complies with AV limit, AV Result is deemed to comply with AV limit.
 3. Peak: Peak detector.
 4. The High Pass filter loss factor already add into the correct factor.
 5. Proper operation of the transmitter prior to adding the filter to the measurement chain.



HARMONICS AND SPURIOUS EMISSIONS (MID CHANNEL, HORIZONTAL)

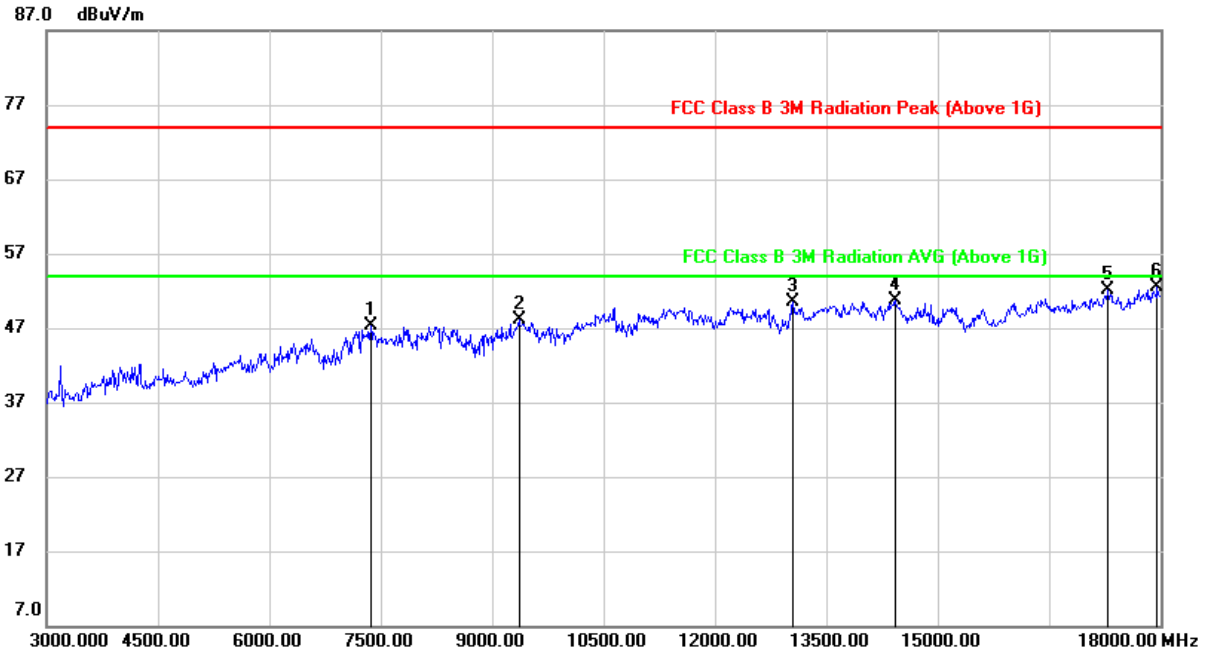

No.	Frequency (MHz)	Reading (dBuV)	Correct (dB/m)	Result (dBuV/m)	Limit (dBuV/m)	Margin (dB)	Remark
1	7365.000	39.87	7.37	47.24	74.00	-26.76	peak
2	9360.000	38.07	10.05	48.12	74.00	-25.88	peak
3	13050.000	35.74	14.85	50.59	74.00	-23.41	peak
4	14430.000	34.28	16.39	50.67	74.00	-23.33	peak
5	17295.000	30.17	21.86	52.03	74.00	-21.97	peak
6	17955.000	29.36	23.23	52.59	74.00	-21.41	peak

- Note:
1. Measurement = Reading Level + Correct Factor.
 2. If Peak Result complies with AV limit, AV Result is deemed to comply with AV limit.
 3. Peak: Peak detector.
 4. The High Pass filter loss factor already add into the correct factor.
 5. Proper operation of the transmitter prior to adding the filter to the measurement chain.



HARMONICS AND SPURIOUS EMISSIONS (MID CHANNEL, VERTICAL)

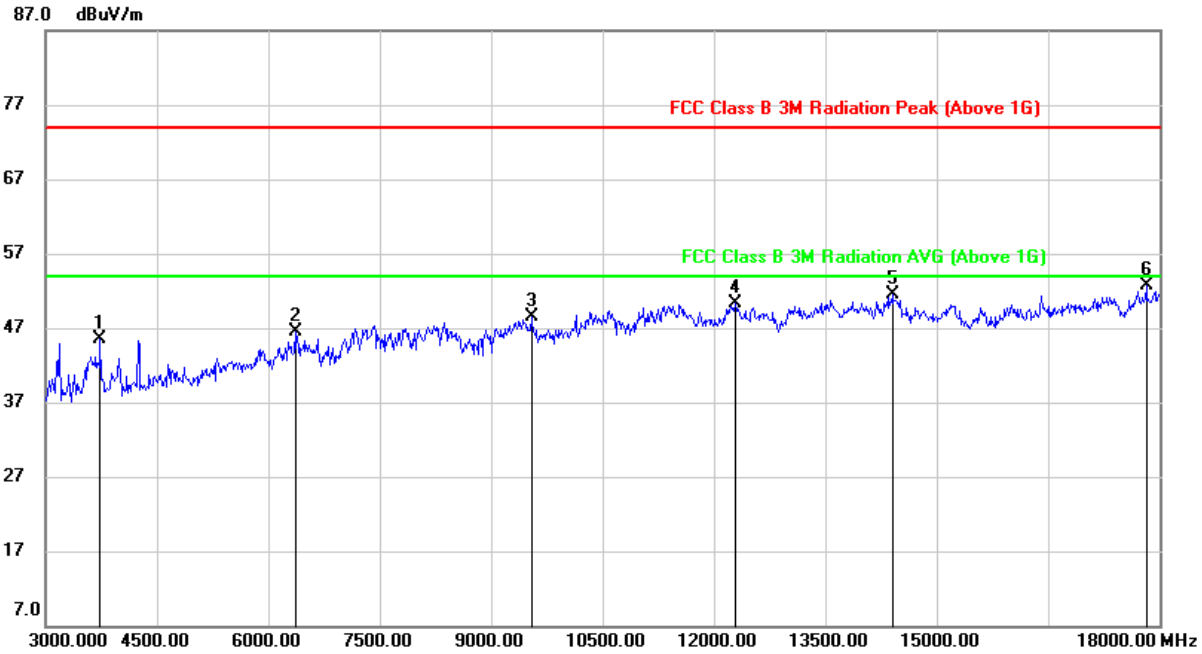

No.	Frequency (MHz)	Reading (dBuV)	Correct (dB/m)	Result (dBuV/m)	Limit (dBuV/m)	Margin (dB)	Remark
1	3735.000	48.44	-2.94	45.50	74.00	-28.50	peak
2	6360.000	41.75	4.84	46.59	74.00	-27.41	peak
3	9540.000	38.21	10.28	48.49	74.00	-25.51	peak
4	12285.000	35.85	14.37	50.22	74.00	-23.78	peak
5	14400.000	35.01	16.43	51.44	74.00	-22.56	peak
6	17820.000	29.40	23.21	52.61	74.00	-21.39	peak

- Note: 1. Measurement = Reading Level + Correct Factor.
 2. If Peak Result complies with AV limit, AV Result is deemed to comply with AV limit.
 3. Peak: Peak detector.
 4. The High Pass filter loss factor already add into the correct factor.
 5. Proper operation of the transmitter prior to adding the filter to the measurement chain.



HARMONICS AND SPURIOUS EMISSIONS (HIGH CHANNEL, HORIZONTAL)

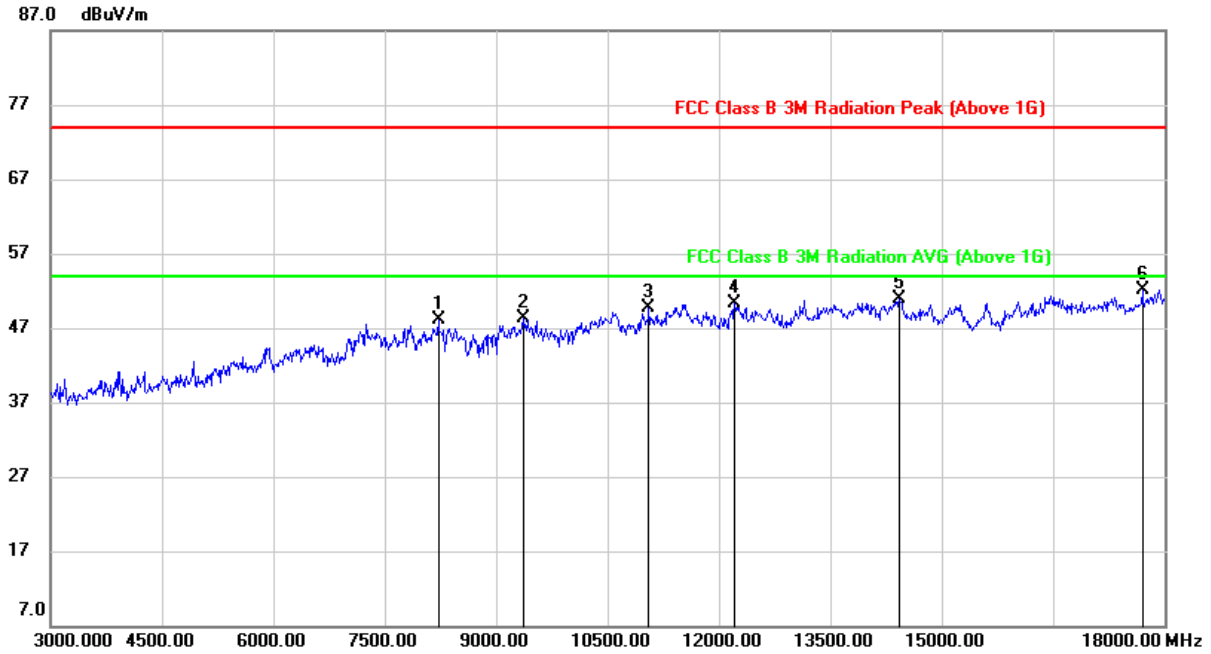

No.	Frequency (MHz)	Reading (dBuV)	Correct (dB/m)	Result (dBuV/m)	Limit (dBuV/m)	Margin (dB)	Remark
1	8220.000	38.62	9.40	48.02	74.00	-25.98	peak
2	9360.000	38.18	10.05	48.23	74.00	-25.77	peak
3	11055.000	36.38	13.26	49.64	74.00	-24.36	peak
4	12210.000	36.07	14.25	50.32	74.00	-23.68	peak
5	14430.000	34.51	16.39	50.90	74.00	-23.10	peak
6	17700.000	29.92	22.24	52.16	74.00	-21.84	peak

- Note: 1. Measurement = Reading Level + Correct Factor.
 2. If Peak Result complies with AV limit, AV Result is deemed to comply with AV limit.
 3. Peak: Peak detector.
 4. The High Pass filter loss factor already add into the correct factor.
 5. Proper operation of the transmitter prior to adding the filter to the measurement chain.



HARMONICS AND SPURIOUS EMISSIONS (HIGH CHANNEL, VERTICAL)

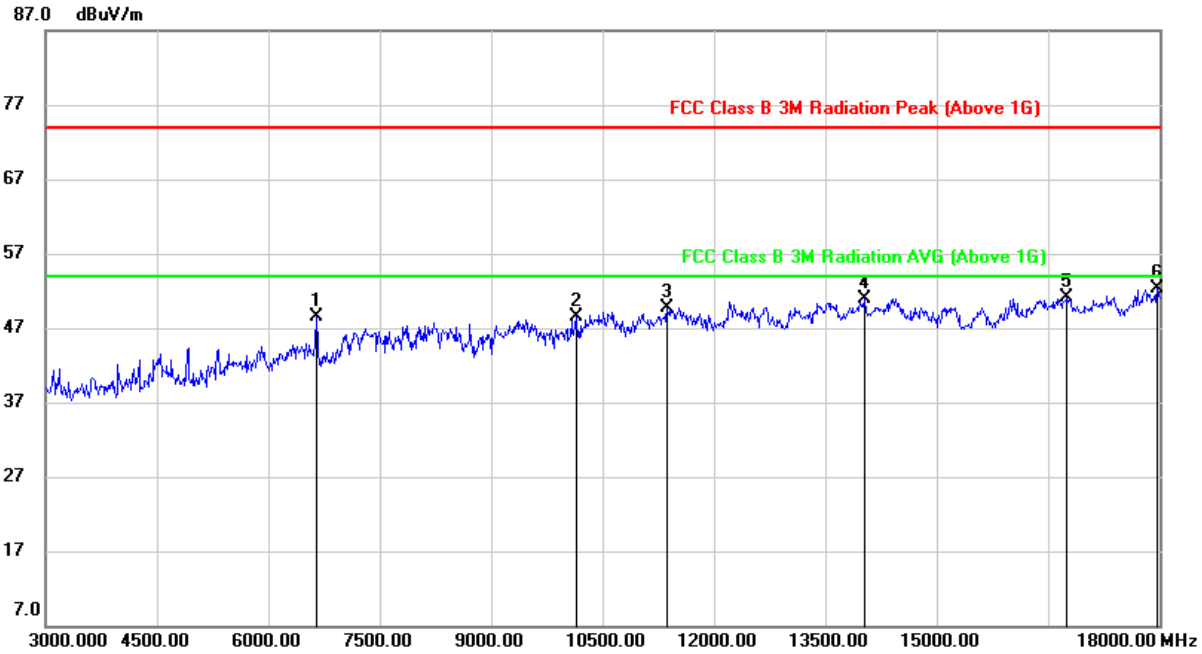

No.	Frequency (MHz)	Reading (dBuV)	Correct (dB/m)	Result (dBuV/m)	Limit (dBuV/m)	Margin (dB)	Remark
1	6645.000	42.52	5.99	48.51	74.00	-25.49	peak
2	10140.000	37.54	10.90	48.44	74.00	-25.56	peak
3	11370.000	36.48	13.22	49.70	74.00	-24.30	peak
4	14025.000	34.65	16.31	50.96	74.00	-23.04	peak
5	16755.000	31.15	19.87	51.02	74.00	-22.98	peak
6	17970.000	29.09	23.24	52.33	74.00	-21.67	peak

- Note: 1. Measurement = Reading Level + Correct Factor.
 2. If Peak Result complies with AV limit, AV Result is deemed to comply with AV limit.
 3. Peak: Peak detector.
 4. The High Pass filter loss factor already add into the correct factor.
 5. Proper operation of the transmitter prior to adding the filter to the measurement chain.

Note: All antennas have been tested, only the worst data record in the report.



9.2.4. 802.11n HT40 MIMO MODE

HARMONICS AND SPURIOUS EMISSIONS (LOW CHANNEL, HORIZONTAL)

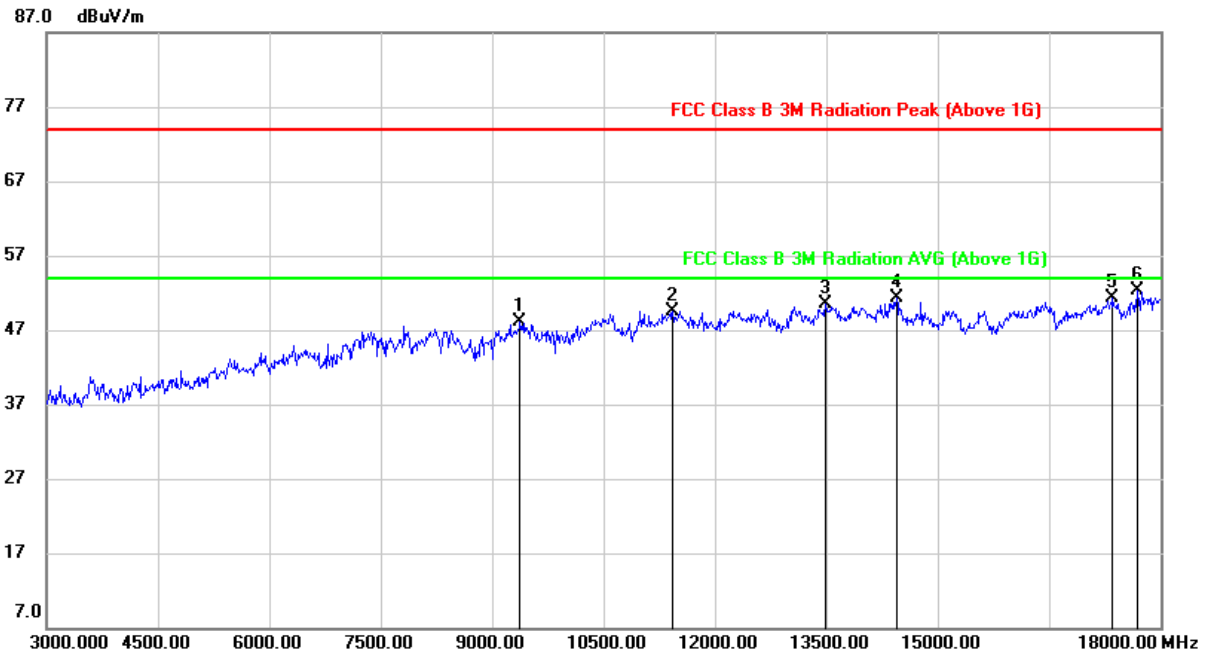

No.	Frequency (MHz)	Reading (dBuV)	Correct (dB/m)	Result (dBuV/m)	Limit (dBuV/m)	Margin (dB)	Remark
1	9375.000	38.01	10.14	48.15	74.00	-25.85	peak
2	11430.000	35.94	13.57	49.51	74.00	-24.49	peak
3	13485.000	34.81	15.70	50.51	74.00	-23.49	peak
4	14445.000	34.90	16.37	51.27	74.00	-22.73	peak
5	17355.000	29.57	21.66	51.23	74.00	-22.77	peak
6	17685.000	30.23	22.11	52.34	74.00	-21.66	peak

- Note: 1. Measurement = Reading Level + Correct Factor.
 2. If Peak Result complies with AV limit, AV Result is deemed to comply with AV limit.
 3. Peak: Peak detector.
 4. The High Pass filter loss factor already add into the correct factor.
 5. Proper operation of the transmitter prior to adding the filter to the measurement chain.



HARMONICS AND SPURIOUS EMISSIONS (LOW CHANNEL, VERTICAL)

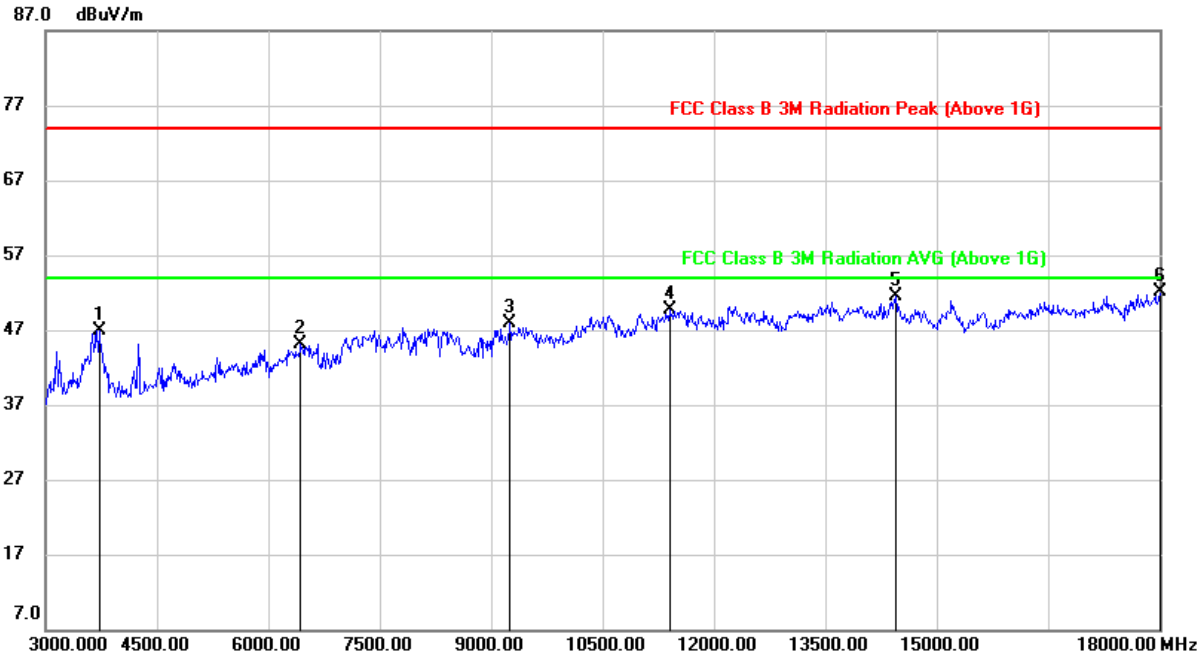

No.	Frequency (MHz)	Reading (dBuV)	Correct (dB/m)	Result (dBuV/m)	Limit (dBuV/m)	Margin (dB)	Remark
1	3720.000	49.82	-2.92	46.90	74.00	-27.10	peak
2	6435.000	39.63	5.48	45.11	74.00	-28.89	peak
3	9255.000	38.42	9.52	47.94	74.00	-26.06	peak
4	11400.000	36.27	13.36	49.63	74.00	-24.37	peak
5	14445.000	35.06	16.37	51.43	74.00	-22.57	peak
6	18000.000	28.93	23.27	52.20	74.00	-21.80	peak

- Note:
1. Measurement = Reading Level + Correct Factor.
 2. If Peak Result complies with AV limit, AV Result is deemed to comply with AV limit.
 3. Peak: Peak detector.
 4. The High Pass filter loss factor already add into the correct factor.
 5. Proper operation of the transmitter prior to adding the filter to the measurement chain.



HARMONICS AND SPURIOUS EMISSIONS (MID CHANNEL, HORIZONTAL)

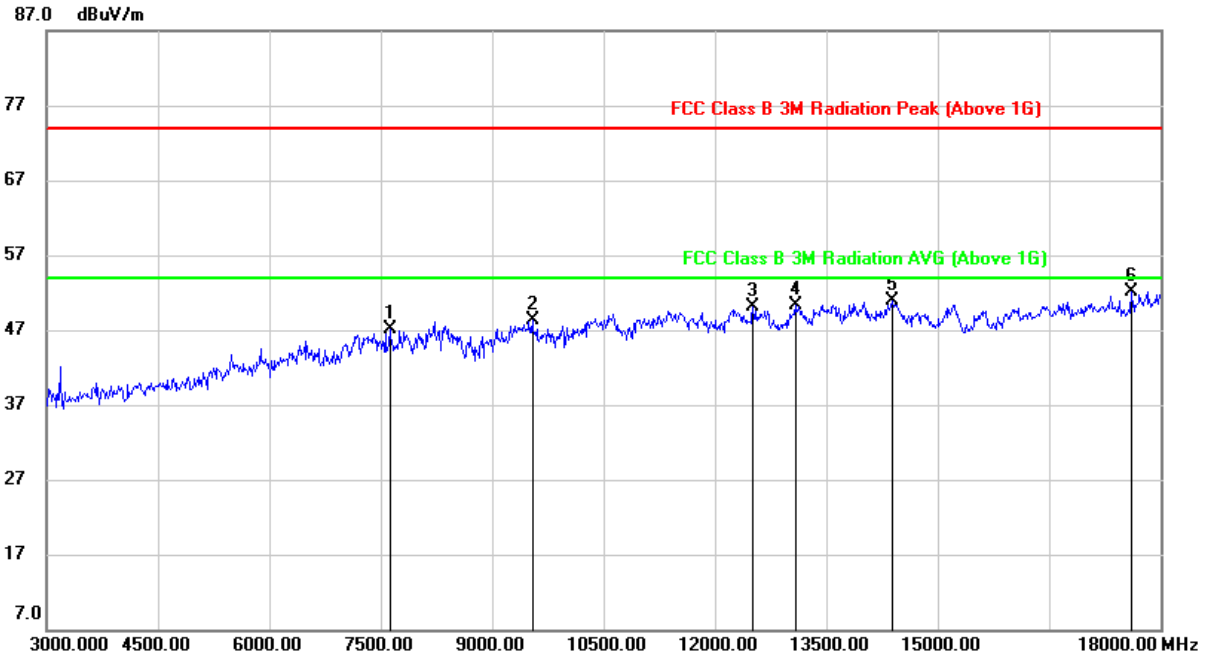

No.	Frequency (MHz)	Reading (dBuV)	Correct (dB/m)	Result (dBuV/m)	Limit (dBuV/m)	Margin (dB)	Remark
1	7620.000	39.53	7.63	47.16	74.00	-26.84	peak
2	9540.000	38.00	10.28	48.28	74.00	-25.72	peak
3	12510.000	35.34	14.76	50.10	74.00	-23.90	peak
4	13080.000	35.37	14.94	50.31	74.00	-23.69	peak
5	14385.000	34.48	16.41	50.89	74.00	-23.11	peak
6	17610.000	30.52	21.50	52.02	74.00	-21.98	peak

- Note: 1. Measurement = Reading Level + Correct Factor.
 2. If Peak Result complies with AV limit, AV Result is deemed to comply with AV limit.
 3. Peak: Peak detector.
 4. The High Pass filter loss factor already add into the correct factor.
 5. Proper operation of the transmitter prior to adding the filter to the measurement chain.



HARMONICS AND SPURIOUS EMISSIONS (MID CHANNEL, VERTICAL)

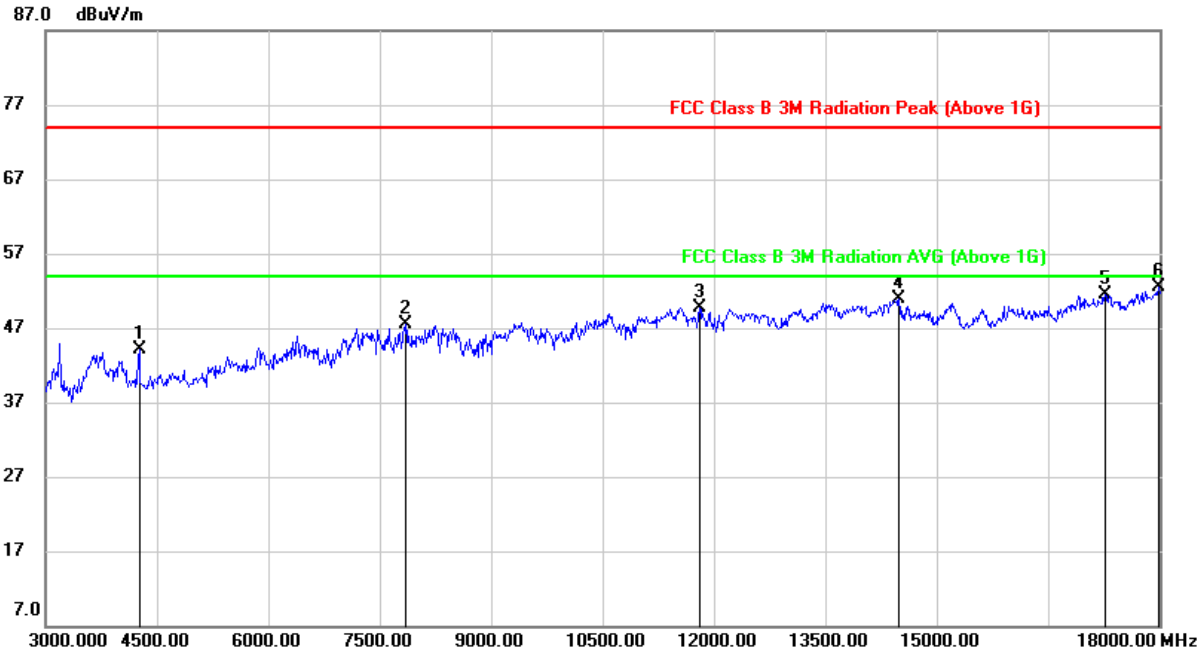

No.	Frequency (MHz)	Reading (dBuV)	Correct (dB/m)	Result (dBuV/m)	Limit (dBuV/m)	Margin (dB)	Remark
1	4260.000	46.22	-2.09	44.13	74.00	-29.87	peak
2	7845.000	38.87	8.68	47.55	74.00	-26.45	peak
3	11805.000	36.09	13.66	49.75	74.00	-24.25	peak
4	14490.000	34.54	16.32	50.86	74.00	-23.14	peak
5	17265.000	29.85	21.59	51.44	74.00	-22.56	peak
6	17985.000	29.23	23.25	52.48	74.00	-21.52	peak

- Note: 1. Measurement = Reading Level + Correct Factor.
 2. If Peak Result complies with AV limit, AV Result is deemed to comply with AV limit.
 3. Peak: Peak detector.
 4. The High Pass filter loss factor already add into the correct factor.
 5. Proper operation of the transmitter prior to adding the filter to the measurement chain.



HARMONICS AND SPURIOUS EMISSIONS (HIGH CHANNEL, HORIZONTAL)

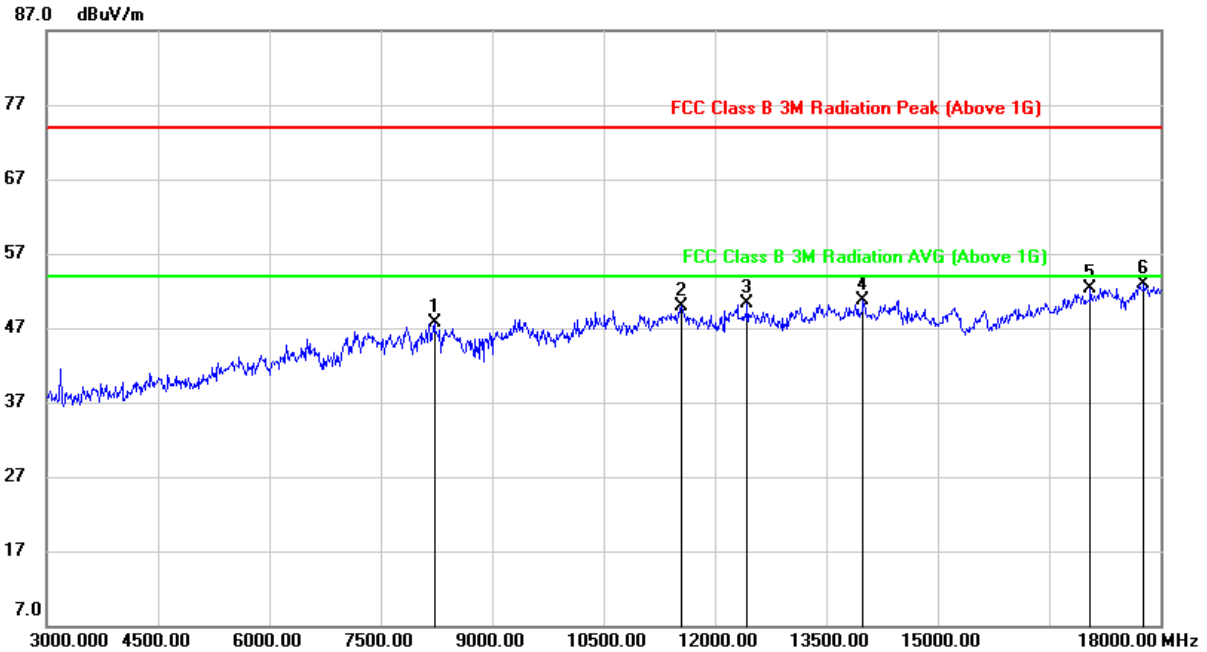

No.	Frequency (MHz)	Reading (dBuV)	Correct (dB/m)	Result (dBuV/m)	Limit (dBuV/m)	Margin (dB)	Remark
1	8220.000	38.36	9.40	47.76	74.00	-26.24	peak
2	11550.000	35.69	14.13	49.82	74.00	-24.18	peak
3	12435.000	35.70	14.51	50.21	74.00	-23.79	peak
4	13995.000	34.29	16.35	50.64	74.00	-23.36	peak
5	17055.000	31.82	20.57	52.39	74.00	-21.61	peak
6	17775.000	29.92	22.97	52.89	74.00	-21.11	peak

- Note:
1. Measurement = Reading Level + Correct Factor.
 2. If Peak Result complies with AV limit, AV Result is deemed to comply with AV limit.
 3. Peak: Peak detector.
 4. The High Pass filter loss factor already add into the correct factor.
 5. Proper operation of the transmitter prior to adding the filter to the measurement chain.



HARMONICS AND SPURIOUS EMISSIONS (HIGH CHANNEL, VERTICAL)

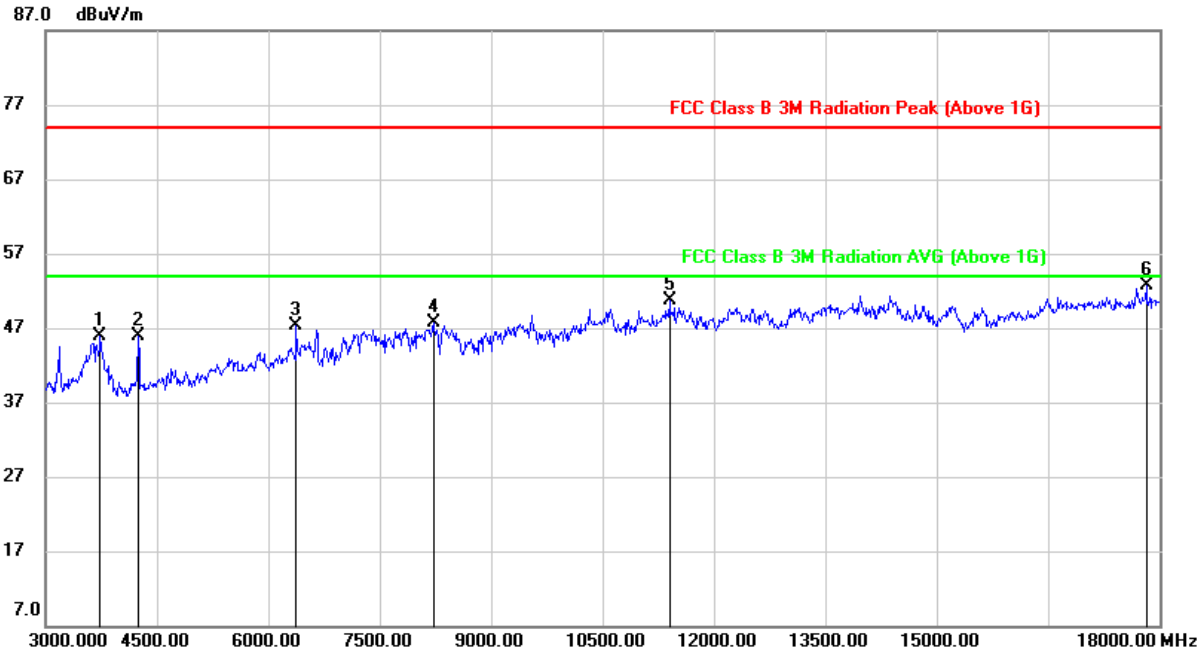

No.	Frequency (MHz)	Reading (dBuV)	Correct (dB/m)	Result (dBuV/m)	Limit (dBuV/m)	Margin (dB)	Remark
1	3735.000	48.92	-2.94	45.98	74.00	-28.02	peak
2	4245.000	47.90	-2.02	45.88	74.00	-28.12	peak
3	6375.000	42.38	4.90	47.28	74.00	-26.72	peak
4	8220.000	38.38	9.40	47.78	74.00	-26.22	peak
5	11400.000	37.29	13.36	50.65	74.00	-23.35	peak
6	17820.000	29.44	23.21	52.65	74.00	-21.35	peak

- Note: 1. Measurement = Reading Level + Correct Factor.
 2. If Peak Result complies with AV limit, AV Result is deemed to comply with AV limit.
 3. Peak: Peak detector.
 4. The High Pass filter loss factor already add into the correct factor.
 5. Proper operation of the transmitter prior to adding the filter to the measurement chain.

Note: All antennas have been tested, only the worst data record in the report.



9.3. SPURIOUS EMISSIONS (1~3GHz)

9.3.1. 802.11b MODE

HARMONICS AND SPURIOUS EMISSIONS (LOW CHANNEL, HORIZONTAL)

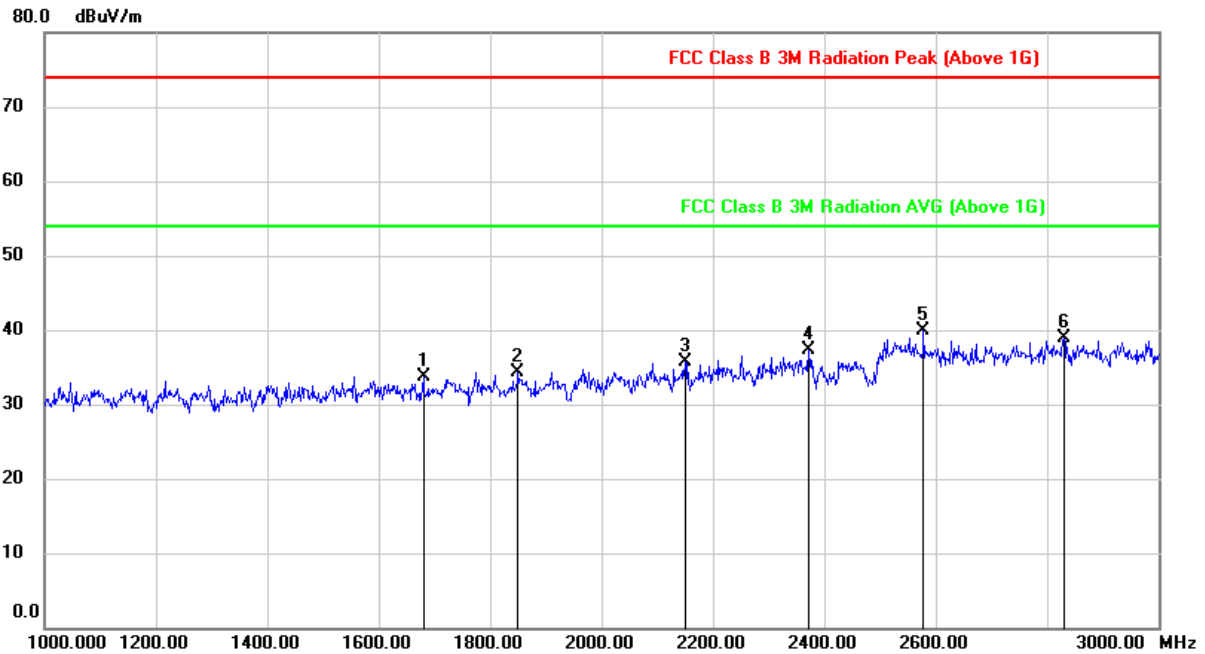

No.	Frequency (MHz)	Reading (dBuV)	Correct (dB/m)	Result (dBuV/m)	Limit (dBuV/m)	Margin (dB)	Remark
1	1680.000	44.40	-10.70	33.70	74.00	-40.30	peak
2	1850.000	43.70	-9.35	34.35	74.00	-39.65	peak
3	2150.000	44.17	-8.38	35.79	74.00	-38.21	peak
4	2372.000	44.45	-7.22	37.23	74.00	-36.77	peak
5	2578.000	46.67	-6.70	39.97	74.00	-34.03	peak
6	2830.000	44.01	-5.17	38.84	74.00	-35.16	peak

- Note: 1. Measurement = Reading Level + Correct Factor.
 2. If Peak Result complies with AV limit, AV Result is deemed to comply with AV limit.
 3. Peak: Peak detector.
 4. Filter losses were only considered in then spurious frequency bands and the authorized band was not corrected for BRF losses.
 5. Proper operation of the transmitter prior to adding the filter to the measurement chain.



HARMONICS AND SPURIOUS EMISSIONS (LOW CHANNEL, VERTICAL)

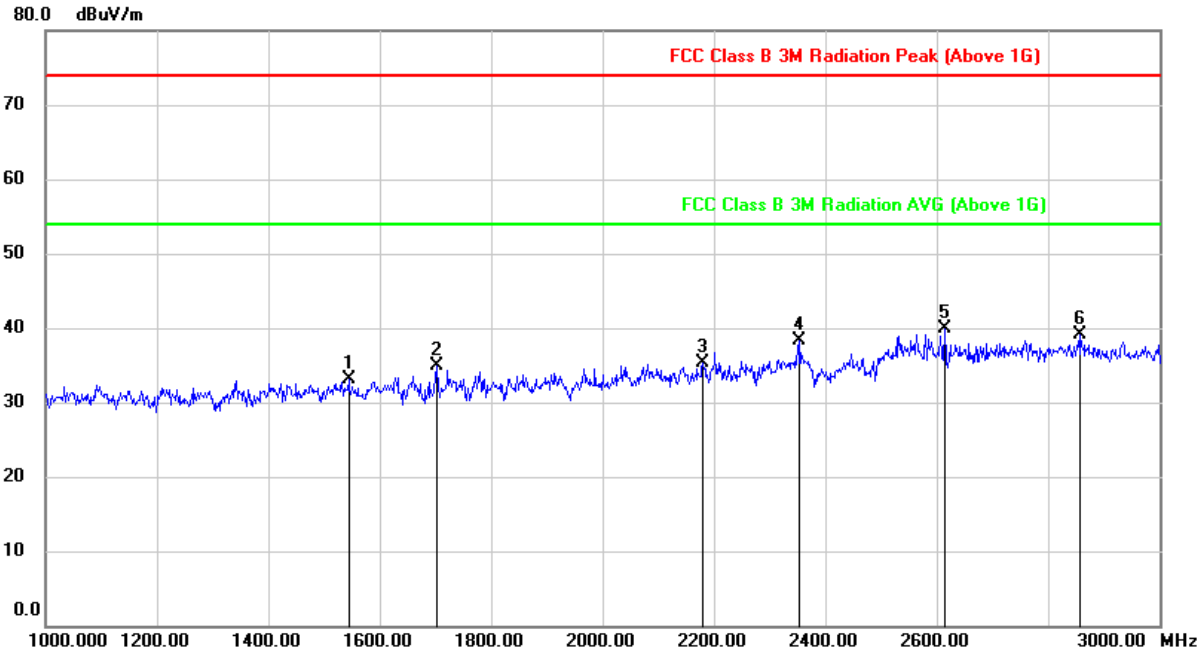

No.	Frequency (MHz)	Reading (dBuV)	Correct (dB/m)	Result (dBuV/m)	Limit (dBuV/m)	Margin (dB)	Remark
1	1544.000	44.34	-11.16	33.18	74.00	-40.82	peak
2	1702.000	45.54	-10.68	34.86	74.00	-39.14	peak
3	2180.000	43.77	-8.42	35.35	74.00	-38.65	peak
4	2354.000	45.59	-7.28	38.31	74.00	-35.69	peak
5	2614.000	46.82	-6.89	39.93	74.00	-34.07	peak
6	2858.000	44.32	-5.16	39.16	74.00	-34.84	peak

- Note: 1. Measurement = Reading Level + Correct Factor.
 2. If Peak Result complies with AV limit, AV Result is deemed to comply with AV limit.
 3. Peak: Peak detector.
 4. Filter losses were only considered in then spurious frequency bands and the authorized band was not corrected for BRF losses.
 5. Proper operation of the transmitter prior to adding the filter to the measurement chain.



HARMONICS AND SPURIOUS EMISSIONS (MID CHANNEL, HORIZONTAL)

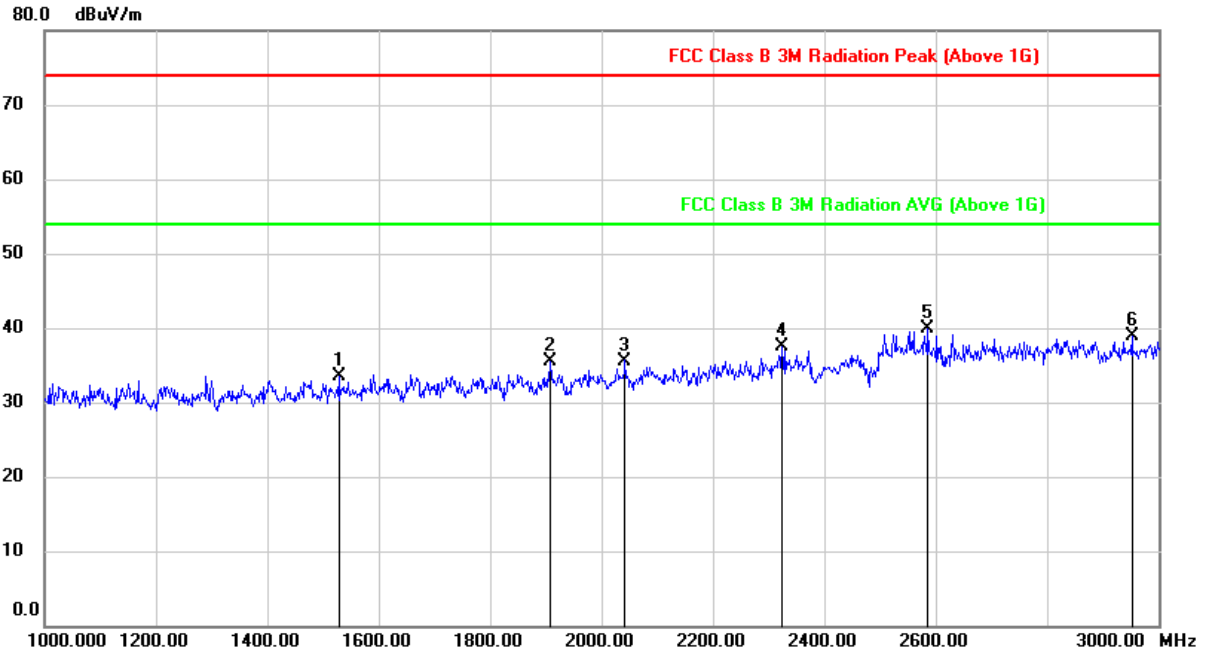

No.	Frequency (MHz)	Reading (dBuV)	Correct (dB/m)	Result (dBuV/m)	Limit (dBuV/m)	Margin (dB)	Remark
1	1528.000	44.78	-11.32	33.46	74.00	-40.54	peak
2	1908.000	44.93	-9.34	35.59	74.00	-38.41	peak
3	2042.000	44.76	-9.16	35.60	74.00	-38.40	peak
4	2324.000	44.81	-7.40	37.41	74.00	-36.59	peak
5	2586.000	46.62	-6.73	39.89	74.00	-34.11	peak
6	2952.000	43.69	-4.85	38.84	74.00	-35.16	peak

- Note: 1. Measurement = Reading Level + Correct Factor.
 2. If Peak Result complies with AV limit, AV Result is deemed to comply with AV limit.
 3. Peak: Peak detector.
 4. Filter losses were only considered in then spurious frequency bands and the authorized band was not corrected for BRF losses.
 5. Proper operation of the transmitter prior to adding the filter to the measurement chain.



HARMONICS AND SPURIOUS EMISSIONS (MID CHANNEL, VERTICAL)

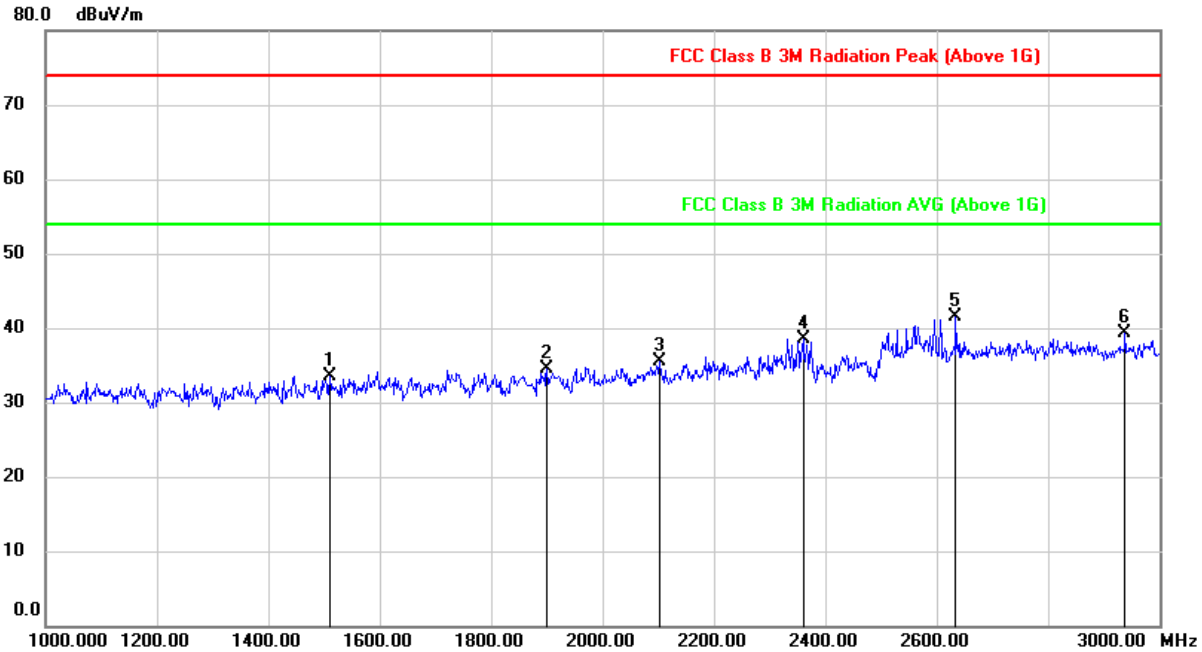

No.	Frequency (MHz)	Reading (dBuV)	Correct (dB/m)	Result (dBuV/m)	Limit (dBuV/m)	Margin (dB)	Remark
1	1510.000	45.09	-11.50	33.59	74.00	-40.41	peak
2	1900.000	43.75	-9.30	34.45	74.00	-39.55	peak
3	2102.000	43.85	-8.33	35.52	74.00	-38.48	peak
4	2360.000	45.78	-7.26	38.52	74.00	-35.48	peak
5	2634.000	48.48	-7.02	41.46	74.00	-32.54	peak
6	2938.000	44.28	-4.93	39.35	74.00	-34.65	peak

- Note: 1. Measurement = Reading Level + Correct Factor.
 2. If Peak Result complies with AV limit, AV Result is deemed to comply with AV limit.
 3. Peak: Peak detector.
 4. Filter losses were only considered in then spurious frequency bands and the authorized band was not corrected for BRF losses.
 5. Proper operation of the transmitter prior to adding the filter to the measurement chain.



HARMONICS AND SPURIOUS EMISSIONS (HIGH CHANNEL, HORIZONTAL)

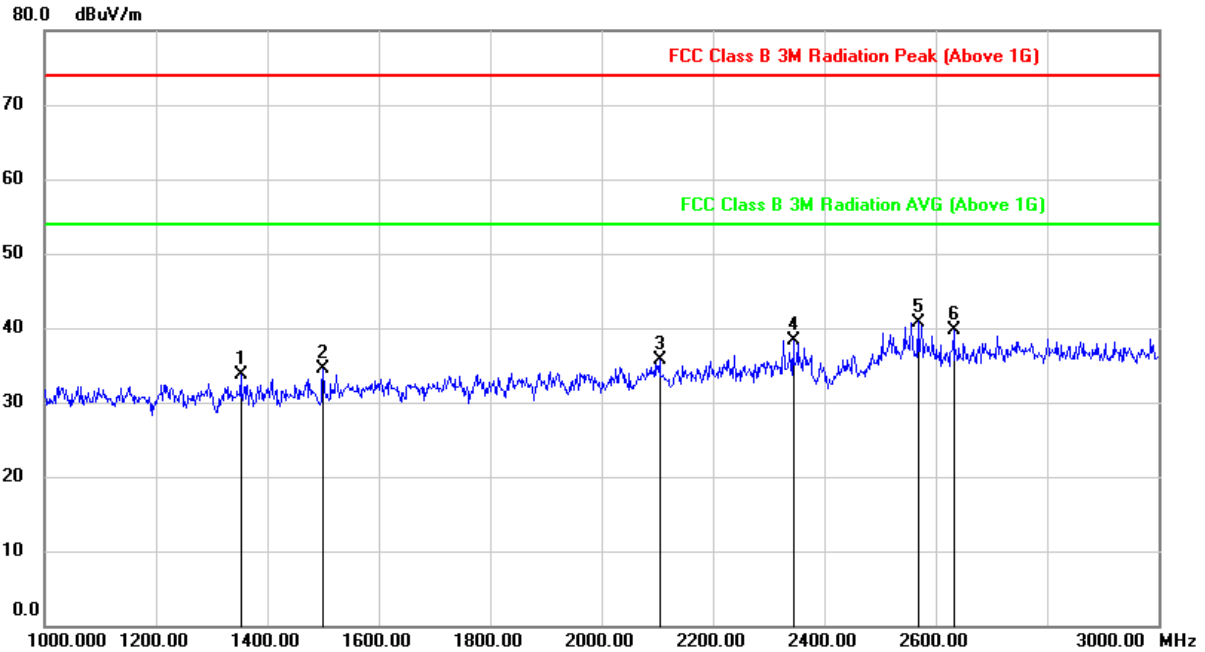

No.	Frequency (MHz)	Reading (dBuV)	Correct (dB/m)	Result (dBuV/m)	Limit (dBuV/m)	Margin (dB)	Remark
1	1352.000	45.24	-11.59	33.65	74.00	-40.35	peak
2	1500.000	46.12	-11.60	34.52	74.00	-39.48	peak
3	2104.000	44.04	-8.32	35.72	74.00	-38.28	peak
4	2344.000	45.68	-7.32	38.36	74.00	-35.64	peak
5	2568.000	47.46	-6.66	40.80	74.00	-33.20	peak
6	2632.000	46.68	-7.00	39.68	74.00	-34.32	peak

- Note: 1. Measurement = Reading Level + Correct Factor.
 2. If Peak Result complies with AV limit, AV Result is deemed to comply with AV limit.
 3. Peak: Peak detector.
 4. Filter losses were only considered in then spurious frequency bands and the authorized band was not corrected for BRF losses.
 5. Proper operation of the transmitter prior to adding the filter to the measurement chain.



HARMONICS AND SPURIOUS EMISSIONS (HIGH CHANNEL, VERTICAL)

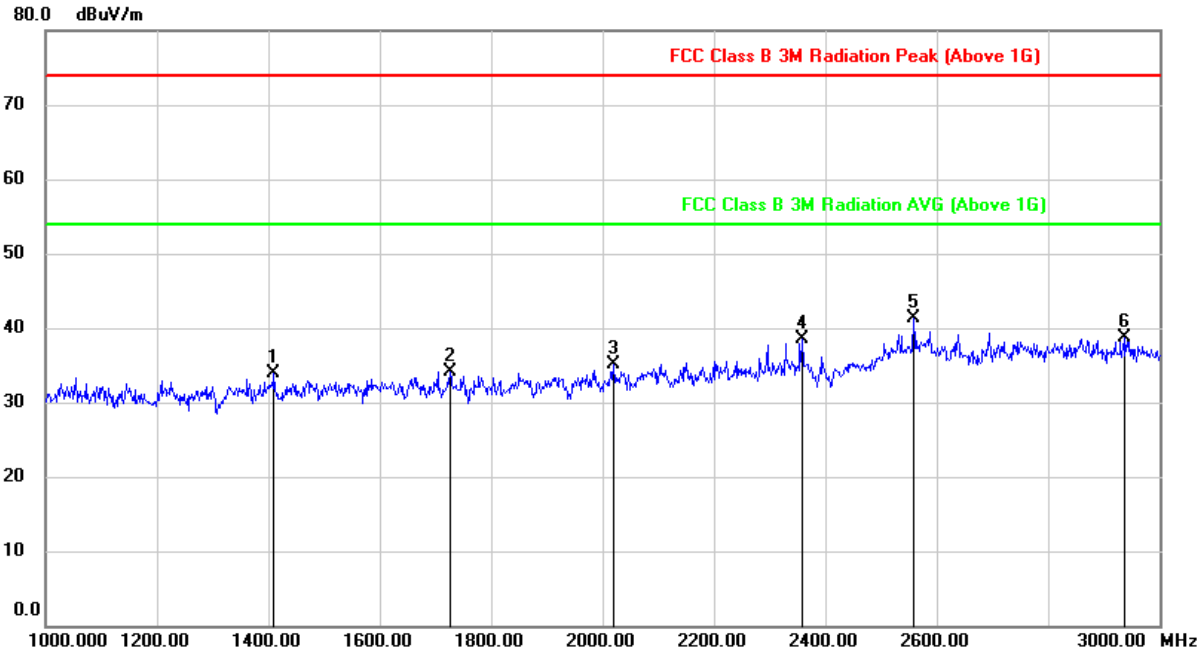

No.	Frequency (MHz)	Reading (dBuV)	Correct (dB/m)	Result (dBuV/m)	Limit (dBuV/m)	Margin (dB)	Remark
1	1410.000	45.79	-11.89	33.90	74.00	-40.10	peak
2	1726.000	44.42	-10.37	34.05	74.00	-39.95	peak
3	2020.000	44.57	-9.49	35.08	74.00	-38.92	peak
4	2358.000	45.84	-7.27	38.57	74.00	-35.43	peak
5	2558.000	48.00	-6.60	41.40	74.00	-32.60	peak
6	2938.000	43.62	-4.93	38.69	74.00	-35.31	peak

- Note: 1. Measurement = Reading Level + Correct Factor.
 2. If Peak Result complies with AV limit, AV Result is deemed to comply with AV limit.
 3. Peak: Peak detector.
 4. Filter losses were only considered in then spurious frequency bands and the authorized band was not corrected for BRF losses.
 5. Proper operation of the transmitter prior to adding the filter to the measurement chain.

Note: All antennas have been tested, only the worst data record in the report.



9.3.2. 802.11g MODE

HARMONICS AND SPURIOUS EMISSIONS (LOW CHANNEL, HORIZONTAL)

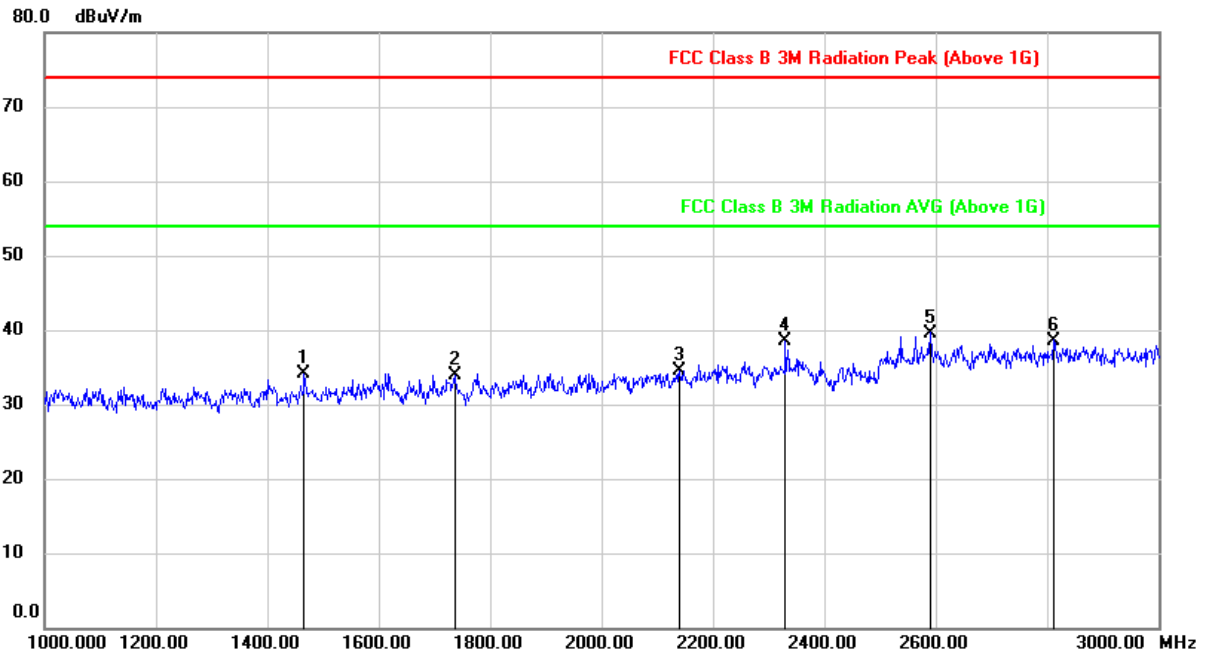

No.	Frequency (MHz)	Reading (dBuV)	Correct (dB/m)	Result (dBuV/m)	Limit (dBuV/m)	Margin (dB)	Remark
1	1466.000	45.83	-11.71	34.12	74.00	-39.88	peak
2	1736.000	44.10	-10.24	33.86	74.00	-40.14	peak
3	2140.000	42.90	-8.37	34.53	74.00	-39.47	peak
4	2330.000	45.89	-7.38	38.51	74.00	-35.49	peak
5	2590.000	46.36	-6.76	39.60	74.00	-34.40	peak
6	2812.000	43.80	-5.20	38.60	74.00	-35.40	peak

- Note: 1. Measurement = Reading Level + Correct Factor.
 2. If Peak Result complies with AV limit, AV Result is deemed to comply with AV limit.
 3. Peak: Peak detector.
 4. Filter losses were only considered in then spurious frequency bands and the authorized band was not corrected for BRF losses.
 5. Proper operation of the transmitter prior to adding the filter to the measurement chain.



HARMONICS AND SPURIOUS EMISSIONS (LOW CHANNEL, VERTICAL)

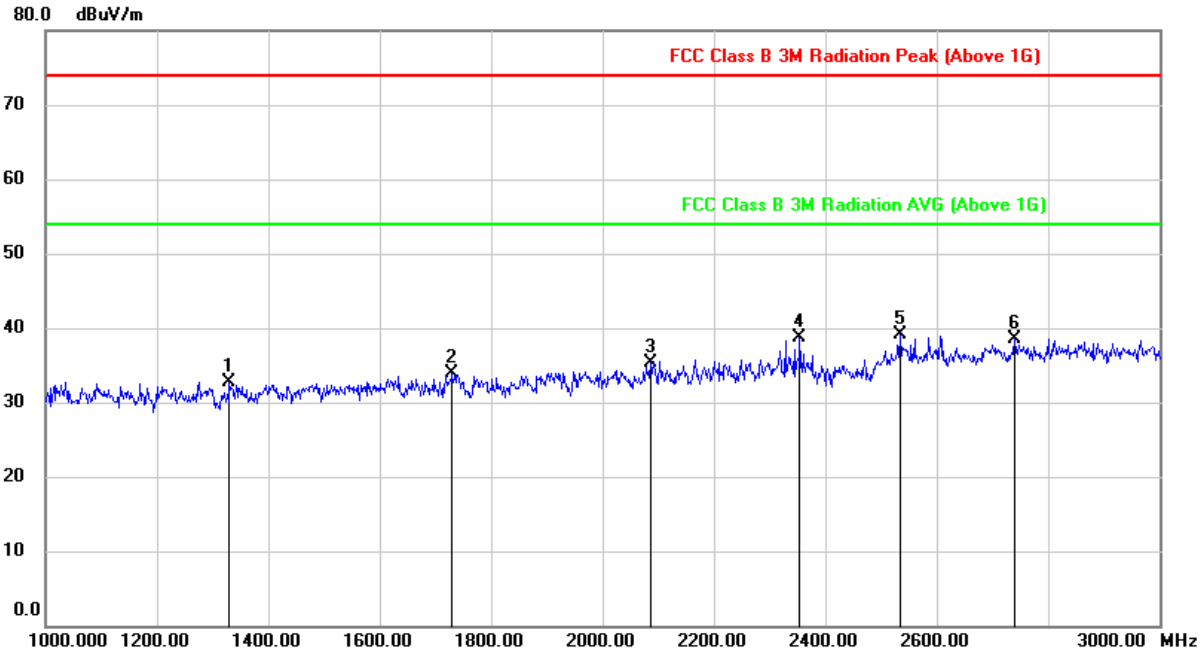

No.	Frequency (MHz)	Reading (dBuV)	Correct (dB/m)	Result (dBuV/m)	Limit (dBuV/m)	Margin (dB)	Remark
1	1330.000	44.18	-11.42	32.76	74.00	-41.24	peak
2	1730.000	44.15	-10.32	33.83	74.00	-40.17	peak
3	2086.000	43.85	-8.53	35.32	74.00	-38.68	peak
4	2354.000	46.07	-7.28	38.79	74.00	-35.21	peak
5	2534.000	45.63	-6.50	39.13	74.00	-34.87	peak
6	2740.000	45.05	-6.53	38.52	74.00	-35.48	peak

- Note: 1. Measurement = Reading Level + Correct Factor.
 2. If Peak Result complies with AV limit, AV Result is deemed to comply with AV limit.
 3. Peak: Peak detector.
 4. Filter losses were only considered in then spurious frequency bands and the authorized band was not corrected for BRF losses.
 5. Proper operation of the transmitter prior to adding the filter to the measurement chain.



HARMONICS AND SPURIOUS EMISSIONS (MID CHANNEL, HORIZONTAL)

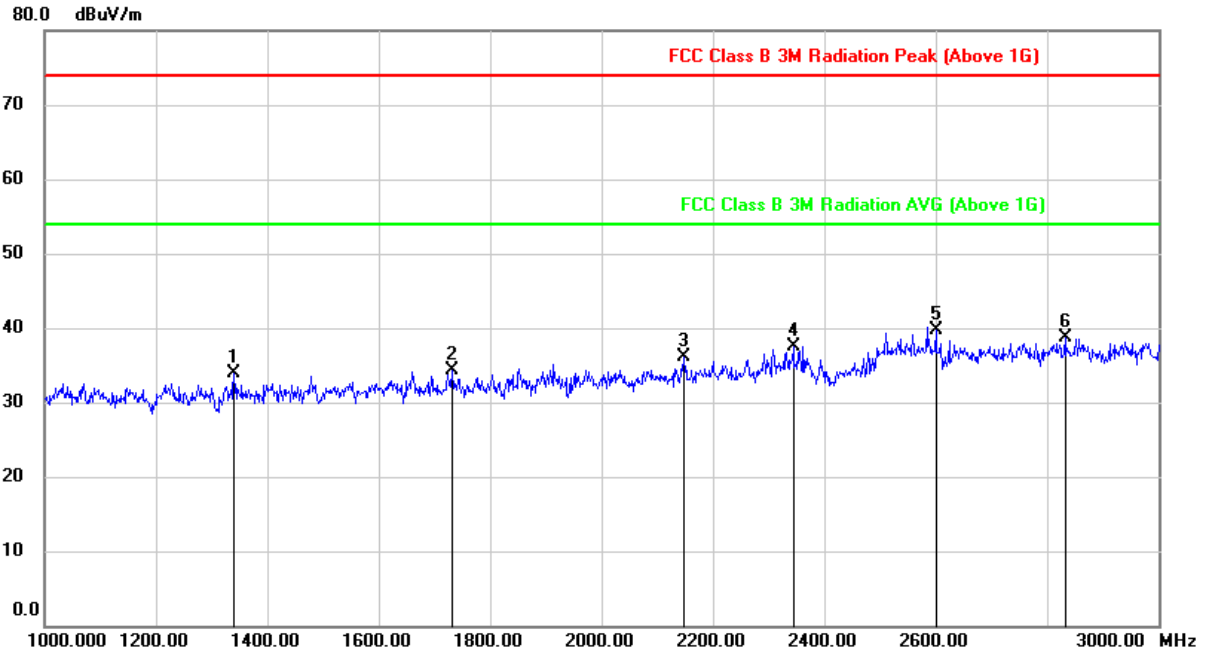

No.	Frequency (MHz)	Reading (dBuV)	Correct (dB/m)	Result (dBuV/m)	Limit (dBuV/m)	Margin (dB)	Remark
1	1340.000	45.31	-11.49	33.82	74.00	-40.18	peak
2	1732.000	44.61	-10.30	34.31	74.00	-39.69	peak
3	2148.000	44.40	-8.37	36.03	74.00	-37.97	peak
4	2344.000	44.89	-7.32	37.57	74.00	-36.43	peak
5	2600.000	46.48	-6.80	39.68	74.00	-34.32	peak
6	2832.000	43.78	-5.17	38.61	74.00	-35.39	peak

- Note: 1. Measurement = Reading Level + Correct Factor.
 2. If Peak Result complies with AV limit, AV Result is deemed to comply with AV limit.
 3. Peak: Peak detector.
 4. Filter losses were only considered in then spurious frequency bands and the authorized band was not corrected for BRF losses.
 5. Proper operation of the transmitter prior to adding the filter to the measurement chain.



HARMONICS AND SPURIOUS EMISSIONS (MID CHANNEL, VERTICAL)

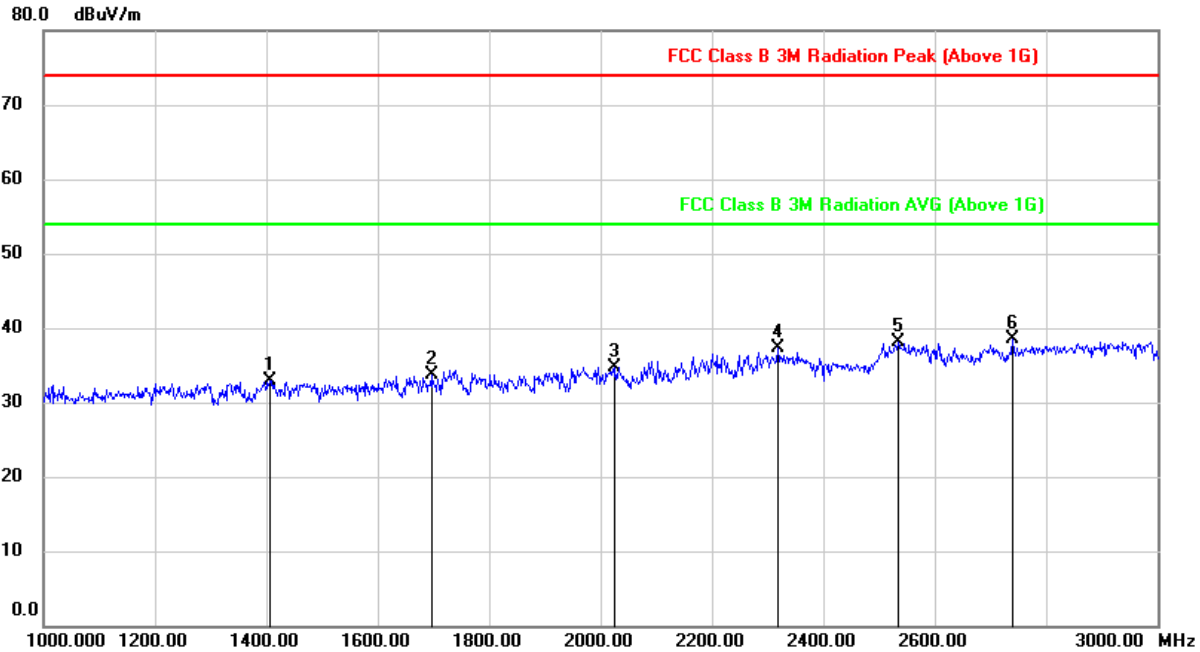

No.	Frequency (MHz)	Reading (dBuV)	Correct (dB/m)	Result (dBuV/m)	Limit (dBuV/m)	Margin (dB)	Remark
1	1406.000	44.75	-11.90	32.85	74.00	-41.15	peak
2	1696.000	44.35	-10.71	33.64	74.00	-40.36	peak
3	2026.000	44.12	-9.40	34.72	74.00	-39.28	peak
4	2318.000	44.80	-7.43	37.37	74.00	-36.63	peak
5	2534.000	44.63	-6.50	38.13	74.00	-35.87	peak
6	2740.000	45.05	-6.53	38.52	74.00	-35.48	peak

- Note: 1. Measurement = Reading Level + Correct Factor.
 2. If Peak Result complies with AV limit, AV Result is deemed to comply with AV limit.
 3. Peak: Peak detector.
 4. Filter losses were only considered in then spurious frequency bands and the authorized band was not corrected for BRF losses.
 5. Proper operation of the transmitter prior to adding the filter to the measurement chain.



HARMONICS AND SPURIOUS EMISSIONS (HIGH CHANNEL, HORIZONTAL)

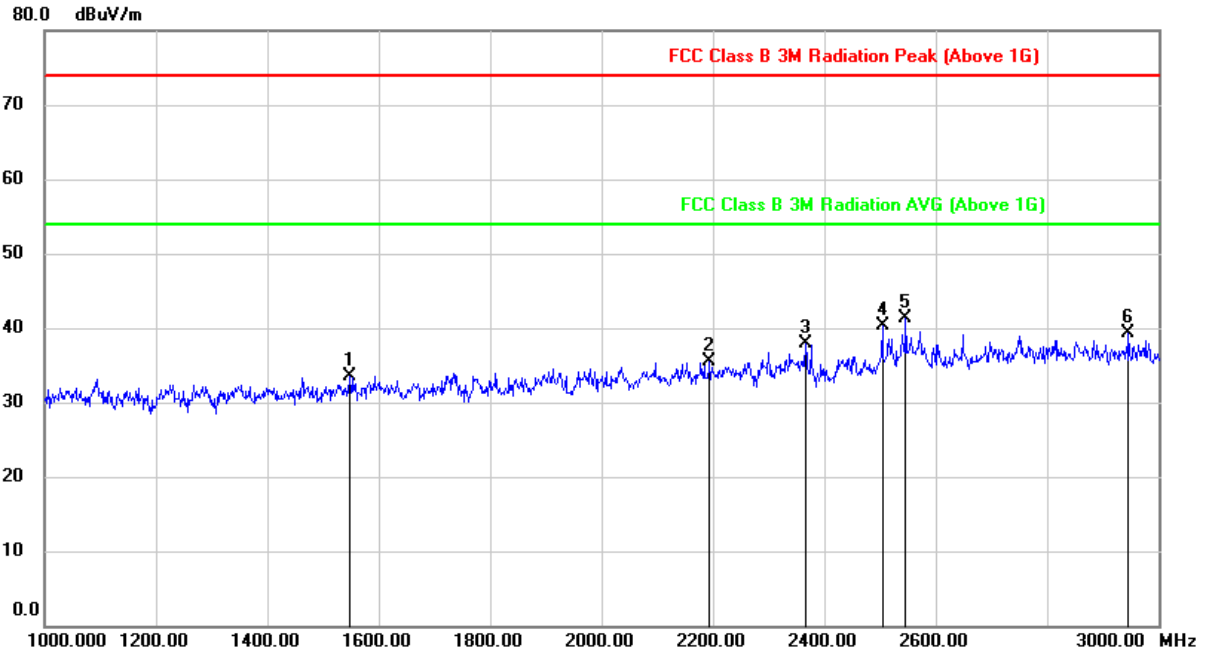

No.	Frequency (MHz)	Reading (dBuV)	Correct (dB/m)	Result (dBuV/m)	Limit (dBuV/m)	Margin (dB)	Remark
1	1548.000	44.56	-11.12	33.44	74.00	-40.56	peak
2	2194.000	43.92	-8.44	35.48	74.00	-38.52	peak
3	2366.000	45.15	-7.23	37.92	74.00	-36.08	peak
4	2504.000	46.57	-6.36	40.21	74.00	-33.79	peak
5	2546.000	47.89	-6.54	41.35	74.00	-32.65	peak
6	2946.000	44.15	-4.88	39.27	74.00	-34.73	peak

- Note: 1. Measurement = Reading Level + Correct Factor.
 2. If Peak Result complies with AV limit, AV Result is deemed to comply with AV limit.
 3. Peak: Peak detector.
 4. Filter losses were only considered in then spurious frequency bands and the authorized band was not corrected for BRF losses.
 5. Proper operation of the transmitter prior to adding the filter to the measurement chain.



HARMONICS AND SPURIOUS EMISSIONS (HIGH CHANNEL, VERTICAL)

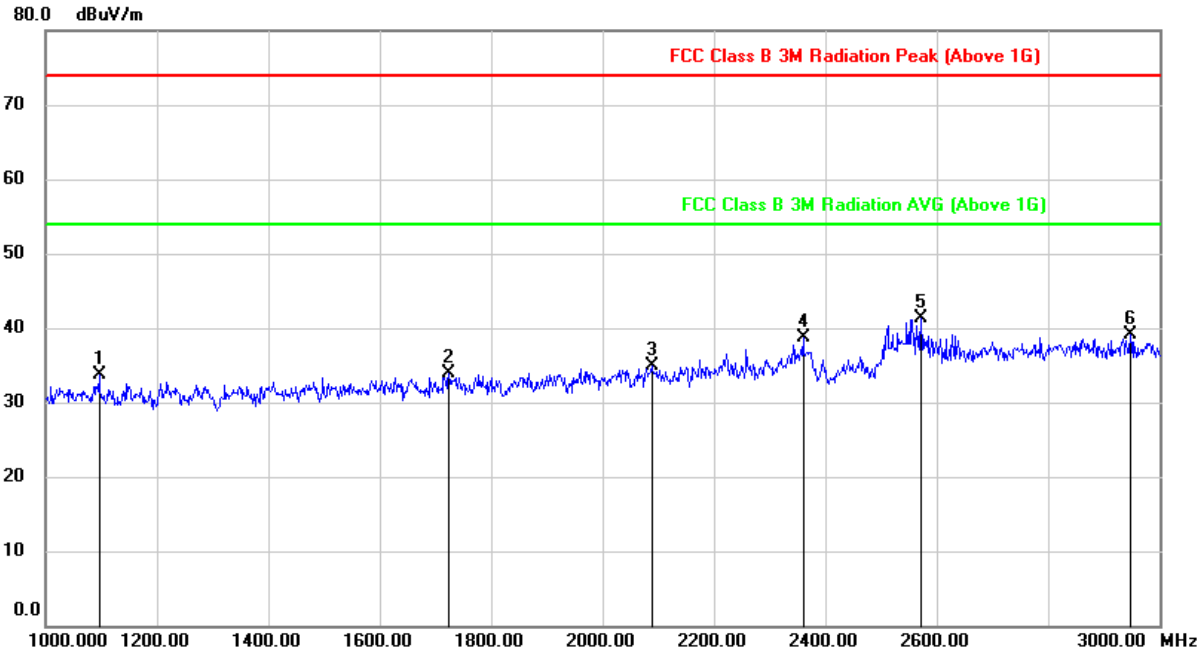

No.	Frequency (MHz)	Reading (dBuV)	Correct (dB/m)	Result (dBuV/m)	Limit (dBuV/m)	Margin (dB)	Remark
1	1096.000	46.31	-12.62	33.69	74.00	-40.31	peak
2	1724.000	44.37	-10.40	33.97	74.00	-40.03	peak
3	2088.000	43.43	-8.50	34.93	74.00	-39.07	peak
4	2360.000	45.92	-7.26	38.66	74.00	-35.34	peak
5	2572.000	48.07	-6.67	41.40	74.00	-32.60	peak
6	2948.000	43.95	-4.88	39.07	74.00	-34.93	peak

- Note: 1. Measurement = Reading Level + Correct Factor.
 2. If Peak Result complies with AV limit, AV Result is deemed to comply with AV limit.
 3. Peak: Peak detector.
 4. Filter losses were only considered in then spurious frequency bands and the authorized band was not corrected for BRF losses.
 5. Proper operation of the transmitter prior to adding the filter to the measurement chain.

Note: All antennas have been tested, only the worst data record in the report.



9.3.3. 802.11n HT20 MODE

HARMONICS AND SPURIOUS EMISSIONS (LOW CHANNEL, HORIZONTAL)

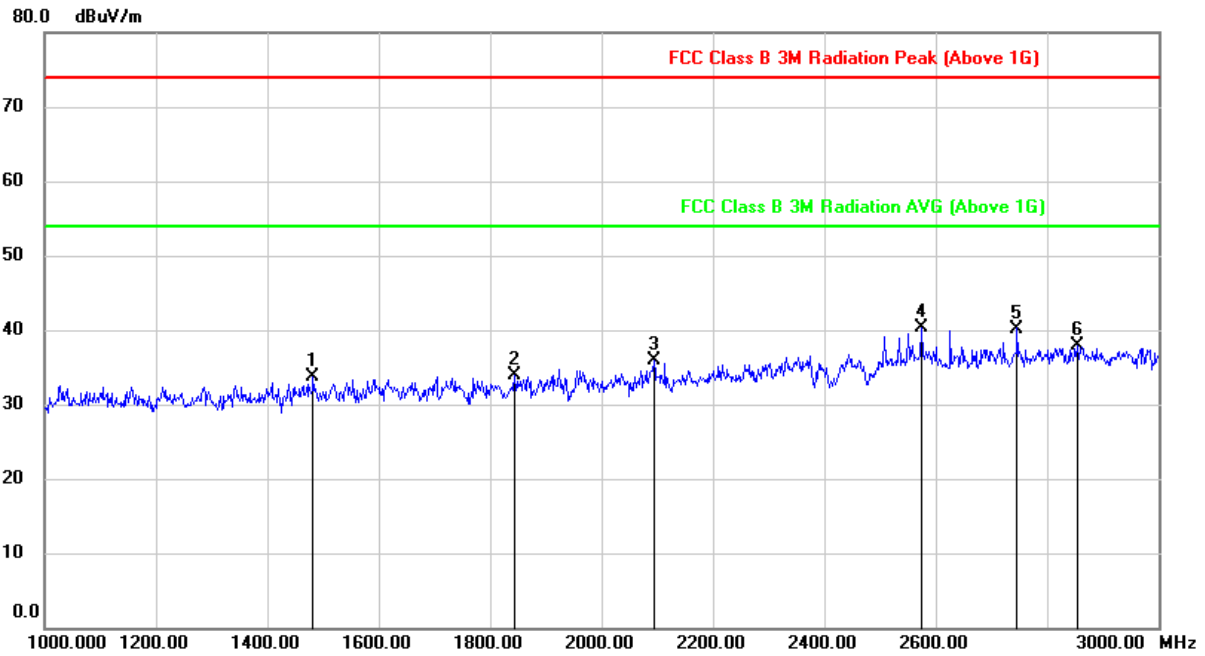

No.	Frequency (MHz)	Reading (dBuV)	Correct (dB/m)	Result (dBuV/m)	Limit (dBuV/m)	Margin (dB)	Remark
1	1482.000	45.33	-11.66	33.67	74.00	-40.33	peak
2	1844.000	43.29	-9.36	33.93	74.00	-40.07	peak
3	2094.000	44.27	-8.40	35.87	74.00	-38.13	peak
4	2574.000	46.89	-6.68	40.21	74.00	-33.79	peak
5	2746.000	46.60	-6.40	40.20	74.00	-33.80	peak
6	2854.000	43.01	-5.18	37.83	74.00	-36.17	peak

- Note: 1. Measurement = Reading Level + Correct Factor.
 2. If Peak Result complies with AV limit, AV Result is deemed to comply with AV limit.
 3. Peak: Peak detector.
 4. Filter losses were only considered in then spurious frequency bands and the authorized band was not corrected for BRF losses.
 5. Proper operation of the transmitter prior to adding the filter to the measurement chain.



HARMONICS AND SPURIOUS EMISSIONS (LOW CHANNEL, VERTICAL)

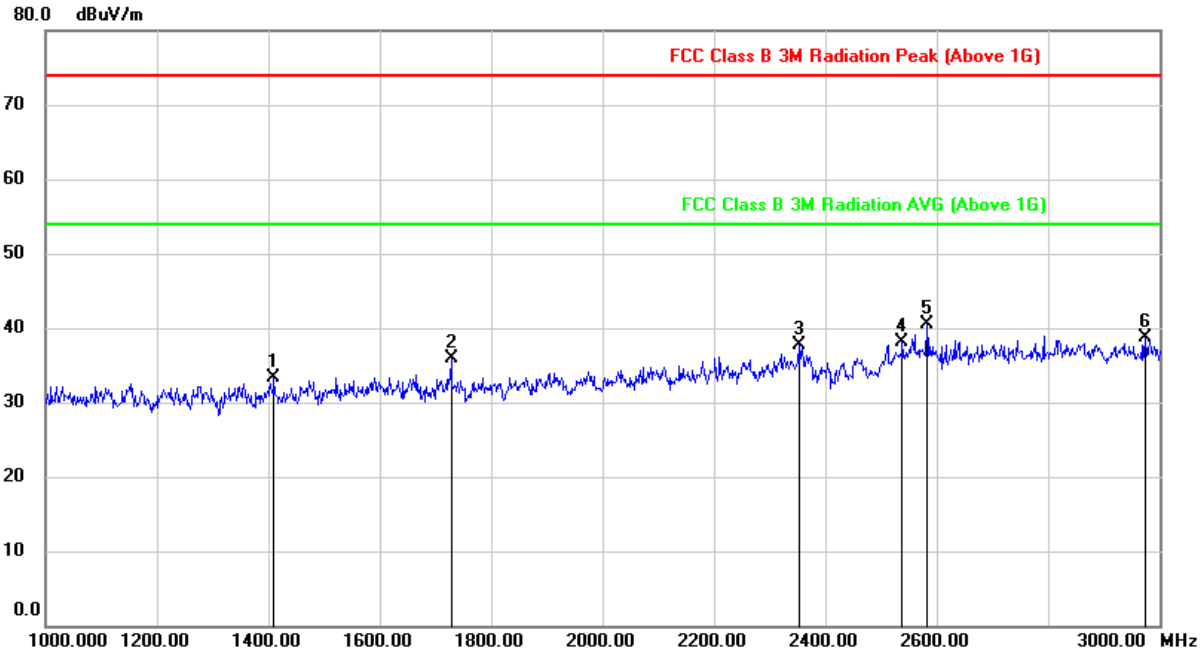

No.	Frequency (MHz)	Reading (dBuV)	Correct (dB/m)	Result (dBuV/m)	Limit (dBuV/m)	Margin (dB)	Remark
1	1410.000	45.17	-11.89	33.28	74.00	-40.72	peak
2	1728.000	46.15	-10.34	35.81	74.00	-38.19	peak
3	2352.000	44.99	-7.29	37.70	74.00	-36.30	peak
4	2538.000	44.59	-6.51	38.08	74.00	-35.92	peak
5	2582.000	47.31	-6.72	40.59	74.00	-33.41	peak
6	2974.000	43.50	-4.73	38.77	74.00	-35.23	peak

- Note: 1. Measurement = Reading Level + Correct Factor.
 2. If Peak Result complies with AV limit, AV Result is deemed to comply with AV limit.
 3. Peak: Peak detector.
 4. Filter losses were only considered in then spurious frequency bands and the authorized band was not corrected for BRF losses.
 5. Proper operation of the transmitter prior to adding the filter to the measurement chain.



HARMONICS AND SPURIOUS EMISSIONS (MID CHANNEL, HORIZONTAL)

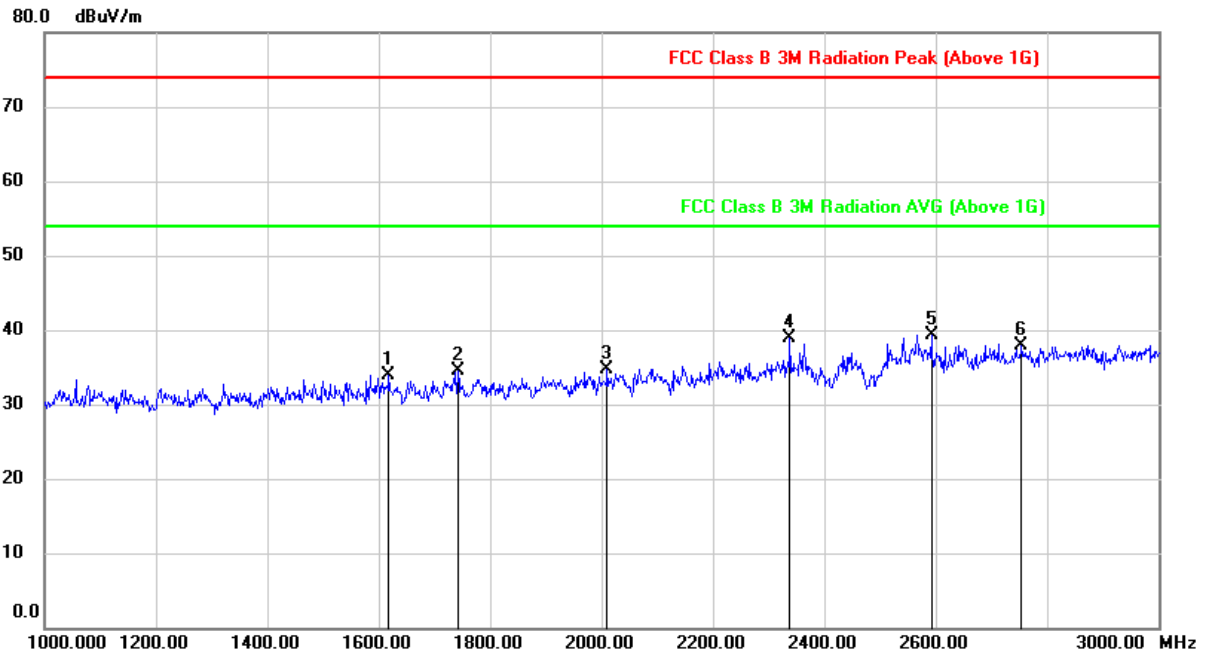

No.	Frequency (MHz)	Reading (dBuV)	Correct (dB/m)	Result (dBuV/m)	Limit (dBuV/m)	Margin (dB)	Remark
1	1618.000	44.56	-10.62	33.94	74.00	-40.06	peak
2	1742.000	44.61	-10.16	34.45	74.00	-39.55	peak
3	2010.000	44.29	-9.63	34.66	74.00	-39.34	peak
4	2338.000	46.30	-7.34	38.96	74.00	-35.04	peak
5	2592.000	46.01	-6.77	39.24	74.00	-34.76	peak
6	2754.000	44.19	-6.22	37.97	74.00	-36.03	peak

- Note: 1. Measurement = Reading Level + Correct Factor.
 2. If Peak Result complies with AV limit, AV Result is deemed to comply with AV limit.
 3. Peak: Peak detector.
 4. Filter losses were only considered in then spurious frequency bands and the authorized band was not corrected for BRF losses.
 5. Proper operation of the transmitter prior to adding the filter to the measurement chain.



HARMONICS AND SPURIOUS EMISSIONS (MID CHANNEL, VERTICAL)

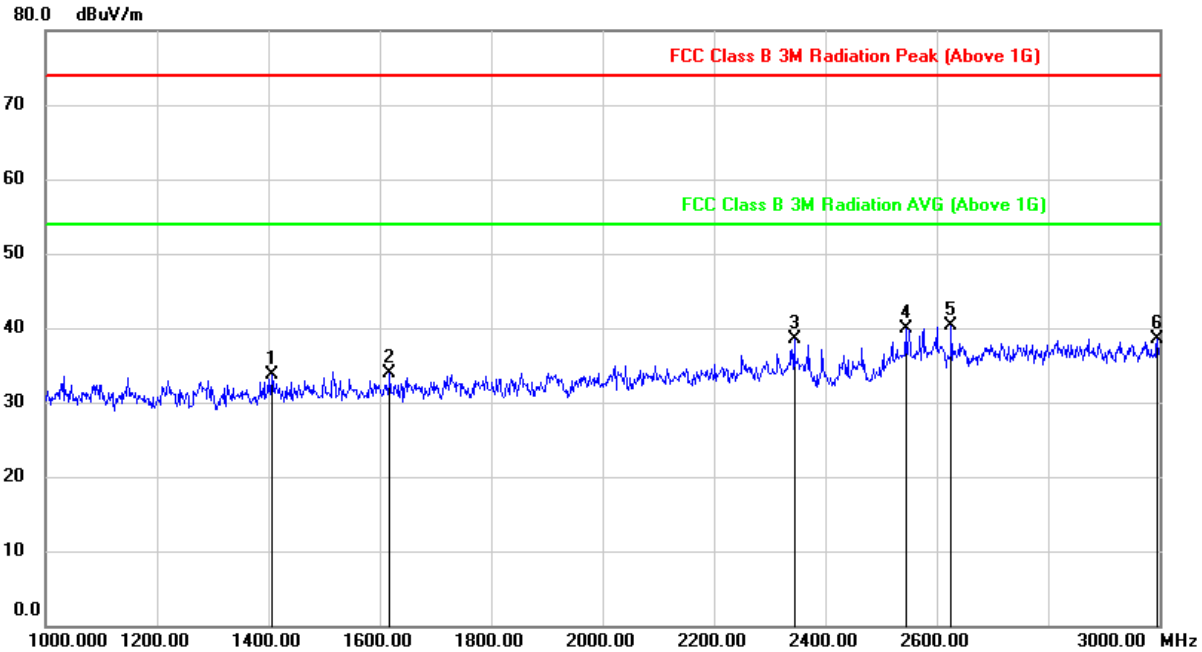

No.	Frequency (MHz)	Reading (dBuV)	Correct (dB/m)	Result (dBuV/m)	Limit (dBuV/m)	Margin (dB)	Remark
1	1406.000	45.54	-11.90	33.64	74.00	-40.36	peak
2	1618.000	44.50	-10.62	33.88	74.00	-40.12	peak
3	2344.000	45.80	-7.32	38.48	74.00	-35.52	peak
4	2544.000	46.51	-6.54	39.97	74.00	-34.03	peak
5	2626.000	47.24	-6.96	40.28	74.00	-33.72	peak
6	2996.000	43.18	-4.60	38.58	74.00	-35.42	peak

- Note: 1. Measurement = Reading Level + Correct Factor.
 2. If Peak Result complies with AV limit, AV Result is deemed to comply with AV limit.
 3. Peak: Peak detector.
 4. Filter losses were only considered in then spurious frequency bands and the authorized band was not corrected for BRF losses.
 5. Proper operation of the transmitter prior to adding the filter to the measurement chain.



HARMONICS AND SPURIOUS EMISSIONS (HIGH CHANNEL, HORIZONTAL)

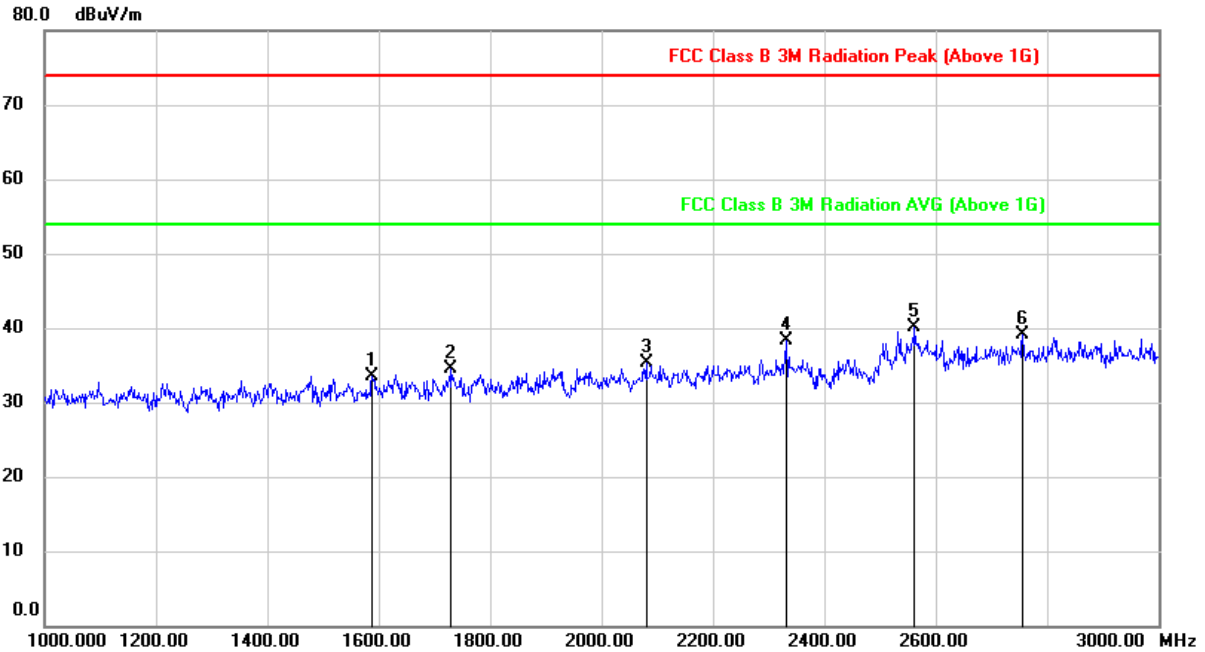

No.	Frequency (MHz)	Reading (dBuV)	Correct (dB/m)	Result (dBuV/m)	Limit (dBuV/m)	Margin (dB)	Remark
1	1588.000	44.33	-10.73	33.60	74.00	-40.40	peak
2	1730.000	44.76	-10.32	34.44	74.00	-39.56	peak
3	2080.000	43.86	-8.61	35.25	74.00	-38.75	peak
4	2332.000	45.67	-7.37	38.30	74.00	-35.70	peak
5	2562.000	46.76	-6.63	40.13	74.00	-33.87	peak
6	2756.000	45.26	-6.18	39.08	74.00	-34.92	peak

- Note: 1. Measurement = Reading Level + Correct Factor.
 2. If Peak Result complies with AV limit, AV Result is deemed to comply with AV limit.
 3. Peak: Peak detector.
 4. Filter losses were only considered in then spurious frequency bands and the authorized band was not corrected for BRF losses.
 5. Proper operation of the transmitter prior to adding the filter to the measurement chain.



HARMONICS AND SPURIOUS EMISSIONS (HIGH CHANNEL, VERTICAL)

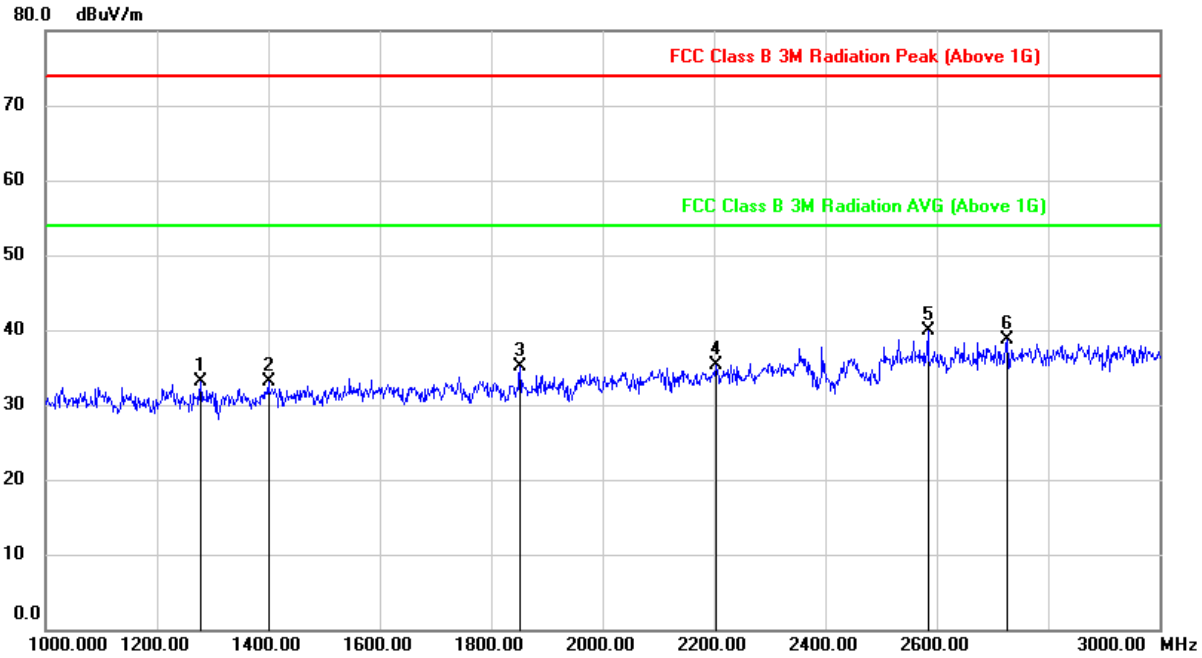

No.	Frequency (MHz)	Reading (dBuV)	Correct (dB/m)	Result (dBuV/m)	Limit (dBuV/m)	Margin (dB)	Remark
1	1278.000	44.61	-11.48	33.13	74.00	-40.87	peak
2	1400.000	45.06	-11.92	33.14	74.00	-40.86	peak
3	1852.000	44.46	-9.36	35.10	74.00	-38.90	peak
4	2204.000	43.78	-8.40	35.38	74.00	-38.62	peak
5	2584.000	46.64	-6.73	39.91	74.00	-34.09	peak
6	2726.000	45.50	-6.84	38.66	74.00	-35.34	peak

- Note: 1. Measurement = Reading Level + Correct Factor.
 2. If Peak Result complies with AV limit, AV Result is deemed to comply with AV limit.
 3. Peak: Peak detector.
 4. Filter losses were only considered in then spurious frequency bands and the authorized band was not corrected for BRF losses.
 5. Proper operation of the transmitter prior to adding the filter to the measurement chain.

Note: All antennas have been tested, only the worst data record in the report.



9.3.4. 802.11n HT40 MODE

HARMONICS AND SPURIOUS EMISSIONS (LOW CHANNEL, HORIZONTAL)

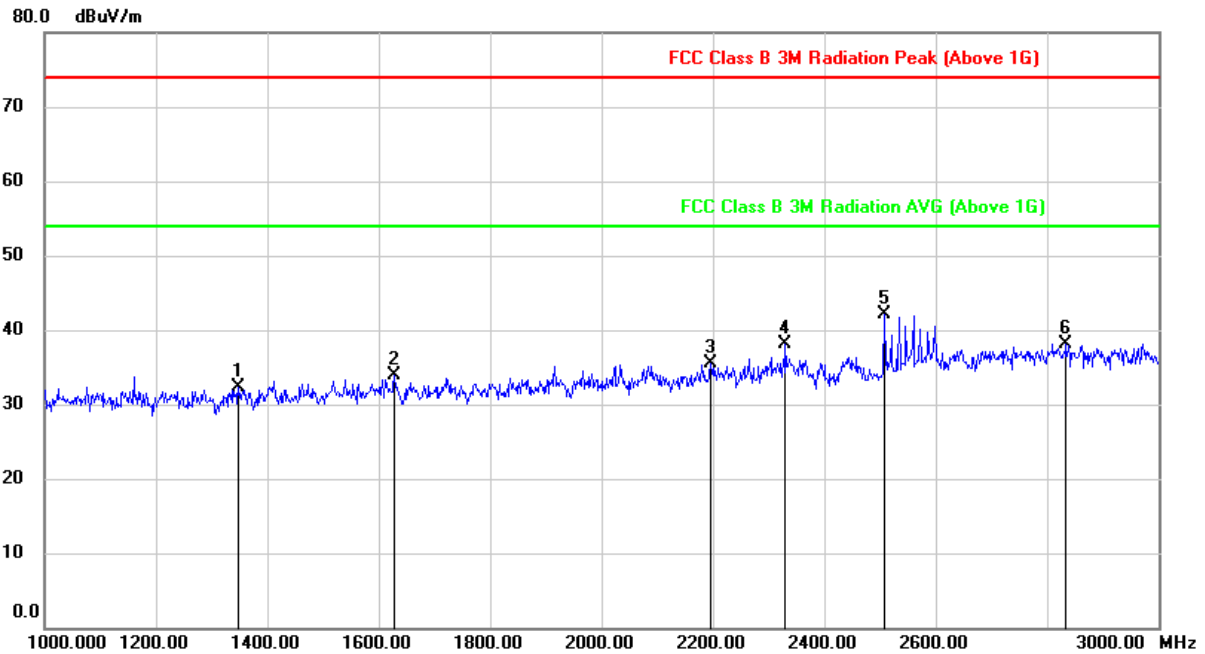

No.	Frequency (MHz)	Reading (dBuV)	Correct (dB/m)	Result (dBuV/m)	Limit (dBuV/m)	Margin (dB)	Remark
1	1348.000	43.92	-11.54	32.38	74.00	-41.62	peak
2	1628.000	44.52	-10.63	33.89	74.00	-40.11	peak
3	2196.000	43.92	-8.44	35.48	74.00	-38.52	peak
4	2330.000	45.47	-7.38	38.09	74.00	-35.91	peak
5	2508.000	48.56	-6.37	42.19	74.00	-31.81	peak
6	2834.000	43.20	-5.18	38.02	74.00	-35.98	peak

- Note: 1. Measurement = Reading Level + Correct Factor.
 2. If Peak Result complies with AV limit, AV Result is deemed to comply with AV limit.
 3. Peak: Peak detector.
 4. Filter losses were only considered in then spurious frequency bands and the authorized band was not corrected for BRF losses.
 5. Proper operation of the transmitter prior to adding the filter to the measurement chain.



HARMONICS AND SPURIOUS EMISSIONS (LOW CHANNEL, VERTICAL)

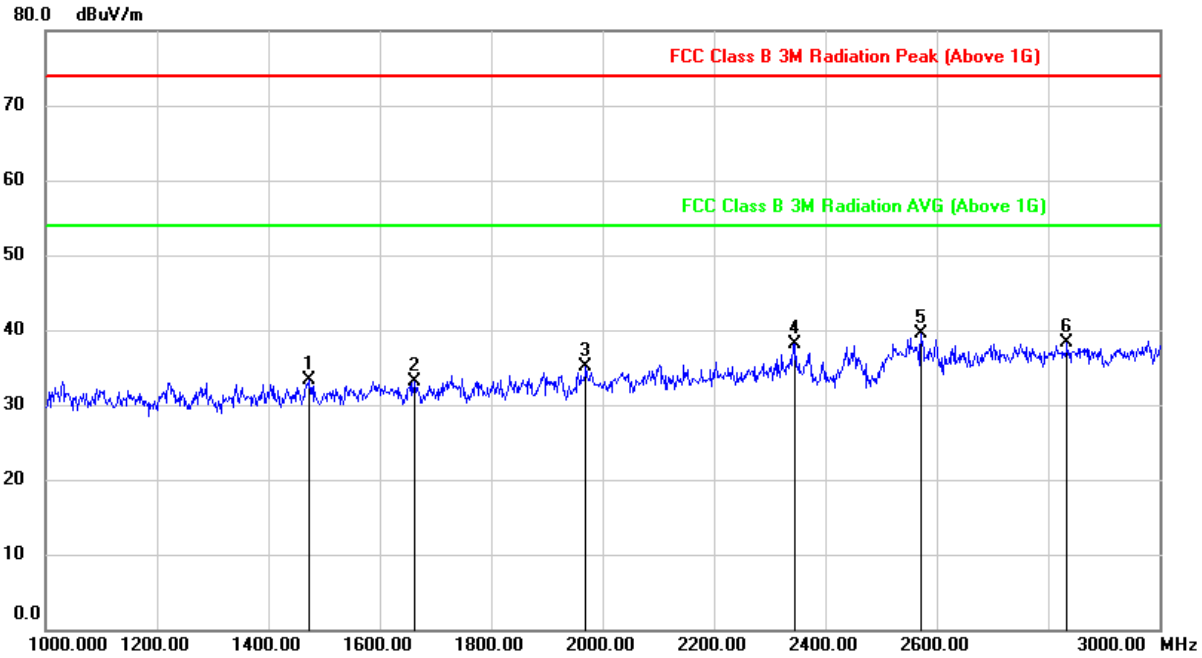

No.	Frequency (MHz)	Reading (dBuV)	Correct (dB/m)	Result (dBuV/m)	Limit (dBuV/m)	Margin (dB)	Remark
1	1474.000	44.97	-11.69	33.28	74.00	-40.72	peak
2	1662.000	43.81	-10.67	33.14	74.00	-40.86	peak
3	1970.000	44.77	-9.64	35.13	74.00	-38.87	peak
4	2346.000	45.47	-7.32	38.15	74.00	-35.85	peak
5	2572.000	46.12	-6.67	39.45	74.00	-34.55	peak
6	2834.000	43.51	-5.18	38.33	74.00	-35.67	peak

- Note: 1. Measurement = Reading Level + Correct Factor.
 2. If Peak Result complies with AV limit, AV Result is deemed to comply with AV limit.
 3. Peak: Peak detector.
 4. Filter losses were only considered in then spurious frequency bands and the authorized band was not corrected for BRF losses.
 5. Proper operation of the transmitter prior to adding the filter to the measurement chain.



HARMONICS AND SPURIOUS EMISSIONS (MID CHANNEL, HORIZONTAL)

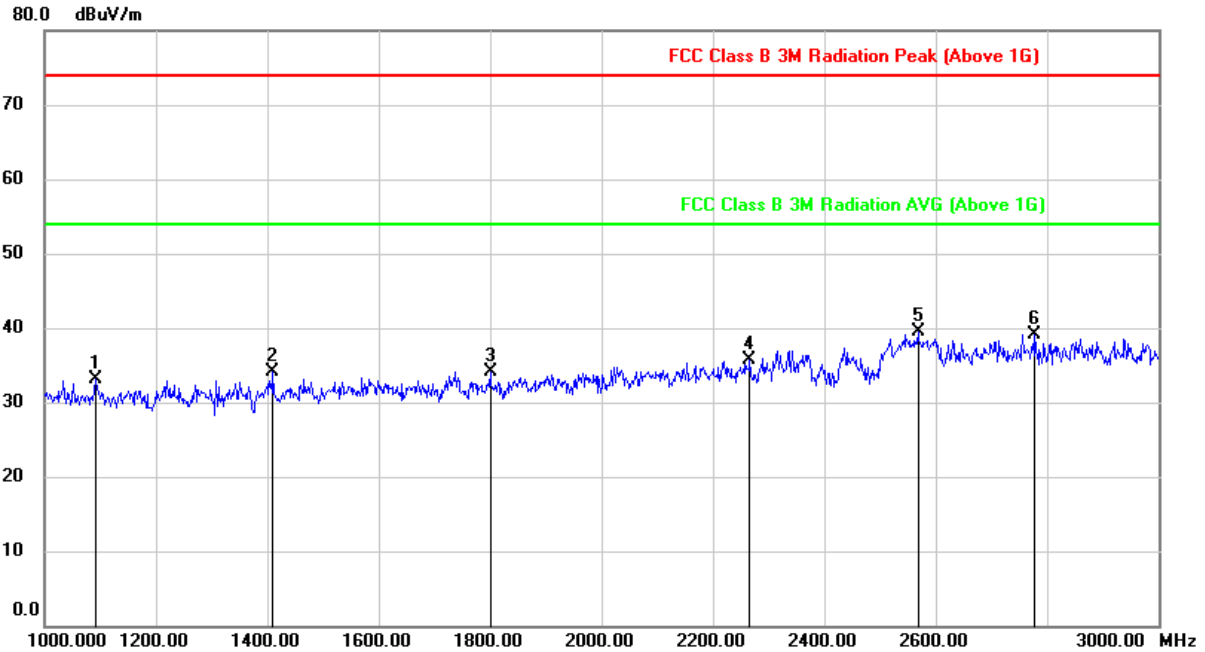

No.	Frequency (MHz)	Reading (dBuV)	Correct (dB/m)	Result (dBuV/m)	Limit (dBuV/m)	Margin (dB)	Remark
1	1092.000	45.82	-12.64	33.18	74.00	-40.82	peak
2	1410.000	46.06	-11.89	34.17	74.00	-39.83	peak
3	1800.000	43.62	-9.42	34.20	74.00	-39.80	peak
4	2266.000	43.52	-7.82	35.70	74.00	-38.30	peak
5	2568.000	46.14	-6.66	39.48	74.00	-34.52	peak
6	2778.000	44.81	-5.68	39.13	74.00	-34.87	peak

- Note: 1. Measurement = Reading Level + Correct Factor.
 2. If Peak Result complies with AV limit, AV Result is deemed to comply with AV limit.
 3. Peak: Peak detector.
 4. Filter losses were only considered in then spurious frequency bands and the authorized band was not corrected for BRF losses.
 5. Proper operation of the transmitter prior to adding the filter to the measurement chain.



HARMONICS AND SPURIOUS EMISSIONS (MID CHANNEL, VERTICAL)

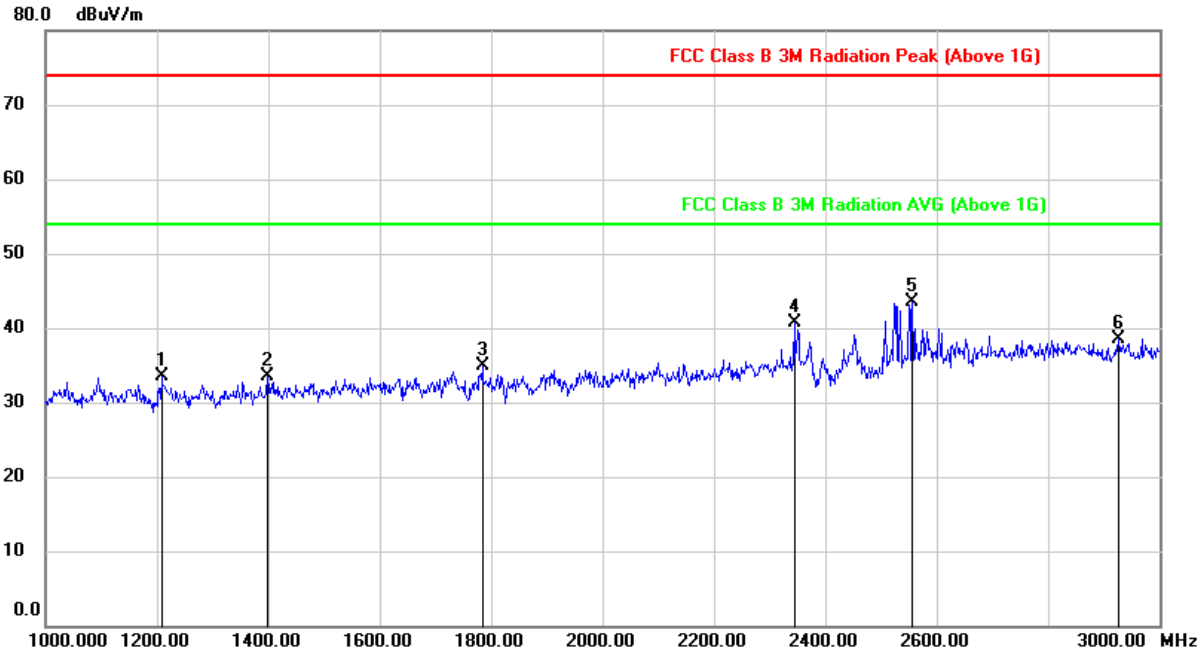

No.	Frequency (MHz)	Reading (dBuV)	Correct (dB/m)	Result (dBuV/m)	Limit (dBuV/m)	Margin (dB)	Remark
1	1208.000	45.87	-12.35	33.52	74.00	-40.48	peak
2	1398.000	45.49	-11.90	33.59	74.00	-40.41	peak
3	1784.000	44.49	-9.63	34.86	74.00	-39.14	peak
4	2344.000	48.02	-7.32	40.70	74.00	-33.30	peak
5	2556.000	50.11	-6.59	43.52	74.00	-30.48	peak
6	2926.000	43.59	-5.00	38.59	74.00	-35.41	peak

- Note: 1. Measurement = Reading Level + Correct Factor.
 2. If Peak Result complies with AV limit, AV Result is deemed to comply with AV limit.
 3. Peak: Peak detector.
 4. Filter losses were only considered in then spurious frequency bands and the authorized band was not corrected for BRF losses.
 5. Proper operation of the transmitter prior to adding the filter to the measurement chain.



HARMONICS AND SPURIOUS EMISSIONS (HIGH CHANNEL, HORIZONTAL)

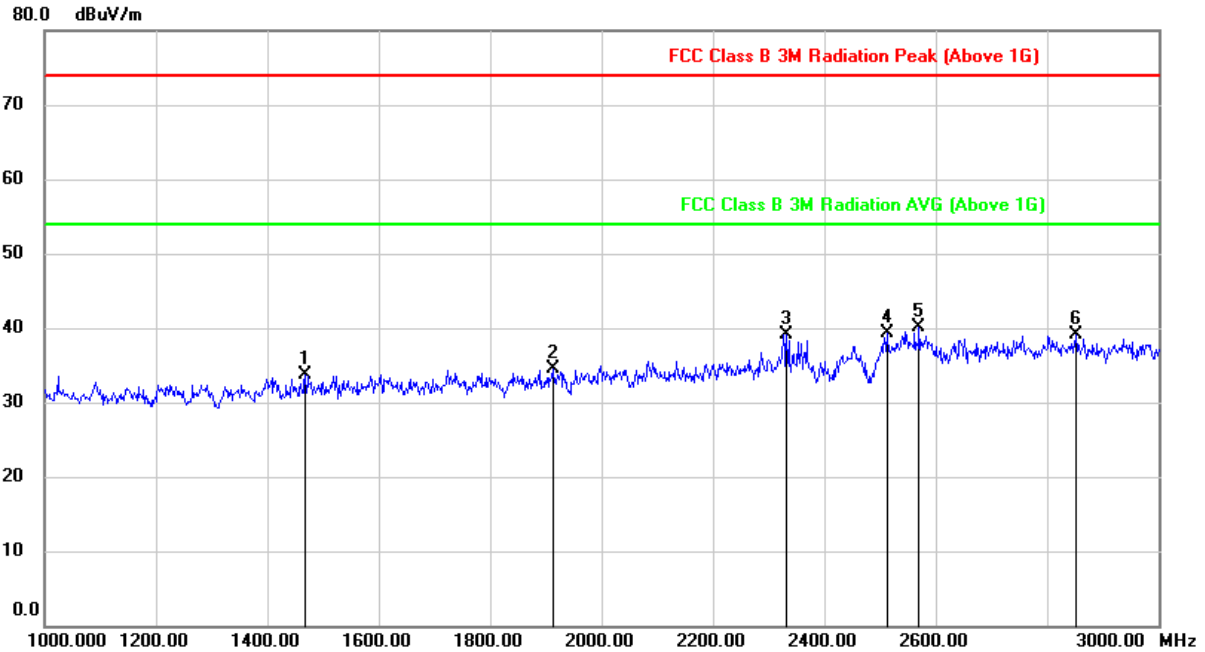

No.	Frequency (MHz)	Reading (dBuV)	Correct (dB/m)	Result (dBuV/m)	Limit (dBuV/m)	Margin (dB)	Remark
1	1468.000	45.33	-11.71	33.62	74.00	-40.38	peak
2	1912.000	43.77	-9.35	34.42	74.00	-39.58	peak
3	2332.000	46.53	-7.37	39.16	74.00	-34.84	peak
4	2512.000	45.74	-6.40	39.34	74.00	-34.66	peak
5	2570.000	46.79	-6.66	40.13	74.00	-33.87	peak
6	2852.000	44.18	-5.17	39.01	74.00	-34.99	peak

- Note: 1. Measurement = Reading Level + Correct Factor.
 2. If Peak Result complies with AV limit, AV Result is deemed to comply with AV limit.
 3. Peak: Peak detector.
 4. Filter losses were only considered in then spurious frequency bands and the authorized band was not corrected for BRF losses.
 5. Proper operation of the transmitter prior to adding the filter to the measurement chain.



HARMONICS AND SPURIOUS EMISSIONS (HIGH CHANNEL, VERTICAL)

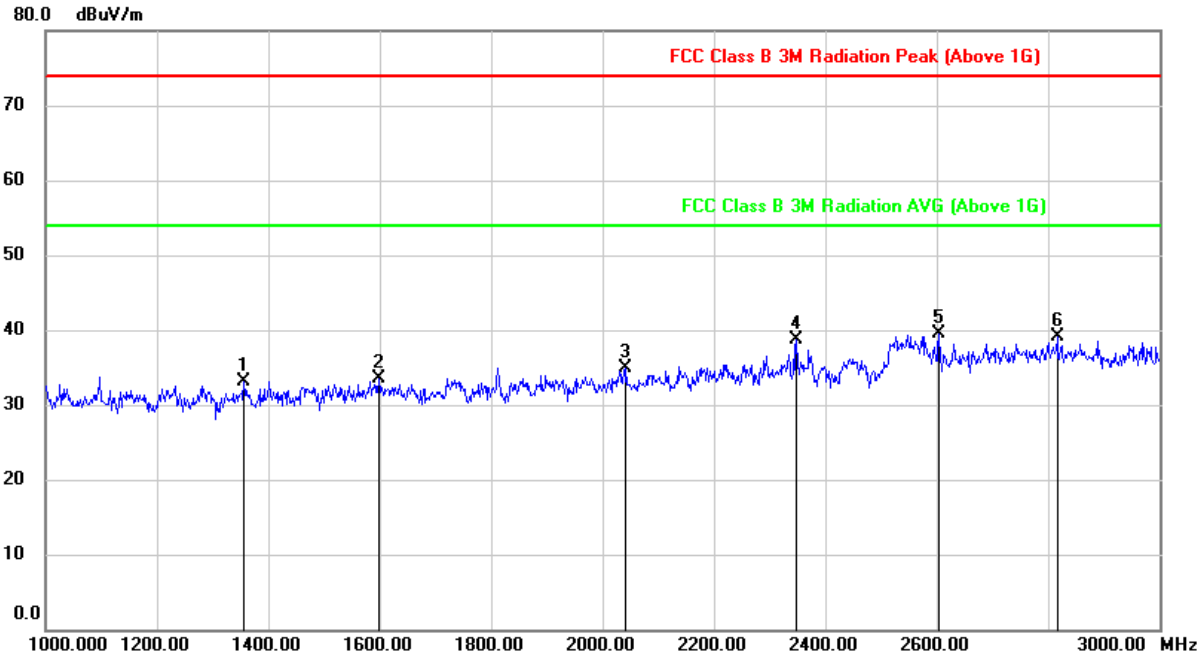

No.	Frequency (MHz)	Reading (dBuV)	Correct (dB/m)	Result (dBuV/m)	Limit (dBuV/m)	Margin (dB)	Remark
1	1356.000	44.75	-11.61	33.14	74.00	-40.86	peak
2	1598.000	44.16	-10.63	33.53	74.00	-40.47	peak
3	2042.000	44.15	-9.16	34.99	74.00	-39.01	peak
4	2348.000	45.98	-7.31	38.67	74.00	-35.33	peak
5	2604.000	46.31	-6.83	39.48	74.00	-34.52	peak
6	2816.000	44.19	-5.18	39.01	74.00	-34.99	peak

- Note: 1. Measurement = Reading Level + Correct Factor.
 2. If Peak Result complies with AV limit, AV Result is deemed to comply with AV limit.
 3. Peak: Peak detector.
 4. Filter losses were only considered in then spurious frequency bands and the authorized band was not corrected for BRF losses.
 5. Proper operation of the transmitter prior to adding the filter to the measurement chain.

Note: All antennas have been tested, only the worst data record in the report.



9.4. SPURIOUS EMISSIONS (18~26GHz)

9.4.1. 802.11n HT20 MIMO MODE

SPURIOUS EMISSIONS (MID CHANNEL, WORST-CASE CONFIGURATION, HORIZONTAL)

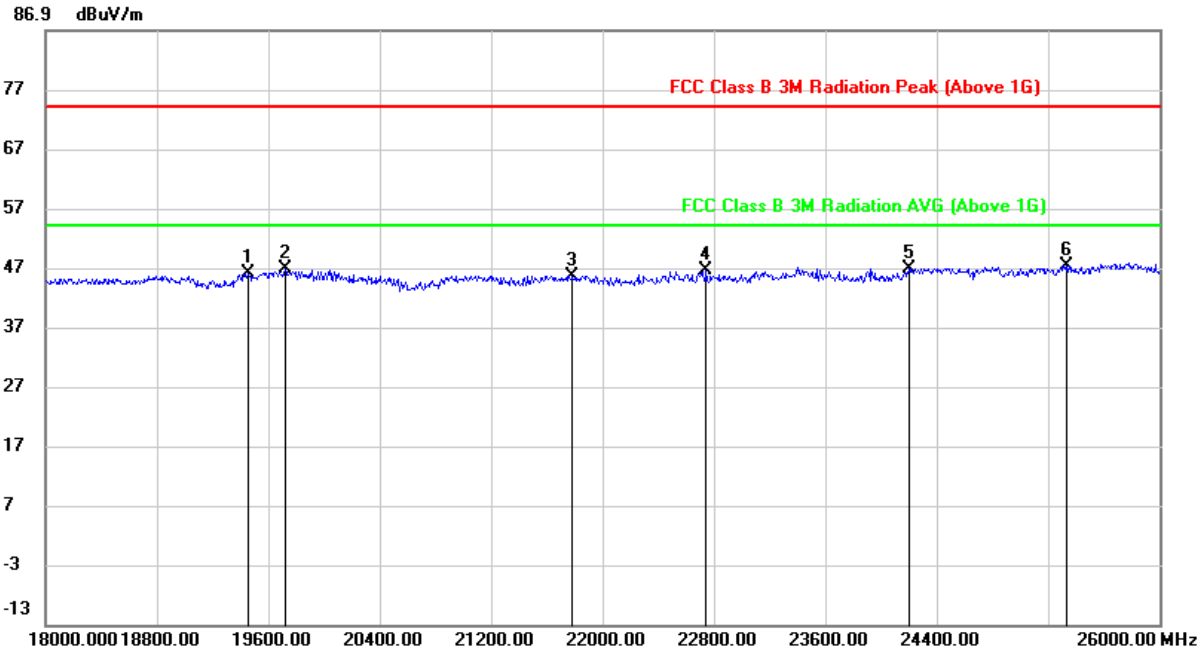

No.	Frequency (MHz)	Reading (dBuV)	Correct (dB/m)	Result (dBuV/m)	Limit (dBuV/m)	Margin (dB)	Remark
1	19456.000	50.94	-4.84	46.10	74.00	-27.90	peak
2	19720.000	51.08	-4.39	46.69	74.00	-27.31	peak
3	21784.000	51.46	-5.82	45.64	74.00	-28.36	peak
4	22744.000	52.18	-5.74	46.44	74.00	-27.56	peak
5	24200.000	50.56	-3.67	46.89	74.00	-27.11	peak
6	25328.000	48.76	-1.38	47.38	74.00	-26.62	peak

- Note: 1. Measurement = Reading Level + Correct Factor.
 2. If Peak Result complies with AV limit, AV Result is deemed to comply with AV limit.
 3. Peak: Peak detector.
 4. Proper operation of the transmitter prior to adding the filter to the measurement chain.



SPURIOUS EMISSIONS (MID CHANNEL, WORST-CASE CONFIGURATION, VERTICAL)

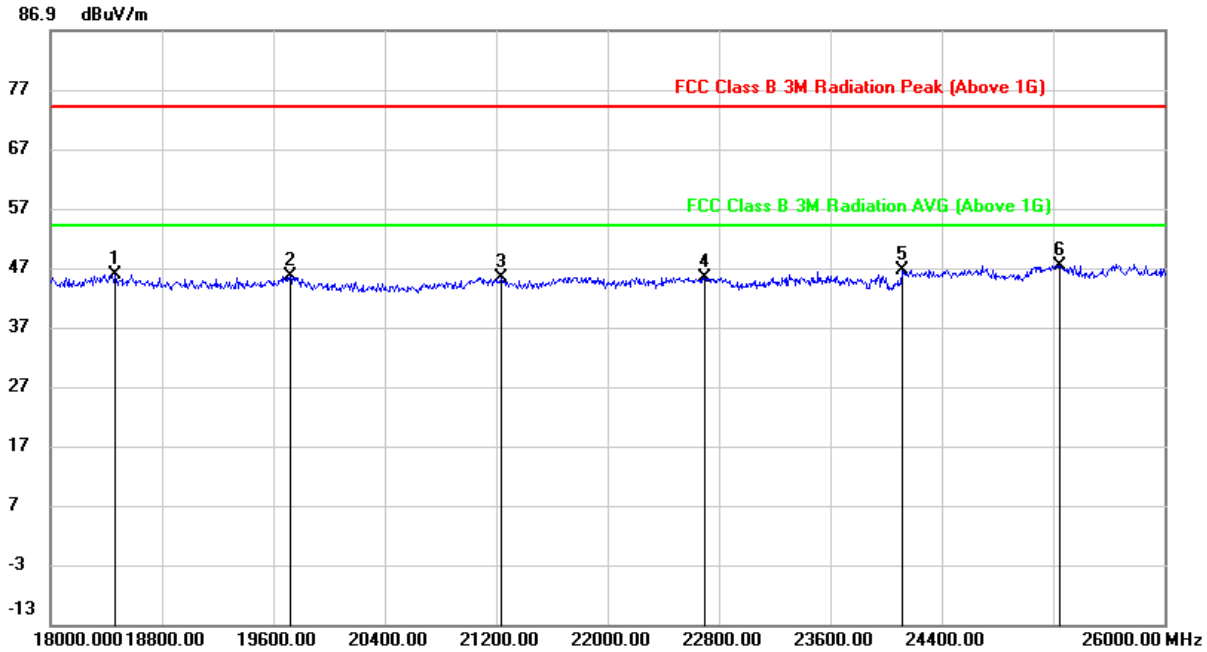

No.	Frequency (MHz)	Reading (dBuV)	Correct (dB/m)	Result (dBuV/m)	Limit (dBuV/m)	Margin (dB)	Remark
1	18464.000	50.20	-4.39	45.81	74.00	-28.19	peak
2	19720.000	50.00	-4.39	45.61	74.00	-28.39	peak
3	21232.000	50.88	-5.49	45.39	74.00	-28.61	peak
4	22696.000	51.13	-5.75	45.38	74.00	-28.62	peak
5	24120.000	50.28	-3.81	46.47	74.00	-27.53	peak
6	25248.000	48.55	-1.17	47.38	74.00	-26.62	peak

- Note:
1. Measurement = Reading Level + Correct Factor.
 2. If Peak Result complies with AV limit, AV Result is deemed to comply with AV limit.
 3. Peak: Peak detector.
 4. Proper operation of the transmitter prior to adding the filter to the measurement chain.

Note: All antennas and test modes have been tested, only the worst data record in the report.



9.5. SPURIOUS EMISSIONS (0.03 ~ 1 GHz)

9.5.1. 802.11n HT20 MIMO MODE

SPURIOUS EMISSIONS (MID CHANNEL, WORST-CASE CONFIGURATION, HORIZONTAL)

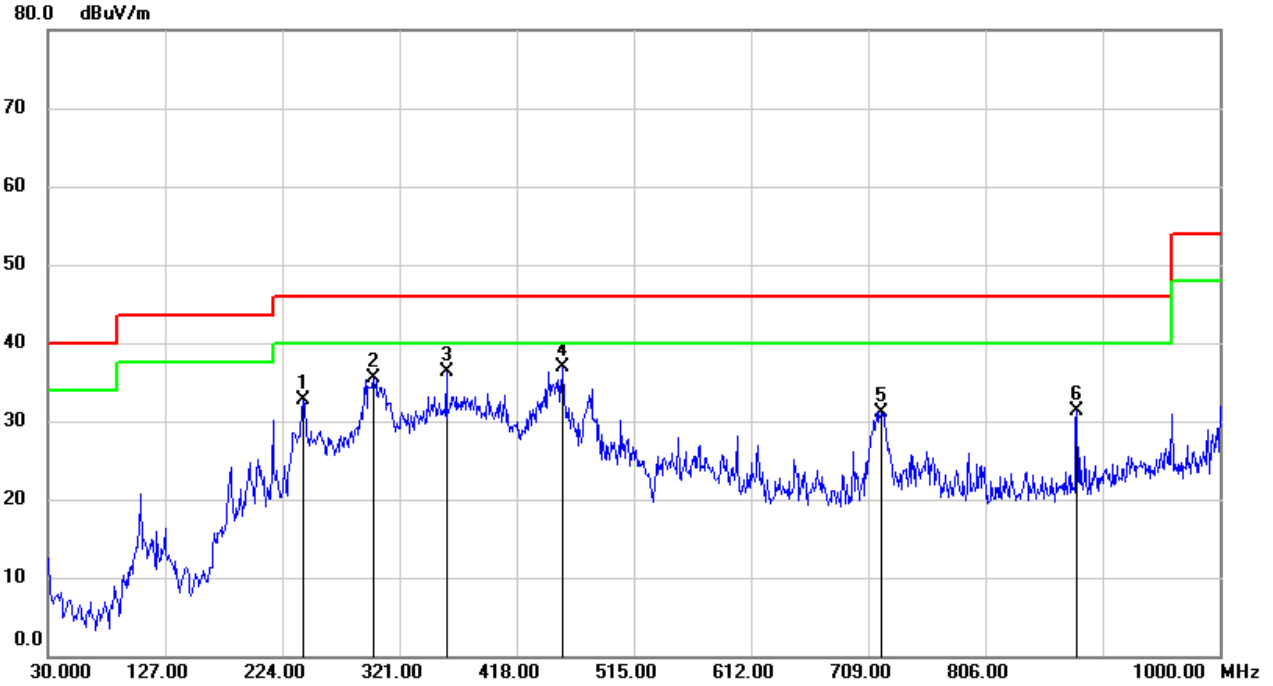

No.	Frequency (MHz)	Reading (dBuV)	Correct (dB/m)	Result (dBuV/m)	Limit (dBuV/m)	Margin (dB)	Remark
1	241.4600	49.49	-16.88	32.61	46.00	-13.39	QP
2	299.6600	49.36	-13.87	35.49	46.00	-10.51	QP
3	359.8000	49.35	-13.04	36.31	46.00	-9.69	QP
4	455.8300	48.24	-11.42	36.82	46.00	-9.18	QP
5	719.6700	37.27	-6.09	31.18	46.00	-14.82	QP
6	881.6600	35.44	-4.21	31.23	46.00	-14.77	QP

- Note: 1. Result Level = Read Level + Correct Factor.
 2. If Peak Result complies with QP limit, QP Result is deemed to comply with QP limit.
 3. Test setup: RBW: 120 kHz, VBW: 300 kHz, Sweep time: auto.



SPURIOUS EMISSIONS (MID CHANNEL, WORST-CASE CONFIGURATION, VERTICAL)

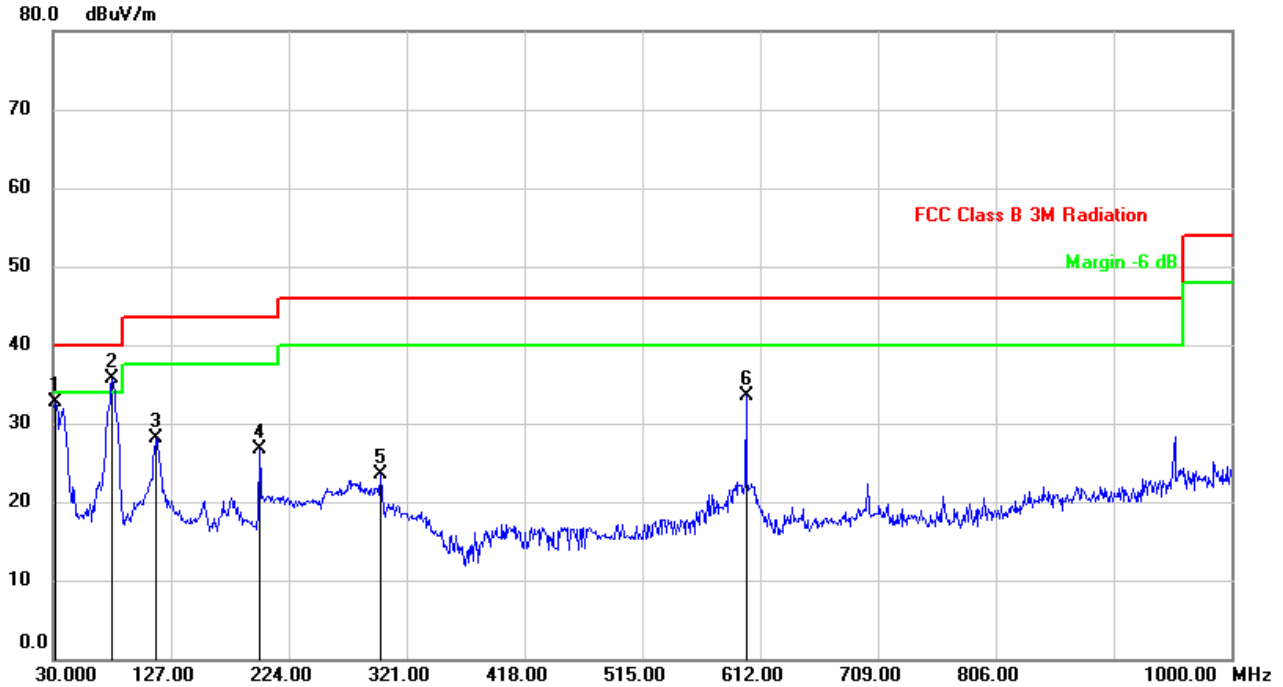

No.	Frequency (MHz)	Reading (dBuV)	Correct (dB/m)	Result (dBuV/m)	Limit (dBuV/m)	Margin (dB)	Remark
1	31.9400	49.82	-17.09	32.73	40.00	-7.27	QP
2	78.5000	55.94	-20.27	35.67	40.00	-4.33	QP
3	114.3900	49.08	-21.01	28.07	43.50	-15.43	QP
4	199.7500	42.57	-15.89	26.68	43.50	-16.82	QP
5	299.6600	37.11	-13.51	23.60	46.00	-22.40	QP
6	600.3600	41.47	-8.06	33.41	46.00	-12.59	QP

- Note: 1. Result Level = Read Level + Correct Factor.
 2. If Peak Result complies with QP limit, QP Result is deemed to comply with QP limit.
 3. Test setup: RBW: 120 kHz, VBW: 300 kHz, Sweep time: auto

Note: All antennas and test modes have been tested, only the worst data record in the report.



9.6. SPURIOUS EMISSIONS BELOW 30M

9.6.1. 802.11n HT20 MIMO MODE

SPURIOUS EMISSIONS (MID CHANNEL, WORST-CASE CONFIGURATION, HORIZONTAL)

0.09~ 150kHz

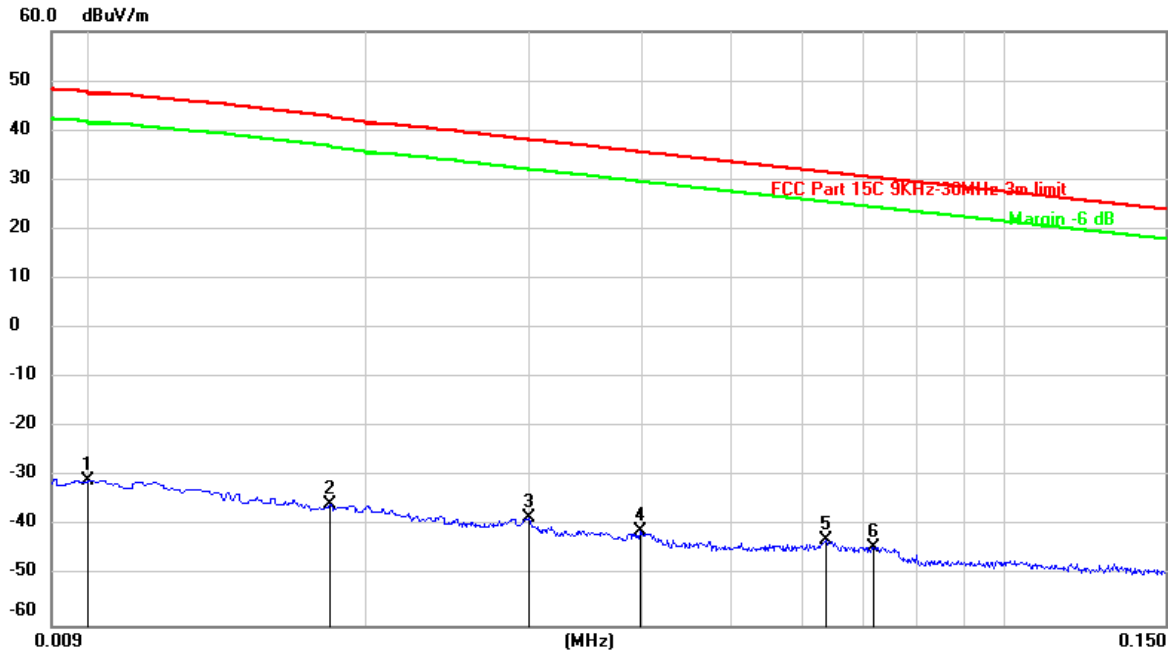

No.	Frequency (MHz)	Reading (dBuV)	Correct (dB/m)	Result (dBuV/m)	Limit (dBuV/m)	Margin (dB)	Remark
1	0.0100	70.72	-101.40	-30.68	47.60	-78.28	peak
2	0.0182	65.85	-101.36	-35.51	42.66	-78.17	peak
3	0.0300	63.18	-101.39	-38.21	38.06	-76.27	peak
4	0.0398	60.36	-101.43	-41.07	35.61	-76.68	peak
5	0.0636	58.81	-101.54	-42.73	31.56	-74.29	peak
6	0.0719	57.34	-101.58	-44.24	30.48	-74.72	peak

Note: 1. Measurement = Reading Level + Correct Factor.

2. If Peak Result complies with AV and QP limit, AV and QP Result are deemed to comply with AV limit.



150kHz ~ 490kHz

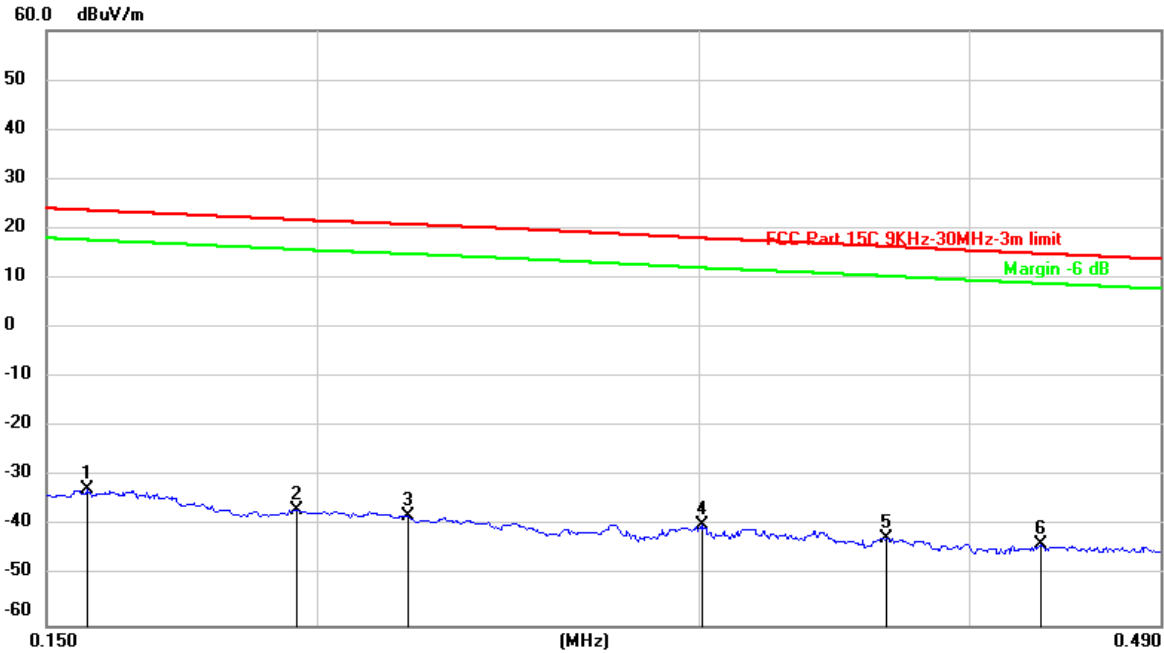

No.	Frequency (MHz)	Reading (dBuV)	Correct (dB/m)	Result (dBuV/m)	Limit (dBuV/m)	Margin (dB)	Remark
1	0.1565	69.03	-101.65	-32.62	23.72	-56.34	peak
2	0.1955	64.85	-101.71	-36.86	21.78	-58.64	peak
3	0.2204	63.66	-101.75	-38.09	20.86	-58.95	peak
4	0.3009	62.22	-101.85	-39.63	18.04	-57.67	peak
5	0.3662	59.58	-101.93	-42.35	16.40	-58.75	peak
6	0.4319	58.46	-101.99	-43.53	14.94	-58.47	peak

Note: 1. Measurement = Reading Level + Correct Factor.

2. If Peak Result complies with AV and QP limit, AV and QP Result are deemed to comply with AV limit.



490kHz ~ 30MHz

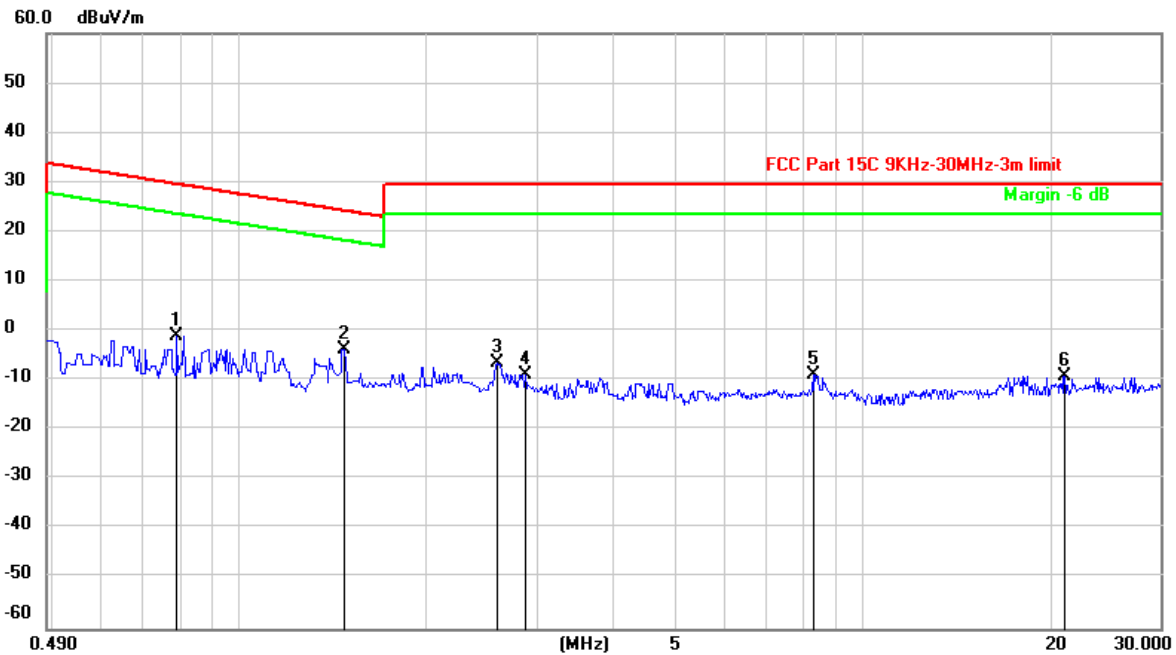

No.	Frequency (MHz)	Reading (dBuV)	Correct (dB/m)	Result (dBuV/m)	Limit (dBuV/m)	Margin (dB)	Remark
1	0.7929	61.02	-62.14	-1.12	29.62	-30.74	peak
2	1.4700	58.39	-62.05	-3.66	24.26	-27.92	peak
3	2.5935	55.11	-61.68	-6.57	29.54	-36.11	peak
4	2.8803	52.84	-61.60	-8.76	29.54	-38.30	peak
5	8.3397	52.19	-61.03	-8.84	29.54	-38.38	peak
6	21.0880	51.69	-60.75	-9.06	29.54	-38.60	peak

Note: 1. Measurement = Reading Level + Correct Factor.

2. If Peak Result complies with AV and QP limit, AV and QP Result are deemed to comply with AV limit.

Note: All constructions and test modes have been tested, only the worst data record in the report.



SPURIOUS EMISSIONS (MID CHANNEL, WORST-CASE CONFIGURATION, VERTICAL)

0.09kHz~ 150kHz

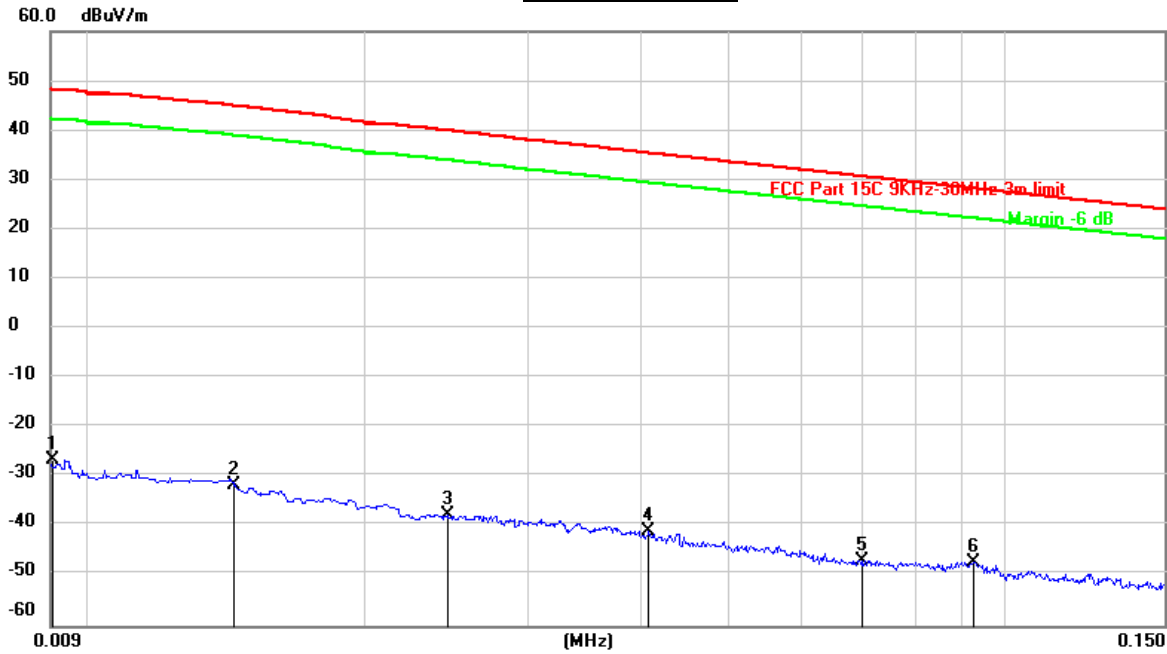

No.	Frequency (MHz)	Reading (dBuV)	Correct (dB/m)	Result (dBuV/m)	Limit (dBuV/m)	Margin (dB)	Remark
1	0.0091	74.84	-101.33	-26.49	48.29	-74.78	peak
2	0.0143	69.72	-101.38	-31.66	45.01	-76.67	peak
3	0.0245	63.74	-101.36	-37.62	40.00	-77.62	peak
4	0.0408	60.46	-101.44	-40.98	35.40	-76.38	peak
5	0.0700	54.76	-101.57	-46.81	30.70	-77.51	peak
6	0.0926	54.57	-101.74	-47.17	28.28	-75.45	peak

Note: 1. Measurement = Reading Level + Correct Factor.
 2. If Peak Result complies with AV and QP limit, AV and QP Result are deemed to comply with AV limit.



150kHz ~ 490kHz

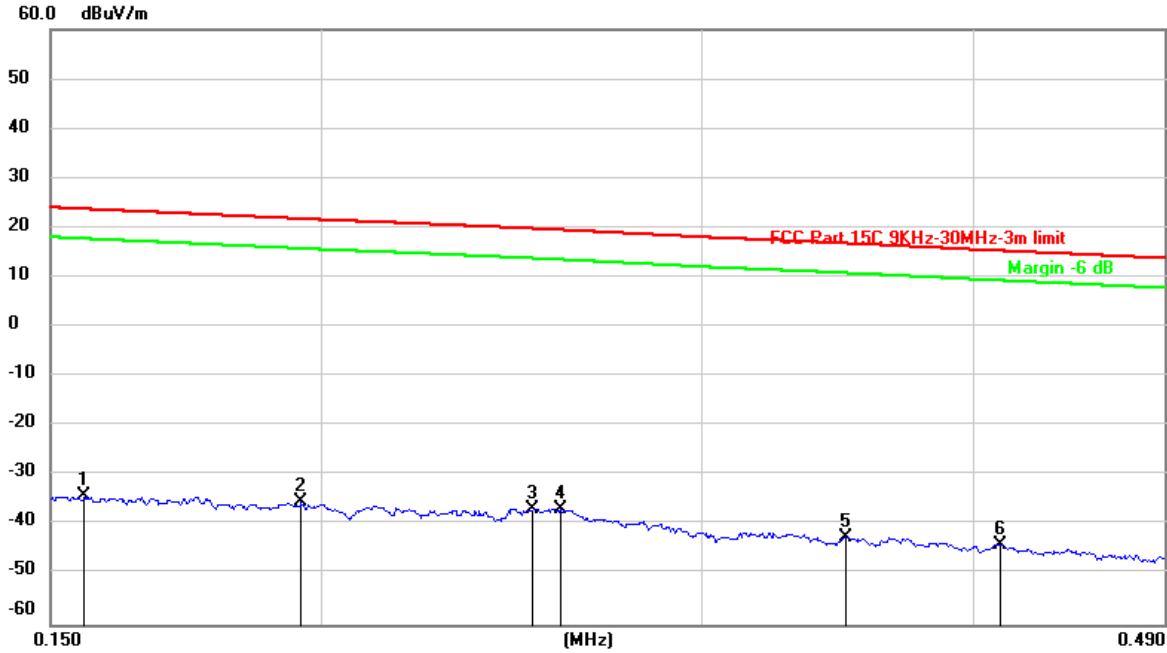

No.	Frequency (MHz)	Reading (dBuV)	Correct (dB/m)	Result (dBuV/m)	Limit (dBuV/m)	Margin (dB)	Remark
1	0.1556	67.52	-101.65	-34.13	23.77	-57.90	peak
2	0.1958	66.48	-101.71	-35.23	21.77	-57.00	peak
3	0.2505	65.20	-101.80	-36.60	19.80	-56.40	peak
4	0.2580	65.15	-101.81	-36.66	19.54	-56.20	peak
5	0.3496	59.52	-101.91	-42.39	16.82	-59.21	peak
6	0.4112	58.10	-101.97	-43.87	15.34	-59.21	peak

Note: 1. Measurement = Reading Level + Correct Factor.

2. If Peak Result complies with AV and QP limit, AV and QP Result are deemed to comply with AV limit.



490kHz ~ 30MHz

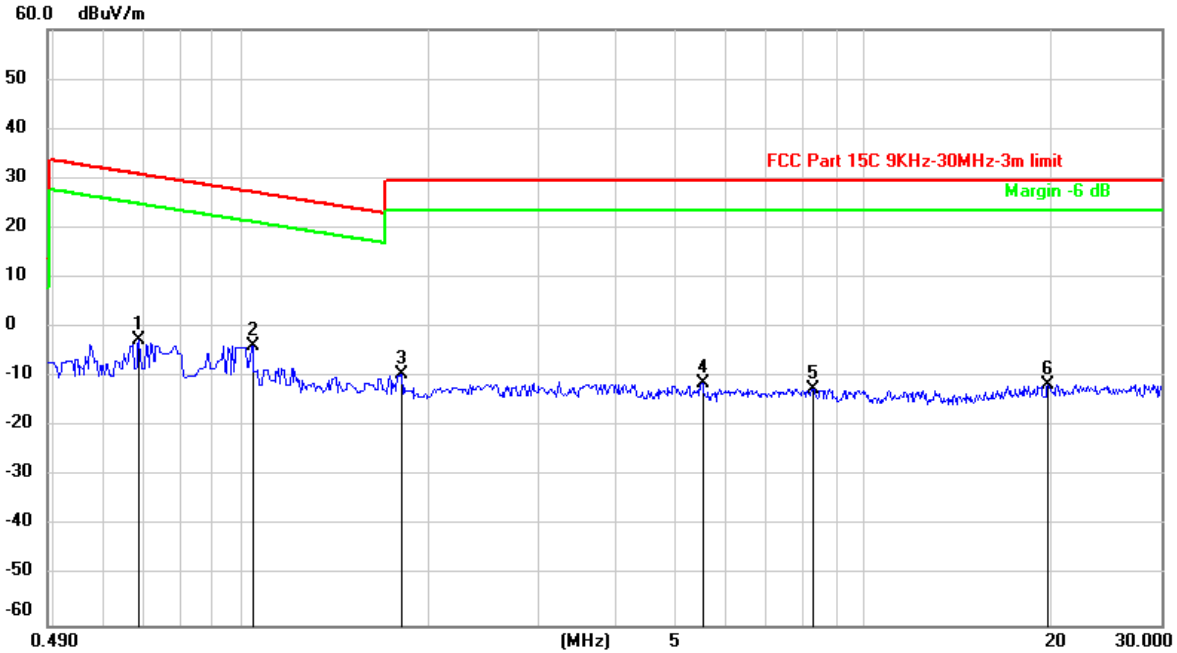

No.	Frequency (MHz)	Reading (dBuV)	Correct (dB/m)	Result (dBuV/m)	Limit (dBuV/m)	Margin (dB)	Remark
1	0.6864	59.42	-62.11	-2.69	30.88	-33.57	peak
2	1.0443	58.39	-62.25	-3.86	27.24	-31.10	peak
3	1.8180	52.44	-61.90	-9.46	29.54	-39.00	peak
4	5.5068	50.14	-61.42	-11.28	29.54	-40.82	peak
5	8.2804	48.69	-61.03	-12.34	29.54	-41.88	peak
6	19.7895	49.18	-60.84	-11.66	29.54	-41.20	peak

Note: 1. Measurement = Reading Level + Correct Factor.

2. If Peak Result complies with AV and QP limit, AV and QP Result are deemed to comply with AV limit.

Note: All antennas and test modes have been tested, only the worst data record in the report.

10. AC POWER LINE CONDUCTED EMISSIONS

LIMITS

Please refer to CFR 47 FCC §15.207 (a) and ISED RSS-Gen Clause 8.8

FREQUENCY (MHz)	Quasi-peak	Average
0.15 -0.5	66 - 56 *	56 - 46 *
0.50 -5.0	56.00	46.00
5.0 -30.0	60.00	50.00

TEST SETUP AND PROCEDURE

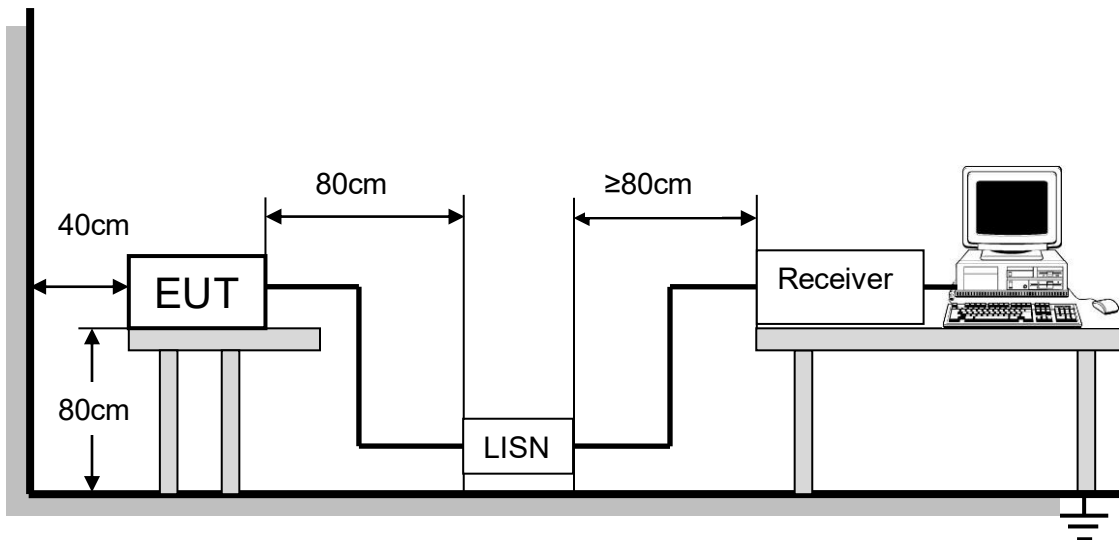

The EUT is put on a table of non-conducting material that is 80cm high. The vertical conducting wall of shielding is located 40cm to the rear of the EUT. The power line of the EUT is connected to the AC mains through a Artificial Mains Network (A.M.N.). A EMI Measurement Receiver (R&S Test Receiver ESR3) is used to test the emissions from both sides of AC line. According to the requirements in Section 7 and 13 of ANSI C63.10-2013. Conducted emissions from the EUT measured in the frequency range between 0.15 MHz and 30MHz using CISPR Quasi-Peak and average detector mode. The bandwidth of EMI test receiver is set at 9kHz.

The arrangement of the equipment is installed to meet the standards and operating in a manner, which tends to maximize its emission characteristics in a normal application.

TEST ENVIRONMENT

Temperature	24.2°C	Relative Humidity	55%
Atmosphere Pressure	101kPa	Test Voltage	AC 120V,60Hz



TEST RESULTS

10.1. 802.11n HT20 MIMO MODE

LINE N RESULTS (MID CHANNEL, WORST-CASE CONFIGURATION)

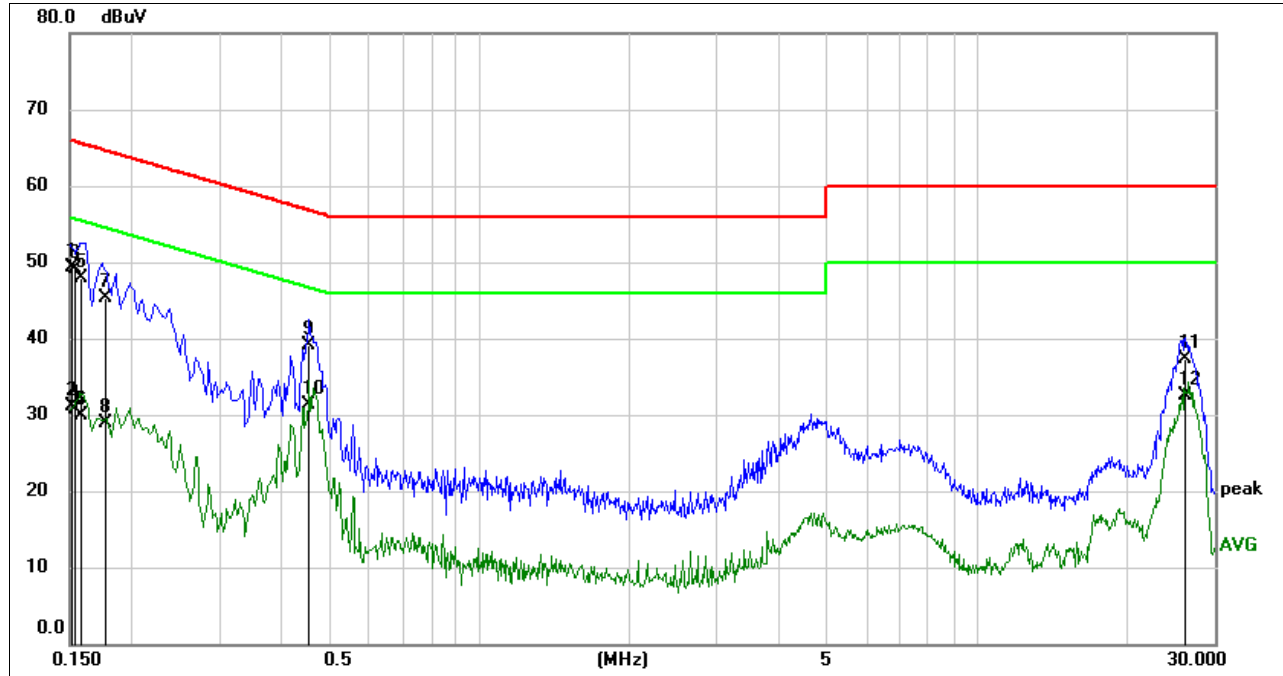

No.	Frequency (MHz)	Reading (dBuV)	Correct (dB)	Result (dBuV)	Limit (dBuV)	Margin (dB)	Remark
1	0.1518	39.74	9.60	49.34	65.90	-16.56	QP
2	0.1518	21.45	9.60	31.05	55.90	-24.85	AVG
3	0.1536	39.51	9.60	49.11	65.80	-16.69	QP
4	0.1536	21.15	9.60	30.75	55.80	-25.05	AVG
5	0.1585	38.28	9.60	47.88	65.54	-17.66	QP
6	0.1585	20.25	9.60	29.85	55.54	-25.69	AVG
7	0.1778	35.67	9.60	45.27	64.59	-19.32	QP
8	0.1778	19.32	9.60	28.92	54.59	-25.67	AVG
9	0.4521	29.44	9.60	39.04	56.84	-17.80	QP
10	0.4521	21.71	9.60	31.31	46.84	-15.53	AVG
11	26.2382	27.20	10.02	37.22	60.00	-22.78	QP
12	26.2382	22.39	10.02	32.41	50.00	-17.59	AVG

- Note: 1. Result = Reading +Correct Factor.
 2. If QP Result complies with AV limit, AV Result is deemed to comply with AV limit.
 3. Test setup: RBW: 200 Hz (9 kHz—150 kHz), 9 kHz (150 kHz—30 MHz).
 4. Step size: 80Hz (0.009MHz-0.15MHz), 4 kHz (0.15MHz-30MHz), Scan time: auto.



LINE L RESULTS (HIGH CHANNEL, WORST-CASE CONFIGURATION)

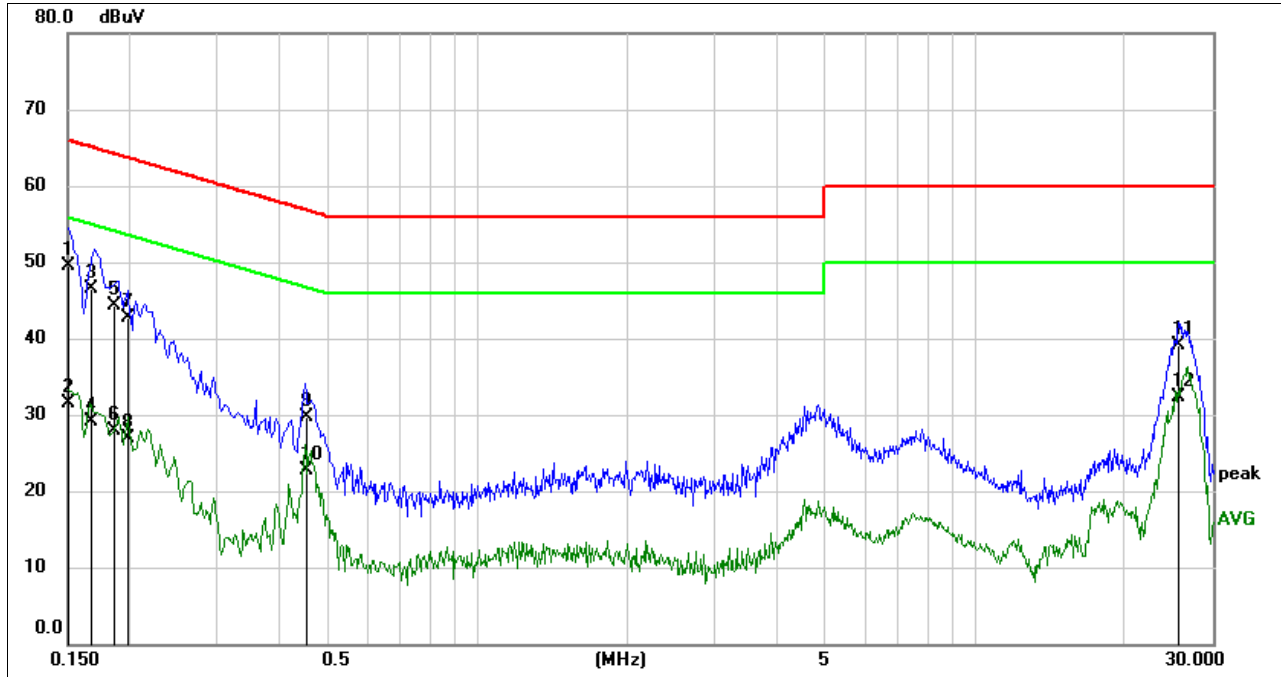

No.	Frequency (MHz)	Reading (dBuV)	Correct (dB)	Result (dBuV)	Limit (dBuV)	Margin (dB)	Remark
1	0.1507	39.99	9.61	49.60	65.96	-16.36	QP
2	0.1507	21.98	9.61	31.59	55.96	-24.37	AVG
3	0.1666	36.98	9.61	46.59	65.13	-18.54	QP
4	0.1666	19.42	9.61	29.03	55.13	-26.10	AVG
5	0.1856	34.80	9.60	44.40	64.23	-19.83	QP
6	0.1856	18.21	9.60	27.81	54.23	-26.42	AVG
7	0.1970	33.06	9.60	42.66	63.74	-21.08	QP
8	0.1970	17.29	9.60	26.89	53.74	-26.85	AVG
9	0.4529	20.18	9.60	29.78	56.82	-27.04	QP
10	0.4529	13.16	9.60	22.76	46.82	-24.06	AVG
11	25.7615	29.26	9.93	39.19	60.00	-20.81	QP
12	25.7615	22.41	9.93	32.34	50.00	-17.66	AVG

- Note: 1. Result = Reading +Correct Factor.
 2. If QP Result complies with AV limit, AV Result is deemed to comply with AV limit.
 3. Test setup: RBW: 200 Hz (9 kHz—150 kHz), 9 kHz (150 kHz—30 MHz).
 4. Step size: 80Hz (0.009MHz-0.15MHz), 4 kHz (0.15MHz-30MHz), Scan time: auto.

Note: All antennas and test modes have been tested, only the worst data record in the report.



11. ANTENNA REQUIREMENTS

APPLICABLE REQUIREMENTS

Please refer to FCC §15.203

An intentional radiator shall be designed to ensure that no antenna other than that furnished by the responsible party shall be used with the device. The use of a permanently attached antenna or of an antenna that uses a unique coupling to the intentional radiator shall be considered sufficient to comply with the provisions of this section. The manufacturer may design the unit so that a broken antenna can be replaced by the user, but the use of a standard antenna jack or electrical connector is prohibited.

Please refer to FCC §15.247(b)(4)

The conducted output power limit specified in paragraph (b) of this section is based on the use of antennas with directional gains that do not exceed 6 dBi. Except as shown in paragraph (c) of this section, if transmitting antennas of directional gain greater than 6 dBi are used, the conducted output power from the intentional radiator shall be reduced below the stated values in paragraphs (b)(1), (b)(2), and (b)(3) of this section, as appropriate, by the amount in dB that the directional gain of the antenna exceeds 6 dBi.

RESULTS

Complies

END OF REPORT