



# RF MEASUREMENT REPORT

---

**FCC ID:** 2AR82-SKIWB921A5  
**Applicant:** Guangzhou Shikun Electronics Co., Ltd  
**Product:** IEEE 802.11b/g/n/a/ac/ax 2T2R USB WiFi Module  
Integrated BT 2.1+EDR/4.2/5.2  
**Model No.:** SKI.WB921A.5  
**FCC Classification:** 15E 6GHz Low Power Indoor Client (6XD)  
**FCC Rule Part(s):** Part 15 Subpart E (Section 15.407)  
**Test Date:** February 15 ~ March 13, 2022

**Reviewed By:**

\_\_\_\_\_  
Vincent Yu

**Approved By:**

\_\_\_\_\_  
Robin Wu



The test results relate only to the samples tested.

This equipment has been shown to be capable of compliance with the applicable technical standards as indicated in the measurement report and was tested in accordance with the measurement procedures specified in KDB789033. Test results reported herein relate only to the item(s) tested.

The test report shall not be reproduced except in full without the written approval of MRT Technology (Suzhou) Co., Ltd.

### Revision History

Report No.	Version	Description	Issue Date	Note
2112RSU080-U6	Rev. 01	Initial Report	04-08-2022	Valid

## CONTENTS

Description	Page
<b>1. General Information .....</b>	<b>6</b>
1.1. Applicant .....	6
1.2. Manufacturer .....	6
1.3. Testing Facility .....	6
1.4. Product Information.....	7
1.5. Radio Specification .....	7
1.6. Working Frequencies .....	8
1.7. Antenna Details.....	9
<b>2. Test Configuration .....</b>	<b>10</b>
2.1. Test Mode .....	10
2.2. Test System Connection Diagram .....	10
2.3. Test Software .....	10
2.4. Applied Standards.....	11
2.5. Test Environment Condition .....	11
<b>3. Antenna Requirements .....</b>	<b>12</b>
<b>4. Measuring Instrument .....</b>	<b>13</b>
<b>5. Measurement Uncertainty.....</b>	<b>14</b>
<b>6. Test Result.....</b>	<b>15</b>
6.1. Summary .....	15
6.2. 26dB Bandwidth Measurement.....	16
6.2.1. Test Limit .....	16
6.2.2. Test Procedure .....	16
6.2.3. Test Setting .....	16
6.2.4. Test Setup .....	17
6.2.5. Test Result .....	17
6.3. Output Power Measurement.....	18
6.3.1. Test Limit .....	18
6.3.2. Test Procedure .....	18
6.3.3. Test Setting .....	18
6.3.4. Test Setup .....	18
6.3.5. Test Result .....	18
6.4. Power Spectral Density Measurement .....	19
6.4.1. Test Limit .....	19
6.4.2. Test Procedure .....	19
6.4.3. Test Setting .....	19

6.4.4.	Test Setup .....	20
6.4.5.	Test Result .....	20
6.5.	In-Band Emission Measurement.....	21
6.5.1.	Test Limit .....	21
6.5.2.	Test Procedure.....	21
6.5.3.	Test Setting .....	21
6.5.4.	Test Setup .....	22
6.5.5.	Test Result .....	22
6.6.	Contention Based Protocol Measurement.....	23
6.6.1.	Test Limit.....	23
6.6.2.	Test Procedure.....	23
6.6.3.	Test Setting .....	23
6.6.4.	Test Setup .....	24
6.6.5.	Test Result .....	24
6.7.	Radiated Spurious Emission Measurement .....	25
6.7.1.	Test Limit.....	25
6.7.2.	Test Procedure.....	25
6.7.3.	Test Setting .....	26
6.7.4.	Test Setup .....	27
6.7.5.	Test Result .....	28
6.8.	Radiated Restricted Band Edge Measurement .....	29
6.8.1.	Test Limit.....	29
6.8.2.	Test Procedure.....	30
6.8.3.	Test Setting .....	30
6.8.4.	Test Setup .....	31
6.8.5.	Test Result .....	31
6.9.	AC Conducted Emissions Measurement.....	32
6.9.1.	Test Limit.....	32
6.9.2.	Test Setup .....	32
6.9.3.	Test Result .....	32
<b>Appendix A - Test Result.....</b>		<b>33</b>
A.1	Duty Cycle Test Result.....	33
A.2	26dB Bandwidth Test Result.....	34
A.3	Output Power Test Result .....	42
A.4	Power Spectral Density Test Result.....	44
A.5	In-Band Emission Measurement .....	58
A.6	Contention Based Protocol Test Result.....	84
A.7	Radiated Spurious Emission Test Result .....	96

A.8 Radiated Restricted Band Edge Test Result.....	134
A.9 AC Conducted Emissions Test Result.....	158
<b>Appendix B - Test Setup Photograph .....</b>	<b>160</b>
<b>Appendix C - EUT Photograph .....</b>	<b>161</b>



**1.4. Product Information**

Product Name	IEEE 802.11b/g/n/a/ac/ax 2T2R USB WiFi Module Integrated BT 2.1+EDR/4.2/5.2
Model No.	SKI.WB921A.5
EUT Identification No.	20211228Sample#09
Wi-Fi Specification	802.11a/b/g/n/ac/ax
Bluetooth Specification	BT2.1+EDR/4.2/5.2 with BLE
Antenna Information	Refer to Section 1.7
Operating Voltage	3.3Vdc+/-0.3
Operating Temperature	0°C to +40°C

Remark: The information of EUT was provided by the manufacturer, and the accuracy of the information shall be the responsibility of the manufacturer.

**1.5. Radio Specification**

Frequency Range	802.11ax-HE20: 5955 ~ 7095MHz 802.11ax-HE40: 5965 ~ 7085MHz 802.11ax-HE80: 5985 ~ 7025MHz
Type of Modulation	802.11ax: OFDMA
Data Rate	802.11ax: up to 1201Mbps

Note: For other features of this EUT, test report will be issued separately.

## 1.6. Working Frequencies

802.11ax-HE20

Channel	Frequency	Channel	Frequency	Channel	Frequency
01	5955 MHz	05	5975 MHz	09	5995 MHz
13	6015 MHz	17	6035 MHz	21	6055 MHz
25	6075 MHz	29	6095 MHz	33	6115 MHz
37	6135 MHz	41	6155 MHz	45	6175 MHz
49	6195 MHz	53	6215 MHz	57	6235 MHz
61	6255 MHz	65	6275 MHz	69	6295 MHz
73	6315 MHz	77	6335 MHz	81	6355 MHz
85	6375 MHz	89	6395 MHz	93	6415 MHz
97	6435 MHz	101	6455 MHz	105	6475 MHz
109	5495 MHz	113	6515 MHz	117	6535 MHz
121	6555 MHz	125	6575 MHz	129	6595 MHz
133	6615 MHz	137	6635 MHz	141	6655 MHz
145	6675 MHz	149	6695 MHz	153	6715 MHz
157	6735 MHz	161	6755 MHz	165	6775 MHz
169	6795 MHz	173	6815 MHz	177	6835 MHz
181	6855 MHz	185	6875 MHz	189	6895 MHz
193	6915 MHz	197	6935 MHz	201	6955 MHz
205	6975 MHz	209	6995 MHz	213	7015 MHz
217	7035 MHz	221	7055 MHz	225	7075 MHz
229	7095 MHz	--	--	--	--



## 802.11ax-HE40

Channel	Frequency	Channel	Frequency	Channel	Frequency
03	5965 MHz	11	6005 MHz	19	6045 MHz
27	6085 MHz	35	6125 MHz	43	6165 MHz
51	6205 MHz	59	6245 MHz	67	6285 MHz
75	6325 MHz	83	6365 MHz	91	6405 MHz
99	6445 MHz	107	6485 MHz	115	6525 MHz
123	6565 MHz	131	6605 MHz	139	6645 MHz
147	6685 MHz	155	6725 MHz	163	6765 MHz
171	6805 MHz	179	6845 MHz	187	6885 MHz
195	6925 MHz	203	6965 MHz	211	7005 MHz
219	7045 MHz	227	7085 MHz	--	--

## 802.11ax-HE80

Channel	Frequency	Channel	Frequency	Channel	Frequency
07	5985 MHz	23	6065 MHz	39	6145 MHz
55	6225 MHz	71	6305 MHz	87	6385 MHz
103	6465 MHz	119	6545 MHz	135	6625 MHz
151	6705 MHz	167	6785 MHz	183	6865 MHz
199	6945 MHz	215	7025 MHz	--	--

**1.7. Antenna Details**

Antenna Type	Frequency Band (GHz)	Max Peak Gain (dBi)	CDD Directional Gain (dBi)	
			For Power	For PSD
Wi-Fi Antenna (2T2R)				
PIFA	2.4 ~ 2.5	3.76	3.76	6.77
	5.15 ~ 5.9	3.79	3.79	6.80
	5.9 ~ 7.2	3.80	3.80	6.81
Bluetooth Antenna (2T2R)				
PIFA	2.4 ~ 2.5		2.65	

Note:

1. The EUT supports Cyclic Delay Diversity (CDD) mode, and CDD signals are correlated.
2. Bluetooth supports 2T2R, and two antennas cannot transmit simultaneously.

## 2. Test Configuration

### 2.1. Test Mode

Mode 1: Transmit by 802.11ax-HE20 (MCS0)
Mode 2: Transmit by 802.11ax-HE40 (MCS0)
Mode 3: Transmit by 802.11ax-HE80 (MCS0)

### 2.2. Test System Connection Diagram

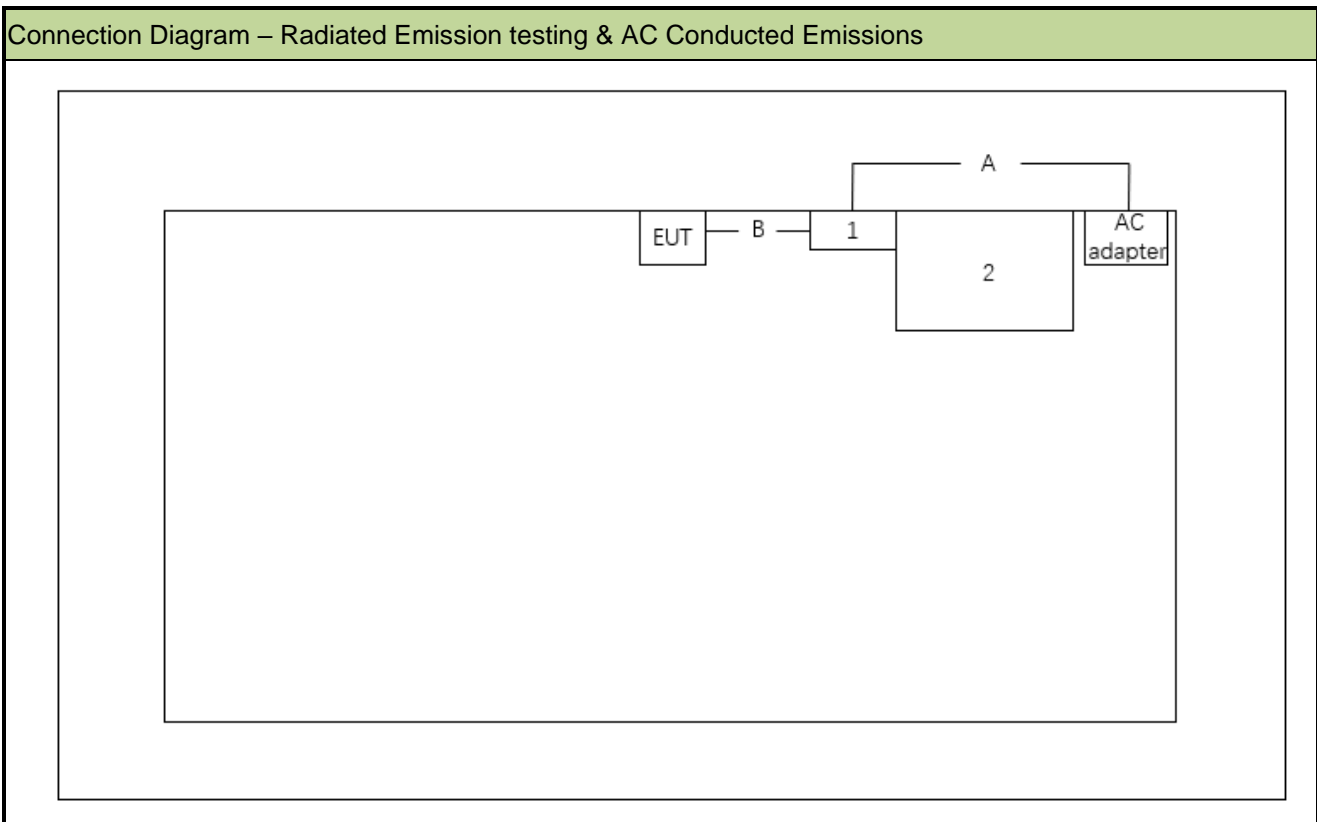

Cable Type		Cable Description	
A	Power Cable	Non shielded, 1.0m	
B	DuPont Cable	Non shielded, 0.1m	
Product	Manufacturer	Model No.	
1	Power Board	N/A	N/A
2	Notebook (for RF Test)	Dell	Latitude 5491

### 2.3. Test Software

The test utility software used during testing was “QATool\_Dbg.exe”, and the version was 0.0.2.39.

Note: Final power setting please refer to operational description.

## 2.4. Applied Standards

According to the specifications of the manufacturer, the EUT must comply with the requirements of the following standards:

- ANSI C63.10-2013
- FCC KDB 789033 D02v02r01
- FCC KDB 987594 D02v01
- FCC KDB 662911 D01v02r01
- FCC KDB 414788 D01v01r01
- FCC KDB 412172 D01v01r01

## 2.5. Test Environment Condition

Ambient Temperature	15 ~ 35°C
Relative Humidity	20 ~ 75%RH

### **3. Antenna Requirements**

**Excerpt from §15.203 of the FCC Rules/Regulations:**

“An intentional radiator antenna shall be designed to ensure that no antenna other than that furnished by the responsible party can be used with the device. The use of a permanently attached antenna or of an antenna that uses a unique coupling to the intentional radiator shall be considered sufficient to comply with the provisions of this section.”

**Conclusion:**

The unit complies with the requirement of §15.203.

#### 4. Measuring Instrument

Instrument	Manufacturer	Model No.	Asset No.	Cali. Interval	Cali. Due Date	Test Site
Signal Generator	Agilent	E4438C	MRTSUE06081	1 year	2023/2/14	WZ-SR5
Signal Analyzer	Agilent	N9020A	MRTSUE06106	1 year	2022/4/13	WZ-SR5
Bluetooth Test Set	Anritsu	MT8852B	MRTSUE06389	1 year	2022/6/8	WZ-SR5
Thermohygrometer	testo	608-H1	MRTSUE06402	1 year	2022/6/28	WZ-SR5
Shielding Room	HUAMING	WZ-SR5	MRTSUE06442	/	/	WZ-SR5
Signal Analyzer	Keysight	N9010B	MRTSUE06457	1 year	2022/6/24	WZ-SR5
USB Power Sensor	Keysight	U2021XA	MRTSUE06446	1 year	2022/6/8	WZ-SR5
EMI Test Receiver	R&S	ESR7	MRTSUE06001	1 year	2022/12/29	WZ-AC1
Horn Antenna	Schwarzbeck	BBHA 9120D	MRTSUE06023	1 year	2022/9/16	WZ-AC1
Preamplifier	Agilent	83017A	MRTSUE06076	1 year	2022/11/12	WZ-AC1
TRILOG Antenna	Schwarzbeck	VULB 9168	MRTSUE06172	1 year	2022/8/5	WZ-AC1
Anechoic Chamber	TDK	WZ-AC1	MRTSUE06212	1 year	2022/4/29	WZ-AC1
Thermohygrometer	testo	608-H1	MRTSUE06403	1 year	2022/6/28	WZ-AC1
Signal Analyzer	Keysight	N9010B	MRTSUE06607	1 year	2022/12/29	WZ-AC1
Thermohygrometer	testo	Testo 608-H1	MRTSUE11039	1 year	2022/11/11	WZ-AC1
Loop Antenna	Schwarzbeck	FMZB 1519	MRTSUE06025	1 year	2022/10/28	WZ-AC1
Horn Antenna	Schwarzbeck	BBHA 9170	MRTSUE06597	1 year	2022/12/1	WZ-AC1
Preamplifier	EMCI	EMC184045SE	MRTSUE06640	1 year	2023/1/13	WZ-AC1
TRILOG Antenna	Schwarzbeck	VULB 9162	MRTSUE06022	1 year	2022/5/24	WZ-AC2
EMI Test Receiver	Agilent	N9038A	MRTSUE06125	1 year	2022/6/24	WZ-AC2
Thermohygrometer	Mingle	ETH529	MRTSUE06170	1 year	2022/12/1	WZ-AC2
Horn Antenna	Schwarzbeck	BBHA 9120D	MRTSUE06171	1 year	2022/10/21	WZ-AC2
Preamplifier	Schwarzbeck	BBV 9718	MRTSUE06176	1 year	2022/11/12	WZ-AC2
Anechoic Chamber	RIKEN	WZ-AC2	MRTSUE06213	1 year	2022/4/29	WZ-AC2
Thermohygrometer	testo	Testo 608-H1	MRTSUE11038	1 year	2022/11/11	WZ-AC2
Two-Line V-Network	R&S	ENV216	MRTSUE06002	1 year	2022/6/8	WZ-SR2
Shielding Room	MIX-BEP	WZ-SR2	MRTSUE06215	5 years	2026/12/20	WZ-SR2
Thermohygrometer	testo	608-H1	MRTSUE06404	1 year	2022/6/28	WZ-SR2
Four-Line V-Network	R&S	ENV432	MRTSUE06615	1 year	2022/10/13	WZ-SR2
EMI Test Receiver	R&S	ESR3	MRTSUE06909	1 year	2022/11/1	WZ-SR2

Software	Version	Function
EMI Software	V3	EMI Test Software

## 5. Measurement Uncertainty

Where relevant, the following test uncertainty levels have been estimated for tests performed on the EUT as specified in CISPR 16-4-2. This uncertainty represents an expanded uncertainty expressed at approximately the 95% confidence level using a coverage factor of  $k = 2$ .

<b>AC Conducted Emission Measurement</b>
Measurement Uncertainty for a Level of Confidence of 95% ( $U=2Uc(y)$ ): 9kHz~150kHz: 3.74dB 150kHz~30MHz: 3.44dB
<b>Radiated Emission Measurement</b>
Measurement Uncertainty for a Level of Confidence of 95% ( $U=2Uc(y)$ ): Horizontal: 30MHz~300MHz: 5.04dB 300MHz~1GHz: 4.95dB 1GHz~40GHz: 6.40dB Vertical: 30MHz~300MHz: 5.24dB 300MHz~1GHz: 6.03dB 1GHz~40GHz: 6.40dB
<b>Spurious Emissions, Conducted</b>
Measuring Uncertainty for a Level of Confidence of 95% ( $U=2Uc(y)$ ): 0.78dB
<b>Output Power</b>
Measuring Uncertainty for a Level of Confidence of 95% ( $U=2Uc(y)$ ): 1.13dB
<b>Power Spectrum Density</b>
Measuring Uncertainty for a Level of Confidence of 95% ( $U=2Uc(y)$ ): 1.15dB
<b>Occupied Bandwidth</b>
Measuring Uncertainty for a Level of Confidence of 95% ( $U=2Uc(y)$ ): 0.28%

## 6. Test Result

### 6.1. Summary

FCC Section(s)	Test Description	Test Condition	Verdict
15.407(a)	26dB Bandwidth	Conducted	Pass
15.407(a)(8)	Maximum Equivalent Isotropically Radiated Power (EIRP)		Pass
15.407(a)(8)	Power Spectral Density (EIRP)		Pass
15.407(b)(7)	In-Band Emission		Pass
15.407(d)(6)	Contention-Based Protocol		Pass
15.407(b)(6)	Unwanted Emissions	Radiated	Pass
15.407 (b)(6), (8), (9), (10)	General Field Strength (Restricted Bands and Radiated Emission)		Pass
15.207	AC Conducted Emissions 150kHz - 30MHz	Line Conducted	Pass

#### Remark:

- The analyzer plots shown in this section were all taken with a correction table loaded into the analyzer. The correction table was used to account for the losses of the cables and attenuators used as part of the system to connect the EUT to the analyzer at all frequencies of interest.
- Output power test was verified over all data rates of each mode (data refers to operational description), and then choose the maximum power output (low data rate) for final test of each channel.
- For radiated emission test, every axis (X, Y, Z) was also verified. The test results shown in the following sections represent the worst-case emissions.
- EUT supports one configuration only in 802.11ax full RU mode.

## 6.2. 26dB Bandwidth Measurement

### 6.2.1. Test Limit

< 320MHz

### 6.2.2. Test Procedure

KDB 789033 D02v02r01- Section C.1 (26dB Bandwidth)

KDB 789033 D02v02r01- Section D (99% Bandwidth)

### 6.2.3. Test Setting

#### 26dB Bandwidth

1. The analyzers' automatic bandwidth measurement capability was used to perform the 26dB bandwidth measurement. The "X" dB bandwidth parameter was set to  $X = 26$ . The automatic bandwidth measurement function also has the capability of simultaneously measuring the 99% occupied bandwidth. The bandwidth measurement was not influenced by any intermediated power nulls in the fundamental emission.
2. RBW = approximately 1% of the emission bandwidth.
3. VBW  $\geq$  RBW.
4. Detector = Peak.
5. Trace mode = max hold.

#### 99% Bandwidth

1. Set center frequency to the nominal EUT channel center frequency.
2. Set span = 1.5 times to 5.0 times the OBW.
3. Set RBW = 1% to 5% of the OBW
4. Set VBW  $\geq 3 \times$  RBW
5. Detector = Peak.
6. Use the 99% power bandwidth function of the instrument.



#### 6.2.4. Test Setup

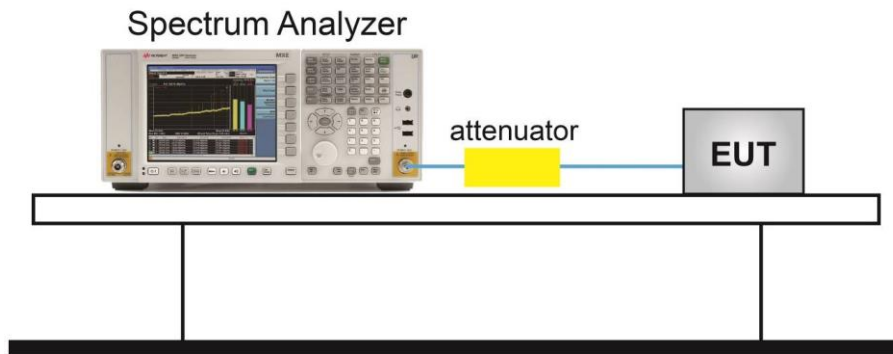

#### 6.2.5. Test Result

Refer to Appendix A.2.

### 6.3. Output Power Measurement

#### 6.3.1. Test Limit

For client devices operating under the control of an indoor access point operating in the 5.925-7.125 GHz band, the maximum e.i.r.p. over the frequency band of operation must not exceed 24 dBm.

#### 6.3.2. Test Procedure

KDB 789033D02v02r01- Section E)3)b) Method PM-G

#### 6.3.3. Test Setting

##### Average Power Measurement

Average power measurements were performed only when the EUT was transmitting at its maximum power control level using a broadband power meter with a pulse sensor. The power meter implemented triggering and gating capabilities which were set up such that power measurements were recorded only during the ON time of the transmitter.

#### 6.3.4. Test Setup

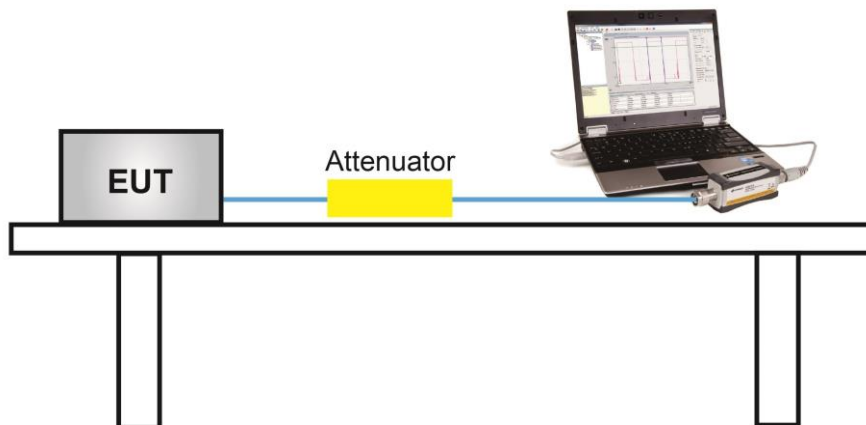

#### 6.3.5. Test Result

Refer to Appendix A.3.

## **6.4. Power Spectral Density Measurement**

### **6.4.1. Test Limit**

For client devices operating under the control of an indoor access point operating in the 5.925-7.125 GHz band, the maximum power spectral density must not exceed -1 dBm e.i.r.p. in any 1-megahertz band.

### **6.4.2. Test Procedure**

KDB 789033 D02v02r01-Section F

### **6.4.3. Test Setting**

1. Analyzer was set to the center frequency of the UNII channel under investigation
2. Span was set to encompass the entire 26dB EBW of the signal.
3. RBW = 1MHz
4. VBW = 3MHz
5. Number of sweep points  $\geq 2 \times (\text{span} / \text{RBW})$
6. Detector = power averaging (Average)
7. Sweep time = auto
8. Trigger = free run
9. Use the peak search function on the instrument to find the peak of the spectrum and record its value.
10. Add  $10 \cdot \log(1/x)$ , where x is the duty cycle, to the measured power in order to compute the average power during the actual transmission times (because the measurement represents an average over both the on and off times of the transmission). For example, add  $10 \cdot \log(1/0.25) = 6$  dB if the duty cycle is 25 percent.

#### 6.4.4. Test Setup

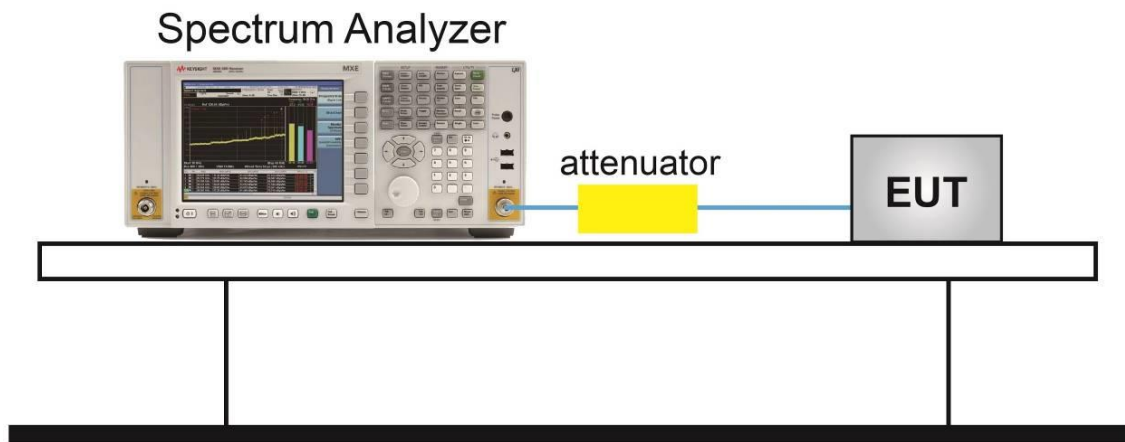

#### 6.4.5. Test Result

Refer to Appendix A.4.

## 6.5. In-Band Emission Measurement

### 6.5.1. Test Limit

Suppressed by 20 dB at 1 MHz outside of the channel edge. (The channel edge is defined as the 26-dB point on either side of the carrier center frequency.)

Suppressed by 28 dB at one channel bandwidth from the channel center.

Suppressed by 40 dB at one- and one-half times the channel bandwidth from the channel center.

### 6.5.2. Test Procedure

KDB 987594 D02v01r01- Section J

### 6.5.3. Test Setting

#### Emissions Mask Reference Level Measurement

1. Set the span to encompass the entire 26 dB EBW of the signal.
2. Set RBW = same RBW used for 26 dB EBW measurement.
3. Set VBW  $\geq 3 \times$  RBW.
4. Number of points in sweep  $\geq [2 \times \text{span} / \text{RBW}]$ .
5. Sweep time = auto.
6. Detector = RMS.
7. Trace average at least 100 traces in power averaging (rms) mode.
8. Use the peak search function on the instrument to find the peak of the spectrum.

#### In-Band Emission

1. Using the measuring equipment limit line function, develop the emissions mask based on rule.
2. Adjust the span to encompass the entire mask as necessary.
3. Clear trace.
4. Trace average at least 100 traces in power averaging (rms) mode.
5. Adjust the reference level as necessary so that the crest of the channel touches the top of the emission mask.

#### 6.5.4. Test Setup

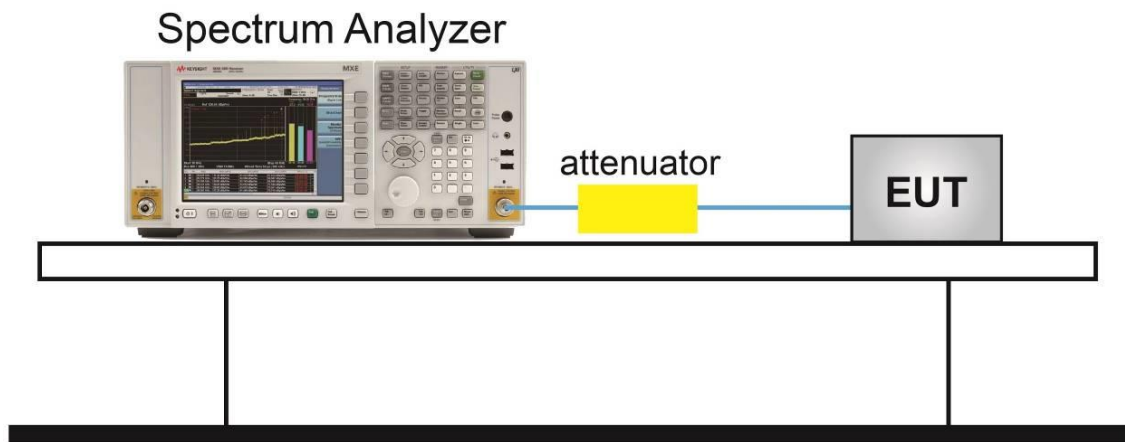

#### 6.5.5. Test Result

Refer to Appendix A.5.

## **6.6. Contention Based Protocol Measurement**

### **6.6.1. Test Limit**

Unlicensed client device must detect co-channel radio frequency power that is at least -62dBm (The threshold is referenced to a 0dBi antenna gain.) or low.

client device must detect an AWGN signal with 90% (or better) level of certainty.

### **6.6.2. Test Procedure**

KDB 987594 D02v01- Section I

### **6.6.3. Test Setting**

1. Configure the EUT to transmit with a constant duty cycle.
  2. Set the operating parameters of the EUT including power level, operating frequency, modulation and bandwidth.
  3. Set the signal analyzer center frequency to the nominal EUT channel center frequency. The span range of the signal analyzer shall be between two times and five times the OBW of the EUT.  
Connect the output port of the EUT to the signal analyzer 2. Ensure that the attenuator 2 provides enough attenuation to not overload the signal analyzer 2 receiver.
  4. Monitoring the signal analyzer 2, verify the EUT is operating and transmitting with the parameters set at step two.
  5. Using an AWGN signal source, generate a 10 MHz-wide AWGN signal. Use Table 1 of KDB 987594 to determine the center frequency of the 10 MHz AWGN signal relative to the EUT's channel bandwidth and center frequency.
  6. Set the AWGN signal power to an extremely low level. Connect the AWGN signal source, via a 3-dB splitter, to the signal analyzer 1 and the EUT as shown in below figure.
  7. Transmit the AWGN signal (RF ON) and verify its characteristics on the signal analyzer 1.
  8. Monitor the signal analyzer 2 to verify if the AWGN signal has been detected and the EUT has ceased transmission. If the EUT continues to transmit, then incrementally increase the AWGN signal power level until the EUT stops transmitting.
-

9. Determine and record the AWGN signal power level (at the EUT's antenna port) at which the EUT ceased transmission. Repeat the procedure at least 10 times to verify the EUT can detect an AWGN signal with 90% (or better) level of certainty.

10. Refer to Table 1 to determine number of times the detection threshold testing needs to be repeated. If testing is required more than once, then go back to step 5, choose a different center frequency for the AWGN signal and repeat the process.

#### 6.6.4. Test Setup

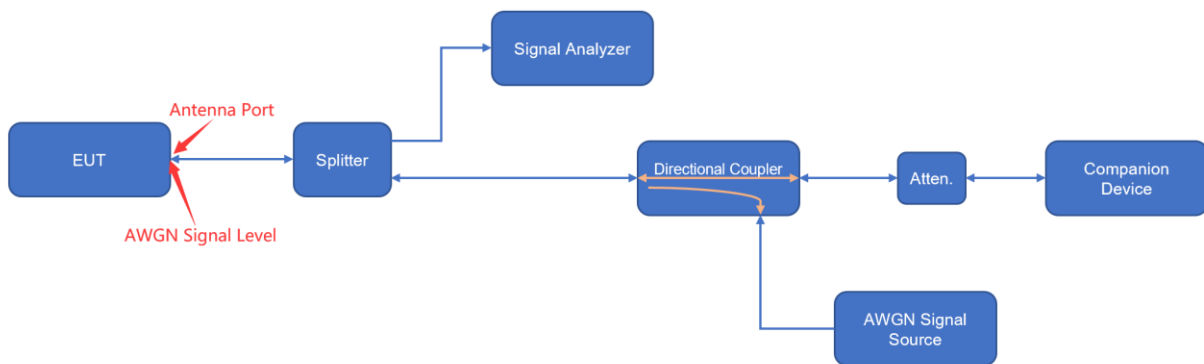

#### 6.6.5. Test Result

Refer to Appendix A.6.



**6.7. Radiated Spurious Emission Measurement**

**6.7.1. Test Limit**

For 15.407(b)(6) requirement

For transmitters operating within the 5.925-7.125 GHz band: Any emissions outside of the 5.925-7.125 GHz band must not exceed an e.i.r.p. of -27 dBm/MHz.

Refer to 987594 D02 U-NII 6GHz EMC Measurement v01 clause G

Use guidance in KDB 789033 for measurements below 1000 MHz and above 1000 MHz. Unwanted emissions outside of restricted bands are measured with a RMS detector. In addition, 15.35(b) applies where the peak emissions must be limited to no more than 20 dB above the average limit.

All out of band emissions appearing in a restricted band as specified in Section 15.205 of the Title 47CFR must not exceed the limits shown in Table per Section 15.209.

FCC Part 15 Subpart C Paragraph 15.209		
Frequency [MHz]	Field Strength [uV/m]	Measured Distance [Meters]
0.009 - 0.490	2400/F (kHz)	300
0.490 - 1.705	24000/F (kHz)	30
1.705 - 30	30	30
30 - 88	100	3
88 - 216	150	3
216 - 960	200	3
Above 960	500	3

**6.7.2. Test Procedure**

KDB 789033 D02v02r01- Section G

### 6.7.3. Test Setting

**Table 1 - RBW as a function of frequency**

Frequency	RBW
9 ~ 150 kHz	200 ~ 300 Hz
0.15 ~ 30 MHz	9 ~ 10 kHz
30 ~ 1000 MHz	100 ~ 120 kHz
> 1000MHz	1MHz

#### **Quasi-Peak Measurements below 1GHz**

1. Analyzer center frequency was set to the frequency of the radiated spurious emission of interest
2. Span was set greater than 1MHz
3. RBW = as specified in Table 1
4. Detector = CISPR quasi-peak
5. Sweep time = auto couple
6. Trace was allowed to stabilize

#### **Peak Measurements above 1GHz**

1. Analyzer center frequency was set to the frequency of the radiated spurious emission of interest
2. RBW = 1MHz
3. VBW = 3MHz
4. Detector = peak
5. Sweep time = auto couple
6. Trace mode = max hold
7. Trace was allowed to stabilize

#### **Average Measurements above 1GHz (Method VB)**

1. Analyzer center frequency was set to the frequency of the radiated spurious emission of interest
2. RBW = 1MHz

3. VBW; If the EUT is configured to transmit with duty cycle  $\geq 98\%$ , set VBW = 10 Hz.

If the EUT duty cycle is  $< 98\%$ , set VBW  $\geq 1/T$ . T is the minimum transmission duration.

4. Detector = Peak

5. Sweep time = auto

6. Trace mode = max hold

7. Trace was allowed to stabilize

#### 6.7.4. Test Setup

Below 1GHz Test Setup:

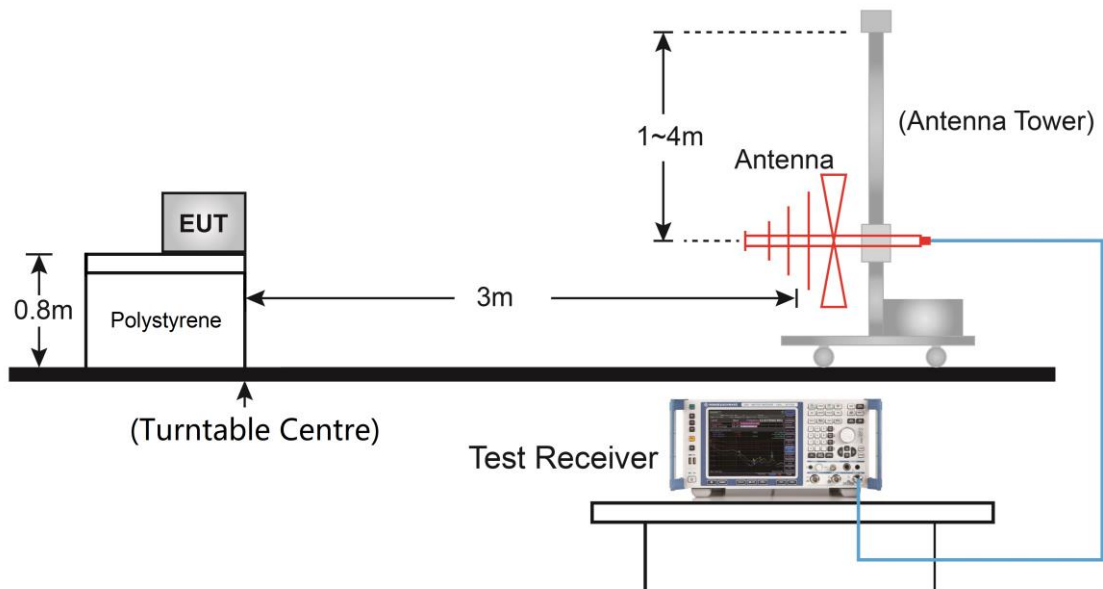

Above 1GHz Test Setup:

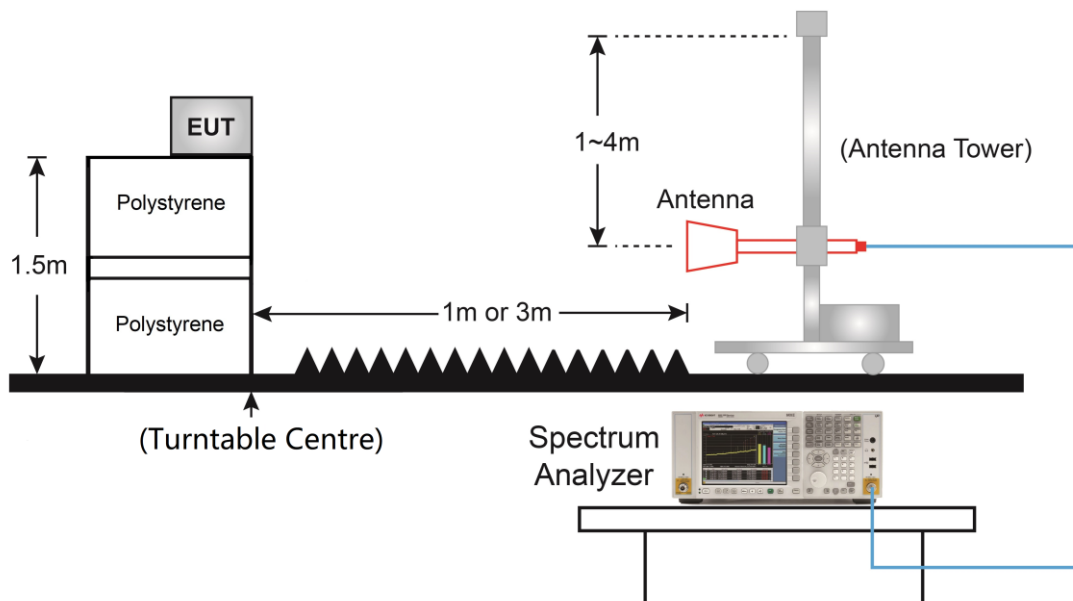

### 6.7.5. Test Result

Refer to Appendix A.7.

## 6.8. Radiated Restricted Band Edge Measurement

### 6.8.1. Test Limit

#### For 15.205 requirement:

Radiated emissions which fall in the restricted bands, as defined in Section 15.205(a) of FCC part 15, must also comply with the radiated emission limits specified in Section 15.209(a).

Frequency (MHz)	Frequency (MHz)	Frequency (MHz)	Frequency (GHz)
0.090 - 0.110	16.42 - 16.423	399.9 - 410	4.5 - 5.15
<sup>1</sup> 0.495 - 0.505	16.69475 - 16.69525	608 - 614	5.35 - 5.46
2.1735 - 2.1905	16.80425 - 16.80475	960 - 1240	7.25 - 7.75
4.125 - 4.128	25.5 - 25.67	1300 - 1427	8.025 - 8.5
4.17725 - 4.17775	37.5 - 38.25	1435 - 1626.5	9.0 - 9.2
4.20725 - 4.20775	73 - 74.6	1645.5 - 1646.5	9.3 - 9.5
6.215 - 6.218	74.8 - 75.2	1660 - 1710	10.6 - 12.7
6.26775 - 6.26825	108 - 121.94	1718.8 - 1722.2	13.25 - 13.4
6.31175 - 6.31225	123 - 138	2200 - 2300	14.47 - 14.5
8.291 - 8.294	149.9 - 150.05	2310 - 2390	15.35 - 16.2
8.362 - 8.366	156.52475 - 156.52525	2483.5 - 2500	17.7 - 21.4
8.37625 - 8.38675	156.7 - 156.9	2690 - 2900	22.01 - 23.12
8.41425 - 8.41475	162.0125 - 167.17	3260 - 3267	23.6 - 24.0
12.29 - 12.293	167.72 - 173.2	3332 - 3339	31.2 - 31.8
12.51975 - 12.52025	240 - 285	3345.8 - 3358	36.43 - 36.5
12.57675 - 12.57725	322 - 335.4	3600 - 4400	( <sup>2</sup> )
13.36 - 13.41	--	--	--

For 15.407(b)(6) requirement

For transmitters operating within the 5.925-7.125 GHz band: Any emissions outside of the 5.925-7.125 GHz band must not exceed an e.i.r.p. of -27 dBm/MHz.

Refer to 987594 D02 U-NII 6GHz EMC Measurement v01 clause G - Unwanted Emission Measurement

Use guidance in KDB 789033 for measurements below 1000 MHz and above 1000 MHz. Unwanted emissions outside of restricted bands are measured with a RMS detector. In addition, 15.35(b) applies where the peak emissions must be limited to no more than 20 dB above the average limit.

All out of band emissions appearing in a restricted band as specified in Section 15.205 of the Title 47CFR must not exceed the limits shown in Table per Section 15.209.

FCC Part 15 Subpart C Paragraph 15.209		
Frequency [MHz]	Field Strength [uV/m]	Measured Distance [Meters]
0.009 - 0.490	2400/F (kHz)	300
0.490 - 1.705	24000/F (kHz)	30
1.705 - 30	30	30
30 - 88	100	3
88 - 216	150	3
216 - 960	200	3
Above 960	500	3

### 6.8.2. Test Procedure

KDB 789033 D02v02r01- Section G

### 6.8.3. Test Setting

#### Peak Measurements above 1GHz

1. Analyzer center frequency was set to the frequency of the radiated spurious emission of interest
2. RBW = 1MHz
3. VBW = 3MHz
4. Detector = Peak
5. Sweep time = Auto couple
6. Trace mode = Max hold
7. Trace was allowed to stabilize

#### Average Measurements above 1GHz (Method VB)

1. Analyzer center frequency was set to the frequency of the radiated spurious emission of interest
2. RBW = 1MHz
3. VBW; if the EUT is configured to transmit with duty cycle  $\geq 98\%$ , set VBW = 10Hz

4. If the EUT duty cycle is  $< 98\%$ , set  $VBW \geq 1/T$ . T is the minimum transmission duration
5. Detector = Peak
6. Sweep time = Auto
7. Trace mode = Max hold
8. Trace was allowed to stabilize

#### 6.8.4. Test Setup

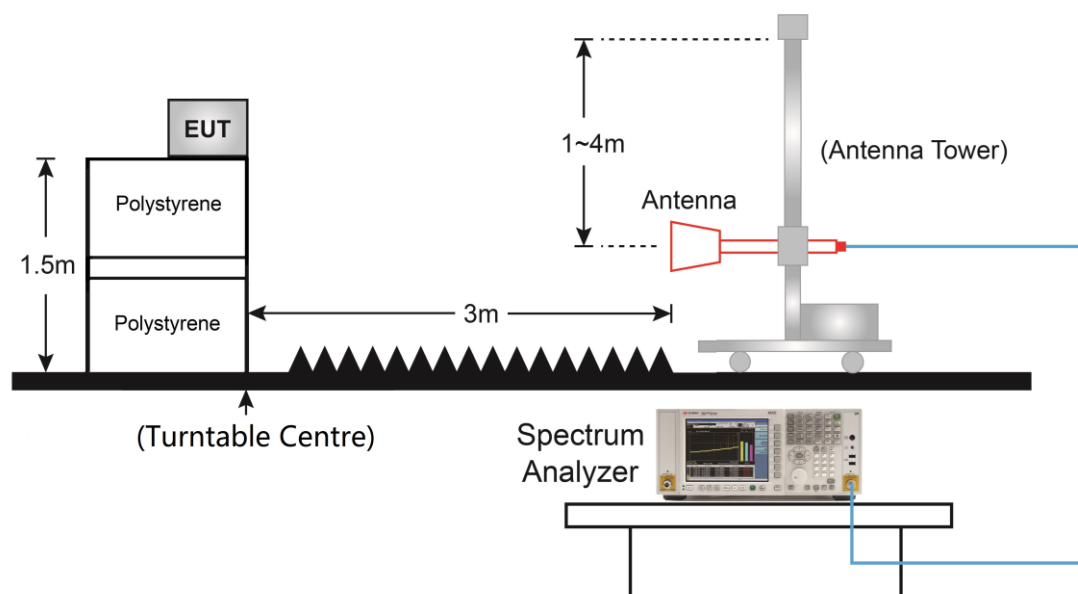

#### 6.8.5. Test Result

Refer to Appendix A.8.

## 6.9. AC Conducted Emissions Measurement

### 6.9.1. Test Limit

FCC Part 15.207 Limits		
Frequency (MHz)	QP (dB $\mu$ V)	AV (dB $\mu$ V)
0.15 - 0.50	66 - 56	56 - 46
0.50 - 5.0	56	46
5.0 - 30	60	50

Note 1: The lower limit shall apply at the transition frequencies.

Note 2: The limit decreases linearly with the logarithm of the frequency in the range 0.15MHz to 0.5MHz.

### 6.9.2. Test Setup

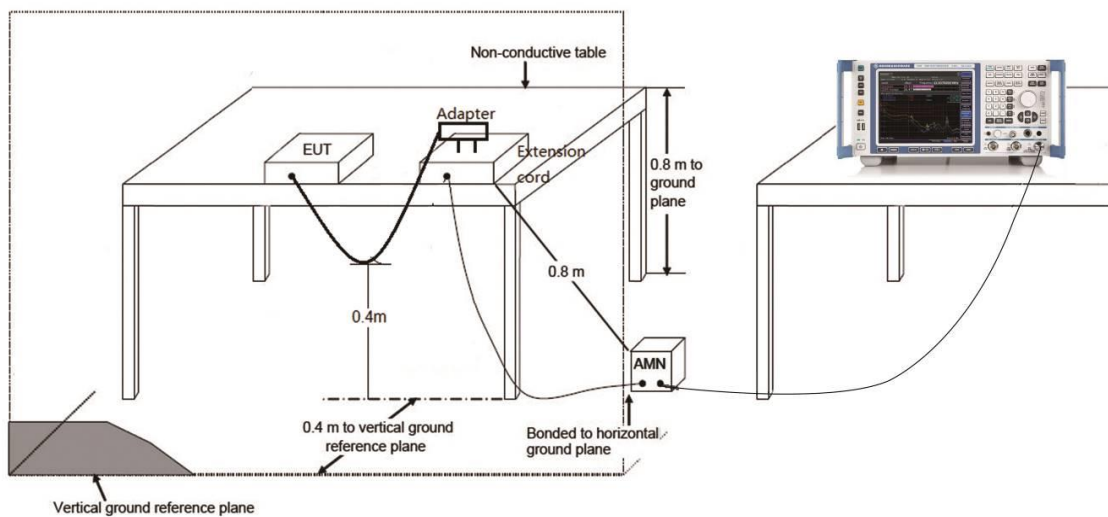

### 6.9.3. Test Result

Refer to Appendix A.9.



## Appendix A - Test Result

### A.1 Duty Cycle Test Result

Test Site	WZ-SR5	Test Engineer	Liz Yuan
Test Date	2022/02/15		

Test Mode	Duty Cycle
802.11ax-HE20	73.02%
802.11ax-HE40	46.34%
802.11ax-HE80	44.13%

#### Duty Cycle (T = Transmission Duration)

802.11ax-HE20 (T = 1.023ms)	802.11ax-HE40 (T = 310.0us)																																																																																
<p>Marker 3 Time: 1.40093 ms Delta Marker: 0.70 dB</p> <table border="1"> <thead> <tr> <th>Mode</th> <th>Trace</th> <th>Scale</th> <th>X</th> <th>Y</th> <th>Function</th> <th>Function Width</th> <th>Function Value</th> </tr> </thead> <tbody> <tr> <td>1</td> <td>Δ2</td> <td>1</td> <td>t</td> <td>(Δ)</td> <td>1.023 ms (Δ)</td> <td>-1.532 dB</td> <td></td> </tr> <tr> <td>2</td> <td>F</td> <td>1</td> <td>1</td> <td>(Δ)</td> <td>2.060 ms</td> <td>18.64 dBm</td> <td></td> </tr> <tr> <td>3</td> <td>M4</td> <td>1</td> <td>1</td> <td>(Δ)</td> <td>1.401 ms (Δ)</td> <td>0.700 dB</td> <td></td> </tr> <tr> <td>4</td> <td>F</td> <td>1</td> <td>t</td> <td>(Δ)</td> <td>2.060 ms</td> <td>18.64 dBm</td> <td></td> </tr> </tbody> </table>	Mode	Trace	Scale	X	Y	Function	Function Width	Function Value	1	Δ2	1	t	(Δ)	1.023 ms (Δ)	-1.532 dB		2	F	1	1	(Δ)	2.060 ms	18.64 dBm		3	M4	1	1	(Δ)	1.401 ms (Δ)	0.700 dB		4	F	1	t	(Δ)	2.060 ms	18.64 dBm		<p>Marker 3 Time: 669.000 μs Delta Marker: 0.67 dB</p> <table border="1"> <thead> <tr> <th>Mode</th> <th>Trace</th> <th>Scale</th> <th>X</th> <th>Y</th> <th>Function</th> <th>Function Width</th> <th>Function Value</th> </tr> </thead> <tbody> <tr> <td>1</td> <td>Δ2</td> <td>1</td> <td>t</td> <td>(Δ)</td> <td>310.0 μs (Δ)</td> <td>-1.589 dB</td> <td></td> </tr> <tr> <td>2</td> <td>F</td> <td>1</td> <td>1</td> <td>(Δ)</td> <td>638.0 μs</td> <td>14.24 dBm</td> <td></td> </tr> <tr> <td>3</td> <td>M4</td> <td>1</td> <td>1</td> <td>(Δ)</td> <td>669.0 μs (Δ)</td> <td>0.6699 dB</td> <td></td> </tr> <tr> <td>4</td> <td>F</td> <td>1</td> <td>t</td> <td>(Δ)</td> <td>638.0 μs</td> <td>14.24 dBm</td> <td></td> </tr> </tbody> </table>	Mode	Trace	Scale	X	Y	Function	Function Width	Function Value	1	Δ2	1	t	(Δ)	310.0 μs (Δ)	-1.589 dB		2	F	1	1	(Δ)	638.0 μs	14.24 dBm		3	M4	1	1	(Δ)	669.0 μs (Δ)	0.6699 dB		4	F	1	t	(Δ)	638.0 μs	14.24 dBm	
Mode	Trace	Scale	X	Y	Function	Function Width	Function Value																																																																										
1	Δ2	1	t	(Δ)	1.023 ms (Δ)	-1.532 dB																																																																											
2	F	1	1	(Δ)	2.060 ms	18.64 dBm																																																																											
3	M4	1	1	(Δ)	1.401 ms (Δ)	0.700 dB																																																																											
4	F	1	t	(Δ)	2.060 ms	18.64 dBm																																																																											
Mode	Trace	Scale	X	Y	Function	Function Width	Function Value																																																																										
1	Δ2	1	t	(Δ)	310.0 μs (Δ)	-1.589 dB																																																																											
2	F	1	1	(Δ)	638.0 μs	14.24 dBm																																																																											
3	M4	1	1	(Δ)	669.0 μs (Δ)	0.6699 dB																																																																											
4	F	1	t	(Δ)	638.0 μs	14.24 dBm																																																																											
<p>Marker 3 Time: 673.000 μs Delta Marker: 0.02 dB</p> <table border="1"> <thead> <tr> <th>Mode</th> <th>Trace</th> <th>Scale</th> <th>X</th> <th>Y</th> <th>Function</th> <th>Function Width</th> <th>Function Value</th> </tr> </thead> <tbody> <tr> <td>1</td> <td>Δ2</td> <td>1</td> <td>t</td> <td>(Δ)</td> <td>297.0 μs (Δ)</td> <td>1.255 dB</td> <td></td> </tr> <tr> <td>2</td> <td>F</td> <td>1</td> <td>1</td> <td>(Δ)</td> <td>638.0 μs</td> <td>9.303 dBm</td> <td></td> </tr> <tr> <td>3</td> <td>M4</td> <td>1</td> <td>1</td> <td>(Δ)</td> <td>673.0 μs (Δ)</td> <td>0.01764 dB</td> <td></td> </tr> <tr> <td>4</td> <td>F</td> <td>1</td> <td>t</td> <td>(Δ)</td> <td>638.0 μs</td> <td>9.303 dBm</td> <td></td> </tr> </tbody> </table>	Mode	Trace	Scale	X	Y	Function	Function Width	Function Value	1	Δ2	1	t	(Δ)	297.0 μs (Δ)	1.255 dB		2	F	1	1	(Δ)	638.0 μs	9.303 dBm		3	M4	1	1	(Δ)	673.0 μs (Δ)	0.01764 dB		4	F	1	t	(Δ)	638.0 μs	9.303 dBm																																										
Mode	Trace	Scale	X	Y	Function	Function Width	Function Value																																																																										
1	Δ2	1	t	(Δ)	297.0 μs (Δ)	1.255 dB																																																																											
2	F	1	1	(Δ)	638.0 μs	9.303 dBm																																																																											
3	M4	1	1	(Δ)	673.0 μs (Δ)	0.01764 dB																																																																											
4	F	1	t	(Δ)	638.0 μs	9.303 dBm																																																																											

**A.2 26dB Bandwidth Test Result**

Test Site	WZ-SR5	Test Engineer	Liz Yuan
Test Date	2022/02/21		

Test Mode	Data Rate/ MCS	Channel No.	Frequency (MHz)	26dB Bandwidth (MHz)	99% Bandwidth (MHz)
802.11ax-HE20	MCS0	01	5955	22.61	19.08
802.11ax-HE20	MCS0	49	6195	24.39	19.09
802.11ax-HE20	MCS0	93	6415	24.88	19.09
802.11ax-HE20	MCS0	97	6435	22.94	19.06
802.11ax-HE20	MCS0	105	6475	24.06	19.11
802.11ax-HE20	MCS0	113	6515	25.33	19.07
802.11ax-HE20	MCS0	117	6535	22.83	19.02
802.11ax-HE20	MCS0	129	6695	26.46	19.06
802.11ax-HE20	MCS0	181	6855	26.89	19.13
802.11ax-HE20	MCS0	185	6875	28.03	19.09
802.11ax-HE20	MCS0	189	6895	24.96	19.09
802.11ax-HE20	MCS0	209	6995	22.82	19.06
802.11ax-HE20	MCS0	229	7095	25.00	19.07
802.11ax-HE40	MCS0	03	5965	39.26	37.52
802.11ax-HE40	MCS0	51	6205	39.25	37.45
802.11ax-HE40	MCS0	91	6405	39.34	37.53
802.11ax-HE40	MCS0	99	6445	39.60	37.47
802.11ax-HE40	MCS0	107	6485	39.48	37.48
802.11ax-HE40	MCS0	115	6525	39.54	37.47
802.11ax-HE40	MCS0	123	6565	39.53	37.54
802.11ax-HE40	MCS0	147	6685	39.49	37.50
802.11ax-HE40	MCS0	187	6885	39.52	37.52
802.11ax-HE40	MCS0	195	6925	39.40	37.61
802.11ax-HE40	MCS0	211	7005	39.48	37.47
802.11ax-HE40	MCS0	227	7085	39.26	37.39

Test Mode	Data Rate/ MCS	Channel No.	Frequency (MHz)	26dB Bandwidth (MHz)	99% Bandwidth (MHz)
802.11ax-HE80	MCS0	07	5985	79.78	76.85
802.11ax-HE80	MCS0	55	6225	79.78	76.88
802.11ax-HE80	MCS0	87	6385	79.93	76.75
802.11ax-HE80	MCS0	103	6465	80.04	76.82
802.11ax-HE80	MCS0	119	6545	80.11	76.86
802.11ax-HE80	MCS0	135	6625	80.03	76.63
802.11ax-HE80	MCS0	151	6705	79.91	76.67
802.11ax-HE80	MCS0	163	6785	79.85	76.57
802.11ax-HE80	MCS0	183	6865	79.74	76.66
802.11ax-HE80	MCS0	199	6945	79.85	76.89
802.11ax-HE80	MCS0	215	7025	79.97	76.76

802.11ax-HE20 26dB Bandwidth

Channel 01 (5955MHz)

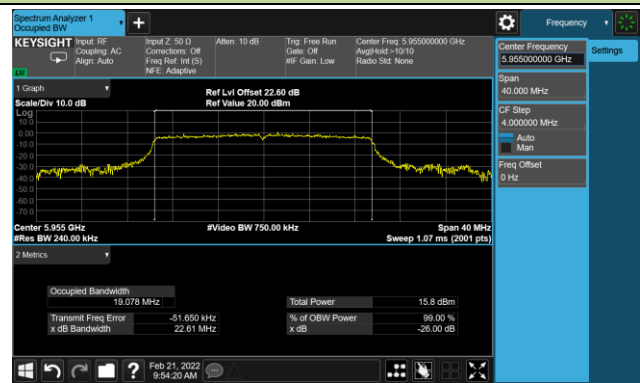

Channel 49 (6195MHz)

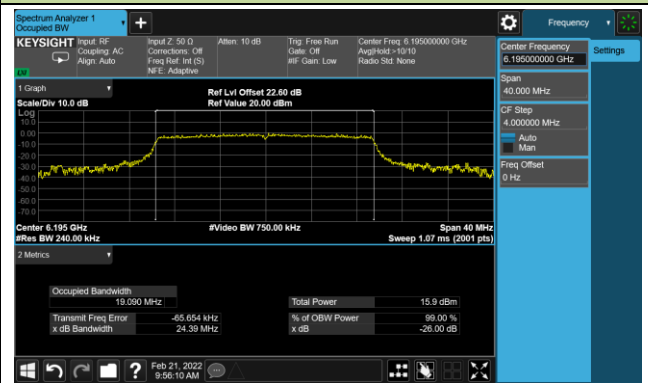

Channel 93 (6415MHz)

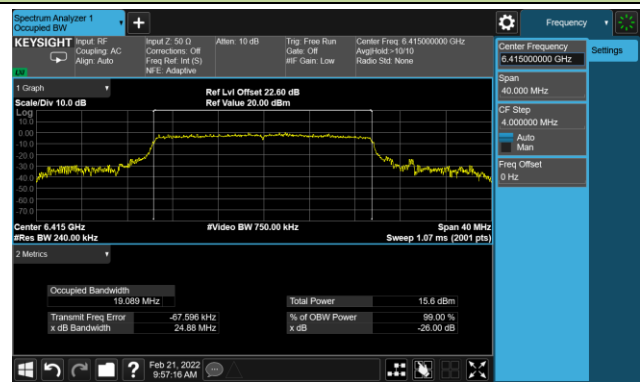

Channel 97 (6435MHz)

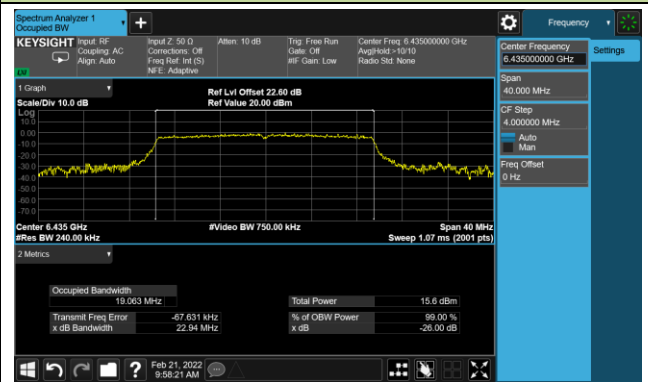

Channel 105 (6475MHz)

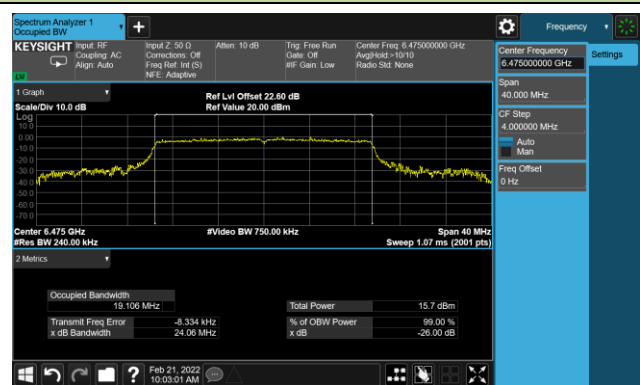

Channel 113 (6515MHz)

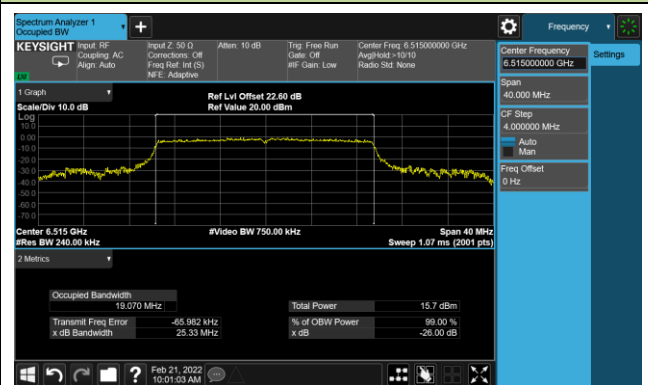

802.11ax-HE20 26dB Bandwidth

Channel 117 (6535MHz)

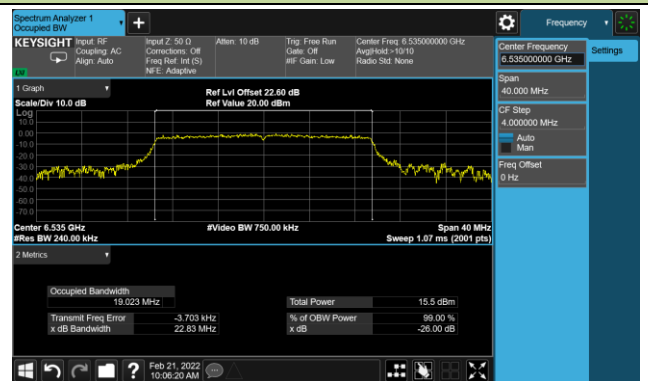

Channel 129 (6695MHz)

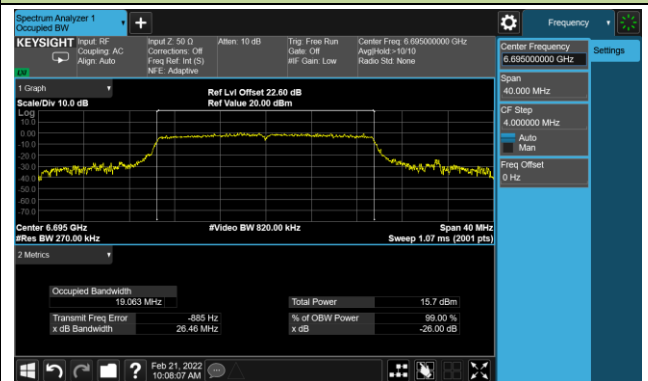

Channel 181 (6855MHz)

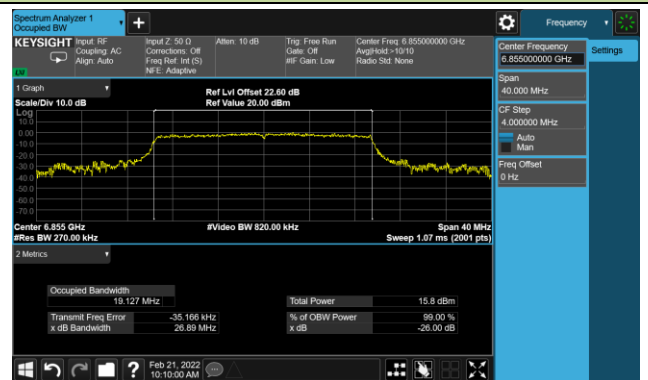

Channel 185 (6875MHz)

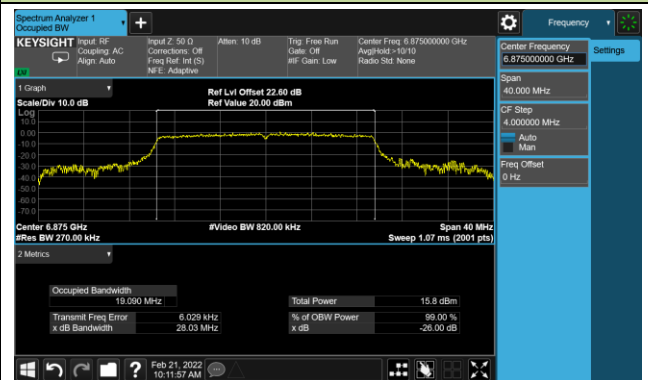

Channel 189 (6895MHz)



Channel 209 (6995MHz)



Channel 229 (7095MHz)



802.11ax-HE40 26dB Bandwidth

Channel 03 (5965MHz)

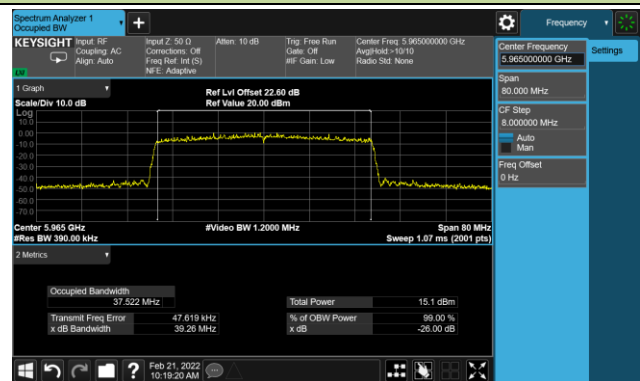

Channel 51 (6205MHz)

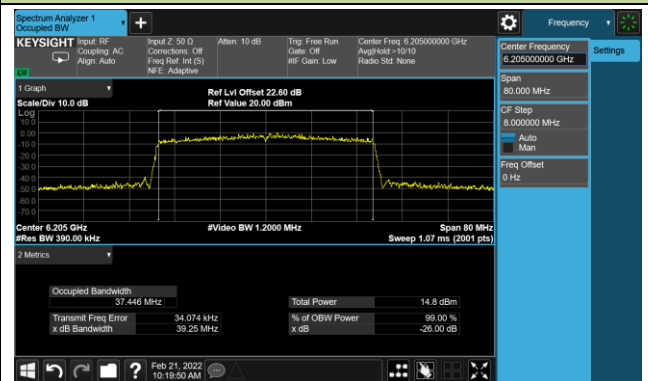

Channel 91 (6405MHz)

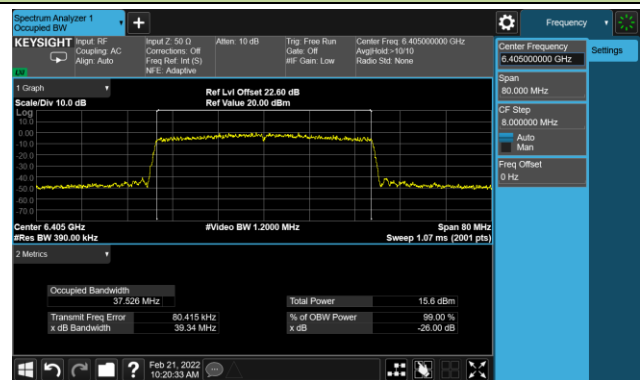

Channel 99 (6445MHz)

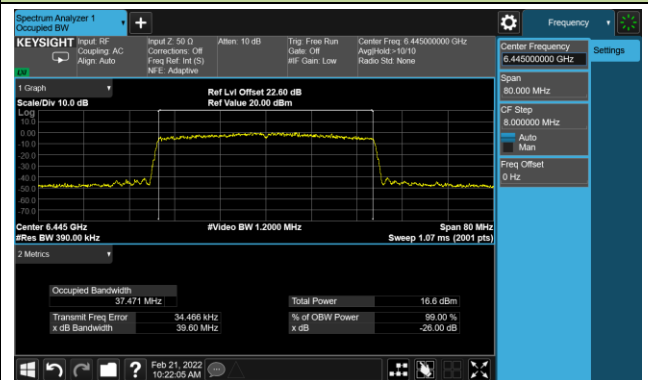

Channel 107 (6485MHz)



Channel 115 (6525MHz)

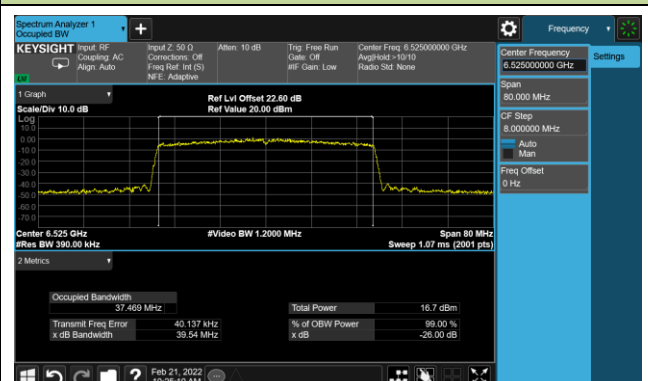

802.11ax-HE40 26dB Bandwidth

Channel 123 (6565MHz)

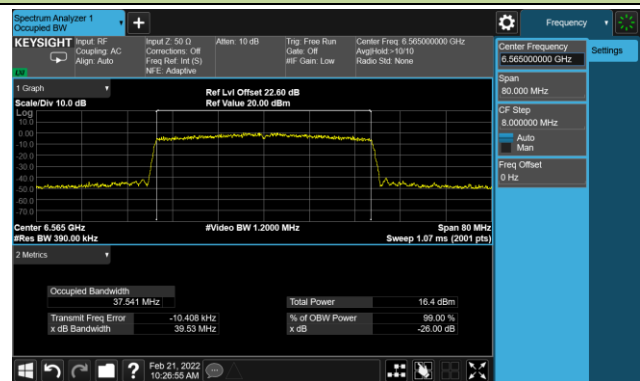

Channel 147 (6685MHz)

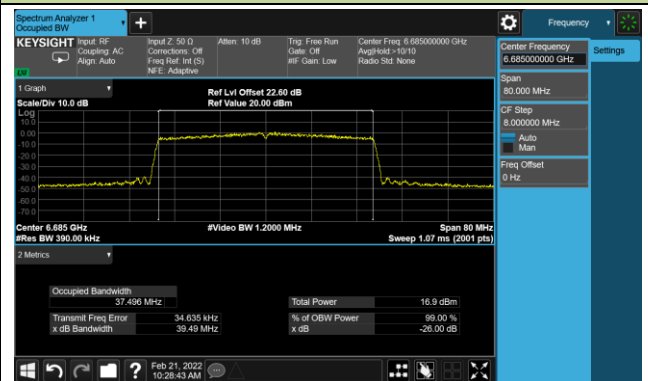

Channel 187 (6885MHz)

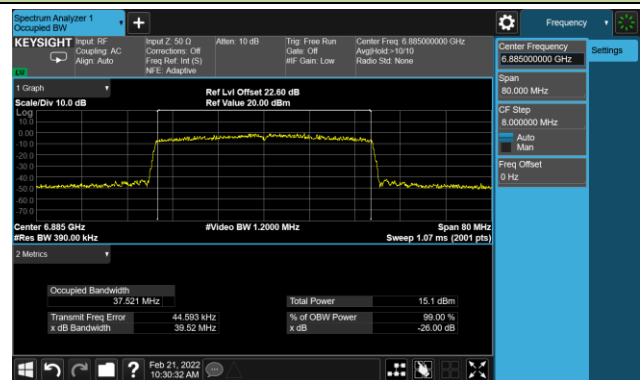

Channel 195 (6925MHz)

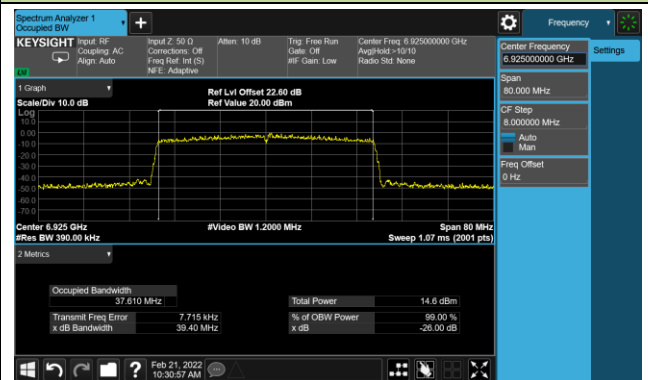

Channel 211 (7005MHz)

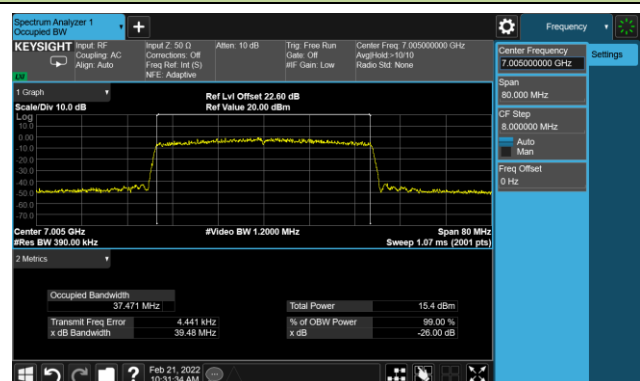

Channel 227 (7085MHz)

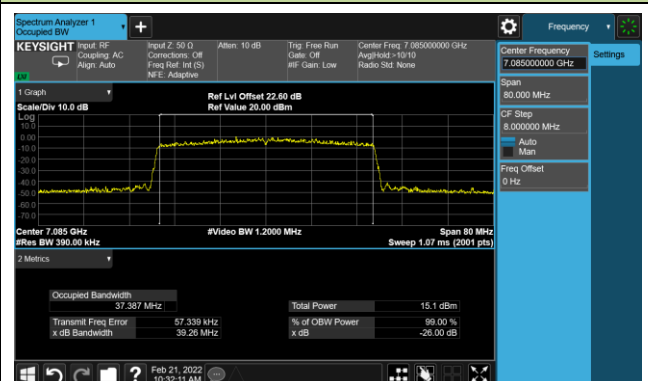

802.11ax-HE80 26dB Bandwidth

Channel 07 (5985MHz)

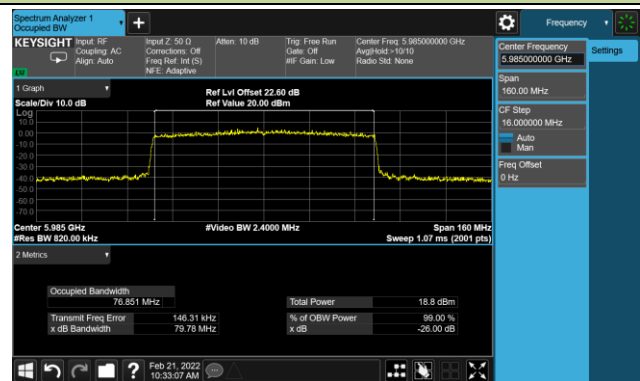

Channel 55 (6225MHz)

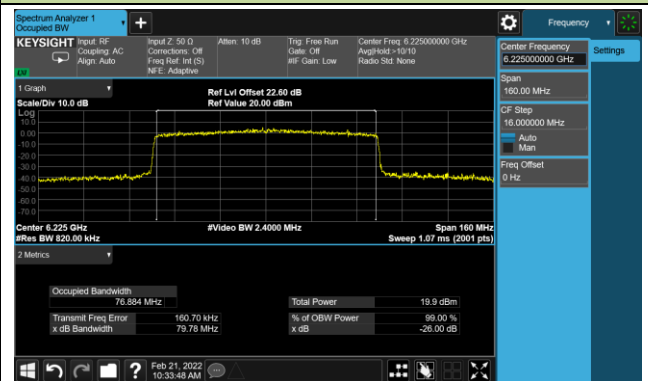

Channel 87 (6385MHz)

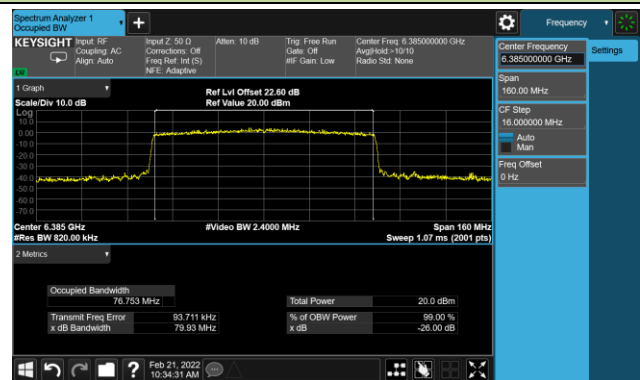

Channel 103 (6465MHz)

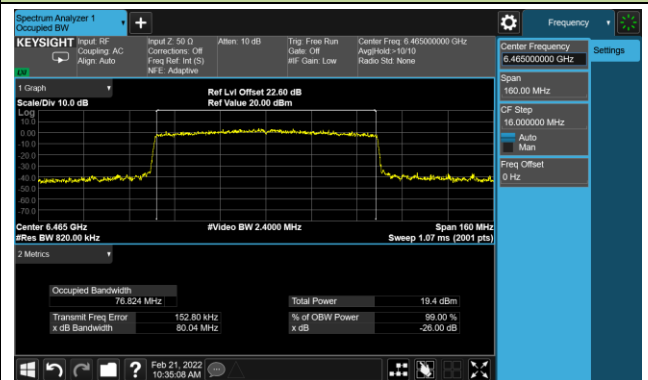

Channel 119 (6545MHz)

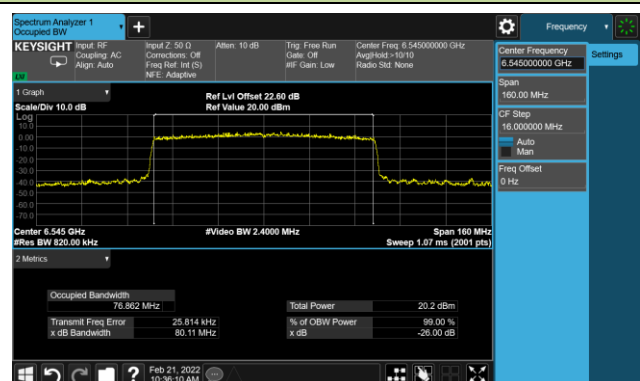

Channel 135 (6625MHz)

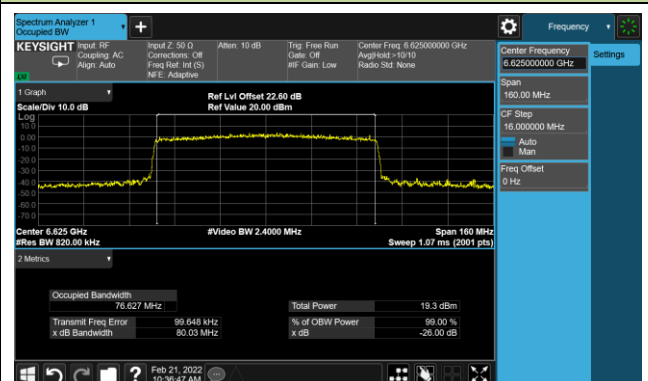



## 802.11ax-HE80 26dB Bandwidth

## Channel 151 (6705MHz)

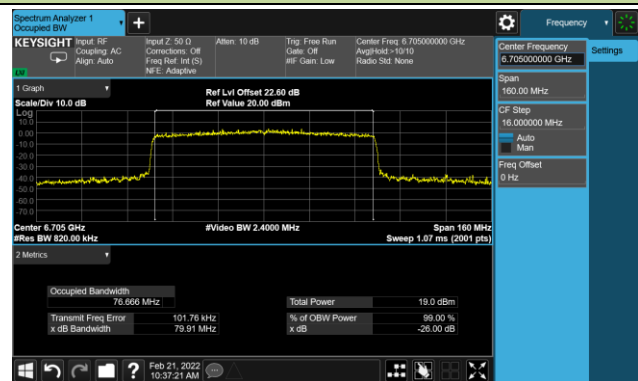

## Channel 163 (6785MHz)

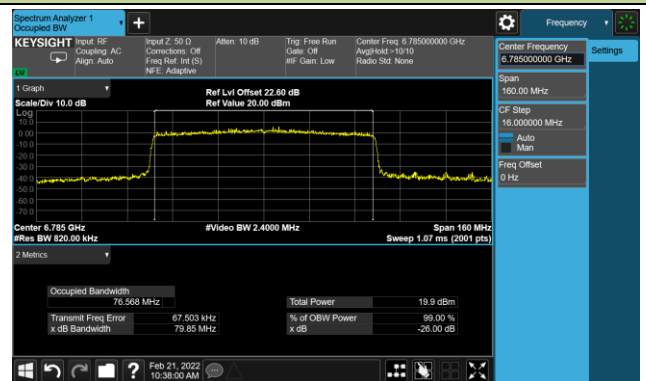

## Channel 183 (6865MHz)

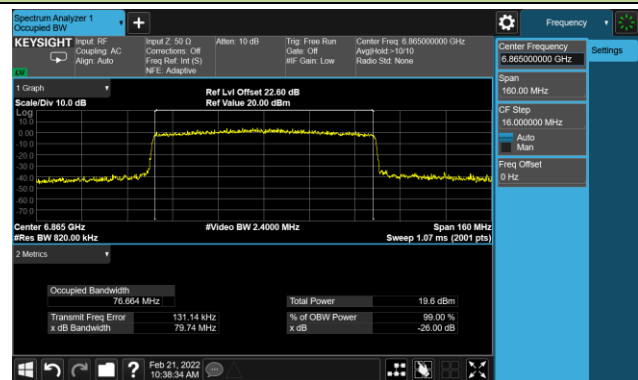

## Channel 199 (6945MHz)

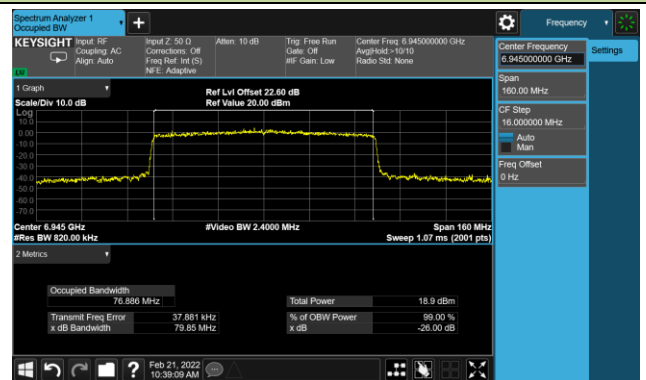

## Channel 215 (7025MHz)

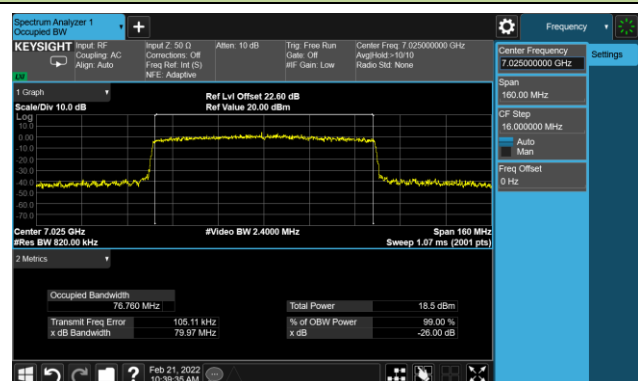

### A.3 Output Power Test Result

Test Site	WZ-SR5	Test Engineer	Liz Yuan
Test Date	2022/03/13		

Test Mode	Data Rate/MCS	Channel No.	Freq. (MHz)	Ant 0 Average Power (dBm)	Ant 1 Average Power (dBm)	Total Average Power (dBm)	Antenna Gain (dBi)	EIRP (dBm)	EIRP Limit (dBm)
11ax-HE20	MCS0	01	5955	-1.23	-1.87	1.47	3.80	5.27	≤ 24.00
11ax-HE20	MCS0	49	6195	-0.55	-1.45	2.03	3.80	5.83	≤ 24.00
11ax-HE20	MCS0	93	6415	-0.69	-1.21	2.07	3.80	5.87	≤ 24.00
11ax-HE20	MCS0	97	6435	-0.76	-1.15	2.06	3.80	5.86	≤ 24.00
11ax-HE20	MCS0	105	6475	-0.78	-0.98	2.13	3.80	5.93	≤ 24.00
11ax-HE20	MCS0	113	6515	-0.87	-1.45	1.86	3.80	5.66	≤ 24.00
11ax-HE20	MCS0	117	6535	-1.07	-1.21	1.87	3.80	5.67	≤ 24.00
11ax-HE20	MCS0	149	6695	-0.78	-1.48	1.89	3.80	5.69	≤ 24.00
11ax-HE20	MCS0	181	6855	-1.12	-1.54	1.69	3.80	5.49	≤ 24.00
11ax-HE20	MCS0	185	6875	-1.34	-1.76	1.47	3.80	5.27	≤ 24.00
11ax-HE20	MCS0	189	6895	-1.36	-1.89	1.39	3.80	5.19	≤ 24.00
11ax-HE20	MCS0	209	6995	0.02	-0.57	2.75	3.80	6.55	≤ 24.00
11ax-HE20	MCS0	229	7095	-0.41	-0.74	2.44	3.80	6.24	≤ 24.00
11ax-HE40	MCS0	03	5965	-0.11	-0.78	2.58	3.80	6.38	≤ 24.00
11ax-HE40	MCS0	51	6205	-0.65	-0.78	2.30	3.80	6.10	≤ 24.00
11ax-HE40	MCS0	91	6405	-0.89	-0.99	2.07	3.80	5.87	≤ 24.00
11ax-HE40	MCS0	99	6445	-1.01	-1.36	1.83	3.80	5.63	≤ 24.00
11ax-HE40	MCS0	107	6485	-0.56	-1.23	2.13	3.80	5.93	≤ 24.00
11ax-HE40	MCS0	115	6525	-0.99	-1.36	1.84	3.80	5.64	≤ 24.00
11ax-HE40	MCS0	123	6565	-0.78	-1.36	1.95	3.80	5.75	≤ 24.00
11ax-HE40	MCS0	147	6685	-0.78	-1.02	2.11	3.80	5.91	≤ 24.00
11ax-HE40	MCS0	187	6885	-0.45	-0.35	2.61	3.80	6.41	≤ 24.00
11ax-HE40	MCS0	195	6925	-0.65	-0.76	2.31	3.80	6.11	≤ 24.00
11ax-HE40	MCS0	211	7005	-0.36	-0.46	2.60	3.80	6.40	≤ 24.00
11ax-HE40	MCS0	227	7085	-0.23	-0.44	2.68	3.80	6.48	≤ 24.00

Test Mode	Data Rate/ MCS	Channel No.	Freq. (MHz)	Ant 0 Average Power (dBm)	Ant 1 Average Power (dBm)	Total Average Power (dBm)	Antenna Gain (dBi)	EIRP (dBm)	EIRP Limit (dBm)
11ax-HE80	MCS0	07	5985	2.24	1.98	5.12	3.80	8.92	≤ 24.00
11ax-HE80	MCS0	55	6225	2.31	1.86	5.10	3.80	8.90	≤ 24.00
11ax-HE80	MCS0	87	6385	2.30	1.95	5.14	3.80	8.94	≤ 24.00
11ax-HE80	MCS0	103	6465	2.36	2.11	5.25	3.80	9.05	≤ 24.00
11ax-HE80	MCS0	119	6545	2.13	2.22	5.19	3.80	8.99	≤ 24.00
11ax-HE80	MCS0	135	6625	2.35	1.98	5.18	3.80	8.98	≤ 24.00
11ax-HE80	MCS0	151	6705	2.74	2.36	5.56	3.80	9.36	≤ 24.00
11ax-HE80	MCS0	167	6785	2.16	2.35	5.27	3.80	9.07	≤ 24.00
11ax-HE80	MCS0	183	6865	2.48	1.96	5.24	3.80	9.04	≤ 24.00
11ax-HE80	MCS0	199	6945	2.46	2.32	5.40	3.80	9.20	≤ 24.00
11ax-HE80	MCS0	215	7025	2.87	2.34	5.62	3.80	9.42	≤ 24.00

Note 1: Total Average Power (dBm) =  $10 \cdot \log \{10^{(\text{Ant 0 Average Power} / 10)} + 10^{(\text{Ant 1 Average Power} / 10)}\}$ .

Note 2: EIRP Power (dBm) = Total Average Power (dBm) + Antenna Gain (dBi).

**A.4 Power Spectral Density Test Result**

Test Site	WZ-SR5	Test Engineer	Liz Yuan
Test Date	2022/03/13		

Test Mode	Data Rate/MCS	CH No.	Freq. (MHz)	Ant 0 PSD (dBm/MHz)	Ant 1 PSD (dBm/MHz)	Duty Cycle (%)	Total PSD (dBm/MHz)	Directional Gain (dBi)	EIRP PSD (dBm/MHz)	EIRP PSD Limit (dBm/MHz)
802.11ax-HE20	MCS0	01	5955	-12.13	-12.67	73.02	-8.02	6.81	-1.21	≤ -1.00
802.11ax-HE20	MCS0	49	6195	-12.09	-12.72	73.02	-8.02	6.81	-1.21	≤ -1.00
802.11ax-HE20	MCS0	93	6415	-11.92	-12.80	73.02	-7.96	6.81	-1.15	≤ -1.00
802.11ax-HE20	MCS0	97	6435	-12.26	-12.65	73.02	-8.07	6.81	-1.26	≤ -1.00
802.11ax-HE20	MCS0	105	6475	-12.21	-12.58	73.02	-8.02	6.81	-1.21	≤ -1.00
802.11ax-HE20	MCS0	113	6515	-12.11	-12.84	73.02	-8.08	6.81	-1.27	≤ -1.00
802.11ax-HE20	MCS0	117	6535	-12.37	-12.72	73.02	-8.17	6.81	-1.35	≤ -1.00
802.11ax-HE20	MCS0	149	6695	-12.07	-13.09	73.02	-8.17	6.81	-1.36	≤ -1.00
802.11ax-HE20	MCS0	181	6855	-12.00	-12.60	73.02	-7.91	6.81	-1.10	≤ -1.00
802.11ax-HE20	MCS0	185	6875	-12.38	-13.03	73.02	-8.32	6.81	-1.51	≤ -1.00
802.11ax-HE20	MCS0	189	6895	-12.24	-13.04	73.02	-8.25	6.81	-1.44	≤ -1.00
802.11ax-HE20	MCS0	209	6995	-12.08	-12.82	73.02	-8.06	6.81	-1.25	≤ -1.00
802.11ax-HE20	MCS0	229	7095	-12.27	-12.75	73.02	-8.13	6.81	-1.32	≤ -1.00
802.11ax-HE40	MCS0	03	5965	-14.67	-14.26	46.34	-8.11	6.81	-1.30	≤ -1.00
802.11ax-HE40	MCS0	51	6205	-14.19	-14.98	46.34	-8.21	6.81	-1.40	≤ -1.00
802.11ax-HE40	MCS0	91	6405	-14.46	-14.89	46.34	-8.32	6.81	-1.51	≤ -1.00
802.11ax-HE40	MCS0	99	6445	-14.52	-14.52	46.34	-8.17	6.81	-1.36	≤ -1.00
802.11ax-HE40	MCS0	107	6485	-14.21	-14.72	46.34	-8.11	6.81	-1.30	≤ -1.00
802.11ax-HE40	MCS0	115	6525	-14.46	-14.72	46.34	-8.24	6.81	-1.43	≤ -1.00
802.11ax-HE40	MCS0	123	6565	-14.23	-14.70	46.34	-8.11	6.81	-1.30	≤ -1.00
802.11ax-HE40	MCS0	147	6685	-14.50	-14.52	46.34	-8.16	6.81	-1.35	≤ -1.00
802.11ax-HE40	MCS0	187	6885	-14.20	-14.88	46.34	-8.17	6.81	-1.36	≤ -1.00
802.11ax-HE40	MCS0	195	6925	-14.52	-14.87	46.34	-8.34	6.81	-1.53	≤ -1.00
802.11ax-HE40	MCS0	211	7005	-14.49	-14.59	46.34	-8.19	6.81	-1.38	≤ -1.00
802.11ax-HE40	MCS0	227	7085	-14.57	-14.77	46.34	-8.32	6.81	-1.51	≤ -1.00

Test Mode	Data Rate/MCS	CH No.	Freq. (MHz)	Ant 0 PSD (dBm/MHz)	Ant 1 PSD (dBm/MHz)	Duty Cycle (%)	Total PSD (dBm/MHz)	Directional Gain (dBi)	EIRP PSD (dBm/MHz)	EIRP PSD Limit (dBm/MHz)
802.11ax-HE80	MCS0	07	5985	-14.20	-14.84	44.13	-7.94	6.81	-1.13	≤ -1.00
802.11ax-HE80	MCS0	55	6225	-14.81	-15.11	44.13	-8.40	6.81	-1.59	≤ -1.00
802.11ax-HE80	MCS0	87	6385	-14.92	-14.79	44.13	-8.29	6.81	-1.48	≤ -1.00
802.11ax-HE80	MCS0	103	6465	-14.24	-15.63	44.13	-8.32	6.81	-1.51	≤ -1.00
802.11ax-HE80	MCS0	119	6545	-14.14	-15.06	44.13	-8.01	6.81	-1.20	≤ -1.00
802.11ax-HE80	MCS0	135	6625	-14.73	-14.26	44.13	-7.93	6.81	-1.12	≤ -1.00
802.11ax-HE80	MCS0	151	6705	-14.22	-15.13	44.13	-8.09	6.81	-1.28	≤ -1.00
802.11ax-HE80	MCS0	167	6785	-15.11	-14.74	44.13	-8.36	6.81	-1.55	≤ -1.00
802.11ax-HE80	MCS0	183	6865	-14.47	-15.16	44.13	-8.24	6.81	-1.43	≤ -1.00
802.11ax-HE80	MCS0	199	6945	-14.92	-14.83	44.13	-8.31	6.81	-1.50	≤ -1.00
802.11ax-HE80	MCS0	215	7025	-14.69	-14.84	44.13	-8.20	6.81	-1.39	≤ -1.00

Note: EUT duty cycle < 98%, EIRP PSD (dBm/MHz) =  $10 \cdot \log \{ 10^{(\text{Ant 0 PSD}/10)} + 10^{(\text{Ant 1 PSD}/10)} \}$  (dBm/MHz) +  $10 \cdot \log (1/\text{Duty Cycle})$  + Antenna Gain (dBi).

802.11ax-HE20 Power Spectral Density – Ant 0

Channel 01 (5955MHz)

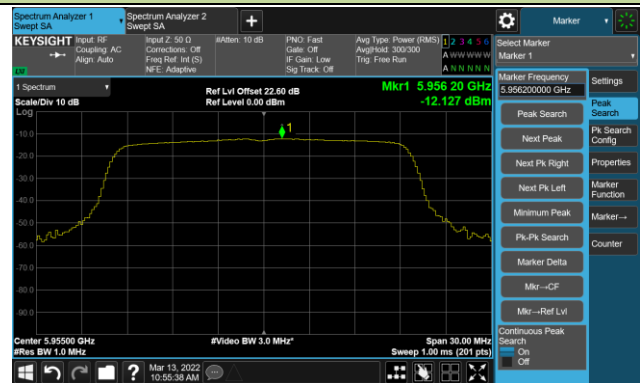

Channel 49 (6195MHz)

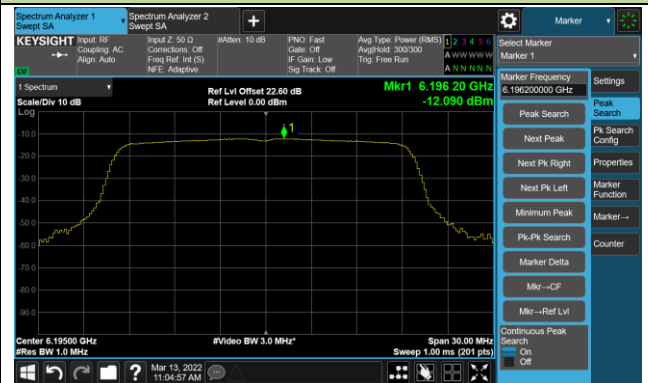

Channel 93 (6415MHz)



Channel 97 (6435MHz)

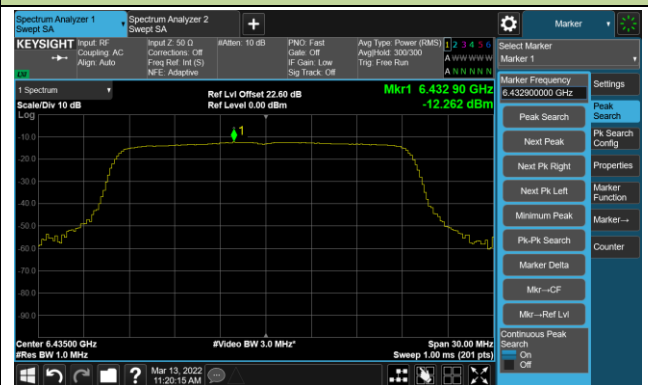

Channel 105 (6475MHz)



Channel 113 (6515MHz)



802.11ax-HE20 Power Spectral Density – Ant 0

Channel 117 (6535MHz)



Channel 149 (6695MHz)



Channel 181 (6855MHz)



Channel 185 (6875MHz)



Channel 189 (6895MHz)



Channel 209 (6995MHz)



Channel 229 (7095MHz)

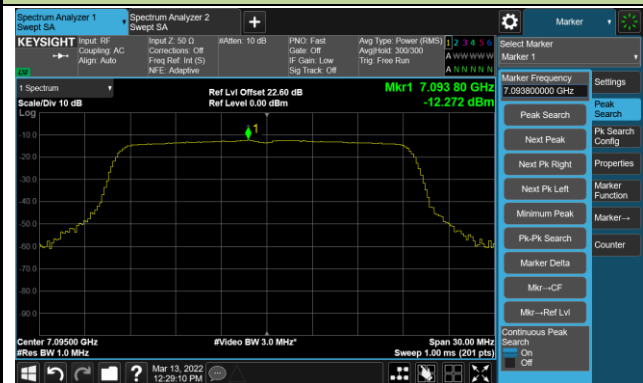

## 802.11ax-HE40 Power Spectral Density – Ant 0

Channel 03 (5965MHz)

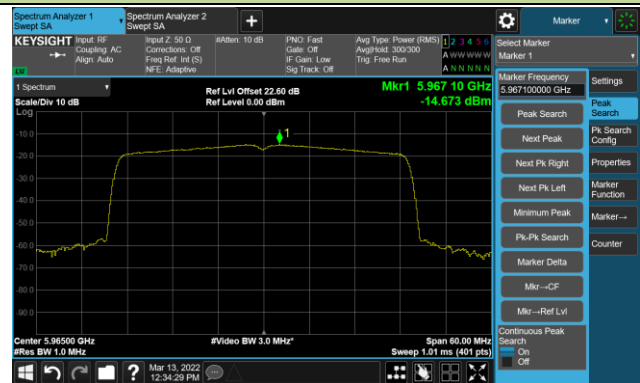

Channel 51 (6205MHz)

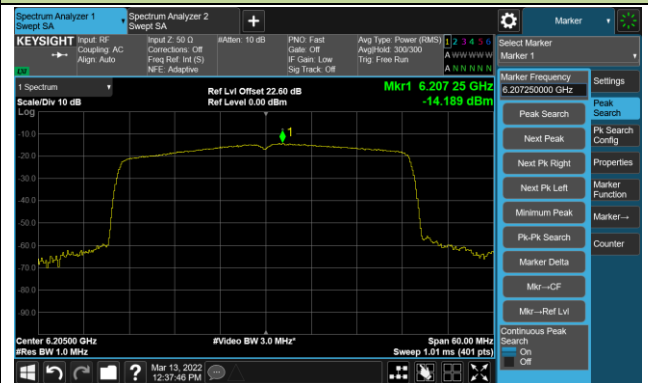

Channel 91 (6405MHz)

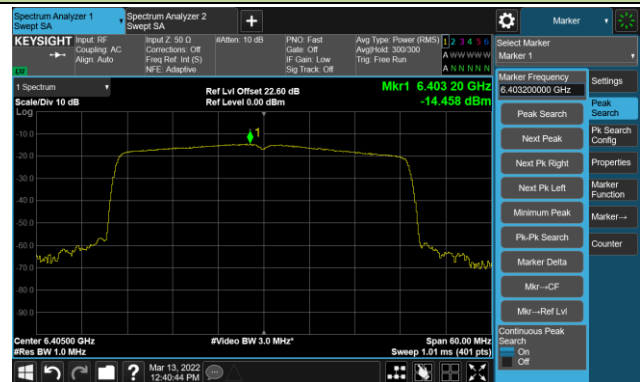

Channel 99 (6445MHz)

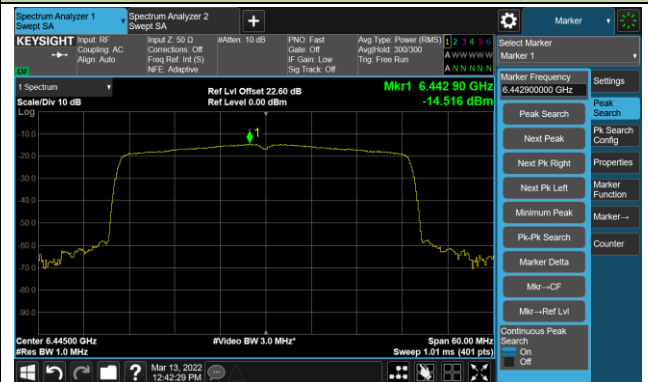

Channel 107 (6485MHz)



Channel 115 (6525MHz)





802.11ax-HE40 Power Spectral Density – Ant 0

Channel 123 (6565MHz)

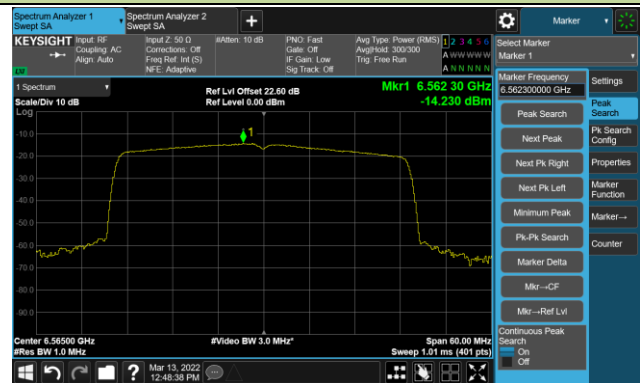

Channel 147 (6685MHz)



Channel 187 (6885MHz)

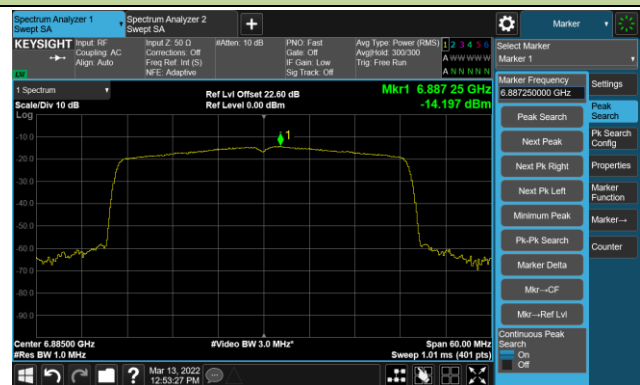

Channel 195 (6925MHz)

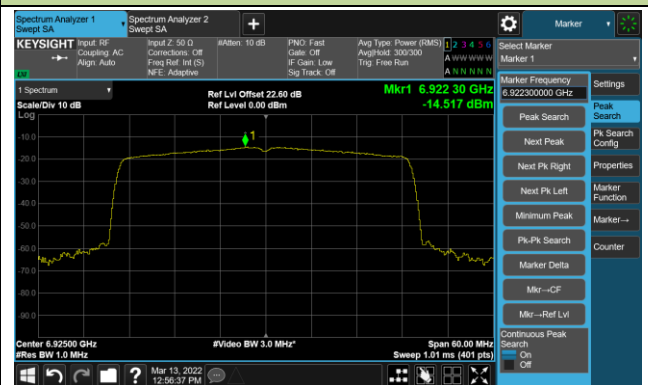

Channel 211 (7005MHz)



Channel 227 (7085MHz)

