





FCC AND ISCED CERTIFICATION TEST REPORT

Applicant:	Guangzhou Shikun Electronics Co., Ltd
Address:	NO.6 Liankun Road, Huangpu District, Guangzhou, China
Manufacturer:	Guangzhou Shikun Electronics Co., Ltd
Address:	NO.6 Liankun Road, Huangpu District, Guangzhou, China
Product Description:	IEEE 802.11b/g/n/a/ac/ax 2T2R USB WiFi Module Integrated BT 2.1+EDR/4.2/5.2
Brand Name:	N/A
Tested Model:	SKI.WB920TU.2
FCC ID:	2AR82-SKIWB920TU2
IC:	24728-SKIWB920TU2
Report No.:	JCF230821202-002
Received Date:	Aug. 24, 2023
Tested Date:	Aug. 24, 2023 - Sep. 22, 2023
Issued Date:	Oct. 20, 2023
Test Standards:	FCC Rules and Regulations Part 15 Subpart C, RSS-247 Issue 3, Aug. 2023.
Test Procedure:	ANSI C63.10:2013, RSS-Gen Issue 5, A2 (February 2021)
Test Result:	Pass
Prepared By:	
	
<u>Kennys Zhang/Engineer</u>	Date: Oct. 20, 2023
Reviewed By:	
	
<u>Roger Li/Engineer</u>	Date: Oct. 20, 2023
	
Approved By:	
	
<u>Talent Zhang/Engineer</u>	Date: Oct. 20, 2023

Note: The test results in this report apply exclusively to the tested model / sample. Without written approval of Guangzhou Jingce Testing Technology Co., Ltd. the test report shall not be reproduced except in full.

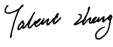
Report Revise Record

Report Version	Revise Time	Issued Date	Valid Version	Notes
V1.0	/	Oct. 20, 2023	Original Report	/

TABLE OF CONTENTS

1. Test Report Declare	5
2. Summary of Test Results	6
3. Test Laboratory	6
4. Equipment Under Test	7
4.1. Description of EUT	7
4.2. Channel List	7
4.3. Test Channel Configuration	7
4.4. Test environment conditions	8
4.5. The Worse Case Power Setting Parameter	8
4.6. Description of Available Antennas	8
5. Description of Test Setup	8
5.1. Accessory	8
5.2. Support Equipment	8
5.3. Test Setup	8
5.4. Setup Diagram for Tests	8
6. Measurement Uncertainty	9
7. Measuring Instrument and Software Used	9
8. On Time and Duty Cycle	11
8.1. Block diagram of test setup	11
8.2. Limits	11
8.3. Procedure	11
8.4. Results	11
8.5. Original test data	12
9. 6 dB DTS Bandwidth and 99 % Bandwidth	14
9.1. Block diagram of test setup	14
9.2. Limits	14
9.3. Test Procedure	14
9.4. Results	14
9.5. Original test data	15
10. Peak Conducted Output Power	19
10.1. Block diagram of test setup	19
10.2. Limits	19
10.3. Test Procedure	19
10.4. Results	19
10.5. Original test data	20
11. Power Spectral Density	22
11.1. Block diagram of test setup	22
11.2. Limits	22
11.3. Test Procedure	22
11.4. Results	22
11.5. Original test data	23
12. Conducted Bandedge and Spurious Emissions	25
12.1. Block diagram of test setup	25
12.2. Limits	25
12.3. Test Procedure	25
12.4. Results	25
12.5. Original test data	27
13. Radiated Emission	35
13.1. Block diagram of test setup	35
13.2. Limit	36
13.3. Test Procedure	38
13.4. Results	41

- 13.5. Original test data 41
- 14. AC Power Line Conducted Emissions 42**
 - 14.1. Block diagram of test setup 42
 - 14.2. Limits 42
 - 14.3. Test procedure 42
 - 14.4. Test result 43
- 15. Antenna Requirements 44**
 - 15.1. Limits 44
 - 15.2. Result 44
- APPENDIX A – Radiated Emission Below 1GHz Test Data 45**
- APPENDIX B – Radiated Emission Above 1GHz Test Data 47**

1. Test Report Declare

Applicant:	Guangzhou Shikun Electronics Co., Ltd
Address:	NO.6 Liankun Road, Huangpu District, Guangzhou, China
Manufacturer:	Guangzhou Shikun Electronics Co., Ltd
Address:	NO.6 Liankun Road, Huangpu District, Guangzhou, China
Product Name:	IEEE 802.11b/g/n/a/ac/ax 2T2R USB WiFi Module Integrated BT 2.1+EDR/4.2/5.2
Brand Name:	N/A
Model Name:	SKI.WB920TU.2
Difference Description:	N/A

We Declare:

The equipment described above is tested by Guangzhou Jingce Testing Technology Co., Ltd. and in the configuration tested the equipment complied with the standards specified above. The test results are contained in this test report and Guangzhou Jingce Testing Technology Co., Ltd. is assumed of full responsibility for the accuracy and completeness of these tests.

2. Summary of Test Results

Summary of Test Results			
Clause	Test Items	FCC/ISED Rules	Test Results
1	6 dB Bandwidth and 99 % Occupied Bandwidth	FCC Part 15.247 (a) (2) RSS-247 Clause 5.2 (a) ISED RSS-Gen Clause 6.7	Pass
2	Peak Conducted Output Power	FCC Part 15.247 (b) (3) RSS-247 Clause 5.4 (d)	Pass
3	Power Spectral Density	FCC Part 15.247 (e) RSS-247 Clause 5.2 (b)	Pass
4	Conducted Bandedge and Spurious Emission	FCC Part 15.247 (d) RSS-247 Clause 5.5	Pass
5	Radiated Bandedge and Spurious Emission	FCC Part 15.247 (d) FCC Part 15.209 FCC Part 15.205 RSS-247 Clause 5.5 RSS-GEN Clause 8.9	Pass
6	Conducted Emission Test For AC Power Port	FCC Part 15.207 RSS-GEN Clause 8.8	N/A
7	Antenna Requirement	FCC Part 15.203 RSS-GEN Clause 6.8	Pass

3. Test Laboratory

Guangzhou Jingce Testing Technology Co., Ltd.

Add.: No.192, Kezhu Road, Huangpu District, Guangzhou, Guangdong, China

Association for Laboratory Accreditation(A2LA). Certificate Number: 6594.01

FCC Designation Number: CN1331. Test Firm Registration Number: 360543

IC Test Firm Registration Number: 28796

Conformity Assessment Body identifier: CN0138

4. Equipment Under Test

4.1. Description of EUT

EUT Name:	IEEE 802.11b/g/n/a/ac/ax 2T2R USB WiFi Module Integrated BT 2.1+EDR/4.2/5.2
Model Number:	SKI.WB920TU.2
EUT Function Description:	Please reference user's manual
Power Supply:	DC 3.3V+/-0.3
Hardware Version:	N/A
Software Version:	N/A
Radio Specification:	Bluetooth V5.2
Operation Frequency:	2402 MHz - 2480 MHz
Modulation:	GFSK
Data Rate:	1Mbps, 2Mbps,
Antenna Type:	External Antenna, MAX. Gain: 2.71 dBi

Note 1: EUT is the ab. of equipment under test.

Note 2: The antenna gain is declared by the customer and the laboratory is not responsible for the accuracy of the antenna gain.

4.2. Channel List

Channel	Frequency (MHz)	Channel	Frequency (MHz)	Channel	Frequency (MHz)	Channel	Frequency (MHz)
0	2402	11	2424	22	2446	33	2468
1	2404	12	2426	23	2448	34	2470
2	2406	13	2428	24	2450	35	2472
3	2408	14	2430	25	2452	36	2474
4	2410	15	2432	26	2454	37	2476
5	2412	16	2434	27	2456	38	2478
6	2414	17	2436	28	2458	39	2480
7	2416	18	2438	29	2460	/	/
8	2418	19	2440	30	2462	/	/
9	2420	20	2442	31	2464	/	/
10	2422	21	2444	32	2468	/	/

4.3. Test Channel Configuration

Tested mode, channel, information		
Mode	Channel	Frequency (MHz)
GFSK 1M	LCH:CH0	2402
	MCH:CH19	2440
	HCH:CH39	2480
GFSK 2M	LCH:CH0	2402
	MCH:CH19	2440
	HCH:CH39	2480

4.4. Test environment conditions

During the measurement the environmental conditions were within the listed ranges:

Temperature range:	21-25 °C
Humidity range:	40-75%
Pressure range:	86-106 kPa

4.5. The Worse Case Power Setting Parameter

The Worse Case Power Setting Parameter under 2400 ~ 2483.5MHz Band				
Test Software		WCN_Combo_Tool		
Modulation Type	Transmit Antenna Number	Test Software Setting Value		
		CH 00	CH 39	CH 78
GFSK 1M	1	Default	Default	Default
GFSK 2M	1	Default	Default	Default

4.6. Description of Available Antennas

Test Mode	Transmit and Receive Mode	Description
GFSK 1M	<input checked="" type="checkbox"/> 1TX, 1RX	Antenna 1 can be used as transmitting/receiving antenna.
GFSK 2M	<input checked="" type="checkbox"/> 1TX, 1RX	Antenna 1 can be used as transmitting/receiving antenna.

5. Description of Test Setup

5.1. Accessory

Description of Accessories	Manufacturer	Model Number	Description	Remark
/	/	/	/	/

5.2. Support Equipment

Equipment	Brand Name	Model Name	P/N
PC	Lenovo	T480	/

5.3. Test Setup

The EUT can work in Fixed Frequency mode.

5.4. Setup Diagram for Tests



6. Measurement Uncertainty

Where relevant, the following measurement uncertainty levels have been estimated for tests performed on the apparatus:

Test Item	Uncertainty
AC Power Conduction emission	1.37 dB
All Radiated emissions	5.4dB
Conducted emissions	3.09 dB
Occupied Channel Bandwidth	1.1%
Conducted Output power	0.82dB
Power Spectral Density	0.82dB

Note: This uncertainty represents an expanded uncertainty expressed at approximately the 95 % confidence level using a coverage factor of $k = 2$.

7. Measuring Instrument and Software Used

TS Test System						
Used	Equipment	Manufacturer	Model No.	Serial No.	Last Cal.	Due. Date
<input checked="" type="checkbox"/>	Spectrum Analyzer	Keysight	N9030B	MY56320512	Sep. 12, 2023	Sep. 11, 2024
<input checked="" type="checkbox"/>	Vector Signal Generator	Keysight	N5182B	MY57300334	Sep. 12, 2023	Sep. 11, 2024
<input checked="" type="checkbox"/>	Signal Generator	Keysight	N5171B	MY57280639	Sep. 12, 2023	Sep. 11, 2024
<input checked="" type="checkbox"/>	DC POWER	Keysight	E342A	MY59020356	Jul. 14, 2023	Jul. 13, 2024
<input checked="" type="checkbox"/>	Incubator thermometer	GWS	EL-02JA	21107288	Sep. 12, 2023	Sep. 11, 2024
<input checked="" type="checkbox"/>	Control unit(Power sensor)	Tonscend	JS0806-2	/	Sep. 12, 2023	Sep. 11, 2024
<input checked="" type="checkbox"/>	Wideband radio communication tester	R&S	CMW500	163478	Jul. 11, 2023	Jul. 10, 2024
<input checked="" type="checkbox"/>	Spectrum Analyzer	Keysight	N9020B	MY60112206	Sep. 12, 2023	Sep. 12, 2024
<input checked="" type="checkbox"/>	Control unit(Power sensor)	Tonscend	JS0806-2	21H8060465	Sep. 12, 2023	Sep. 12, 2024
Software						
Used	Description	Manufacturer	Name	Version		
<input checked="" type="checkbox"/>	Test software	TS+	JS1120-3	V3.3.10		
RSE Test System						
Used	Equipment	Manufacturer	Model No.	Serial No.	Last Cal.	Due. Date
<input checked="" type="checkbox"/>	EMI Receiver	R&S	ESW	101685	Jul. 12, 2023	Jul. 11, 2024
<input checked="" type="checkbox"/>	Bilog Antenna	Schwarzbeck	VULB 9163	01416	Mar. 21, 2023	Mar. 20, 2024
<input checked="" type="checkbox"/>	Horn Antenna 1	Schwarzbeck	BBHA 9120 D	02411	May. 25, 2023	May. 24, 2024
<input checked="" type="checkbox"/>	Horn Antenna 2	ETS	BBHA 9170	1090	Sep. 04, 2023	Sep. 03, 2024
<input checked="" type="checkbox"/>	loop-antenna	Schwarzbeck	FMZB 1513-60	00030	Jan.14,2023	Jan.13,2024
<input checked="" type="checkbox"/>	Signal Pre-Amplifier	Tonscend	TAP01018050	AP21C806122	Jul. 10, 2023	Jul. 09, 2024

<input checked="" type="checkbox"/>	Signal Pre-Amplifier	Tonscend	TAP9K3G32	AP20K806104	Jul. 10, 2023	Jul. 09, 2024
<input checked="" type="checkbox"/>	Signal Pre-Amplifier	ETS	3116C-PA	00217677	Aug. 24, 2023	Aug. 23, 2024
<input checked="" type="checkbox"/>	3m Fully-anechoic Chamber	ETS	RFD-100	/	Apr. 24, 2021	Apr. 23, 2024
Software						
Used	Description	Manufacturer	Name		Version	
<input checked="" type="checkbox"/>	Test software	TS+	TS+		V3.0.0.4	
Conducted Emission Test For AC Power Port						
Used	Equipment	Manufacturer	Model No.	Serial No.	Last Cal.	Due. Date
<input checked="" type="checkbox"/>	LISN	R&S	ENV216	102154	Jul. 10, 2023	Jul. 09, 2024
<input checked="" type="checkbox"/>	EMI Receiver	R&S	ESR3	102509	Jul. 12, 2023	Jul. 11, 2024
Software						
Used	Description	Manufacturer	Name		Version	
<input checked="" type="checkbox"/>	Test software	EZ	EZ-EMC		EMEC-3A1	
Other Instrument						
Used	Equipment	Manufacturer	Model No.	Serial No.	Last Cal.	Due. Date
<input checked="" type="checkbox"/>	Temperature & Humidity	Temperature	HTC-1	/	Nov. 25, 2022	Nov. 24, 2023

8. On Time and Duty Cycle

8.1. Block diagram of test setup

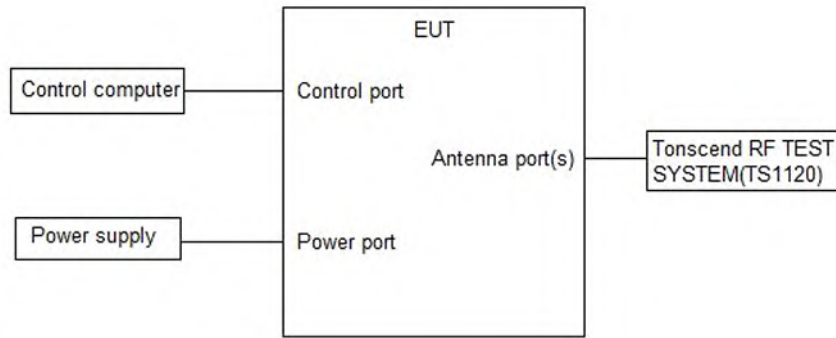

8.2. Limits

None; for reporting purposes only

8.3. Procedure

KDB 558074 Zero-Span Spectrum Analyzer Method

8.4. Results

Test Mode	Ant.	Freq. (MHz)	ON Time (ms)	Period (ms)	Duty Cycle (%)	Duty Cycle Factor(dB)
BLE_1M	Ant1	2402	2.13	2.50	85.20	0.70
		2440	2.13	2.50	85.20	0.70
		2480	2.13	2.50	85.20	0.70
BLE_2M	Ant1	2402	1.07	1.87	57.22	2.42
		2440	1.07	1.87	57.22	2.42
		2480	1.07	1.87	57.22	2.42

Note: Duty Cycle Correction Factor = $10\log(1/x)$.

Where: x is Duty Cycle(Linear)

Where: T is On Time (transmit duration)

If that calculated VBW is not available on the analyzer, then the next higher value should be used.

8.5. Original test data



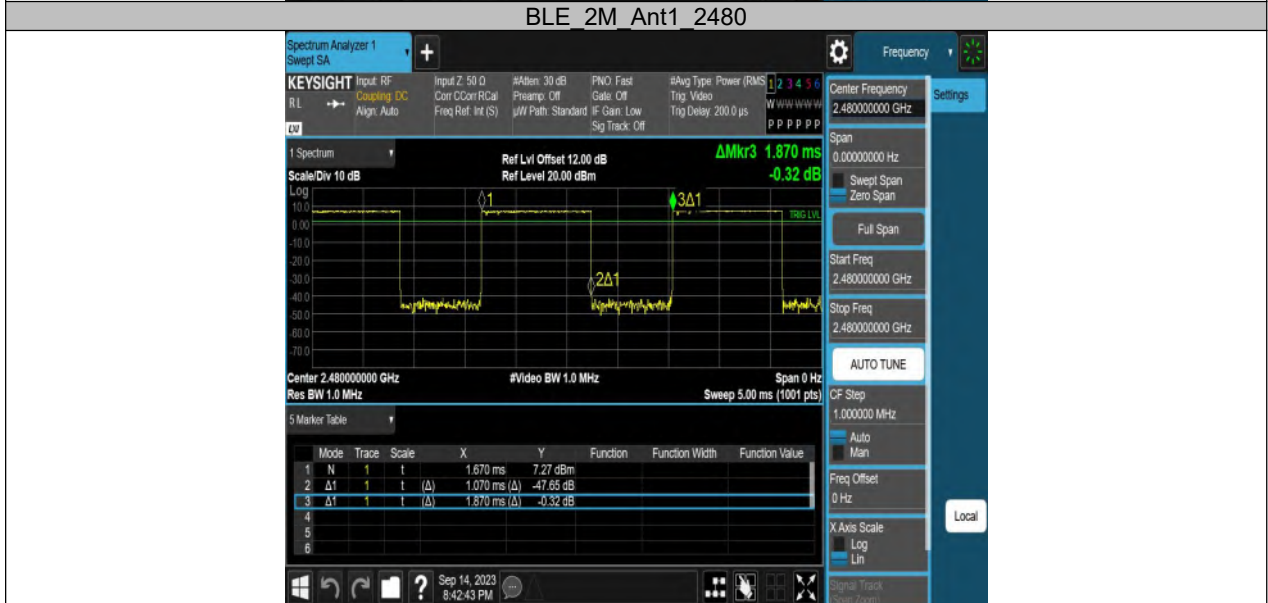
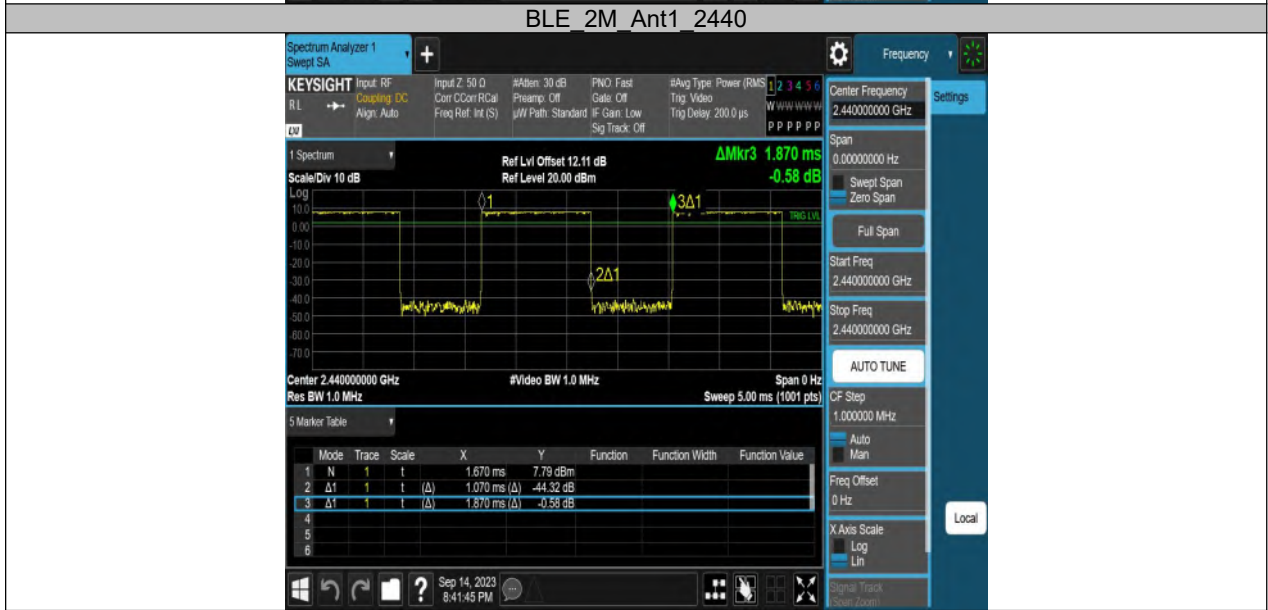

9. 6 dB DTS Bandwidth and 99 % Bandwidth

9.1. Block diagram of test setup

Same as section 8.1

9.2. Limits

CFR 47FCC Part15 (15.247) Subpart C ISED RSS-247 ISSUE 3			
Section	Test Item	Limit	Frequency Range (MHz)
CFR 47 FCC 15.247(a)(2) ISED RSS-247 5.2 (a)	6 dB Bandwidth	>= 500 kHz	2400-2483.5
ISED RSS-Gen Clause 6.7	99 % Occupied Bandwidth	For reporting purposes only.	2400-2483.5

9.3. Test Procedure

Connect the UUT to the spectrum analyzer and use the following settings:

Center Frequency	The center frequency of the channel under test
Detector	Peak
RBW	For 6 dB Bandwidth :100 kHz For 99 % Occupied Bandwidth :1 % to 5 % of the occupied bandwidth
VBW	For 6 dB Bandwidth : $\geq 3 \times$ RBW For 99 % Occupied Bandwidth : $\geq 3 \times$ RBW
Trace	Max hold
Sweep	Auto couple

Allow the trace to stabilize and measure the maximum width of the emission that is constrained by the frequencies associated with the two outermost amplitude points (upper and lower frequencies) that are attenuated by 6 dB/99 % relative to the maximum level measured in the fundamental emission.

9.4. Results

6 dB bandwidth:

Test Mode	Ant.	Freq. (MHz)	DTS BW (MHz)	FL (MHz)	FH (MHz)	Limit (MHz)	Verdict
BLE_1M	Ant1	2402	0.688	2401.668	2402.356	0.5	PASS
		2440	0.736	2439.632	2440.368	0.5	PASS
		2480	0.656	2479.672	2480.328	0.5	PASS
BLE_2M	Ant1	2402	1.024	2401.492	2402.516	0.5	PASS
		2440	1.236	2439.384	2440.620	0.5	PASS
		2480	1.312	2479.316	2480.628	0.5	PASS

99% bandwidth

Test Mode	Antenna	Frequency (MHz)	OCB (MHz)	FL(MHz)	FH(MHz)
BLE_1M	Ant1	2402	1.0592	2401.4816	2402.5408
		2440	1.0541	2439.4868	2440.5409
		2480	1.0594	2479.4839	2480.5433
BLE_2M	Ant1	2402	2.1271	2400.9378	2403.0649
		2440	1.9741	2439.0328	2441.0069
		2480	2.1174	2478.9419	2481.0593

9.5. Original test data

6 dB bandwidth:





99% bandwidth



BLE_2M_Ant1_2402



10. Peak Conducted Output Power

10.1. Block diagram of test setup

Same as section 8.1

10.2. Limits

CFR 47 FCC Part15 (15.247) Subpart C ISED RSS-247 ISSUE 3			
Section	Test Item	Limit	Frequency Range (MHz)
CFR 47 FCC 15.247(b)(3) ISED RSS-247 5.4 (d)	Peak Output Power	1 watt or 30 dBm	2400 - 2483.5

10.3. Test Procedure

Connect EUT's antenna output to spectrum analyzer by RF cable.

99% Bandwidth set the spectrum analyzer as follows:

RBW:	30 kHz
VBW:	100 kHz
Detector Mode:	Peak
Sweep time:	auto
Trace mode	Max hold

6 dB Bandwidth set the spectrum analyzer as follows:

RBW:	100 kHz
VBW:	300 kHz
Detector Mode:	Peak
Sweep time:	auto
Trace mode	Max hold

Allow the trace to stabilize, measure the 6 dB and 99% bandwidth of signal.

10.4. Results

Test Mode	Ant.	Freq (MHz)	Conducted Peak Power (dBm)	Conducted Limit (dBm)	EIRP (dBm)	EIRP Limit (dBm)	Verdict
BLE_1M	Ant1	2402	2.29	≤30	5	≤36	PASS
		2440	2.42	≤30	5.13	≤36	PASS
		2480	2.09	≤30	4.8	≤36	PASS
BLE_2M	Ant1	2402	2.23	≤30	4.94	≤36	PASS
		2440	2.4	≤30	5.11	≤36	PASS
		2480	2.04	≤30	4.75	≤36	PASS

10.5. Original test data

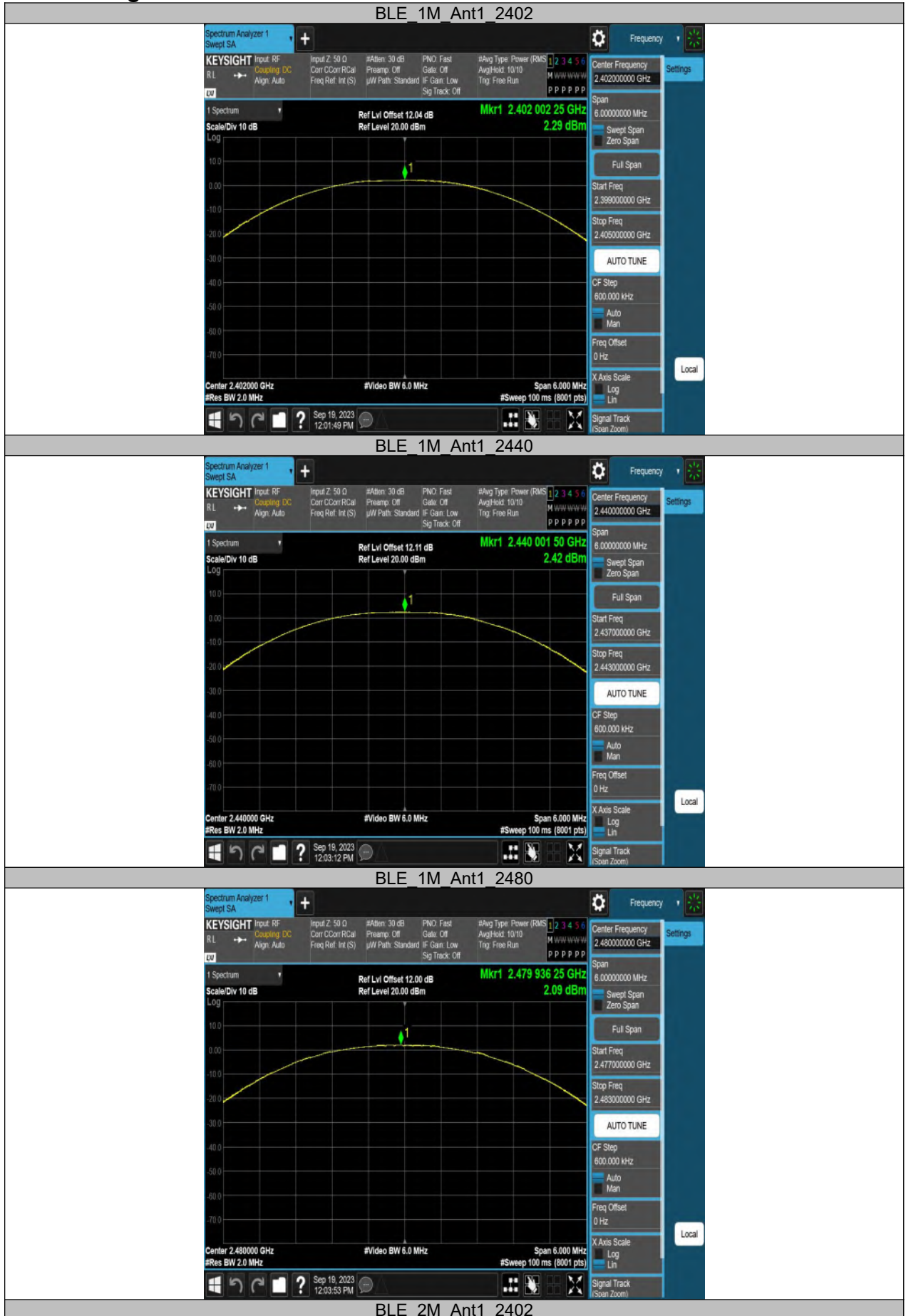



11. Power Spectral Density

11.1. Block diagram of test setup

Same as section 8.1

11.2. Limits

CFR 47 FCC Part15 (15.247) Subpart C ISED RSS-247 ISSUE 3			
Section	Test Item	Limit	Frequency Range (MHz)
CFR 47 FCC §15.247 (e) ISED RSS-247 5.2 (b)	Power Spectral Density	8 dBm in any 3 kHz band	2400 - 2483.5

11.3. Test Procedure

Connect the UUT to the spectrum analyzer and use the following settings:

Center Frequency	The center frequency of the channel under test
Detector	Peak
RBW	$3 \text{ kHz} \leq \text{RBW} \leq 100 \text{ kHz}$
VBW	$\geq 3 \times \text{RBW}$
Span	1.5 x DTS bandwidth
Trace	Max hold
Sweep time	Auto couple.

Allow trace to fully stabilize and use the peak marker function to determine the maximum amplitude level within the RBW.

If measured value exceeds limit, reduce RBW (no less than 3 kHz) and repeat.

11.4. Results

Test Mode	Ant.	Freq. (MHz)	Result (dBm/3kHz)	Limit (dBm/3kHz)	Verdict
BLE_1M	Ant1	2402	-15.35	≤ 8.00	PASS
		2440	-14.68	≤ 8.00	PASS
		2480	-15.44	≤ 8.00	PASS
BLE_2M	Ant1	2402	-10.81	≤ 8.00	PASS
		2440	-14.54	≤ 8.00	PASS
		2480	-11.65	≤ 8.00	PASS

11.5. Original test data

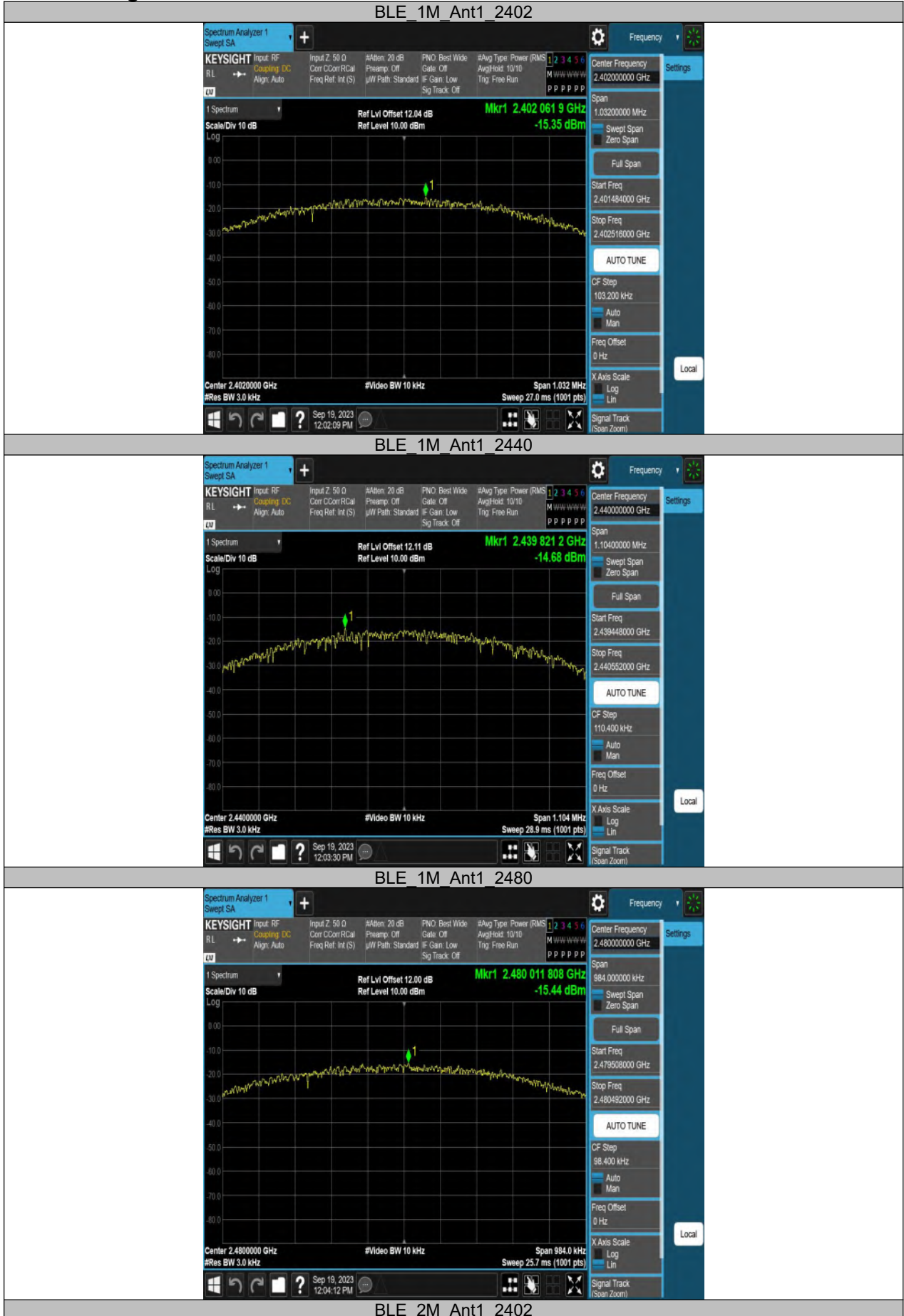

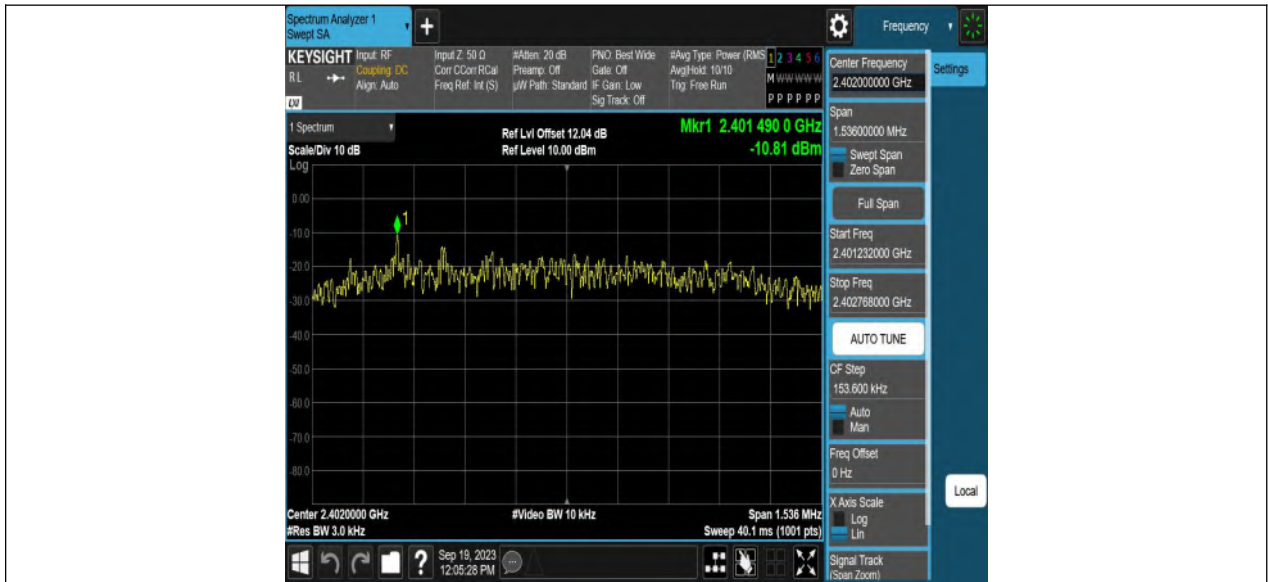

BLE 2M Ant1 2440



BLE 2M Ant1 2480

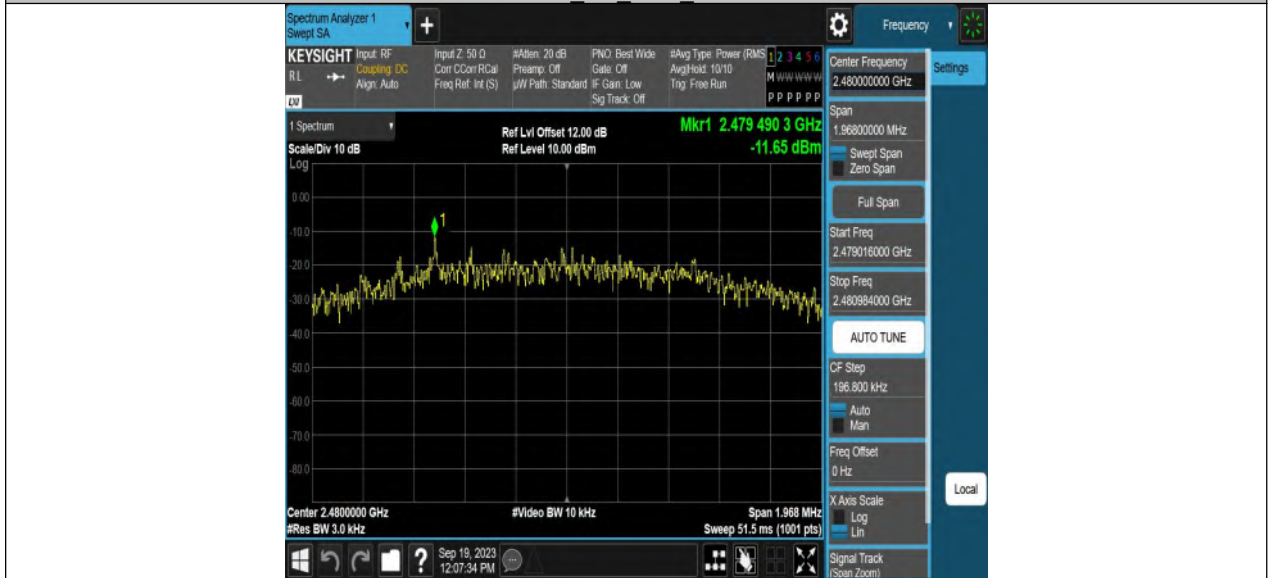

12. Conducted Bandedge and Spurious Emissions

12.1. Block diagram of test setup

Same as section 8.1

12.2. Limits

CFR 47 FCC Part15 (15.247) Subpart C ISED RSS-247 ISSUE 3		
Section	Test Item	Limit
CFR 47 FCC §15.247 (d) ISED RSS-247 5.5	Conducted Band edge and Spurious Emissions	at least 20 dB below that in the 100 kHz bandwidth within the band that contains the highest level of the desired power

12.3. Test Procedure

Center Frequency	The center frequency of the channel under test
Detector	Peak
RBW	100 kHz
VBW	$\geq 3 \times \text{RBW}$
Span	$\geq 1.5 \times \text{DTS bandwidth}$
Trace	Max hold
Sweep time	Auto couple

Connect the UUT to the spectrum analyzer and use the following settings:

Use the peak marker function to determine the maximum peak power level to establish the reference level.

Span	Set the center frequency and span to encompass frequency range to be measured
Detector	Peak
RBW	100 kHz
VBW	$\geq 3 \times \text{RBW}$
measurement points	$\geq \text{span}/\text{RBW}$
Trace	Max hold
Sweep time	Auto couple

Use the peak marker function to determine the maximum amplitude level.

12.4. Results

Band edge

Test Mode	Ant.	Ch Name	Freq. (MHz)	Ref Level (dBm)	Result (dBm)	Limit (dBm)	Verdict
BLE_1M	Ant1	Low	2402	0.87	-49.03	≤ -19.13	PASS
		High	2480	1.26	-47.43	≤ -18.74	PASS
BLE_2M	Ant1	Low	2402	-1.12	-37.14	≤ -21.12	PASS
		High	2480	-1.30	-49.37	≤ -21.3	PASS

Spurious Emissions

Test Mode	Ant.	Freq. (MHz)	Freq Range (MHz)	Ref Level (dBm)	Result (dBm)	Limit (dBm)	Verdict
BLE_1M	Ant1	2402	30~1000	0.87	-61.95	≤-19.13	PASS
			1000~26500	0.87	-49.92	≤-19.13	PASS
		2440	30~1000	0.18	-61.16	≤-19.82	PASS
			1000~26500	0.18	-49.43	≤-19.82	PASS
		2480	30~1000	1.26	-62.05	≤-18.74	PASS
			1000~26500	1.26	-50.41	≤-18.74	PASS
BLE_2M	Ant1	2402	30~1000	-1.12	-61.46	≤-21.12	PASS
			1000~26500	-1.12	-50.32	≤-21.12	PASS
		2440	30~1000	-1.54	-62.21	≤-21.54	PASS
			1000~26500	-1.54	-49.7	≤-21.54	PASS
		2480	30~1000	-1.30	-62.07	≤-21.3	PASS
			1000~26500	-1.30	-50.24	≤-21.3	PASS

12.5. Original test data

Reference level

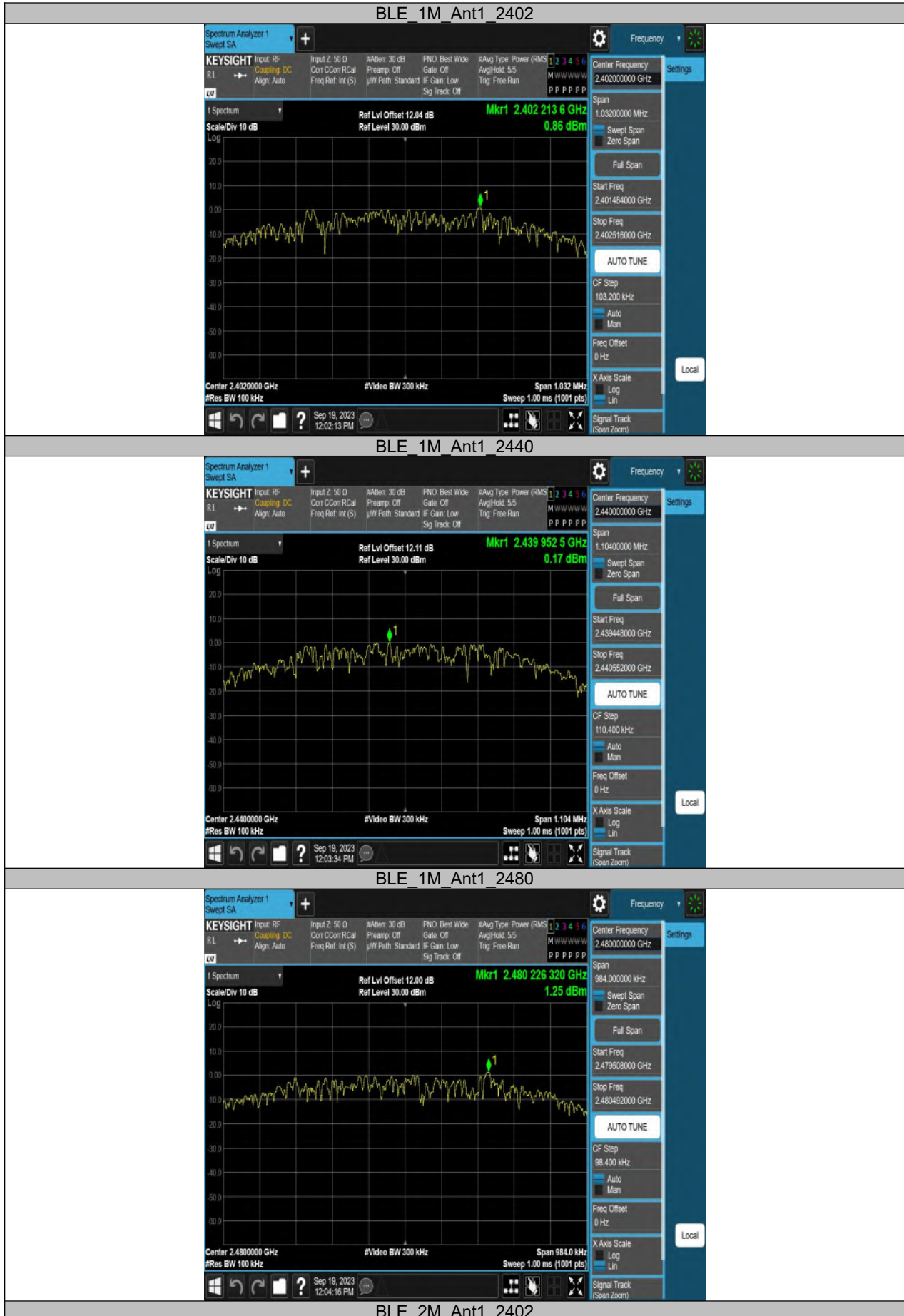



Band edge:

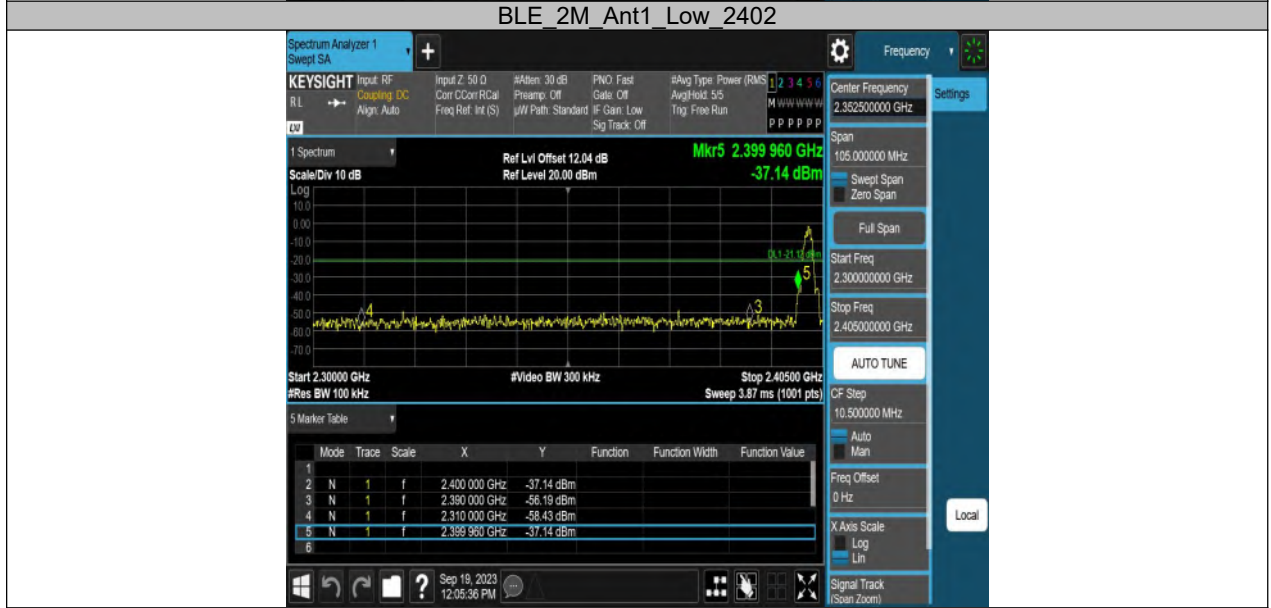
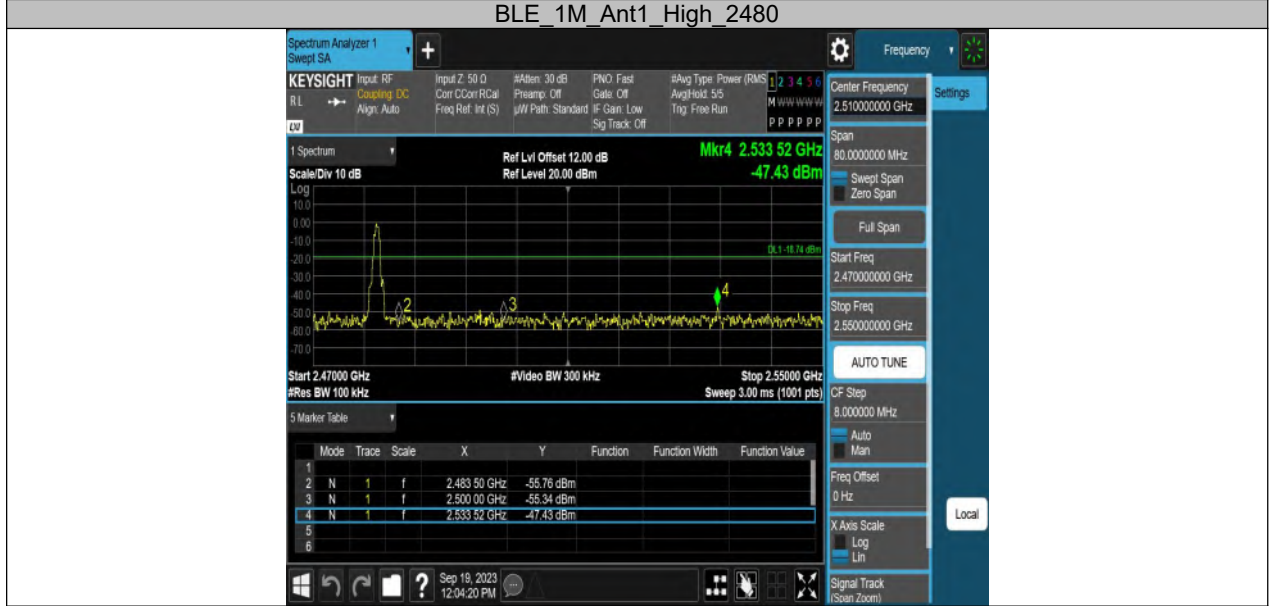
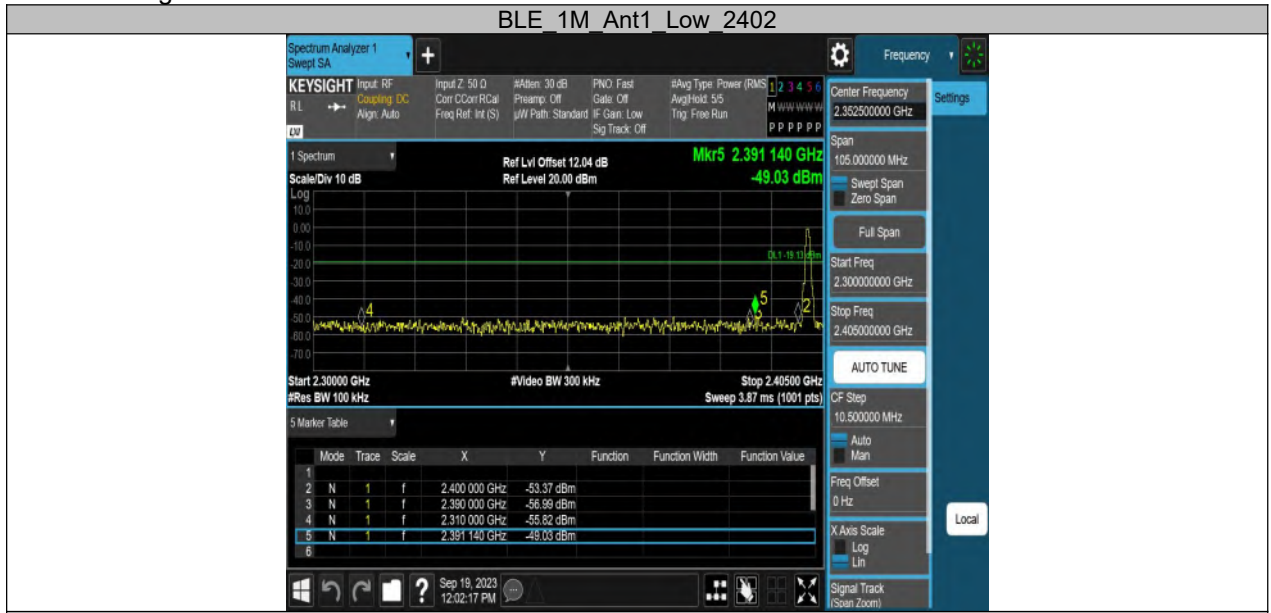

BLE 2M Ant1 High 2480



Spurious Emissions:

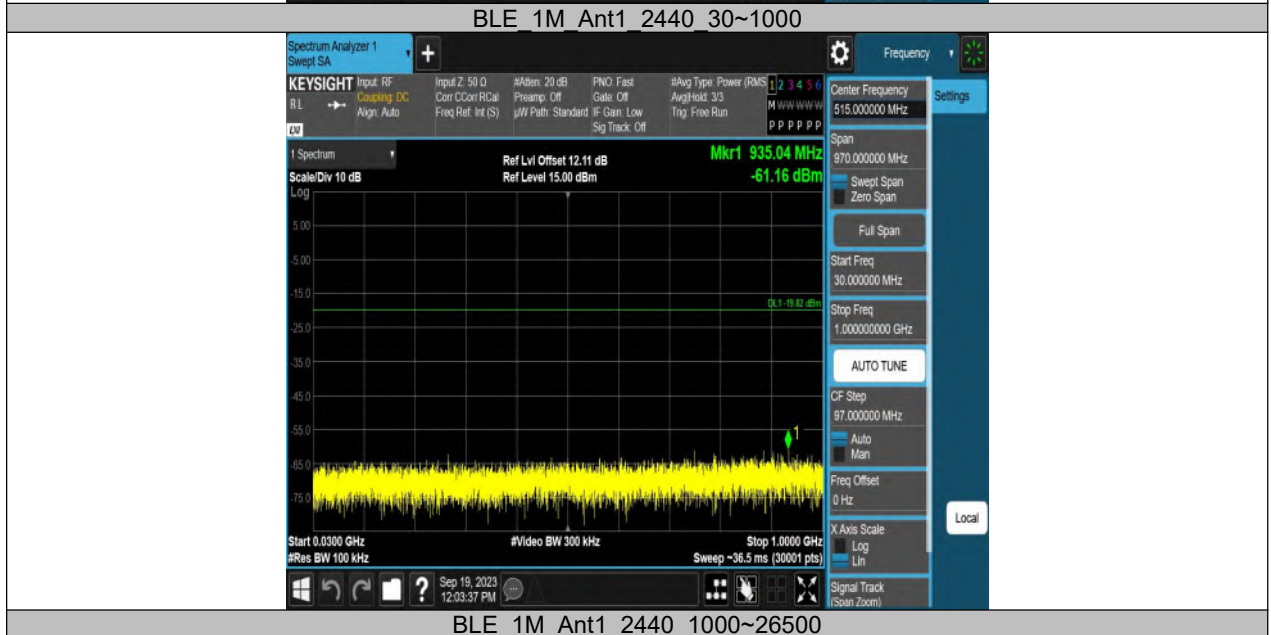
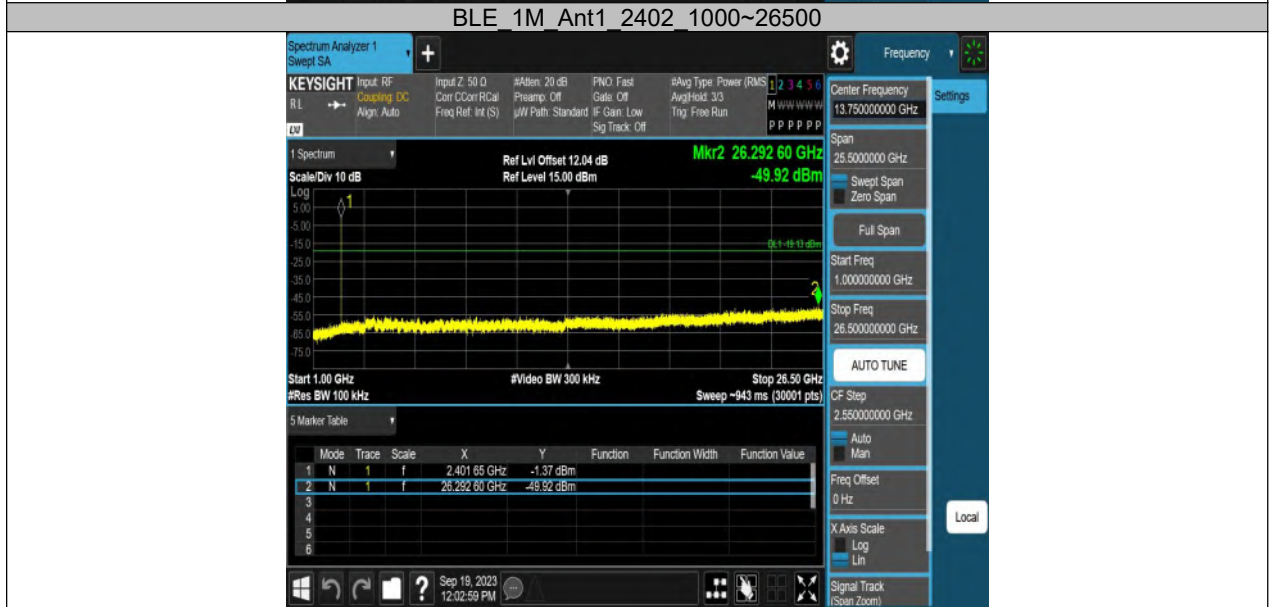
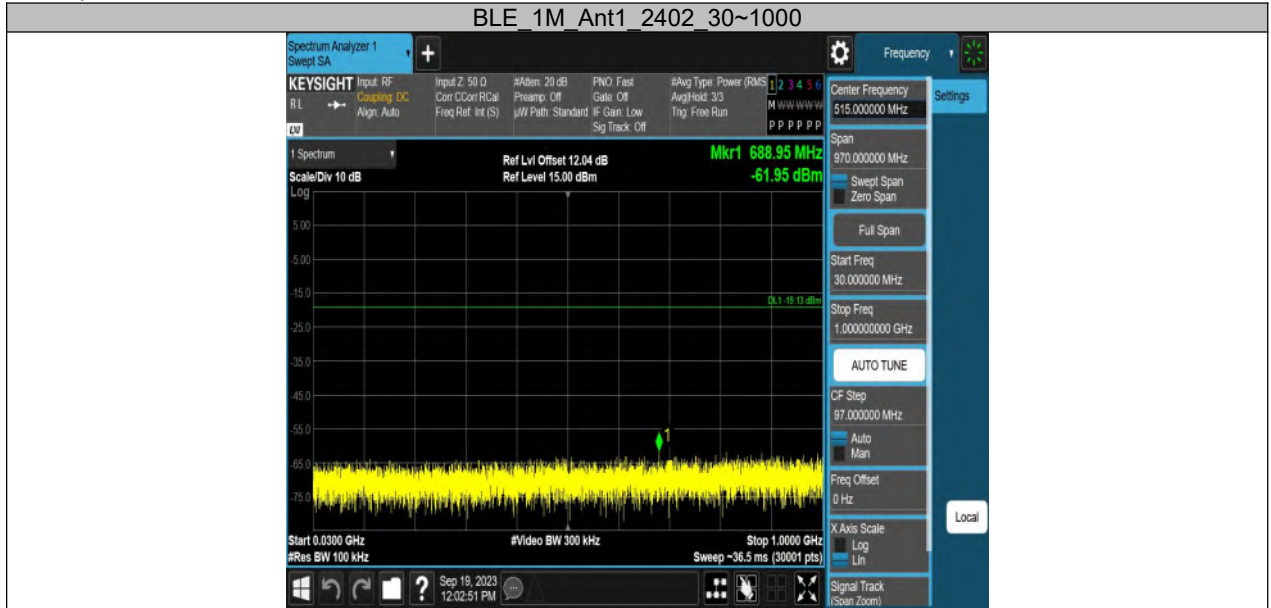





BLE 2M Ant1 2402 1000~26500



BLE 2M Ant1 2440 30~1000

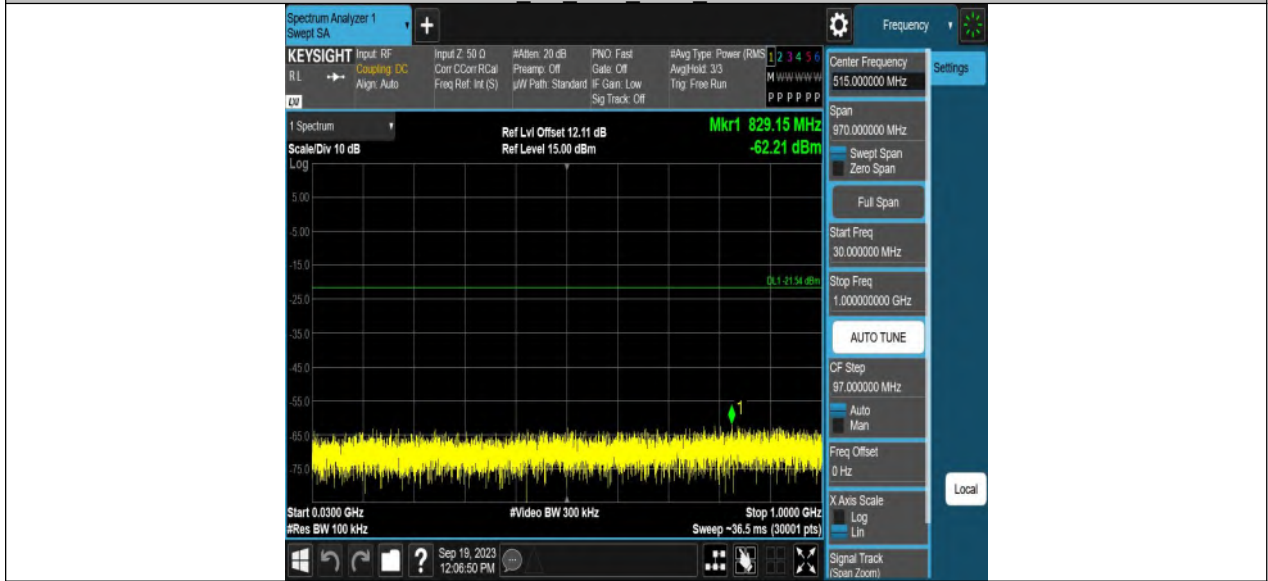

BLE 2M Ant1 2440 1000~26500

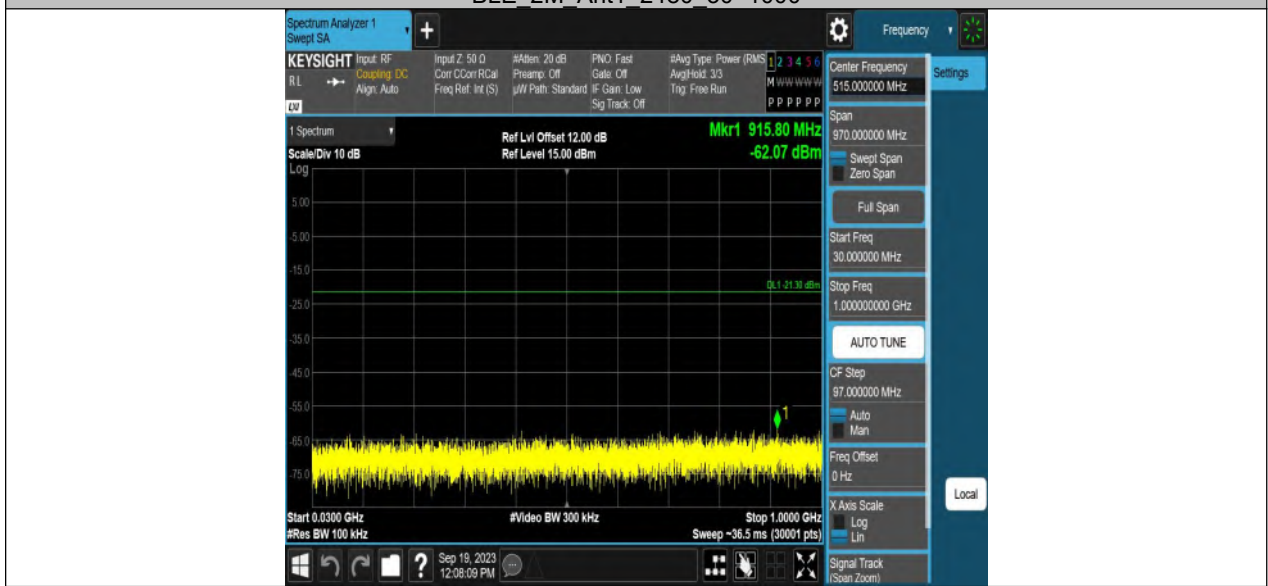

13. Radiated Emission

13.1. Block diagram of test setup

In 3 m Anechoic Chamber, test setup diagram for 9 kHz - 30 MHz:

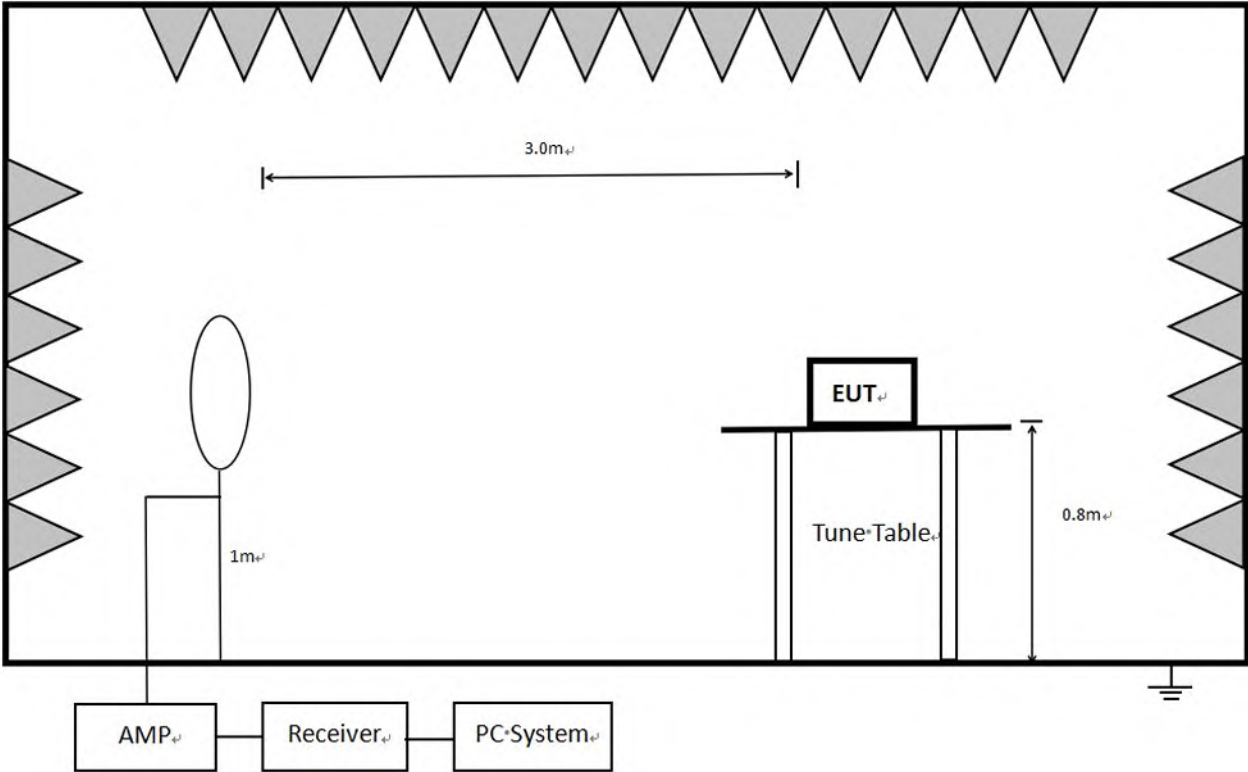

In 3 m Anechoic Chamber, test setup diagram for 30 MHz - 1 GHz:

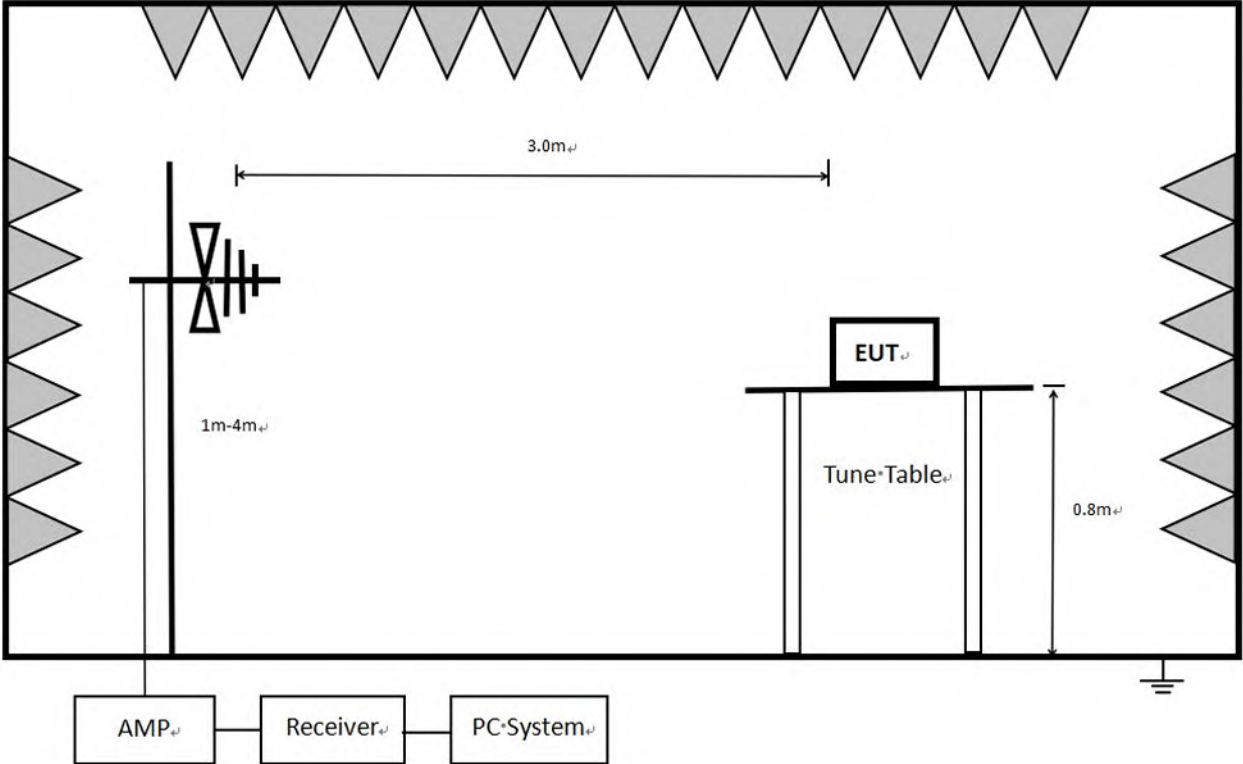

In 3 m Anechoic Chamber, test setup diagram for frequency above 1 GHz:

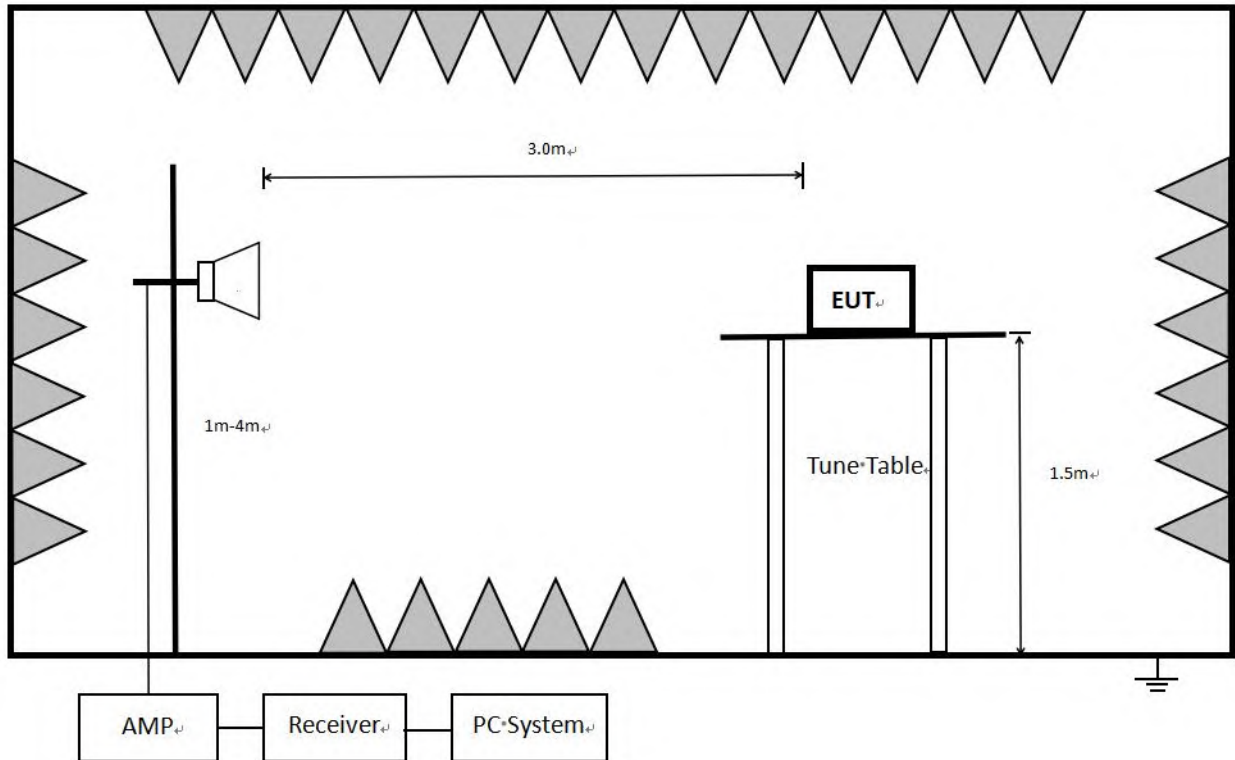

Note: For harmonic emissions test an appropriate high pass filter was inserted in the input port of AMP.

13.2. Limit

(1) FCC 15.205 Restricted frequency band

MHz	MHz	MHz	GHz
0.090-0.110	16.42-16.423	399.9-410	4.5-5.15
¹ 0.495-0.505	16.69475-16.69525	608-614	5.35-5.46
2.1735-2.1905	16.80425-16.80475	960-1240	7.25-7.75
4.125-4.128	25.5-25.67	1300-1427	8.025-8.5
4.1772&4.17775	37.5-38.25	1435-1626.5	9.0-9.2
4.2072&4.20775	73-74.6	1645.5-1646.5	9.3-9.5
6.215-6.218	74.8-75.2	1660-1710	10.6-12.7
6.26775-6.26825	108-121.94	1718.8-1722.2	13.25-13.4
6.31175-6.31225	123-138	2200-2300	14.47-14.5
8.291-8.294	149.9-150.05	2310-2390	15.35-16.2
8.362-8.366	156.52475-156.52525	2483.5-2500	17.7-21.4
8.37625-8.38675	156.7-156.9	2690-2900	22.01-23.12
8.41425-8.41475	162.0125-167.17	3260-3267	23.6-24.0
12.29-12.293	167.72-173.2	3332-3339	31.2-31.8
12.51975-12.52025	240-285	3345.8-3358	36.43-36.5
12.57675-12.57725	322-335.4	3600-4400	(²)
13.36-13.41			

¹Until February 1, 1999, this restricted band shall be 0.490-0.510 MHz.

²Above 38.6

(2) FCC 15.209 Limit.

Frequency MHz	Distance Meters	Field Strengths Limit	
		$\mu\text{V}/\text{m}$	$\text{dB}(\mu\text{V})/\text{m}$
0.009 ~ 0.490	300	$2400/F(\text{kHz})$	$67.6-20\log(F)$
0.490 ~ 1.705	30	$24000/F(\text{kHz})$	$87.6-20\log(F)$
1.705 ~ 30.0	30	30	29.54
30 ~ 88	3	100	40.0
88 ~ 216	3	150	43.5
216~960	3	200	46.0
960~1000	3	500	54.0
Above 1000	3	74.0 $\text{dB}(\mu\text{V})/\text{m}$ (Peak) 54.0 $\text{dB}(\mu\text{V})/\text{m}$ (Average)	

Note: (1) At frequencies at or above 30 MHz, measurements may be performed at a distance other than what is specified provided: measurements are not made in the near field except where it can be shown that near field measurements are appropriate due to the characteristics of the device; and it can be demonstrated that the signal levels needed to be measured at the distance employed can be detected by the measurement equipment. Measurements shall not be performed at a distance greater than 30 meters unless it can be further demonstrated that measurements at a distance of 30 meters or less are impractical. When performing measurements at a distance other than that specified, the results shall be extrapolated to the specified distance using an extrapolation factor of 20 dB/decade (inverse linear-distance for field strength measurements; inverse-linear-distance-squared for power density measurements).

(2) At frequencies below 30 MHz, measurements may be performed at a distance closer than that specified in the regulations; however, an attempt should be made to avoid making measurements in the near field. Pending the development of an appropriate measurement procedure for measurements performed below 30 MHz, when performing measurements at a closer distance than specified, the results shall be extrapolated to the specified distance by either making measurements at a minimum of two distances on at least one radial to determine the proper extrapolation factor or by using the square of an inverse linear distance extrapolation factor (40 dB/decade). This paragraph (f) shall not apply to Access BPL devices operating below 30 MHz.

About Restricted bands of operation please refer to RSS-Gen section 8.10 and FCC § 15.205(a),

13.3. Test Procedure

Below 30 MHz:

The setting of the spectrum Analyzer

RBW	300 Hz (From 9 kHz to 0.15 MHz)/ 10 kHz (From 0.15 MHz to 30 MHz)
VBW	1 kHz (From 9 kHz to 0.15 MHz)/ 30 kHz (From 0.15 MHz to 30 MHz)
Sweep	Auto
Trace	Max hold

1. The testing follows the guidelines in ANSI C63.10-2013
2. The EUT was arranged to its worst case and then turntable (from 0 degree to 360 degrees) to find the maximum reading. A pre-amp and a high pass filter are used for the test in order to get better signal level. Both Horizontal, Face-on and Face-off polarizations of the antenna are set to make the measurement.
3. The EUT was placed on a turntable with 80 cm meter above ground.
4. The EUT was set 3 meters from the interference receiving antenna, which was mounted on the top of 1 meter height antenna tower.
5. The radiated emission limits are based on measurements employing a CISPR quasi-peak detector except for the frequency bands 9-90 kHz, 110-490 kHz and above 1000 MHz. Radiated emission limits in these three bands are based on measurements employing an average detector.
6. For measurement below 1 GHz, the initial step in collecting conducted emission data is a spectrum analyzer peak detector mode pre-scanning the measurement frequency range. Significant peaks are then marked and then Quasi Peak detector mode re-measured. If the emission level of the EUT measured by the peak detector is 3 dB lower than the applicable limit, the peak emission level will be reported. Otherwise, the emission measurement will be repeated using the quasi-peak detector and reported.
7. Although these tests were performed other than open field site, adequate comparison measurements were confirmed against 30m open field site. Therefore, sufficient tests were made to demonstrate that the alternative site produces results that correlate with the ones of tests made in an open field site based on KDB 414788.

Below 1 GHz and above 30 MHz:

The setting of the spectrum Analyzer

RBW	100 kHz
VBW	300 kHz
Sweep	Auto
Trace	Max hold

1. The testing follows the guidelines in ANSI C63.10-2013.
2. The EUT was arranged to its worst case and then tune the antenna tower (from 1 m to 4 m) and turntable (from 0 degree to 360 degrees) to find the maximum reading. A pre-amp and a high pass filter are used for the test in order to get better signal level. Both horizontal and vertical polarizations of the antenna are set to make the measurement.
3. The EUT was placed on a turntable with 80 cm above ground.
4. The EUT was set 3 meters from the interference receiving antenna, which was mounted on the top of a variable height antenna tower.
5. For measurement below 1GHz, the initial step in collecting conducted emission data is a spectrum analyzer peak detector mode pre-scanning the measurement frequency range. Significant peaks are then marked and then Quasi Peak detector mode re-measured. If the emission level of the EUT measured by the peak detector is 3 dB lower than the applicable limit, the peak emission level will be reported. Otherwise, the emission measurement will be repeated using the quasi-peak detector and reported.

Above 1 GHz:

RBW	1 MHz
VBW	PEAK: 3 MHz AVG: see note 6
Sweep	Auto
Detector	Peak
Trace	Max hold

1. The testing follows the guidelines in ANSI C63.10-2013.

2. The EUT was arranged to its worst case and then tune the antenna tower (from 1 m to 4 m) and turntable (from 0 degree to 360 degrees) to find the maximum reading. A pre-amp and a high pass filter are used for the test in order to get better signal level. Both horizontal and vertical polarizations of the antenna are set to make the measurement.

3. The EUT was placed on a turntable with 1.5m above ground.

4. The EUT was set 3 meters from the interference receiving antenna, which was mounted on the top of a variable height antenna tower.

5. For measurement above 1GHz, the emission measurement will be measured by the peak detector. This peak level, once corrected, must comply with the limit specified in Section 15.209.

6. For measurements above 1 GHz the resolution bandwidth is set to 1 MHz, then the video bandwidth is set to 3 MHz for peak measurements and 1 MHz resolution bandwidth with 1/T video bandwidth with peak detector for AVG measurements. For the Duty Cycle please refer to clause 8.1.ON TIME AND DUTY CYCLE.

7. Restriction band: Investigated frequency range from 2310 MHz to 2410 MHz and 2470MHz to 2500 MHz.

All restriction band should comply with 15.209, other emission should be at least 20 dB below the fundamental.

Note 1: For all radiated test, EUT in each of three orthogonal axis emissions had been tested, but only the worst case (X axis) data recorded in the report.

Note 2: The EUT does not support simultaneous transmission.

Note 3: The EUT was fully exercised with external accessories during the test. In the case of multiple accessory external ports, an external accessory shall be connected to one of each type of port.

13.4. Results

Pass. (See below detailed test result)

All the emissions except fundamental emission from 9 kHz to 25 GHz were comply with 15.209 limits.

Note1: According exploratory test, the emission levels are 20 dB below the limit detected from 9 kHz to 30 MHz, so the final test was performed with frequency range from 30 MHz to 26 GHz and recorded in below.

Note2: For emissions below 1 GHz, according exploratory explorer test, when change Tx mode and channel, have no distinct influence on emissions level, so for emissions below 1 GHz, the final test was only performed with EUT working in GFSK 1M, Tx 2402 MHz mode.

Note3: For emissions above 1 GHz. If peak results comply with AV limit, AV Result is deemed to comply with AV limit.

13.5. Original test data

Below 1 GHz and above 30 MHz test data Refer to appendix A

Above 1 GHz test data Refer to appendix B

14. AC Power Line Conducted Emissions

14.1. Block diagram of test setup

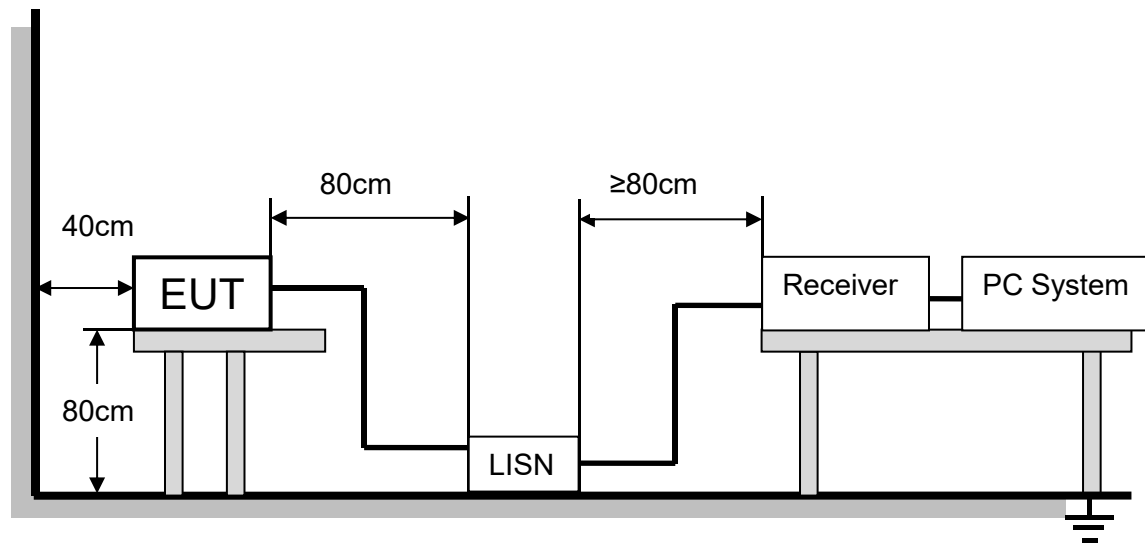

The EUT is put on a table of non-conducting material that is 80 cm high. The vertical conducting wall of shielding is located 40 cm to the rear of the EUT. The power line of the EUT is connected to the AC mains through an Artificial Mains Network (A.M.N.). A EMI Measurement Receiver (R&S Test Receiver ESR3) is used to test the emissions from both sides of AC line. According to the requirements in Section 6.2 of ANSI C63.10-2013. Conducted emissions from the EUT measured in the frequency range between 0.15 MHz and 30 MHz using CISPR Quasi-Peak and average detector mode. The bandwidth of EMI test receiver is set at 9 kHz.

The arrangement of the equipment is installed to meet the standards and operating in a manner, which tends to maximize its emission characteristics in a normal application.

14.2. Limits

Please refer to CFR 47 FCC § 15.207 (a) and ISED RSS-Gen Clause 8.8.

Frequency (MHz)	Quasi-peak	Average
0.15 -0.5	66 - 56 *	56 - 46 *
0.50 -5.0	56.00	46.00
5.0 -30.0	60.00	50.00

Note 1: * Decreasing linearly with logarithm of frequency.

Note 2: The lower limit shall apply at the transition frequencies.

14.3. Test procedure

The EUT and Support equipment, if needed, were put placed on a non-metallic table, 80cm above the ground plane.

Configuration EUT to simulate typical usage as described in clause 2.4 and test equipment as described in clause 10.2 of this report.

All I/O cables were positioned to simulate typical actual usage as per ANSI C63.10.

All support equipment power received from a second LISN.

Emissions were measured on each current carrying line of the EUT using an EMI Test Receiver connected to the LISN powering the EUT.

The Receiver scanned from 150 kHz to 30 MHz for emissions in each of the test modes.

During the above scans, the emissions were maximized by cable manipulation.

The test mode(s) described in clause 2.4 were scanned during the preliminary test.

After the preliminary scan, we found the test mode producing the highest emission level.

The EUT configuration and worse cable configuration of the above highest emission levels were recorded for reference of the final test.

EUT and support equipment were set up on the test bench as per the configuration with highest emission level in the preliminary test.

A scan was taken on both power lines, Neutral and Line, recording at least the six highest emissions.

Emission frequency and amplitude were recorded into a computer in which correction factors were used to calculate the emission level and compare reading to the applicable limit.

The test data of the worst-case condition(s) was recorded.

The bandwidth of test receiver is set at 9 kHz.

14.4. Test result

According to 15.207, power Line Conducted Emission is not required for devices which only employ battery power for operation and which do not operate from the AC power lines or contain provisions for operation while connected to the AC power lines.

15. Antenna Requirements

15.1. Limits

Please refer to FCC § 15.203

An intentional radiator shall be designed to ensure that no antenna other than that furnished by the responsible party shall be used with the device. The use of a permanently attached antenna or of an antenna that uses a unique coupling to the intentional radiator shall be considered sufficient to comply with the provisions of this section. The manufacturer may design the unit so that a broken antenna can be replaced by the user, but the use of a standard antenna jack or electrical connector is prohibited.

Please refer to FCC § 15.247(b)(4)

The conducted output power limit specified in paragraph (b) of this section is based on the use of antennas with directional gains that do not exceed 6 dBi. Except as shown in paragraph (c) of this section, if transmitting antennas of directional gain greater than 6 dBi are used, the conducted output power from the intentional radiator shall be reduced below the stated values in paragraphs (b)(1), (b)(2), and (b)(3) of this section, as appropriate, by the amount in dB that the directional gain of the antenna exceeds 6 dBi.

15.2. Result

The antenna used for this product is External antenna and that no antenna other than that furnished by the responsible party shall be used with the device, the maximum peak gain of the transmit antenna is 2.71 dBi

APPENDIX A – Radiated Emission Below 1GHz Test Data

Test Report

Project Information			
EUT:	IEEE 802.11b/g/n/a/ac/ax 2T2R USB WiFi Module Integrated BT 2.1+EDR/4.2/5.2		
Model:	SKI.WB920TU.2	Environment:	23°C 56%
Mode:	BLE_2402	Voltage:	DC3.3V
Customer:		Engineer:	Kennys Zhang
Remark:			

Start of Test: 2023-09-02 10:34:40

Test Graph

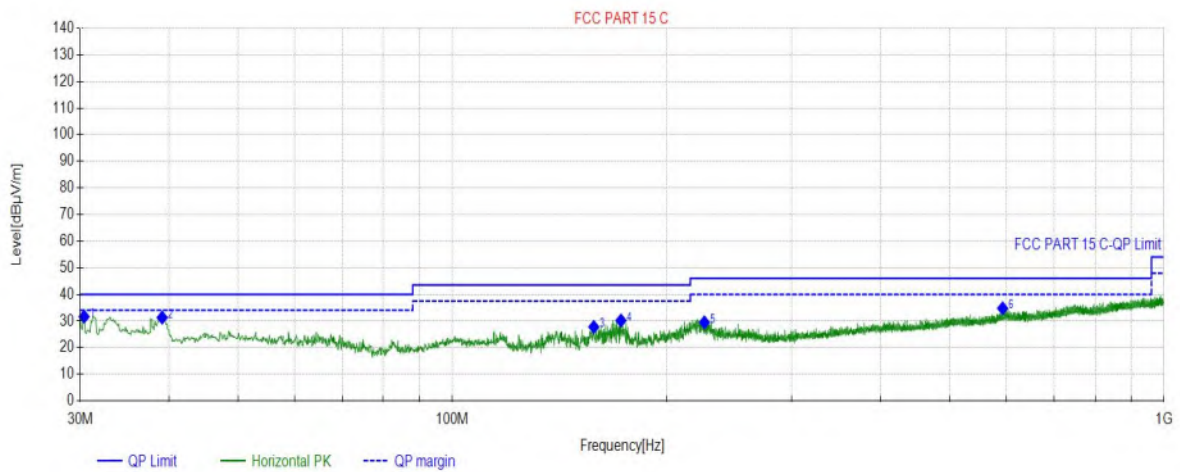

Final Data List								
NO.	Freq. (MHz)	Factor (dB)	QP Value (dBµV/m)	QP Limit (dBµV/m)	QP Margin (dB)	Height (cm)	Angle (°)	Polarity
1	30.3880	18.91	31.64	40.00	8.36	100	27	Horizontal
2	39.1189	21.02	31.30	40.00	8.70	100	59	Horizontal
3	158.0528	17.58	27.78	43.50	15.72	100	255	Horizontal
4	172.6043	18.05	30.19	43.50	13.31	100	273	Horizontal
5	226.0566	20.97	29.49	46.00	16.51	100	176	Horizontal
6	593.2383	29.99	34.77	46.00	11.23	100	324	Horizontal

Test Report

Project Information			
EUT:	IEEE 802.11b/g/n/a/ac/ax 2T2R USB WiFi Module Integrated BT 2.1+EDR/4.2/5.2		
Model:	SKI.WB920TU.2	Environment:	23°C 56%
Mode:	BLE_2402	Voltage:	DC3.3V
Customer:		Engineer:	Kennys Zhang
Remark:			

Start of Test: 2023-09-02 10:35:24

Test Graph

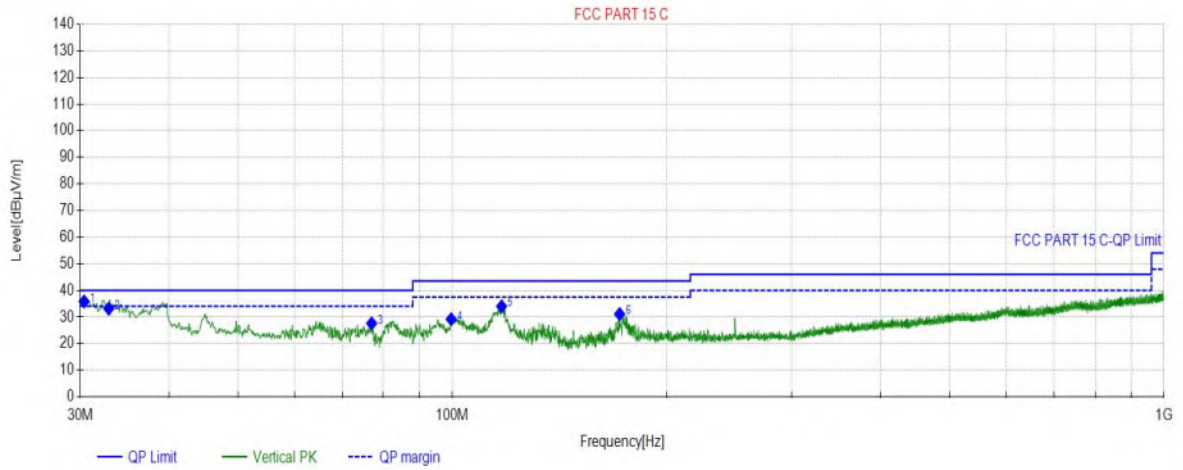

Final Data List

NO.	Freq. (MHz)	Factor (dB)	QP Value (dBµV/m)	QP Limit (dBµV/m)	QP Margin (dB)	Height (cm)	Angle (°)	Polarity
1	30.3880	18.91	35.83	40.00	4.17	100	1	Vertical
2	32.9103	19.52	33.15	40.00	6.85	100	27	Vertical
3	77.0497	16.48	27.60	40.00	12.40	100	214	Vertical
4	99.6530	20.70	29.17	43.50	14.33	100	47	Vertical
5	117.3087	19.02	34.02	43.50	9.48	100	61	Vertical
6	171.8282	18.01	31.12	43.50	12.38	100	228	Vertical

APPENDIX B – Radiated Emission Above 1GHz Test Data Test Report

Project Information			
EUT:	IEEE 802.11b/g/n/a/ac/ax 2T2R USB WiFi Module Integrated BT 2.1+EDR/4.2/5.2		
Model:	SKI.WB920TU.2	Environment:	23°C 56%
Mode:	BLE_2402	Voltage:	DC3.3V
Customer:		Engineer:	Kennys Zhang
Remark:			

Start of Test: 2023-09-04 10:04:39

Test Graph

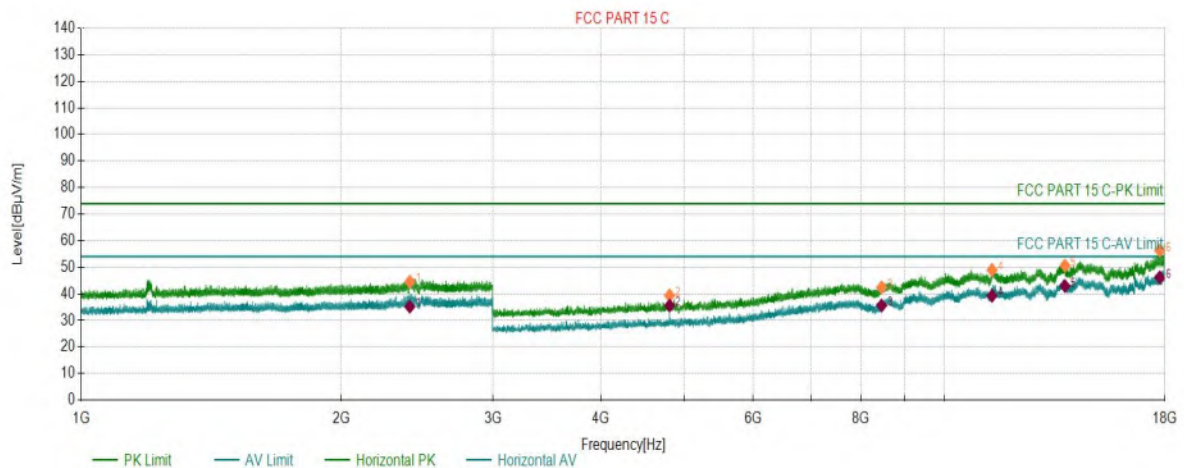

PK Final Data List								
NO.	Freq. (MHz)	Factor (dB)	PK Value (dBµV/m)	PK Limit (dBµV/m)	PK Margin (dB)	Height (cm)	Angle (°)	Polarity
1	2402.1701	7.11	44.51	74.00	29.49	150	29	Horizontal
2	4803.0902	-11.18	39.40	74.00	34.60	150	2	Horizontal
3	8452.0226	-0.31	42.40	74.00	31.60	150	170	Horizontal
4	11347.1674	6.38	49.00	74.00	25.00	150	77	Horizontal
5	13783.2892	10.73	50.62	74.00	23.38	150	358	Horizontal
6	17748.7374	19.73	56.34	74.00	17.66	150	4	Horizontal

AV Final Data List								
NO.	Freq. (MHz)	Factor (dB)	AV Value (dBµV/m)	AV Limit (dBµV/m)	AV Margin (dB)	Height (cm)	Angle (°)	Polarity
1	2402.1701	7.11	35.19	54.00	18.81	150	29	Horizontal
2	4803.0902	-11.18	35.61	54.00	18.39	150	2	Horizontal
3	8452.0226	-0.31	35.60	54.00	18.40	150	170	Horizontal
4	11347.1674	6.38	39.26	54.00	14.74	150	77	Horizontal
5	13783.2892	10.73	42.94	54.00	11.06	150	358	Horizontal
6	17748.7374	19.73	46.21	54.00	7.79	150	4	Horizontal

Test Report

Project Information			
EUT:	IEEE 802.11b/g/n/a/ac/ax 2T2R USB WiFi Module Integrated BT 2.1+EDR/4.2/5.2		
Model:	SKI.WB920TU.2	Environment:	23°C 56%
Mode:	BLE_2402	Voltage:	DC3.3V
Customer:		Engineer:	Kennys Zhang
Remark:			

Start of Test: 2023-09-04 10:06:26

Test Graph

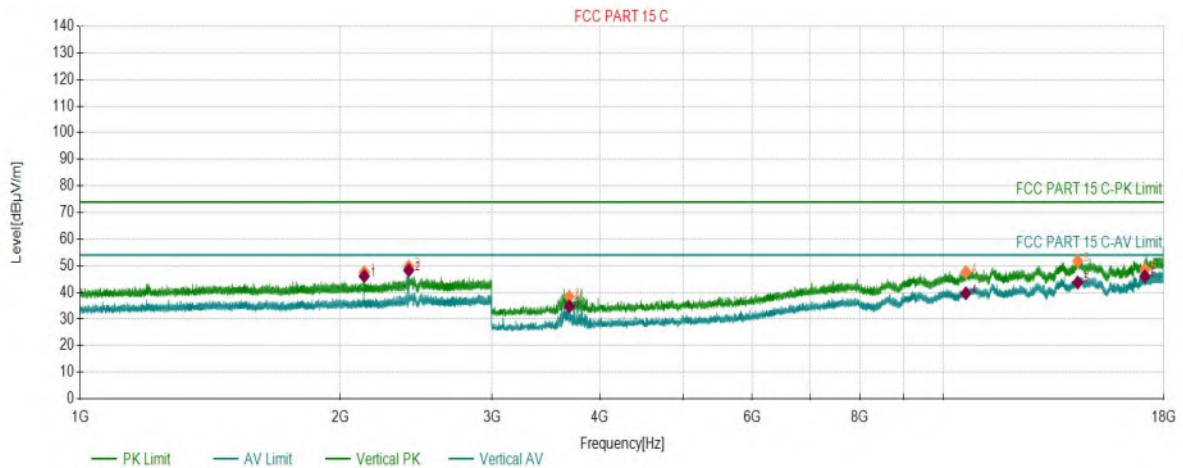

PK Final Data List

NO.	Freq. (MHz)	Factor (dB)	PK Value (dBµV/m)	PK Limit (dBµV/m)	PK Margin (dB)	Height (cm)	Angle (°)	Polarity
1	2133.4567	5.33	47.62	74.00	26.38	150	98	Vertical
2	2402.2701	7.11	49.76	74.00	24.24	150	292	Vertical
3	3684.7842	-15.38	38.39	74.00	35.61	150	109	Vertical
4	10610.6305	5.47	47.67	74.00	26.33	150	304	Vertical
5	14297.8149	12.62	51.79	74.00	22.21	150	126	Vertical
6	17105.9553	13.68	48.72	74.00	25.28	150	8	Vertical

AV Final Data List

NO.	Freq. (MHz)	Factor (dB)	AV Value (dBµV/m)	AV Limit (dBµV/m)	AV Margin (dB)	Height (cm)	Angle (°)	Polarity
1	2133.4567	5.33	46.10	54.00	7.90	150	98	Vertical
2	2402.2701	7.11	48.33	54.00	5.67	150	292	Vertical
3	3684.7842	-15.38	34.77	54.00	19.23	150	109	Vertical
4	10610.6305	5.47	39.67	54.00	14.33	150	304	Vertical
5	14297.8149	12.62	43.71	54.00	10.29	150	126	Vertical
6	17105.9553	13.68	46.09	54.00	7.91	150	8	Vertical

Test Report

Project Information			
EUT:	IEEE 802.11b/g/n/a/ac/ax 2T2R USB WiFi Module Integrated BT 2.1+EDR/4.2/5.2		
Model:	SKI.WB920TU.2	Environment:	23°C 56%
Mode:	BLE_2480	Voltage:	DC3.3V
Customer:		Engineer:	Kennys Zhang
Remark:			

Start of Test: 2023-09-04 15:47:00

Test Graph

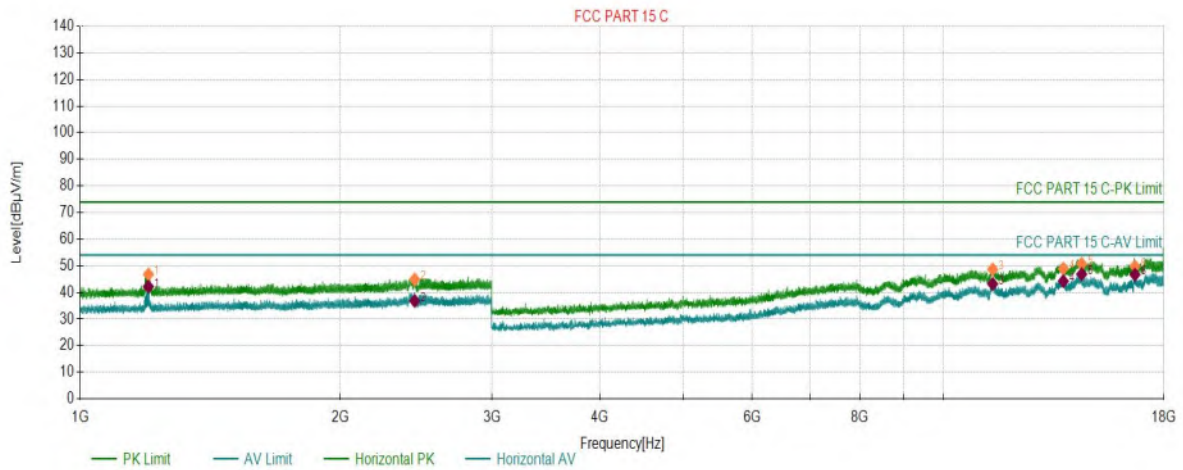

PK Final Data List

NO.	Freq. (MHz)	Factor (dB)	PK Value (dBµV/m)	PK Limit (dBµV/m)	PK Margin (dB)	Height (cm)	Angle (°)	Polarity
1	1199.8100	1.36	46.79	74.00	27.21	150	221	Horizontal
2	2440.2720	7.27	44.89	74.00	29.11	150	96	Horizontal
3	11398.1699	7.12	48.66	74.00	25.34	150	286	Horizontal
4	13761.5381	10.91	48.93	74.00	25.07	150	360	Horizontal
5	14450.8225	13.09	50.75	74.00	23.25	150	235	Horizontal
6	16655.9328	12.54	49.78	74.00	24.22	150	110	Horizontal

AV Final Data List

NO.	Freq. (MHz)	Factor (dB)	AV Value (dBµV/m)	AV Limit (dBµV/m)	AV Margin (dB)	Height (cm)	Angle (°)	Polarity
1	1199.8100	1.36	42.16	54.00	11.84	150	221	Horizontal
2	2440.2720	7.27	36.80	54.00	17.20	150	96	Horizontal
3	11398.1699	7.12	43.19	54.00	10.81	150	286	Horizontal
4	13761.5381	10.91	44.25	54.00	9.75	150	360	Horizontal
5	14450.8225	13.09	46.86	54.00	7.14	150	235	Horizontal
6	16655.9328	12.54	46.69	54.00	7.31	150	110	Horizontal

Test Report

Project Information			
EUT:	IEEE 802.11b/g/n/a/ac/ax 2T2R USB WiFi Module Integrated BT 2.1+EDR/4.2/5.2		
Model:	SKI.WB920TU.2	Environment:	23°C 56%
Mode:	BLE_2480	Voltage:	DC3.3V
Customer:		Engineer:	Kennys Zhang
Remark:			

Start of Test: 2023-09-04 15:48:49

Test Graph

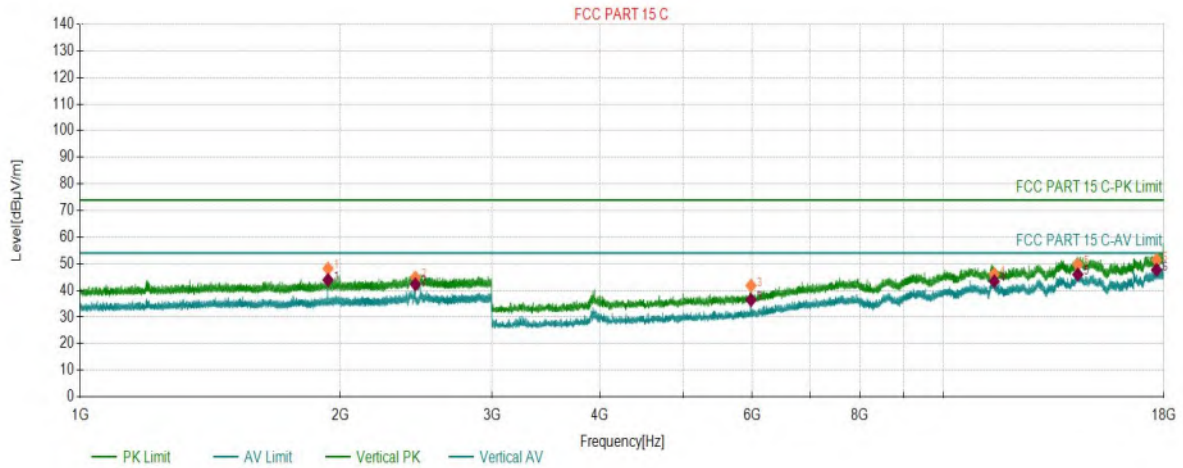

PK Final Data List

NO.	Freq. (MHz)	Factor (dB)	PK Value (dBµV/m)	PK Limit (dBµV/m)	PK Margin (dB)	Height (cm)	Angle (°)	Polarity
1	1936.7468	4.66	48.23	74.00	25.77	150	156	Vertical
2	2445.1723	7.29	44.88	74.00	29.12	150	306	Vertical
3	5984.3992	-7.84	41.79	74.00	32.21	150	99	Vertical
4	11445.4223	6.84	46.08	74.00	27.92	150	38	Vertical
5	14303.8152	12.64	49.76	74.00	24.24	150	353	Vertical
6	17646.7323	17.76	51.46	74.00	22.54	150	346	Vertical

AV Final Data List

NO.	Freq. (MHz)	Factor (dB)	AV Value (dBµV/m)	AV Limit (dBµV/m)	AV Margin (dB)	Height (cm)	Angle (°)	Polarity
1	1936.7468	4.66	43.95	54.00	10.05	150	156	Vertical
2	2445.1723	7.29	42.26	54.00	11.74	150	306	Vertical
3	5984.3992	-7.84	36.40	54.00	17.60	150	99	Vertical
4	11445.4223	6.84	43.43	54.00	10.57	150	38	Vertical
5	14303.8152	12.64	46.00	54.00	8.00	150	353	Vertical
6	17646.7323	17.76	47.75	54.00	6.25	150	346	Vertical

Test Report

Project Information			
EUT:	IEEE 802.11b/g/n/a/ac/ax 2T2R USB WiFi Module Integrated BT 2.1+EDR/4.2/5.2		
Model:	SKI.WB920TU.2	Environment:	23°C 56%
Mode:	BLE_2440	Voltage:	DC3.3V
Customer:		Engineer:	Kennys Zhang
Remark:			

Start of Test: 2023-09-04 15:52:02

Test Graph

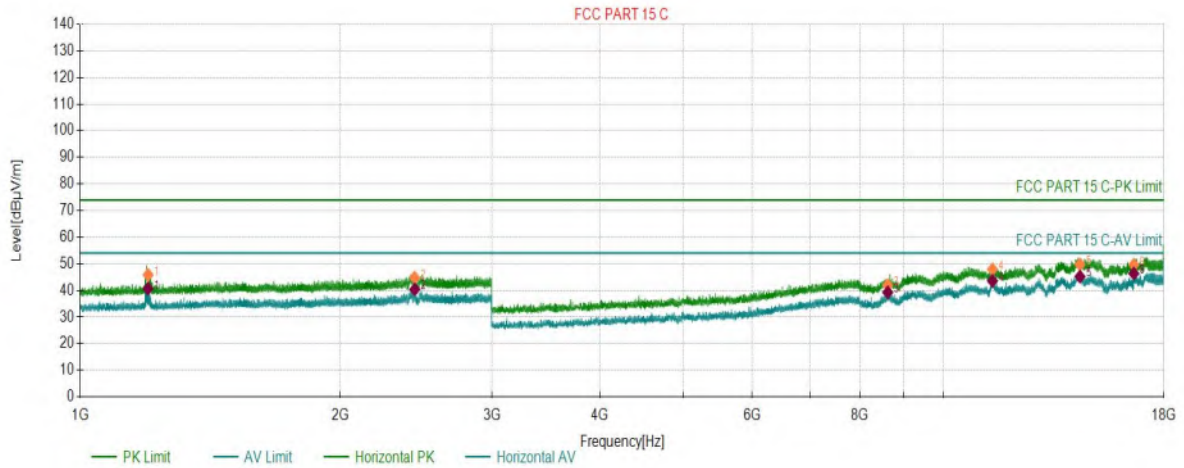

PK Final Data List								
NO.	Freq. (MHz)	Factor (dB)	PK Value (dBµV/m)	PK Limit (dBµV/m)	PK Margin (dB)	Height (cm)	Angle (°)	Polarity
1	1198.5099	1.35	45.86	74.00	28.14	150	218	Horizontal
2	2440.4720	7.27	44.76	74.00	29.24	150	280	Horizontal
3	8615.5308	0.91	41.97	74.00	32.03	150	360	Horizontal
4	11392.1696	7.04	47.90	74.00	26.10	150	58	Horizontal
5	14386.3193	12.96	49.77	74.00	24.23	150	74	Horizontal
6	16605.6803	12.28	49.61	74.00	24.39	150	158	Horizontal

AV Final Data List								
NO.	Freq. (MHz)	Factor (dB)	AV Value (dBµV/m)	AV Limit (dBµV/m)	AV Margin (dB)	Height (cm)	Angle (°)	Polarity
1	1198.5099	1.35	40.66	54.00	13.34	150	218	Horizontal
2	2440.4720	7.27	40.38	54.00	13.62	150	280	Horizontal
3	8615.5308	0.91	39.26	54.00	14.74	150	360	Horizontal
4	11392.1696	7.04	43.57	54.00	10.43	150	58	Horizontal
5	14386.3193	12.96	45.20	54.00	8.80	150	74	Horizontal
6	16605.6803	12.28	46.35	54.00	7.65	150	158	Horizontal

Test Report

Project Information			
EUT:	IEEE 802.11b/g/n/a/ac/ax 2T2R USB WiFi Module Integrated BT 2.1+EDR/4.2/5.2		
Model:	SKI.WB920TU.2	Environment:	23°C 56%
Mode:	BLE_2440	Voltage:	DC3.3V
Customer:		Engineer:	Kennys Zhang
Remark:			

Start of Test: 2023-09-04 15:53:53

Test Graph

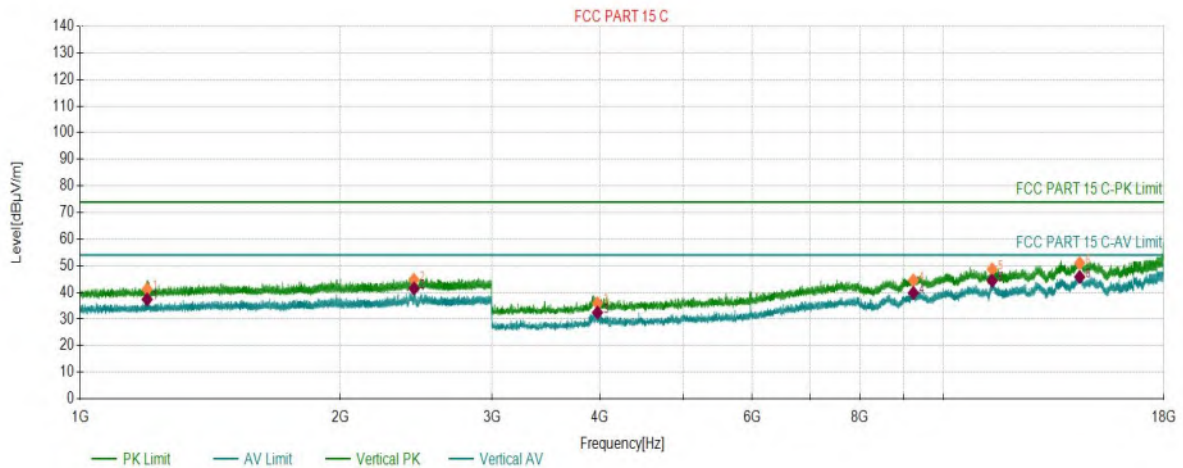

PK Final Data List

NO.	Freq. (MHz)	Factor (dB)	PK Value (dBµV/m)	PK Limit (dBµV/m)	PK Margin (dB)	Height (cm)	Angle (°)	Polarity
1	1195.6098	1.32	41.17	74.00	32.83	150	259	Vertical
2	2435.8718	7.25	44.71	74.00	29.29	150	352	Vertical
3	3973.5487	-14.42	35.95	74.00	38.05	150	107	Vertical
4	9226.0613	2.96	44.53	74.00	29.47	150	165	Vertical
5	11384.6692	6.93	48.69	74.00	25.31	150	83	Vertical
6	14374.3187	12.91	51.00	74.00	23.00	150	360	Vertical

AV Final Data List

NO.	Freq. (MHz)	Factor (dB)	AV Value (dBµV/m)	AV Limit (dBµV/m)	AV Margin (dB)	Height (cm)	Angle (°)	Polarity
1	1195.6098	1.32	37.37	54.00	16.63	150	259	Vertical
2	2435.8718	7.25	41.48	54.00	12.52	150	352	Vertical
3	3973.5487	-14.42	32.41	54.00	21.59	150	107	Vertical
4	9226.0613	2.96	39.82	54.00	14.18	150	165	Vertical
5	11384.6692	6.93	44.41	54.00	9.59	150	83	Vertical
6	14374.3187	12.91	45.80	54.00	8.20	150	360	Vertical

Restriction Band Emission

Test Report

Project Information			
EUT:	IEEE 802.11b/g/n/a/ac/ax 2T2R USB WiFi Module Integrated BT 2.1+EDR/4.2/5.2		
Model:	SKI.WB920TU.2	Environment:	23°C 56%
Mode:	BLE 1M_2402	Voltage:	DC3.3V
Customer:		Engineer:	Kennys Zhang
Remark:	Power Set : 3		

Start of Test: 2023-09-04 10:00:44

Test Graph

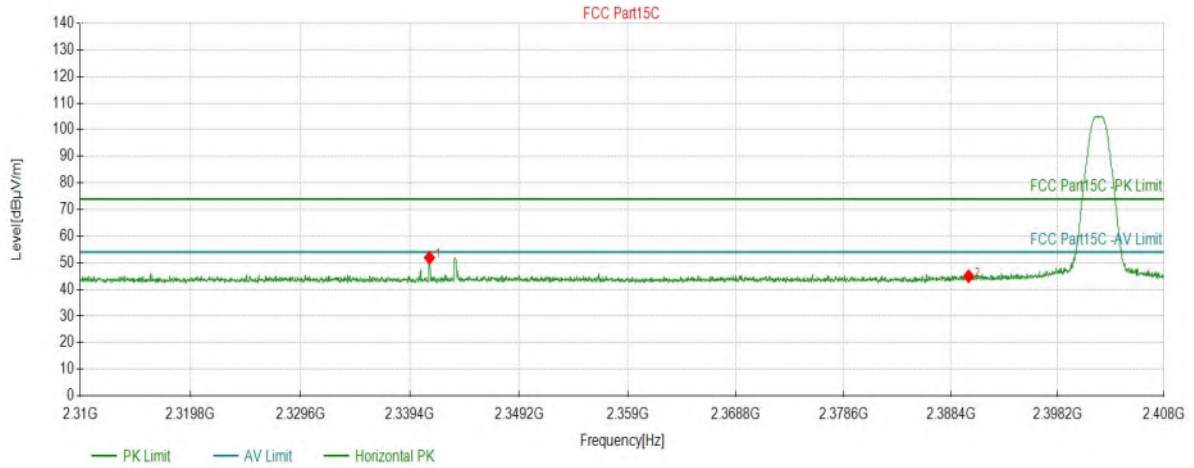

Suspected Data List

NO.	Freq. (MHz)	Level (dBµV/m)	Factor (dB)	Limit (dBµV/m)	Margin (dB)	Height (cm)	Angle (°)	Detector	Polarity
1	2341.1417	51.88	5.55	74.00	22.12	150	335	PK	Horizont
2	2390.0273	44.94	5.61	74.00	29.06	150	351	PK	Horizont

Test Report

Project Information			
EUT:	IEEE 802.11b/g/n/a/ac/ax 2T2R USB WiFi Module Integrated BT 2.1+EDR/4.2/5.2		
Model:	SKI.WB920TU.2	Environment:	23°C 56%
Mode:	BLE 1M_2402	Voltage:	DC3.3V
Customer:		Engineer:	Kennys Zhang
Remark:	Power Set : 3		

Start of Test: 2023-09-04 10:02:30

Test Graph

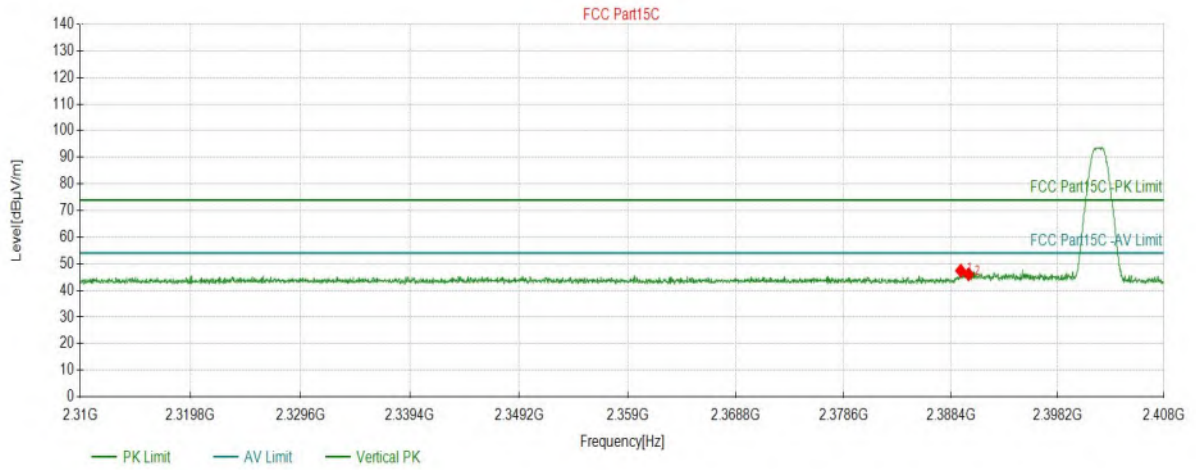

Suspected Data List

NO.	Freq. (MHz)	Level (dBµV/m)	Factor (dB)	Limit (dBµV/m)	Margin (dB)	Height (cm)	Angle (°)	Detector	Polarity
1	2389.3084	47.40	5.61	74.00	26.60	150	98	PK	Vertical
2	2390.0273	46.05	5.61	74.00	27.95	150	78	PK	Vertical

Test Report

Project Information			
EUT:	IEEE 802.11b/g/n/a/ac/ax 2T2R USB WiFi Module Integrated BT 2.1+EDR/4.2/5.2		
Model:	SKI.WB920TU.2	Environment:	23°C 56%
Mode:	BLE 1M_2480	Voltage:	DC3.3V
Customer:		Engineer:	Kennys Zhang
Remark:			

Start of Test: 2023-09-04 15:43:41

Test Graph

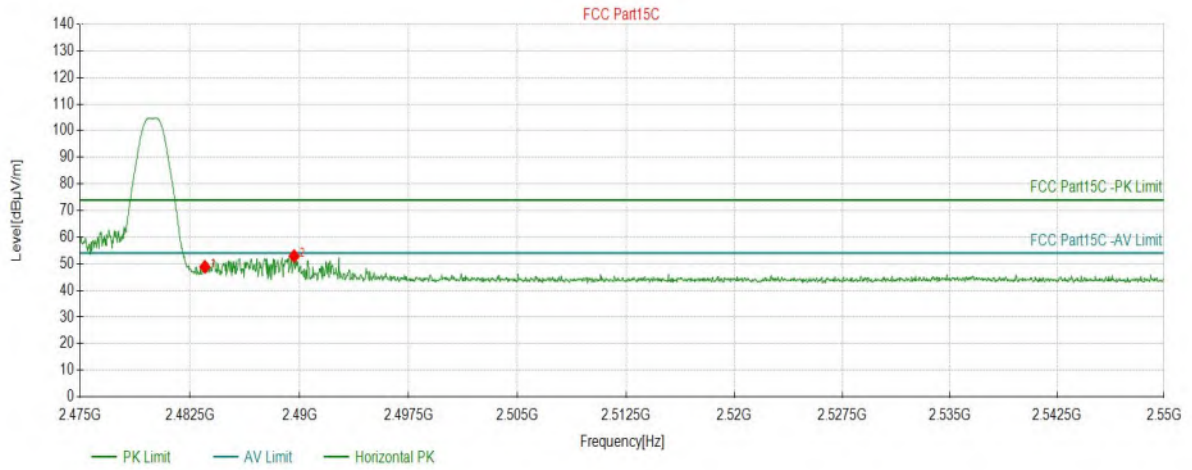

Suspected Data List

NO.	Freq. (MHz)	Level (dBµV/m)	Factor (dB)	Limit (dBµV/m)	Margin (dB)	Height (cm)	Angle (°)	Detector	Polarity
1	2483.5168	48.85	6.07	74.00	25.15	150	56	PK	Horizont
2	2489.6323	52.87	6.10	74.00	21.13	150	56	PK	Horizont

Test Report

Project Information			
EUT:	IEEE 802.11b/g/n/a/ac/ax 2T2R USB WiFi Module Integrated BT 2.1+EDR/4.2/5.2		
Model:	SKI.WB920TU.2	Environment:	23°C 56%
Mode:	BLE 1M_2480	Voltage:	DC3.3V
Customer:		Engineer:	Kennys Zhang
Remark:			

Start of Test: 2023-09-04 15:44:25

Test Graph

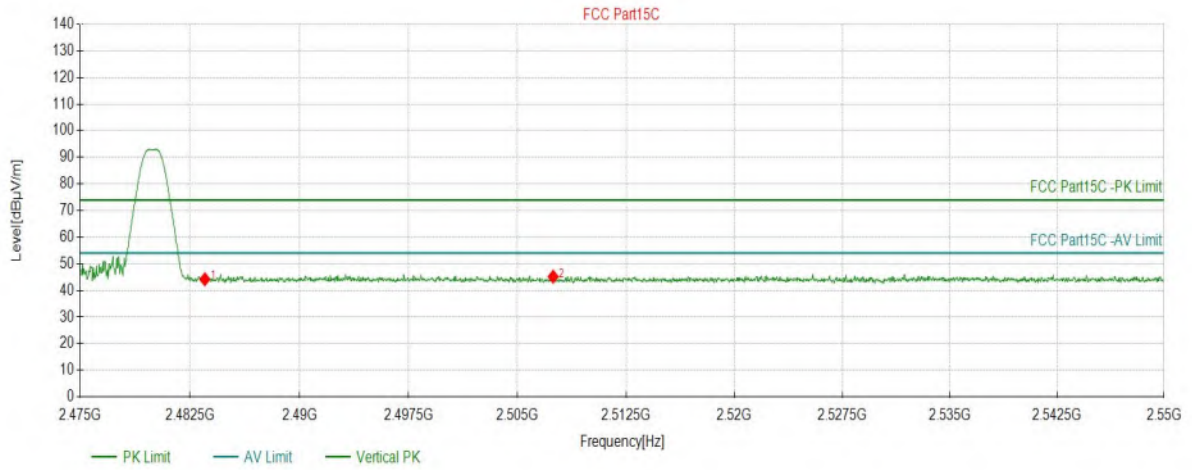

Suspected Data List

NO.	Freq. (MHz)	Level (dBµV/m)	Factor (dB)	Limit (dBµV/m)	Margin (dB)	Height (cm)	Angle (°)	Detector	Polarity
1	2483.5168	44.18	6.07	74.00	29.82	150	29	PK	Vertical
2	2507.4537	45.15	6.16	74.00	28.85	150	113	PK	Vertical

Test Report

Project Information			
EUT:	IEEE 802.11b/g/n/a/ac/ax 2T2R USB WiFi Module Integrated BT 2.1+EDR/4.2/5.2		
Model:	SKI.WB920TU.2	Environment:	23°C 56%
Mode:	BLE 2M_2402	Voltage:	DC3.3V
Customer:		Engineer:	Kennys Zhang
Remark:			

Start of Test: 2023-09-04 15:57:52

Test Graph

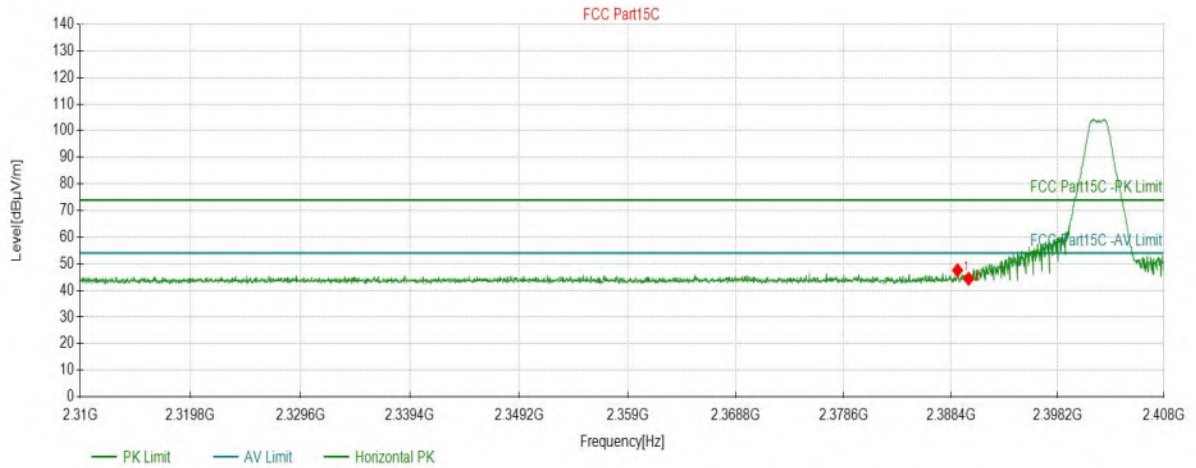

Suspected Data List

NO.	Freq. (MHz)	Level (dBµV/m)	Factor (dB)	Limit (dBµV/m)	Margin (dB)	Height (cm)	Angle (°)	Detector	Polarity
1	2389.0143	47.57	5.61	74.00	26.43	150	258	PK	Horizont
2	2390.0273	44.37	5.61	74.00	29.63	150	86	PK	Horizont

Test Report

Project Information			
EUT:	IEEE 802.11b/g/n/a/ac/ax 2T2R USB WiFi Module Integrated BT 2.1+EDR/4.2/5.2		
Model:	SKI.WB920TU.2	Environment:	23°C 56%
Mode:	BLE 2M_2402	Voltage:	DC3.3V
Customer:		Engineer:	Kennys Zhang
Remark:			

Start of Test: 2023-09-04 15:58:36

Test Graph

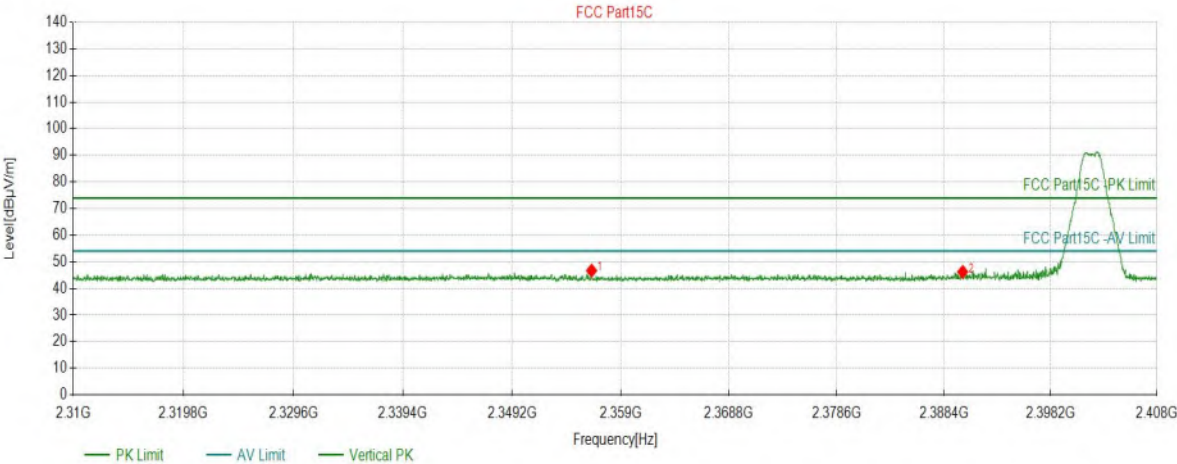

Suspected Data List

NO.	Freq. (MHz)	Level (dBµV/m)	Factor (dB)	Limit (dBµV/m)	Margin (dB)	Height (cm)	Angle (°)	Detector	Polarity
1	2356.3695	46.71	5.57	74.00	27.29	150	177	PK	Vertical
2	2390.1254	46.21	5.61	74.00	27.79	150	133	PK	Vertical

Test Report

Project Information			
EUT:	IEEE 802.11b/g/n/a/ac/ax 2T2R USB WiFi Module Integrated BT 2.1+EDR/4.2/5.2		
Model:	SKI.WB920TU.2	Environment:	23°C 56%
Mode:	BLE 2M_2480	Voltage:	AC 120V/60Hz
Customer:		Engineer:	Kennys Zhang
Remark:			

Start of Test: 2023-09-04 16:01:48

Test Graph

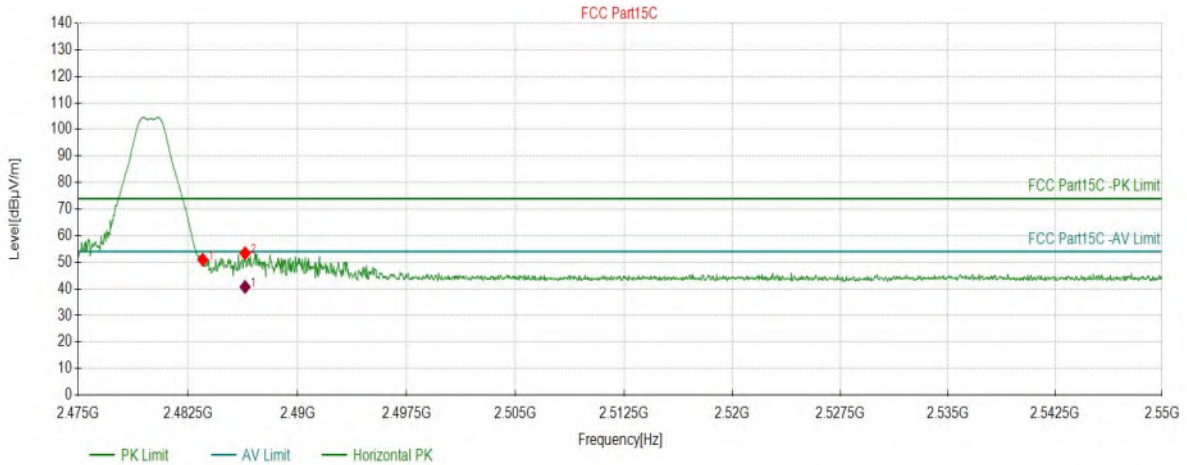

Suspected Data List

NO.	Freq. (MHz)	Level (dBµV/m)	Factor (dB)	Limit (dBµV/m)	Margin (dB)	Height (cm)	Angle (°)	Detector	Polarity
1	2483.5168	50.94	6.07	74.00	23.06	150	272	PK	Horizont
2	2486.4057	53.40	6.09	74.00	20.60	150	52	PK	Horizont

AV Final Data List

NO.	Freq. (MHz)	Factor (dB)	AV Value (dBµV/m)	AV Limit (dBµV/m)	AV Margin (dB)	Height (cm)	Angle (°)	Polarity
1	2486.4059	6.09	40.72	54.00	13.28	211.5	290	Horizontal

Test Report

Project Information			
EUT:	IEEE 802.11b/g/n/a/ac/ax 2T2R USB WiFi Module Integrated BT 2.1+EDR/4.2/5.2		
Model:	SKI.WB920TU.2	Environment:	23°C 56%
Mode:	BLE 2M_2480	Voltage:	AC 120V/60Hz
Customer:		Engineer:	Kennys Zhang
Remark:			

Start of Test: 2023-09-04 16:02:41

Test Graph

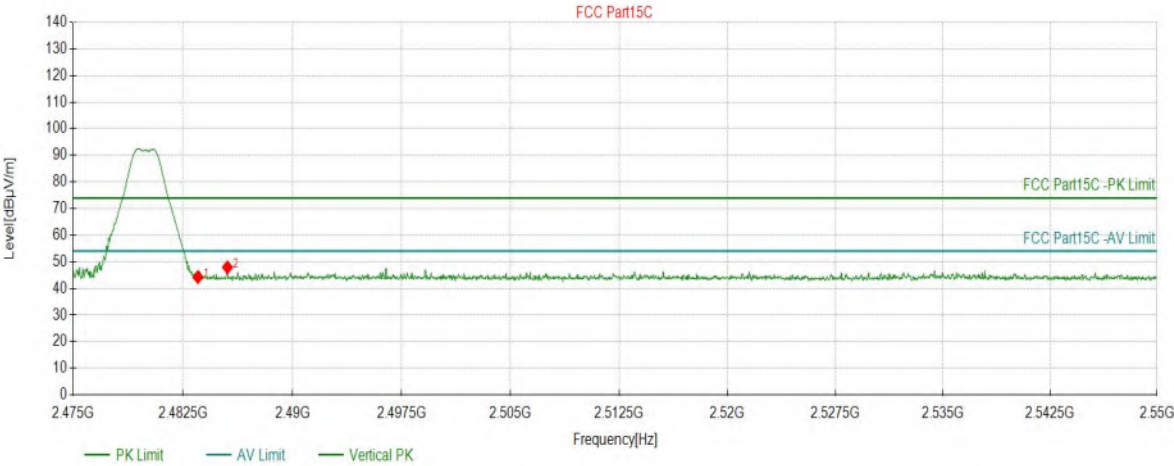

Suspected Data List									
NO.	Freq. (MHz)	Level (dBµV/m)	Factor (dB)	Limit (dBµV/m)	Margin (dB)	Height (cm)	Angle (°)	Detector	Polarity
1	2483.5168	44.26	6.07	74.00	29.74	150	87	PK	Vertical
2	2485.5428	47.92	6.08	74.00	26.08	150	144	PK	Vertical

END OF REPORT