





FCC AND ISCED CERTIFICATION TEST REPORT

Applicant:	Guangzhou Shikun Electronics Co., Ltd
Address:	NO.6 Liankun Road, Huangpu District, Guangzhou, China
Manufacturer:	Guangzhou Shikun Electronics Co., Ltd
Address:	NO.6 Liankun Road, Huangpu District, Guangzhou, China
Product Description:	IEEE 802.11b/g/n/a/ac/ax 2T2R USB WiFi Module Integrated BT 2.1+EDR/4.2/5.2
Brand Name:	N/A
Tested Model:	SKI.WB920TU.2
FCC ID:	2AR82-SKIWB920TU2
IC:	24728-SKIWB920TU2
Report No.:	JCF230821202-001
Received Date:	Aug. 24, 2023
Tested Date:	Aug. 24, 2023 - Sep. 22, 2023
Issued Date:	Oct. 20, 2023
Test Standards:	FCC Rules and Regulations Part 15 Subpart C, RSS-247 Issue 3, Aug. 2023.
Test Procedure:	ANSI C63.10:2013, RSS-Gen Issue 5, A2 (February 2021)
Test Result:	Pass
Prepared By:	
	
<u>Kennys Zhang/Engineer</u>	Date: Oct. 20, 2023
Reviewed By:	
	
<u>Roger Li/Engineer</u>	Date: Oct. 20, 2023
	
Approved By:	
	
<u>Talent Zhang/Engineer</u>	Date: Oct. 20, 2023

Note: The test results in this report apply exclusively to the tested model / sample. Without written approval of Guangzhou Jingce Testing Technology Co., Ltd. the test report shall not be reproduced except in full.

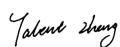
Report Revise Record

Report Version	Revise Time	Issued Date	Valid Version	Notes
V1.0	/	Oct. 20, 2023	Original Report	/

Table of Contents

1. Test Report Declare	5
2. Summary of Test Results	6
3. Test Laboratory	6
4. Equipment Under Test	7
4.1. Description of EUT	7
4.2. Channel List	7
4.3. Packet Type Configuration	8
4.4. Test Channel Configuration	8
4.5. Test environment conditions	8
4.6. The Worse Case Power Setting Parameter	8
4.7. Description of Available Antennas	9
5. Description of Test Setup	9
5.1. Accessory	9
5.2. Support Equipment	9
5.3. Test Setup	9
5.4. Setup Diagram for Tests	9
6. Measurement Uncertainty	10
7. Measuring Instrument and Software Used	10
8. On Time and Duty Cycle	12
8.1. Block diagram of test setup	12
8.2. Limits	12
8.3. Results	12
8.4. Original test data	13
9. 20 dB Occupied Bandwidth and 99 % Occupied Bandwidth	16
9.1. Block diagram of test setup	16
9.2. Limit	16
9.3. Test Procedure	16
9.4. Results	16
9.5. Original test data	18
10. Conducted Output Power	24
10.1. Block diagram of test setup	24
10.2. Limits	24
10.3. Test Procedure	24
10.4. Results	24
10.5. Original test data	25
11. Carrier Hopping Channel Separation	28
11.1. Block diagram of test setup	28
11.2. Limits	28
11.3. Test Procedure	28
11.4. Results	28
11.5. Original test data	29
12. Number of Hopping Frequency	30
12.1. Block diagram of test setup	30
12.2. Limits	30
12.3. Test Procedure	30
12.4. Results	30
12.5. Original test data	31
13. Time of Occupancy (Dwell Time)	32
13.1. Block diagram of test setup	32
13.2. Limits	32
13.3. Test Procedure	32
13.4. Results	33

13.5. Original test data	34
14. Conducted Spurious Emission	37
14.1. Block diagram of test setup	37
14.2. Limits	37
14.3. Test Procedure	37
14.4. Results	38
14.5. Original test data	40
15. Radiated Emission	50
15.1. Block diagram of test setup	50
15.2. Limit	51
15.3. Test Procedure	53
15.4. Results	56
15.5. Original test data	56
16. AC Power Line Conducted Emissions	57
16.1. Block diagram of test setup	57
16.2. Limits	57
16.3. Test procedure	57
16.4. Test result	58
17. Antenna Requirements	59
17.1. Limits	59
17.2. Result	59
APPENDIX A – Radiated Emission Below 1GHz Test Data	60
APPENDIX B – Radiated Emission Above 1GHz Test Data	62

1. Test Report Declare

Applicant:	Guangzhou Shikun Electronics Co., Ltd
Address:	NO.6 Liankun Road, Huangpu District, Guangzhou, China
Manufacturer:	Guangzhou Shikun Electronics Co., Ltd
Address:	NO.6 Liankun Road, Huangpu District, Guangzhou, China
Product Name:	IEEE 802.11b/g/n/a/ac/ax 2T2R USB WiFi Module Integrated BT 2.1+EDR/4.2/5.2
Brand Name:	N/A
Model Name:	SKI.WB920TU.2
Difference Description:	N/A

We Declare:

The equipment described above is tested by Guangzhou Jingce Testing Technology Co., Ltd. and in the configuration tested the equipment complied with the standards specified above. The test results are contained this test report and Guangzhou Jingce Testing Technology Co., Ltd. is assumed of full responsibility for the accuracy and completeness of these tests.

2. Summary of Test Results

Summary of Test Results			
Clause	Test Items	FCC/ISED Rules	Test Result
1	20 dB Bandwidth and 99 % Occupied Bandwidth	FCC 15.247 (a) (1) RSS-247 Clause 5.1 (a) RSS-Gen Clause 6.7	Pass
2	Conducted Output Power	FCC 15.247 (b) (1) RSS-247 Clause 5.1 (b)	Pass
3	Carrier Hopping Channel Separation	FCC 15.247 (a) (1) RSS-247 Clause 5.1 (b)	Pass
4	Number of Hopping Frequency	15.247 (a) (1) III RSS-247 Clause 5.1 (d)	Pass
5	Time of Occupancy (Dwell Time)	15.247 (a) (1) III RSS-247 Clause 5.1 (d)	Pass
6	Conducted Band edge	FCC 15.247 (d) RSS-247 Clause 5.5	Pass
7	Radiated Band edge and Spurious	FCC 15.247 (d) FCC 15.209 FCC 15.205 RSS-247 Clause 5.5 RSS-GEN Clause 8.9 RSS-GEN Clause 8.10	Pass
8	Conducted Emission Test For AC Power Port	FCC 15.207 RSS-GEN Clause 8.8	N/A
9	Antenna Requirement	FCC 15.203 RSS-GEN Clause 6.8	Pass

3. Test Laboratory

Guangzhou Jingce Testing Technology Co., Ltd.

Add.: No.192, Kezhu Road, Huangpu District, Guangzhou, Guangdong, China

Association for Laboratory Accreditation(A2LA). Certificate Number: 6594.01

FCC Designation Number: CN1331. Test Firm Registration Number: 360543

IC Test Firm Registration Number: 28796

Conformity Assessment Body identifier: CN0138

4. Equipment Under Test

4.1. Description of EUT

EUT Name:	IEEE 802.11b/g/n/a/ac/ax 2T2R USB WiFi Module Integrated BT 2.1+EDR/4.2/5.2
Model Number:	SKI.WB920TU.2
EUT Function Description:	Please reference user's manual
Power Supply:	DC 3.3V+/-0.3
Hardware Version:	N/A
Software Version:	N/A
Radio Specification:	Bluetooth V5.2
Operation Frequency:	2402 MHz - 2480 MHz
Modulation:	GFSK, $\pi/4$ -DQPSK, 8DPSK
Data Rate:	1Mbps, 2Mbps, 3Mbps
Antenna Type:	External Antenna, MAX. Gain: 2.71 dBi

Note 1: EUT is the ab. of equipment under test.

Note 2: The antenna gain is declared by the customer and the laboratory is not responsible for the accuracy of the antenna gain.

4.2. Channel List

Channel	Frequency (MHz)	Channel	Frequency (MHz)	Channel	Frequency (MHz)	Channel	Frequency (MHz)
0	2402	20	2422	40	2442	60	2462
1	2403	21	2423	41	2443	61	2463
2	2404	22	2424	42	2444	62	2464
3	2405	23	2425	43	2445	63	2465
4	2406	24	2426	44	2446	64	2466
5	2407	25	2427	45	2447	65	2467
6	2408	26	2428	46	2448	66	2468
7	2409	27	2429	47	2449	67	2469
8	2410	28	2430	48	2450	68	2470
9	2411	29	2431	49	2451	69	2471
10	2412	30	2432	50	2452	70	2472
11	2413	31	2433	51	2453	71	2473
12	2414	32	2434	52	2454	72	2474
13	2415	33	2435	53	2455	73	2475
14	2416	34	2436	54	2456	74	2476
15	2417	35	2437	55	2457	75	2477
16	2418	36	2438	56	2458	76	2478
17	2419	37	2439	57	2459	77	2479
18	2420	38	2440	58	2460	78	2480
19	2421	39	2441	59	2461	/	/

4.3. Packet Type Configuration

Test Mode	Packet Type	Setting(Packet Length)
GFSK	DH1	27
	DH3	183
	DH5	339
$\pi/4$ -DQPSK	2-DH1	54
	2-DH3	367
	2-DH5	679
8DPSK	3-DH1	83
	3-DH3	552
	3-DH5	1021

4.4. Test Channel Configuration

Tested mode, channel, information		
Mode	Channel	Frequency (MHz)
GFSK hopping on Tx mode	CH0 to CH78	2402 to 2480
$\pi/4$ -DQPSK hopping on Tx mode	CH0 to CH78	2402 to 2480
8DPSK hopping on Tx mode	CH0 to CH78	2402 to 2480
GFSK hopping off Tx mode	LCH: CH0	2402
	MCH: CH39	2441
	HCH: CH78	2480
$\pi/4$ -DQPSK hopping off Tx mode	LCH: CH0	2402
	MCH: CH39	2441
	HCH: CH78	2480
8DPSK hopping off Tx mode	LCH: CH0	2402
	MCH: CH39	2441
	HCH: CH78	2480

4.5. Test environment conditions

During the measurement the environmental conditions were within the listed ranges:

Temperature range:	21-25 °C
Humidity range:	40-75%
Pressure range:	86-106 kPa

4.6. The Worst Case Power Setting Parameter

The Worst Case Power Setting Parameter under 2400 ~ 2483.5MHz Band				
Test Software		WCN_Combo_Tool		
Modulation Type	Transmit Antenna Number	Test Software Setting Value		
		CH 0	CH 39	CH 78
GFSK	1	Default	Default	Default
$\pi/4$ -DQPSK	1	Default	Default	Default
8DPSK	1	Default	Default	Default

4.7. Description of Available Antennas

Test Mode	Transmit and Receive Mode	Description
GFSK	<input checked="" type="checkbox"/> 1TX, 1RX	Antenna 1 can be used as transmitting/receiving antenna.
$\pi/4$ -DQPSK	<input checked="" type="checkbox"/> 1TX, 1RX	Antenna 1 can be used as transmitting/receiving antenna.
8DPSK	<input checked="" type="checkbox"/> 1TX, 1RX	Antenna 1 can be used as transmitting/receiving antenna.

5. Description of Test Setup

5.1. Accessory

Description of Accessories	Manufacturer	Model Number	Description	Remark
/	/	/	/	/

5.2. Support Equipment

Equipment	Brand Name	Model Name	P/N
PC	Lenovo	T480	/

5.3. Test Setup

The EUT can work in Fixed Frequency mode.

5.4. Setup Diagram for Tests



6. Measurement Uncertainty

Where relevant, the following measurement uncertainty levels have been estimated for tests performed on the apparatus:

Test Item	Uncertainty
AC Power Conduction emission	1.37 dB
All Radiated emissions	5.4dB
Conducted emissions	3.09 dB
Occupied Channel Bandwidth	1.1%
Conducted Output power	0.82dB
Power Spectral Density	0.82dB

Note: This uncertainty represents an expanded uncertainty expressed at approximately the 95 % confidence level using a coverage factor of $k = 2$.

7. Measuring Instrument and Software Used

TS Test System						
Used	Equipment	Manufacturer	Model No.	Serial No.	Last Cal.	Due. Date
<input checked="" type="checkbox"/>	Spectrum Analyzer	Keysight	N9030B	MY56320512	Sep. 12, 2023	Sep. 11, 2024
<input checked="" type="checkbox"/>	Vector Signal Generator	Keysight	N5182B	MY57300334	Sep. 12, 2023	Sep. 11, 2024
<input checked="" type="checkbox"/>	Signal Generator	Keysight	N5171B	MY57280639	Sep. 12, 2023	Sep. 11, 2024
<input checked="" type="checkbox"/>	DC POWER	Keysight	E342A	MY59020356	Jul. 14, 2023	Jul. 13, 2024
<input checked="" type="checkbox"/>	Incubator thermometer	GWS	EL-02JA	21107288	Sep. 12, 2023	Sep. 11, 2024
<input checked="" type="checkbox"/>	Control unit(Power sensor)	Tonscend	JS0806-2	/	Sep. 12, 2023	Sep. 11, 2024
<input checked="" type="checkbox"/>	Wideband radio communication tester	R&S	CMW500	163478	Jul. 11, 2023	Jul. 10, 2024
<input checked="" type="checkbox"/>	Spectrum Analyzer	Keysight	N9020B	MY60112206	Sep. 12, 2023	Sep. 12, 2024
<input checked="" type="checkbox"/>	Control unit(Power sensor)	Tonscend	JS0806-2	21H8060465	Sep. 12, 2023	Sep. 12, 2024
Software						
Used	Description	Manufacturer	Name	Version		
<input checked="" type="checkbox"/>	Test software	TS+	JS1120-3	V3.3.10		
RSE Test System						
Used	Equipment	Manufacturer	Model No.	Serial No.	Last Cal.	Due. Date
<input checked="" type="checkbox"/>	EMI Receiver	R&S	ESW	101685	Jul. 12, 2023	Jul. 11, 2024
<input checked="" type="checkbox"/>	Bilog Antenna	Schwarzbeck	VULB 9163	01416	Mar. 21, 2023	Mar. 20, 2024
<input checked="" type="checkbox"/>	Horn Antenna 1	Schwarzbeck	BBHA 9120 D	02411	May. 25, 2023	May. 24, 2024
<input checked="" type="checkbox"/>	Horn Antenna 2	ETS	BBHA 9170	1090	Sep. 04, 2023	Sep. 03, 2024
<input checked="" type="checkbox"/>	loop-antenna	Schwarzbeck	FMZB 1513-60	00030	Jan.14,2023	Jan.13,2024
<input checked="" type="checkbox"/>	Signal Pre-Amplifier	Tonscend	TAP01018050	AP21C806122	Jul. 10, 2023	Jul. 09, 2024

<input checked="" type="checkbox"/>	Signal Pre-Amplifier	Tonscend	TAP9K3G32	AP20K806104	Jul. 10, 2023	Jul. 09, 2024
<input checked="" type="checkbox"/>	Signal Pre-Amplifier	ETS	3116C-PA	00217677	Aug. 24, 2023	Aug. 23, 2024
<input checked="" type="checkbox"/>	3m Fully-anechoic Chamber	ETS	RFD-100	/	Apr. 24, 2021	Apr. 23, 2024
Software						
Used	Description	Manufacturer	Name		Version	
<input checked="" type="checkbox"/>	Test software	TS+	TS+		V3.0.0.4	
Conducted Emission Test For AC Power Port						
Used	Equipment	Manufacturer	Model No.	Serial No.	Last Cal.	Due. Date
<input checked="" type="checkbox"/>	LISN	R&S	ENV216	102154	Jul. 10, 2023	Jul. 09, 2024
<input checked="" type="checkbox"/>	EMI Receiver	R&S	ESR3	102509	Jul. 12, 2023	Jul. 11, 2024
Software						
Used	Description	Manufacturer	Name		Version	
<input checked="" type="checkbox"/>	Test software	EZ	EZ-EMC		EMEC-3A1	
Other Instrument						
Used	Equipment	Manufacturer	Model No.	Serial No.	Last Cal.	Due. Date
<input checked="" type="checkbox"/>	Temperature & Humidity	Temperature	HTC-1	/	Nov. 25, 2022	Nov. 24, 2023

8. On Time and Duty Cycle

8.1. Block diagram of test setup

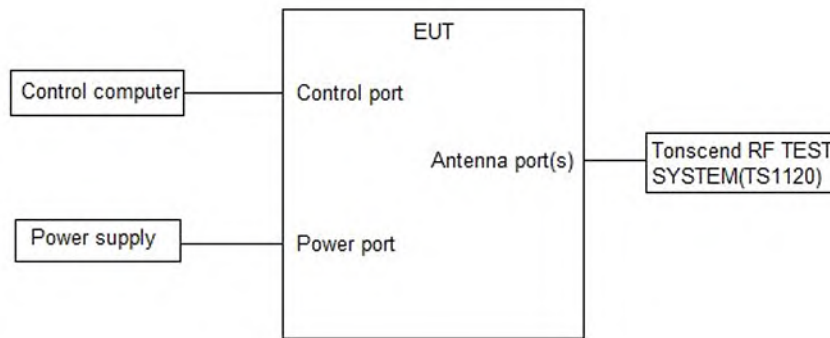

8.2. Limits

None; for reporting purposes only

8.3. Results

Test Mode	Ant.	Freq. (MHz)	ON Time (ms)	Period (ms)	Duty Cycle (%)	Duty Cycle Factor(dB)
DH5	Ant1	2402	2.88	3.74	77.01	1.13
		2441	2.88	3.75	76.80	1.15
		2480	2.88	3.75	76.80	1.15
2DH5	Ant1	2402	2.88	3.75	76.80	1.15
		2441	2.88	3.75	76.80	1.15
		2480	2.88	3.75	76.80	1.15
3DH5	Ant1	2402	2.88	3.74	77.01	1.13
		2441	2.89	3.75	77.07	1.13
		2480	2.89	3.75	77.07	1.13

Note: Duty Cycle Correction Factor= $10\log(1/x)$.

Where: x is Duty Cycle (Linear)

Where: T is On Time

If that calculated VBW is not available on the analyzer then the next higher value should be used.

8.4. Original test data





2DH5_Ant1_2441



2DH5_Ant1_2480



3DH5_Ant1_2402



9. 20 dB Occupied Bandwidth and 99 % Occupied Bandwidth

9.1. Block diagram of test setup

Same as section 8.1

9.2. Limit

CFR 47 FCC Part15 (15.247) Subpart C ISED RSS-247 ISSUE 3			
Section	Test Item	Limit	Frequency Range (MHz)
CFR 47 FCC 15.247 (a) (1) RSS-247 Clause 5.1 (a)	20 dB Occupied Bandwidth	N/A	2400-2483.5
ISED RSS-Gen Clause 6.7	99 % Occupied Bandwidth	N/A	2400-2483.5

9.3. Test Procedure

Connect the UUT to the spectrum analyzer and use the following settings:

Center Frequency	The center frequency of the channel under test
Detector	Peak
RBW	For 20 dB Occupied Bandwidth: 1 % to 5 % of the 20 dB bandwidth For 99 % Occupied Bandwidth: 1 % to 5 % of the occupied bandwidth
VBW	For 20 dB Occupied Bandwidth: approximately 3×RBW For 99 % Occupied Bandwidth: ≥ 3×RBW
Span	approximately 2 to 3 times the 20 dB bandwidth
Trace	Max hold
Sweep	Auto couple

Allow the trace to stabilize and measure the maximum width of the emission that is constrained by the frequencies associated with the two outermost amplitude points (upper and lower frequencies) that are attenuated by 20 dB and 99 % relative to the maximum level measured in the fundamental emission.

9.4. Results

20 dB Occupied Bandwidth:

Test Mode	Ant.	Freq. (MHz)	20db EBW (MHz)	FL (MHz)	FH (MHz)
DH5	Ant1	2402	0.846	2401.547	2402.393
		2441	0.750	2440.610	2441.360
		2480	0.801	2479.616	2480.417
2DH5	Ant1	2402	1.344	2401.328	2402.672
		2441	1.338	2440.331	2441.669
		2480	1.338	2479.343	2480.681
3DH5	Ant1	2402	1.305	2401.358	2402.663
		2441	1.320	2440.346	2441.666
		2480	1.296	2479.349	2480.645

99 % Occupied Bandwidth

Test Mode	Ant.	Freq. (MHz)	OCB (MHz)	FL (MHz)	FH (MHz)
DH5	Ant1	2402	0.77969	2401.5997	2402.3794
		2441	0.76503	2440.6147	2441.3797
		2480	0.74372	2479.6334	2480.3772
2DH5	Ant1	2402	1.1849	2401.4120	2402.5969
		2441	1.1843	2440.4010	2441.5853
		2480	1.1918	2479.4085	2480.6003
3DH5	Ant1	2402	1.1832	2401.4049	2402.5881
		2441	1.1645	2440.4281	2441.5926
		2480	1.1681	2479.4184	2480.5865

9.5. Original test data

20 dB Occupied Bandwidth:

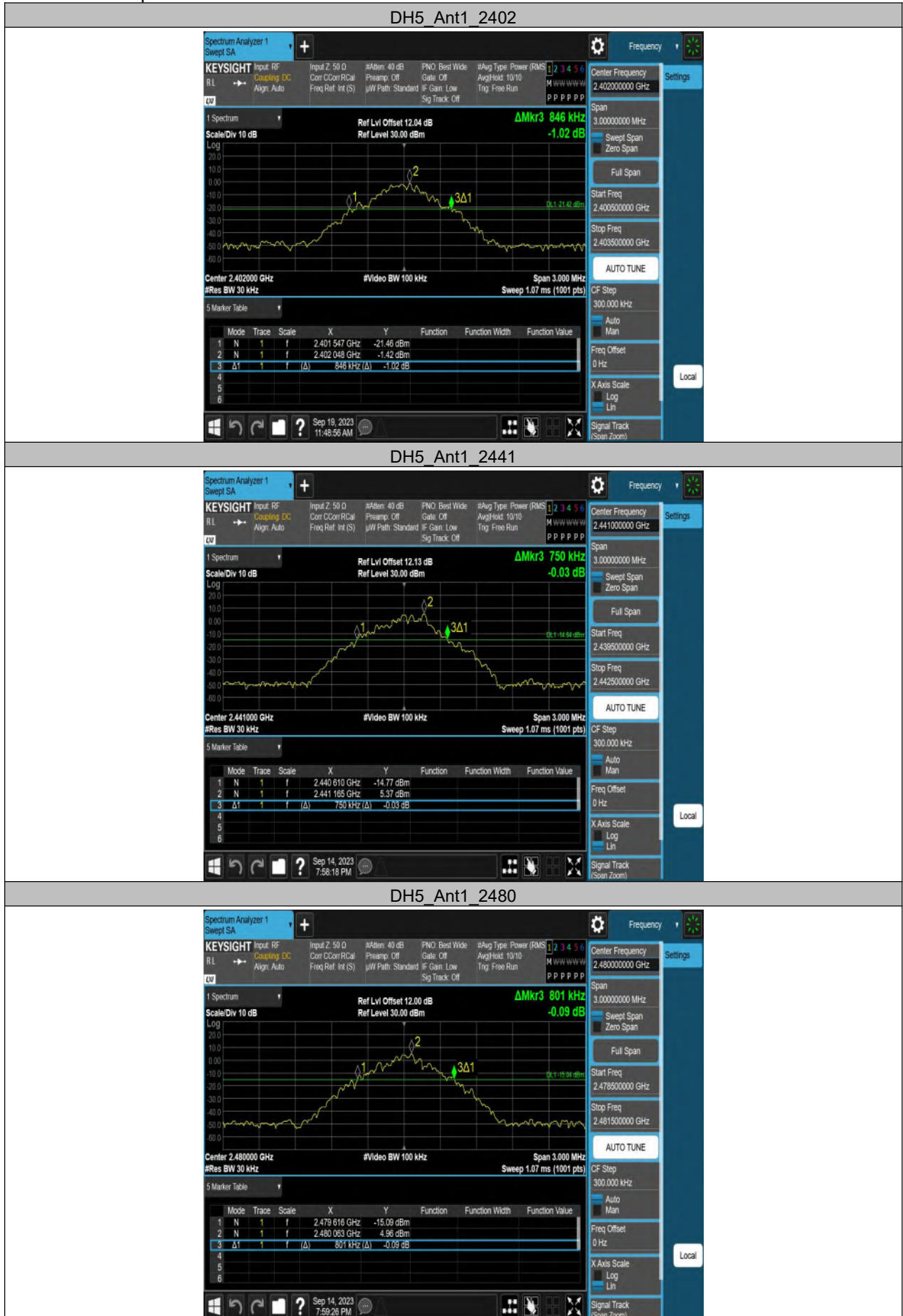

2DH5_Ant1_2402



2DH5_Ant1_2441



2DH5_Ant1_2480



3DH5_Ant1_2402



99 % Occupied bandwidth:

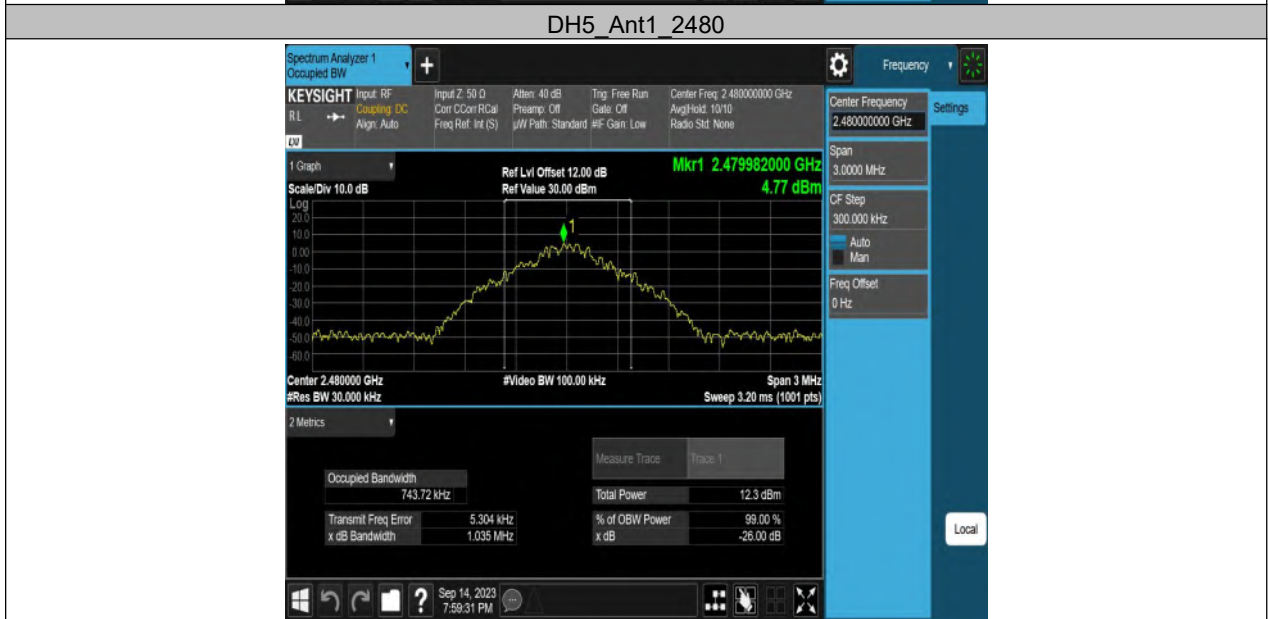
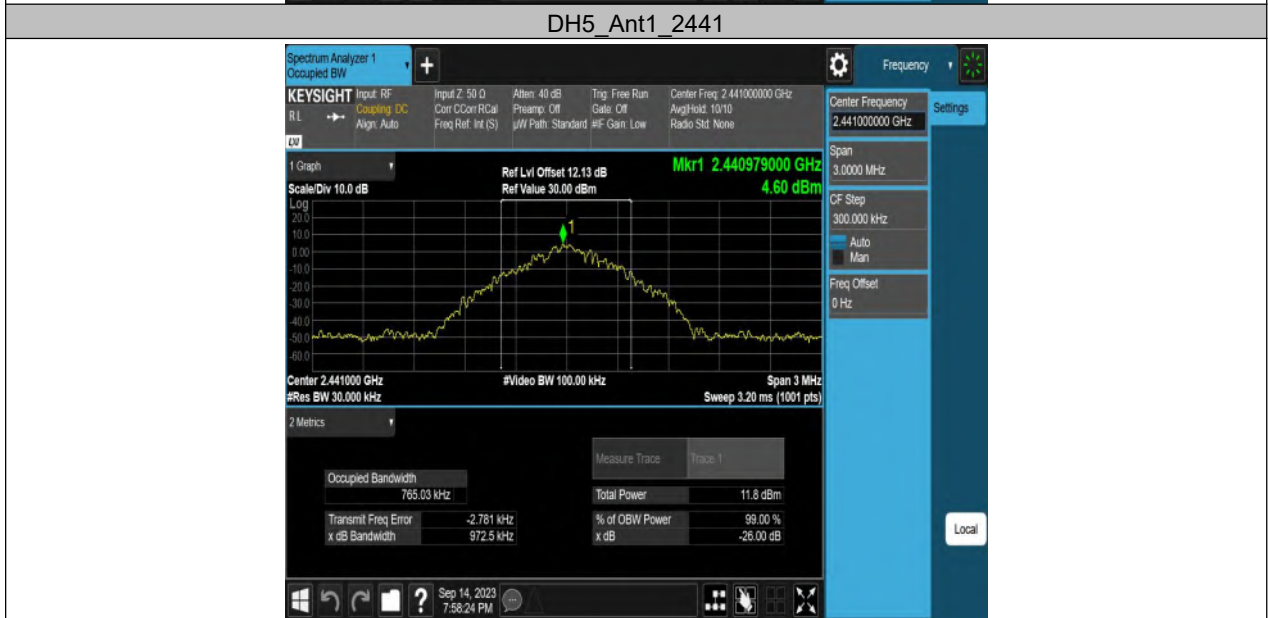
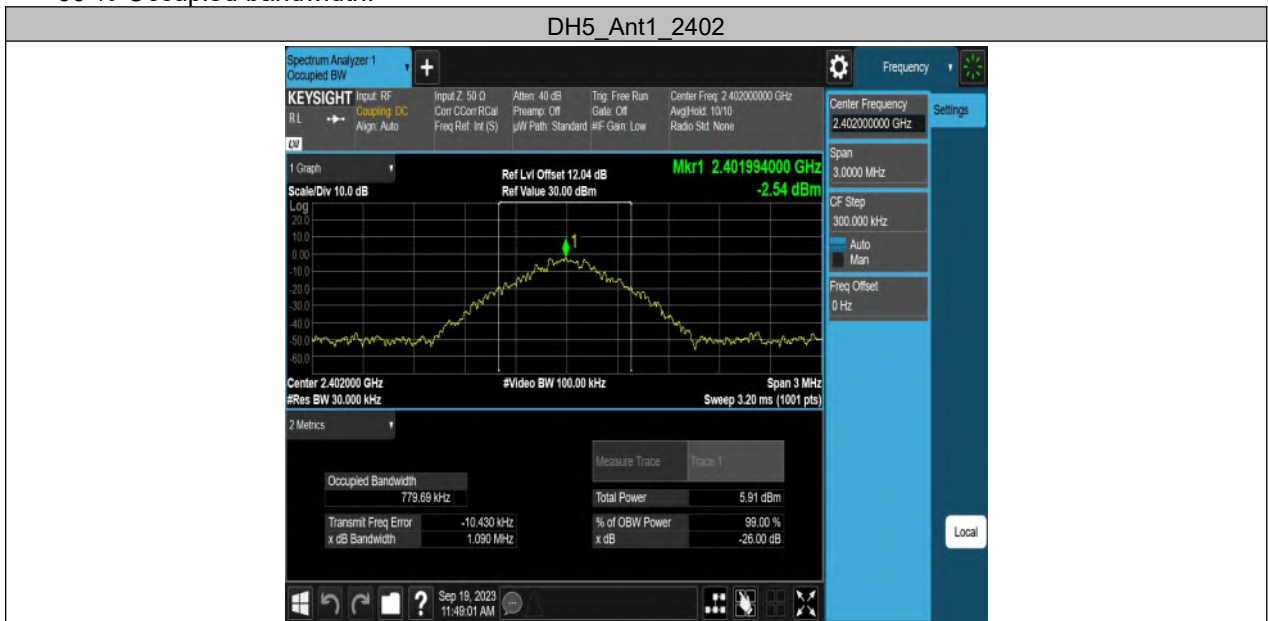

2DH5_Ant1_2402



2DH5_Ant1_2441



2DH5_Ant1_2480



3DH5_Ant1_2402



3DH5_Ant1_2441



3DH5_Ant1_2480



10. Conducted Output Power

10.1. Block diagram of test setup

Same as section 8.1

10.2. Limits

CFR 47 FCC Part15 (15.247) , Subpart C ISED RSS-247 ISSUE 3			
Section	Test Item	Limit	Frequency Range (MHz)
CFR 47 FCC 15.247 (b) (1) ISED RSS-247 Clause 5.4 (b)	Peak Conducted Output Power	Hopping channel carrier frequencies separated by a minimum of 25 kHz or the 20 dB bandwidth of the hopping channel: 1 watt or 30dBm; Hopping channel carrier frequencies that are separated by 25 kHz or two-thirds of the 20 dB bandwidth of the hopping channel : 125 mW or 21dBm	2400-2483.5

10.3. Test Procedure

(1) Connect EUT's antenna output to spectrum analyzer by RF cable.

(2) Measure the maximum output power of EUT by spectrum analyzer with PK detector and RBW=3 MHz (above 20 dB bandwidth of measured signal), VBW=8 MHz

Note: The attenuator loss was inputted into spectrum analyzer as amplitude offset.

10.4. Results

Test Mode	Ant.	Freq. (MHz)	Conducted Peak Power (dBm)	Conducted Limit (dBm)	Gain (dBi)	EIRP (dBm)	Limit (dBm)	Verdict
DH5	Ant1	2402	2.44	≤20.97	2.71	5.15	≤36	PASS
		2441	2.72	≤20.97	2.71	5.43	≤36	PASS
		2480	2.35	≤20.97	2.71	5.06	≤36	PASS
2DH5	Ant1	2402	5.02	≤20.97	2.71	7.73	≤36	PASS
		2441	5.19	≤20.97	2.71	7.9	≤36	PASS
		2480	4.6	≤20.97	2.71	7.31	≤36	PASS
3DH5	Ant1	2402	5.19	≤20.97	2.71	7.9	≤36	PASS
		2441	5.34	≤20.97	2.71	8.05	≤36	PASS
		2480	5.03	≤20.97	2.71	7.74	≤36	PASS

10.5. Original test data

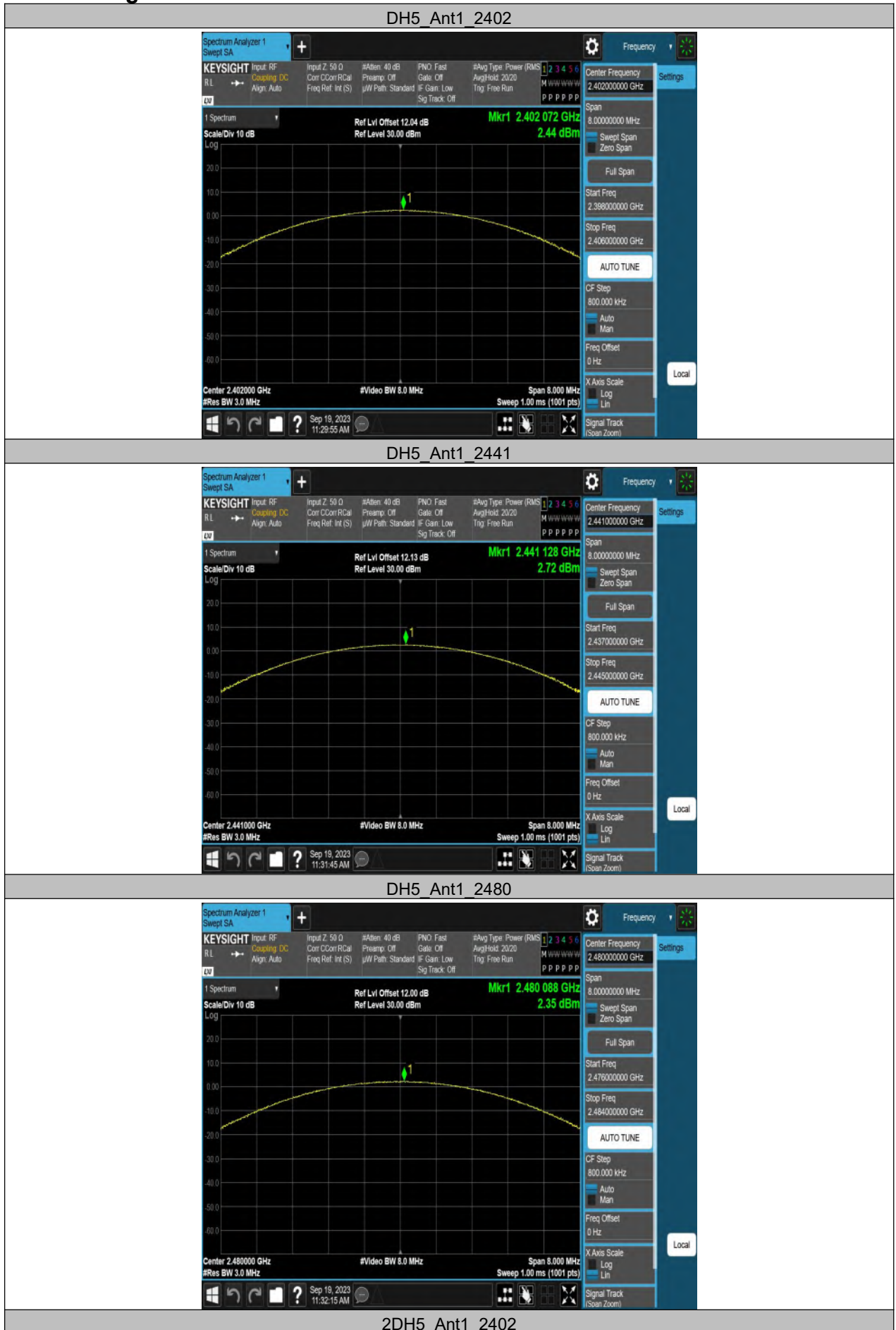



2DH5_Ant1_2441



2DH5_Ant1_2480



3DH5_Ant1_2402



3DH5_Ant1_2441

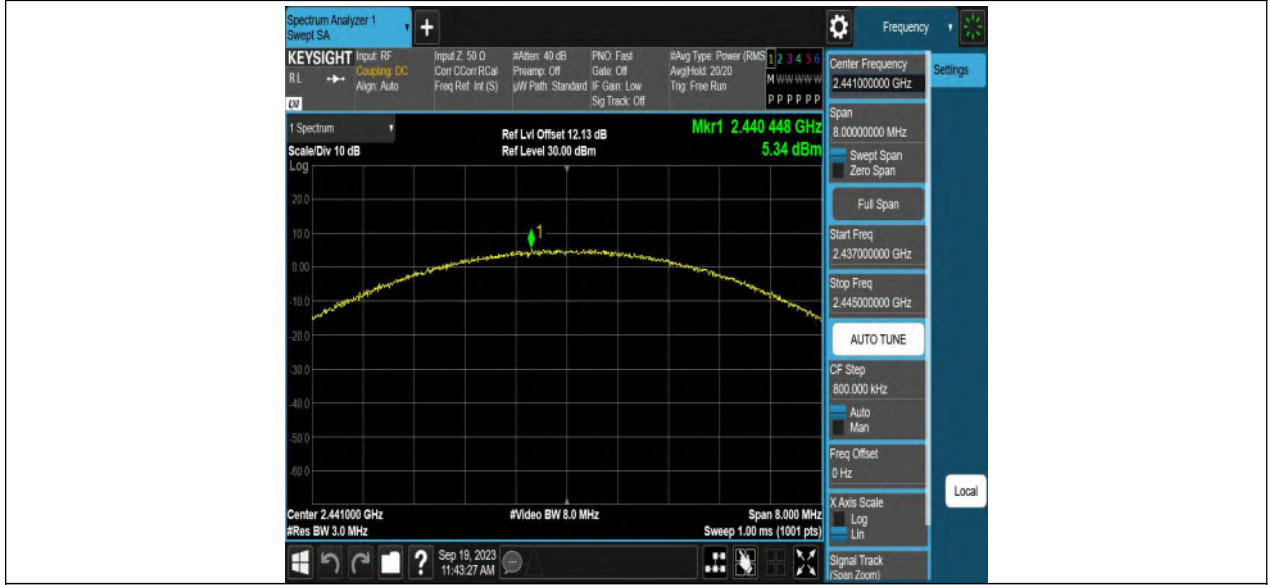

3DH5_Ant1_2480

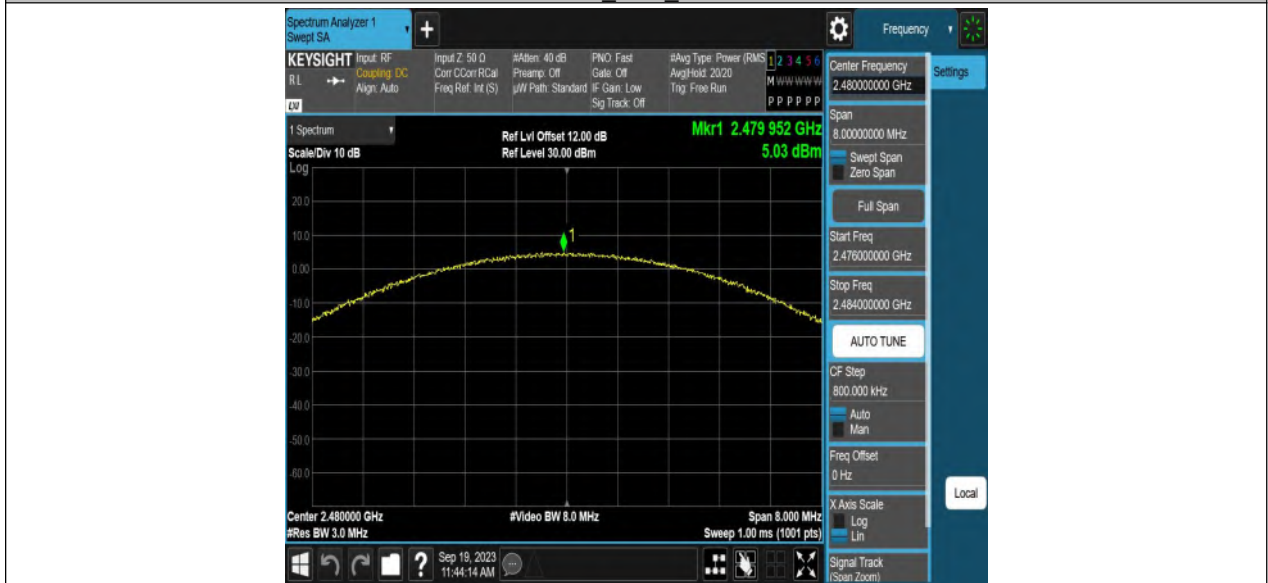

11. Carrier Hopping Channel Separation

11.1. Block diagram of test setup

Same as section 8.1

11.2. Limits

CFR 47 FCC Part15 (15.247) , Subpart C ISED RSS-247 ISSUE 3			
Section	Test Item	Limit	Frequency Range (MHz)
CFR 47 FCC 15.247 (a) (1) ISED RSS-247 Clause 5.1 (b)	Carrier Hopping Channel Separation	Frequency hopping systems shall have hopping channel carrier frequencies separated by a minimum of 25 kHz or the 20 dB bandwidth of the hopping channel, whichever is greater. Alternatively, frequency hopping systems operating in the 2400-2483.5 MHz band may have hopping channel carrier frequencies that are separated by 25 kHz or two-thirds of the 20 dB bandwidth of the hopping channel.	2400-2483.5

11.3. Test Procedure

Connect the UUT to the spectrum Analyzer and use the following settings:

Center Frequency	The center frequency of the channel under test
Span	wide enough to capture the peaks of two adjacent channels
Detector	Peak
RBW	Start with the RBW set to approximately 30 % of the channel spacing; adjust as necessary to best identify the center of each individual channel.
VBW	\geq RBW
Trace	Max hold
Sweep time	Auto couple

Allow the trace to stabilize. Use the marker-delta function to determine the separation between the peaks of the adjacent channels.

Compliance of an EUT with the appropriate regulatory limit shall be determined.

A plot of the data shall be included in the test report.

11.4. Results

Test Mode	Ant.	Freq. (MHz)	Result (MHz)	Limit (MHz)	Verdict
DH5	Ant1	Hop	0.986	≥ 0.861	PASS
2DH5	Ant1	Hop	1.024	≥ 0.896	PASS
3DH5	Ant1	Hop	0.994	≥ 0.880	PASS

11.5. Original test data

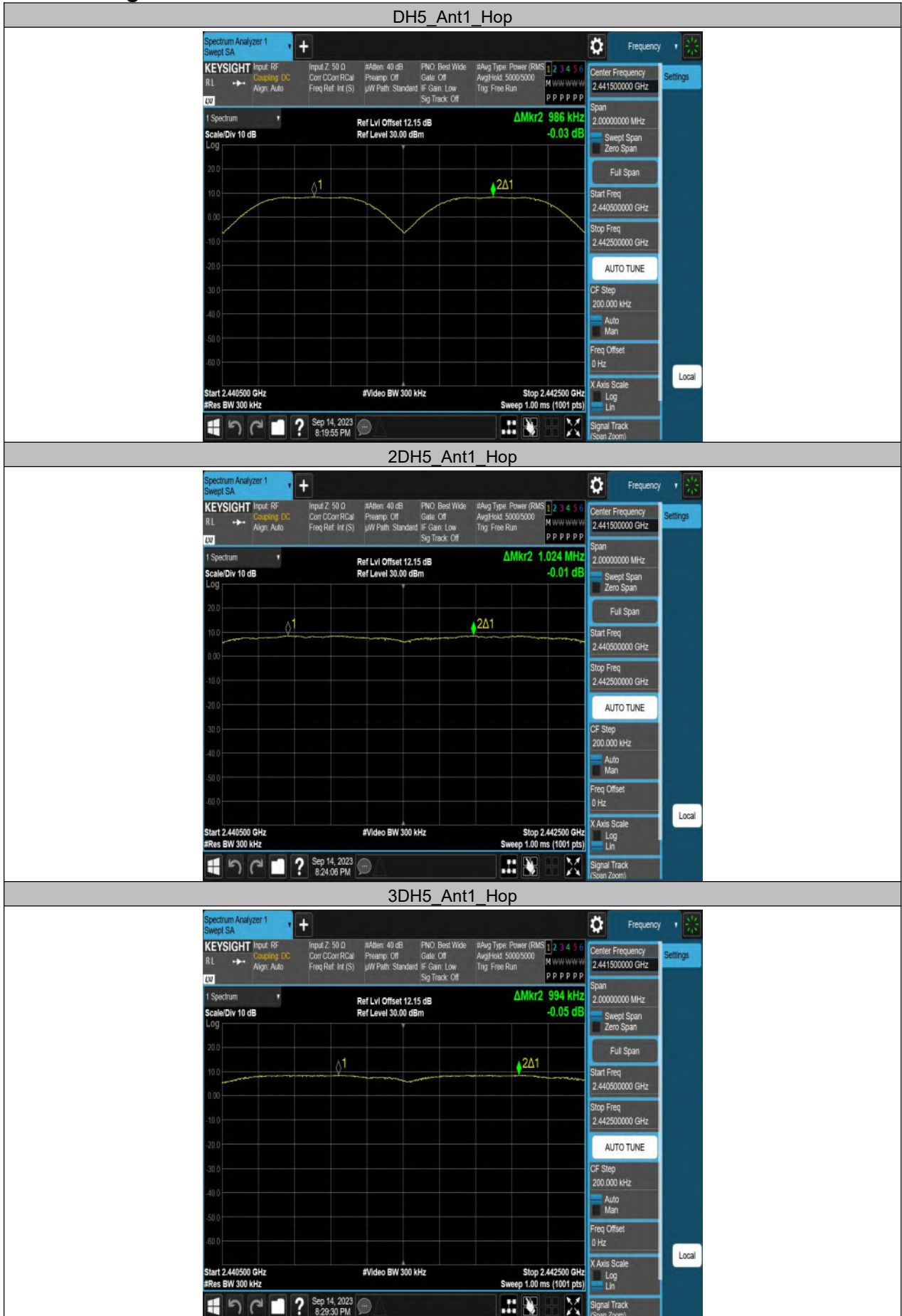

12. Number of Hopping Frequency

12.1. Block diagram of test setup

Same as section 8.1

12.2. Limits

CFR 47 FCC Part15 (15.247), Subpart C ISED RSS-247 ISSUE 3		
Section	Test Item	Limit
CFR 47 15.247 (a) (1) III ISED RSS-247 Clause 5.1 (d)	Number of Hopping Frequency	at least 15 hopping channels

12.3. Test Procedure

Connect the EUT to the spectrum Analyzer and use the following settings:

Detector	Peak
RBW	To identify clearly the individual channels, set the RBW to less than 30 % of the channel spacing or the 20 dB bandwidth, whichever is smaller.
VBW	\geq RBW
Span	The frequency band of operation
Trace	Max hold
Sweep time	Auto couple

Set EUT to transmit maximum output power and switch on frequency hopping function. then set enough count time (larger than 5000 times) to get all the hopping frequency channel displayed on the screen of spectrum analyzer.

Count the quantity of peaks to get the number of hopping channels.

FHSS Mode: 79 Channels observed.

AFHSS Mode: 20 Channels declared.

12.4. Results

Test Mode	Ant.	Freq. (MHz)	Result (Num)	Limit (Num)	Verdict
DH5	Ant1	Hop	79	\geq 15	PASS
2DH5	Ant1	Hop	79	\geq 15	PASS
3DH5	Ant1	Hop	79	\geq 15	PASS

12.5. Original test data

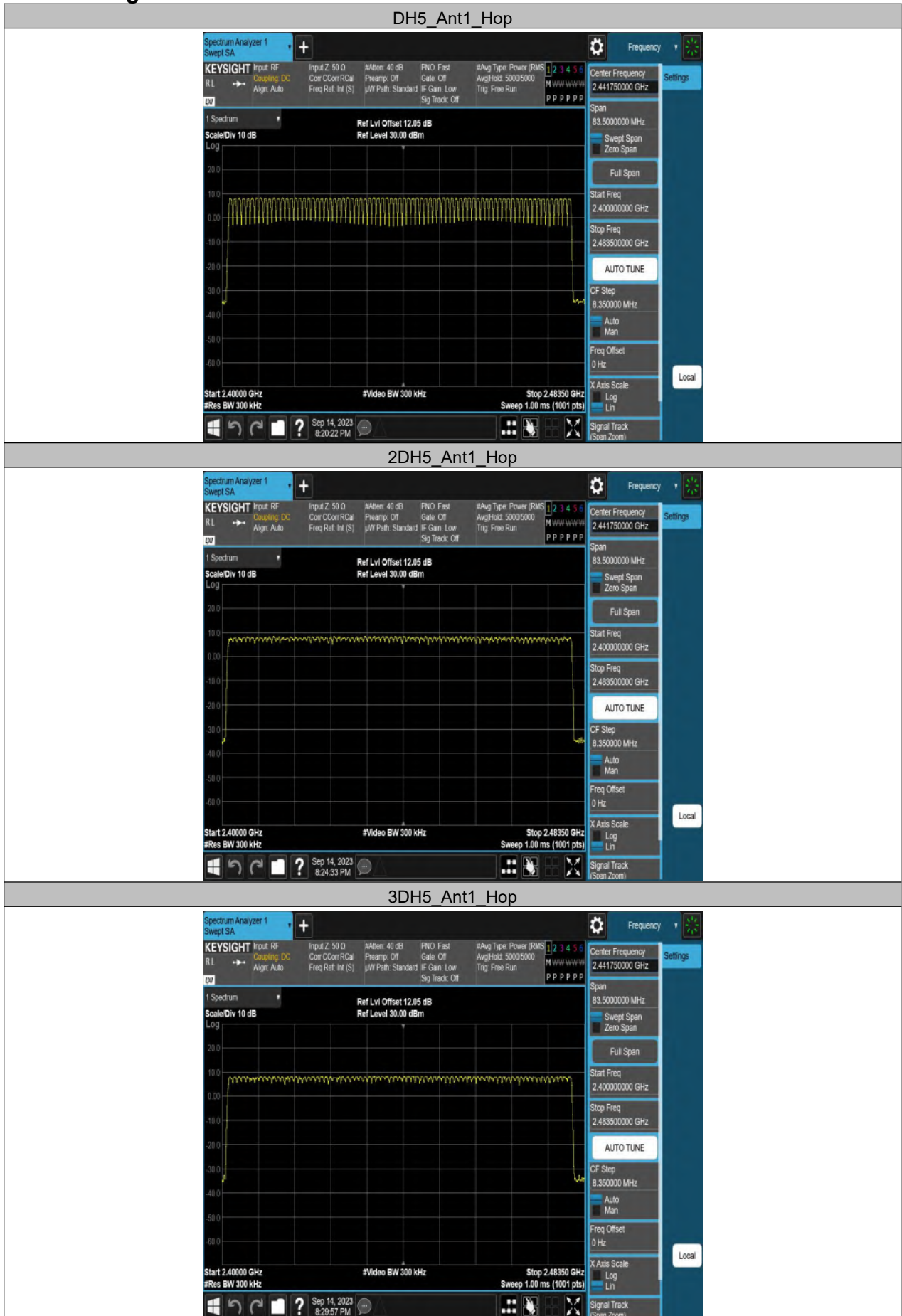

13. Time of Occupancy (Dwell Time)

13.1. Block diagram of test setup

Same as section 8.1

13.2. Limits

CFR 47 FCC Part15 (15.247), Subpart C ISED RSS-247 ISSUE 3		
Section	Test Item	Limit
CFR 47 15.247 (a) (1) III ISED RSS-247 Clause 5.1 (d)	Time of Occupancy (Dwell Time)	The average time of occupancy on any channel shall not be greater than 0.4 seconds within a period of 0.4 seconds, multiplied by the number of hopping channels employed.

13.3. Test Procedure

Connect the UUT to the spectrum analyzer and use the following settings:

Center Frequency	The center frequency of the channel under test
Detector	Average
RBW	1 MHz
VBW	≥ RBW
Span	zero span
Trace	Clear Write
Sweep time	As necessary to capture the entire dwell time per hopping channel

Connect the UUT to the spectrum Analyzer and use the following settings:

- The transmitter output (antenna port) was connected to the spectrum analyzer
- Set RBW of spectrum analyzer to 1 MHz and VBW to 3 MHz.
- Use a video trigger with the trigger level set to enable triggering only on full pulses.
- Sweep Time is more than once pulse time.
- Set the center frequency on any frequency would be measure and set the frequency span to zero span.
- Measure the maximum time duration of one single pulse.
- Set the EUT for DH5, DH3 and DH1 packet transmitting.
- Measure the maximum time duration of one single pulse.

A Period Time = (channel number)*0.4

For FHSS Mode (79 Channel):

DH1 Time Slot: Reading * (1600/2)*31.6/(channel number)

DH3 Time Slot: Reading * (1600/4)*31.6/(channel number)

DH5 Time Slot: Reading * (1600/6)*31.6/(channel number)

13.4. Results

Test Mode	Ant.	Freq. (MHz)	Burst Width (ms)	Total Hops (Num)	Result (s)	Limit (s)	Verdict
DH1	Ant1	Hop	0.374	320	0.12	≤0.4	PASS
DH3	Ant1	Hop	1.630	160	0.261	≤0.4	PASS
DH5	Ant1	Hop	2.878	106.67	0.307	≤0.4	PASS
2DH1	Ant1	Hop	0.383	320	0.123	≤0.4	PASS
2DH3	Ant1	Hop	1.633	160	0.261	≤0.4	PASS
2DH5	Ant1	Hop	2.882	106.67	0.307	≤0.4	PASS
3DH1	Ant1	Hop	0.381	320	0.122	≤0.4	PASS
3DH3	Ant1	Hop	1.633	160	0.261	≤0.4	PASS
3DH5	Ant1	Hop	2.884	106.67	0.308	≤0.4	PASS

13.5. Original test data



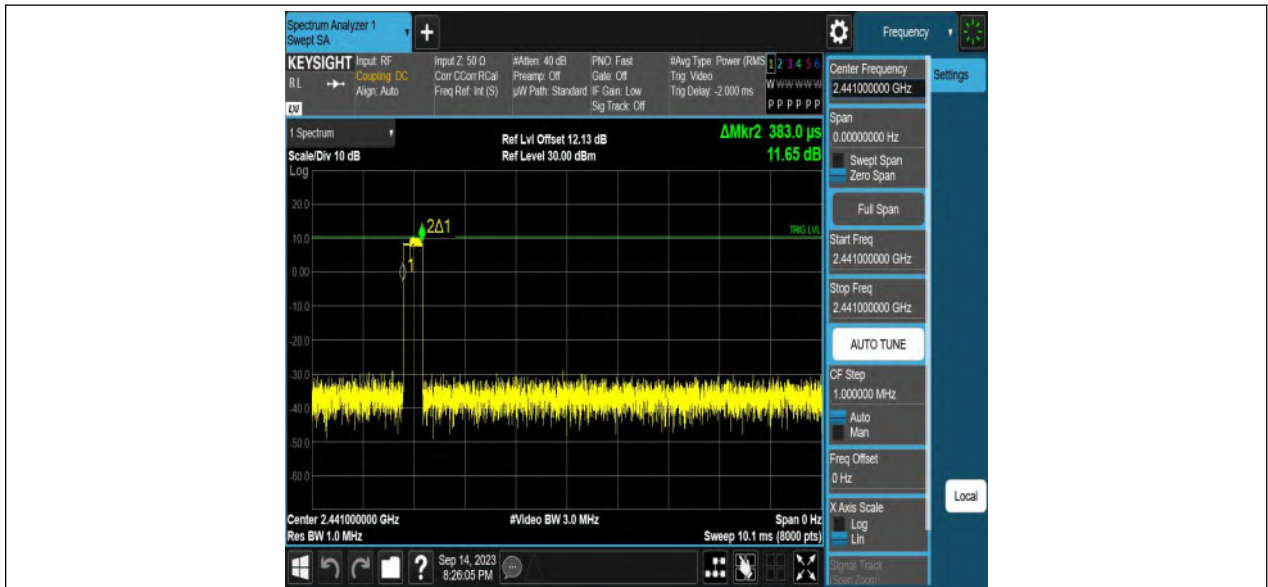

2DH3 Ant1 Hop



2DH5 Ant1 Hop



3DH1 Ant1 Hop



3DH3 Ant1 Hop



3DH5 Ant1 Hop



14. Conducted Spurious Emission

14.1. Block diagram of test setup

Same as section 8.1

14.2. Limits

CFR 47 FCC Part15 (15.247), Subpart C ISED RSS-247 ISSUE 3		
Section	Test Item	Limit
CFR 47 FCC §15.247 (d) ISED RSS-247 5.5	Conducted Spurious Emission	at least 20 dB below that in the 100 kHz bandwidth within the band that contains the highest level of the desired power

14.3. Test Procedure

Please refer to the ANSI C63.10 section 6.10.

For Band edge use the following settings:

Detector	Peak
RBW	100 kHz
VBW	300 kHz
Span	wide enough to fully capture the emission being measured
Trace	Max hold
Sweep time	Auto couple.

For Spurious Emission use the following settings:

Detector	Peak
RBW	100 kHz
VBW	300 kHz
Span	wide enough to fully capture the emission being measured
Trace	Max hold
Sweep time	Auto couple.

Use the peak marker function to determine the maximum amplitude level.

14.4. Results

Band edge:

Test Mode	Ant.	Ch Name	Freq. (MHz)	Ref Level (dBm)	Result (dBm)	Limit (dBm)	Verdict
DH5	Ant1	Low	2402	1.34	-49.3	≤-18.66	PASS
		High	2480	1.24	-47.85	≤-18.76	PASS
		Low	Hop_2402	1.36	-48.14	≤-18.64	PASS
		High	Hop_2480	1.64	-47.06	≤-18.36	PASS
2DH5	Ant1	Low	2402	0.99	-49.63	≤-19.01	PASS
		High	2480	-0.22	-49.09	≤-20.22	PASS
		Low	Hop_2402	0.17	-48.38	≤-19.83	PASS
		High	Hop_2480	0.21	-47.05	≤-19.79	PASS
3DH5	Ant1	Low	2402	-0.34	-49.9	≤-20.34	PASS
		High	2480	-0.66	-48.49	≤-20.66	PASS
		Low	Hop_2402	-2.73	-47.95	≤-22.73	PASS
		High	Hop_2480	0.52	-47.51	≤-19.48	PASS

Spurious Emission:

Test Mode	Ant.	Freq. (MHz)	Freq. Range (MHz)	Ref Level (dBm)	Result (dBm)	Limit (dBm)	Verdict
DH5	Ant1	2402	30~1000	1.34	-62.12	≤-18.66	PASS
			1000~26500	1.34	-50.88	≤-18.66	PASS
		2441	30~1000	1.84	-62.16	≤-18.16	PASS
			1000~26500	1.84	-49.94	≤-18.16	PASS
		2480	30~1000	1.24	-61.73	≤-18.76	PASS
			1000~26500	1.24	-50.41	≤-18.76	PASS
2DH5	Ant1	2402	30~1000	0.99	-61.87	≤-19.01	PASS
			1000~26500	0.99	-50.29	≤-19.01	PASS
		2441	30~1000	0.47	-61.95	≤-19.53	PASS
			1000~26500	0.47	-49.5	≤-19.53	PASS
		2480	30~1000	-0.22	-61.73	≤-20.22	PASS
			1000~26500	-0.22	-50.2	≤-20.22	PASS
3DH5	Ant1	2402	30~1000	-0.34	-61.83	≤-20.34	PASS
			1000~26500	-0.34	-50.41	≤-20.34	PASS
		2441	30~1000	1.15	-62.62	≤-18.85	PASS
			1000~26500	1.15	-50.22	≤-18.85	PASS
		2480	30~1000	-0.66	-61.78	≤-20.66	PASS
			1000~26500	-0.66	-49.55	≤-20.66	PASS

14.5. Original test data

Band edge:



DH5 Ant1 High Hop 2480

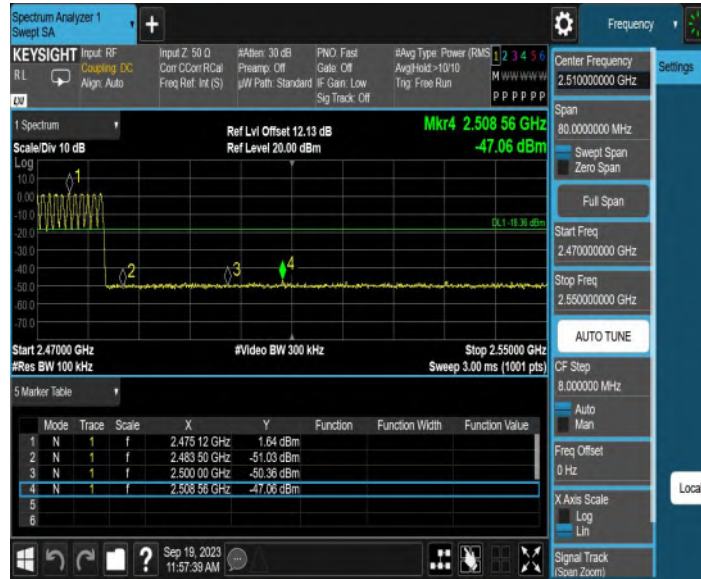

2DH5 Ant1 Low 2402



2DH5 Ant1 High 2480



2DH5 Ant1 Low Hop 2402

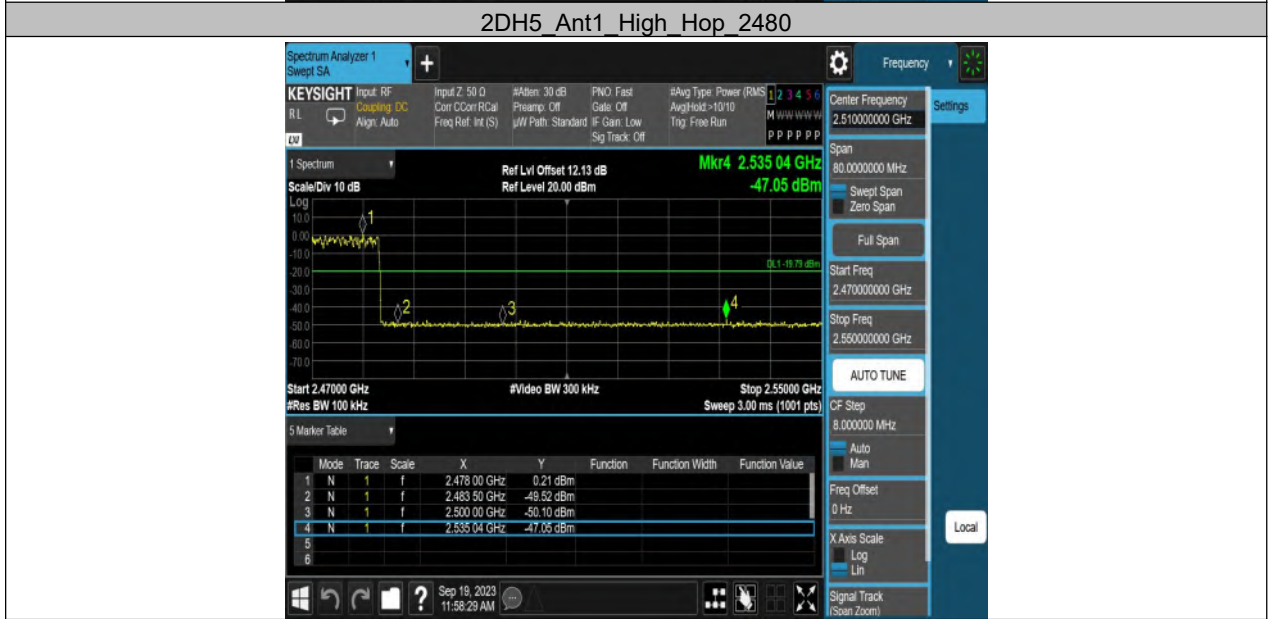

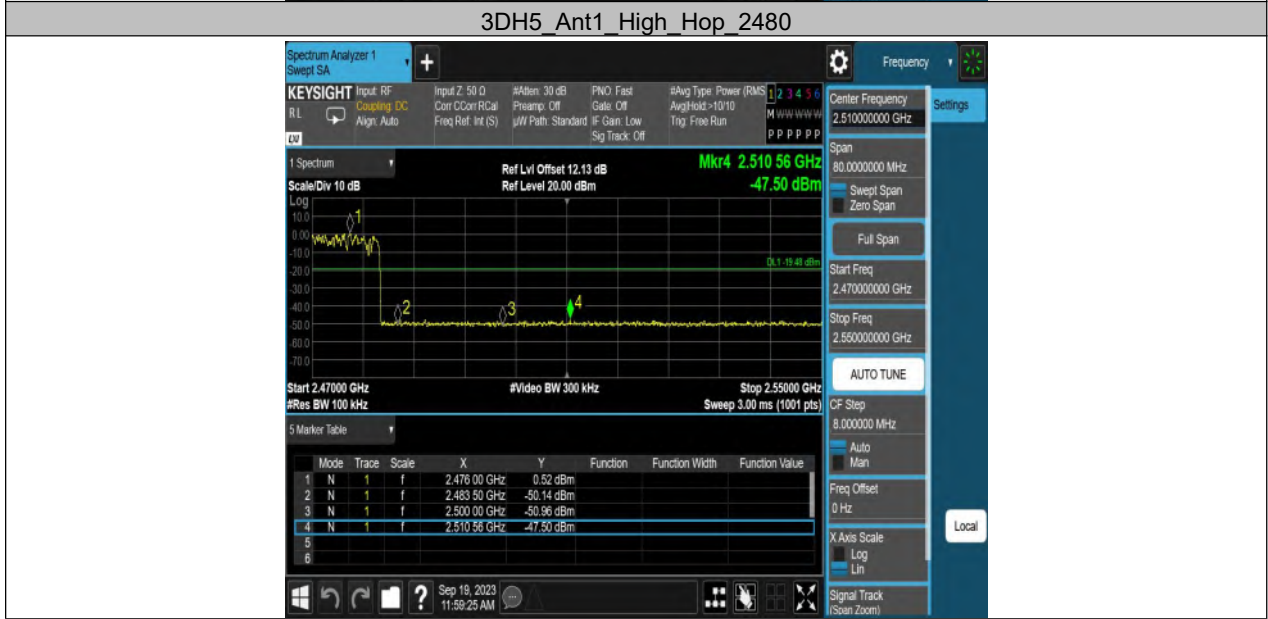
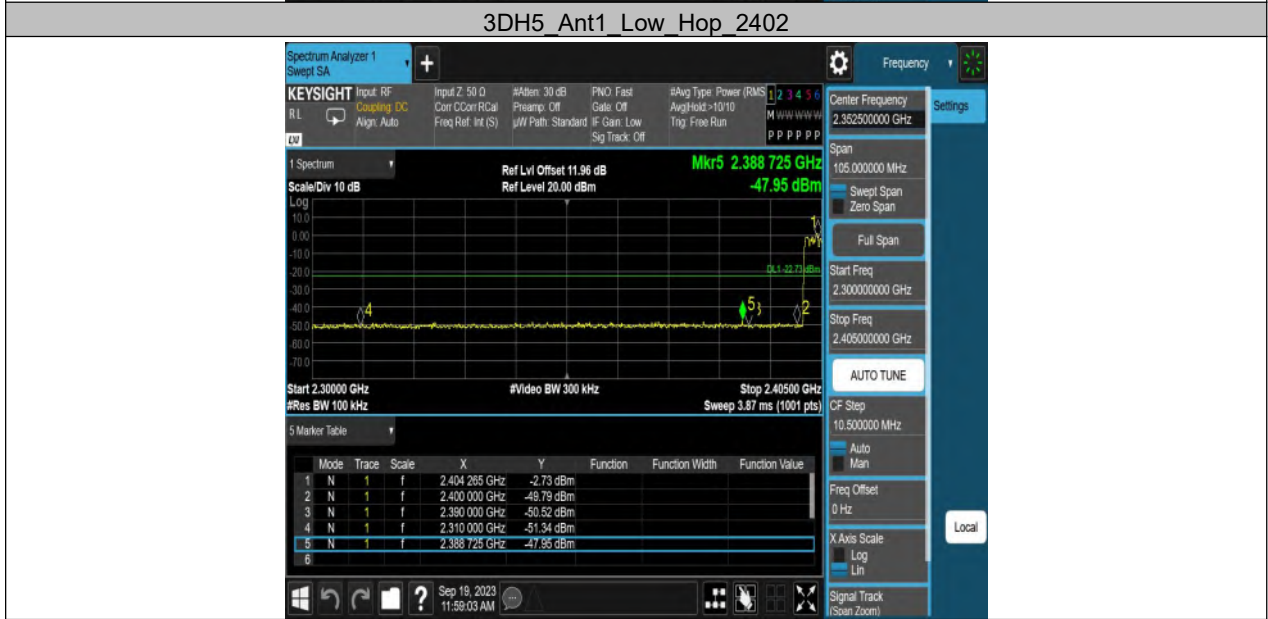

Spurious Emission:





DH5 Ant1_2480_30~1000



DH5 Ant1_2480_1000~26500



2DH5 Ant1_2402_30~1000



2DH5_Ant1_2402_1000~26500



2DH5_Ant1_2441_30~1000



2DH5_Ant1_2441_1000~26500

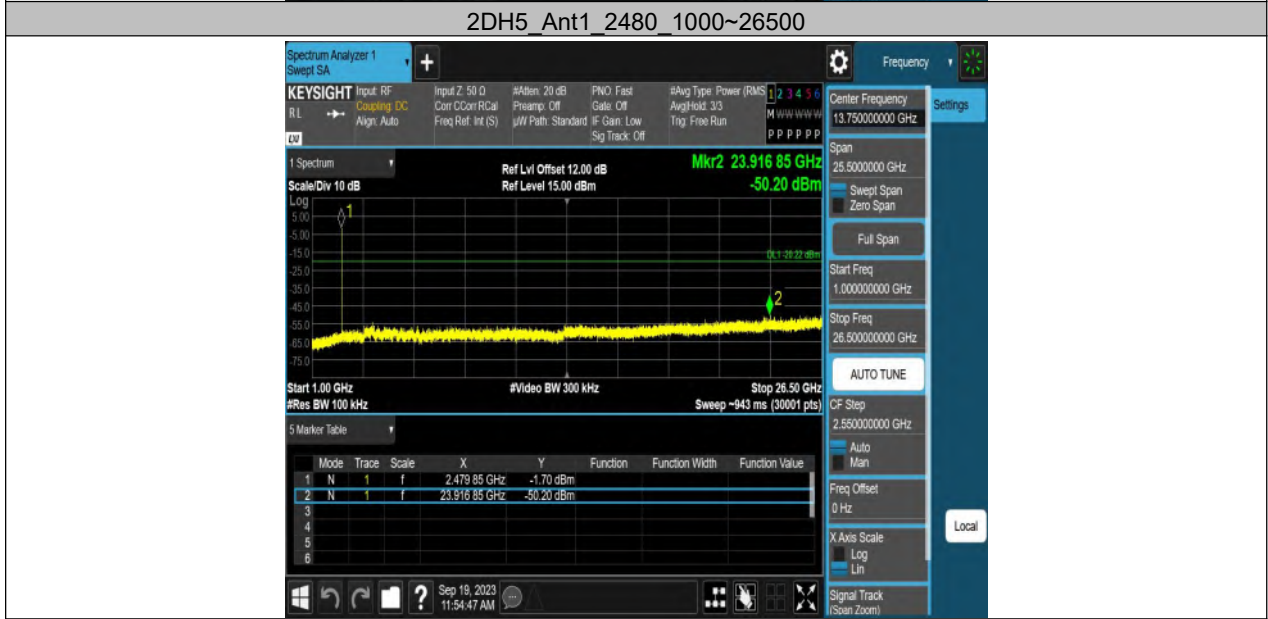
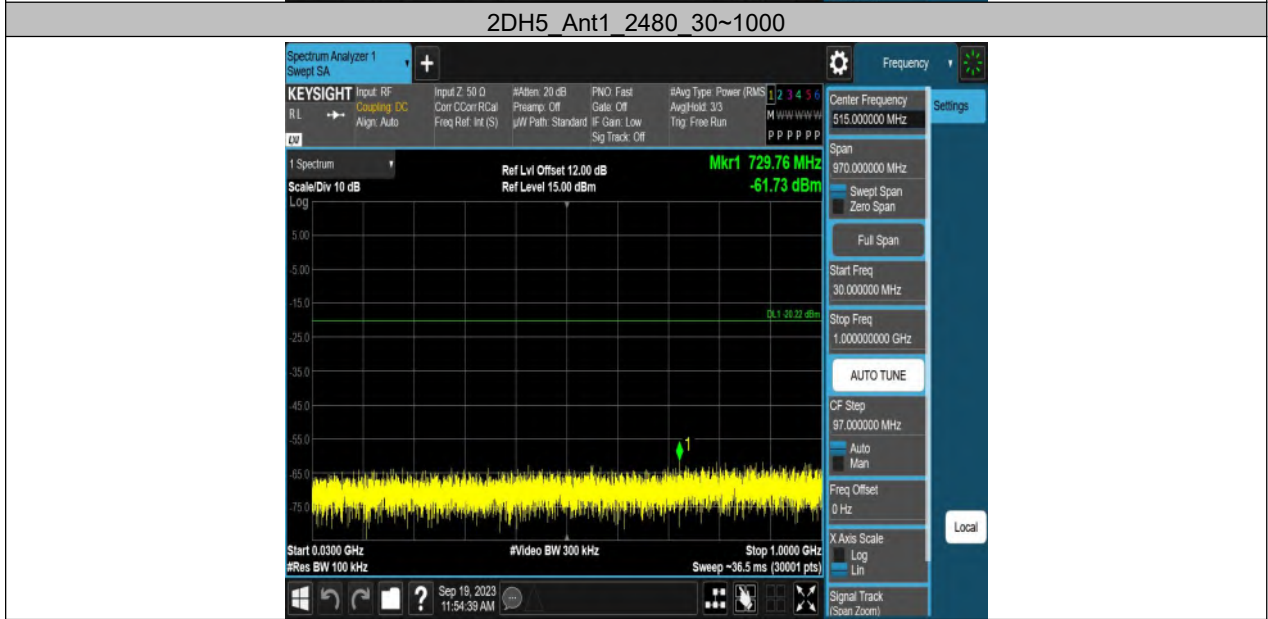



3DH5_Ant1_2402_1000~26500

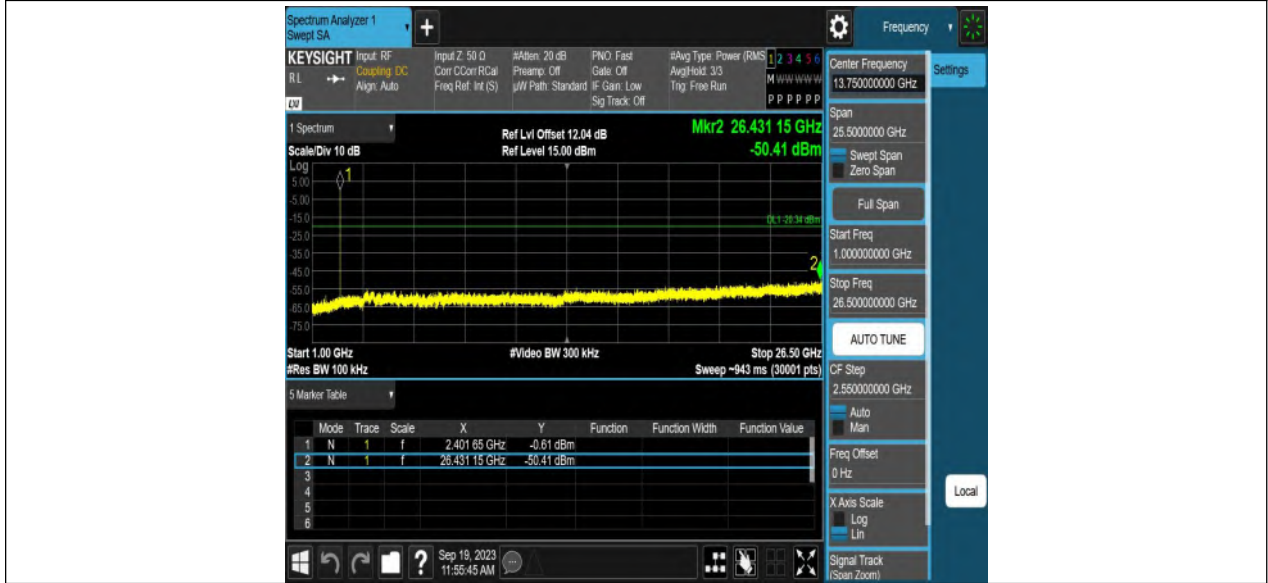

3DH5_Ant1_2441_30~1000



3DH5_Ant1_2441_1000~26500

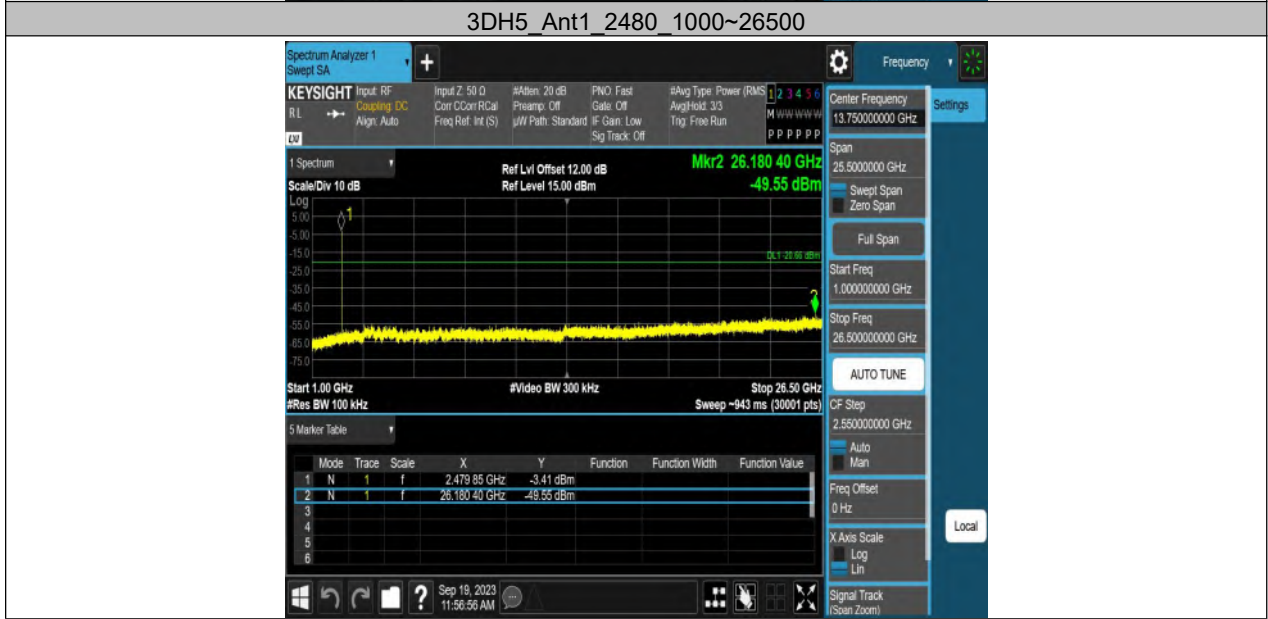
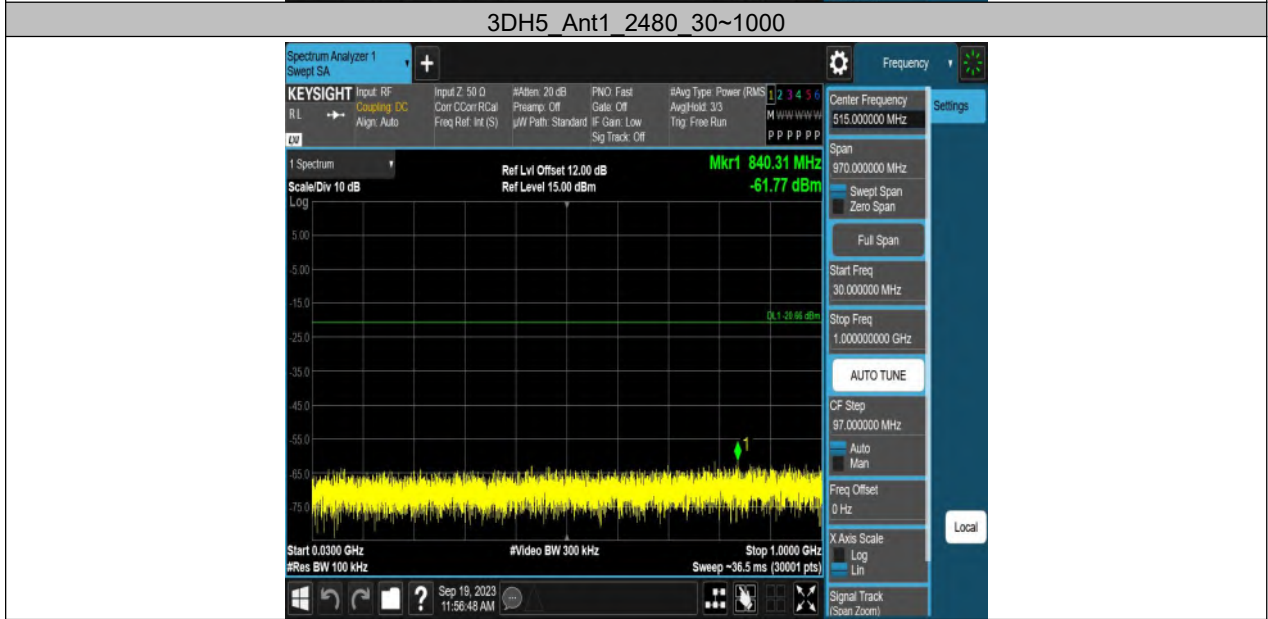

15. Radiated Emission

15.1. Block diagram of test setup

In 3m Anechoic Chamber, test setup diagram for 9kHz - 30MHz:

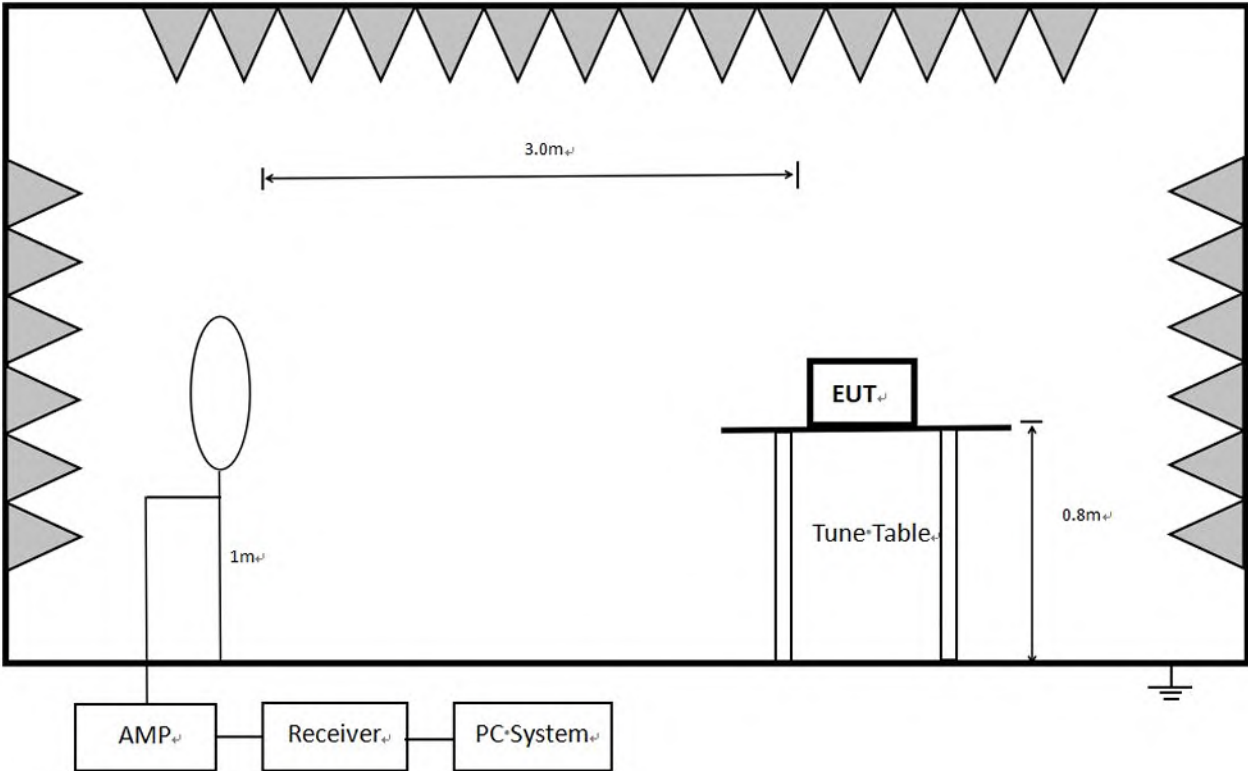

In 3m Anechoic Chamber, test setup diagram for 30 MHz - 1 GHz:

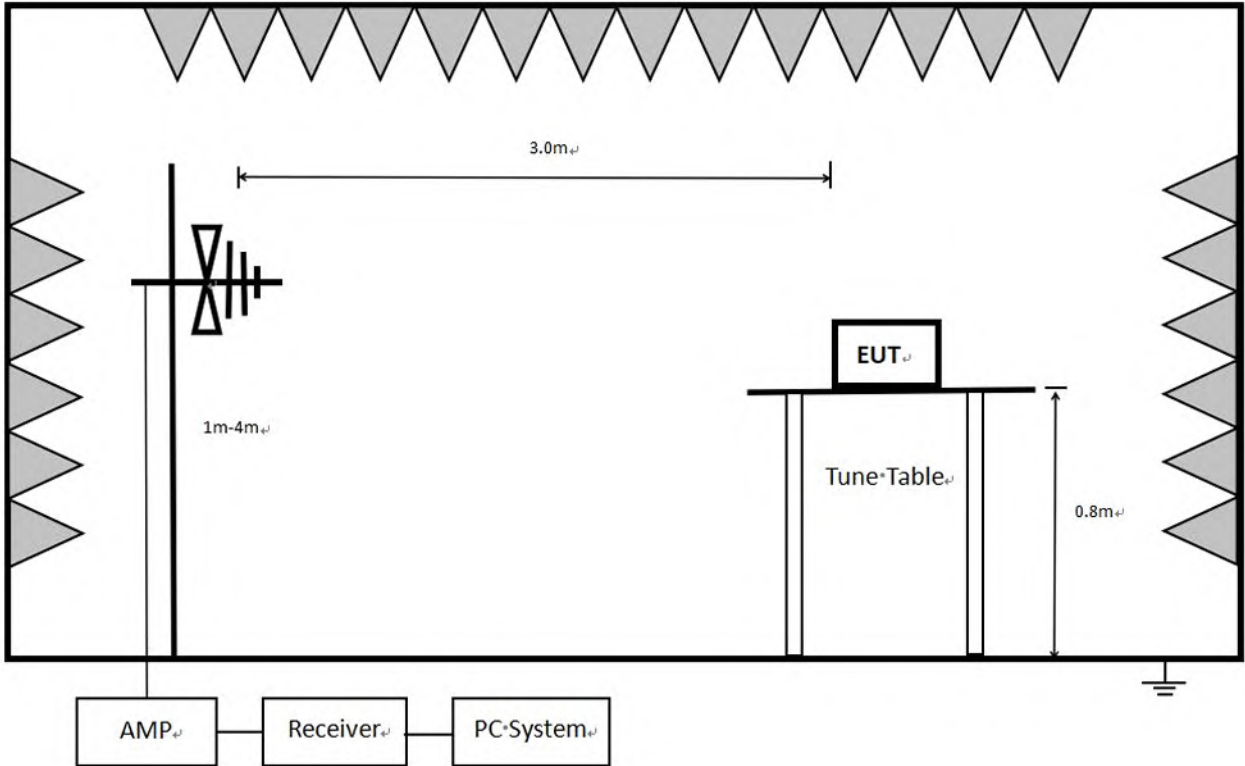

In 3m Anechoic Chamber, test setup diagram for frequency above 1 GHz:

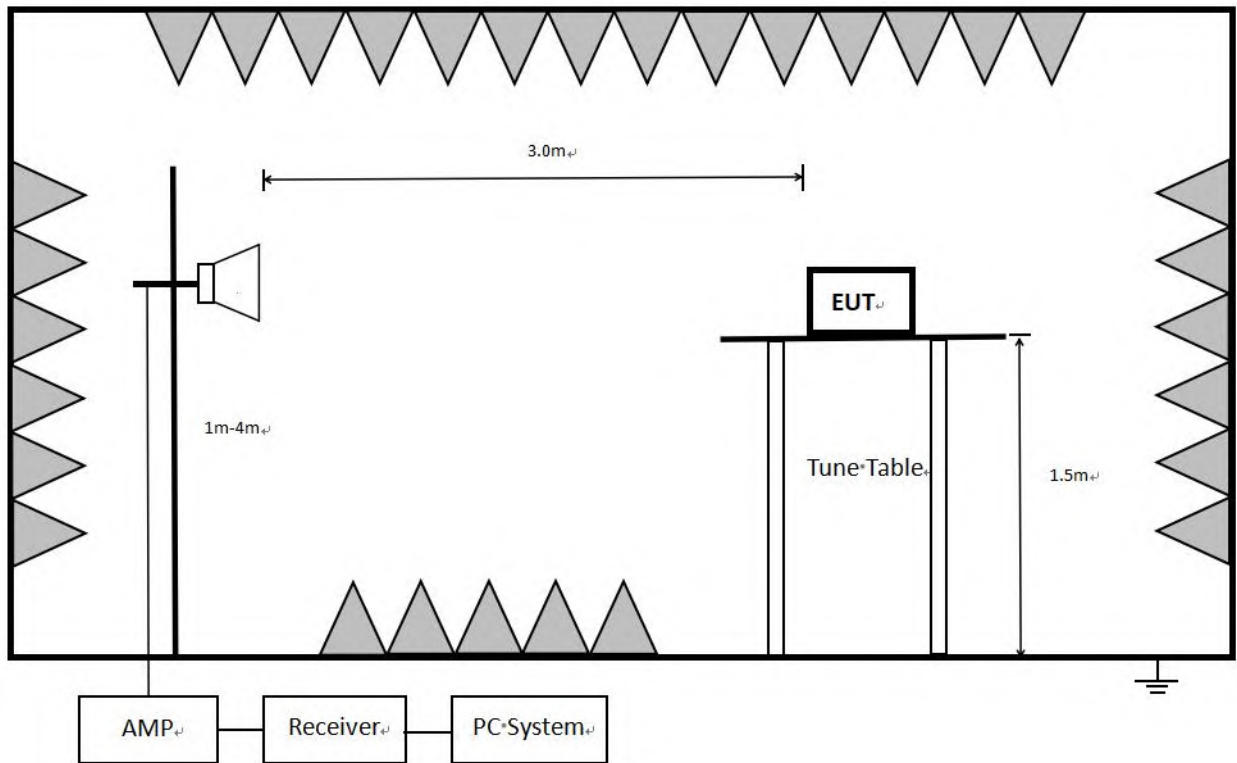

Note: For harmonic emissions test an appropriate high pass filter was inserted in the input port of AMP.

15.2. Limit

(1) FCC 15.205 Restricted frequency band

MHz	MHz	MHz	GHz
0.090-0.110	16.42-16.423	399.9-410	4.5-5.15
¹ 0.495-0.505	16.69475-16.69525	608-614	5.35-5.46
2.1735-2.1905	16.80425-16.80475	960-1240	7.25-7.75
4.125-4.128	25.5-25.67	1300-1427	8.025-8.5
4.1772&4.17775	37.5-38.25	1435-1626.5	9.0-9.2
4.2072&4.20775	73-74.6	1645.5-1646.5	9.3-9.5
6.215-6.218	74.8-75.2	1660-1710	10.6-12.7
6.26775-6.26825	108-121.94	1718.8-1722.2	13.25-13.4
6.31175-6.31225	123-138	2200-2300	14.47-14.5
8.291-8.294	149.9-150.05	2310-2390	15.35-16.2
8.362-8.366	156.52475-156.52525	2483.5-2500	17.7-21.4
8.37625-8.38675	156.7-156.9	2690-2900	22.01-23.12
8.41425-8.41475	162.0125-167.17	3260-3267	23.6-24.0
12.29-12.293	167.72-173.2	3332-3339	31.2-31.8
12.51975-12.52025	240-285	3345.8-3358	36.43-36.5
12.57675-12.57725	322-335.4	3600-4400	(²)
13.36-13.41			

¹Until February 1, 1999, this restricted band shall be 0.490-0.510 MHz.

²Above 38.6

(2) FCC 15.209 Limit.

Frequency MHz	Distance Meters	Field Strengths Limit	
		$\mu\text{V}/\text{m}$	$\text{dB}(\mu\text{V})/\text{m}$
0.009 ~ 0.490	300	$2400/\text{F}(\text{kHz})$	$67.6-20\log(\text{F})$
0.490 ~ 1.705	30	$24000/\text{F}(\text{kHz})$	$87.6-20\log(\text{F})$
1.705 ~ 30.0	30	30	29.54
30 ~ 88	3	100	40.0
88 ~ 216	3	150	43.5
216~960	3	200	46.0
960~1000	3	500	54.0
Above 1000	3	74.0 $\text{dB}(\mu\text{V})/\text{m}$ (Peak) 54.0 $\text{dB}(\mu\text{V})/\text{m}$ (Average)	

Note: 1) At frequencies at or above 30 MHz, measurements may be performed at a distance other than what is specified provided: measurements are not made in the near field except where it can be shown that near field measurements are appropriate due to the characteristics of the device; and it can be demonstrated that the signal levels needed to be measured at the distance employed can be detected by the measurement equipment. Measurements shall not be performed at a distance greater than 30 meters unless it can be further demonstrated that measurements at a distance of 30 meters or less are impractical. When performing measurements at a distance other than that specified, the results shall be extrapolated to the specified distance using an extrapolation factor of 20 dB/decade (inverse linear-distance for field strength measurements; inverse-linear-distance-squared for power density measurements).

(2) At frequencies below 30 MHz, measurements may be performed at a distance closer than that specified in the regulations; however, an attempt should be made to avoid making measurements in the near field. Pending the development of an appropriate measurement procedure for measurements performed below 30 MHz, when performing measurements at a closer distance than specified, the results shall be extrapolated to the specified distance by either making measurements at a minimum of two distances on at least one radial to determine the proper extrapolation factor or by using the square of an inverse linear distance extrapolation factor (40 dB/decade). This paragraph (f) shall not apply to Access BPL devices operating below 30 MHz.

About Restricted bands of operation please refer to RSS-Gen section 8.10 and FCC § 15.205 (a),

15.3. Test Procedure

Below 30 MHz:

The setting of the spectrum Analyzer

RBW	300 Hz (From 9 kHz to 0.15 MHz)/ 10 kHz (From 0.15 MHz to 30 MHz)
VBW	1 kHz (From 9 kHz to 0.15 MHz)/ 30 kHz (From 0.15 MHz to 30 MHz)
Sweep	Auto
Trace	Max hold

1. The testing follows the guidelines in ANSI C63.10-2013
2. The EUT was arranged to its worst case and then turntable (from 0 degree to 360 degrees) to find the maximum reading. A pre-amp and a high pass filter are used for the test in order to get better signal level. Both Horizontal, Face-on and Face-off polarizations of the antenna are set to make the measurement.
3. The EUT was placed on a turntable with 80 cm meter above ground.
4. The EUT was set 3 meters from the interference receiving antenna, which was mounted on the top of 1 meter height antenna tower.
5. The radiated emission limits are based on measurements employing a CISPR quasi-peak detector except for the frequency bands 9-90 kHz, 110-490 kHz and above 1000 MHz. Radiated emission limits in these three bands are based on measurements employing an average detector.
6. For measurement below 1 GHz, the initial step in collecting conducted emission data is a spectrum analyzer peak detector mode pre-scanning the measurement frequency range. Significant peaks are then marked and then Quasi Peak detector mode re-measured. If the emission level of the EUT measured by the peak detector is 3 dB lower than the applicable limit, the peak emission level will be reported. Otherwise, the emission measurement will be repeated using the quasi-peak detector and reported.
7. Although these tests were performed other than open field site, adequate comparison measurements were confirmed against 30m open field site. Therefore, sufficient tests were made to demonstrate that the alternative site produces results that correlate with the ones of tests made in an open field site based on KDB 414788.

Below 1 GHz and above 30 MHz:

The setting of the spectrum Analyzer

RBW	100 kHz
VBW	300 kHz
Sweep	Auto
Trace	Max hold

1. The testing follows the guidelines in ANSI C63.10-2013.
2. The EUT was arranged to its worst case and then tune the antenna tower (from 1 m to 4 m) and turntable (from 0 degree to 360 degrees) to find the maximum reading. A pre-amp and a high pass filter are used for the test in order to get better signal level. Both horizontal and vertical polarizations of the antenna are set to make the measurement.
3. The EUT was placed on a turntable with 80 cm above ground.
4. The EUT was set 3 meters from the interference receiving antenna, which was mounted on the top of a variable height antenna tower.
5. For measurement below 1GHz, the initial step in collecting conducted emission data is a spectrum analyzer peak detector mode pre-scanning the measurement frequency range. Significant peaks are then marked and then Quasi Peak detector mode re-measured. If the emission level of the EUT measured by the peak detector is 3 dB lower than the applicable limit, the peak emission level will be reported. Otherwise, the emission measurement will be repeated using the quasi-peak detector and reported.

Above 1 GHz:

RBW	1 MHz
VBW	PEAK: 3 MHz AVG: see note 6
Sweep	Auto
Detector	Peak
Trace	Max hold

1. The testing follows the guidelines in ANSI C63.10-2013.

2. The EUT was arranged to its worst case and then tune the antenna tower (from 1 m to 4 m) and turntable (from 0 degree to 360 degrees) to find the maximum reading. A pre-amp and a high pass filter are used for the test in order to get better signal level. Both horizontal and vertical polarizations of the antenna are set to make the measurement.

3. The EUT was placed on a turntable with 1.5m above ground.

4. The EUT was set 3 meters from the interference receiving antenna, which was mounted on the top of a variable height antenna tower.

5. For measurement above 1GHz, the emission measurement will be measured by the peak detector. This peak level, once corrected, must comply with the limit specified in Section 15.209.

6. For measurements above 1 GHz the resolution bandwidth is set to 1 MHz, then the video bandwidth is set to 3 MHz for peak measurements and 1 MHz resolution bandwidth with 1/T video bandwidth with peak detector for AVG measurements. For the Duty Cycle please refer to clause 7.1.On Time And Duty Cycle.

7. Restriction band: Investigated frequency range from 2310 MHz to 2410 MHz and 2470MHz to 2500 MHz.

All restriction band should comply with 15.209, other emission should be at least 20 dB below the fundamental.

Note 1: For all radiated test, EUT in each of three orthogonal axis emissions had been tested, but only the worst case (X axis) data recorded in the report.

Note 2: The EUT does not support simultaneous transmission.

Note 3: The EUT was fully exercised with external accessories during the test. In the case of multiple accessory external ports, an external accessory shall be connected to one of each type of port.

15.4. Results

Pass. (See below detailed test result)

All the emissions except fundamental emission from 9 kHz to 25 GHz were comply with 15.209 limits.

Note1: According exploratory test, the emission levels are 20 dB below the limit detected from 9 kHz to 30 MHz, so the final test was performed with frequency range from 30 MHz to 26 GHz and recorded in below.

Note2: For emissions below 1 GHz, according exploratory explorer test, when change Tx mode and channel, have no distinct influence on emissions level, so for emissions below 1 GHz, the final test was only performed with EUT working in GFSK, TX 2402 MHz mode.

Note3: For emissions above 1 GHz. If peak results comply with AV limit, AV Result is deemed to comply with AV limit.

15.5. Original test data

Below 1 GHz and above 30 MHz test data Refer to appendix A

Above 1 GHz test data Refer to appendix B

16. AC Power Line Conducted Emissions

16.1. Block diagram of test setup

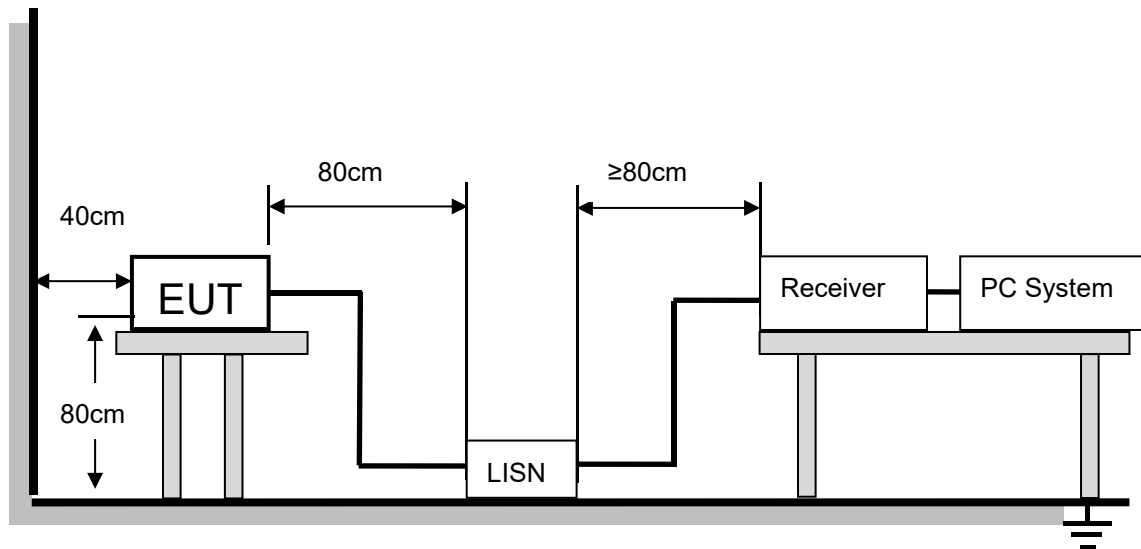

The EUT is put on a table of non-conducting material that is 80 cm high. The vertical conducting wall of shielding is located 40 cm to the rear of the EUT. The power line of the EUT is connected to the AC mains through an Artificial Mains Network (A.M.N.). A EMI Measurement Receiver (R&S Test Receiver ESR3) is used to test the emissions from both sides of AC line. According to the requirements in Section 6.2 of ANSI C63.10-2013. Conducted emissions from the EUT measured in the frequency range between 0.15 MHz and 30 MHz using CISPR Quasi-Peak and average detector mode. The bandwidth of EMI test receiver is set at 9 kHz.

The arrangement of the equipment is installed to meet the standards and operating in a manner, which tends to maximize its emission characteristics in a normal application.

16.2. Limits

Please refer to CFR 47 FCC § 15.207 (a) and ISED RSS-Gen Clause 8.8.

Frequency (MHz)	Quasi-peak	Average
0.15 -0.5	66 - 56 *	56 - 46 *
0.50 -5.0	56.00	46.00
5.0 -30.0	60.00	50.00

Note 1: * Decreasing linearly with logarithm of frequency.

Note 2: The lower limit shall apply at the transition frequencies.

16.3. Test procedure

The EUT and Support equipment, if needed, were put placed on a non-metallic table, 80cm above the ground plane.

Configuration EUT to simulate typical usage as described in clause 2.4 and test equipment as described in clause 10.2 of this report.

All I/O cables were positioned to simulate typical actual usage as per ANSI C63.10.

All support equipment power received from a second LISN.

Emissions were measured on each current carrying line of the EUT using an EMI Test Receiver connected to the LISN powering the EUT.

The Receiver scanned from 150 kHz to 30 MHz for emissions in each of the test modes.

During the above scans, the emissions were maximized by cable manipulation.

The test mode(s) described in clause 2.4 were scanned during the preliminary test.

After the preliminary scan, we found the test mode producing the highest emission level.

The EUT configuration and worse cable configuration of the above highest emission levels were recorded for reference of the final test.

EUT and support equipment were set up on the test bench as per the configuration with highest emission level in the preliminary test.

A scan was taken on both power lines, Neutral and Line, recording at least the six highest emissions.

Emission frequency and amplitude were recorded into a computer in which correction factors were used to calculate the emission level and compare reading to the applicable limit.

The test data of the worst-case condition(s) was recorded.

The bandwidth of test receiver is set at 9 kHz.

16.4. Test result

According to 15.207, power Line Conducted Emission is not required for devices which only employ battery power for operation and which do not operate from the AC power lines or contain provisions for operation while connected to the AC power lines.

17. Antenna Requirements

17.1. Limits

Please refer to FCC § 15.203

An intentional radiator shall be designed to ensure that no antenna other than that furnished by the responsible party shall be used with the device. The use of a permanently attached antenna or of an antenna that uses a unique coupling to the intentional radiator shall be considered sufficient to comply with the provisions of this section. The manufacturer may design the unit so that a broken antenna can be replaced by the user, but the use of a standard antenna jack or electrical connector is prohibited.

Please refer to FCC § 15.247(b)(4)

The conducted output power limit specified in paragraph (b) of this section is based on the use of antennas with directional gains that do not exceed 6 dBi. Except as shown in paragraph (c) of this section, if transmitting antennas of directional gain greater than 6 dBi are used, the conducted output power from the intentional radiator shall be reduced below the stated values in paragraphs (b)(1), (b)(2), and (b)(3) of this section, as appropriate, by the amount in dB that the directional gain of the antenna exceeds 6 dBi.

17.2. Result

The antenna used for this product is External antenna and that no antenna other than that furnished by the responsible party shall be used with the device, the maximum peak gain of the transmit antenna is 2.71 dBi

APPENDIX A – Radiated Emission Below 1GHz Test Data

Test Report

Project Information			
EUT:	IEEE 802.11b/g/n/a/ac/ax 2T2R USB WiFi Module Integrated BT 2.1+EDR/4.2/5.2		
Model:	SKI.WB920TU.2	Environment:	23°C 56%
Mode:	DH5_2402	Voltage:	DC3.3V
Customer:		Engineer:	Kennys Zhang
Remark:			

Start of Test: 2023-09-02 10:40:27

Test Graph

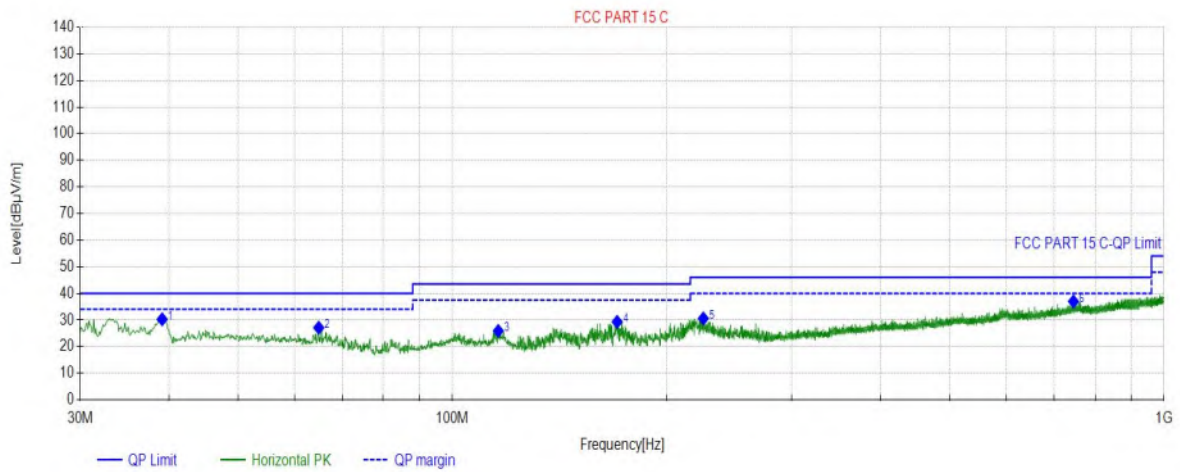

Final Data List								
NO.	Freq. (MHz)	Factor (dB)	QP Value (dBµV/m)	QP Limit (dBµV/m)	QP Margin (dB)	Height (cm)	Angle (°)	Polarity
1	39.1189	21.02	30.28	40.00	9.72	100	328	Horizontal
2	64.9235	19.80	27.11	40.00	12.89	100	27	Horizontal
3	116.0476	19.22	25.91	43.50	17.59	100	27	Horizontal
4	170.4700	17.95	29.30	43.50	14.20	100	272	Horizontal
5	225.2805	20.95	30.58	46.00	15.42	100	184	Horizontal
6	746.0286	32.33	36.98	46.00	9.02	100	194	Horizontal

Test Report

Project Information			
EUT:	IEEE 802.11b/g/n/a/ac/ax 2T2R USB WiFi Module Integrated BT 2.1+EDR/4.2/5.2		
Model:	SKI.WB920TU.2	Environment:	23°C 56%
Mode:	DH5_2402	Voltage:	DC12V
Customer:		Engineer:	Kennys Zhang
Remark:			

Start of Test: 2023-09-02 10:41:11

Test Graph

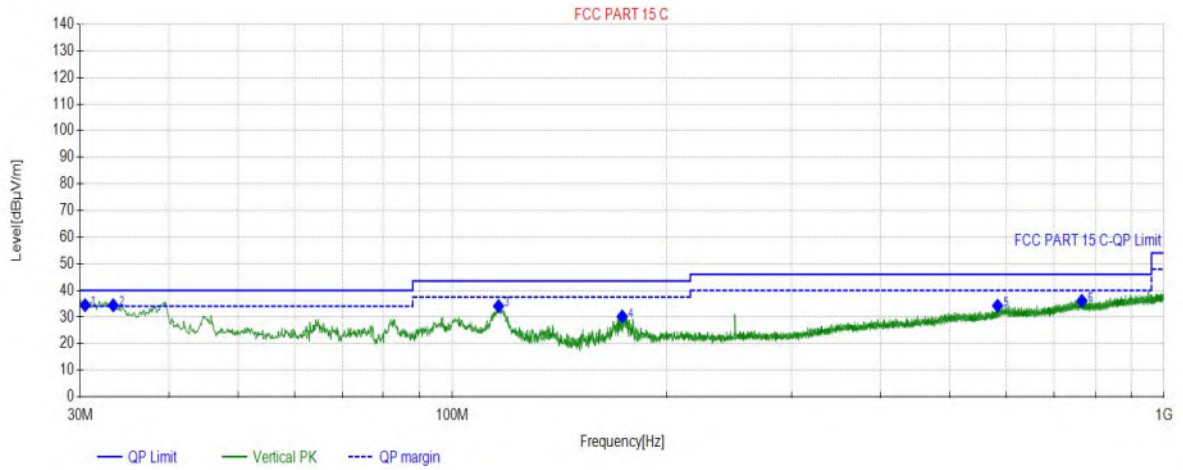

Final Data List								
NO.	Freq. (MHz)	Factor (dB)	QP Value (dBµV/m)	QP Limit (dBµV/m)	QP Margin (dB)	Height (cm)	Angle (°)	Polarity
1	30.4850	18.94	34.46	40.00	5.54	100	40	Vertical
2	33.3953	19.64	34.40	40.00	5.60	100	333	Vertical
3	116.1446	19.21	34.10	43.50	9.40	100	93	Vertical
4	173.2833	18.09	30.21	43.50	13.29	100	107	Vertical
5	583.6344	29.67	34.24	46.00	11.76	100	305	Vertical
6	766.4977	32.53	36.08	46.00	9.92	100	35	Vertical

APPENDIX B – Radiated Emission Above 1GHz Test Data

Test Report

Project Information			
EUT:	IEEE 802.11b/g/n/a/ac/ax 2T2R USB WiFi Module Integrated BT 2.1+EDR/4.2/5.2		
Model:	SKI.WB920TU.2	Environment:	23°C 56%
Mode:	DH5_2402	Voltage:	DC3.3V
Customer:		Engineer:	Kennys Zhang
Remark:	Power Set : 3		

Start of Test: 2023-09-04 09:22:27

Test Graph

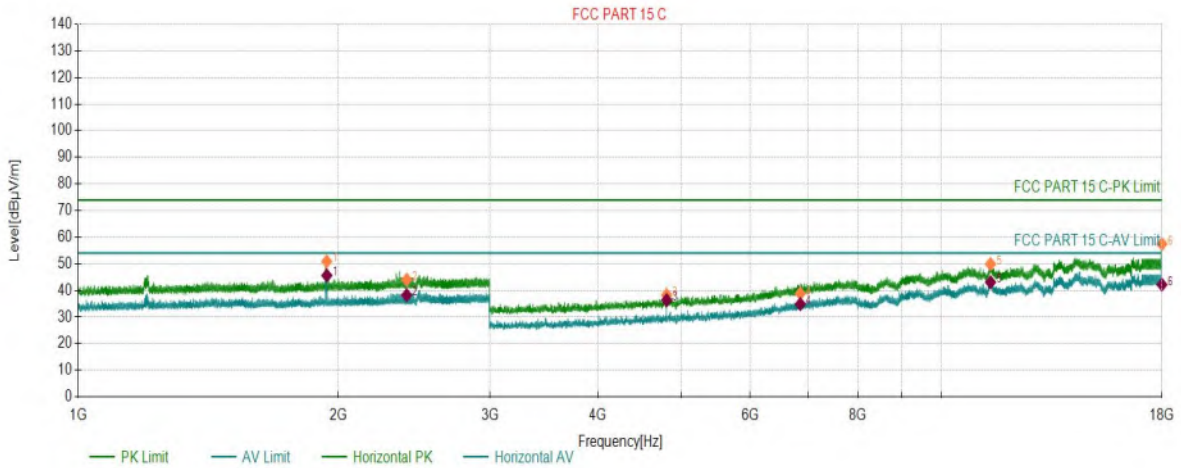

PK Final Data List								
NO.	Freq. (MHz)	Factor (dB)	PK Value (dBµV/m)	PK Limit (dBµV/m)	PK Margin (dB)	Height (cm)	Angle (°)	Polarity
1	1940.7470	4.67	50.89	74.00	23.11	150	16	Horizontal
2	2401.8701	7.11	44.02	74.00	29.98	150	23	Horizontal
3	4803.8402	-11.17	38.25	74.00	35.75	150	346	Horizontal
4	6860.4430	-3.89	38.83	74.00	35.17	150	132	Horizontal
5	11392.9196	7.05	49.90	74.00	24.10	150	65	Horizontal
6	17993.9997	21.96	57.44	74.00	16.56	150	328	Horizontal

AV Final Data List								
NO.	Freq. (MHz)	Factor (dB)	AV Value (dBµV/m)	AV Limit (dBµV/m)	AV Margin (dB)	Height (cm)	Angle (°)	Polarity
1	1940.7470	4.67	45.61	54.00	8.39	150	16	Horizontal
2	2401.8701	7.11	38.22	54.00	15.78	150	23	Horizontal
3	4803.8402	-11.17	36.36	54.00	17.64	150	346	Horizontal
4	6860.4430	-3.89	34.83	54.00	19.17	150	132	Horizontal
5	11392.9196	7.05	43.07	54.00	10.93	150	65	Horizontal
6	17993.9997	21.96	42.17	54.00	11.83	150	328	Horizontal

Test Report

Project Information			
EUT:	IEEE 802.11b/g/n/a/ac/ax 2T2R USB WiFi Module Integrated BT 2.1+EDR/4.2/5.2		
Model:	SKI.WB920TU.2	Environment:	23°C 56%
Mode:	DH5_2402	Voltage:	DC3.3V
Customer:		Engineer:	Kennys Zhang
Remark:	Power Set : 3		

Start of Test: 2023-09-04 09:24:09

Test Graph

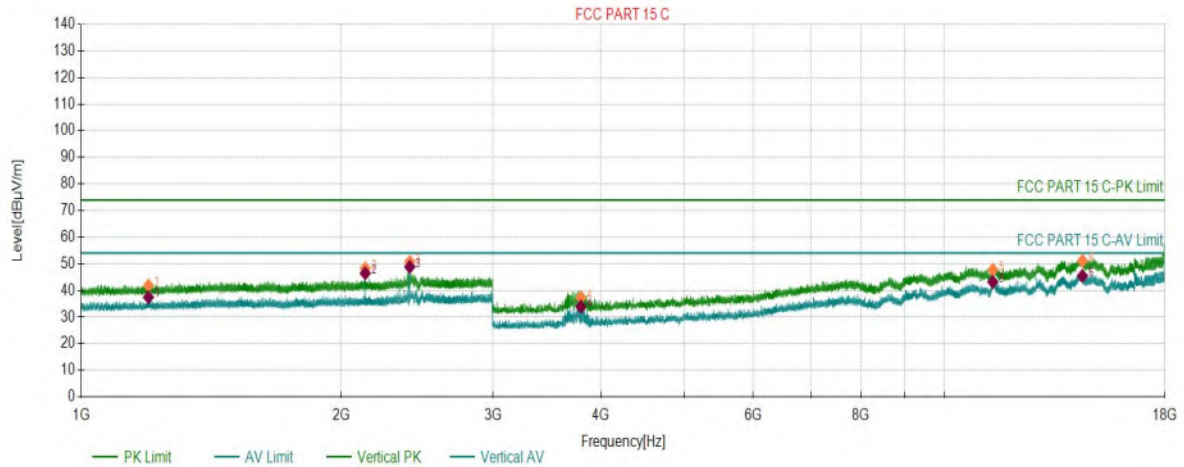

PK Final Data List

NO.	Freq. (MHz)	Factor (dB)	PK Value (dBµV/m)	PK Limit (dBµV/m)	PK Margin (dB)	Height (cm)	Angle (°)	Polarity
1	1196.7098	1.33	41.83	74.00	32.17	150	168	Vertical
2	2133.3567	5.33	48.32	74.00	25.68	150	76	Vertical
3	2402.0701	7.11	50.76	74.00	23.24	150	288	Vertical
4	3791.2896	-15.06	37.34	74.00	36.66	150	114	Vertical
5	11372.6686	6.75	47.72	74.00	26.28	150	336	Vertical
6	14444.0722	13.08	51.12	74.00	22.88	150	301	Vertical

AV Final Data List

NO.	Freq. (MHz)	Factor (dB)	AV Value (dBµV/m)	AV Limit (dBµV/m)	AV Margin (dB)	Height (cm)	Angle (°)	Polarity
1	1196.7098	1.33	37.45	54.00	16.55	150	168	Vertical
2	2133.3567	5.33	46.42	54.00	7.58	150	76	Vertical
3	2402.0701	7.11	48.84	54.00	5.16	150	288	Vertical
4	3791.2896	-15.06	33.88	54.00	20.12	150	114	Vertical
5	11372.6686	6.75	43.23	54.00	10.77	150	336	Vertical
6	14444.0722	13.08	45.47	54.00	8.53	150	301	Vertical

Test Report

Project Information			
EUT:	IEEE 802.11b/g/n/a/ac/ax 2T2R USB WiFi Module Integrated BT 2.1+EDR/4.2/5.2		
Model:	SKI.WB920TU.2	Environment:	23°C 56%
Mode:	DH5_2480	Voltage:	DC3.3V
Customer:		Engineer:	Kennys Zhang
Remark:	Power Set : 3		

Start of Test: 2023-09-04 09:32:59

Test Graph

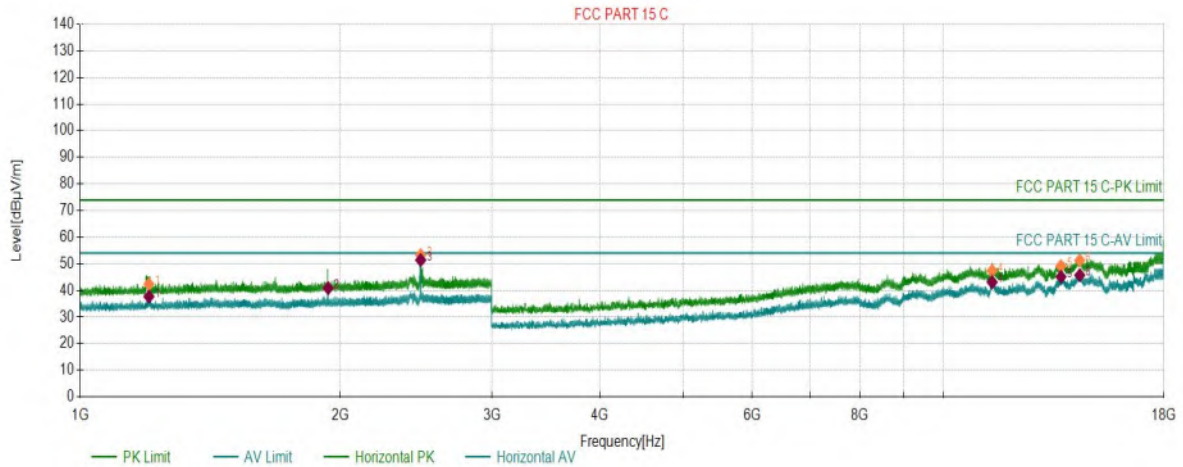

PK Final Data List

NO.	Freq. (MHz)	Factor (dB)	PK Value (dBµV/m)	PK Limit (dBµV/m)	PK Margin (dB)	Height (cm)	Angle (°)	Polarity
1	1201.4101	1.37	42.30	74.00	31.70	150	304	Horizontal
2	1937.3469	4.66	40.90	74.00	33.10	150	237	Horizontal
3	2480.1740	7.43	53.26	74.00	20.74	150	35	Horizontal
4	11382.4191	6.89	47.40	74.00	26.60	150	202	Horizontal
5	13673.7837	11.15	49.18	74.00	24.82	150	87	Horizontal
6	14378.0689	12.93	51.31	74.00	22.69	150	168	Horizontal

AV Final Data List

NO.	Freq. (MHz)	Factor (dB)	AV Value (dBµV/m)	AV Limit (dBµV/m)	AV Margin (dB)	Height (cm)	Angle (°)	Polarity
1	1201.4101	1.37	37.68	54.00	16.32	150	304	Horizontal
2	1937.3469	4.66	40.89	54.00	13.11	150	237	Horizontal
3	2480.1740	7.43	51.40	54.00	2.60	150	35	Horizontal
4	11382.4191	6.89	43.12	54.00	10.88	150	202	Horizontal
5	13673.7837	11.15	45.10	54.00	8.90	150	87	Horizontal
6	14378.0689	12.93	45.73	54.00	8.27	150	168	Horizontal

Test Report

Project Information			
EUT:	IEEE 802.11b/g/n/a/ac/ax 2T2R USB WiFi Module Integrated BT 2.1+EDR/4.2/5.2		
Model:	SKI.WB920TU.2	Environment:	23°C 56%
Mode:	DH5_2480	Voltage:	DC3.3V
Customer:		Engineer:	Kennys Zhang
Remark:	Power Set : 3		

Start of Test: 2023-09-04 09:34:49

Test Graph

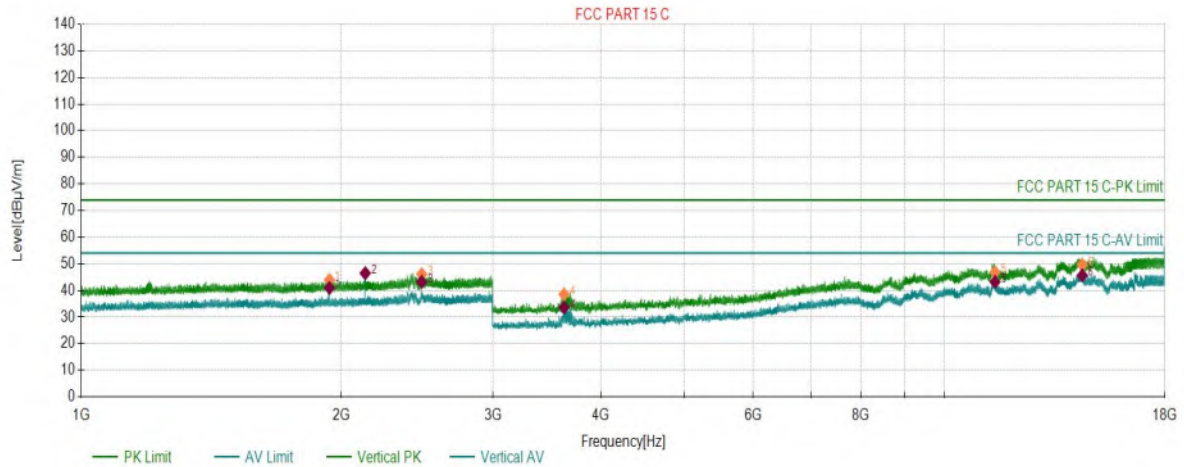

PK Final Data List

NO.	Freq. (MHz)	Factor (dB)	PK Value (dBµV/m)	PK Limit (dBµV/m)	PK Margin (dB)	Height (cm)	Angle (°)	Polarity
1	1938.9469	4.66	43.91	74.00	30.09	150	163	Vertical
2	2133.4567	5.33	46.47	74.00	27.53	150	87	Vertical
3	2480.0740	7.43	46.05	74.00	27.95	150	212	Vertical
4	3624.7812	-15.80	38.52	74.00	35.48	150	98	Vertical
5	11439.4220	6.88	46.83	74.00	27.17	150	320	Vertical
6	14434.3217	13.06	49.60	74.00	24.40	150	81	Vertical

AV Final Data List

NO.	Freq. (MHz)	Factor (dB)	AV Value (dBµV/m)	AV Limit (dBµV/m)	AV Margin (dB)	Height (cm)	Angle (°)	Polarity
1	1938.9469	4.66	40.92	54.00	13.08	150	163	Vertical
2	2133.4567	5.33	46.45	54.00	7.55	150	87	Vertical
3	2480.0740	7.43	43.22	54.00	10.78	150	212	Vertical
4	3624.7812	-15.80	33.59	54.00	20.41	150	98	Vertical
5	11439.4220	6.88	43.21	54.00	10.79	150	320	Vertical
6	14434.3217	13.06	45.65	54.00	8.35	150	81	Vertical

Test Report

Project Information			
EUT:	IEEE 802.11b/g/n/a/ac/ax 2T2R USB WiFi Module Integrated BT 2.1+EDR/4.2/5.2		
Model:	SKI.WB920TU.2	Environment:	23°C 56%
Mode:	DH5_2441	Voltage:	DC3.3V
Customer:		Engineer:	Kennys Zhang
Remark:	Power Set : 3		

Start of Test: 2023-09-04 09:39:52

Test Graph

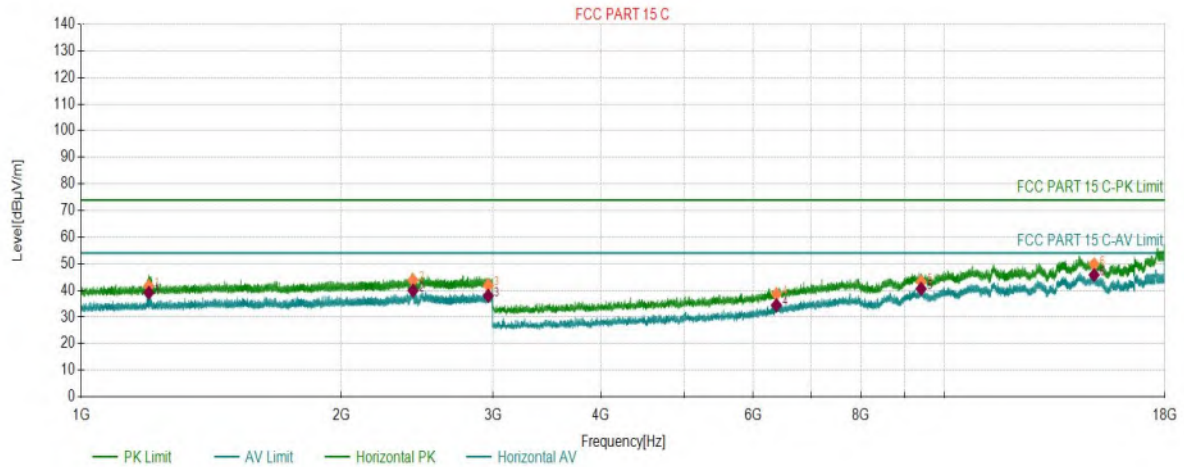

PK Final Data List

NO.	Freq. (MHz)	Factor (dB)	PK Value (dBμV/m)	PK Limit (dBμV/m)	PK Margin (dB)	Height (cm)	Angle (°)	Polarity
1	1197.7099	1.34	41.64	74.00	32.36	150	325	Horizontal
2	2423.2712	7.20	43.83	74.00	30.17	150	140	Horizontal
3	2961.4981	7.78	41.87	74.00	32.13	150	3	Horizontal
4	6385.6693	-5.67	38.65	74.00	35.35	150	107	Horizontal
5	9393.3197	3.81	43.25	74.00	30.75	150	69	Horizontal
6	14898.5949	12.97	49.84	74.00	24.16	150	192	Horizontal

AV Final Data List

NO.	Freq. (MHz)	Factor (dB)	AV Value (dBμV/m)	AV Limit (dBμV/m)	AV Margin (dB)	Height (cm)	Angle (°)	Polarity
1	1197.7099	1.34	39.11	54.00	14.89	150	325	Horizontal
2	2423.2712	7.20	39.95	54.00	14.05	150	140	Horizontal
3	2961.4981	7.78	37.98	54.00	16.02	150	3	Horizontal
4	6385.6693	-5.67	34.43	54.00	19.57	150	107	Horizontal
5	9393.3197	3.81	40.59	54.00	13.41	150	69	Horizontal
6	14898.5949	12.97	45.81	54.00	8.19	150	192	Horizontal

Test Report

Project Information			
EUT:	IEEE 802.11b/g/n/a/ac/ax 2T2R USB WiFi Module Integrated BT 2.1+EDR/4.2/5.2		
Model:	SKI.WB920TU.2	Environment:	23°C 56%
Mode:	DH5_2441	Voltage:	DC3.3V
Customer:		Engineer:	Kennys Zhang
Remark:	Power Set : 3		

Start of Test: 2023-09-04 09:41:41

Test Graph

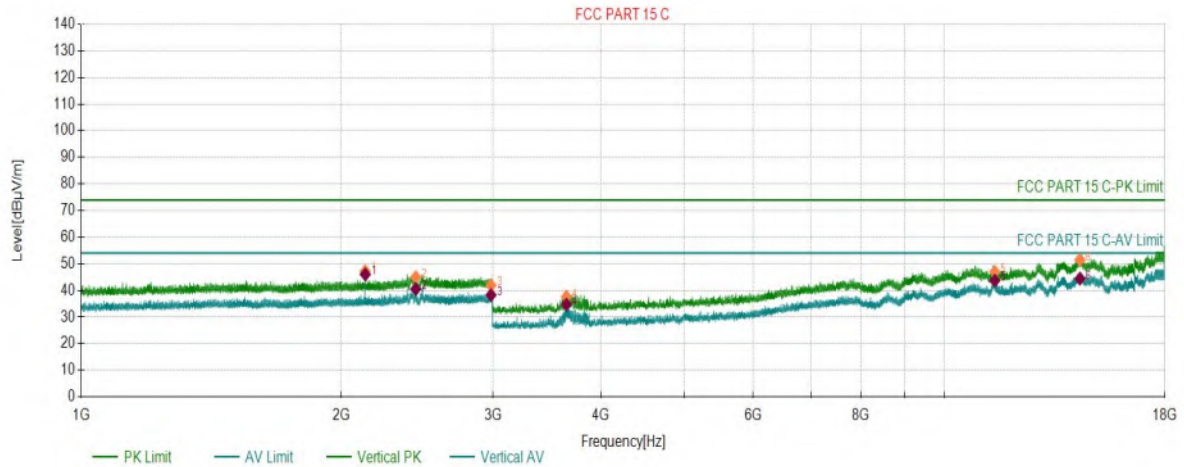

PK Final Data List

NO.	Freq. (MHz)	Factor (dB)	PK Value (dBµV/m)	PK Limit (dBµV/m)	PK Margin (dB)	Height (cm)	Angle (°)	Polarity
1	2133.4567	5.33	47.17	74.00	26.83	150	75	Vertical
2	2440.6720	7.27	44.95	74.00	29.05	150	34	Vertical
3	2983.1992	7.82	41.91	74.00	32.09	150	207	Vertical
4	3647.2824	-15.65	37.55	74.00	36.45	150	99	Vertical
5	11433.4217	6.92	46.99	74.00	27.01	150	286	Vertical
6	14344.3172	12.80	51.45	74.00	22.55	150	116	Vertical

AV Final Data List

NO.	Freq. (MHz)	Factor (dB)	AV Value (dBµV/m)	AV Limit (dBµV/m)	AV Margin (dB)	Height (cm)	Angle (°)	Polarity
1	2133.4567	5.33	46.01	54.00	7.99	150	75	Vertical
2	2440.6720	7.27	40.51	54.00	13.49	150	34	Vertical
3	2983.1992	7.82	38.26	54.00	15.74	150	207	Vertical
4	3647.2824	-15.65	34.69	54.00	19.31	150	99	Vertical
5	11433.4217	6.92	43.70	54.00	10.30	150	286	Vertical
6	14344.3172	12.80	44.43	54.00	9.57	150	116	Vertical

Restriction Band Emission

Test Report

Project Information			
EUT:	IEEE 802.11b/g/n/a/ac/ax 2T2R USB WiFi Module Integrated BT 2.1+EDR/4.2/5.2		
Model:	SKI.WB920TU.2	Environment:	23°C 56%
Mode:	DH5_2402	Voltage:	DC3.3V
Customer:		Engineer:	Kennys Zhang
Remark:	Power Set : Ant1 +Ant2 10		

Start of Test: 2023-09-04 09:13:24

Test Graph

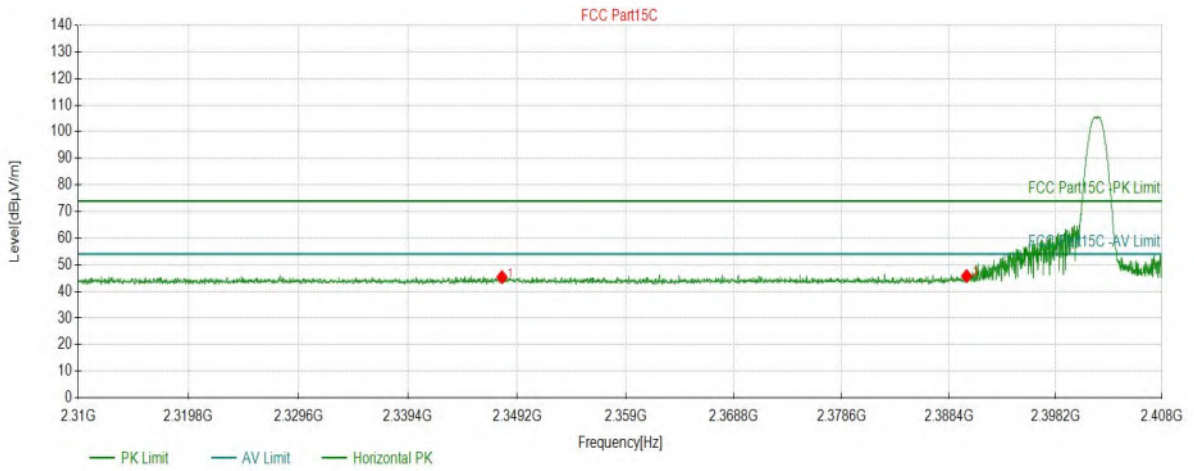

Suspected Data List

NO.	Freq. (MHz)	Level (dBµV/m)	Factor (dB)	Limit (dBµV/m)	Margin (dB)	Height (cm)	Angle (°)	Detector	Polarity
1	2347.8406	45.35	5.56	74.00	28.65	150	271	PK	Horizont
2	2390.0273	45.78	5.61	74.00	28.22	150	15	PK	Horizont

Test Report

Project Information			
EUT:	IEEE 802.11b/g/n/a/ac/ax 2T2R USB WiFi Module Integrated BT 2.1+EDR/4.2/5.2		
Model:	SKI.WB920TU.2	Environment:	23°C 56%
Mode:	DH5_2402	Voltage:	DC3.3V
Customer:		Engineer:	Kennys Zhang
Remark:	Power Set : 3		

Start of Test: 2023-09-04 09:16:21

Test Graph

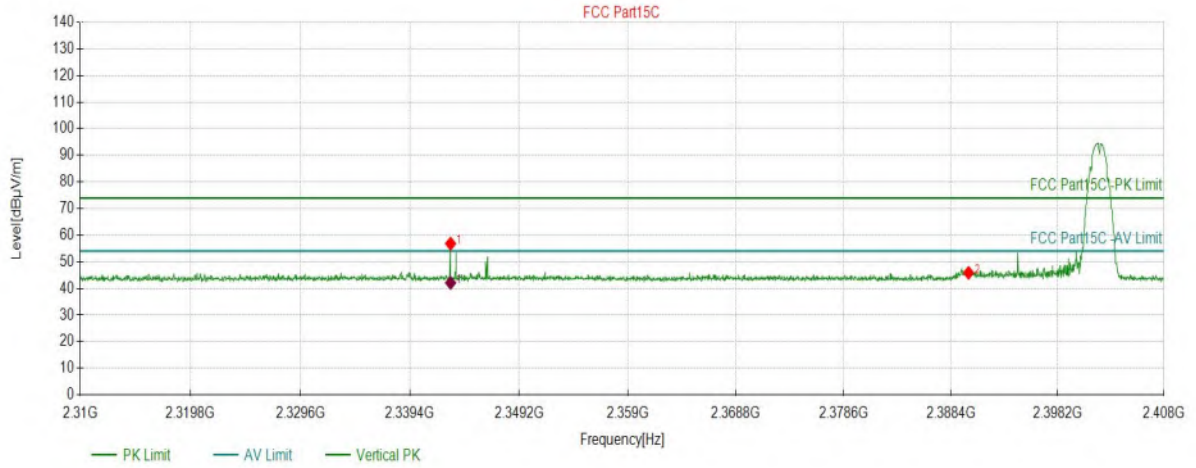

Suspected Data List

NO.	Freq. (MHz)	Level (dBµV/m)	Factor (dB)	Limit (dBµV/m)	Margin (dB)	Height (cm)	Angle (°)	Detector	Polarity
1	2343.0370	56.83	5.55	74.00	17.17	150	355	PK	Vertical
2	2390.0273	45.85	5.61	74.00	28.15	150	81	PK	Vertical

AV Final Data List

NO.	Freq. (MHz)	Factor (dB)	AV Value (dBµV/m)	AV Limit (dBµV/m)	AV Margin (dB)	Height (cm)	Angle (°)	Polarity
1	2343.0372	5.55	42.07	54.00	11.93	190.5	130.8	Vertical

Test Report

Project Information			
EUT:	IEEE 802.11b/g/n/a/ac/ax 2T2R USB WiFi Module Integrated BT 2.1+EDR/4.2/5.2		
Model:	SKI.WB920TU.2	Environment:	23°C 56%
Mode:	DH5_2480	Voltage:	DC3.3V
Customer:		Engineer:	Kennys Zhang
Remark:	Power Set : 3		

Start of Test: 2023-09-04 09:29:42

Test Graph

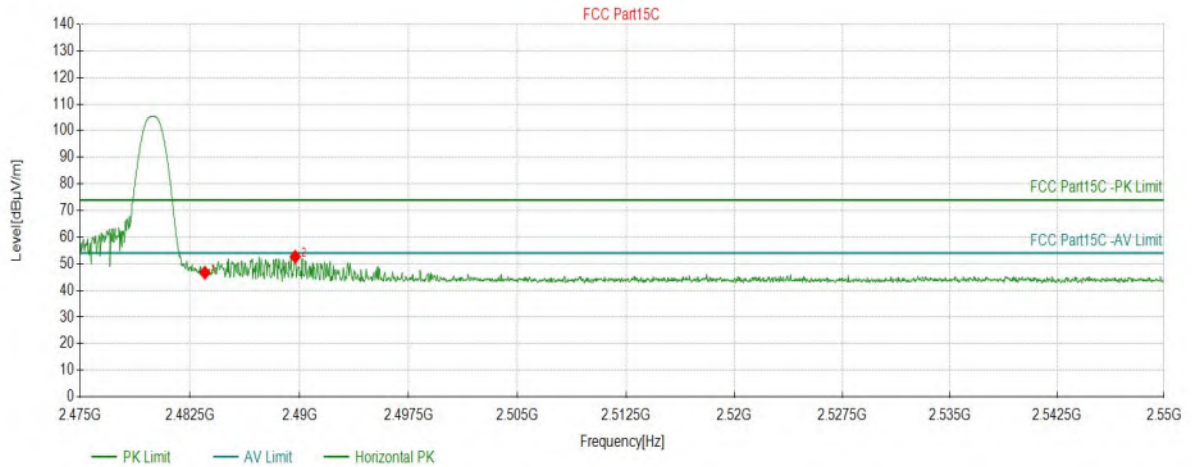

Suspected Data List

NO.	Freq. (MHz)	Level (dBµV/m)	Factor (dB)	Limit (dBµV/m)	Margin (dB)	Height (cm)	Angle (°)	Detector	Polarity
1	2483.5168	46.64	6.07	74.00	27.36	150	15	PK	Horizont
2	2489.7074	52.66	6.10	74.00	21.34	150	31	PK	Horizont

Test Report

Project Information			
EUT:	IEEE 802.11b/g/n/a/ac/ax 2T2R USB WiFi Module Integrated BT 2.1+EDR/4.2/5.2		
Model:	SKI.WB920TU.2	Environment:	23°C 56%
Mode:	DH5_2480	Voltage:	DC3.3V
Customer:		Engineer:	Kennys Zhang
Remark:	Power Set : 3		

Start of Test: 2023-09-04 09:30:34

Test Graph

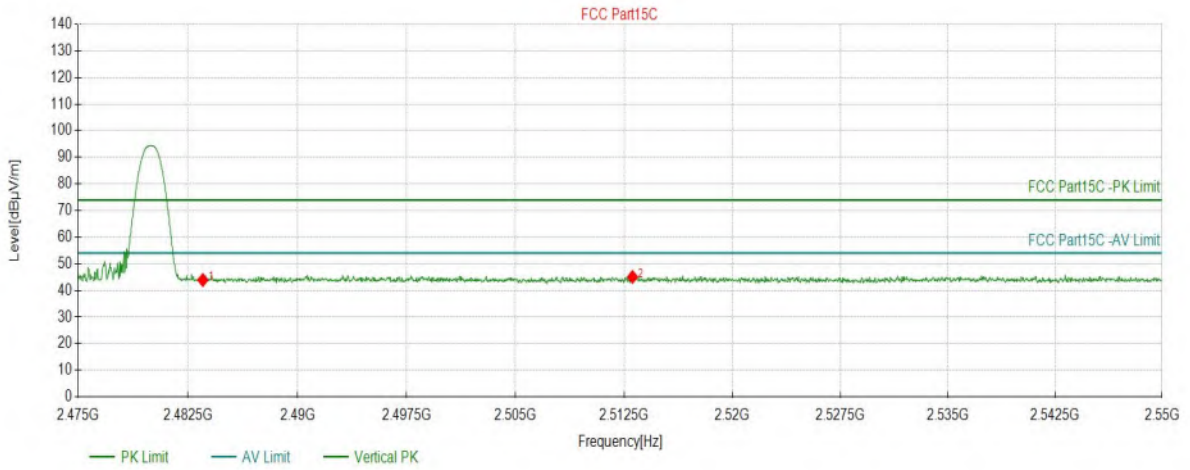

Suspected Data List

NO.	Freq. (MHz)	Level (dBµV/m)	Factor (dB)	Limit (dBµV/m)	Margin (dB)	Height (cm)	Angle (°)	Detector	Polarity
1	2483.5168	43.91	6.07	74.00	30.09	150	127	PK	Vertical
2	2513.0815	45.05	6.17	74.00	28.95	150	2	PK	Vertical

Test Report

Project Information			
EUT:	IEEE 802.11b/g/n/a/ac/ax 2T2R USB WiFi Module Integrated BT 2.1+EDR/4.2/5.2		
Model:	SKI.WB920TU.2	Environment:	23°C 56%
Mode:	2DH5_2402	Voltage:	DC3.3V
Customer:		Engineer:	Kennys Zhang
Remark:	Power Set : 3		

Start of Test: 2023-09-04 09:44:30

Test Graph

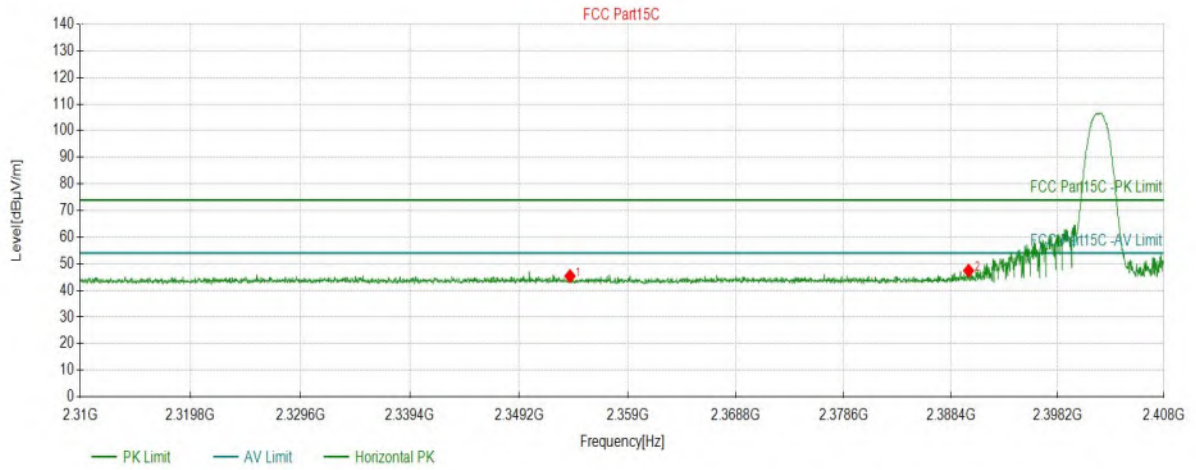

Suspected Data List

NO.	Freq. (MHz)	Level (dBµV/m)	Factor (dB)	Limit (dBµV/m)	Margin (dB)	Height (cm)	Angle (°)	Detector	Polarity
1	2353.7879	45.36	5.56	74.00	28.64	150	144	PK	Horizont
2	2390.0273	47.42	5.61	74.00	26.58	150	219	PK	Horizont

Test Report

Project Information			
EUT:	IEEE 802.11b/g/n/a/ac/ax 2T2R USB WiFi Module Integrated BT 2.1+EDR/4.2/5.2		
Model:	SKI.WB920TU.2	Environment:	23°C 56%
Mode:	2DH5_2402	Voltage:	DC3.3V
Customer:		Engineer:	Kennys Zhang
Remark:	Power Set : 3		

Start of Test: 2023-09-04 09:45:15

Test Graph

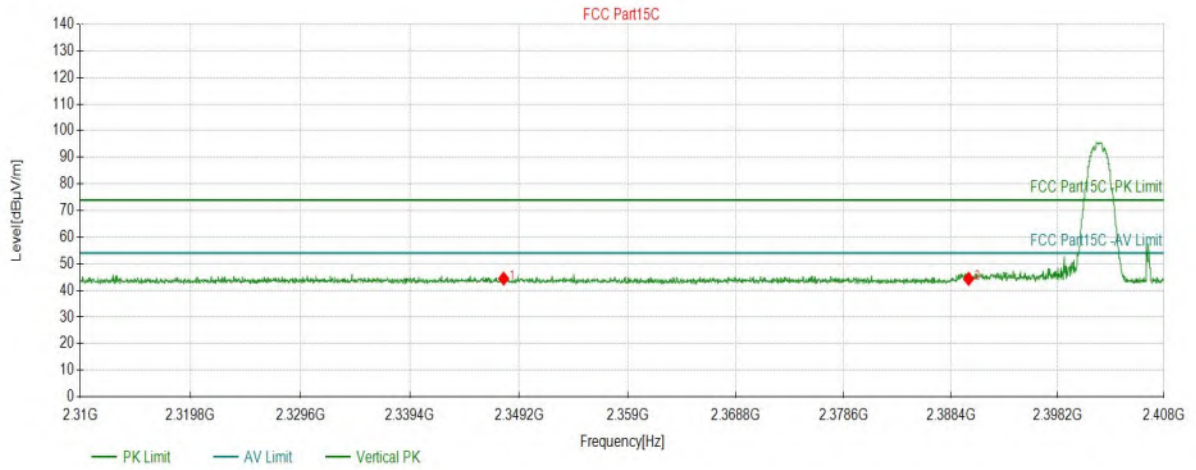

Suspected Data List

NO.	Freq. (MHz)	Level (dBµV/m)	Factor (dB)	Limit (dBµV/m)	Margin (dB)	Height (cm)	Angle (°)	Detector	Polarity
1	2347.8079	44.43	5.56	74.00	29.57	150	274	PK	Vertical
2	2390.0273	44.33	5.61	74.00	29.67	150	113	PK	Vertical

Test Report

Project Information			
EUT:	IEEE 802.11b/g/n/a/ac/ax 2T2R USB WiFi Module Integrated BT 2.1+EDR/4.2/5.2		
Model:	SKI.WB920TU.2	Environment:	23°C 56%
Mode:	2DH5_2480	Voltage:	DC3.3V
Customer:		Engineer:	Kennys Zhang
Remark:	Power Set : 3		

Start of Test: 2023-09-04 09:47:14

Test Graph

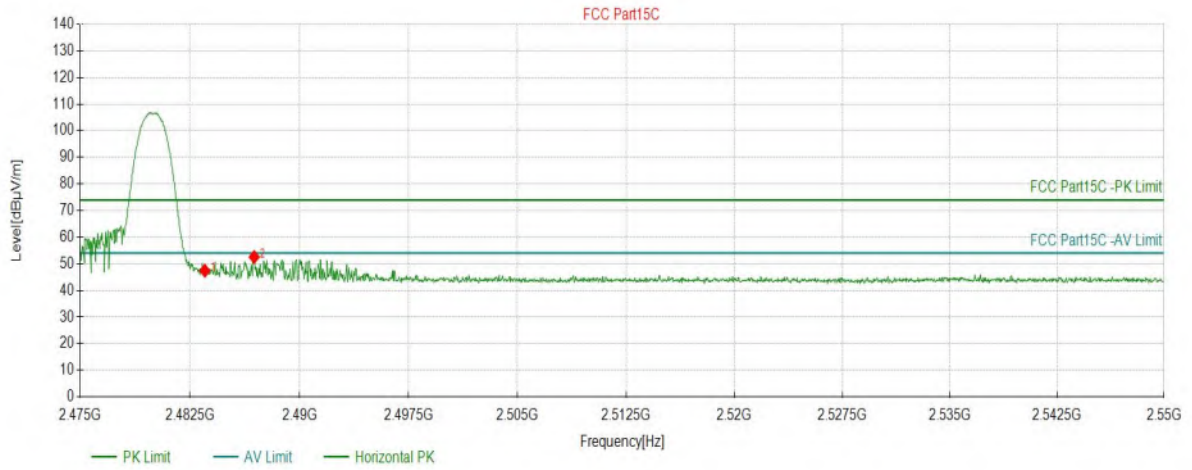

Suspected Data List

NO.	Freq. (MHz)	Level (dBµV/m)	Factor (dB)	Limit (dBµV/m)	Margin (dB)	Height (cm)	Angle (°)	Detector	Polarity
1	2483.5168	47.40	6.07	74.00	26.60	150	22	PK	Horizont
2	2486.8934	52.55	6.09	74.00	21.45	150	10	PK	Horizont

Test Report

Project Information			
EUT:	IEEE 802.11b/g/n/a/ac/ax 2T2R USB WiFi Module Integrated BT 2.1+EDR/4.2/5.2		
Model:	SKI.WB920TU.2	Environment:	23°C 56%
Mode:	2DH5_2480	Voltage:	DC3.3V
Customer:		Engineer:	Kennys Zhang
Remark:	Power Set : 3		

Start of Test: 2023-09-04 09:48:06

Test Graph

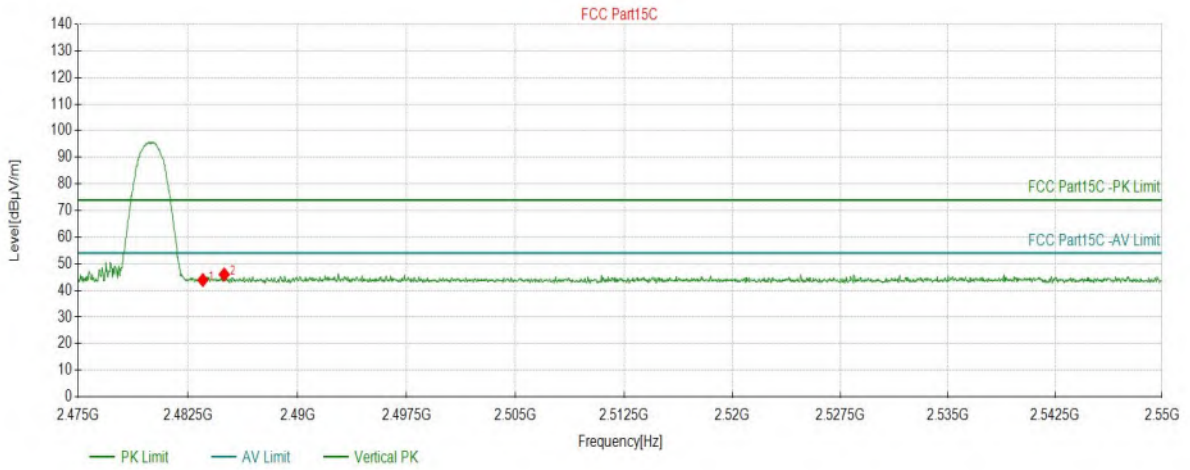

Suspected Data List									
NO.	Freq. (MHz)	Level (dBµV/m)	Factor (dB)	Limit (dBµV/m)	Margin (dB)	Height (cm)	Angle (°)	Detector	Polarity
1	2483.5168	43.90	6.07	74.00	30.10	150	318	PK	Vertical
2	2484.9800	45.97	6.08	74.00	28.03	150	102	PK	Vertical

Test Report

Project Information			
EUT:	IEEE 802.11b/g/n/a/ac/ax 2T2R USB WiFi Module Integrated BT 2.1+EDR/4.2/5.2		
Model:	SKI.WB920TU.2	Environment:	23°C 56%
Mode:	3DH5_2402	Voltage:	DC3.3V
Customer:		Engineer:	Kennys Zhang
Remark:	Power Set : 3		

Start of Test: 2023-09-04 09:51:44

Test Graph

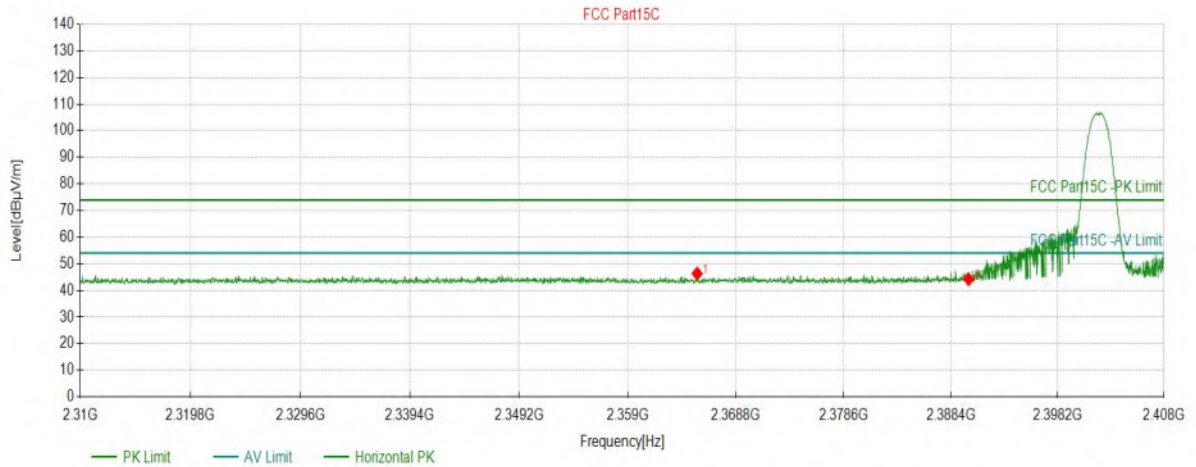

Suspected Data List

NO.	Freq. (MHz)	Level (dBµV/m)	Factor (dB)	Limit (dBµV/m)	Margin (dB)	Height (cm)	Angle (°)	Detector	Polarity
1	2365.2904	46.31	5.58	74.00	27.69	150	26	PK	Horizont
2	2390.0273	44.20	5.61	74.00	29.80	150	211	PK	Horizont

Test Report

Project Information			
EUT:	IEEE 802.11b/g/n/a/ac/ax 2T2R USB WiFi Module Integrated BT 2.1+EDR/4.2/5.2		
Model:	SKI.WB920TU.2	Environment:	23°C 56%
Mode:	3DH5_2402	Voltage:	DC3.3V
Customer:		Engineer:	Kennys Zhang
Remark:	Power Set : 3		

Start of Test: 2023-09-04 09:52:28

Test Graph

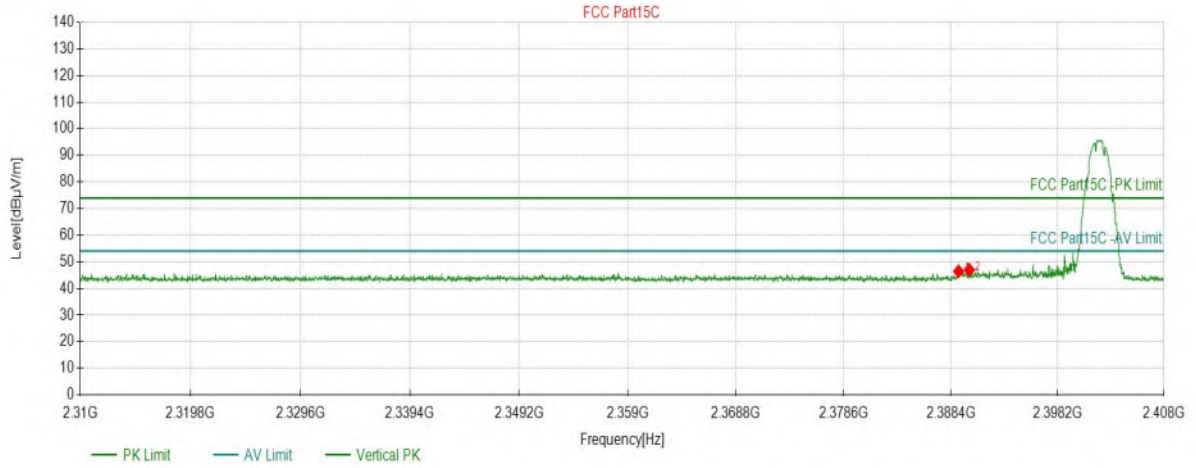

Suspected Data List

NO.	Freq. (MHz)	Level (dBµV/m)	Factor (dB)	Limit (dBµV/m)	Margin (dB)	Height (cm)	Angle (°)	Detector	Polarity
1	2389.1124	46.40	5.61	74.00	27.60	150	130	PK	Vertical
2	2390.0927	46.98	5.61	74.00	27.02	150	130	PK	Vertical

Test Report

Project Information			
EUT:	IEEE 802.11b/g/n/a/ac/ax 2T2R USB WiFi Module Integrated BT 2.1+EDR/4.2/5.2		
Model:	SKI.WB920TU.2	Environment:	23°C 56%
Mode:	3DH5_2480	Voltage:	DC3.3V
Customer:		Engineer:	Kennys Zhang
Remark:	Power Set : 3		

Start of Test: 2023-09-04 09:54:40

Test Graph

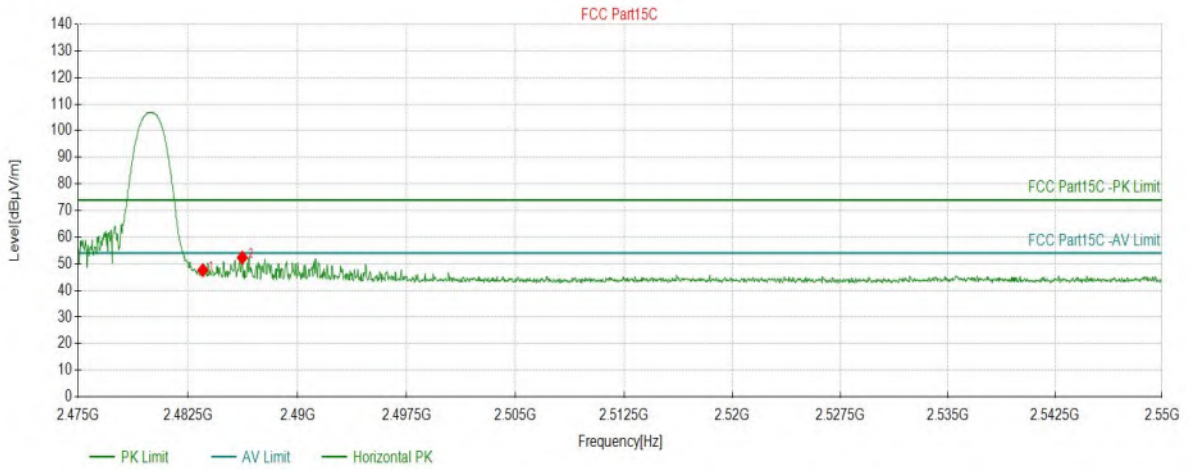

Suspected Data List

NO.	Freq. (MHz)	Level (dBµV/m)	Factor (dB)	Limit (dBµV/m)	Margin (dB)	Height (cm)	Angle (°)	Detector	Polarity
1	2483.5168	47.62	6.07	74.00	26.38	150	11	PK	Horizont
2	2486.2181	52.31	6.09	74.00	21.69	150	33	PK	Horizont

Test Report

Project Information			
EUT:	IEEE 802.11b/g/n/a/ac/ax 2T2R USB WiFi Module Integrated BT 2.1+EDR/4.2/5.2		
Model:	SKI.WB920TU.2	Environment:	23°C 56%
Mode:	3DH5_2480	Voltage:	DC3.3V
Customer:		Engineer:	Kennys Zhang
Remark:	Power Set : 3		

Start of Test: 2023-09-04 09:55:33

Test Graph

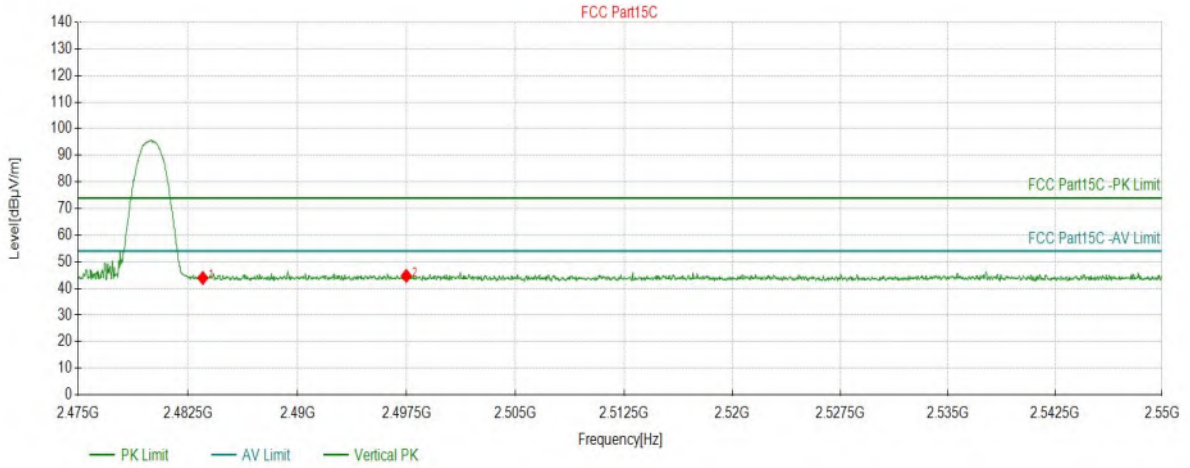

Suspected Data List

NO.	Freq. (MHz)	Level (dBµV/m)	Factor (dB)	Limit (dBµV/m)	Margin (dB)	Height (cm)	Angle (°)	Detector	Polarity
1	2483.5168	43.91	6.07	74.00	30.09	150	343	PK	Vertical
2	2497.4737	44.71	6.15	74.00	29.29	150	360	PK	Vertical

END OF REPORT