



FCC AND ISCED CERTIFICATION TEST REPORT

Applicant:	Guangzhou Shikun Electronics Co., Ltd
Address:	NO.6 Liankun Road, Huangpu District, Guangzhou, China
Manufacturer:	Guangzhou Shikun Electronics Co., Ltd
Address:	NO.6 Liankun Road, Huangpu District, Guangzhou, China
Product Description:	IEEE802.11a/b/g/n/ac 2T2R USB Wi-Fi Module Integrated Bluetooth 2.1/3.0/4.2/5.0
Brand Name:	NA
Tested Model:	SKI.WB822CU.2
FCC ID:	2AR82-SKIWB822CU2
IC:	24728-SKIWB822CU2
Report No.:	JCF240223021-002
Received Date:	Feb. 23, 2024
Tested Date:	Feb. 23, 2024 ~ Mar. 22, 2024
Issued Date:	Mar. 22, 2024
Test Standards:	FCC Rules and Regulations Part 15 Subpart C, RSS-247 Issue 3 August 2023
Test Procedure:	ANSI C63.10:2013, RSS-Gen Issue 5 A2, Feb. 2021
Test Result:	Pass
Prepared By:	
 <u>Roger Li/Engineer</u>	
Date: Mar. 22, 2024 	
Reviewed By:	
 <u>Kennys Zhang/Engineer</u>	
Date: Mar. 22, 2024 	
Approved By:	
 <u>Talent Zhang/Engineer</u>	
Date: Mar. 22, 2024 	

Note: The test results in this report apply exclusively to the tested model / sample. Without written approval of Guangzhou Jingce Testing Technology Co., Ltd. the test report shall not be reproduced except in full.

Report Revise Record

Report Version	Revise Time	Issued Date	Valid Version	Notes
V1.0	/	Mar. 22, 2024	Original Report	/

Table of Contents

1. Test Report Declare	4
2. Summary of Test Results	5
3. Test Laboratory	5
4. Equipment Under Test	6
4.1. Description of EUT	6
4.2. Channel List	6
4.3. Test Channel Configuration	6
4.4. Test environment conditions	7
4.5. The Worse Case Power Setting Parameter	7
4.6. Description of Available Antennas	7
5. Description of Test Setup	7
5.1. Accessory	7
5.2. Support Equipment	7
5.3. Test Setup	7
5.4. Setup Diagram for Tests	7
6. Measurement Uncertainty	8
7. Measuring Instrument and Software Used	8
8. Peak Conducted Output Power	10
8.1. Block diagram of test setup	10
8.2. Limits	10
8.3. Test Procedure	10
8.4. Results	10
9. Radiated Emission	11
9.1. Block diagram of test setup	11
9.2. Limit	12
9.3. Test Procedure	13
9.4. Results	15
9.5. Original test data	15
10. Antenna Requirements	16
10.1. Limits	16
10.2. Result	16
APPENDIX A – Radiated Emission Below 1GHz Test Data	17
APPENDIX B – Radiated Emission Above 1GHz Test Data	19

1. Test Report Declare

Applicant:	Guangzhou Shikun Electronics Co., Ltd
Address:	NO.6 Liankun Road, Huangpu District, Guangzhou, China
Manufacturer:	Guangzhou Shikun Electronics Co., Ltd
Address:	NO.6 Liankun Road, Huangpu District, Guangzhou, China
Product Name:	IEEE802.11a/b/g/n/ac 2T2R USB Wi-Fi Module Integrated Bluetooth 2.1/3.0/4.2/5.0
Brand Name:	NA
Model Name:	SKI.WB822CU.2
Difference Description:	NA

We Declare:

The equipment described above is tested by Guangzhou Jingce Testing Technology Co., Ltd. and in the configuration tested the equipment complied with the standards specified above. The test results are contained in this test report and Guangzhou Jingce Testing Technology Co., Ltd. is assumed of full responsibility for the accuracy and completeness of these tests except as provided information by clients.

2. Summary of Test Results

Summary of Test Results			
Clause	Test Items	FCC/ISED Rules	Test Results
1	6 dB Bandwidth and 99 % Occupied Bandwidth	FCC Part 15.247 (a) (2) RSS-247 Clause 5.2 (a) ISED RSS-Gen Clause 6.7	NA
2	Peak Conducted Output Power	FCC Part 15.247 (b) (3) RSS-247 Clause 5.4 (d)	Pass
3	Power Spectral Density	FCC Part 15.247 (e) RSS-247 Clause 5.2 (b)	NA
4	Conducted Bandedge and Spurious Emission	FCC Part 15.247 (d) RSS-247 Clause 5.5	NA
5	Radiated Bandedge and Spurious Emission	FCC Part 15.247 (d) FCC Part 15.209 FCC Part 15.205 RSS-247 Clause 5.5 RSS-GEN Clause 8.9	Pass
6	Conducted Emission Test For AC Power Port	FCC Part 15.207 RSS-GEN Clause 8.8	NA
7	Antenna Requirement	FCC Part 15.203 RSS-GEN Clause 6.8	Pass

Note: The EUT has only added antenna to the original report. So above test items except clause 2&5&7 need to be retest, the other test items reference report "ESTE-R2112273 " and "ESTE-R2112279"

3. Test Laboratory

Guangzhou Jingce Testing Technology Co., Ltd.

Add.: No.10, Hefeng No.1 street, Huangpu District, Guangzhou, Guangdong, People's Republic of China

Association for Laboratory Accreditation(A2LA). Certificate Number: 6594.03

FCC Designation Number: CN1381. Test Firm Registration Number: 486550

IC Test Firm Registration Number: 31808

Conformity Assessment Body identifier: CN0173

4. Equipment Under Test

4.1. Description of EUT

EUT Name:	IEEE802.11a/b/g/n/ac 2T2R USB Wi-Fi Module Integrated Bluetooth 2.1/3.0/4.2/5.0
Model Number:	SKI.WB822CU.2
EUT Function Description:	Please refer to usual manual
Power Supply:	DC 3.3V+/-0.3
Hardware Version:	NA
Software Version:	NA
Radio Specification:	Bluetooth V5.0
Operation Frequency:	2402 MHz - 2480 MHz
Modulation:	GFSK
Data Rate:	1Mbps, 2Mbps,
Antenna Type:	Shrapnel Antenna, MAX. Gain: 3.32 dBi

Note 1: EUT is the ab. of equipment under test.

Note 2: The antenna gain is declared by the customer and the laboratory is not responsible for the accuracy of the antenna gain.

4.2. Channel List

Channel	Frequency (MHz)	Channel	Frequency (MHz)	Channel	Frequency (MHz)	Channel	Frequency (MHz)
0	2402	11	2424	22	2446	33	2468
1	2404	12	2426	23	2448	34	2470
2	2406	13	2428	24	2450	35	2472
3	2408	14	2430	25	2452	36	2474
4	2410	15	2432	26	2454	37	2476
5	2412	16	2434	27	2456	38	2478
6	2414	17	2436	28	2458	39	2480
7	2416	18	2438	29	2460	/	/
8	2418	19	2440	30	2462	/	/
9	2420	20	2442	31	2464	/	/
10	2422	21	2444	32	2468	/	/

4.3. Test Channel Configuration

Tested mode, channel, information		
Mode	Channel	Frequency (MHz)
GFSK	LCH:CH0	2402
	MCH:CH19	2440
	HCH:CH39	2480

4.4. Test environment conditions

During the measurement the environmental conditions were within the listed ranges:

Temperature range:	21-25 °C
Humidity range:	40-75%
Pressure range:	86-106 kPa

4.5. The Worse Case Power Setting Parameter

The Worse Case Power Setting Parameter under 2400 ~ 2483.5MHz Band				
Test Software		MP Tool		
Modulation Type	Transmit Antenna Number	Test Software Setting Value		
		CH 00	CH 39	CH 78
GFSK	1	Default	Default	Default

4.6. Description of Available Antennas

Test Mode	Transmit and Receive Mode	Description
GFSK	<input checked="" type="checkbox"/> 1TX, 1RX	Antenna 1 can be used as transmitting/receiving antenna.

5. Description of Test Setup

5.1. Accessory

Description of Accessories	Manufacturer	Model Number	Description	Remark
N/A	N/A	N/A	N/A	N/A

5.2. Support Equipment

Equipment	Brand Name	Model Name	P/N
PC	Lenovo	T480	/

5.3. Test Setup

The EUT can work in Fixed Frequency mode.

5.4. Setup Diagram for Tests



6. Measurement Uncertainty

Where relevant, the following measurement uncertainty levels have been estimated for tests performed on the apparatus:

Test Item	Uncertainty
AC Power Conduction emission	1.37 dB
All Radiated emissions	5.4dB
Conducted emissions	3.09 dB
Occupied Channel Bandwidth	1.1%
Conducted Output power	0.82dB
Power Spectral Density	0.82dB

Note: This uncertainty represents an expanded uncertainty expressed at approximately the 95 % confidence level using a coverage factor of $k = 2$.

7. Measuring Instrument and Software Used

TS Test System						
Used	Equipment	Manufacturer	Model No.	Serial No.	Last Cal.	Due. Date
<input checked="" type="checkbox"/>	Spectrum Analyzer	Keysight	N9030B	MY56320512	Sep. 12, 2023	Sep. 11, 2024
<input checked="" type="checkbox"/>	Vector Signal Generator	Keysight	N5182B	MY57300334	Sep. 12, 2023	Sep. 11, 2024
<input checked="" type="checkbox"/>	Signal Generator	Keysight	N5171B	MY57280639	Sep. 12, 2023	Sep. 11, 2024
<input checked="" type="checkbox"/>	DC POWER	Keysight	E342A	MY59020356	Jul. 14, 2023	Jul. 13, 2024
<input checked="" type="checkbox"/>	Incubator thermometer	GWS	EL-02JA	21107288	Sep. 12, 2023	Sep. 11, 2024
<input checked="" type="checkbox"/>	Control unit(Power sensor)	Tonscend	JS0806-2	/	Sep. 12, 2023	Sep. 11, 2024
<input checked="" type="checkbox"/>	Wideband radio communication tester	R&S	CMW500	163478	Jul. 11, 2023	Jul. 10, 2024
<input checked="" type="checkbox"/>	Spectrum Analyzer	Keysight	N9020B	MY60112206	Sep. 12, 2023	Sep. 12, 2024
<input checked="" type="checkbox"/>	Control unit(Power sensor)	Tonscend	JS0806-2	21H8060465	Sep. 12, 2023	Sep. 12, 2024
Software						
Used	Description	Manufacturer	Name		Version	
<input checked="" type="checkbox"/>	Test software	Tonscend	JS1120-3		V3.3.10	
RSE Test System						
Used	Equipment	Manufacturer	Model No.	Serial No.	Last Cal.	Due. Date
<input checked="" type="checkbox"/>	EMI Receiver	R&S	ESW	101685	Jul. 12, 2023	Jul. 11, 2024
<input checked="" type="checkbox"/>	Bilog Antenna	Schwarzbeck	VULB 9163	01361	Aug. 16, 2023	Aug. 15, 2024
<input checked="" type="checkbox"/>	Horn Antenna 1	Schwarzbeck	BBHA 9120 D	02411	May. 25, 2023	May. 24, 2024
<input checked="" type="checkbox"/>	Horn Antenna 2	ETS	BBHA 9170	1090	Sep. 04, 2023	Sep. 03, 2024
<input checked="" type="checkbox"/>	loop-antenna	Schwarzbeck	FMZB 1513-60	00030	Jan. 14, 2024	Jan. 13, 2025
<input checked="" type="checkbox"/>	Signal Pre-Amplifier	Tonscend	TAP01018050	AP21C806122	Jul. 10, 2023	Jul. 09, 2024
<input checked="" type="checkbox"/>	Signal Pre-	Tonscend	TAP9K3G32	AP20K806104	Jul. 10, 2023	Jul. 09, 2024

	Amplifier					
<input checked="" type="checkbox"/>	Signal Pre-Amplifier	ETS	3116C-PA	00217677	Aug. 24, 2023	Aug. 23, 2024
<input checked="" type="checkbox"/>	3m Fully-anechoic Chamber	ETS	RFD-100	/	Apr. 24, 2021	Apr. 23, 2024
Software						
Used	Description	Manufacturer	Name		Version	
<input checked="" type="checkbox"/>	Test software	Tonscend	TS+		V3.0.0.4	
Conducted Emission Test For AC Power Port						
Used	Equipment	Manufacturer	Model No.	Serial No.	Last Cal.	Due. Date
<input checked="" type="checkbox"/>	LISN	R&S	ENV216	102154	Jul. 10, 2023	Jul. 09, 2024
<input checked="" type="checkbox"/>	EMI Receiver	R&S	ESR3	102509	Jul. 12, 2023	Jul. 11, 2024
Software						
Used	Description	Manufacturer	Name		Version	
<input checked="" type="checkbox"/>	Test software	EZ	EZ-EMC		EMEC-3A1	
Other Instrument						
Used	Equipment	Manufacturer	Model No.	Serial No.	Last Cal.	Due. Date
<input checked="" type="checkbox"/>	Temperature & Humidity	Temperature	HTC-1	/	Nov. 02, 2023	Nov. 01, 2024

8. Peak Conducted Output Power

8.1. Block diagram of test setup

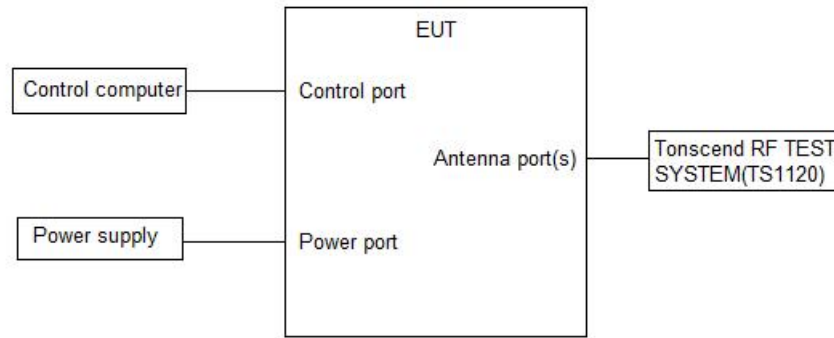

8.2. Limits

CFR 47 FCC Part15 (15.247) Subpart C ISED RSS-247 ISSUE 3			
Section	Test Item	Limit	Frequency Range (MHz)
CFR 47 FCC 15.247(b)(3) ISED RSS-247 5.4 (d)	Peak Output Power	1 watt or 30 dBm	2400 - 2483.5

8.3. Test Procedure

Connect EUT's antenna output to spectrum analyzer by RF cable.

99% Bandwidth set the spectrum analyzer as follows:

RBW:	30 kHz
VBW:	100 kHz
Detector Mode:	Peak
Sweep time:	auto
Trace mode	Max hold

6 dB Bandwidth set the spectrum analyzer as follows:

RBW:	100 kHz
VBW:	300 kHz
Detector Mode:	Peak
Sweep time:	auto
Trace mode	Max hold

Allow the trace to stabilize, measure the 6 dB and 99% bandwidth of signal.

8.4. Results

Test Mode	Ant.	Freq (MHz)	Conducted Peak Power (dBm)	Conducted Limit (dBm)	EIRP (dBm)	EIRP Limit (dBm)	Verdict
BLE_1M	Ant1	2402	2.93	≤30	6.25	≤36	PASS
		2440	3.06	≤30	6.38	≤36	PASS
		2480	4.31	≤30	7.63	≤36	PASS
BLE_2M	Ant1	2402	2.48	≤30	5.8	≤36	PASS
		2440	2.99	≤30	6.31	≤36	PASS
		2480	3.80	≤30	7.12	≤36	PASS

The Conducted Power reference report "ESTE-R2112273" and "ESTE-R2112279"

9. Radiated Emission

9.1. Block diagram of test setup

In 3 m Anechoic Chamber, test setup diagram for 9 kHz - 30 MHz:

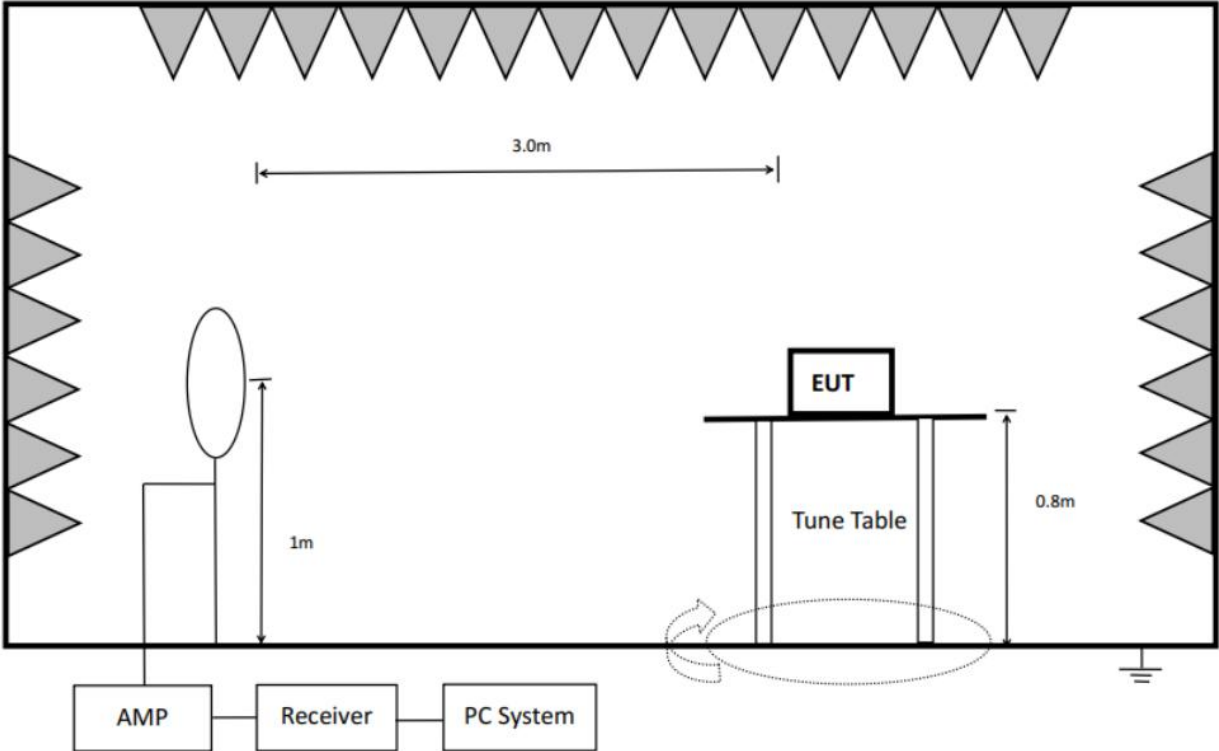

In 3 m Anechoic Chamber, test setup diagram for 30 MHz - 1 GHz:

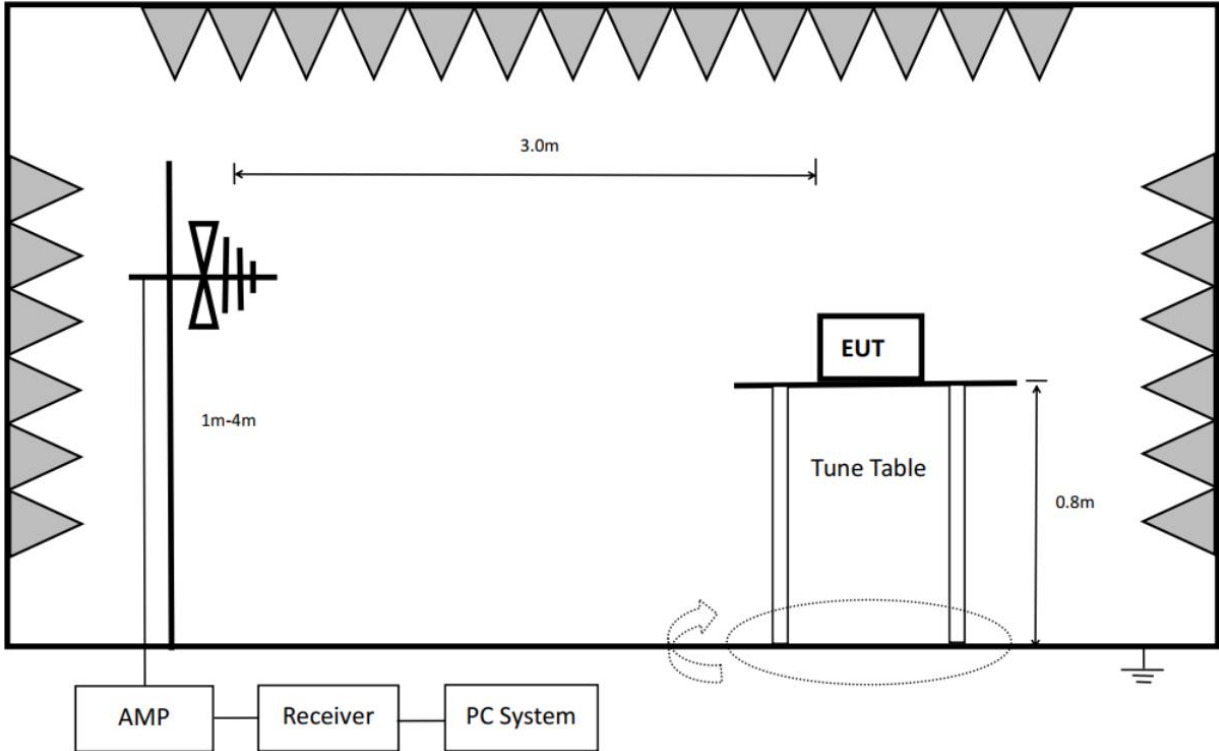

In 3 m Anechoic Chamber, test setup diagram for frequency above 1 GHz:

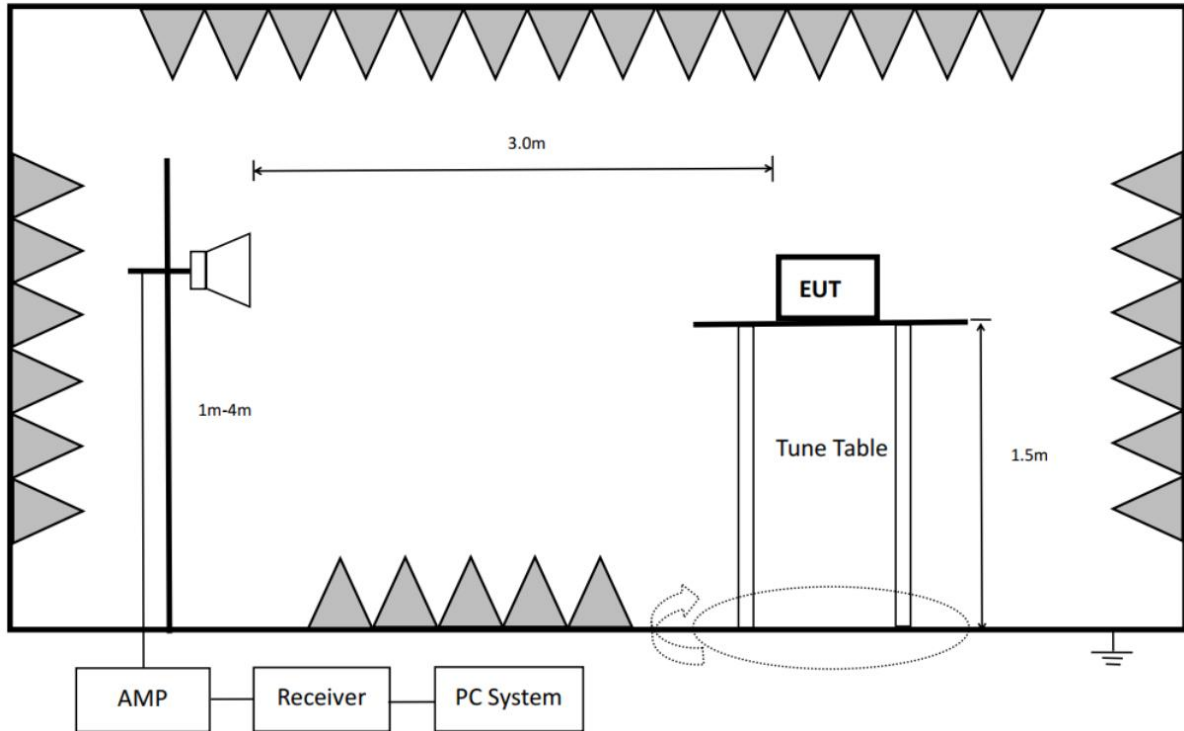

Note: For harmonic emissions test an appropriate high pass filter was inserted in the input port of AMP.

9.2. Limit

(1) FCC 15.205 Restricted frequency band

MHz	MHz	MHz	GHz
0.090-0.110	16.42-16.423	399.9-410	4.5-5.15
¹ 0.495-0.505	16.69475-16.69525	608-614	5.35-5.46
2.1735-2.1905	16.80425-16.80475	960-1240	7.25-7.75
4.125-4.128	25.5-25.67	1300-1427	8.025-8.5
4.1772&4.17775	37.5-38.25	1435-1626.5	9.0-9.2
4.2072&4.20775	73-74.6	1645.5-1646.5	9.3-9.5
6.215-6.218	74.8-75.2	1660-1710	10.6-12.7
6.26775-6.26825	108-121.94	1718.8-1722.2	13.25-13.4
6.31175-6.31225	123-138	2200-2300	14.47-14.5
8.291-8.294	149.9-150.05	2310-2390	15.35-16.2
8.362-8.366	156.52475-156.52525	2483.5-2500	17.7-21.4
8.37625-8.38675	156.7-156.9	2690-2900	22.01-23.12
8.41425-8.41475	162.0125-167.17	3260-3267	23.6-24.0
12.29-12.293	167.72-173.2	3332-3339	31.2-31.8
12.51975-12.52025	240-285	3345.8-3358	36.43-36.5
12.57675-12.57725	322-335.4	3600-4400	(²)
13.36-13.41			

¹Until February 1, 1999, this restricted band shall be 0.490-0.510 MHz.

²Above 38.6

(2) FCC 15.209 Limit.

Frequency MHz	Distance Meters	Field Strengths Limit	
		$\mu\text{V}/\text{m}$	$\text{dB}(\mu\text{V})/\text{m}$
0.009 ~ 0.490	300	2400/F(kHz)	67.6-20log(F)
0.490 ~ 1.705	30	24000/F(kHz)	87.6-20log(F)
1.705 ~ 30.0	30	30	29.54
30 ~ 88	3	100	40.0
88 ~ 216	3	150	43.5
216~960	3	200	46.0
960~1000	3	500	54.0
Above 1000	3	74.0 $\text{dB}(\mu\text{V})/\text{m}$ (Peak) 54.0 $\text{dB}(\mu\text{V})/\text{m}$ (Average)	

Note: (1) At frequencies at or above 30 MHz, measurements may be performed at a distance other than what is specified provided: measurements are not made in the near field except where it can be shown that near field measurements are appropriate due to the characteristics of the device; and it can be demonstrated that the signal levels needed to be measured at the distance employed can be detected by the measurement equipment. Measurements shall not be performed at a distance greater than 30 meters unless it can be further demonstrated that measurements at a distance of 30 meters or less are impractical. When performing measurements at a distance other than that specified, the results shall be extrapolated to the specified distance using an extrapolation factor of 20 dB/decade (inverse linear-distance for field strength measurements; inverse-linear-distance-squared for power density measurements).

(2) At frequencies below 30 MHz, measurements may be performed at a distance closer than that specified in the regulations; however, an attempt should be made to avoid making measurements in the near field. Pending the development of an appropriate measurement procedure for measurements performed below 30 MHz, when performing measurements at a closer distance than specified, the results shall be extrapolated to the specified distance by either making measurements at a minimum of two distances on at least one radial to determine the proper extrapolation factor or by using the square of an inverse linear distance extrapolation factor (40 dB/decade). This paragraph (f) shall not apply to Access BPL devices operating below 30 MHz.

About Restricted bands of operation please refer to RSS-Gen section 8.10 and FCC § 15.205(a),

9.3. Test Procedure

Below 30 MHz:

The setting of the spectrum Analyzer

RBW	300 Hz (From 9 kHz to 0.15 MHz)/ 10 kHz (From 0.15 MHz to 30 MHz)
VBW	1 kHz (From 9 kHz to 0.15 MHz)/ 30 kHz (From 0.15 MHz to 30 MHz)
Sweep	Auto
Trace	Max hold

1. The testing follows the guidelines in ANSI C63.10-2013

2. The EUT was arranged to its worst case and then turntable (from 0 degree to 360 degrees) to find the maximum reading. A pre-amp and a high pass filter are used for the test in order to get better signal level. Both Horizontal, Face-on and Face-off polarizations of the antenna are set to make the measurement.

3. The EUT was placed on a turntable with 80 cm meter above ground.

4. The EUT was set 3 meters from the interference receiving antenna, which was mounted on the top of 1 meter height antenna tower.

5. The radiated emission limits are based on measurements employing a CISPR quasi-peak detector except for the frequency bands 9-90 kHz, 110-490 kHz and above 1000 MHz. Radiated emission limits in these three bands are based on measurements employing an average detector.

6. For measurement below 1 GHz, the initial step in collecting conducted emission data is a spectrum analyzer peak detector mode pre-scanning the measurement frequency range. Significant peaks are then marked and then Quasi Peak detector mode re-measured. If the emission level of the EUT

measured by the peak detector is 3 dB lower than the applicable limit, the peak emission level will be reported. Otherwise, the emission measurement will be repeated using the quasi-peak detector and reported.

7. Although these tests were performed other than open field site, adequate comparison measurements were confirmed against 30m open field site. Therefore, sufficient tests were made to demonstrate that the alternative site produces results that correlate with the ones of tests made in an open field site based on KDB 414788.

Below 1 GHz and above 30 MHz:

The setting of the spectrum Analyzer

RBW	100 kHz
VBW	300 kHz
Sweep	Auto
Trace	Max hold

1. The testing follows the guidelines in ANSI C63.10-2013.

2. The EUT was arranged to its worst case and then tune the antenna tower (from 1 m to 4 m) and turntable (from 0 degree to 360 degrees) to find the maximum reading. A pre-amp and a high pass filter are used for the test in order to get better signal level. Both horizontal and vertical polarizations of the antenna are set to make the measurement.

3. The EUT was placed on a turntable with 80 cm above ground.

4. The EUT was set 3 meters from the interference receiving antenna, which was mounted on the top of a variable height antenna tower.

5. For measurement below 1GHz, the initial step in collecting conducted emission data is a spectrum analyzer peak detector mode pre-scanning the measurement frequency range. Significant peaks are then marked and then Quasi Peak detector mode re-measured. If the emission level of the EUT measured by the peak detector is 3 dB lower than the applicable limit, the peak emission level will be reported. Otherwise, the emission measurement will be repeated using the quasi-peak detector and reported.

Above 1 GHz:

RBW	1 MHz
VBW	PEAK: 3 MHz AVG: see note 6
Sweep	Auto
Detector	Peak
Trace	Max hold

1. The testing follows the guidelines in ANSI C63.10-2013.

2. The EUT was arranged to its worst case and then tune the antenna tower (from 1 m to 4 m) and turntable (from 0 degree to 360 degrees) to find the maximum reading. A pre-amp and a high pass filter are used for the test in order to get better signal level. Both horizontal and vertical polarizations of the antenna are set to make the measurement.

3. The EUT was placed on a turntable with 1.5m above ground.

4. The EUT was set 3 meters from the interference receiving antenna, which was mounted on the top of a variable height antenna tower.

5. For measurement above 1GHz, the emission measurement will be measured by the peak detector. This peak level, once corrected, must comply with the limit specified in Section 15.209.

6. For measurements above 1 GHz the resolution bandwidth is set to 1 MHz, then the video bandwidth is set to 3 MHz for peak measurements and 1 MHz resolution bandwidth with 1/T video bandwidth with peak detector for AVG measurements. For the Duty Cycle please refer to clause 8.1.ON TIME AND DUTY CYCLE.

7. Restriction band: Investigated frequency range from 2310 MHz to 2410 MHz and 2470MHz to 2500 MHz.

All restriction band should comply with 15.209, other emission should be at least 20 dB below the fundamental.

Note 1: For all radiated test, EUT in each of three orthogonal axis emissions had been tested, but only the worst case (X axis) data recorded in the report.

Note 2: The EUT does not support simultaneous transmission.

Note 3: The EUT was fully exercised with external accessories during the test. In the case of multiple accessory external ports, an external accessory shall be connected to one of each type of port.

9.4. Results

Pass. (See below detailed test result)

All the emissions except fundamental emission from 9 kHz to 25 GHz were comply with 15.209 limits.

Note1: According exploratory test, the emission levels are 20 dB below the limit detected from 9 kHz to 30 MHz, so the final test was performed with frequency range from 30 MHz to 26 GHz and recorded in below.

Note2: For emissions below 1 GHz, according exploratory explorer test, when change Tx mode and channel, have no distinct influence on emissions level, so for emissions below 1 GHz, the final test was only performed with EUT working in BLE_1M, Tx 2480 MHz mode.

Note3: For emissions above 1 GHz. If peak results comply with AV limit, AV Result is deemed to comply with AV limit.

9.5. Original test data

Below 1 GHz and above 30 MHz test data Refer to appendix A

Above 1 GHz test data Refer to appendix B

10. Antenna Requirements

10.1. Limits

Please refer to FCC § 15.203

An intentional radiator shall be designed to ensure that no antenna other than that furnished by the responsible party shall be used with the device. The use of a permanently attached antenna or of an antenna that uses a unique coupling to the intentional radiator shall be considered sufficient to comply with the provisions of this section. The manufacturer may design the unit so that a broken antenna can be replaced by the user, but the use of a standard antenna jack or electrical connector is prohibited.

Please refer to FCC § 15.247(b)(4)

The conducted output power limit specified in paragraph (b) of this section is based on the use of antennas with directional gains that do not exceed 6 dBi. Except as shown in paragraph (c) of this section, if transmitting antennas of directional gain greater than 6 dBi are used, the conducted output power from the intentional radiator shall be reduced below the stated values in paragraphs (b)(1), (b)(2), and (b)(3) of this section, as appropriate, by the amount in dB that the directional gain of the antenna exceeds 6 dBi.

10.2. Result

The antenna used for this product is Shrapnel antenna and that no antenna other than that furnished by the responsible party shall be used with the device, the maximum peak gain of the transmit antenna is 3.32 dBi.

APPENDIX A – Radiated Emission Below 1GHz Test Data Test Report

Project Information			
EUT:	Wi-Fi Module Integrated Bluetooth	Environment:	22.9°C 46%
Model:	SKI.WB822CU.2	SN:	
Mode:	BLE_1M_2480	Voltage:	DC 3.3V
Customer:		Engineer:	Soho Liu
Remark:			

Start of Test: 2024-03-16 11:03:26

Test Graph

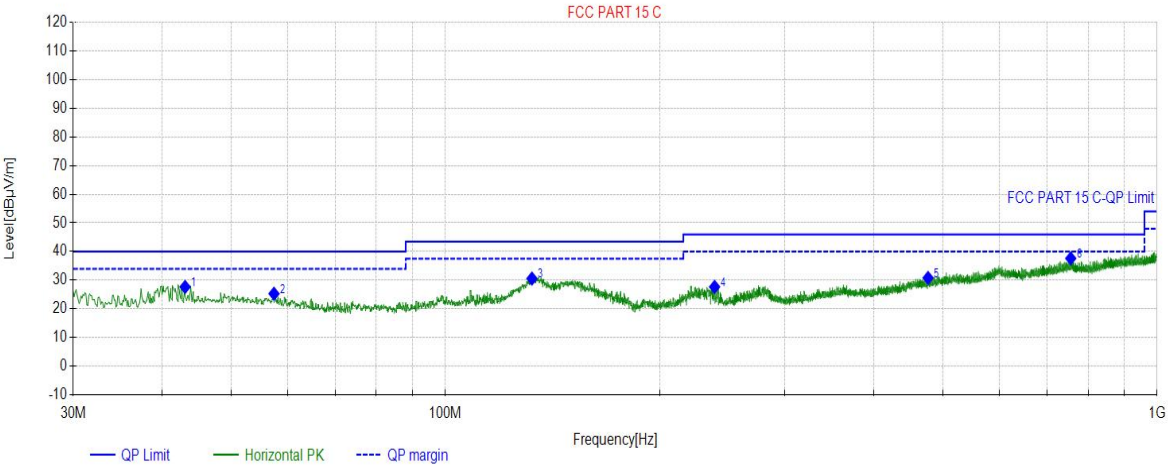

Final Data List								
NO.	Freq. (MHz)	Factor (dB)	QP Value (dBµV/m)	QP Limit (dBµV/m)	Margin (dB)	Height (cm)	Angle (°)	Polarity
1	43.0963	21.76	27.66	40.00	12.34	100	334	Horizontal
2	57.4537	21.34	25.30	40.00	14.70	100	334	Horizontal
3	132.3452	17.21	30.58	43.50	12.92	100	221	Horizontal
4	238.9589	21.03	27.67	46.00	18.33	100	235	Horizontal
5	476.7297	26.92	30.82	46.00	15.18	100	24	Horizontal
6	756.4086	32.36	37.63	46.00	8.37	100	67	Horizontal

Test Report

Project Information			
EUT:	Wi-Fi Module Integrated Bluetooth	Environment:	22.9°C 46%
Model:	SKI.WB822CU.2	SN:	
Mode:	BLE_1M_2480	Voltage:	DC 3.3V
Customer:		Engineer:	Soho Liu
Remark:			

Start of Test: 2024-03-16 11:04:10

Test Graph

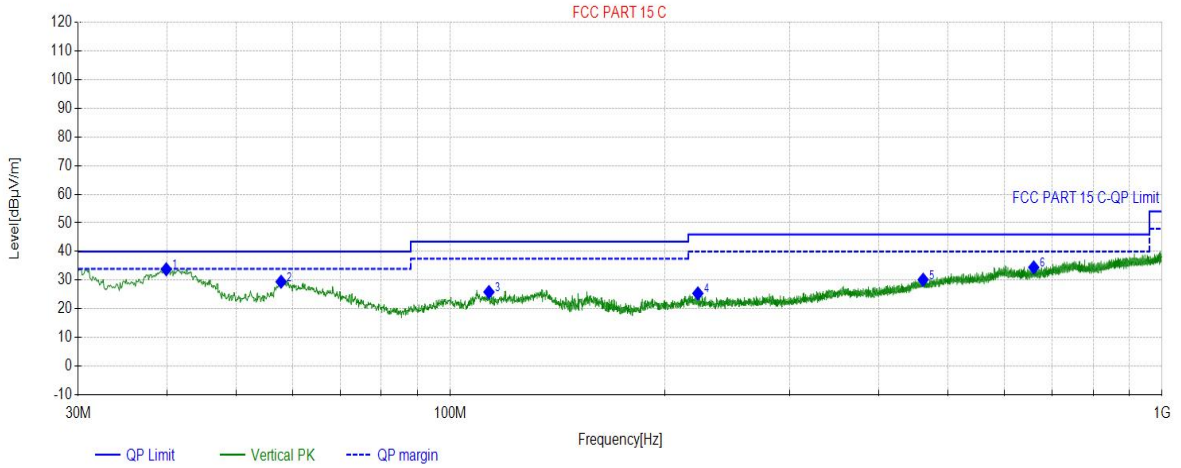

Final Data List

NO.	Freq. (MHz)	Factor (dB)	QP Value (dBµV/m)	QP Limit (dBµV/m)	Margin (dB)	Height (cm)	Angle (°)	Polarity
1	39.8950	21.09	33.81	40.00	6.19	100	110	Vertical
2	57.8418	21.29	29.47	40.00	10.53	100	184	Vertical
3	113.3313	19.52	25.88	43.50	17.62	100	78	Vertical
4	222.7583	20.58	25.39	46.00	20.61	100	280	Vertical
5	461.6932	26.55	30.18	46.00	15.82	100	360	Vertical
6	660.3690	30.28	34.48	46.00	11.52	100	203	Vertical

APPENDIX B – Radiated Emission Above 1GHz Test Data

Test Report

Project Information			
EUT:	Wi-Fi Module Integrated Bluetooth	Environment:	22.1°C 48%
Model:	SKI.WB822CU.2	SN:	
Mode:	BLE_1M_2402	Voltage:	DC 3.3V
Customer:		Engineer:	Winnie Meng
Remark:			

Start of Test: 2024-03-05 19:05:16

Test Graph

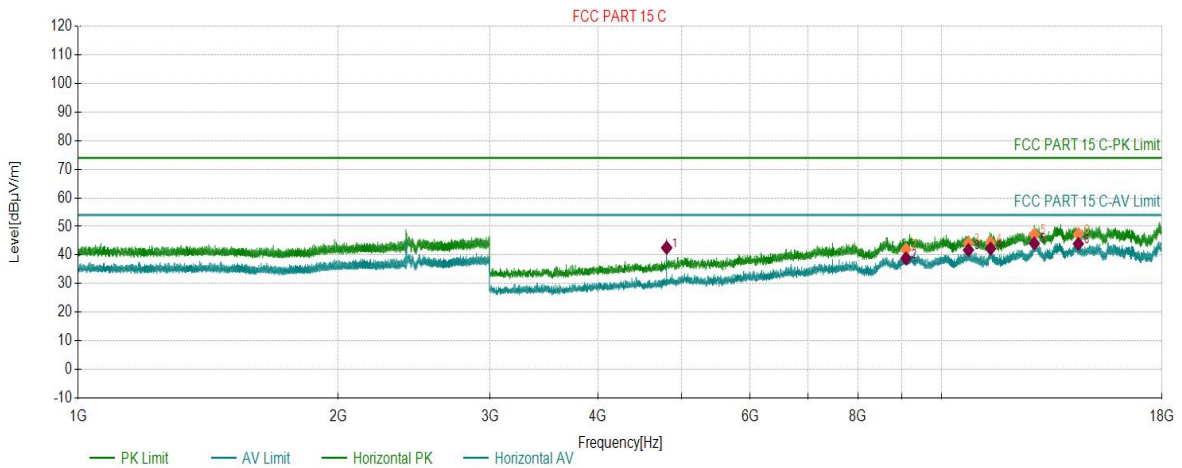

PK Final Data List								
NO.	Freq. (MHz)	Factor (dB)	PK Value (dBµV/m)	PK Limit (dBµV/m)	PK Margin (dB)	Height (cm)	Angle (°)	Polarity
1	4803.8402	-9.95	42.45	74.00	31.55	150	339	Horizontal
2	9092.5546	2.25	41.98	74.00	32.02	150	2	Horizontal
3	10741.8871	5.52	44.14	74.00	29.86	150	155	Horizontal
4	11395.1698	6.39	44.28	74.00	29.72	150	87	Horizontal
5	12802.2401	9.46	47.20	74.00	26.80	150	320	Horizontal
6	14399.8200	11.15	47.36	74.00	26.64	150	271	Horizontal

AV Final Data List								
NO.	Freq. (MHz)	Factor (dB)	AV Value (dBµV/m)	AV Limit (dBµV/m)	AV Margin (dB)	Height (cm)	Angle (°)	Polarity
1	4803.8402	-9.95	42.58	54.00	11.42	150	339	Horizontal
2	9092.5546	2.25	38.83	54.00	15.17	150	2	Horizontal
3	10741.8871	5.52	41.77	54.00	12.23	150	155	Horizontal
4	11395.1698	6.39	42.24	54.00	11.76	150	87	Horizontal
5	12802.2401	9.46	44.10	54.00	9.90	150	320	Horizontal
6	14399.8200	11.15	43.93	54.00	10.07	150	271	Horizontal

Test Report

Project Information			
EUT:	Wi-Fi Module Integrated Bluetooth	Environment:	22.1°C 48%
Model:	SKI.WB822CU.2	SN:	
Mode:	BLE_1M_2402	Voltage:	DC 3.3V
Customer:		Engineer:	Winnie Meng
Remark:			

Start of Test: 2024-03-05 19:07:00

Test Graph

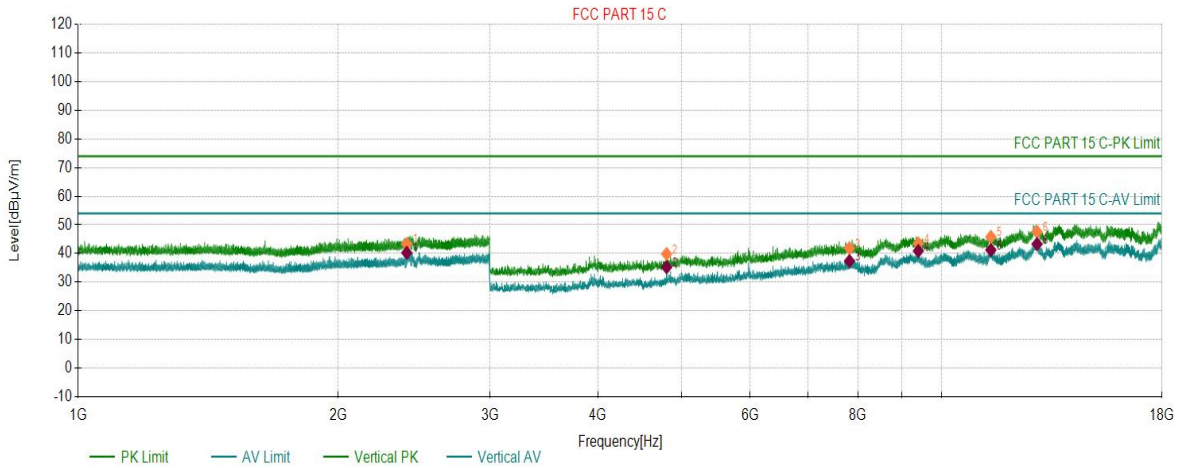

PK Final Data List								
NO.	Freq. (MHz)	Factor (dB)	PK Value (dBµV/m)	PK Limit (dBµV/m)	PK Margin (dB)	Height (cm)	Angle (°)	Polarity
1	2402.1701	7.13	43.36	74.00	30.64	150	98	Vertical
2	4803.0902	-9.95	39.87	74.00	34.13	150	73	Vertical
3	7821.9911	-0.66	41.89	74.00	32.11	150	178	Vertical
4	9397.8199	4.16	43.53	74.00	30.47	150	225	Vertical
5	11404.1702	6.43	45.82	74.00	28.18	150	111	Vertical
6	12898.2449	9.36	47.58	74.00	26.42	150	330	Vertical

AV Final Data List								
NO.	Freq. (MHz)	Factor (dB)	AV Value (dBµV/m)	AV Limit (dBµV/m)	AV Margin (dB)	Height (cm)	Angle (°)	Polarity
1	2402.1701	7.13	40.28	54.00	13.72	150	98	Vertical
2	4803.0902	-9.95	35.23	54.00	18.77	150	73	Vertical
3	7821.9911	-0.66	37.40	54.00	16.60	150	178	Vertical
4	9397.8199	4.16	40.92	54.00	13.08	150	225	Vertical
5	11404.1702	6.43	41.25	54.00	12.75	150	111	Vertical
6	12898.2449	9.36	43.31	54.00	10.69	150	330	Vertical

Test Report

Project Information			
EUT:	Wi-Fi Module Integrated Bluetooth	Environment:	22.1°C 48%
Model:	SKI.WB822CU.2	SN:	
Mode:	BLE_1M_2480	Voltage:	DC 3.3V
Customer:		Engineer:	Winnie Meng
Remark:			

Start of Test: 2024-03-05 19:13:03

Test Graph

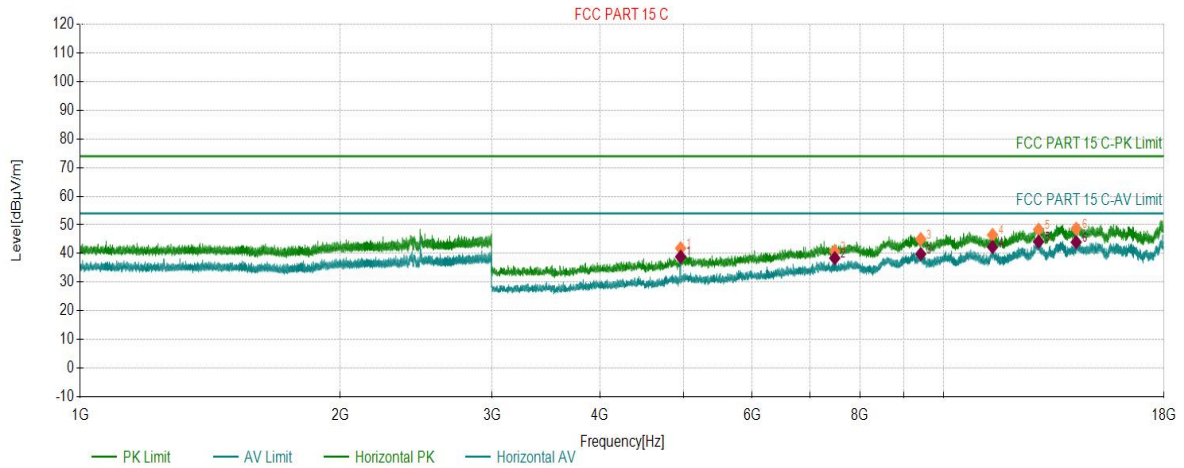

PK Final Data List

NO.	Freq. (MHz)	Factor (dB)	PK Value (dBµV/m)	PK Limit (dBµV/m)	PK Margin (dB)	Height (cm)	Angle (°)	Polarity
1	4959.8480	-8.89	41.85	74.00	32.15	150	262	Horizontal
2	7479.9740	-1.25	40.81	74.00	33.19	150	187	Horizontal
3	9408.3204	4.11	45.06	74.00	28.94	150	72	Horizontal
4	11393.6697	6.37	46.50	74.00	27.50	150	1	Horizontal
5	12881.7441	9.38	48.37	74.00	25.63	150	0	Horizontal
6	14240.0620	10.94	48.69	74.00	25.31	150	272	Horizontal

AV Final Data List

NO.	Freq. (MHz)	Factor (dB)	AV Value (dBµV/m)	AV Limit (dBµV/m)	AV Margin (dB)	Height (cm)	Angle (°)	Polarity
1	4959.8480	-8.89	38.89	54.00	15.11	150	262	Horizontal
2	7479.9740	-1.25	38.40	54.00	15.60	150	187	Horizontal
3	9408.3204	4.11	39.85	54.00	14.15	150	72	Horizontal
4	11393.6697	6.37	42.28	54.00	11.72	150	1	Horizontal
5	12881.7441	9.38	44.13	54.00	9.87	150	0	Horizontal
6	14240.0620	10.94	43.98	54.00	10.02	150	272	Horizontal

Test Report

Project Information			
EUT:	Wi-Fi Module Integrated Bluetooth	Environment:	22.1°C 48%
Model:	SKI.WB822CU.2	SN:	
Mode:	BLE_1M_2480	Voltage:	DC 3.3V
Customer:		Engineer:	Winnie Meng
Remark:			

Start of Test: 2024-03-05 19:14:48

Test Graph

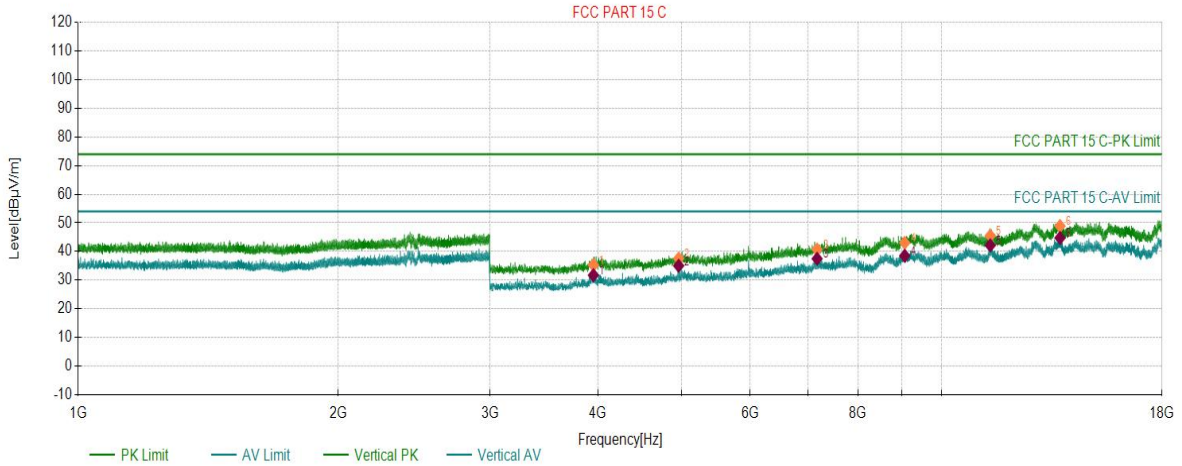

PK Final Data List								
NO.	Freq. (MHz)	Factor (dB)	PK Value (dBµV/m)	PK Limit (dBµV/m)	PK Margin (dB)	Height (cm)	Angle (°)	Polarity
1	3951.0476	-13.55	35.30	74.00	38.70	150	81	Vertical
2	4959.8480	-8.89	37.58	74.00	36.42	150	41	Vertical
3	7174.7087	-1.58	40.74	74.00	33.26	150	22	Vertical
4	9063.3032	2.39	43.05	74.00	30.95	150	111	Vertical
5	11386.1693	6.25	45.51	74.00	28.49	150	0	Vertical
6	13712.7856	10.81	48.90	74.00	25.10	150	0	Vertical

AV Final Data List								
NO.	Freq. (MHz)	Factor (dB)	AV Value (dBµV/m)	AV Limit (dBµV/m)	AV Margin (dB)	Height (cm)	Angle (°)	Polarity
1	3951.0476	-13.55	31.76	54.00	22.24	150	81	Vertical
2	4959.8480	-8.89	35.04	54.00	18.96	150	41	Vertical
3	7174.7087	-1.58	37.49	54.00	16.51	150	22	Vertical
4	9063.3032	2.39	38.52	54.00	15.48	150	111	Vertical
5	11386.1693	6.25	42.18	54.00	11.82	150	0	Vertical
6	13712.7856	10.81	44.76	54.00	9.24	150	0	Vertical

Test Report

Project Information			
EUT:	Wi-Fi Module Integrated Bluetooth	Environment:	22.9°C 46%
Model:	SKI.WB822CU.2	SN:	
Mode:	BLE_1M_2440	Voltage:	DC 3.3V
Customer:		Engineer:	Soho Liu
Remark:			

Start of Test: 2024-03-16 14:10:37

Test Graph

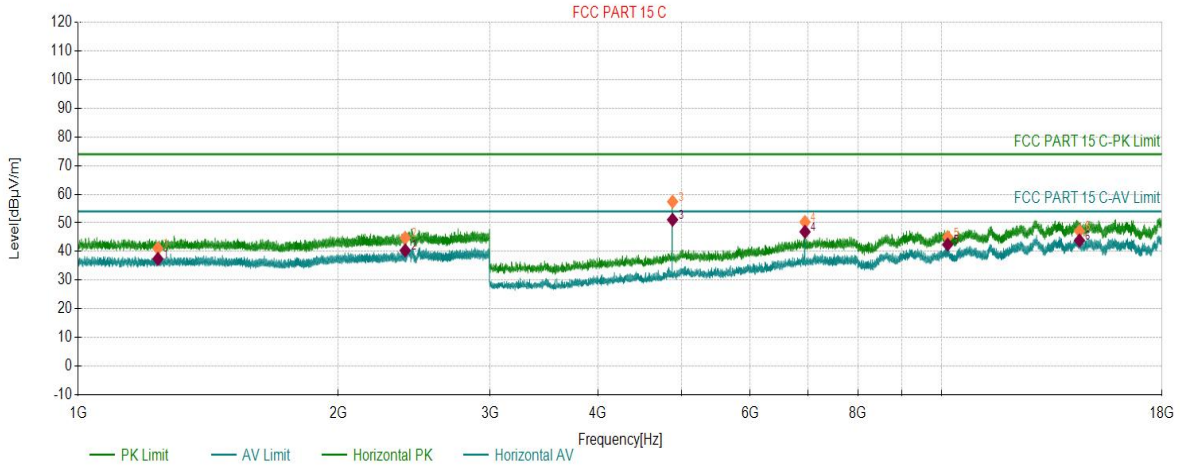

PK Final Data List								
NO.	Freq. (MHz)	Factor (dB)	PK Value (dBµV/m)	PK Limit (dBµV/m)	PK Margin (dB)	Height (cm)	Angle (°)	Polarity
1	1236.9118	2.42	41.12	74.00	32.88	150	301	Horizontal
2	2392.0696	7.10	44.77	74.00	29.23	150	244	Horizontal
3	4880.0340	-9.46	57.40	74.00	16.60	127.8	294.4	Horizontal
4	6946.6973	-2.51	50.31	74.00	23.69	150	260	Horizontal
5	10162.8581	4.78	45.07	74.00	28.93	150	114	Horizontal
6	14442.5721	11.15	47.16	74.00	26.84	150	202	Horizontal

AV Final Data List								
NO.	Freq. (MHz)	Factor (dB)	AV Value (dBµV/m)	AV Limit (dBµV/m)	AV Margin (dB)	Height (cm)	Angle (°)	Polarity
1	1236.9118	2.42	37.43	54.00	16.57	150	301	Horizontal
2	2392.0696	7.10	40.38	54.00	13.62	150	244	Horizontal
3	4880.0340	-9.46	51.10	54.00	2.90	127.8	294.4	Horizontal
4	6946.6973	-2.51	46.90	54.00	7.10	150	260	Horizontal
5	10162.8581	4.78	42.44	54.00	11.56	150	114	Horizontal
6	14442.5721	11.15	43.86	54.00	10.14	150	202	Horizontal

Test Report

Project Information			
EUT:	Wi-Fi Module Integrated Bluetooth	Environment:	22.9°C 46%
Model:	SKI.WB822CU.2	SN:	
Mode:	BLE_1M_2440	Voltage:	DC 3.3V
Customer:		Engineer:	Soho Liu
Remark:			

Start of Test: 2024-03-16 14:12:18

Test Graph

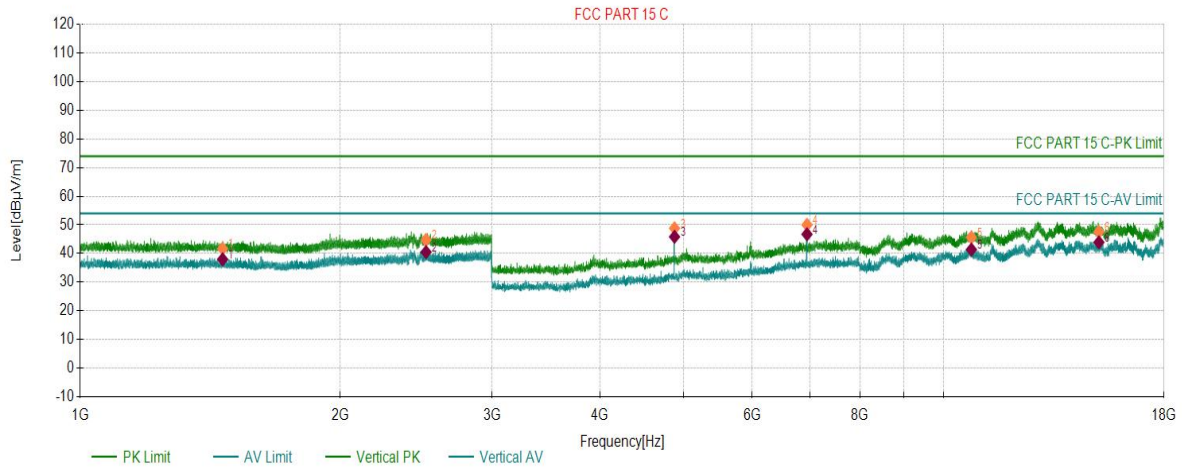

PK Final Data List

NO.	Freq. (MHz)	Factor (dB)	PK Value (dBµV/m)	PK Limit (dBµV/m)	PK Margin (dB)	Height (cm)	Angle (°)	Polarity
1	1462.2231	3.34	41.72	74.00	32.28	150	176	Vertical
2	2515.1758	7.74	44.73	74.00	29.27	150	0	Vertical
3	4879.5940	-9.46	48.83	74.00	25.17	150	329	Vertical
4	6946.6973	-2.51	50.02	74.00	23.98	150	290	Vertical
5	10768.1384	5.55	45.62	74.00	28.38	150	70	Vertical
6	15129.6065	11.68	47.59	74.00	26.41	150	320	Vertical

AV Final Data List

NO.	Freq. (MHz)	Factor (dB)	AV Value (dBµV/m)	AV Limit (dBµV/m)	AV Margin (dB)	Height (cm)	Angle (°)	Polarity
1	1462.2231	3.34	37.99	54.00	16.01	150	176	Vertical
2	2515.1758	7.74	40.52	54.00	13.48	150	0	Vertical
3	4879.5940	-9.46	45.85	54.00	8.15	150	329	Vertical
4	6946.6973	-2.51	46.73	54.00	7.27	150	290	Vertical
5	10768.1384	5.55	41.41	54.00	12.59	150	70	Vertical
6	15129.6065	11.68	43.92	54.00	10.08	150	320	Vertical

Test Report

Project Information			
EUT:	Wi-Fi Module Integrated Bluetooth	Environment:	22.1°C 48%
Model:	SKI.WB822CU.2	SN:	
Mode:	BLE_1M_2402	Voltage:	DC 3.3V
Customer:		Engineer:	Winnie Meng
Remark:			

Start of Test: 2024-03-05 19:02:42

Test Graph

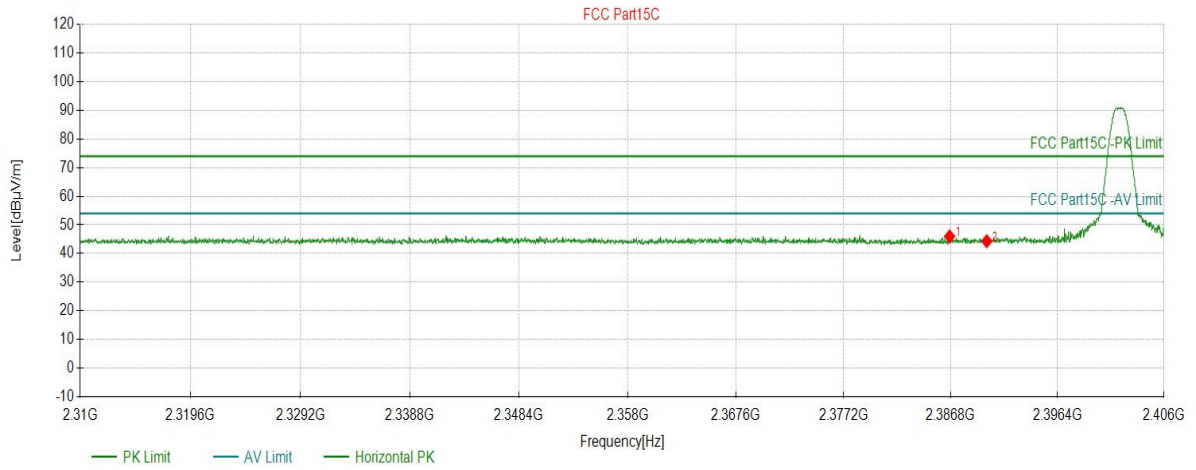

Suspected Data List

NO.	Freq. (MHz)	Level (dBµV/m)	Factor (dB)	Limit (dBµV/m)	Margin (dB)	Height (cm)	Angle (°)	Detector	Polarity
1	2386.6976	45.98	5.65	74.00	28.02	150	288	PK	Horizont
2	2390.0267	44.31	5.65	74.00	29.69	150	309	PK	Horizont

Test Report

Project Information			
EUT:	Wi-Fi Module Integrated Bluetooth	Environment:	22.1°C 48%
Model:	SKI.WB822CU.2	SN:	
Mode:	BLE_1M_2402	Voltage:	DC 3.3V
Customer:		Engineer:	Winnie Meng
Remark:			

Start of Test: 2024-03-05 19:03:43

Test Graph

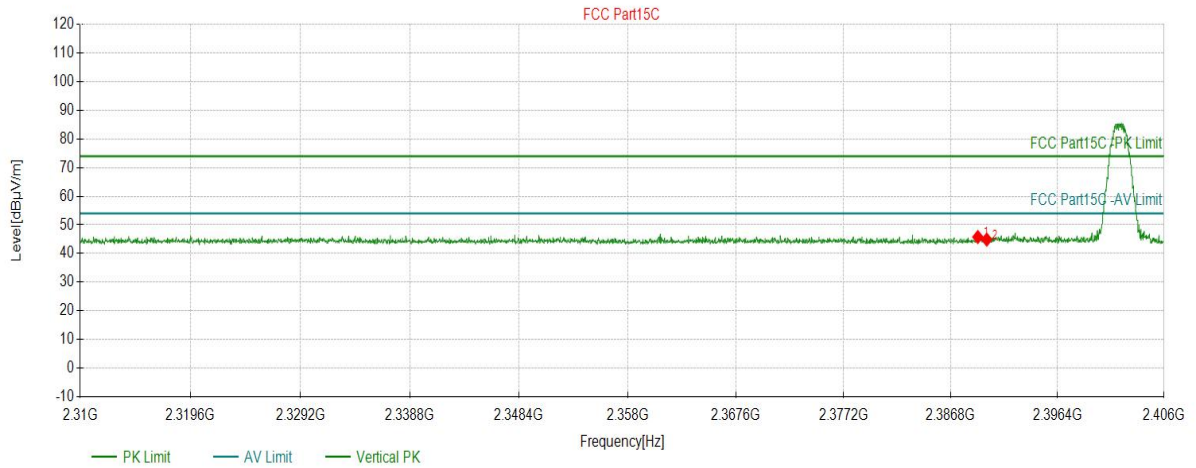

Suspected Data List

NO.	Freq. (MHz)	Level (dBµV/m)	Factor (dB)	Limit (dBµV/m)	Margin (dB)	Height (cm)	Angle (°)	Detector	Polarity
1	2389.2264	45.78	5.65	74.00	28.22	150	158	PK	Vertical
2	2390.0267	44.87	5.65	74.00	29.13	150	60	PK	Vertical

Test Report

Project Information			
EUT:	Wi-Fi Module Integrated Bluetooth	Environment:	22.1°C 48%
Model:	SKI.WB822CU.2	SN:	
Mode:	BLE_1M_2480	Voltage:	DC 3.3V
Customer:		Engineer:	Winnie Meng
Remark:			

Start of Test: 2024-03-05 19:11:09

Test Graph

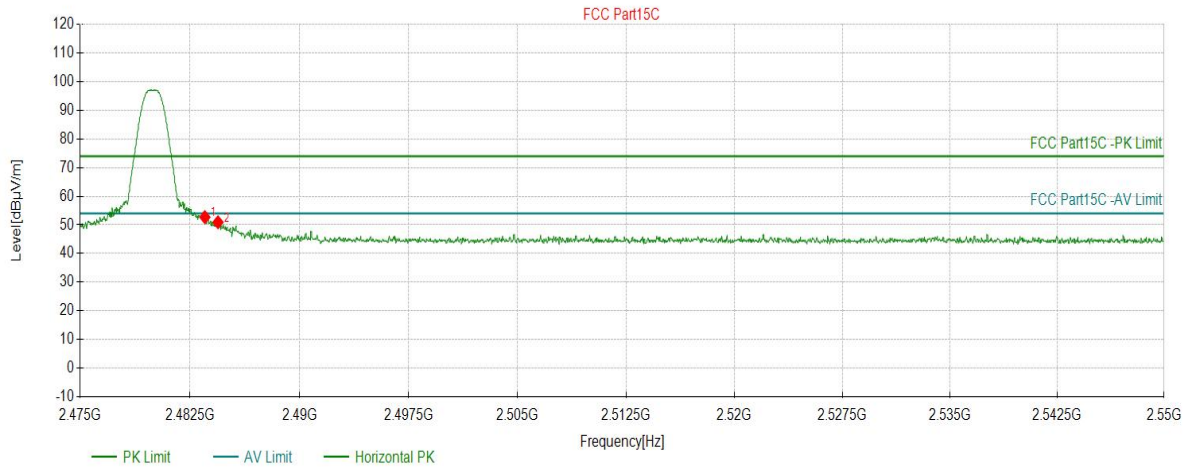

Suspected Data List

NO.	Freq. (MHz)	Level (dBµV/m)	Factor (dB)	Limit (dBµV/m)	Margin (dB)	Height (cm)	Angle (°)	Detector	Polarity
1	2483.5168	52.70	6.24	74.00	21.30	150	207	PK	Horizont
2	2484.4172	50.93	6.25	74.00	23.07	150	215	PK	Horizont

Test Report

Project Information			
EUT:	Wi-Fi Module Integrated Bluetooth	Environment:	22.1°C 48%
Model:	SKI.WB822CU.2	SN:	
Mode:	BLE_1M_2480	Voltage:	DC 3.3V
Customer:		Engineer:	Winnie Meng
Remark:			

Start of Test: 2024-03-05 19:11:57

Test Graph

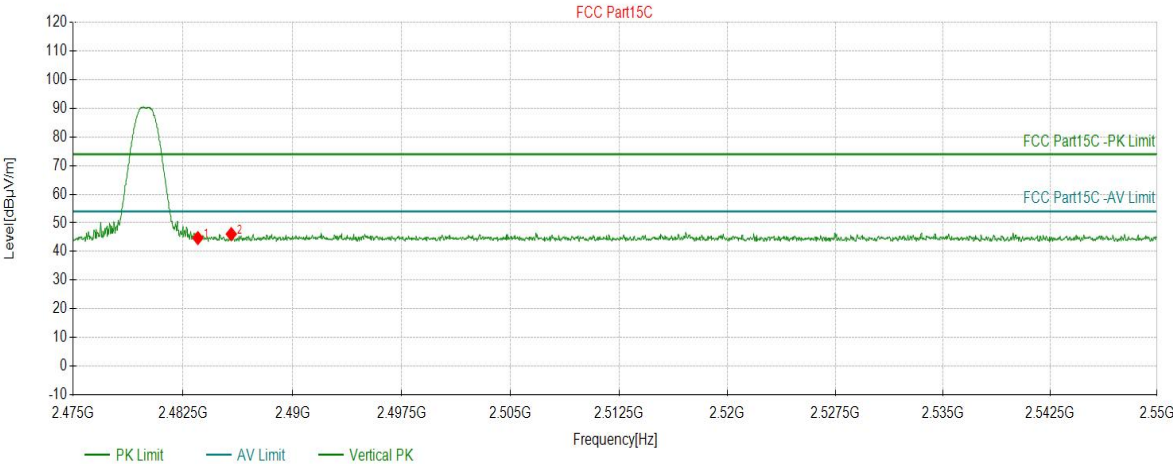

Suspected Data List									
NO.	Freq. (MHz)	Level (dBµV/m)	Factor (dB)	Limit (dBµV/m)	Margin (dB)	Height (cm)	Angle (°)	Detector	Polarity
1	2483.5168	44.72	6.24	74.00	29.28	150	165	PK	Vertical
2	2485.8054	46.10	6.26	74.00	27.90	150	96	PK	Vertical

Test Report

Project Information			
EUT:	Wi-Fi Module Integrated Bluetooth	Environment:	22.1°C 48%
Model:	SKI.WB822CU.2	SN:	
Mode:	BLE_1M_2402	Voltage:	DC 3.3V
Customer:		Engineer:	Winnie Meng
Remark:			

Start of Test: 2024-03-05 19:18:47

Test Graph

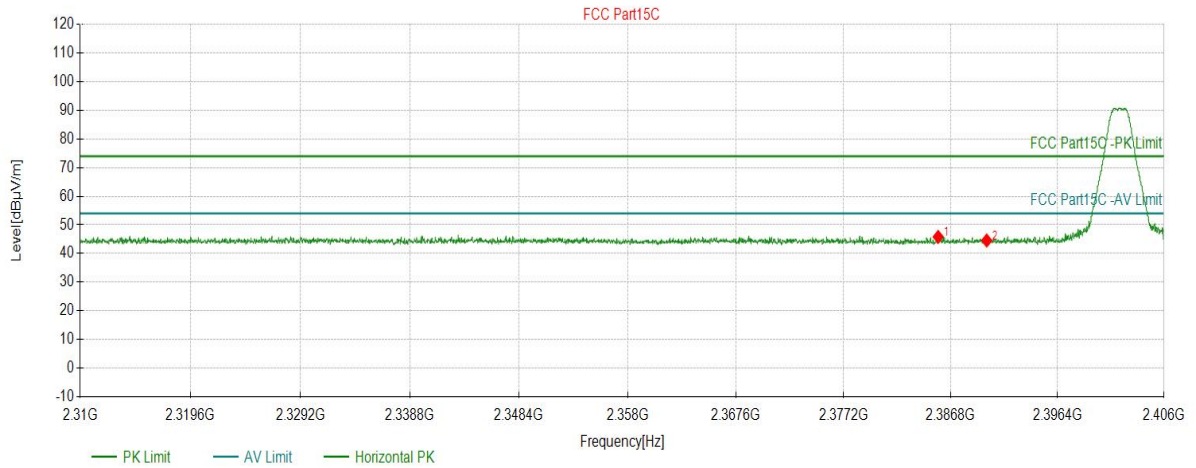

Suspected Data List									
NO.	Freq. (MHz)	Level (dBµV/m)	Factor (dB)	Limit (dBµV/m)	Margin (dB)	Height (cm)	Angle (°)	Detector	Polarity
1	2385.6732	45.84	5.65	74.00	28.16	150	86	PK	Horizont
2	2390.0267	44.56	5.65	74.00	29.44	150	331	PK	Horizont

Test Report

Project Information			
EUT:	Wi-Fi Module Integrated Bluetooth	Environment:	22.1°C 48%
Model:	SKI.WB822CU.2	SN:	
Mode:	BLE_2M_2402	Voltage:	DC 3.3V
Customer:		Engineer:	Winnie Meng
Remark:			

Start of Test: 2024-03-05 19:19:48

Test Graph

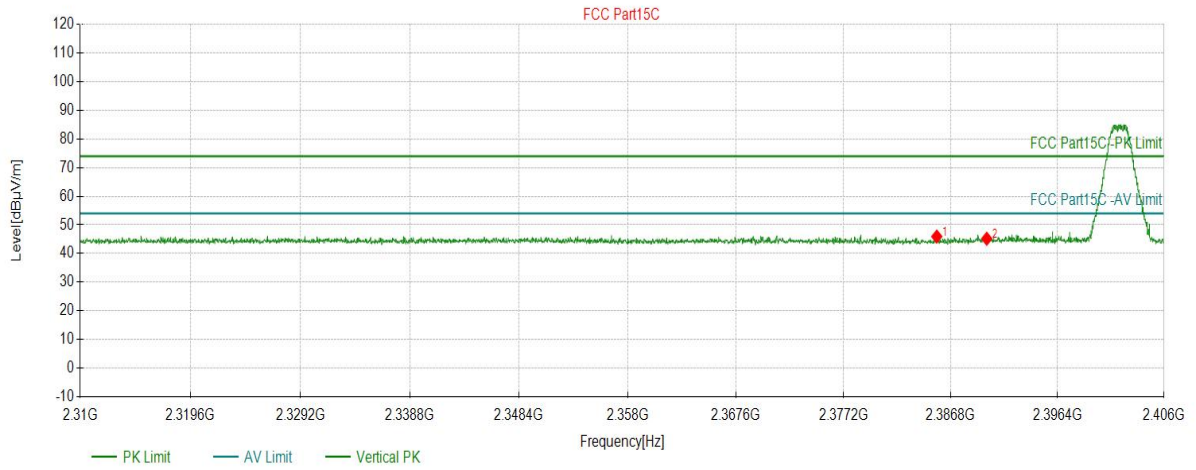

Suspected Data List

NO.	Freq. (MHz)	Level (dBµV/m)	Factor (dB)	Limit (dBµV/m)	Margin (dB)	Height (cm)	Angle (°)	Detector	Polarity
1	2385.5452	45.95	5.65	74.00	28.05	150	147	PK	Vertical
2	2390.0267	45.19	5.65	74.00	28.81	150	42	PK	Vertical

Test Report

Project Information			
EUT:	Wi-Fi Module Integrated Bluetooth	Environment:	22.1°C 48%
Model:	SKI.WB822CU.2	SN:	
Mode:	BLE_2M_2480	Voltage:	DC 3.3V
Customer:		Engineer:	Winnie Meng
Remark:			

Start of Test: 2024-03-05 19:25:48

Test Graph

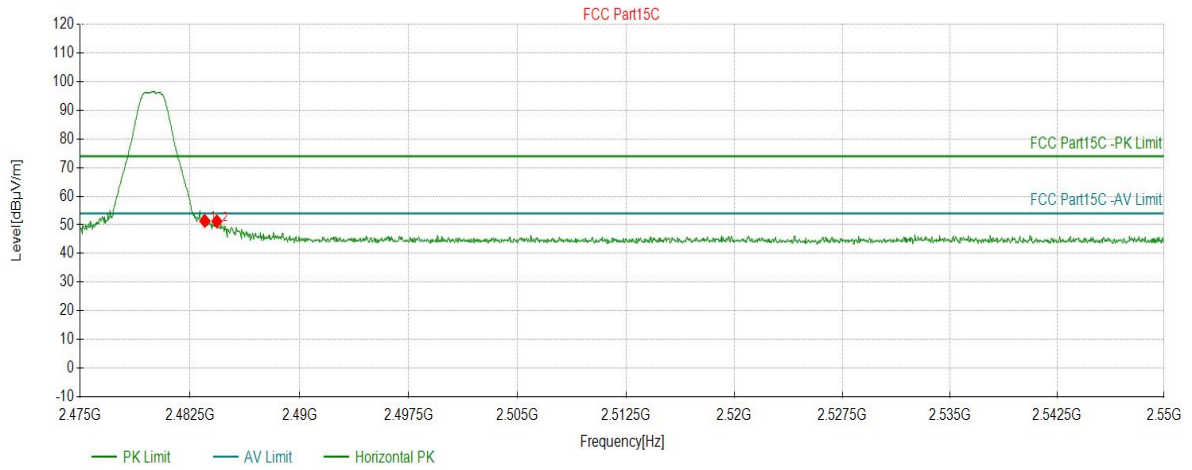

Suspected Data List

NO.	Freq. (MHz)	Level (dBµV/m)	Factor (dB)	Limit (dBµV/m)	Margin (dB)	Height (cm)	Angle (°)	Detector	Polarity
1	2483.5168	51.38	6.24	74.00	22.62	150	243	PK	Horizont
2	2484.3422	51.23	6.25	74.00	22.77	150	209	PK	Horizont

Test Report

Project Information			
EUT:	Wi-Fi Module Integrated Bluetooth	Environment:	22.1°C 48%
Model:	SKI.WB822CU.2	SN:	
Mode:	BLE_2M_2480	Voltage:	DC 3.3V
Customer:		Engineer:	Winnie Meng
Remark:			

Start of Test: 2024-03-05 19:26:37

Test Graph

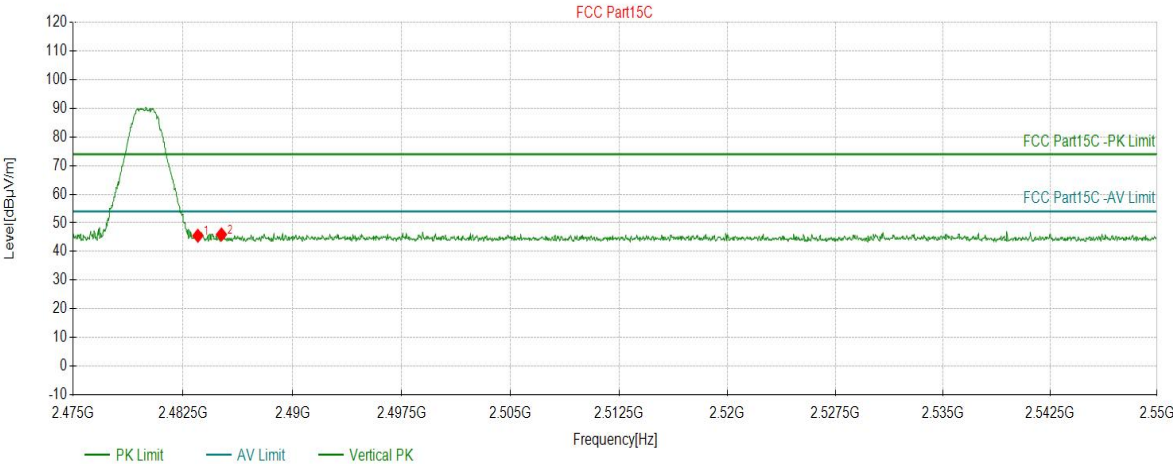

Suspected Data List

NO.	Freq. (MHz)	Level (dBµV/m)	Factor (dB)	Limit (dBµV/m)	Margin (dB)	Height (cm)	Angle (°)	Detector	Polarity
1	2483.5168	45.51	6.24	74.00	28.49	150	127	PK	Vertical
2	2485.1301	45.96	6.25	74.00	28.04	150	290	PK	Vertical

END OF REPORT