

承认书

供应商名称: 深圳市中天迅通信技术股份有限公司

供应商物料名称: AKATW03 WIFI-6 天线

供应商规格型号: WIFI-1 天线组件

CVTE 物料代码: 004.032.0052849

承认书版次: A1

软件版本号（不涉及可不填）: _____

供应商承认栏		
制定	审核	批准
柯友杰	冯家能 2024.01.31 研发专用章	邹国华

地址: 广州市黄埔区连珉路 6 号

电话: 020-86154388

传真:

地址: 深圳市宝安区石龙仔石龙大道 34 号(腾达工业园)

电话: 0755-27588320

传真: 0755-27588045

版权 CVTE 所有，本档内容属商业机密。未经允许，任何组织或个人不得以任何形式复制和传播

规格承认书

SPECIFICATION FOR APPROVAL

客户 Customer	广州视琨电子科技有限公司
项目名称 Project Name	AKATW03 WIFI-6 天线
客户料号 Customer NO.	004.032.0052849
规格 specification	WIFI-1 天线组件
供方料号 Supplier NO.	2.00000443
规格书编号 specification NO.	
编写人 Write by	柯友杰
版本 REV.	A1
日期 Date	2024/1/31
备注 Note	

客户确认 CUSTOMER APPROVED BY		
批准 Approved by	审核 checked by	制表 prepared by
供方确认 SUPPLIER APPROVED BY		
批准 Approved by	审核 checked by	制表 prepared by
邹国华 2024.01.31 研发专用章	冯家能	柯友杰



ANTENNA SPECIFICATION

CUS P/N :AKATW03 WIFI-6 天线_WIFI-1 天线组件 Application Date:Jan,31,2024
ZTX P/N : AKATW03 WIFI-6 天线_WIFI-1 天线组件 Editor:

Rev: R:A1
Page 2 of 15

1. 承认书项目表 (Index)

序号	内容	页码
-	承认书封面	-
-	版本变更记录	1
1	承认书项目表	2
2	试验设备和条件	3~7
3	天线实物图	8
4	驻波图	9
5	成品图	10
6	包装	11
7	全尺寸	12
8	可靠性测试报告	13
9	原材料检测清单	14

ANTENNA SPECIFICATION

CUS P/N :AKATW03 WIFI-6 天线_WIFI-1 天线组件 Application Date:Jan,31,2024
ZTX P/N : AKATW03 WIFI-6 天线_WIFI-1 天线组件 Editor:

Rev: R:A1
Page 3 of 15

2. 试验设备和条件(Test Equipment & Conditions)

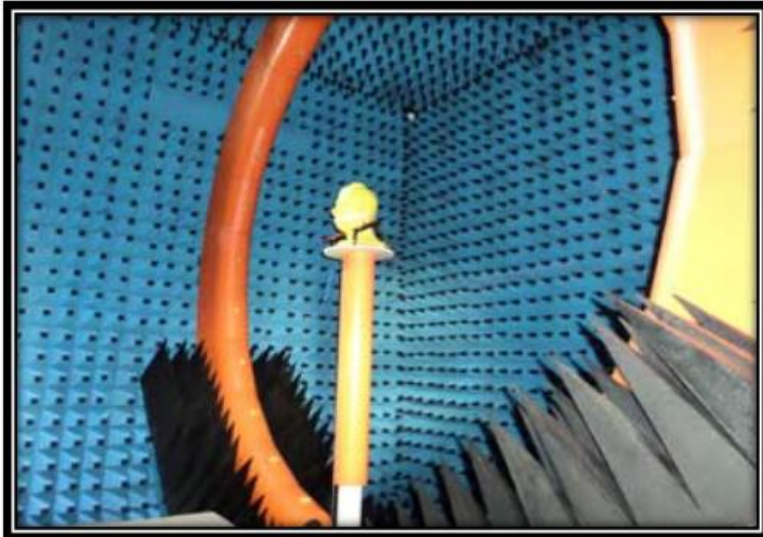

Owned 6 microwave dark room, equipped 2 sets world leading France Satimo SG24 OTA certification test systems (one in SHENZHEN, another one in Shanghai), ETS OTA Standard test system, Blue test reverberation test system which is High repeatability, high accuracy and high resolution. It can quickly provide accurate test reports, fully meet the CITA standards.

Testing range:

Support active, passive testing of
GSM/CDMA/WCDMA/TD-
SCDMA/LTE/WIFI/WLAN/WiMax/BT
/GPS/MIMO/UWB within 0.4-6G.

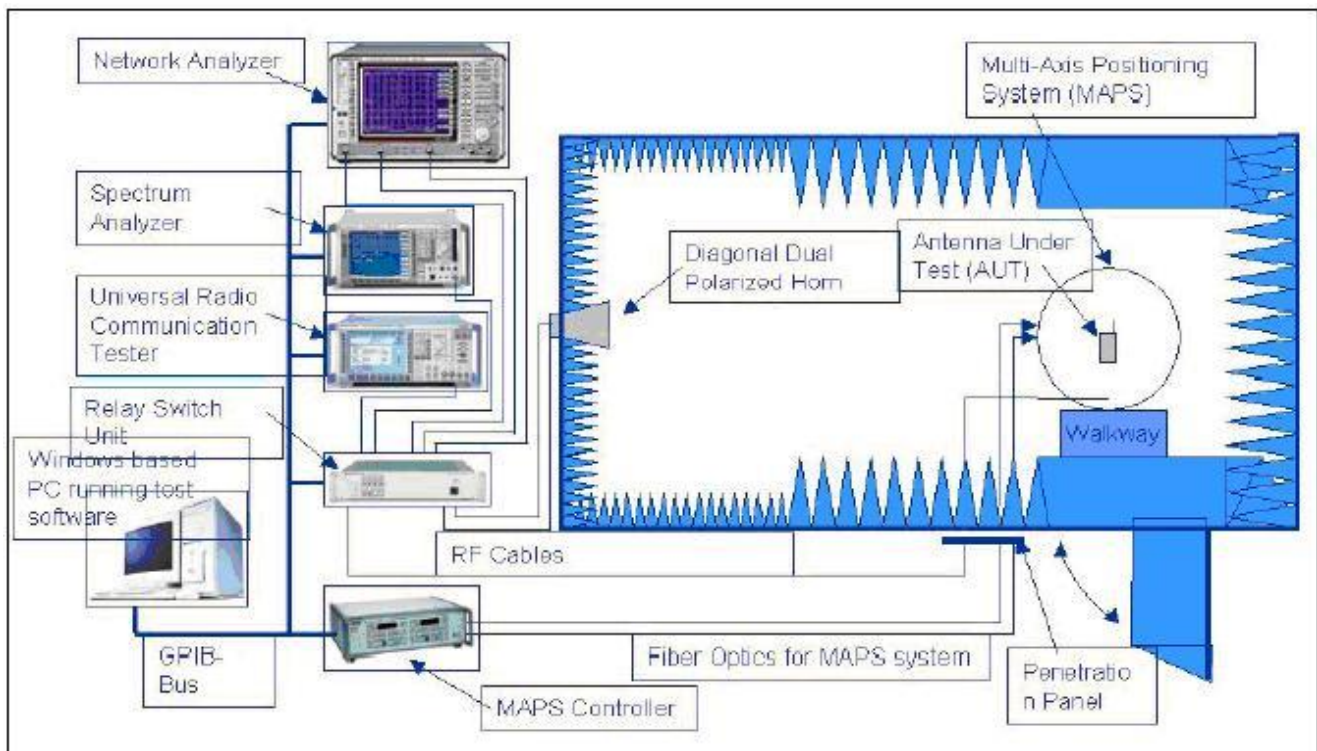

ANTENNA SPECIFICATION

CUS P/N :AKATW03 WIFI-6 天线_WIFI-1 天线组件 Application Date:Jan,31,2024

Rev: R:A1

ZTX P/N : AKATW03 WIFI-6 天线_WIFI-1 天线组件 Editor:

Page 4 of 15

2-1 Passive Test

Frequency	Efficiency	Efficiency . dB	Gain . dB				
2400	51%	-2.92	2.59	5150	44%	-3.57	2.95
2410	53%	-2.76	2.89	5200	45%	-3.47	3.04
2420	52%	-2.84	3.17	5250	44%	-3.57	3.34
2430	47%	-3.28	2.48	5300	44%	-3.57	3.00
2440	47%	-3.28	2.39	5350	45%	-3.47	3.03
2450	47%	-3.28	2.30	5400	46%	-3.37	2.17
2460	46%	-3.37	2.31	5450	47%	-3.28	2.22
2470	48%	-3.19	2.68	5500	42%	-3.77	2.94
2480	47%	-3.28	2.60	5550	42%	-3.77	2.37
2490	49%	-3.10	2.39	5600	44%	-3.57	2.64
2500	50%	-3.01	2.52	5650	43%	-3.67	3.21
				5700	43%	-3.67	3.23
				5750	43%	-3.67	2.56
				5800	43%	-3.67	2.72
				5850	43%	-3.67	2.35

ANTENNA SPECIFICATION

CUS P/N :AKATW03 WIFI-6 天线_WIFI-1 天线组件 Application Date:Jan,31,2024
ZTX P/N : AKATW03 WIFI-6 天线_WIFI-1 天线组件 Editor:

Rev: R:A1
Page 5 of 15

2-2 2D/3D Radiation Pattern Results

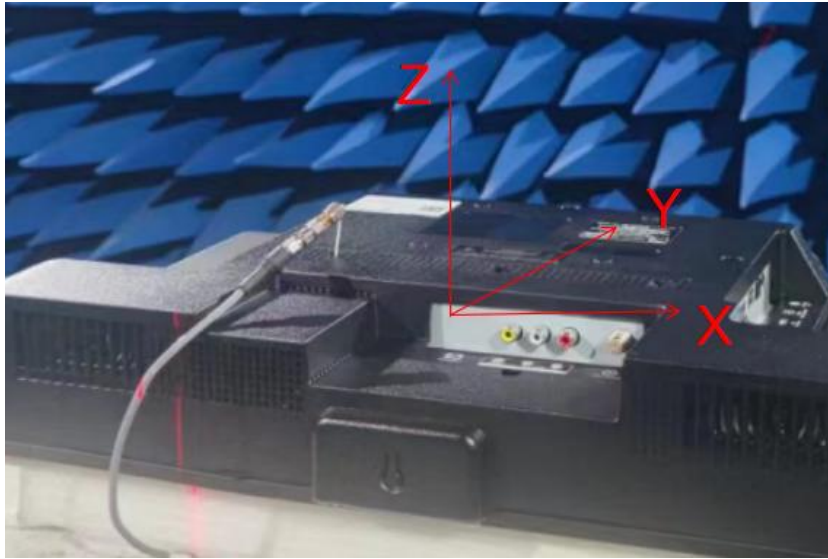

2.4G

xoy

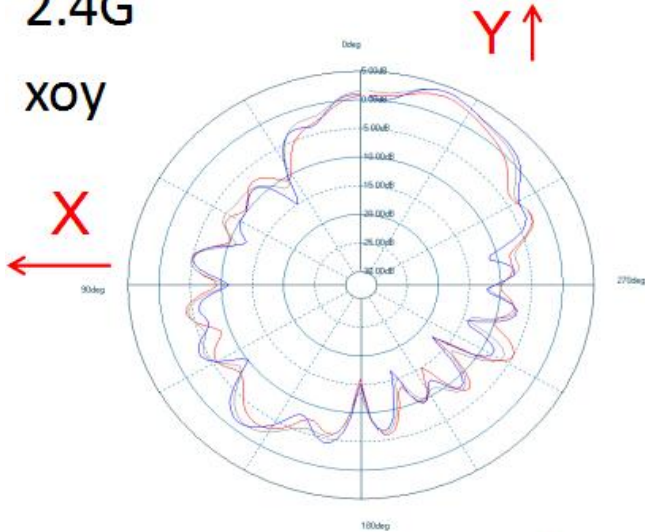

yoz

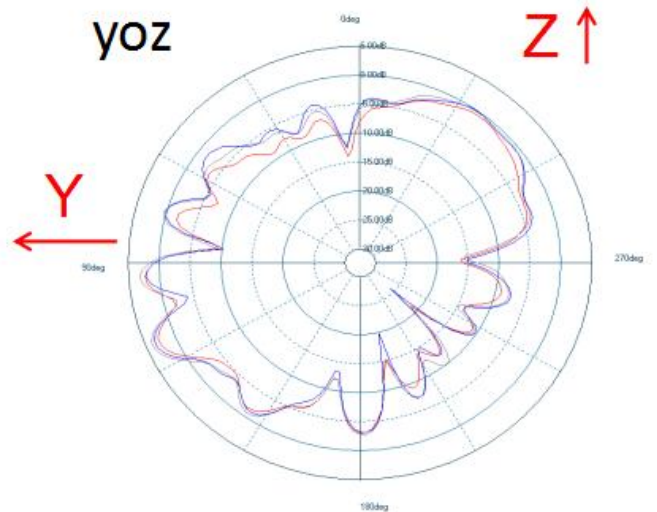

xoz

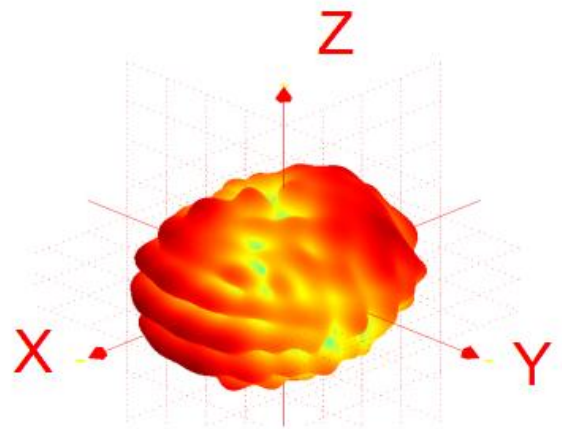
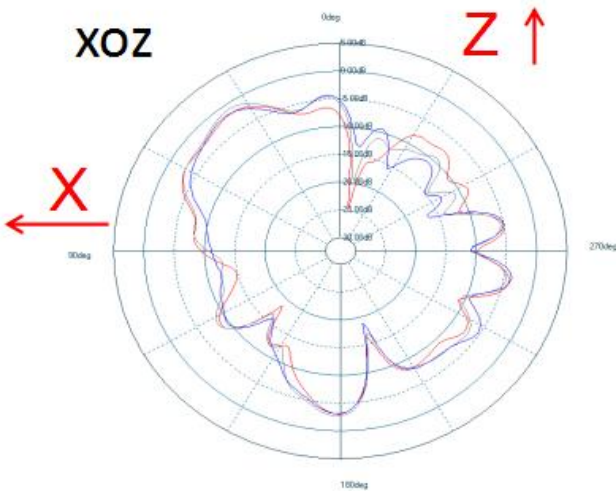

ANTENNA SPECIFICATION

CUS P/N :AKATW03 WIFI-6 天线_WIFI-1 天线组件 Application Date:Jan,31,2024

Rev: R:A1

ZTX P/N : AKATW03 WIFI-6 天线_WIFI-1 天线组件 Editor:

Page 6 of 15

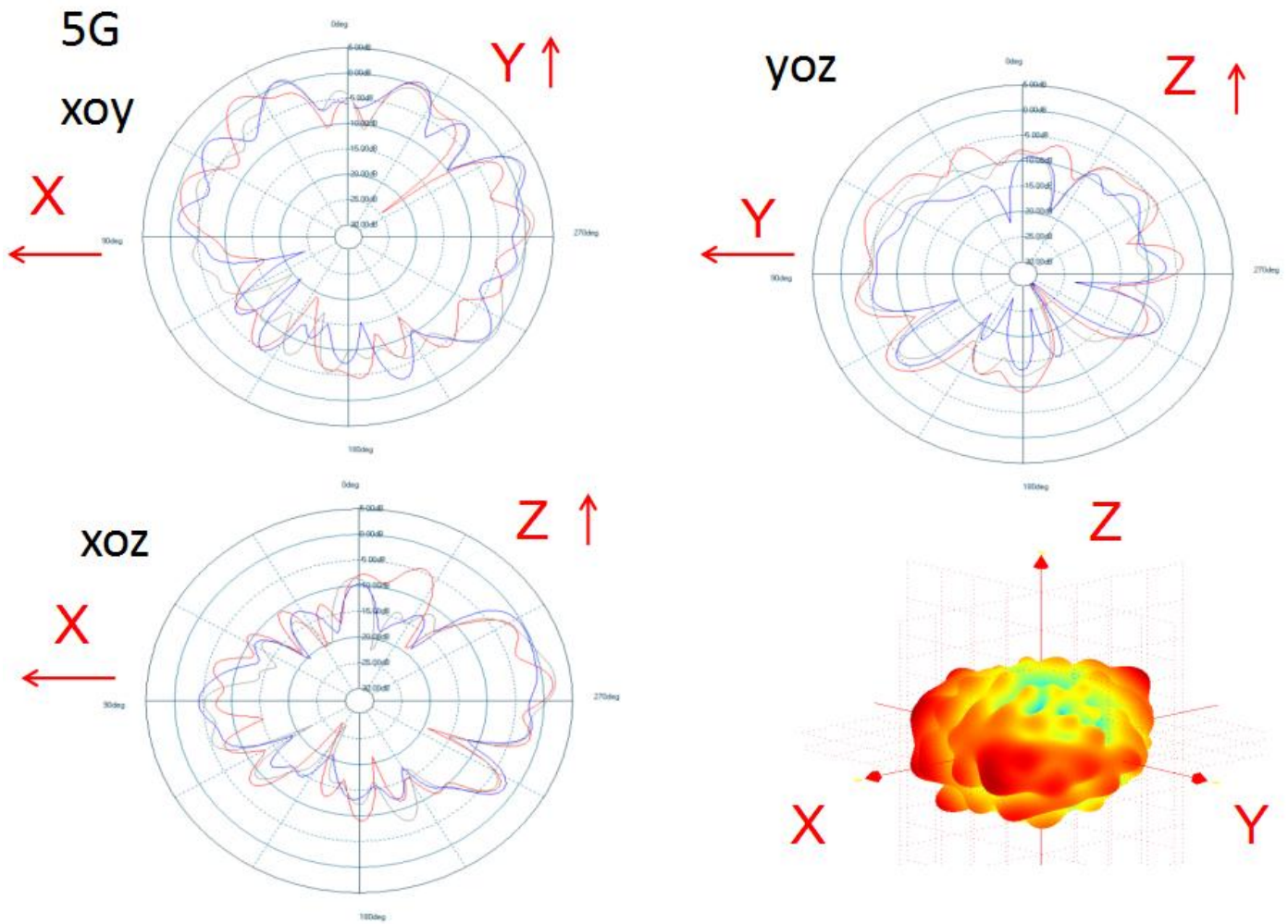

ANTENNA SPECIFICATION

CUS P/N :AKATW03 WIFI-6 天线_WIFI-1 天线组件 Application Date:Jan,31,2024

Rev: R:A1

ZTX P/N : AKATW03 WIFI-6 天线_WIFI-1 天线组件 Editor:

Page 7 of 15

2-3 Environmental treatment



天线后期可添加定位标记

ANTENNA SPECIFICATION

CUS P/N :AKATW03 WIFI-6 天线_WIFI-1 天线组件 Application Date:Jan,31,2024

Rev: R:A1

ZTX P/N : AKATW03 WIFI-6 天线_WIFI-1 天线组件 Editor:

Page 8 of 15

3.FPC 天线实物图(Mechanical instruction)



ANTENNA SPECIFICATION

CUS P/N :AKATW03 WIFI-6 天线_WIFI-1 天线组件 Application Date:Jan,31,2024
ZTX P/N :AKATW03 WIFI-6 天线_WIFI-1 天线组件 Editor:

Rev: R:A1
Page 9 of 15

4.驻波图

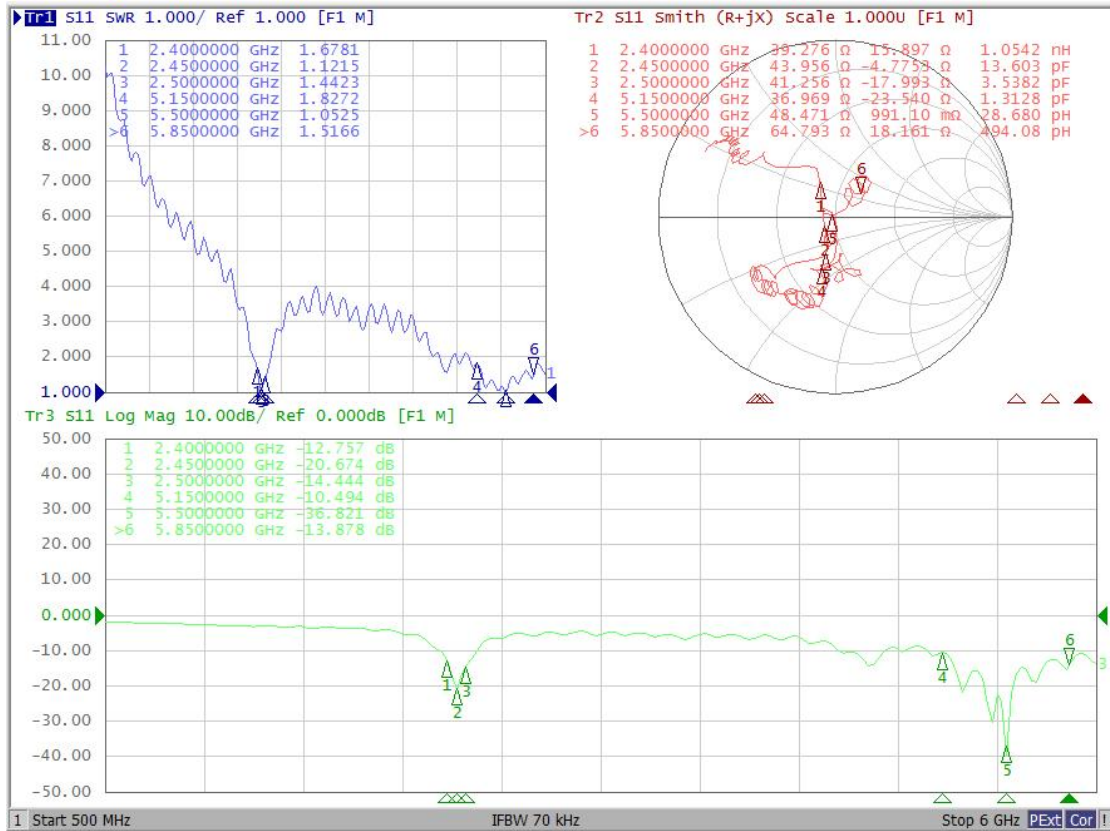

ANTENNA SPECIFICATION

CUS P/N :AKATW03 WIFI-6 天线_WIFI-1 天线组件 Application Date:Jan,31,2024
 ZTX P/N : AKATW03 WIFI-6 天线_WIFI-1 天线组件 Editor:

Rev: R:A1
 Page 10 of 15

5.成品图 (Drawing)

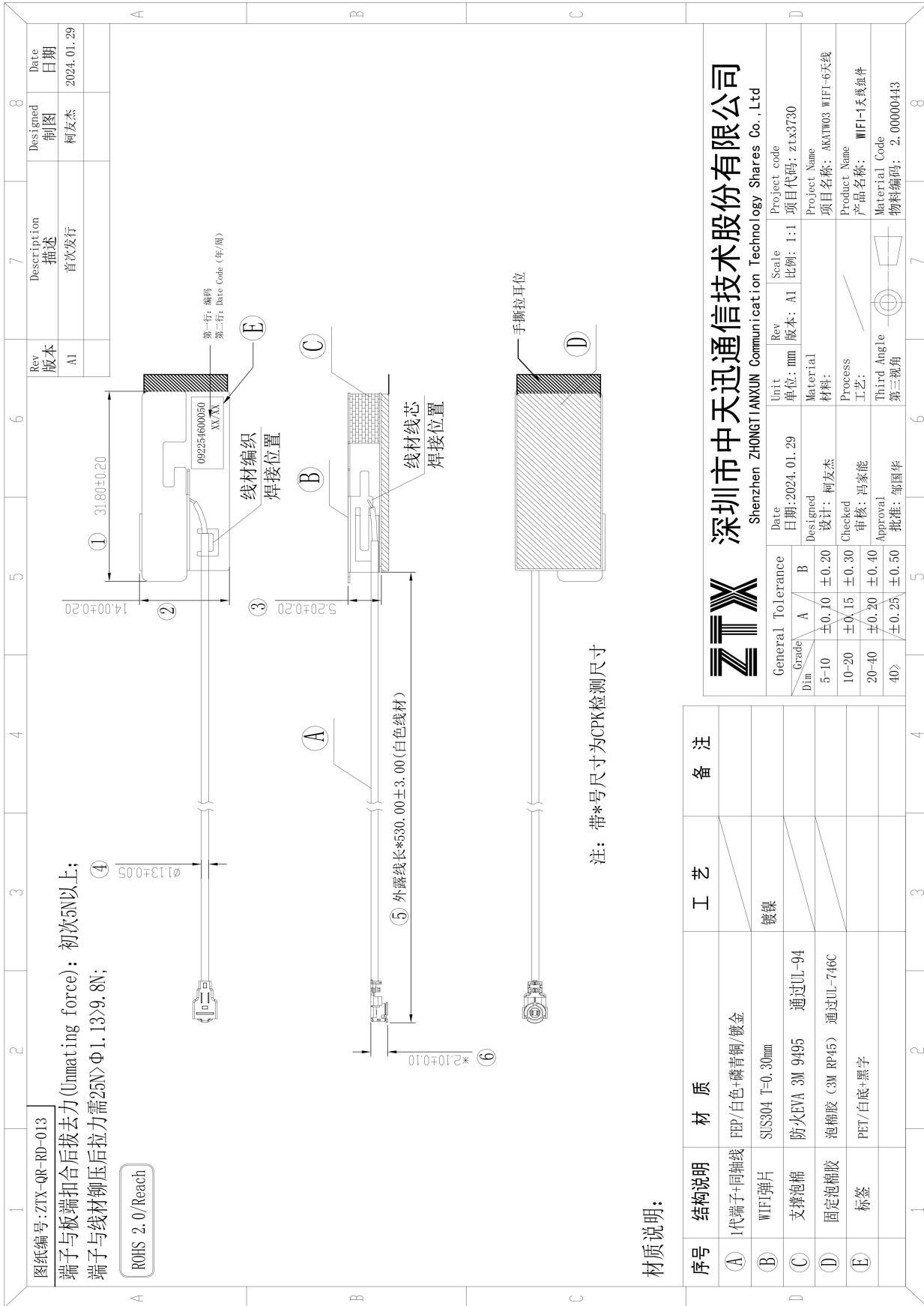

ANTENNA SPECIFICATION

CUS P/N :AKATW03 WIFI-6 天线_WIFI-1 天线组件 Application Date:Jan,31,2024
ZTX P/N : AKATW03 WIFI-6 天线_WIFI-1 天线组件 Editor:

Rev: R:A1
Page 11 of 15

6. 包装(Package)

作业指导书			
工序序号/名称	版本	作业工时 (s)	文件编号
包装	A1	/	ZTX-QD-WI-ASSY-819
仪器校准及要求: N/A			
操作方法及参数 (自检该工序作业合格后,方能流入下一道工序)			
取样	1.作业前需仔细核对物料号与SOP上的物料号一致;以及是否检验合格QC盖PASS确认无误后方可作业		
包装	2.线长<450mm,点数50PCS/扎,将端子头对齐,用橡皮筋扎紧;线长≥450mm需要换线,50pcs分2扎,25PCS/扎,如图一		
周转	3.取50PCS装入PE封口袋,对折多余PE封口袋用订书机封口,并贴上对应的标签如图二;		
	4.取4袋(200PCS)装入PE封口袋,封口后在袋子上贴上对应的标签如图三;		
	5.取底部按“工”字型封箱OK的外箱底部放一张平卡将10袋(2000PCS)产品装入纸箱,在顶部盖上平卡;共2000PCS产品,2张平卡;不许多放漏放;确认无误后按“工”字型封箱,如图四;		
	6.贴上对应的标签。		
6S要求: 1.保持检测现场台面整洁,无尘、水、油污; 2.物料摆放整齐,标识清楚;			
注意事项: 1.客户物料编码和数量是否正确,标签必须用机打印的 2.内标签、外标签、出货报告、送货单内容需一致。 3.如是试产物料或有变更均需贴相应标识,尾数箱需贴尾数标识,内附检验报告等			
物料名称	物料代码	规格	用量
PE开口袋	1.12.000030	240*160*0.05mm	50/袋
PE封口袋	1.12.000029	230*330*0.05mm	200/袋
纸箱	1.12.000002	K-K 46*32.5*21CM (无LOGO丝印标志)	2000/箱
平卡	1.12.0000306	A3B 42*30CM	2张/箱
ROHS标绿色	1.23.000130	铜隔板20*13mm	1张/箱
备注			
版本		修订内容	
A1		新发行	修订日期 2024.01.20
制订	方强	审核	批准
		于鸿尉	曹先浪
			党非非

表单编号: ZTX-QR-RD-028 版本: A1

深圳市中天迅通信技术股份有限公司
SHENZHEN ZHONGTIAN XUN Communication Technology Co.,Ltd.

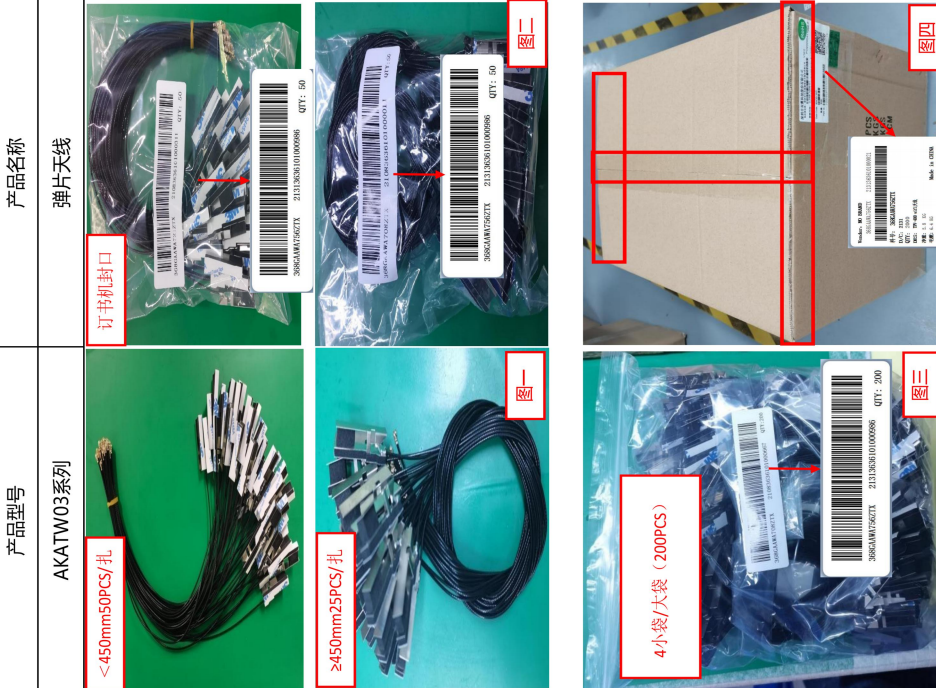

ANTENNA SPECIFICATION

CUS P/N :AKATW03 WIFI-6 天线_WIFI-1 天线组件 Application Date:Jan,31,2024
ZTX P/N : AKATW03 WIFI-6 天线_WIFI-1 天线组件 Editor:

Rev: R:A1
Page 12 of 15

7.全尺寸 (FAI)



样品检测报告

客户名称	广州视现			产品名称	AKATW03_WIFI-6天线_WIFI-1				数量	10PCS						
产品材质	同轴线+端子+弹片+泡棉+背胶			材料颜色	白色				日期	2023/11/29						
产品类型:	<input type="checkbox"/> 新模样品 <input type="checkbox"/> 改模样品 <input type="checkbox"/> 量产 <input type="checkbox"/> 其它															
NO	类型	工程图纸要求尺寸	上公差	下公差	实测尺寸										判定	备注
					1	2	3	4	5	6	7	8	9	10		
1		31.80	0.20	0.20	31.80	31.82	31.78	31.81	31.80	31.80	31.79	31.81	31.80	31.79	OK	
2		14.00	0.20	0.20	14.10	14.08	14.09	14.10	14.08	14.09	14.11	14.08	14.09	14.11	OK	
3		5.20	0.20	0.20	5.21	5.20	5.20	5.20	5.21	5.24	5.20	5.22	5.10	5.21	OK	
4		1.13	0.04	0.04	1.13	1.13	1.13	1.13	1.13	1.13	1.13	1.13	1.13	1.13	OK	
5		530.00	3.00	3.00	531.00	531.00	531.00	531.00	531.00	531.00	531.00	531.00	531.00	531.00	OK	
6		2.10	0.10	0.10	2.04	2.04	2.04	2.04	2.04	2.04	2.04	2.04	2.04	2.04	OK	
7																
8																
9																
10																
11																
12																
13																
14																
外观:OK																
其它:驻波一致性测试OK																
总判定: <input checked="" type="checkbox"/> OK <input type="checkbox"/> NG																
批准:柯友杰 审核:易爱玲 作成:易思露																
备注:																

表单编号:ZTX-QR-QA-016 版本:A1

ANTENNA SPECIFICATION

CUS P/N :AKATW03 WIFI-6 天线_WIFI-1 天线组件 Application Date:Jan,31,2024

Rev: R:A1

ZTX P/N :AKATW03 WIFI-6 天线_WIFI-1 天线组件 Editor:

Page 13 of 15

8. 可靠性测试 (Reliability Report)



测试报告(Test Report)									
样品名称 (Product name)	WIFI-6 WIFI-1天线组件(V1)		样品型号 (Part Model)	AKATW03		环境温度 (Ambient temperature)	20±5℃	测试日期 (Date of test)	2023/11/30
样品数量 (Specimens quantity)	21PCS		客户料号 (Customer number)	/		相对湿度 (Relative humidity)	50-60%RH	委托单位 (Client/Dept)	品质部
测试原因 (Test reasons)	<input checked="" type="checkbox"/> 新型号/材料验证 <input type="checkbox"/> 新工艺验证 <input type="checkbox"/> ORT测试 <input type="checkbox"/> 过期物料 <input type="checkbox"/> 客户投诉要求 <input type="checkbox"/> 高不良率 <input type="checkbox"/> 其他: 定期例行性分析				测试依据 (Test documentation)	<input type="checkbox"/> 产品图纸 <input checked="" type="checkbox"/> 天线可靠性检验基准书 <input type="checkbox"/> 客户要求 <input type="checkbox"/> 出货检验基准书 <input type="checkbox"/> 其他:			
序号 (NO)	测试项目 (Test project)	样品数 (Samples Qty.)	测试仪器 (Test equipment)	测试条件与要求 (Test condition and note)	测试结果 (Test result)	结论 (Conclude) (Pass/Fail)	样品图片/实测值		
1	盐雾测试	3	盐雾测试机	条件: 1. 将产品以30度±5度放置于试验箱 2. 调试好试验箱参数: NaCl (无水); 浓度5%±1%; pH值: 6.5~7.2; 试验室温度: 32-38℃; 压缩空气压力: 1.0±0.01 (KG/M2) 喷雾量: 1.0~2.0ML/80CM2/H. 相对湿度: 85%±2%; 试验品放置角度: 30度+/-10度 3. 放置时间为48小时. 4. 清洗后在室温条件下放置2H观察 要求: 镀(涂)层无脱落、起泡、腐蚀、氧化等不良现象; 产品表面不可有锈斑等不良现象	均未出现镀层脱落及氧化现象。	Pass			
2	高温测试	3	高低温交变湿热试验箱	1.将样品放入高温 85 ℃ 的环境中保持48小时后取出 2.在室温条件下放置2H.	试验后产品无变形, 无变色, 无脱落, 无起翘, 电性功能完好	Pass			
3	低温测试	3	低温冰箱	1.将样品放入低温 -40 ℃ 的环境中保持48小时后取出 2.在室温条件下放置2H.	试验后产品无变形, 无变色, 无脱落, 无起翘, 电性功能完好	Pass			
4	高温高湿储存测试	3	高低温交变湿热试验箱	1.取样3pcs 2.将测试样品置于测试箱中(温度70±2℃, 湿度90%~95%RH), 放置48H后取出检查.	试验后产品无变形, 无变色, 无脱落, 无起翘, 电性功能完好	Pass			
5	端子与线材铆压后拉力	3	拉力计	1.取样3PCS 2.端子固定在治具上, 使其端子与线材分离, 拉断线材记录其最大值, 需≥15N	端子脱落后拉力数据大于15N	Pass	19.3N 16.0N 16.8N		
6	综合插拔去力试验	3	拉力计	1. 取焊接样品3pcs 2. IP6X插头插入对应插座, 对IP6X插头施加垂直插头金属面的拉力, 要求初始拔去力≥5N	插头不会从插座脱落, 无变形等, 初始拔去力>5N	Pass	15.4N 15.8N 16.7N		
7	焊点拉力	3	拉力计	1.取焊接样品3pcs 2.固定弹片,向焊点施加>9.8N的力, 保持5S	焊点拉力大于9.8N	Pass	17.7N 16.1N 16.7N		

备注(Comments):

核准(Approved by): 邓孝华

审核(Checked by): 易爱玲

测试(Name of operator): 李丽华











表单编号: ZTX-QR-QA-076 版本: A1

ANTENNA SPECIFICATION

CUS P/N :AKATW03 WIFI-6 天线_WIFI-1 天线组件 Application Date:Jan,31,2024
 ZTX P/N : AKATW03 WIFI-6 天线_WIFI-1 天线组件 Editor:

Rev: R:A1
 Page 14 of 15

9.原材料检测清单/Raw Material Detection List

Raw Material Detection List 原材料检测清单																			
序号	组成部件或零件 Parts or Components	材料名称或型号 Style/Item NO.	Pb 铅	Cd 镉	Hg 汞	Cr6+ 六价铬	PBBs 多溴联苯	PBDEs 多溴联苯醚	邻苯二甲酸二(2-乙基己)酯 DEHP	邻苯二甲酸二丁酯 DBP	邻苯二甲酸二(4-叔丁基)酯 BBP	邻苯二甲酸二异丁酯 DIBP	Br	Cl	测试报告编号 Test Report NO.	TestLab 测试机构 名称	测试报告日期	测试报告有效期	RoHS Report RoHS报告
1	弹片	SUS 304	ND	ND	ND	ND	ND	ND	ND	ND	ND	ND	NA	NA	SXPEC23000381402	SGS	2023/3/29	2024/3/27	
2	双频同轴线	同轴线-镀锡铜线	ND	ND	ND	ND	ND	ND	ND	ND	ND	ND	ND	ND	A2230496550101001C	SGS	2023/9/26	2024/9/24	
		同轴线-护套/绝缘	ND	ND	ND	ND	ND	ND	ND	ND	ND	ND	ND	ND	NCBME23000169902	SGS	2023/2/6	2024/2/5	
		同轴线-色母(白色)	ND	ND	ND	ND	ND	ND	ND	ND	ND	ND	ND	ND	A2230222421101002C	CTI	2023/5/23	2024/5/21	
3	RF端子	C5210	ND	ND	ND	ND	ND	ND	ND	ND	ND	ND	ND	ND	CANEC2301145810	SGS	2023/2/8	2024/2/7	
		PBT	ND	ND	ND	ND	ND	ND	ND	ND	ND	ND	ND	ND	ETR23C1966	SGS	2023/12/19	2024/12/17	
		镀镍	ND	ND	ND	ND	ND	ND	ND	ND	ND	ND	ND	NA	CANEC23007797304	SGS	2023/8/17	2024/8/15	
4	支撑泡棉	镀金	ND	ND	ND	ND	ND	ND	ND	ND	ND	ND	NA	NA	CANEC23007797302	SGS	2023/8/17	2024/8/15	
		EVA泡棉	ND	ND	ND	ND	ND	ND	ND	ND	ND	ND	ND	NA	WTF23H04088525C	SGS	2023/4/27	2024/4/25	
5	固定背胶	9495	ND	ND	ND	ND	ND	ND	ND	ND	ND	ND	ND	164	CANEC2227657305 CANEC2227657306	SGS	2023/5/30	2024/5/28	
		RP45	ND	ND	ND	ND	ND	ND	ND	ND	ND	ND	ND	ND	CANEC23000474501_1 CANEC23000474502_1	SGS	2023/4/10	2024/4/8	

ANTENNA SPECIFICATION

CUS P/N :AKATW03 WIFI-6 天线_WIFI-1 天线组件 Application Date:Jan,31,2024
ZTX P/N : AKATW03 WIFI-6 天线_WIFI-1 天线组件 Editor:

Rev: R:A1
Page 15 of 15

禁用物质保证 (Certification of Restricted substance)

我方保证所提供的物料，完全遵守签核的广州视源电子科技有限公司/或其子公司的质量和环保协议中的各项条款，物料中禁用物含量，符合最新版《有害物质管理规范》中的各项标准。

we hereby certify that all the Material fully conform to the requirements of the ShiYuan/or its affiliated companies Declaration of conformity that had been signed, and the maximum concentration value of restricted substance in Materials comply with the latest 《Regulations on the management of hazardous substances》.

