

FCC AND ISED CERTIFICATION TEST REPORT

Applicant:	Guangzhou Shikun Electronics Co., Ltd
Address:	NO.6 Liankun Road, Huangpu District, Guangzhou, China
Manufacturer:	Guangzhou Shikun Electronics Co., Ltd
Address:	NO.6 Liankun Road, Huangpu District, Guangzhou, China
Product Description:	IEEE802.11a/b/g/n/ac 2T2R USB Wi-Fi Module Integrated Bluetooth 2.1/3.0/4.2/5.0
Brand Name:	NA
Tested Model:	SKI.WB822CU.2
FCC ID:	2AR82-SKIWB822CU2
IC:	24728-SKIWB822CU2
Report No.:	JCF240223021-003
Received Date:	Feb. 23, 2024
Tested Date:	Feb. 23, 2024 ~ Mar. 22, 2024
Issued Date:	Mar. 22, 2024
Test Standards:	FCC Rules and Regulations Part 15 Subpart C, RSS-247 Issue 3 August 2023
Test Procedure:	ANSI C63.10:2013, RSS-Gen Issue 5 A2, Feb. 2021
Test Result:	Pass
Prepared By:	
 <u>Roger Li/Engineer</u>	
Date: Mar. 22, 2024	
Reviewed By:	
 <u>Kennys Zhang/Engineer</u>	
Date: Mar. 22, 2024	
	
Approved By:	
 <u>Talent Zhang/Engineer</u>	
Date: Mar. 22, 2024	

Note: The test results in this report apply exclusively to the tested model / sample. Without written approval of Guangzhou Jingce Testing Technology Co., Ltd. the test report shall not be reproduced except in full.

Report Revise Record

Report Version	Revise Time	Issued Date	Valid Version	Notes
V1.0	/	Mar. 22, 2024	Original Report	/

Table of Contents

1. Test Report Declare	4
2. Summary of Test Results	5
3. Test Laboratory	5
4. Equipment Under Test	6
4.1. Description of EUT	6
4.2. Channel List	6
4.3. Test Channel Configuration	7
4.4. Test environment conditions	7
4.5. Description of Available Antennas	7
4.6. Description of Available Antennas	8
5. Description of Test Setup	8
5.1. Accessory	8
5.2. Support Equipment	8
5.3. Test Setup	8
5.4. Setup Diagram for Tests	8
6. Measurement Uncertainty	8
7. Measuring Instrument and Software Used	9
8. Conducted Output Power	11
8.1. Block diagram of test setup	11
8.2. Limits	11
8.3. Test Procedure	11
8.4. Results	11
9. Radiated Emission	13
9.1. Block diagram of test setup	13
9.2. Limit	14
9.3. Test Procedure	15
9.4. Results	17
9.5. Original test data	17
10. Antenna Requirements	18
10.1. Applicable Requirements	18
10.2. Result	18
APPENDIX A – Radiated Emission Below 1GHz Test Data	19
APPENDIX B – Radiated Emission Above 1GHz Test Data	21

1. Test Report Declare

Applicant:	Guangzhou Shikun Electronics Co., Ltd
Address:	NO.6 Liankun Road, Huangpu District, Guangzhou, China
Manufacturer:	Guangzhou Shikun Electronics Co., Ltd
Address:	NO.6 Liankun Road, Huangpu District, Guangzhou, China
Product Name:	IEEE802.11a/b/g/n/ac 2T2R USB Wi-Fi Module Integrated Bluetooth 2.1/3.0/4.2/5.0
Brand Name:	NA
Model Name:	SKI.WB822CU.2
Difference Description:	NA

We Declare:

The equipment described above is tested by Guangzhou Jingce Testing Technology Co., Ltd. and in the configuration tested the equipment complied with the standards specified above. The test results are contained in this test report and Guangzhou Jingce Testing Technology Co., Ltd. is assumed of full responsibility for the accuracy and completeness of these tests except as provided information by clients.

2. Summary of Test Results

Summary of Test Results			
Clause	Test Items	FCC/ISED Rules	Test Results
1	6dB Bandwidth and 99 % Occupied Bandwidth	FCC Part 15.247 (a) (2) RSS-247 Clause 5.2 (a) ISED RSS-Gen Clause 6.7	NA
2	Peak Conducted Output Power	FCC Part 15.247 (b) (3) RSS-247 Clause 5.4 (d)	Pass
3	Power Spectral Density	FCC Part 15.247 (e) RSS-247 Clause 5.2 (b)	NA
4	Conducted Bandedge and Spurious Emission	FCC Part 15.247 (d) RSS-247 Clause 5.5	NA
5	Radiated Bandedge and Spurious Emission	FCC Part 15.247 (d) FCC Part 15.209 FCC Part 15.205 RSS-247 Clause 5.5 RSS-GEN Clause 8.9	Pass
6	Conducted Emission Test For AC Power Port	FCC Part 15.207 RSS-GEN Clause 8.8	NA
7	Antenna Requirement	FCC Part 15.203 RSS-GEN Clause 6.8	Pass

Note: The EUT has only added antenna to the original report. So above test items except clause 2&5&7 need to be retest, the other test items reference report "ESTE-R2112274" and "ESTE-R2112280"

3. Test Laboratory

Guangzhou Jingce Testing Technology Co., Ltd.

Add.: No.192, Kezhu Road, Huangpu District, Guangzhou, Guangdong, China

Association for Laboratory Accreditation(A2LA). Certificate Number: 6594.01

FCC Designation Number: CN1331. Test Firm Registration Number: 360543

IC Test Firm Registration Number: 28796

Conformity Assessment Body identifier: CN0138

4. Equipment Under Test

4.1. Description of EUT

EUT Name:	IEEE802.11a/b/g/n/ac 2T2R USB Wi-Fi Module Integrated Bluetooth 2.1/3.0/4.2/5.0
Model Number:	SKI.WB822CU.2
EUT Function Description:	Please refer to usual manual
Power Supply:	DC 3.3V+/-0.3
Hardware Version:	NA
Software Version:	NA
Radio Specification:	IEEE802.11b/g/n
Operation Frequency:	IEEE 802.11b: 2412MHz—2462MHz IEEE 802.11g: 2412MHz—2462MHz IEEE 802.11n HT20: 2412MHz—2462MHz IEEE 802.11n HT40: 2422MHz—2452MHz
Modulation:	IEEE 802.11b: DSSS (CCK, DQPSK, DBPSK) IEEE 802.11g: OFDM (64QAM, 16QAM, QPSK, BPSK) IEEE 802.11n (HT20/40): OFDM (64QAM, 16QAM, QPSK, BPSK)
Data Rate:	IEEE 802.11b: 1, 2, 5.5, 11 Mbps IEEE 802.11g: 6, 9, 12, 18, 24, 36, 48, 54 Mbps IEEE 802.11n HT20: 14.4, 28.9, 43.3, 57.8, 86.7, 115.6, 130.0, 144.4Mbps IEEE 802.11n HT40: 30.0, 60.0, 90.0, 120.0, 180.0, 240.0, 270.0, 300.0 Mbps
Antenna Type:	Shrapnel Antenna, MAX. Gain: 4.58 dBi

Antenna Information		
Ant No.	Antenna Type	Gain(dBi)
1	Shrapnel	3.17
2	Shrapnel	3.37
3	Shrapnel	3.99
4	Shrapnel	4.58

Note 1: EUT is the ab. of equipment under test.

Note 2: The antenna gain is declared by the customer and the laboratory is not responsible for the accuracy of the antenna gain.

4.2. Channel List

Channel List for 802.11b/g/n (20 MHz)							
Channel	Frequency (MHz)	Channel	Frequency (MHz)	Channel	Frequency (MHz)	Channel	Frequency (MHz)
1	2412	4	2427	7	2442	10	2457
2	2417	5	2432	8	2447	11	2462
3	2422	6	2437	9	2452	/	/

Channel List for 802.11n (40 MHz)					
Channel	Frequency (MHz)	Channel	Frequency(MHz)	Channel	Frequency (MHz)
3	2422	6	2437	9	2452
4	2427	7	2442	/	/

5	2432	8	2447	/	/
---	------	---	------	---	---

4.3. Test Channel Configuration

Tested mode, channel and rand data rate information			
Mode	Data rate (Mbps) (see Note)	Channel	Frequency (MHz)
802.11b	1	Low: CH1	2412
	1	Middle: CH6	2437
	1	High: CH11	2462
802.11g	6	Low: CH1	2412
	6	Middle: CH6	2437
	6	High: CH11	2462
802.11n HT20	MCS 8	Low: CH1	2412
	MCS 8	Middle: CH6	2437
	MCS 8	High: CH11	2462
802.11n HT40	MCS 8	Low: CH3	2422
	MCS 8	Middle: CH6	2437
	MCS 8	High: CH9	2452

Note: According exploratory test, EUT will have maximum output power in those data rate, so those data rate were used for all test.

4.4. Test environment conditions

During the measurement the environmental conditions were within the listed ranges:

Temperature range:	21-25 °C
Humidity range:	40-75%
Pressure range:	86-106 kPa

4.5. Description of Available Antennas

The Worst Case Power Setting Parameter under 2400 ~ 2483.5MHz Band				
Test Software		MP Tool		
Modulation Mode	Transmit Antenna Number	Test Software Setting Value		
		Channel	ANT1	ANT2
802.11b	2	CH1	Default	Default
		CH6	Default	Default
		CH11	Default	Default
802.11g	2	CH1	Default	Default
		CH6	Default	Default
		CH11	Default	Default
802.11HT20	2	CH1	Default	Default
		CH6	Default	Default
		CH11	Default	Default
802.11n HT40	2	CH3	Default	Default
		CH6	Default	Default

		CH9	Default	Default
--	--	-----	---------	---------

4.6. Description of Available Antennas

Test Mode	Transmit and Receive Mode	Description
802.11b	<input checked="" type="checkbox"/> 2TX, 2RX	ANT 1 and ANT2 can be used as transmitting/receiving antenna.
802.11g	<input checked="" type="checkbox"/> 2TX, 2RX	ANT 1 and ANT2 can be used as transmitting/receiving antenna.
802.11n HT20	<input checked="" type="checkbox"/> 2TX, 2RX	ANT 1 and ANT2 can be used as transmitting/receiving antenna.
802.11n HT40	<input checked="" type="checkbox"/> 2TX, 2RX	ANT 1 and ANT2 can be used as transmitting/receiving antenna.
Note: 1. Only 802.11n HT20/HT40 support MIMO mode 2. WLAN 2.4 GHz & WLAN 5G can't transmit simultaneously. (declared by client)		

5. Description of Test Setup

5.1. Accessory

Description of Accessories	Manufacturer	Model Number	Description	Remark
/	/	/	/	/

5.2. Support Equipment

Equipment	Brand Name	Model Name	P/N
PC	Lenovo	T480	/

5.3. Test Setup

The EUT can work in Fixed Frequency mode.

5.4. Setup Diagram for Tests



6. Measurement Uncertainty

Where relevant, the following measurement uncertainty levels have been estimated for tests performed on the apparatus:

Test Item	Uncertainty
AC Power Conduction emission	1.37 dB
All Radiated emissions	5.4dB
Conducted emissions	3.09 dB
Occupied Channel Bandwidth	1.1%
Conducted Output power	0.82dB
Power Spectral Density	0.82dB

Note: This uncertainty represents an expanded uncertainty expressed at approximately the 95 % confidence level using a coverage factor of $k = 2$.

7. Measuring Instrument and Software Used

TS Test System						
Used	Equipment	Manufacturer	Model No.	Serial No.	Last Cal.	Due. Date
<input checked="" type="checkbox"/>	Spectrum Analyzer	Keysight	N9030B	MY56320512	Sep. 12, 2023	Sep. 11, 2024
<input checked="" type="checkbox"/>	Vector Signal Generator	Keysight	N5182B	MY57300334	Sep. 12, 2023	Sep. 11, 2024
<input checked="" type="checkbox"/>	Signal Generator	Keysight	N5171B	MY57280639	Sep. 12, 2023	Sep. 11, 2024
<input checked="" type="checkbox"/>	DC POWER	Keysight	E342A	MY59020356	Jul. 14, 2023	Jul. 13, 2024
<input checked="" type="checkbox"/>	Incubator thermometer	GWS	EL-02JA	21107288	Sep. 12, 2023	Sep. 11, 2024
<input checked="" type="checkbox"/>	Control unit(Power sensor)	Tonscend	JS0806-2	/	Sep. 12, 2023	Sep. 11, 2024
<input checked="" type="checkbox"/>	Wideband radio communication tester	R&S	CMW500	163478	Jul. 11, 2023	Jul. 10, 2024
<input checked="" type="checkbox"/>	Spectrum Analyzer	Keysight	N9020B	MY60112206	Sep. 12, 2023	Sep. 12, 2024
<input checked="" type="checkbox"/>	Control unit(Power sensor)	Tonscend	JS0806-2	21H8060465	Sep. 12, 2023	Sep. 12, 2024
Software						
Used	Description	Manufacturer	Name	Version		
<input checked="" type="checkbox"/>	Test software	Tonscend	JS1120-3	V3.3.10		
RSE Test System						
Used	Equipment	Manufacturer	Model No.	Serial No.	Last Cal.	Due. Date
<input checked="" type="checkbox"/>	EMI Receiver	R&S	ESW	101685	Jul. 12, 2023	Jul. 11, 2024
<input checked="" type="checkbox"/>	Bilog Antenna	Schwarzbeck	VULB 9163	01361	Aug. 16, 2023	Aug. 15, 2024
<input checked="" type="checkbox"/>	Horn Antenna 1	Schwarzbeck	BBHA 9120 D	02411	May. 25, 2023	May. 24, 2024
<input checked="" type="checkbox"/>	Horn Antenna 2	ETS	BBHA 9170	1090	Sep. 04, 2023	Sep. 03, 2024
<input checked="" type="checkbox"/>	loop-antenna	Schwarzbeck	FMZB 1513-60	00030	Jan.14,2024	Jan. 13, 2025
<input checked="" type="checkbox"/>	Signal Pre-Amplifier	Tonscend	TAP01018050	AP21C806122	Jul. 10, 2023	Jul. 09, 2024
<input checked="" type="checkbox"/>	Signal Pre-Amplifier	Tonscend	TAP9K3G32	AP20K806104	Jul. 10, 2023	Jul. 09, 2024
<input checked="" type="checkbox"/>	Signal Pre-Amplifier	ETS	3116C-PA	00217677	Aug. 24, 2023	Aug. 23, 2024
<input checked="" type="checkbox"/>	3m Fully-anechoic Chamber	ETS	RFD-100	/	Apr. 24, 2021	Apr. 23, 2024
Software						
Used	Description	Manufacturer	Name	Version		
<input checked="" type="checkbox"/>	Test software	Tonscend	TS+	V3.0.0.4		
Conducted Emission Test For AC Power Port						
Used	Equipment	Manufacturer	Model No.	Serial No.	Last Cal.	Due. Date
<input checked="" type="checkbox"/>	LISN	R&S	ENV216	102154	Jul. 10, 2023	Jul. 09, 2024

<input checked="" type="checkbox"/>	EMI Receiver	R&S	ESR3	102509	Jul. 12, 2023	Jul. 11, 2024
Software						
Used	Description	Manufacturer	Name		Version	
<input checked="" type="checkbox"/>	Test software	EZ	EZ-EMC		EMEC-3A1	
Other Instrument						
Used	Equipment	Manufacturer	Model No.	Serial No.	Last Cal.	Due. Date
<input checked="" type="checkbox"/>	Temperature & Humidity	Temperature	HTC-1	/	Nov. 02, 2023	Nov. 01, 2024

8. Conducted Output Power

8.1. Block diagram of test setup

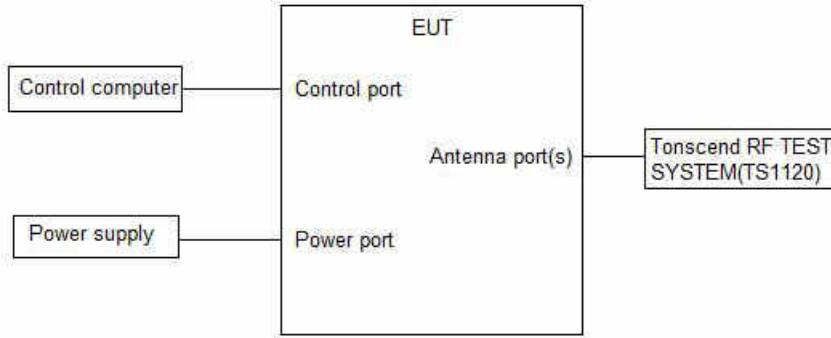

8.2. Limits

CFR 47 FCC Part15 (15.247) Subpart C ISED RSS-247 ISSUE 3			
Section	Test Item	Limit	Frequency Range (MHz)
CFR 47 FCC 15.247(b)(3) ISED RSS-247 5.4 (d)	Peak Output Power	1 watt or 30 dBm	2400-2483.5

8.3. Test Procedure

Place the EUT on the table and set it in the transmitting mode.

Remove the antenna from the EUT and then connect a low loss RF cable from the antenna port to the Power sensor.

Measure peak power each channel.

Peak Detector use for Peak result.

AVG Detector use for AVG result.

8.4. Results

Test Mode	Ant.	Freq. (MHz)	Peak Power (dBm)	Conducted Limit (dBm)	EIRP (dBm)	EIRP Limit (dBm)	Verdict
11B	Ant1	2412	11.39	≤30.00	15.97	≤36.00	PASS
	Ant2	2412	11.30	≤30.00	15.88	≤36.00	PASS
	Ant1	2437	11.82	≤30.00	16.4	≤36.00	PASS
	Ant2	2437	12.00	≤30.00	16.58	≤36.00	PASS
	Ant1	2462	11.72	≤30.00	16.3	≤36.00	PASS
	Ant2	2462	11.88	≤30.00	16.46	≤36.00	PASS
11G	Ant1	2412	17.31	≤30.00	21.89	≤36.00	PASS
	Ant2	2412	17.17	≤30.00	21.75	≤36.00	PASS
	Ant1	2437	17.01	≤30.00	21.59	≤36.00	PASS
	Ant2	2437	16.73	≤30.00	21.31	≤36.00	PASS
	Ant1	2462	16.74	≤30.00	21.32	≤36.00	PASS
	Ant2	2462	16.48	≤30.00	21.06	≤36.00	PASS
11N20MIMO	Ant1	2412	15.00	≤30.00	19.58	≤36.00	PASS
	Ant2	2412	14.27	≤30.00	18.85	≤36.00	PASS
	total	2412	17.66	≤30.00	22.24	≤36.00	PASS
	Ant1	2437	14.68	≤30.00	19.26	≤36.00	PASS
	Ant2	2437	13.99	≤30.00	18.57	≤36.00	PASS
	total	2437	17.36	≤30.00	21.94	≤36.00	PASS
	Ant1	2462	14.45	≤30.00	19.03	≤36.00	PASS

	Ant2	2462	13.80	≤30.00	18.38	≤36.00	PASS
	total	2462	17.15	≤30.00	21.73	≤36.00	PASS
11N40MIMO	Ant1	2422	15.55	≤30.00	20.13	≤36.00	PASS
	Ant2	2422	15.53	≤30.00	20.11	≤36.00	PASS
	total	2422	18.55	≤30.00	23.13	≤36.00	PASS
	Ant1	2437	15.61	≤30.00	20.19	≤36.00	PASS
	Ant2	2437	15.43	≤30.00	20.01	≤36.00	PASS
	total	2437	18.53	≤30.00	23.11	≤36.00	PASS
	Ant1	2452	15.29	≤30.00	19.87	≤36.00	PASS
	Ant2	2452	14.96	≤30.00	19.54	≤36.00	PASS
	total	2452	18.14	≤30.00	22.72	≤36.00	PASS

The Conducted Power reference report "ESTE-R2112274 " and "ESTE-R2112280"

9. Radiated Emission

9.1. Block diagram of test setup

In 3 m Anechoic Chamber, test setup diagram for 9 kHz - 30 MHz:

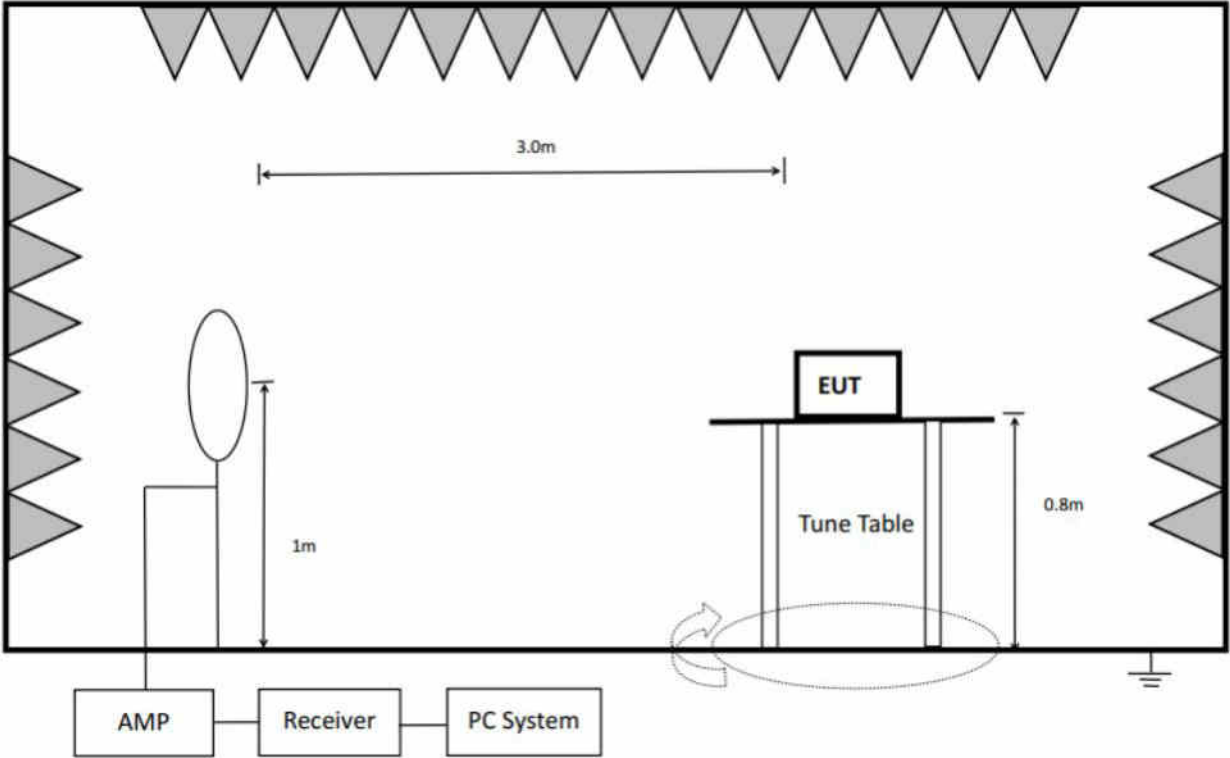

In 3 m Anechoic Chamber, test setup diagram for 30 MHz - 1 GHz:

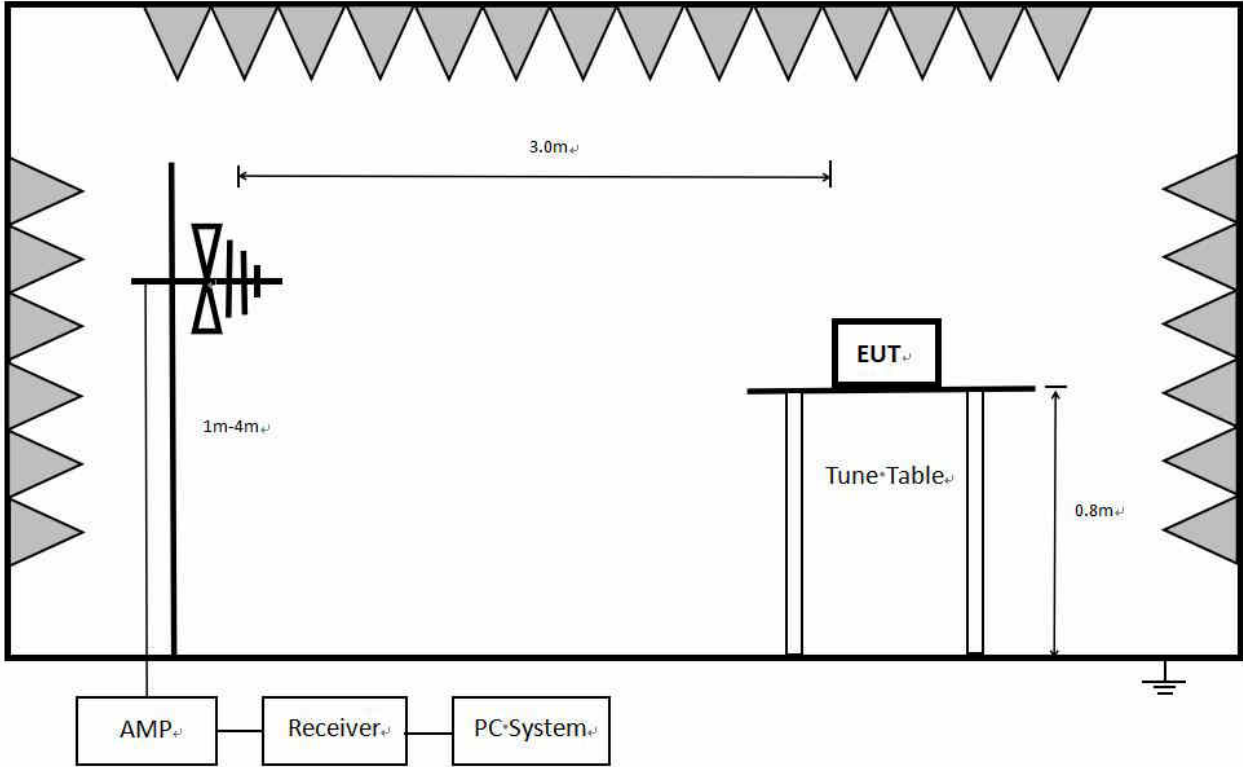

In 3 m Anechoic Chamber, test setup diagram for frequency above 1 GHz:

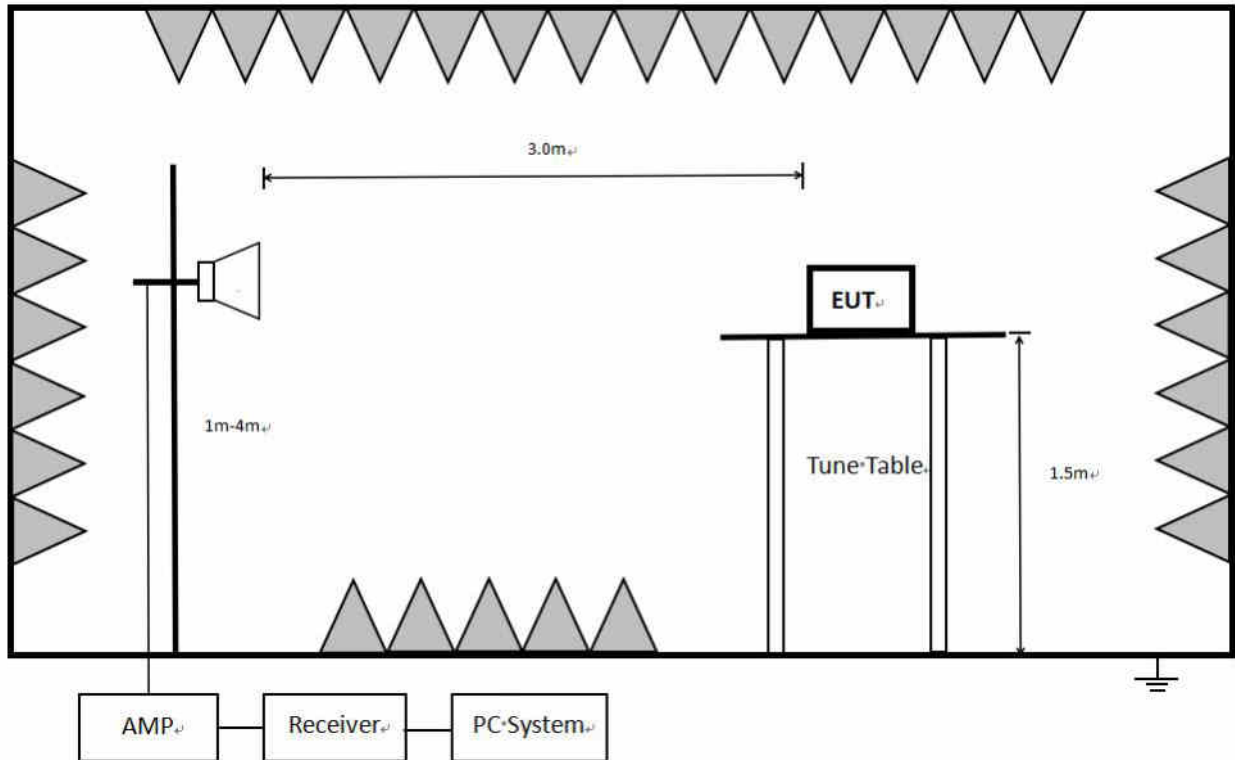

Note: For harmonic emissions test an appropriate high pass filter was inserted in the input port of AMP.

9.2. Limit

(1) FCC 15.205 Restricted frequency band

MHz	MHz	MHz	GHz
0.090-0.110	16.42-16.423	399.9-410	4.5-5.15
¹ 0.495-0.505	16.69475-16.69525	608-614	5.35-5.46
2.1735-2.1905	16.80425-16.80475	960-1240	7.25-7.75
4.125-4.128	25.5-25.67	1300-1427	8.025-8.5
4.1772&4.17775	37.5-38.25	1435-1626.5	9.0-9.2
4.2072&4.20775	73-74.6	1645.5-1646.5	9.3-9.5
6.215-6.218	74.8-75.2	1660-1710	10.6-12.7
6.26775-6.26825	108-121.94	1718.8-1722.2	13.25-13.4
6.31175-6.31225	123-138	2200-2300	14.47-14.5
8.291-8.294	149.9-150.05	2310-2390	15.35-16.2
8.362-8.366	156.52475-156.52525	2483.5-2500	17.7-21.4
8.37625-8.38675	156.7-156.9	2690-2900	22.01-23.12
8.41425-8.41475	162.0125-167.17	3260-3267	23.6-24.0
12.29-12.293	167.72-173.2	3332-3339	31.2-31.8
12.51975-12.52025	240-285	3345.8-3358	36.43-36.5
12.57675-12.57725	322-335.4	3600-4400	(²)
13.36-13.41			

¹Until February 1, 1999, this restricted band shall be 0.490-0.510 MHz.

²Above 38.6

(2) FCC 15.209 Limit.

Frequency MHz	Distance Meters	Field Strengths Limit	
		$\mu\text{V}/\text{m}$	$\text{dB}(\mu\text{V})/\text{m}$
0.009 ~ 0.490	300	2400/F(kHz)	67.6-20log(F)
0.490 ~ 1.705	30	24000/F(kHz)	87.6-20log(F)
1.705 ~ 30.0	30	30	29.54
30 ~ 88	3	100	40.0
88 ~ 216	3	150	43.5
216~960	3	200	46.0
960~1000	3	500	54.0
Above 1000	3	74.0 dB(μV)/m (Peak) 54.0 dB(μV)/m (Average)	

Note: (1) At frequencies at or above 30 MHz, measurements may be performed at a distance other than what is specified provided: measurements are not made in the near field except where it can be shown that near field measurements are appropriate due to the characteristics of the device; and it can be demonstrated that the signal levels needed to be measured at the distance employed can be detected by the measurement equipment. Measurements shall not be performed at a distance greater than 30 meters unless it can be further demonstrated that measurements at a distance of 30 meters or less are impractical. When performing measurements at a distance other than that specified, the results shall be extrapolated to the specified distance using an extrapolation factor of 20 dB/decade (inverse linear-distance for field strength measurements; inverse-linear-distance-squared for power density measurements).

(2) At frequencies below 30 MHz, measurements may be performed at a distance closer than that specified in the regulations; however, an attempt should be made to avoid making measurements in the near field. Pending the development of an appropriate measurement procedure for measurements performed below 30 MHz, when performing measurements at a closer distance than specified, the results shall be extrapolated to the specified distance by either making measurements at a minimum of two distances on at least one radial to determine the proper extrapolation factor or by using the square of an inverse linear distance extrapolation factor (40 dB/decade). This paragraph (f) shall not apply to Access BPL devices operating below 30 MHz.

About Restricted bands of operation please refer to RSS-Gen section 8.10 and FCC § 15.205(a).

9.3. Test Procedure

Below 30 MHz:

The setting of the spectrum Analyzer

RBW	300 Hz (From 9 kHz to 0.15 MHz)/ 10 kHz (From 0.15 MHz to 30 MHz)
VBW	1 kHz (From 9 kHz to 0.15 MHz)/ 30 kHz (From 0.15 MHz to 30 MHz)
Sweep	Auto
Trace	Max hold

1. The testing follows the guidelines in ANSI C63.10-2013

2. The EUT was arranged to its worst case and then turntable (from 0 degree to 360 degrees) to find the maximum reading. A pre-amp and a high pass filter are used for the test in order to get better signal level. Both Horizontal, Face-on and Face-off polarizations of the antenna are set to make the measurement.

3. The EUT was placed on a turntable with 80 cm meter above ground.

4. The EUT was set 3 meters from the interference receiving antenna, which was mounted on the top of 1 meter height antenna tower.

5. The radiated emission limits are based on measurements employing a CISPR quasi-peak detector except for the frequency bands 9-90 kHz, 110-490 kHz and above 1000 MHz. Radiated emission limits in these three bands are based on measurements employing an average detector.

6. For measurement below 1 GHz, the initial step in collecting conducted emission data is a spectrum analyzer peak detector mode pre-scanning the measurement frequency range. Significant peaks are then marked and then Quasi Peak detector mode re-measured. If the emission level of the EUT

measured by the peak detector is 3 dB lower than the applicable limit, the peak emission level will be reported. Otherwise, the emission measurement will be repeated using the quasi-peak detector and reported.

7. Although these tests were performed other than open field site, adequate comparison measurements were confirmed against 30m open field site. Therefore, sufficient tests were made to demonstrate that the alternative site produces results that correlate with the ones of tests made in an open field site based on KDB 414788.

Below 1 GHz and above 30 MHz:

The setting of the spectrum Analyzer

RBW	100 kHz
VBW	300 kHz
Sweep	Auto
Trace	Max hold

1. The testing follows the guidelines in ANSI C63.10-2013.

2. The EUT was arranged to its worst case and then tune the antenna tower (from 1 m to 4 m) and turntable (from 0 degree to 360 degrees) to find the maximum reading. A pre-amp and a high pass filter are used for the test in order to get better signal level. Both horizontal and vertical polarizations of the antenna are set to make the measurement.

3. The EUT was placed on a turntable with 80 cm above ground.

4. The EUT was set 3 meters from the interference receiving antenna, which was mounted on the top of a variable height antenna tower.

5. For measurement below 1GHz, the initial step in collecting conducted emission data is a spectrum analyzer peak detector mode pre-scanning the measurement frequency range. Significant peaks are then marked and then Quasi Peak detector mode re-measured. If the emission level of the EUT measured by the peak detector is 3 dB lower than the applicable limit, the peak emission level will be reported. Otherwise, the emission measurement will be repeated using the quasi-peak detector and reported.

Above 1 GHz:

RBW	1 MHz
VBW	PEAK: 3 MHz AVG: see note 6
Sweep	Auto
Detector	Peak
Trace	Max hold

1. The testing follows the guidelines in ANSI C63.10-2013.

2. The EUT was arranged to its worst case and then tune the antenna tower (from 1 m to 4 m) and turntable (from 0 degree to 360 degrees) to find the maximum reading. A pre-amp and a high pass filter are used for the test in order to get better signal level. Both horizontal and vertical polarizations of the antenna are set to make the measurement.

3. The EUT was placed on a turntable with 1.5m above ground.

4. The EUT was set 3 meters from the interference receiving antenna, which was mounted on the top of a variable height antenna tower.

5. For measurement above 1GHz, the emission measurement will be measured by the peak detector. This peak level, once corrected, must comply with the limit specified in Section 15.209.

6. For measurements above 1 GHz the resolution bandwidth is set to 1 MHz, then the video bandwidth is set to 3 MHz for peak measurements and 1 MHz resolution bandwidth with 1/T video bandwidth with peak detector for AVG measurements. For the Duty Cycle please refer to clause 8.1.ON TIME AND DUTY CYCLE.

7. Restriction band: Investigated frequency range from 2310 MHz to 2430 MHz and 2445 MHz to 2500 MHz, 2310 MHz to 2450 MHz and 2425 MHz to 2500MHz.

All restriction band should comply with 15.209, other emission should be at least 20 dB below the fundamental.

Note 1: For all radiated test, EUT in each of three orthogonal axis emissions had been tested, but only the worst case (X axis) data recorded in the report.

Note 2: The EUT does not support simultaneous transmission.

Note 3: The EUT was fully exercised with external accessories during the test. In the case of multiple accessory external ports, an external accessory shall be connected to one of each type of port.

9.4. Results

Pass. (See below detailed test result)

All the emissions except fundamental emission from 9 kHz to 25 GHz were comply with 15.209 limits.

Note1: According exploratory test, the emission levels are 20 dB below the limit detected from 9 kHz to 30 MHz, so the final test was performed with frequency range from 30 MHz to 26 GHz and recorded in below.

Note2: For emissions below 1 GHz, according exploratory explorer test, when change Tx mode and channel, have no distinct influence on emissions level, so for emissions below 1 GHz, the final test was only performed with EUT working in 11n HT40, Tx CH03 mode.

Note3: For emissions above 1 GHz. If peak results comply with AV limit, AV Result is deemed to comply with AV limit.

9.5. Original test data

Below 1 GHz and above 30 MHz test data Refer to appendix A

Above 1 GHz test data Refer to appendix B

10. Antenna Requirements

10.1. Applicable Requirements

Please refer to FCC §15.203

An intentional radiator shall be designed to ensure that no antenna other than that furnished by the responsible party shall be used with the device. The use of a permanently attached antenna or of an antenna that uses a unique coupling to the intentional radiator shall be considered sufficient to comply with the provisions of this section. The manufacturer may design the unit so that a broken antenna can be replaced by the user, but the use of a standard antenna jack or electrical connector is prohibited.

Please refer to FCC §15.247(b)(4)

The conducted output power limit specified in paragraph (b) of this section is based on the use of antennas with directional gains that do not exceed 6 dBi. Except as shown in paragraph (c) of this section, if transmitting antennas of directional gain greater than 6 dBi are used, the conducted output power from the intentional radiator shall be reduced below the stated values in paragraphs (b)(1), (b)(2), and (b)(3) of this section, as appropriate, by the amount in dB that the directional gain of the antenna exceeds 6 dBi.

10.2. Result

The antenna used for this product is Shrapnel antenna and that no antenna other than that furnished by the responsible party shall be used with the device, the maximum peak gain of the transmit antenna is 4.58 dBi

APPENDIX A – Radiated Emission Below 1GHz Test Data

Test Report

Project Information			
EUT:	Wi-Fi Module Integrated Bluetooth	Environment:	22.9°C 46%
Model:	SKI.WB822CU.2	SN:	
Mode:	11N40_2422	Voltage:	DC 3.3V
Customer:		Engineer:	Soho Liu
Remark:			

Start of Test: 2024-03-16 10:46:44

Test Graph

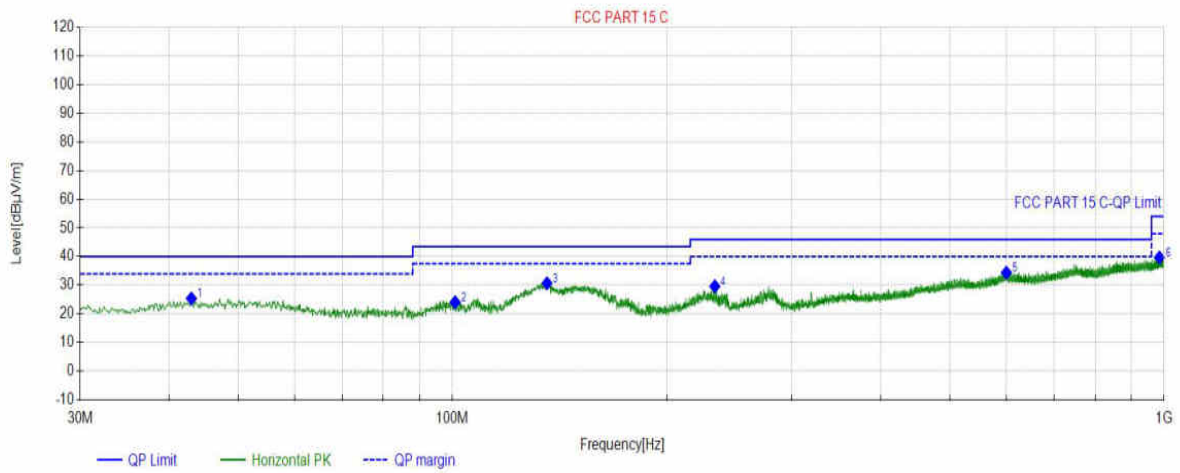

Final Data List								
NO.	Freq. (MHz)	Factor (dB)	QP Value (dBµV/m)	QP Limit (dBµV/m)	Margin (dB)	Height (cm)	Angle (°)	Polarity
1	42.9993	21.74	25.39	40.00	14.61	100	300	Horizontal
2	100.9141	20.72	24.09	43.50	19.41	100	191	Horizontal
3	135.8376	17.07	30.68	43.50	12.82	100	256	Horizontal
4	233.8174	20.89	29.60	46.00	16.40	100	218	Horizontal
5	600.6111	30.11	34.38	46.00	11.62	100	1	Horizontal
6	985.2545	35.15	39.67	54.00	14.33	100	7	Horizontal

Test Report

Project Information			
EUT:	Wi-Fi Module Integrated Bluetooth	Environment:	22.9°C 46%
Model:	SKI.WB822CU.2	SN:	
Mode:	11N40_2422	Voltage:	DC 3.3V
Customer:		Engineer:	Soho Liu
Remark:			

Start of Test: 2024-03-16 10:47:28

Test Graph

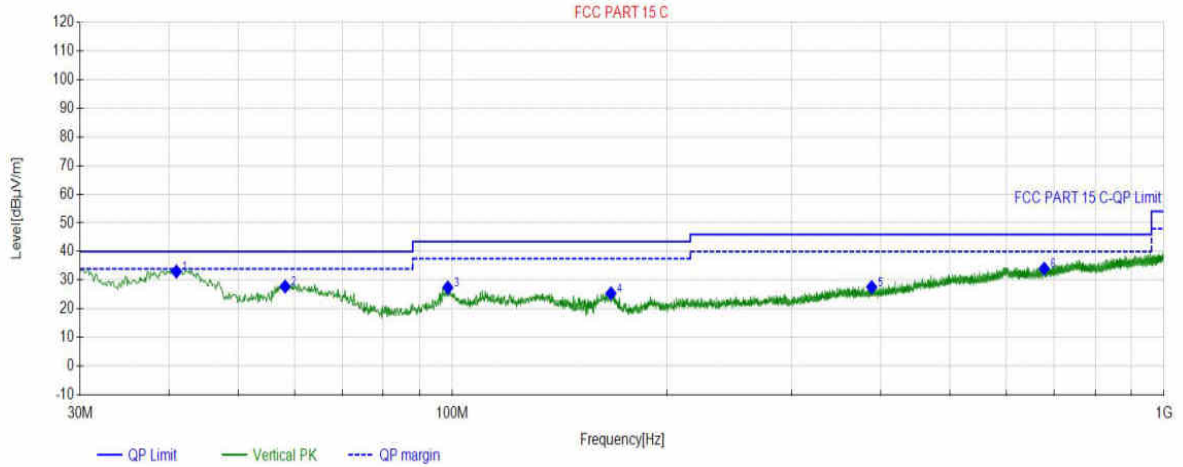

Final Data List

NO.	Freq. (MHz)	Factor (dB)	QP Value (dBµV/m)	QP Limit (dBµV/m)	Margin (dB)	Height (cm)	Angle (°)	Polarity
1	40.9621	21.33	33.03	40.00	6.97	100	169	Vertical
2	58.2298	21.24	27.81	40.00	12.19	100	192	Vertical
3	98.5859	20.44	27.45	43.50	16.05	100	96	Vertical
4	167.0747	17.77	25.43	43.50	18.07	100	140	Vertical
5	388.3538	24.76	27.61	46.00	18.39	100	109	Vertical
6	678.6069	30.48	34.05	46.00	11.95	100	354	Vertical

APPENDIX B – Radiated Emission Above 1GHz Test Data

Test Report

Project Information			
EUT:	Wi-Fi Module Integrated Bluetooth	Environment:	22.9°C 46%
Model:	SKI.WB822CU.2	SN:	
Mode:	11N40_2422	Voltage:	DC 3.3V
Customer:		Engineer:	Soho Liu
Remark:			

Start of Test: 2024-03-16 11:17:05

Test Graph

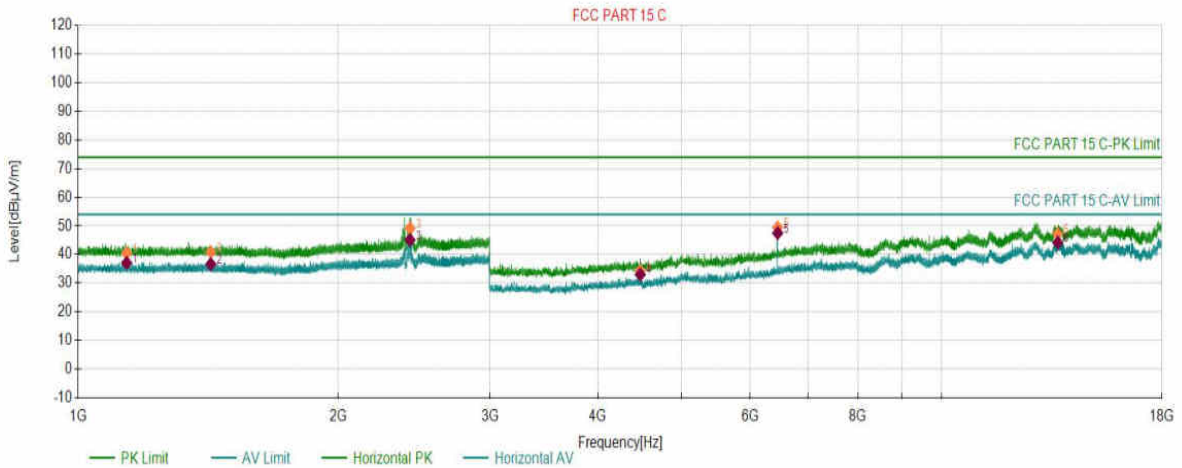

PK Final Data List								
NO.	Freq. (MHz)	Factor (dB)	PK Value (dBµV/m)	PK Limit (dBµV/m)	PK Margin (dB)	Height (cm)	Angle (°)	Polarity
1	1138.1069	1.93	40.53	74.00	33.47	150	252	Horizontal
2	1424.5212	3.29	40.89	74.00	33.11	150	11	Horizontal
3	2423.1712	7.26	49.20	74.00	24.80	150	272	Horizontal
4	4476.8238	-11.33	34.32	74.00	39.68	150	276	Horizontal
5	6458.4229	-4.12	49.50	74.00	24.50	150	341	Horizontal
6	13631.7816	10.51	47.22	74.00	26.78	150	222	Horizontal

AV Final Data List								
NO.	Freq. (MHz)	Factor (dB)	AV Value (dBµV/m)	AV Limit (dBµV/m)	AV Margin (dB)	Height (cm)	Angle (°)	Polarity
1	1138.1069	1.93	37.10	54.00	16.90	150	252	Horizontal
2	1424.5212	3.29	36.67	54.00	17.33	150	11	Horizontal
3	2423.1712	7.26	45.06	54.00	8.94	150	272	Horizontal
4	4476.8238	-11.33	33.00	54.00	21.00	150	276	Horizontal
5	6458.4229	-4.12	47.48	54.00	6.52	150	341	Horizontal
6	13631.7816	10.51	44.20	54.00	9.80	150	222	Horizontal

Test Report

Project Information			
EUT:	Wi-Fi Module Integrated Bluetooth	Environment:	22.9°C 46%
Model:	SKI.WB822CU.2	SN:	
Mode:	11N40_2422	Voltage:	DC 3.3V
Customer:		Engineer:	Soho Liu
Remark:			

Start of Test: 2024-03-16 11:18:47

Test Graph

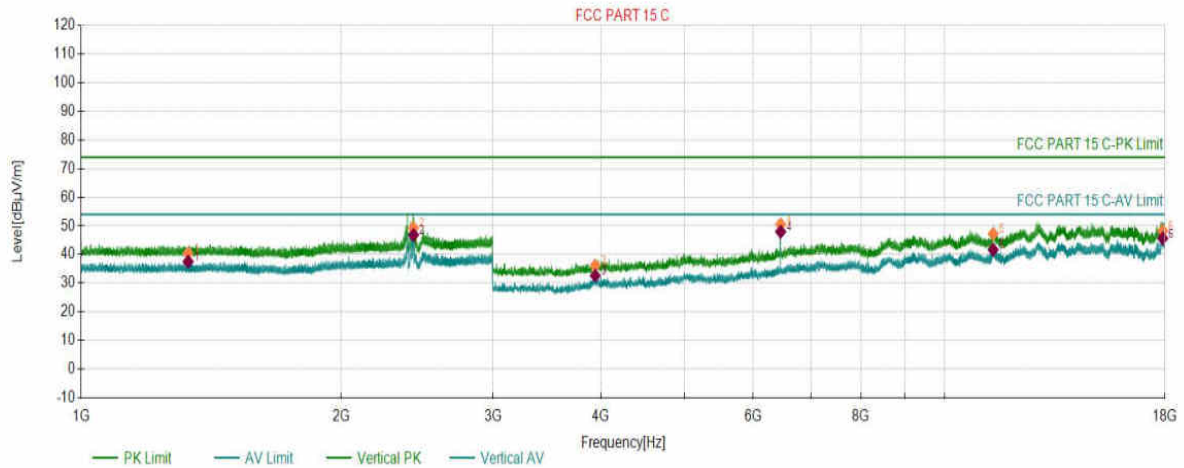

PK Final Data List

NO.	Freq. (MHz)	Factor (dB)	PK Value (dBμV/m)	PK Limit (dBμV/m)	PK Margin (dB)	Height (cm)	Angle (°)	Polarity
1	1330.3165	2.83	40.44	74.00	33.56	150	347	Vertical
2	2426.3713	7.28	49.27	74.00	24.73	150	189	Vertical
3	3938.2969	-13.62	36.16	74.00	37.84	150	114	Vertical
4	6458.4229	-4.12	50.54	74.00	23.46	150	218	Vertical
5	11383.1692	6.20	47.27	74.00	26.73	150	114	Vertical
6	17889.7445	14.48	48.27	74.00	25.73	150	13	Vertical

AV Final Data List

NO.	Freq. (MHz)	Factor (dB)	AV Value (dBμV/m)	AV Limit (dBμV/m)	AV Margin (dB)	Height (cm)	Angle (°)	Polarity
1	1330.3165	2.83	37.52	54.00	16.48	150	347	Vertical
2	2426.3713	7.28	46.81	54.00	7.19	150	189	Vertical
3	3938.2969	-13.62	32.65	54.00	21.35	150	114	Vertical
4	6458.4229	-4.12	47.97	54.00	6.03	150	218	Vertical
5	11383.1692	6.20	41.68	54.00	12.32	150	114	Vertical
6	17889.7445	14.48	45.67	54.00	8.33	150	13	Vertical

Test Report

Project Information			
EUT:	Wi-Fi Module Integrated Bluetooth	Environment:	22.9°C 46%
Model:	SKI.WB822CU.2	SN:	
Mode:	11N40_2437	Voltage:	DC 3.3V
Customer:		Engineer:	Soho Liu
Remark:			

Start of Test: 2024-03-16 11:23:47

Test Graph

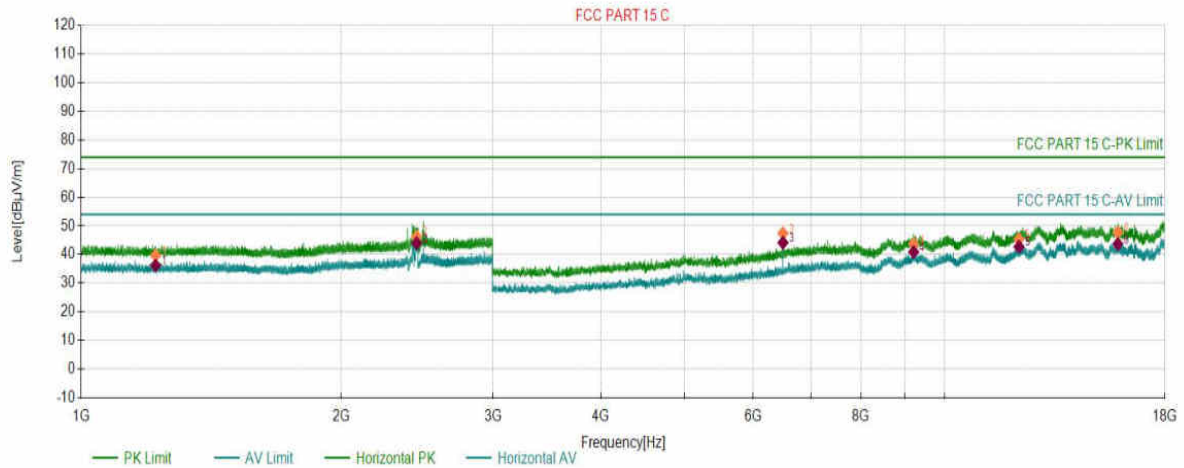

PK Final Data List

NO.	Freq. (MHz)	Factor (dB)	PK Value (dBμV/m)	PK Limit (dBμV/m)	PK Margin (dB)	Height (cm)	Angle (°)	Polarity
1	1219.6110	2.35	39.70	74.00	34.30	150	77	Horizontal
2	2446.5723	7.40	46.29	74.00	27.71	150	284	Horizontal
3	6498.1749	-3.98	47.41	74.00	26.59	150	341	Horizontal
4	9207.3104	3.50	43.66	74.00	30.34	150	2	Horizontal
5	12193.2097	6.66	45.32	74.00	28.68	150	323	Horizontal
6	15873.6437	12.05	47.66	74.00	26.34	150	2	Horizontal

AV Final Data List

NO.	Freq. (MHz)	Factor (dB)	AV Value (dBμV/m)	AV Limit (dBμV/m)	AV Margin (dB)	Height (cm)	Angle (°)	Polarity
1	1219.6110	2.35	36.21	54.00	17.79	150	77	Horizontal
2	2446.5723	7.40	43.96	54.00	10.04	150	284	Horizontal
3	6498.1749	-3.98	44.15	54.00	9.85	150	341	Horizontal
4	9207.3104	3.50	40.90	54.00	13.10	150	2	Horizontal
5	12193.2097	6.66	42.74	54.00	11.26	150	323	Horizontal
6	15873.6437	12.05	43.68	54.00	10.32	150	2	Horizontal

Test Report

Project Information			
EUT:	Wi-Fi Module Integrated Bluetooth	Environment:	22.9°C 46%
Model:	SKI.WB822CU.2	SN:	
Mode:	11N40_2437	Voltage:	DC 3.3V
Customer:		Engineer:	Soho Liu
Remark:			

Start of Test: 2024-03-16 11:25:28

Test Graph

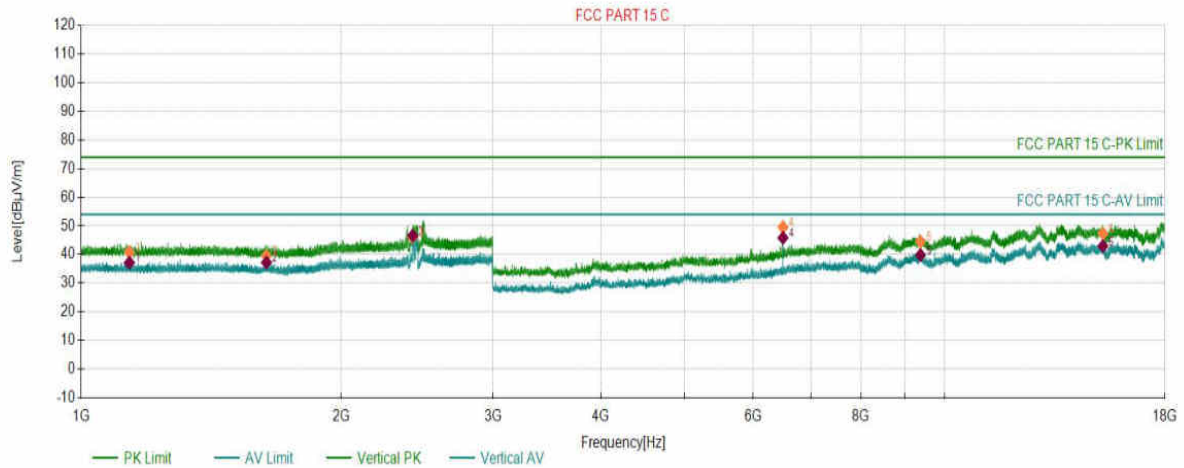

PK Final Data List

NO.	Freq. (MHz)	Factor (dB)	PK Value (dBµV/m)	PK Limit (dBµV/m)	PK Margin (dB)	Height (cm)	Angle (°)	Polarity
1	1137.3069	1.93	40.86	74.00	33.14	150	309	Vertical
2	1639.0320	3.45	39.58	74.00	34.42	150	290	Vertical
3	2421.2711	7.25	46.09	74.00	27.91	150	186	Vertical
4	6498.1749	-3.98	49.59	74.00	24.41	150	302	Vertical
5	9376.8188	3.95	44.50	74.00	29.50	150	30	Vertical
6	15253.3627	11.59	47.37	74.00	26.63	150	302	Vertical

AV Final Data List

NO.	Freq. (MHz)	Factor (dB)	AV Value (dBµV/m)	AV Limit (dBµV/m)	AV Margin (dB)	Height (cm)	Angle (°)	Polarity
1	1137.3069	1.93	37.18	54.00	16.82	150	309	Vertical
2	1639.0320	3.45	37.22	54.00	16.78	150	290	Vertical
3	2421.2711	7.25	46.62	54.00	7.38	150	186	Vertical
4	6498.1749	-3.98	45.85	54.00	8.15	150	302	Vertical
5	9376.8188	3.95	39.86	54.00	14.14	150	30	Vertical
6	15253.3627	11.59	43.00	54.00	11.00	150	302	Vertical

Test Report

Project Information			
EUT:	Wi-Fi Module Integrated Bluetooth	Environment:	22.9°C 46%
Model:	SKI.WB822CU.2	SN:	
Mode:	11N40_2452	Voltage:	DC 3.3V
Customer:		Engineer:	Soho Liu
Remark:			

Start of Test: 2024-03-16 11:29:36

Test Graph

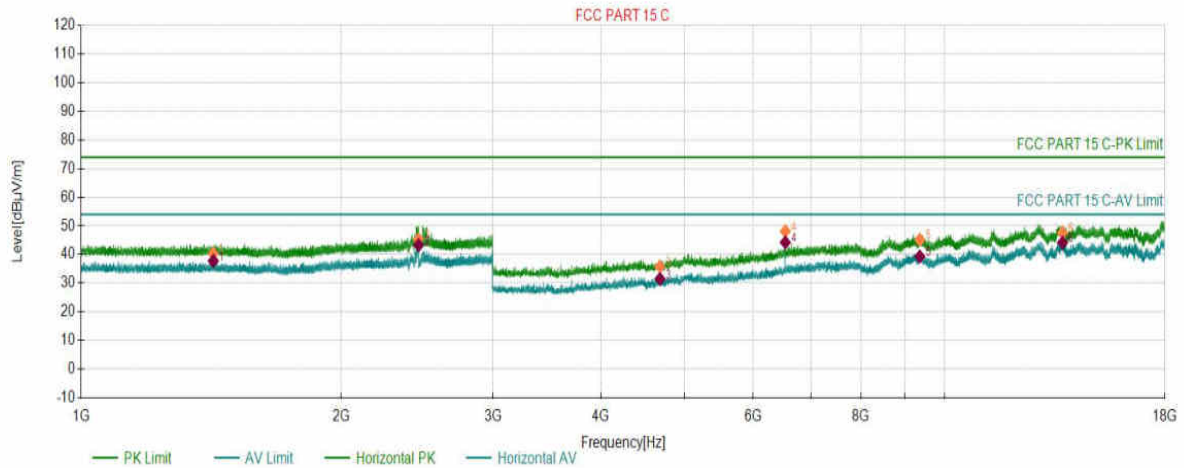

PK Final Data List

NO.	Freq. (MHz)	Factor (dB)	PK Value (dBµV/m)	PK Limit (dBµV/m)	PK Margin (dB)	Height (cm)	Angle (°)	Polarity
1	1422.4211	3.29	40.38	74.00	33.62	150	347	Horizontal
2	2459.2730	7.47	45.38	74.00	28.62	150	206	Horizontal
3	4681.5841	-10.83	35.82	74.00	38.18	150	97	Horizontal
4	6538.6769	-3.70	48.10	74.00	25.90	150	333	Horizontal
5	9358.8179	3.77	45.15	74.00	28.85	150	32	Horizontal
6	13696.2848	10.95	47.61	74.00	26.39	150	358	Horizontal

AV Final Data List

NO.	Freq. (MHz)	Factor (dB)	AV Value (dBµV/m)	AV Limit (dBµV/m)	AV Margin (dB)	Height (cm)	Angle (°)	Polarity
1	1422.4211	3.29	37.77	54.00	16.23	150	347	Horizontal
2	2459.2730	7.47	43.29	54.00	10.71	150	206	Horizontal
3	4681.5841	-10.83	31.52	54.00	22.48	150	97	Horizontal
4	6538.6769	-3.70	44.24	54.00	9.76	150	333	Horizontal
5	9358.8179	3.77	39.31	54.00	14.69	150	32	Horizontal
6	13696.2848	10.95	44.19	54.00	9.81	150	358	Horizontal

Test Report

Project Information			
EUT:	Wi-Fi Module Integrated Bluetooth	Environment:	22.9°C 46%
Model:	SKI.WB822CU.2	SN:	
Mode:	11N40_2452	Voltage:	DC 3.3V
Customer:		Engineer:	Soho Liu
Remark:			

Start of Test: 2024-03-16 11:31:17

Test Graph

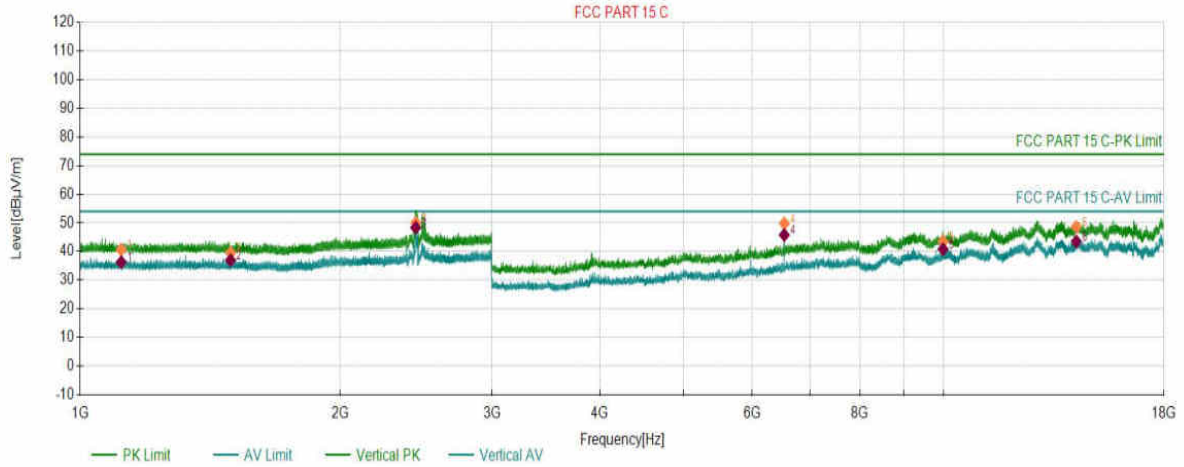

PK Final Data List

NO.	Freq. (MHz)	Factor (dB)	PK Value (dBµV/m)	PK Limit (dBµV/m)	PK Margin (dB)	Height (cm)	Angle (°)	Polarity
1	1115.9058	1.81	40.67	74.00	33.33	150	152	Vertical
2	1493.5247	3.38	39.60	74.00	34.40	150	282	Vertical
3	2447.2724	7.40	50.02	74.00	23.98	150	209	Vertical
4	6538.6769	-3.70	49.83	74.00	24.17	150	259	Vertical
5	9985.0993	4.16	43.52	74.00	30.48	150	222	Vertical
6	14244.5622	10.95	48.60	74.00	25.40	150	201	Vertical

AV Final Data List

NO.	Freq. (MHz)	Factor (dB)	AV Value (dBµV/m)	AV Limit (dBµV/m)	AV Margin (dB)	Height (cm)	Angle (°)	Polarity
1	1115.9058	1.81	36.30	54.00	17.70	150	152	Vertical
2	1493.5247	3.38	36.97	54.00	17.03	150	282	Vertical
3	2447.2724	7.40	48.33	54.00	5.67	150	209	Vertical
4	6538.6769	-3.70	45.80	54.00	8.20	150	259	Vertical
5	9985.0993	4.16	40.81	54.00	13.19	150	222	Vertical
6	14244.5622	10.95	43.51	54.00	10.49	150	201	Vertical

Test Report

Project Information			
EUT:	Wi-Fi Module Integrated Bluetooth	Environment:	23.0°C 43%
Model:	SKI.WB822CU.2	SN:	
Mode:	11B_2412	Voltage:	DC 3.3V
Customer:		Engineer:	Winnie Meng
Remark:			

Start of Test: 2024-02-28 11:13:46

Test Graph

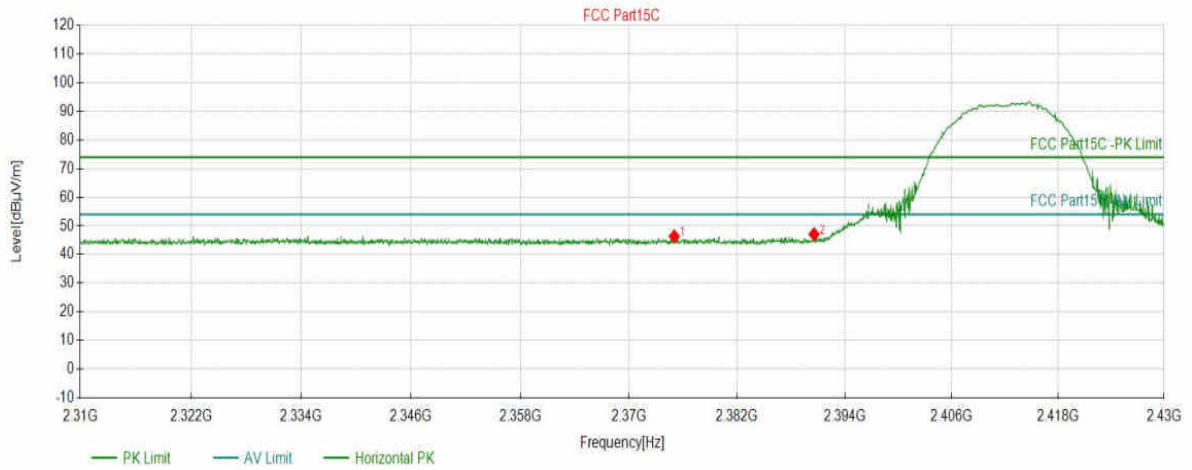

Suspected Data List

NO.	Freq. (MHz)	Level (dBµV/m)	Factor (dB)	Limit (dBµV/m)	Margin (dB)	Height (cm)	Angle (°)	Detector	Polarity
1	2375.0217	46.35	5.66	74.00	27.65	150	356	PK	Horizont
2	2390.5869	47.09	5.65	74.00	26.91	150	313	PK	Horizont

Test Report

Project Information			
EUT:	Wi-Fi Module Integrated Bluetooth	Environment:	23.0°C 43%
Model:	SKI.WB822CU.2	SN:	
Mode:	11B_2412	Voltage:	DC 3.3V
Customer:		Engineer:	Winnie Meng
Remark:			

Start of Test: 2024-02-28 11:14:38

Test Graph

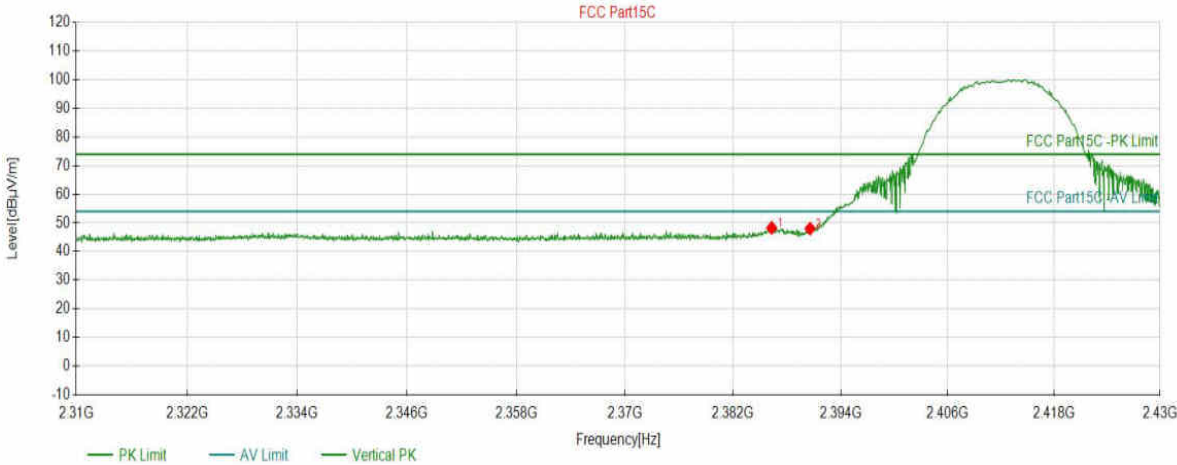

Suspected Data List									
NO.	Freq. (MHz)	Level (dBµV/m)	Factor (dB)	Limit (dBµV/m)	Margin (dB)	Height (cm)	Angle (°)	Detector	Polarity
1	2386.3054	48.26	5.65	74.00	25.74	150	309	PK	Vertical
2	2390.5869	48.01	5.65	74.00	25.99	150	158	PK	Vertical

Test Report

Project Information			
EUT:	Wi-Fi Module Integrated Bluetooth	Environment:	23.0°C 43%
Model:	SKI.WB822CU.2	SN:	
Mode:	11B_2462	Voltage:	DC 3.3V
Customer:		Engineer:	Winnie Meng
Remark:			

Start of Test: 2024-02-28 11:23:26

Test Graph

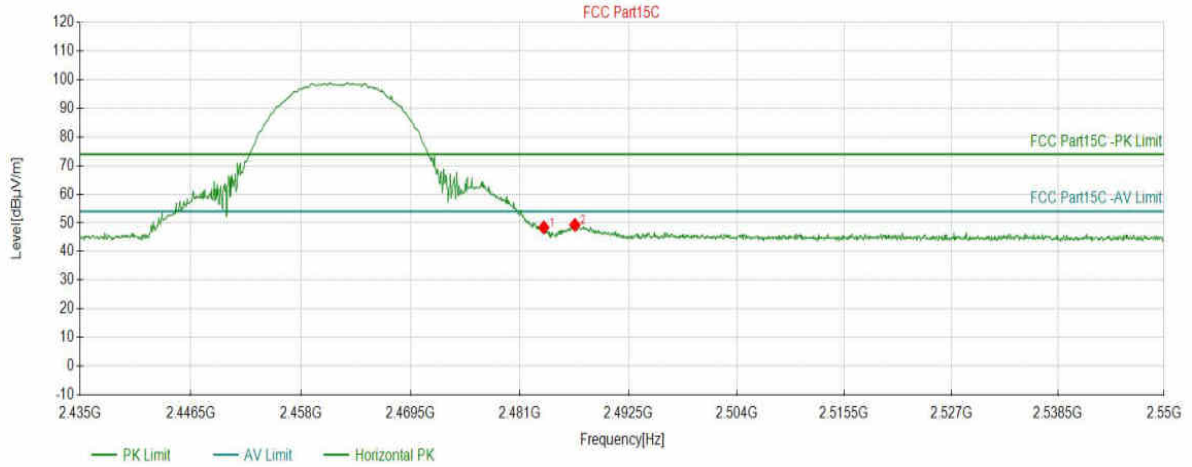

Suspected Data List									
NO.	Freq. (MHz)	Level (dBµV/m)	Factor (dB)	Limit (dBµV/m)	Margin (dB)	Height (cm)	Angle (°)	Detector	Polarity
1	2483.5543	48.41	6.24	74.00	25.59	150	16	PK	Horizont
2	2486.8334	49.30	6.27	74.00	24.70	150	357	PK	Horizont

Test Report

Project Information			
EUT:	Wi-Fi Module Integrated Bluetooth	Environment:	23.0°C 43%
Model:	SKI.WB822CU.2	SN:	
Mode:	11B_2462	Voltage:	DC 3.3V
Customer:		Engineer:	Winnie Meng
Remark:			

Start of Test: 2024-02-28 11:24:14

Test Graph

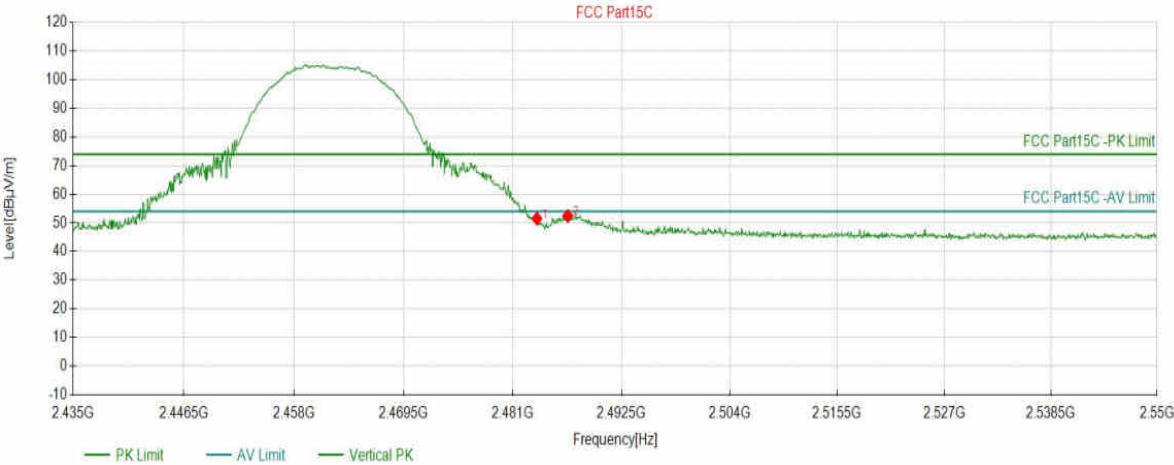

Suspected Data List									
NO.	Freq. (MHz)	Level (dBµV/m)	Factor (dB)	Limit (dBµV/m)	Margin (dB)	Height (cm)	Angle (°)	Detector	Polarity
1	2483.5543	51.51	6.24	74.00	22.49	150	113	PK	Vertical
2	2486.8334	52.40	6.27	74.00	21.60	150	67	PK	Vertical

Test Report

Project Information			
EUT:	Wi-Fi Module Integrated Bluetooth	Environment:	23.0°C 43%
Model:	SKI.WB822CU.2	SN:	
Mode:	11G_2412	Voltage:	DC 3.3V
Customer:		Engineer:	Winnie Meng
Remark:			

Start of Test: 2024-02-28 11:27:12

Test Graph

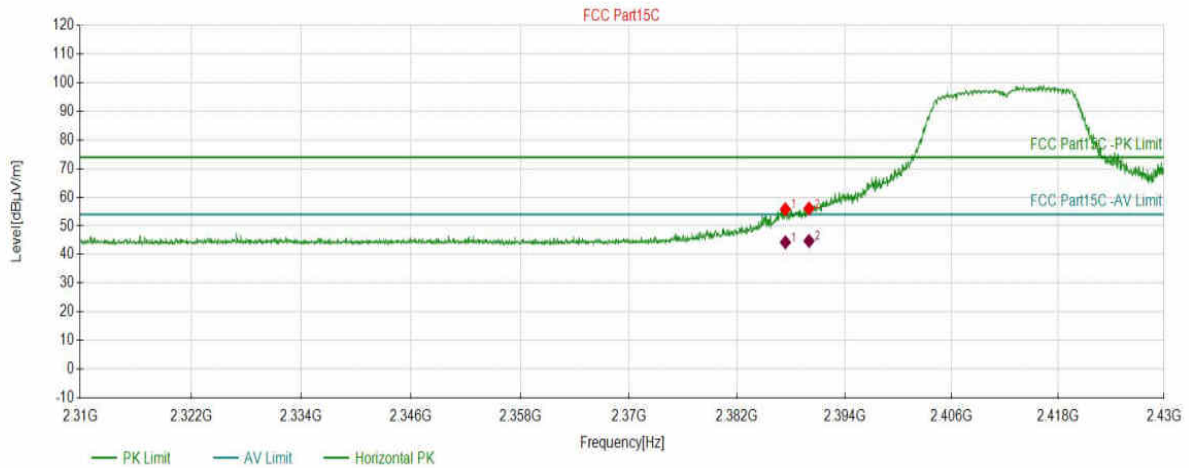

Suspected Data List

NO.	Freq. (MHz)	Level (dBµV/m)	Factor (dB)	Limit (dBµV/m)	Margin (dB)	Height (cm)	Angle (°)	Detector	Polarity
1	2387.3858	55.80	5.65	74.00	18.20	150	70	PK	Horizont
2	2390.0267	56.11	5.65	74.00	17.89	150	128	PK	Horizont

AV Final Data List

NO.	Freq. (MHz)	Factor (dB)	AV Value (dBµV/m)	AV Limit (dBµV/m)	AV Margin (dB)	Height (cm)	Angle (°)	Polarity
1	2387.3858	5.65	44.27	54.00	9.73	150	70	Horizontal
2	2390.0267	5.65	44.75	54.00	9.25	150	128	Horizontal

Test Report

Project Information			
EUT:	Wi-Fi Module Integrated Bluetooth	Environment:	23.0°C 43%
Model:	SKI.WB822CU.2	SN:	
Mode:	11G_2412	Voltage:	DC 3.3V
Customer:		Engineer:	Winnie Meng
Remark:			

Start of Test: 2024-02-28 11:28:12

Test Graph

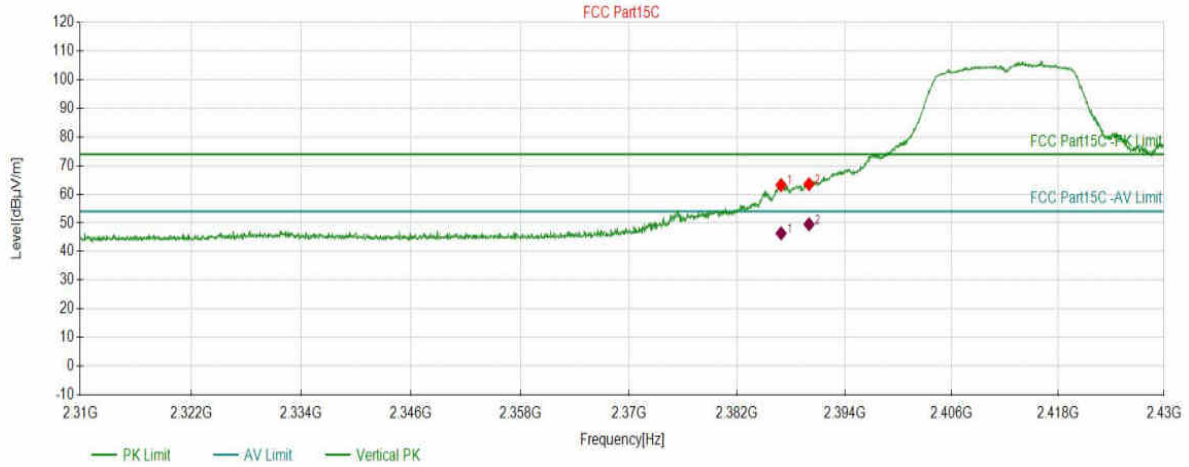

Suspected Data List

NO.	Freq. (MHz)	Level (dBµV/m)	Factor (dB)	Limit (dBµV/m)	Margin (dB)	Height (cm)	Angle (°)	Detector	Polarity
1	2386.9056	63.21	5.65	74.00	10.79	150	350	PK	Vertical
2	2390.0267	63.50	5.65	74.00	10.50	150	323	PK	Vertical

AV Final Data List

NO.	Freq. (MHz)	Factor (dB)	AV Value (dBµV/m)	AV Limit (dBµV/m)	AV Margin (dB)	Height (cm)	Angle (°)	Polarity
1	2386.9054	5.65	46.34	54.00	7.66	150	50.6	Vertical
2	2390.0265	5.65	49.51	54.00	4.49	150	352.7	Vertical

Test Report

Project Information			
EUT:	Wi-Fi Module Integrated Bluetooth	Environment:	23.0°C 43%
Model:	SKI.WB822CU.2	SN:	
Mode:	11G_2462	Voltage:	DC 3.3V
Customer:		Engineer:	Winnie Meng
Remark:			

Start of Test: 2024-02-28 12:06:58

Test Graph

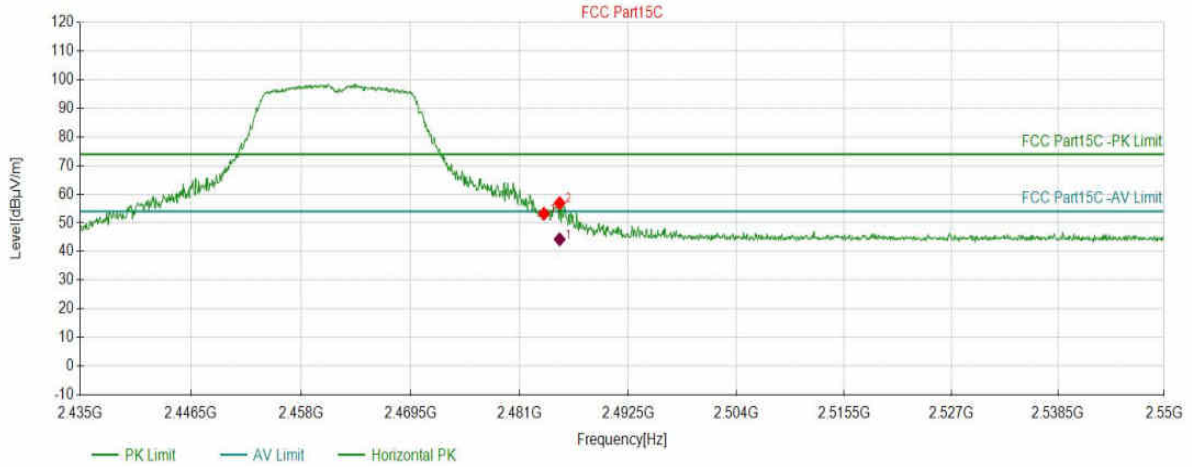

Suspected Data List									
NO.	Freq. (MHz)	Level (dBµV/m)	Factor (dB)	Limit (dBµV/m)	Margin (dB)	Height (cm)	Angle (°)	Detector	Polarity
1	2483.5543	53.19	6.24	74.00	20.81	150	163	PK	Horizont
2	2485.2226	56.89	6.25	74.00	17.11	150	154	PK	Horizont

AV Final Data List								
NO.	Freq. (MHz)	Factor (dB)	AV Value (dBµV/m)	AV Limit (dBµV/m)	AV Margin (dB)	Height (cm)	Angle (°)	Polarity
1	2485.2226	6.25	44.27	54.00	9.73	150	154	Horizontal

Test Report

Project Information			
EUT:	Wi-Fi Module Integrated Bluetooth	Environment:	23.0°C 43%
Model:	SKI.WB822CU.2	SN:	
Mode:	11G_2462	Voltage:	DC 3.3V
Customer:		Engineer:	Winnie Meng
Remark:			

Start of Test: 2024-02-28 12:07:46

Test Graph

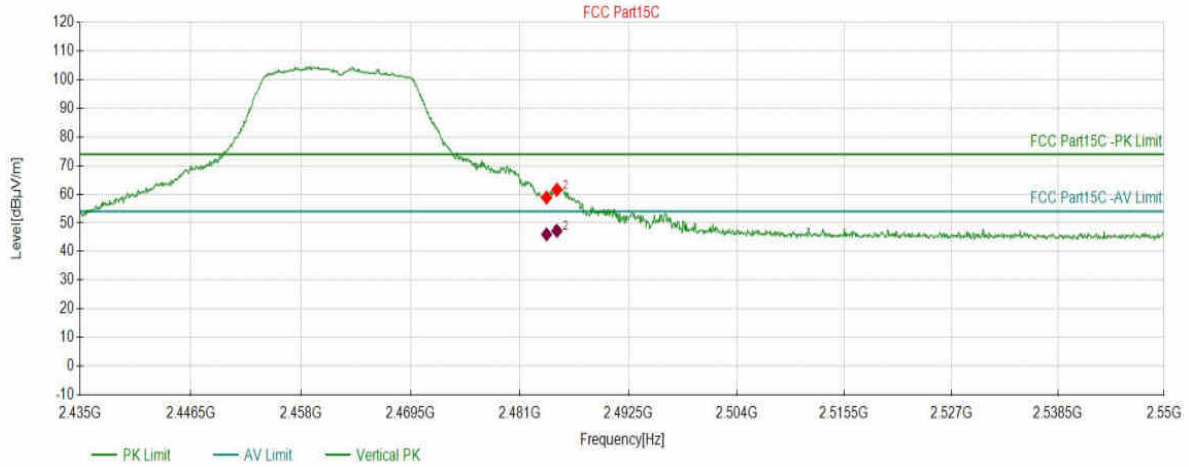

Suspected Data List

NO.	Freq. (MHz)	Level (dBµV/m)	Factor (dB)	Limit (dBµV/m)	Margin (dB)	Height (cm)	Angle (°)	Detector	Polarity
1	2483.8419	58.83	6.24	74.00	15.17	150	237	PK	Vertical
2	2484.9350	61.60	6.25	74.00	12.40	150	27	PK	Vertical

AV Final Data List

NO.	Freq. (MHz)	Factor (dB)	AV Value (dBµV/m)	AV Limit (dBµV/m)	AV Margin (dB)	Height (cm)	Angle (°)	Polarity
1	2483.8419	6.25	45.99	54.00	8.01	154.6	54.1	Vertical
2	2484.9350	6.25	47.21	54.00	6.79	161.4	27.1	Vertical

Test Report

Project Information			
EUT:	Wi-Fi Module Integrated Bluetooth	Environment:	23.0°C 43%
Model:	SKI.WB822CU.2	SN:	
Mode:	11N20_2412	Voltage:	DC 3.3V
Customer:		Engineer:	Winnie Meng
Remark:			

Start of Test: 2024-02-28 14:26:24

Test Graph

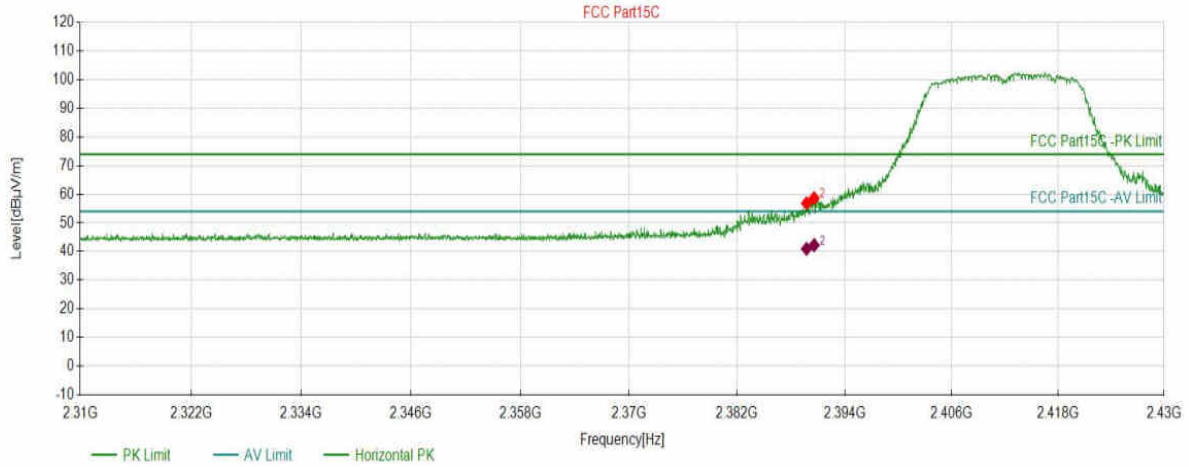

Suspected Data List									
NO.	Freq. (MHz)	Level (dBµV/m)	Factor (dB)	Limit (dBµV/m)	Margin (dB)	Height (cm)	Angle (°)	Detector	Polarity
1	2389.7466	56.81	5.65	74.00	17.19	150	308	PK	Horizont
2	2390.5869	58.62	5.65	74.00	15.38	150	315	PK	Horizont

AV Final Data List								
NO.	Freq. (MHz)	Factor (dB)	AV Value (dBµV/m)	AV Limit (dBµV/m)	AV Margin (dB)	Height (cm)	Angle (°)	Polarity
1	2389.7467	5.65	40.95	54.00	13.05	154.8	298.7	Horizontal
2	2390.5871	5.65	42.20	54.00	11.80	149.9	315.8	Horizontal

Test Report

Project Information			
EUT:	Wi-Fi Module Integrated Bluetooth	Environment:	23.0°C 43%
Model:	SKI.WB822CU.2	SN:	
Mode:	11N20_2412	Voltage:	DC 3.3V
Customer:		Engineer:	Winnie Meng
Remark:			

Start of Test: 2024-02-28 14:27:17

Test Graph

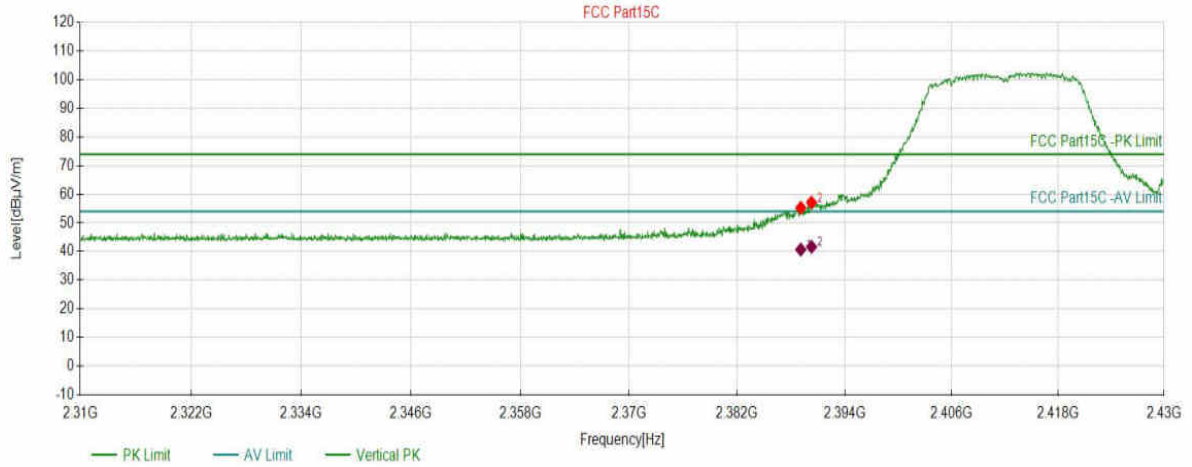

Suspected Data List

NO.	Freq. (MHz)	Level (dBµV/m)	Factor (dB)	Limit (dBµV/m)	Margin (dB)	Height (cm)	Angle (°)	Detector	Polarity
1	2389.1064	55.28	5.65	74.00	18.72	150	270	PK	Vertical
2	2390.3068	57.10	5.65	74.00	16.90	150	4	PK	Vertical

AV Final Data List

NO.	Freq. (MHz)	Factor (dB)	AV Value (dBµV/m)	AV Limit (dBµV/m)	AV Margin (dB)	Height (cm)	Angle (°)	Polarity
1	2389.1064	5.65	40.69	54.00	13.31	150	270	Vertical
2	2390.3068	5.65	41.67	54.00	12.33	150	4	Vertical

Test Report

Project Information			
EUT:	Wi-Fi Module Integrated Bluetooth	Environment:	22.1°C 48%
Model:	SKI.WB822CU.2	SN:	
Mode:	11N20_2462	Voltage:	DC 12V
Customer:		Engineer:	Winnie Meng
Remark:			

Start of Test: 2024-03-05 09:45:38

Test Graph

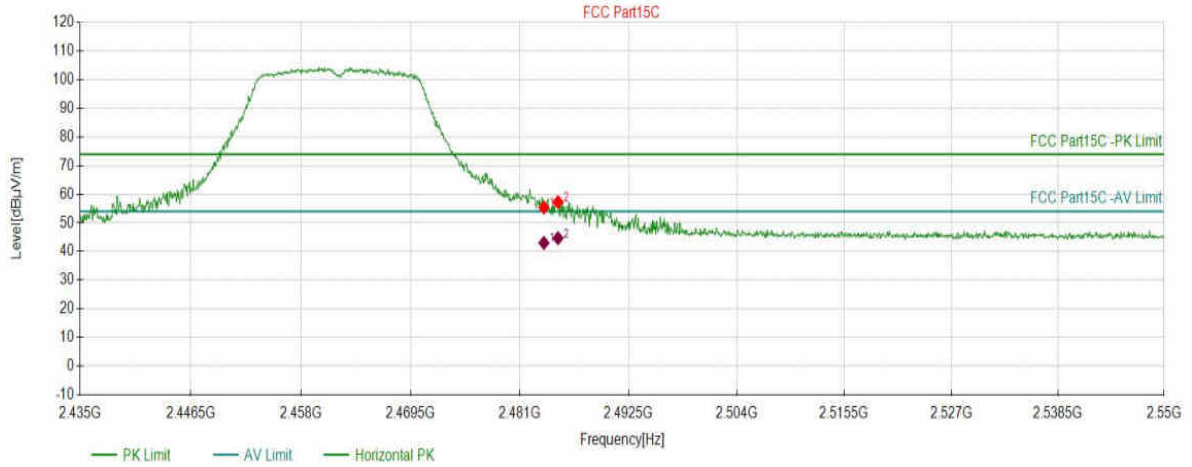

Suspected Data List									
NO.	Freq. (MHz)	Level (dBµV/m)	Factor (dB)	Limit (dBµV/m)	Margin (dB)	Height (cm)	Angle (°)	Detector	Polarity
1	2483.5543	55.38	6.24	74.00	18.62	150	117	PK	Horizont
2	2485.0500	57.23	6.25	74.00	16.77	150	0	PK	Horizont

AV Final Data List								
NO.	Freq. (MHz)	Factor (dB)	AV Value (dBµV/m)	AV Limit (dBµV/m)	AV Margin (dB)	Height (cm)	Angle (°)	Polarity
1	2483.5543	6.24	43.02	54.00	10.98	150	117	Horizontal
2	2485.0500	6.25	44.67	54.00	9.33	150	0	Horizontal

Test Report

Project Information			
EUT:	Wi-Fi Module Integrated Bluetooth	Environment:	22.1°C 48%
Model:	SKI.WB822CU.2	SN:	
Mode:	11N20_2462	Voltage:	DC 12V
Customer:		Engineer:	Winnie Meng
Remark:			

Start of Test: 2024-03-05 09:46:18

Test Graph

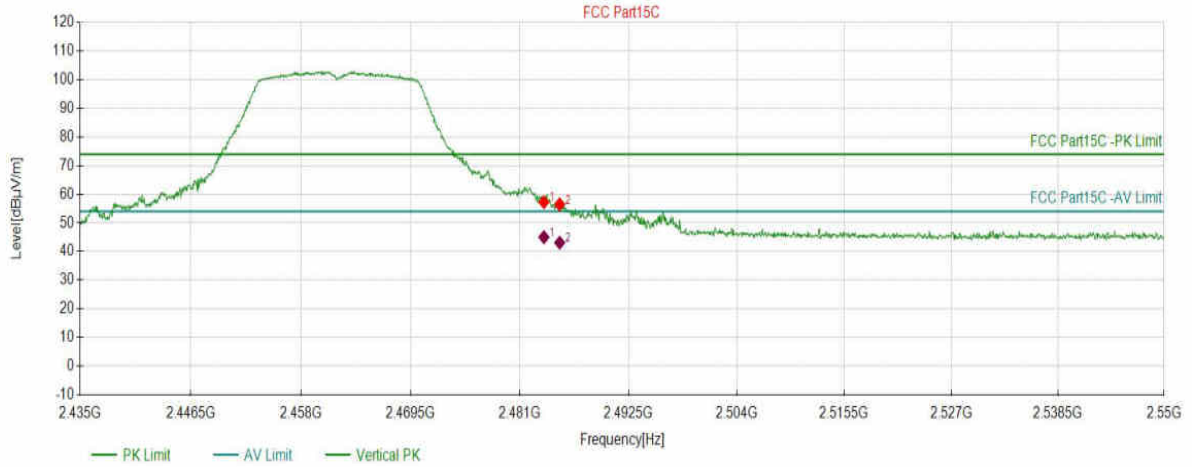

Suspected Data List

NO.	Freq. (MHz)	Level (dBµV/m)	Factor (dB)	Limit (dBµV/m)	Margin (dB)	Height (cm)	Angle (°)	Detector	Polarity
1	2483.5543	57.22	6.24	74.00	16.78	150	4	PK	Vertical
2	2485.2226	56.46	6.25	74.00	17.54	150	342	PK	Vertical

AV Final Data List

NO.	Freq. (MHz)	Factor (dB)	AV Value (dBµV/m)	AV Limit (dBµV/m)	AV Margin (dB)	Height (cm)	Angle (°)	Polarity
1	2483.5543	6.24	45.01	54.00	8.99	150	4	Vertical
2	2485.2226	6.25	43.10	54.00	10.90	150	342	Vertical

Test Report

Project Information			
EUT:	Wi-Fi Module Integrated Bluetooth	Environment:	22.1°C 48%
Model:	SKI.WB822CU.2	SN:	
Mode:	11N40_2422	Voltage:	DC 12V
Customer:		Engineer:	Winnie Meng
Remark:			

Start of Test: 2024-03-05 09:57:41

Test Graph

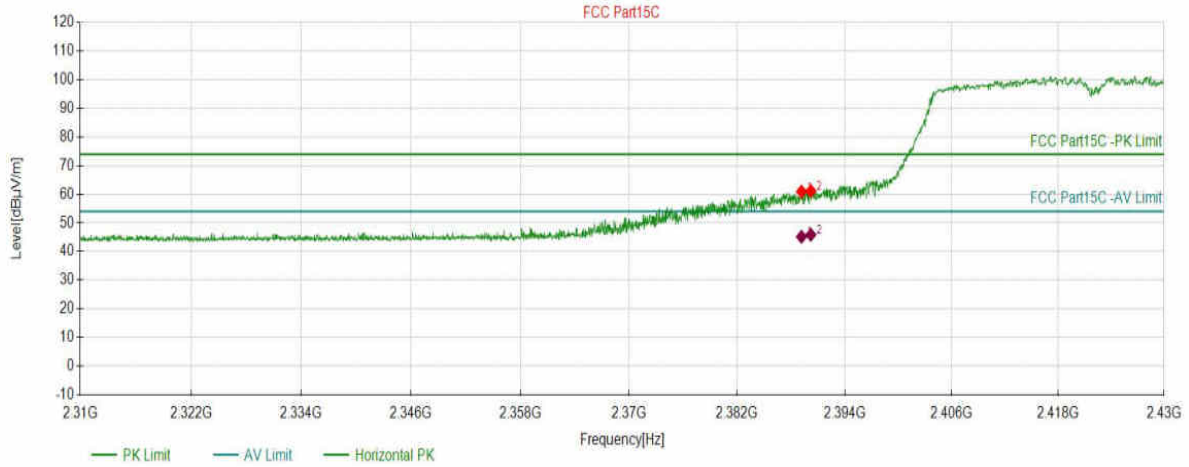

Suspected Data List									
NO.	Freq. (MHz)	Level (dBµV/m)	Factor (dB)	Limit (dBµV/m)	Margin (dB)	Height (cm)	Angle (°)	Detector	Polarity
1	2389.1864	60.91	5.65	74.00	13.09	150	4	PK	Horizont
2	2390.2267	61.12	5.65	74.00	12.88	150	5	PK	Horizont

AV Final Data List								
NO.	Freq. (MHz)	Factor (dB)	AV Value (dBµV/m)	AV Limit (dBµV/m)	AV Margin (dB)	Height (cm)	Angle (°)	Polarity
1	2389.1864	5.65	45.16	54.00	8.84	150	4	Horizontal
2	2390.2267	5.65	45.87	54.00	8.13	150	5	Horizontal

Test Report

Project Information			
EUT:	Wi-Fi Module Integrated Bluetooth	Environment:	22.1°C 48%
Model:	SKI.WB822CU.2	SN:	
Mode:	11N40_2422	Voltage:	DC 12V
Customer:		Engineer:	Winnie Meng
Remark:			

Start of Test: 2024-03-05 09:58:41

Test Graph

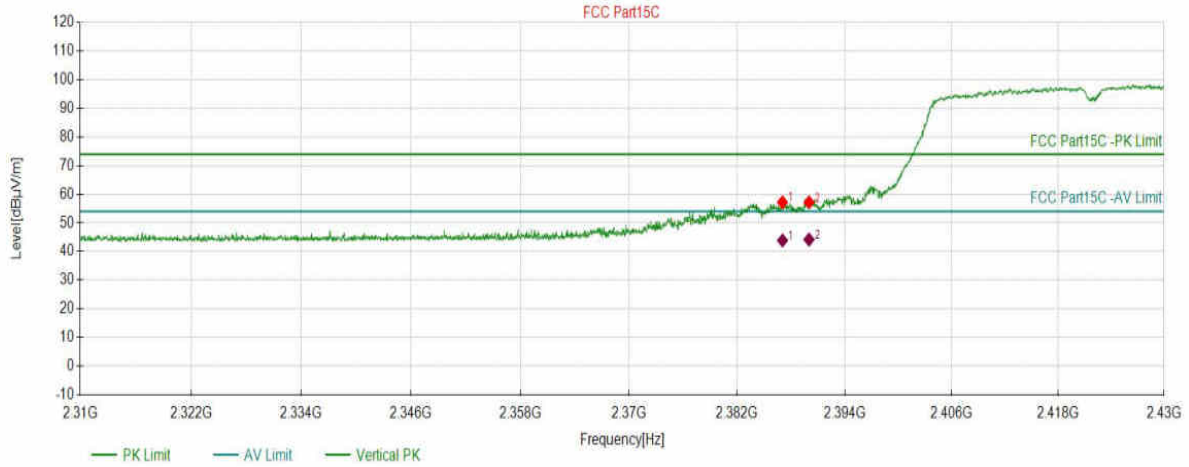

Suspected Data List

NO.	Freq. (MHz)	Level (dBµV/m)	Factor (dB)	Limit (dBµV/m)	Margin (dB)	Height (cm)	Angle (°)	Detector	Polarity
1	2387.0657	57.19	5.65	74.00	16.81	150	174	PK	Vertical
2	2390.0267	57.17	5.65	74.00	16.83	150	359	PK	Vertical

AV Final Data List

NO.	Freq. (MHz)	Factor (dB)	AV Value (dBµV/m)	AV Limit (dBµV/m)	AV Margin (dB)	Height (cm)	Angle (°)	Polarity
1	2387.0657	5.65	43.88	54.00	10.12	150	174	Vertical
2	2390.0267	5.65	44.19	54.00	9.81	150	359	Vertical

Test Report

Project Information			
EUT:	Wi-Fi Module Integrated Bluetooth	Environment:	22.1°C 48%
Model:	SKI.WB822CU.2	SN:	
Mode:	11N40_2452	Voltage:	DC 12V
Customer:		Engineer:	Winnie Meng
Remark:			

Start of Test: 2024-03-05 10:09:34

Test Graph

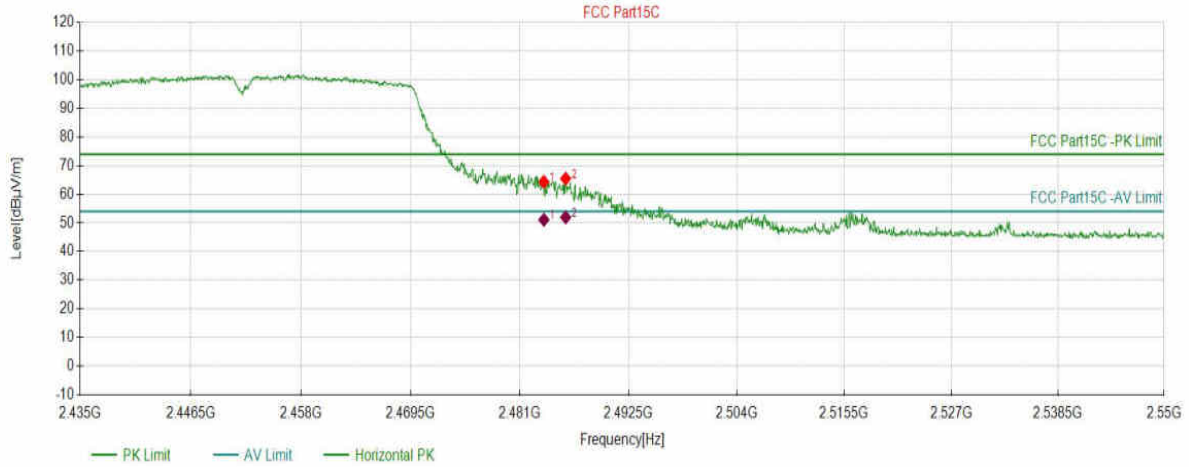

Suspected Data List

NO.	Freq. (MHz)	Level (dBµV/m)	Factor (dB)	Limit (dBµV/m)	Margin (dB)	Height (cm)	Angle (°)	Detector	Polarity
1	2483.5543	64.32	6.24	74.00	9.68	150	127	PK	Horizont
2	2485.8554	65.44	6.26	74.00	8.56	150	131	PK	Horizont

AV Final Data List

NO.	Freq. (MHz)	Factor (dB)	AV Value (dBµV/m)	AV Limit (dBµV/m)	AV Margin (dB)	Height (cm)	Angle (°)	Polarity
1	2483.5543	6.24	51.07	54.00	2.93	150	127	Horizontal
2	2485.8554	6.26	51.95	54.00	2.05	150	131	Horizontal

Test Report

Project Information			
EUT:	Wi-Fi Module Integrated Bluetooth	Environment:	22.1°C 48%
Model:	SKI.WB822CU.2	SN:	
Mode:	11N40_2452	Voltage:	DC 12V
Customer:		Engineer:	Winnie Meng
Remark:			

Start of Test: 2024-03-05 10:10:22

Test Graph

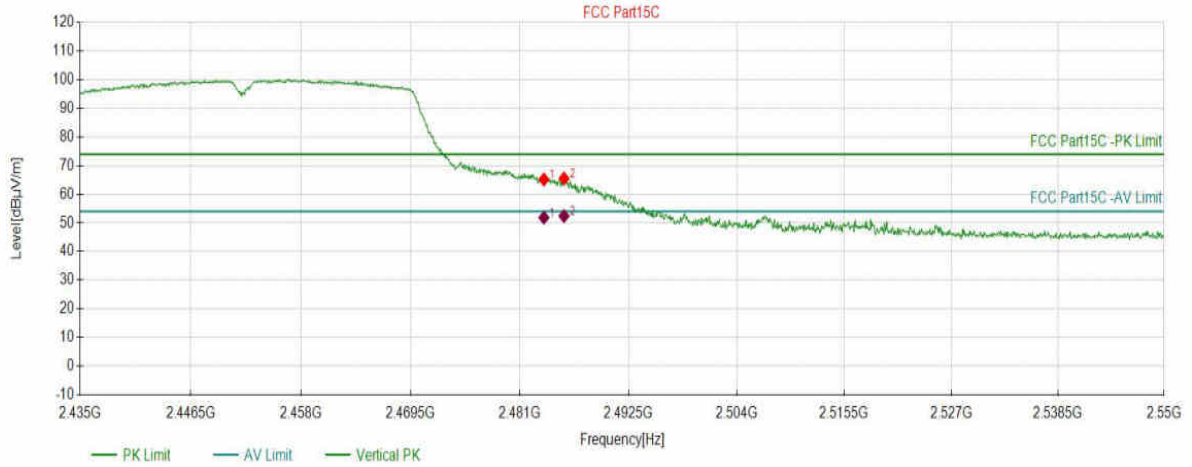

Suspected Data List									
NO.	Freq. (MHz)	Level (dBµV/m)	Factor (dB)	Limit (dBµV/m)	Margin (dB)	Height (cm)	Angle (°)	Detector	Polarity
1	2483.5543	65.16	6.24	74.00	8.84	150	302	PK	Vertical
2	2485.6828	65.51	6.26	74.00	8.49	150	342	PK	Vertical

AV Final Data List								
NO.	Freq. (MHz)	Factor (dB)	AV Value (dBµV/m)	AV Limit (dBµV/m)	AV Margin (dB)	Height (cm)	Angle (°)	Polarity
1	2483.5543	6.24	51.85	54.00	2.15	150	302	Vertical
2	2485.6828	6.26	52.40	54.00	1.60	150	342	Vertical

END OF REPORT