

FCC AND ISCED CERTIFICATION TEST REPORT

Applicant:	Guangzhou Shikun Electronics Co., Ltd
Address:	NO.6 Liankun Road, Huangpu District, Guangzhou, China
Manufacturer:	Guangzhou Shikun Electronics Co., Ltd
Address:	NO.6 Liankun Road, Huangpu District, Guangzhou, China
Product Description:	IEEE802.11a/b/g/n/ac 2T2R USB Wi-Fi Module Integrated Bluetooth 2.1/3.0/4.2/5.0
Brand Name:	NA
Tested Model:	SKI.WB822CU.2
FCC ID:	2AR82-SKIWB822CU2
IC:	24728-SKIWB822CU2
Report No.:	JCF240223021-001
Received Date:	Feb. 23, 2024
Tested Date:	Feb. 23, 2024 ~ Mar. 22, 2024
Issued Date:	Mar. 22, 2024
Test Standards:	FCC Rules and Regulations Part 15 Subpart C, RSS-247 Issue 3 August 2023
Test Procedure:	ANSI C63.10:2013, RSS-Gen Issue 5 A2, Feb. 2021
Test Result:	Pass
Prepared By:	
	
<u>Roger Li/Engineer</u>	Date: Mar. 22, 2024
Reviewed By:	
	
<u>Kennys Zhang/Engineer</u>	Date: Mar. 22, 2024
	
Approved By:	
	
<u>Talent Zhang/Engineer</u>	Date: Mar. 22, 2024

Note: The test results in this report apply exclusively to the tested model / sample. Without written approval of Guangzhou Jingce Testing Technology Co., Ltd. the test report shall not be reproduced except in full.

Report Revise Record

Report Version	Revise Time	Issued Date	Valid Version	Notes
V1.0	/	Mar. 22, 2024	Original Report	/

Table of Contents

1. Test Report Declare	4
2. Summary of Test Results	5
3. Test Laboratory	5
4. Equipment Under Test	6
4.1. Description of EUT	6
4.2. Channel List	6
4.3. Packet Type Configuration	7
4.4. Test Channel Configuration	7
4.5. Test environment conditions	7
4.6. The Worst Case Power Setting Parameter	7
4.7. Description of Available Antennas	8
5. Description of Test Setup	8
5.1. Accessory	8
5.2. Support Equipment	8
5.3. Test Setup	8
5.4. Setup Diagram for Tests	8
6. Measurement Uncertainty	9
7. Measuring Instrument and Software Used	9
8. Conducted Output Power	11
8.1. Block diagram of test setup	11
8.2. Limits	11
8.3. Test Procedure	11
8.4. Results	11
9. Radiated Emission	12
9.1. Block diagram of test setup	12
9.2. Limit	13
9.3. Test Procedure	14
9.4. Results	16
9.5. Original test data	16
10. Antenna Requirements	17
10.1. Limits	17
10.2. Result	17
APPENDIX A – Radiated Emission Below 1GHz Test Data	18
APPENDIX B – Radiated Emission Above 1GHz Test Data	20

1. Test Report Declare

Applicant:	Guangzhou Shikun Electronics Co., Ltd
Address:	NO.6 Liankun Road, Huangpu District, Guangzhou, China
Manufacturer:	Guangzhou Shikun Electronics Co., Ltd
Address:	NO.6 Liankun Road, Huangpu District, Guangzhou, China
Product Name:	IEEE802.11a/b/g/n/ac 2T2R USB Wi-Fi Module Integrated Bluetooth 2.1/3.0/4.2/5.0
Brand Name:	NA
Model Name:	SKI.WB822CU.2
Difference Description:	NA

We Declare:

The equipment described above is tested by Guangzhou Jingce Testing Technology Co., Ltd. and in the configuration tested the equipment complied with the standards specified above. The test results are contained in this test report and Guangzhou Jingce Testing Technology Co., Ltd. is assumed of full responsibility for the accuracy and completeness of these tests except as provided information by clients.

2. Summary of Test Results

Summary of Test Results			
Clause	Test Items	FCC/ISED Rules	Test Result
1	20 dB Bandwidth and 99 % Occupied Bandwidth	FCC 15.247 (a) (1) RSS-247 Clause 5.1 (a) RSS-Gen Clause 6.7	NA
2	Conducted Output Power	FCC 15.247 (b) (1) RSS-247 Clause 5.1 (b)	Pass
3	Carrier Hopping Channel Separation	FCC 15.247 (a) (1) RSS-247 Clause 5.1 (b)	NA
4	Number of Hopping Frequency	15.247 (a) (1) III RSS-247 Clause 5.1 (d)	NA
5	Time of Occupancy (Dwell Time)	15.247 (a) (1) III RSS-247 Clause 5.1 (d)	NA
6	Conducted Band edge	FCC 15.247 (d) RSS-247 Clause 5.5	NA
7	Radiated Band edge and Spurious	FCC 15.247 (d) FCC 15.209 FCC 15.205 RSS-247 Clause 5.5 RSS-GEN Clause 8.9 RSS-GEN Clause 8.10	Pass
8	Conducted Emission Test For AC Power Port	FCC 15.207 RSS-GEN Clause 8.8	NA
9	Antenna Requirement	FCC 15.203 RSS-GEN Clause 6.8	Pass

Note: The EUT has only added antenna to the original report. So above test items except clause 2&7&9 need to be retest, the other test items reference report "ESTE-R2112272 " and "ESTE-R2112278"

3. Test Laboratory

Guangzhou Jingce Testing Technology Co., Ltd.

Add.: No.192, Kezhu Road, Huangpu District, Guangzhou, Guangdong, China

Association for Laboratory Accreditation(A2LA). Certificate Number: 6594.01

FCC Designation Number: CN1331. Test Firm Registration Number: 360543

IC Test Firm Registration Number: 28796

Conformity Assessment Body identifier: CN0138

4. Equipment Under Test

4.1. Description of EUT

EUT Name:	IEEE802.11a/b/g/n/ac 2T2R USB Wi-Fi Module Integrated Bluetooth 2.1/3.0/4.2/5.0
Model Number:	SKI.WB822CU.2
EUT Function Description:	Please refer to usual manual
Power Supply:	DC 3.3V+/-0.3
Hardware Version:	NA
Software Version:	NA
Radio Specification:	Bluetooth V5.0
Operation Frequency:	2402 MHz - 2480 MHz
Modulation:	GFSK, $\pi/4$ -DQPSK, 8DPSK
Data Rate:	1Mbps, 2Mbps, 3Mbps
Antenna Type:	Shrapnel Antenna, MAX. Gain: 3.32 dBi

Note 1: EUT is the ab. of equipment under test.

Note 2: The antenna gain is declared by the customer and the laboratory is not responsible for the accuracy of the antenna gain.

4.2. Channel List

Channel	Frequency (MHz)	Channel	Frequency (MHz)	Channel	Frequency (MHz)	Channel	Frequency (MHz)
0	2402	20	2422	40	2442	60	2462
1	2403	21	2423	41	2443	61	2463
2	2404	22	2424	42	2444	62	2464
3	2405	23	2425	43	2445	63	2465
4	2406	24	2426	44	2446	64	2466
5	2407	25	2427	45	2447	65	2467
6	2408	26	2428	46	2448	66	2468
7	2409	27	2429	47	2449	67	2469
8	2410	28	2430	48	2450	68	2470
9	2411	29	2431	49	2451	69	2471
10	2412	30	2432	50	2452	70	2472
11	2413	31	2433	51	2453	71	2473
12	2414	32	2434	52	2454	72	2474
13	2415	33	2435	53	2455	73	2475
14	2416	34	2436	54	2456	74	2476
15	2417	35	2437	55	2457	75	2477
16	2418	36	2438	56	2458	76	2478
17	2419	37	2439	57	2459	77	2479
18	2420	38	2440	58	2460	78	2480
19	2421	39	2441	59	2461	/	/

4.3. Packet Type Configuration

Test Mode	Packet Type	Setting(Packet Length)
GFSK	DH1	27
	DH3	183
	DH5	339
$\pi/4$ -DQPSK	2-DH1	54
	2-DH3	367
	2-DH5	679
8DPSK	3-DH1	83
	3-DH3	552
	3-DH5	1021

4.4. Test Channel Configuration

Tested mode, channel, information		
Mode	Channel	Frequency (MHz)
GFSK hopping on Tx mode	CH0 to CH78	2402 to 2480
$\pi/4$ -DQPSK hopping on Tx mode	CH0 to CH78	2402 to 2480
8DPSK hopping on Tx mode	CH0 to CH78	2402 to 2480
GFSK hopping off Tx mode	LCH: CH0	2402
	MCH: CH39	2441
	HCH: CH78	2480
$\pi/4$ -DQPSK hopping off Tx mode	LCH: CH0	2402
	MCH: CH39	2441
	HCH: CH78	2480
8DPSK hopping off Tx mode	LCH: CH0	2402
	MCH: CH39	2441
	HCH: CH78	2480

4.5. Test environment conditions

During the measurement the environmental conditions were within the listed ranges:

Temperature range:	21-25 °C
Humidity range:	40-75%
Pressure range:	86-106 kPa

4.6. The Worst Case Power Setting Parameter

The Worst Case Power Setting Parameter under 2400 ~ 2483.5MHz Band				
Test Software		MP Tool		
Modulation Type	Transmit Antenna Number	Test Software Setting Value		
		CH 0	CH 39	CH 78
GFSK	1	Default	Default	Default
$\pi/4$ -DQPSK	1	Default	Default	Default
8DPSK	1	Default	Default	Default

4.7. Description of Available Antennas

Test Mode	Transmit and Receive Mode	Description
GFSK	<input checked="" type="checkbox"/> 1TX, 1RX	Antenna 1 can be used as transmitting/receiving antenna.
$\pi/4$ -DQPSK	<input checked="" type="checkbox"/> 1TX, 1RX	Antenna 1 can be used as transmitting/receiving antenna.
8DPSK	<input checked="" type="checkbox"/> 1TX, 1RX	Antenna 1 can be used as transmitting/receiving antenna.

5. Description of Test Setup

5.1. Accessory

Description of Accessories	Manufacturer	Model Number	Description	Remark
/	/	/	/	/

5.2. Support Equipment

Equipment	Brand Name	Model Name	P/N
PC	Lenovo	T480	/

5.3. Test Setup

The EUT can work in Fixed Frequency mode.

5.4. Setup Diagram for Tests



6. Measurement Uncertainty

Where relevant, the following measurement uncertainty levels have been estimated for tests performed on the apparatus:

Test Item	Uncertainty
AC Power Conduction emission	1.37 dB
All Radiated emissions	5.4dB
Conducted emissions	3.09 dB
Occupied Channel Bandwidth	1.1%
Conducted Output power	0.82dB
Power Spectral Density	0.82dB

Note: This uncertainty represents an expanded uncertainty expressed at approximately the 95 % confidence level using a coverage factor of $k = 2$.

7. Measuring Instrument and Software Used

TS Test System						
Used	Equipment	Manufacturer	Model No.	Serial No.	Last Cal.	Due. Date
<input checked="" type="checkbox"/>	Spectrum Analyzer	Keysight	N9030B	MY56320512	Sep. 12, 2023	Sep. 11, 2024
<input checked="" type="checkbox"/>	Vector Signal Generator	Keysight	N5182B	MY57300334	Sep. 12, 2023	Sep. 11, 2024
<input checked="" type="checkbox"/>	Signal Generator	Keysight	N5171B	MY57280639	Sep. 12, 2023	Sep. 11, 2024
<input checked="" type="checkbox"/>	DC POWER	Keysight	E342A	MY59020356	Jul. 14, 2023	Jul. 13, 2024
<input checked="" type="checkbox"/>	Incubator thermometer	GWS	EL-02JA	21107288	Sep. 12, 2023	Sep. 11, 2024
<input checked="" type="checkbox"/>	Control unit(Power sensor)	Tonscend	JS0806-2	/	Sep. 12, 2023	Sep. 11, 2024
<input checked="" type="checkbox"/>	Wideband radio communication tester	R&S	CMW500	163478	Jul. 11, 2023	Jul. 10, 2024
<input checked="" type="checkbox"/>	Spectrum Analyzer	Keysight	N9020B	MY60112206	Sep. 12, 2023	Sep. 12, 2024
<input checked="" type="checkbox"/>	Control unit(Power sensor)	Tonscend	JS0806-2	21H8060465	Sep. 12, 2023	Sep. 12, 2024
Software						
Used	Description	Manufacturer	Name	Version		
<input checked="" type="checkbox"/>	Test software	Tonscend	JS1120-3	V3.3.10		
RSE Test System						
Used	Equipment	Manufacturer	Model No.	Serial No.	Last Cal.	Due. Date
<input checked="" type="checkbox"/>	EMI Receiver	R&S	ESW	101685	Jul. 12, 2023	Jul. 11, 2024
<input checked="" type="checkbox"/>	Bilog Antenna	Schwarzbeck	VULB 9163	01361	Aug. 16, 2023	Aug. 15, 2024
<input checked="" type="checkbox"/>	Horn Antenna 1	Schwarzbeck	BBHA 9120 D	02411	May. 25, 2023	May. 24, 2024
<input checked="" type="checkbox"/>	Horn Antenna 2	ETS	BBHA 9170	1090	Sep. 04, 2023	Sep. 03, 2024
<input checked="" type="checkbox"/>	loop-antenna	Schwarzbeck	FMZB 1513-60	00030	Jan. 14, 2024	Jan. 13, 2025
<input checked="" type="checkbox"/>	Signal Pre-Amplifier	Tonscend	TAP01018050	AP21C806122	Jul. 10, 2023	Jul. 09, 2024

<input checked="" type="checkbox"/>	Signal Pre-Amplifier	Tonscend	TAP9K3G32	AP20K806104	Jul. 10, 2023	Jul. 09, 2024
<input checked="" type="checkbox"/>	Signal Pre-Amplifier	ETS	3116C-PA	00217677	Aug. 24, 2023	Aug. 23, 2024
<input checked="" type="checkbox"/>	3m Fully-anechoic Chamber	ETS	RFD-100	/	Apr. 24, 2021	Apr. 23, 2024
Software						
Used	Description	Manufacturer	Name		Version	
<input checked="" type="checkbox"/>	Test software	Tonscend	TS+		V3.0.0.4	
Conducted Emission Test For AC Power Port						
Used	Equipment	Manufacturer	Model No.	Serial No.	Last Cal.	Due. Date
<input checked="" type="checkbox"/>	LISN	R&S	ENV216	102154	Jul. 10, 2023	Jul. 09, 2024
<input checked="" type="checkbox"/>	EMI Receiver	R&S	ESR3	102509	Jul. 12, 2023	Jul. 11, 2024
Software						
Used	Description	Manufacturer	Name		Version	
<input checked="" type="checkbox"/>	Test software	EZ	EZ-EMC		EMEC-3A1	
Other Instrument						
Used	Equipment	Manufacturer	Model No.	Serial No.	Last Cal.	Due. Date
<input checked="" type="checkbox"/>	Temperature & Humidity	Temperature	HTC-1	/	Nov. 02, 2023	Nov. 01, 2024

8. Conducted Output Power

8.1. Block diagram of test setup

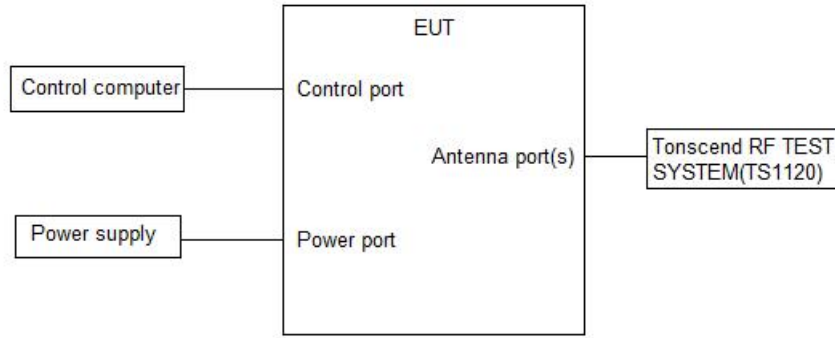

8.2. Limits

CFR 47 FCC Part15 (15.247) , Subpart C ISED RSS-247 ISSUE 3			
Section	Test Item	Limit	Frequency Range (MHz)
CFR 47 FCC 15.247 (b) (1) ISED RSS-247 Clause 5.4 (b)	Peak Conducted Output Power	Hopping channel carrier frequencies separated by a minimum of 25 kHz or the 20 dB bandwidth of the hopping channel: 1 watt or 30dBm; Hopping channel carrier frequencies that are separated by 25 kHz or two-thirds of the 20 dB bandwidth of the hopping channel : 125 mW or 21dBm	2400-2483.5

8.3. Test Procedure

- (1) Connect EUT's antenna output to spectrum analyzer by RF cable.
 - (2) Measure the maximum output power of EUT by spectrum analyzer with PK detector and RBW=3 MHz (above 20 dB bandwidth of measured signal), VBW=8 MHz
- Note: The attenuator loss was inputted into spectrum analyzer as amplitude offset.

8.4. Results

Test Mode	Ant.	Freq. (MHz)	Conducted Peak Power (dBm)	EIRP (dBm)	Conducted Limit (dBm)	EIRP Limit (dBm)	Verdict
DH5	Ant1	2402	3.60	6.92	≤20.97	≤36	PASS
		2441	3.65	6.97	≤20.97	≤36	PASS
		2480	4.43	7.75	≤20.97	≤36	PASS
3DH5	Ant1	2402	5.88	9.2	≤20.97	≤36	PASS
		2441	6.55	9.87	≤20.97	≤36	PASS
		2480	7.22	10.54	≤20.97	≤36	PASS

The test Conducted Power reference report “ESTE-R2112272 ” and “ESTE-R2112278”

9. Radiated Emission

9.1. Block diagram of test setup

In 3m Anechoic Chamber, test setup diagram for 9kHz - 30MHz:

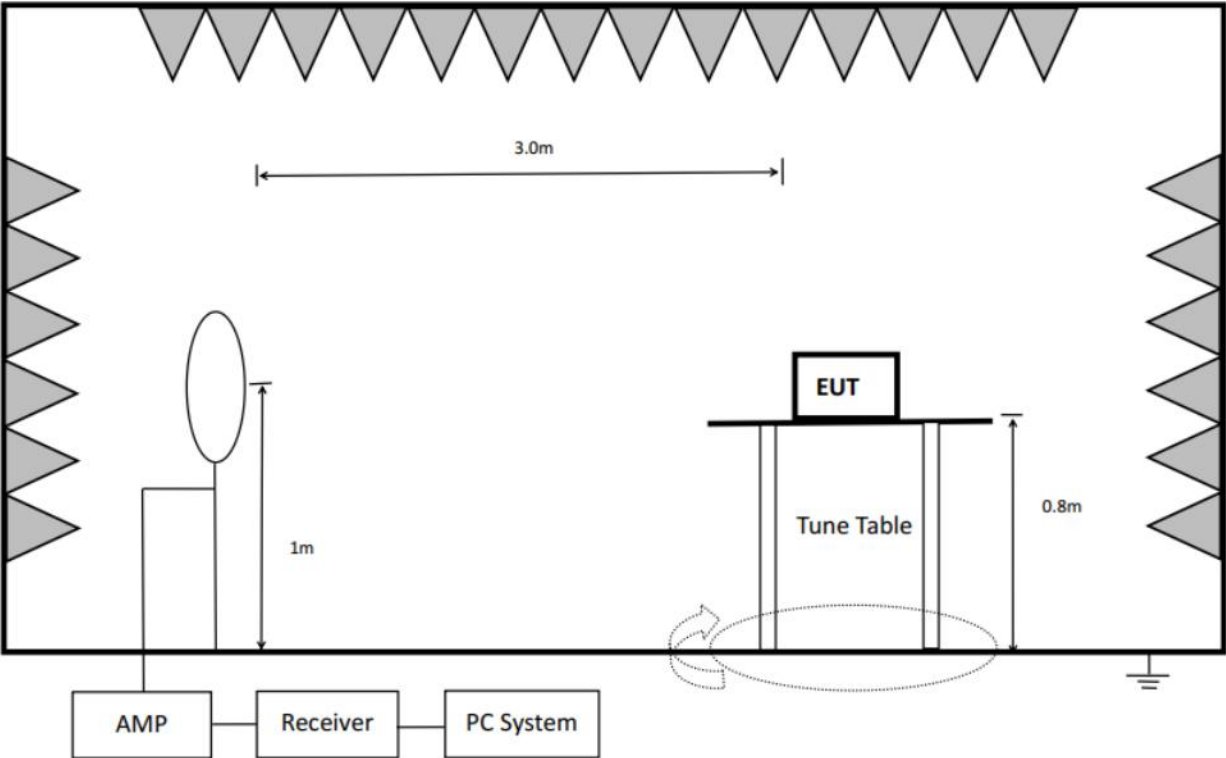

In 3m Anechoic Chamber, test setup diagram for 30 MHz - 1 GHz:

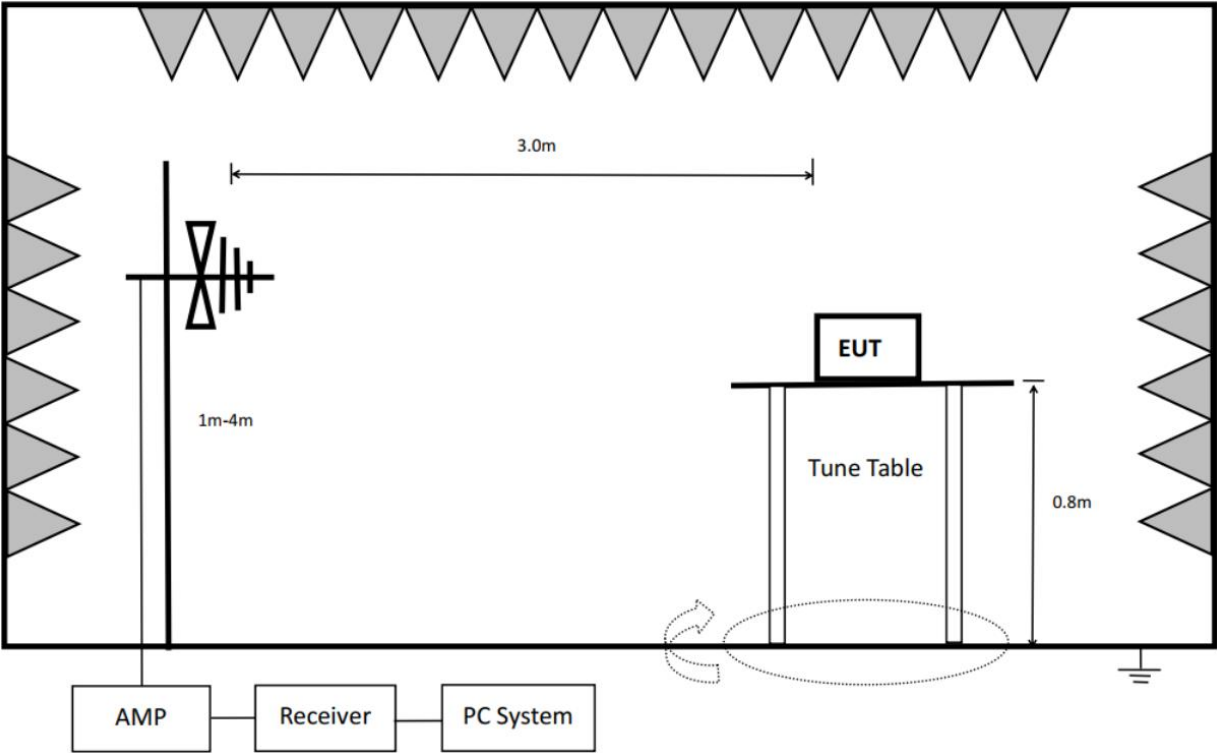

In 3m Anechoic Chamber, test setup diagram for frequency above 1 GHz:

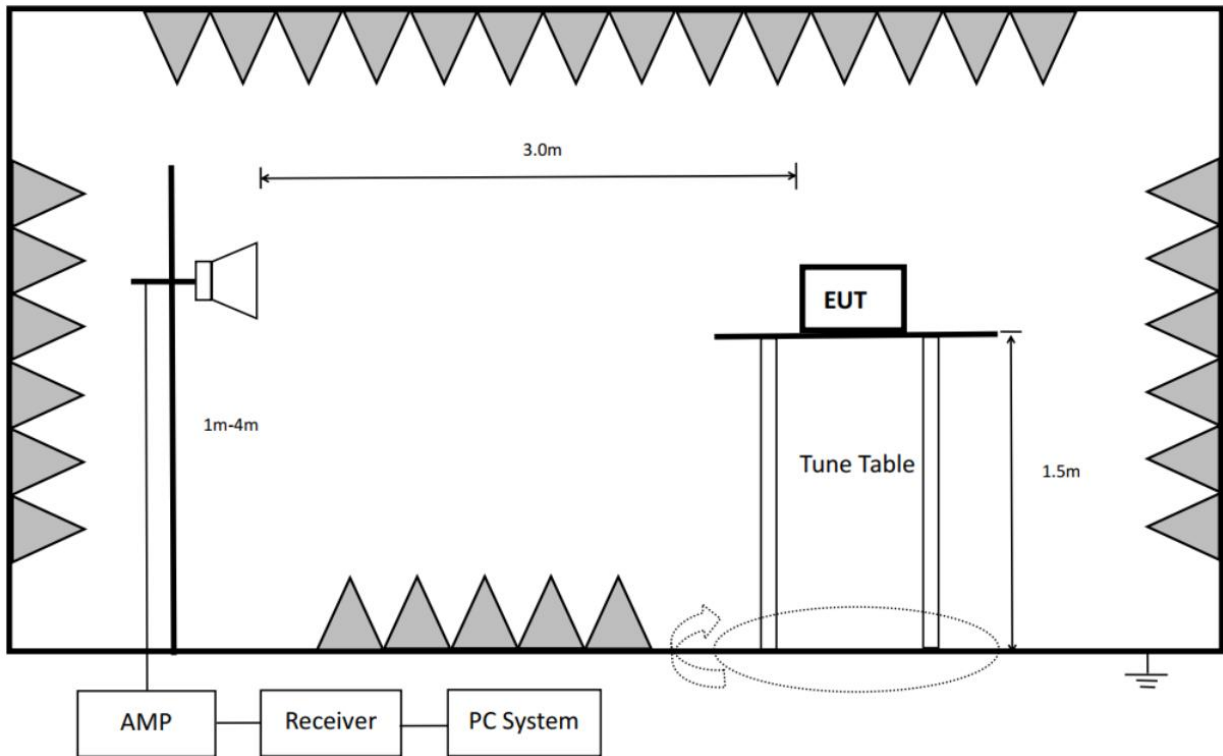

Note: For harmonic emissions test an appropriate high pass filter was inserted in the input port of AMP.

9.2. Limit

(1) FCC 15.205 Restricted frequency band

MHz	MHz	MHz	GHz
0.090-0.110	16.42-16.423	399.9-410	4.5-5.15
¹ 0.495-0.505	16.69475-16.69525	608-614	5.35-5.46
2.1735-2.1905	16.80425-16.80475	960-1240	7.25-7.75
4.125-4.128	25.5-25.67	1300-1427	8.025-8.5
4.1772&4.17775	37.5-38.25	1435-1626.5	9.0-9.2
4.2072&4.20775	73-74.6	1645.5-1646.5	9.3-9.5
6.215-6.218	74.8-75.2	1660-1710	10.6-12.7
6.26775-6.26825	108-121.94	1718.8-1722.2	13.25-13.4
6.31175-6.31225	123-138	2200-2300	14.47-14.5
8.291-8.294	149.9-150.05	2310-2390	15.35-16.2
8.362-8.366	156.52475-156.52525	2483.5-2500	17.7-21.4
8.37625-8.38675	156.7-156.9	2690-2900	22.01-23.12
8.41425-8.41475	162.0125-167.17	3260-3267	23.6-24.0
12.29-12.293	167.72-173.2	3332-3339	31.2-31.8
12.51975-12.52025	240-285	3345.8-3358	36.43-36.5
12.57675-12.57725	322-335.4	3600-4400	(²)
13.36-13.41			

¹Until February 1, 1999, this restricted band shall be 0.490-0.510 MHz.

²Above 38.6

(2) FCC 15.209 Limit.

Frequency MHz	Distance Meters	Field Strengths Limit	
		$\mu\text{V}/\text{m}$	$\text{dB}(\mu\text{V})/\text{m}$
0.009 ~ 0.490	300	2400/F(kHz)	67.6-20log(F)
0.490 ~ 1.705	30	24000/F(kHz)	87.6-20log(F)
1.705 ~ 30.0	30	30	29.54
30 ~ 88	3	100	40.0
88 ~ 216	3	150	43.5
216~960	3	200	46.0
960~1000	3	500	54.0
Above 1000	3	74.0 dB(μV)/m (Peak) 54.0 dB(μV)/m (Average)	

Note: 1) At frequencies at or above 30 MHz, measurements may be performed at a distance other than what is specified provided: measurements are not made in the near field except where it can be shown that near field measurements are appropriate due to the characteristics of the device; and it can be demonstrated that the signal levels needed to be measured at the distance employed can be detected by the measurement equipment. Measurements shall not be performed at a distance greater than 30 meters unless it can be further demonstrated that measurements at a distance of 30 meters or less are impractical. When performing measurements at a distance other than that specified, the results shall be extrapolated to the specified distance using an extrapolation factor of 20 dB/decade (inverse linear-distance for field strength measurements; inverse-linear-distance-squared for power density measurements).

(2) At frequencies below 30 MHz, measurements may be performed at a distance closer than that specified in the regulations; however, an attempt should be made to avoid making measurements in the near field. Pending the development of an appropriate measurement procedure for measurements performed below 30 MHz, when performing measurements at a closer distance than specified, the results shall be extrapolated to the specified distance by either making measurements at a minimum of two distances on at least one radial to determine the proper extrapolation factor or by using the square of an inverse linear distance extrapolation factor (40 dB/decade). This paragraph (f) shall not apply to Access BPL devices operating below 30 MHz.

About Restricted bands of operation please refer to RSS-Gen section 8.10 and FCC § 15.205 (a),

9.3. Test Procedure

Below 30 MHz:

The setting of the spectrum Analyzer

RBW	300 Hz (From 9 kHz to 0.15 MHz)/ 10 kHz (From 0.15 MHz to 30 MHz)
VBW	1 kHz (From 9 kHz to 0.15 MHz)/ 30 kHz (From 0.15 MHz to 30 MHz)
Sweep	Auto
Trace	Max hold

1. The testing follows the guidelines in ANSI C63.10-2013

2. The EUT was arranged to its worst case and then turntable (from 0 degree to 360 degrees) to find the maximum reading. A pre-amp and a high pass filter are used for the test in order to get better signal level. Both Horizontal, Face-on and Face-off polarizations of the antenna are set to make the measurement.

3. The EUT was placed on a turntable with 80 cm meter above ground.

4. The EUT was set 3 meters from the interference receiving antenna, which was mounted on the top of 1 meter height antenna tower.

5. The radiated emission limits are based on measurements employing a CISPR quasi-peak detector except for the frequency bands 9-90 kHz, 110-490 kHz and above 1000 MHz. Radiated emission limits in these three bands are based on measurements employing an average detector.

6. For measurement below 1 GHz, the initial step in collecting conducted emission data is a spectrum analyzer peak detector mode pre-scanning the measurement frequency range. Significant peaks are then marked and then Quasi Peak detector mode re-measured. If the emission level of the EUT

measured by the peak detector is 3 dB lower than the applicable limit, the peak emission level will be reported. Otherwise, the emission measurement will be repeated using the quasi-peak detector and reported.

7. Although these tests were performed other than open field site, adequate comparison measurements were confirmed against 30m open field site. Therefore, sufficient tests were made to demonstrate that the alternative site produces results that correlate with the ones of tests made in an open field site based on KDB 414788.

Below 1 GHz and above 30 MHz:

The setting of the spectrum Analyzer

RBW	100 kHz
VBW	300 kHz
Sweep	Auto
Trace	Max hold

1. The testing follows the guidelines in ANSI C63.10-2013.

2. The EUT was arranged to its worst case and then tune the antenna tower (from 1 m to 4 m) and turntable (from 0 degree to 360 degrees) to find the maximum reading. A pre-amp and a high pass filter are used for the test in order to get better signal level. Both horizontal and vertical polarizations of the antenna are set to make the measurement.

3. The EUT was placed on a turntable with 80 cm above ground.

4. The EUT was set 3 meters from the interference receiving antenna, which was mounted on the top of a variable height antenna tower.

5. For measurement below 1GHz, the initial step in collecting conducted emission data is a spectrum analyzer peak detector mode pre-scanning the measurement frequency range. Significant peaks are then marked and then Quasi Peak detector mode re-measured. If the emission level of the EUT measured by the peak detector is 3 dB lower than the applicable limit, the peak emission level will be reported. Otherwise, the emission measurement will be repeated using the quasi-peak detector and reported.

Above 1 GHz:

RBW	1 MHz
VBW	PEAK: 3 MHz AVG: see note 6
Sweep	Auto
Detector	Peak
Trace	Max hold

1. The testing follows the guidelines in ANSI C63.10-2013.

2. The EUT was arranged to its worst case and then tune the antenna tower (from 1 m to 4 m) and turntable (from 0 degree to 360 degrees) to find the maximum reading. A pre-amp and a high pass filter are used for the test in order to get better signal level. Both horizontal and vertical polarizations of the antenna are set to make the measurement.

3. The EUT was placed on a turntable with 1.5m above ground.

4. The EUT was set 3 meters from the interference receiving antenna, which was mounted on the top of a variable height antenna tower.

5. For measurement above 1GHz, the emission measurement will be measured by the peak detector. This peak level, once corrected, must comply with the limit specified in Section 15.209.

6. For measurements above 1 GHz the resolution bandwidth is set to 1 MHz, then the video bandwidth is set to 3 MHz for peak measurements and 1 MHz resolution bandwidth with 1/T video bandwidth with peak detector for AVG measurements. For the Duty Cycle please refer to clause 7.1.On Time And Duty Cycle.

7. Restriction band: Investigated frequency range from 2310 MHz to 2410 MHz and 2470MHz to 2500 MHz.

All restriction band should comply with 15.209, other emission should be at least 20 dB below the fundamental.

Note 1: For all radiated test, EUT in each of three orthogonal axis emissions had been tested, but only the worst case (X axis) data recorded in the report.

Note 2: The EUT does not support simultaneous transmission.

Note 3: The EUT was fully exercised with external accessories during the test. In the case of multiple accessory external ports, an external accessory shall be connected to one of each type of port.

9.4. Results

Pass. (See below detailed test result)

All the emissions except fundamental emission from 9 kHz to 25 GHz were comply with 15.209 limits.

Note1: According exploratory test, the emission levels are 20 dB below the limit detected from 9 kHz to 30 MHz, so the final test was performed with frequency range from 30 MHz to 26 GHz and recorded in below.

Note2: For emissions below 1 GHz, according exploratory explorer test, when change Tx mode and channel, have no distinct influence on emissions level, so for emissions below 1 GHz, the final test was only performed with EUT working in 8DPSK, TX 2480 MHz mode.

Note3: For emissions above 1 GHz. If peak results comply with AV limit, AV Result is deemed to comply with AV limit.

9.5. Original test data

Below 1 GHz and above 30 MHz test data Refer to appendix A

Above 1 GHz test data Refer to appendix B

10. Antenna Requirements

10.1. Limits

Please refer to FCC § 15.203

An intentional radiator shall be designed to ensure that no antenna other than that furnished by the responsible party shall be used with the device. The use of a permanently attached antenna or of an antenna that uses a unique coupling to the intentional radiator shall be considered sufficient to comply with the provisions of this section. The manufacturer may design the unit so that a broken antenna can be replaced by the user, but the use of a standard antenna jack or electrical connector is prohibited.

Please refer to FCC § 15.247(b)(4)

The conducted output power limit specified in paragraph (b) of this section is based on the use of antennas with directional gains that do not exceed 6 dBi. Except as shown in paragraph (c) of this section, if transmitting antennas of directional gain greater than 6 dBi are used, the conducted output power from the intentional radiator shall be reduced below the stated values in paragraphs (b)(1), (b)(2), and (b)(3) of this section, as appropriate, by the amount in dB that the directional gain of the antenna exceeds 6 dBi.

10.2. Result

The antenna used for this product is Shrapnel antenna and that no antenna other than that furnished by the responsible party shall be used with the device, the maximum peak gain of the transmit antenna is 3.32 dBi.

APPENDIX A – Radiated Emission Below 1GHz Test Data

Test Report

Project Information			
EUT:	Wi-Fi Module Integrated Bluetooth	Environment:	22.9°C 46%
Model:	SKI.WB822CU.2	SN:	
Mode:	3DH5_2480	Voltage:	DC 3.3V
Customer:		Engineer:	Soho Liu
Remark:			

Start of Test: 2024-03-16 10:59:40

Test Graph

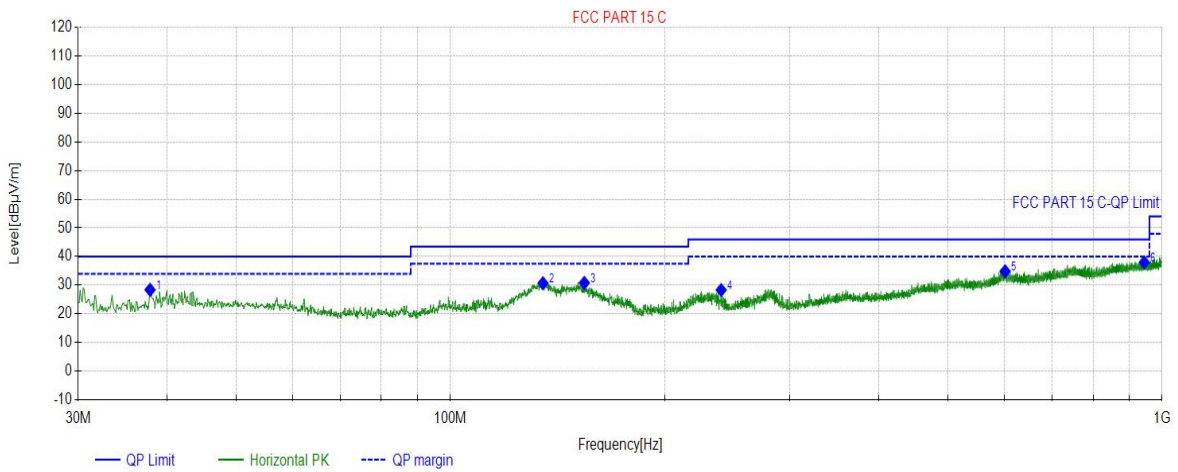

Final Data List								
NO.	Freq. (MHz)	Factor (dB)	QP Value (dBµV/m)	QP Limit (dBµV/m)	Margin (dB)	Height (cm)	Angle (°)	Polarity
1	37.8578	20.27	28.39	40.00	11.61	100	333	Horizontal
2	134.9645	17.10	30.70	43.50	12.80	100	214	Horizontal
3	154.2694	17.34	30.81	43.50	12.69	100	200	Horizontal
4	240.2200	21.07	28.34	46.00	17.66	100	228	Horizontal
5	601.8722	30.11	34.86	46.00	11.14	100	172	Horizontal
6	944.2194	34.66	37.97	46.00	8.03	100	254	Horizontal

Test Report

Project Information			
EUT:	Wi-Fi Module Integrated Bluetooth	Environment:	22.9°C 46%
Model:	SKI.WB822CU.2	SN:	
Mode:	3DH5_2480	Voltage:	DC 3.3V
Customer:		Engineer:	Soho Liu
Remark:			

Start of Test: 2024-03-16 11:00:24

Test Graph

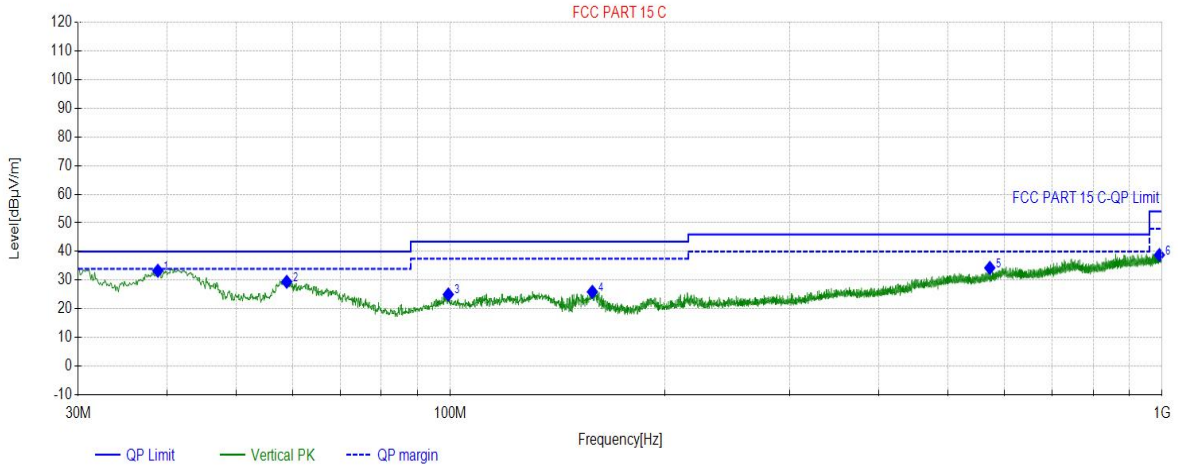

Final Data List								
NO.	Freq. (MHz)	Factor (dB)	QP Value (dBµV/m)	QP Limit (dBµV/m)	Margin (dB)	Height (cm)	Angle (°)	Polarity
1	38.8279	20.66	33.30	40.00	6.70	100	157	Vertical
2	58.9089	21.14	29.46	40.00	10.54	100	181	Vertical
3	99.3619	20.63	25.04	43.50	18.46	100	302	Vertical
4	158.3438	17.47	25.95	43.50	17.55	100	144	Vertical
5	572.7693	29.10	34.31	46.00	11.69	100	64	Vertical
6	991.4631	35.23	38.82	54.00	15.18	100	338	Vertical

APPENDIX B – Radiated Emission Above 1GHz Test Data

Test Report

Project Information			
EUT:	Wi-Fi Module Integrated Bluetooth	Environment:	22.1°C 48%
Model:	SKI.WB822CU.2	SN:	
Mode:	BT_3DH5_2402	Voltage:	DC 3.3V
Customer:		Engineer:	Winnie Meng
Remark:			

Start of Test: 2024-03-05 18:42:31

Test Graph

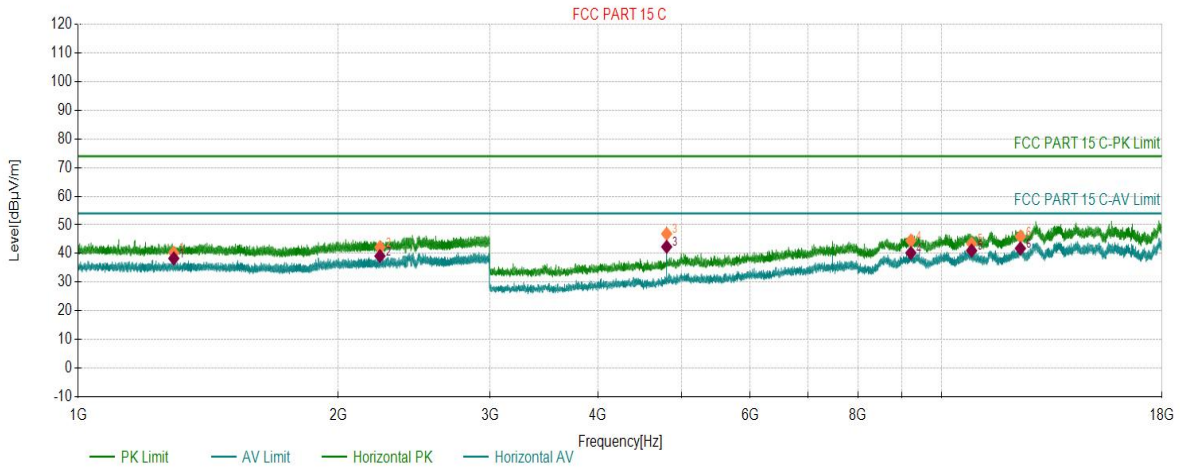

PK Final Data List								
NO.	Freq. (MHz)	Factor (dB)	PK Value (dBµV/m)	PK Limit (dBµV/m)	PK Margin (dB)	Height (cm)	Angle (°)	Polarity
1	1290.5145	2.61	40.31	74.00	33.69	150	4	Horizontal
2	2236.1618	5.99	42.24	74.00	31.76	150	353	Horizontal
3	4803.8402	-9.95	46.89	74.00	27.11	150	343	Horizontal
4	9212.5606	3.48	44.52	74.00	29.48	150	166	Horizontal
5	10833.3917	5.52	43.46	74.00	30.54	150	147	Horizontal
6	12337.9669	7.14	45.92	74.00	28.08	150	313	Horizontal

AV Final Data List								
NO.	Freq. (MHz)	Factor (dB)	AV Value (dBµV/m)	AV Limit (dBµV/m)	AV Margin (dB)	Height (cm)	Angle (°)	Polarity
1	1290.5145	2.61	38.30	54.00	15.70	150	4	Horizontal
2	2236.1618	5.99	39.13	54.00	14.87	150	353	Horizontal
3	4803.8402	-9.95	42.35	54.00	11.65	150	343	Horizontal
4	9212.5606	3.48	40.22	54.00	13.78	150	166	Horizontal
5	10833.3917	5.52	41.04	54.00	12.96	150	147	Horizontal
6	12337.9669	7.14	41.79	54.00	12.21	150	313	Horizontal

Test Report

Project Information			
EUT:	Wi-Fi Module Integrated Bluetooth	Environment:	22.1°C 48%
Model:	SKI.WB822CU.2	SN:	
Mode:	BT_3DH5_2402	Voltage:	DC 3.3V
Customer:		Engineer:	Winnie Meng
Remark:			

Start of Test: 2024-03-05 18:44:14

Test Graph

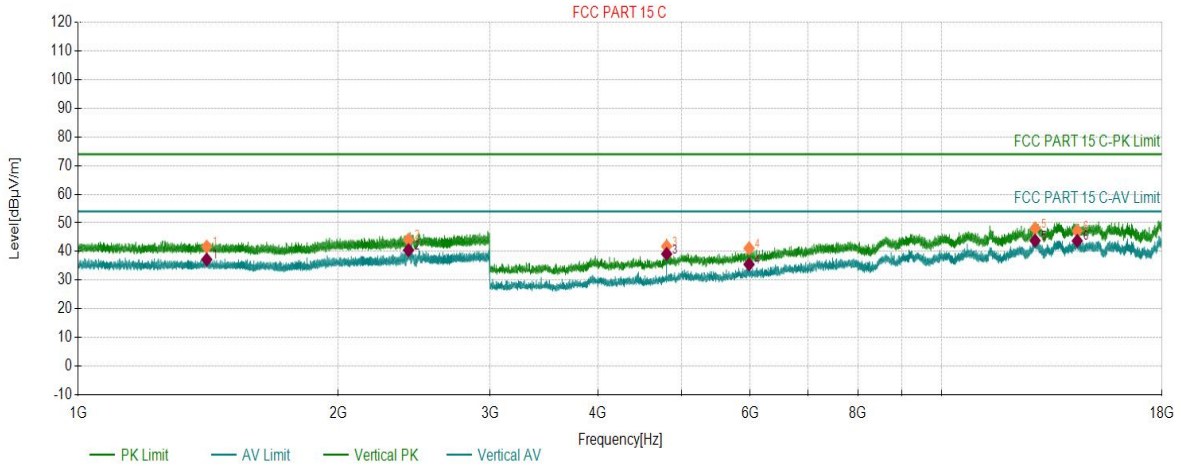

PK Final Data List

NO.	Freq. (MHz)	Factor (dB)	PK Value (dBµV/m)	PK Limit (dBµV/m)	PK Margin (dB)	Height (cm)	Angle (°)	Polarity
1	1409.0205	3.27	41.71	74.00	32.29	150	26	Vertical
2	2413.3707	7.20	44.11	74.00	29.89	150	240	Vertical
3	4803.8402	-9.95	41.82	74.00	32.18	150	100	Vertical
4	5983.6492	-5.95	41.13	74.00	32.87	150	130	Vertical
5	12830.7415	9.43	48.12	74.00	25.88	150	294	Vertical
6	14357.8179	11.13	47.18	74.00	26.82	150	109	Vertical

AV Final Data List

NO.	Freq. (MHz)	Factor (dB)	AV Value (dBµV/m)	AV Limit (dBµV/m)	AV Margin (dB)	Height (cm)	Angle (°)	Polarity
1	1409.0205	3.27	37.22	54.00	16.78	150	26	Vertical
2	2413.3707	7.20	40.48	54.00	13.52	150	240	Vertical
3	4803.8402	-9.95	39.15	54.00	14.85	150	100	Vertical
4	5983.6492	-5.95	35.54	54.00	18.46	150	130	Vertical
5	12830.7415	9.43	43.82	54.00	10.18	150	294	Vertical
6	14357.8179	11.13	43.72	54.00	10.28	150	109	Vertical

Test Report

Project Information			
EUT:	Wi-Fi Module Integrated Bluetooth	Environment:	22.1°C 48%
Model:	SKI.WB822CU.2	SN:	
Mode:	BT_3DH5_2480	Voltage:	DC 3.3V
Customer:		Engineer:	Winnie Meng
Remark:			

Start of Test: 2024-03-05 18:56:50

Test Graph

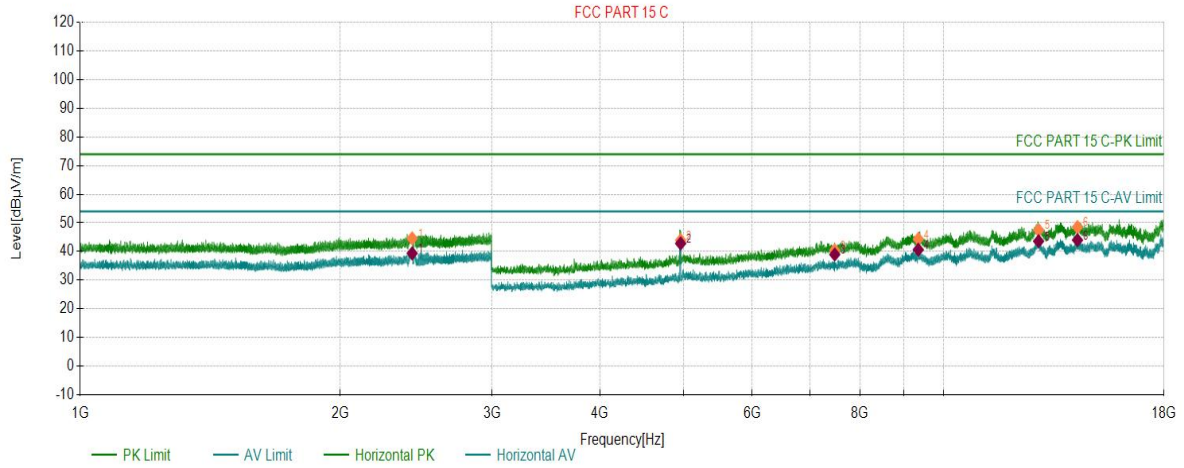

PK Final Data List

NO.	Freq. (MHz)	Factor (dB)	PK Value (dBµV/m)	PK Limit (dBµV/m)	PK Margin (dB)	Height (cm)	Angle (°)	Polarity
1	2423.7712	7.26	44.60	74.00	29.40	150	141	Horizontal
2	4959.8480	-8.89	43.97	74.00	30.03	150	260	Horizontal
3	7479.9740	-1.25	40.48	74.00	33.52	150	222	Horizontal
4	9346.8173	3.65	44.38	74.00	29.62	150	339	Horizontal
5	12881.7441	9.38	47.50	74.00	26.50	150	75	Horizontal
6	14289.5645	11.08	48.54	74.00	25.46	150	222	Horizontal

AV Final Data List

NO.	Freq. (MHz)	Factor (dB)	AV Value (dBµV/m)	AV Limit (dBµV/m)	AV Margin (dB)	Height (cm)	Angle (°)	Polarity
1	2423.7712	7.26	39.38	54.00	14.62	150	141	Horizontal
2	4959.8480	-8.89	42.83	54.00	11.17	150	260	Horizontal
3	7479.9740	-1.25	38.98	54.00	15.02	150	222	Horizontal
4	9346.8173	3.65	40.66	54.00	13.34	150	339	Horizontal
5	12881.7441	9.38	43.62	54.00	10.38	150	75	Horizontal
6	14289.5645	11.08	44.00	54.00	10.00	150	222	Horizontal

Test Report

Project Information			
EUT:	Wi-Fi Module Integrated Bluetooth	Environment:	22.1°C 48%
Model:	SKI.WB822CU.2	SN:	
Mode:	BT_3DH5_2480	Voltage:	DC 3.3V
Customer:		Engineer:	Winnie Meng
Remark:			

Start of Test: 2024-03-05 18:58:34

Test Graph

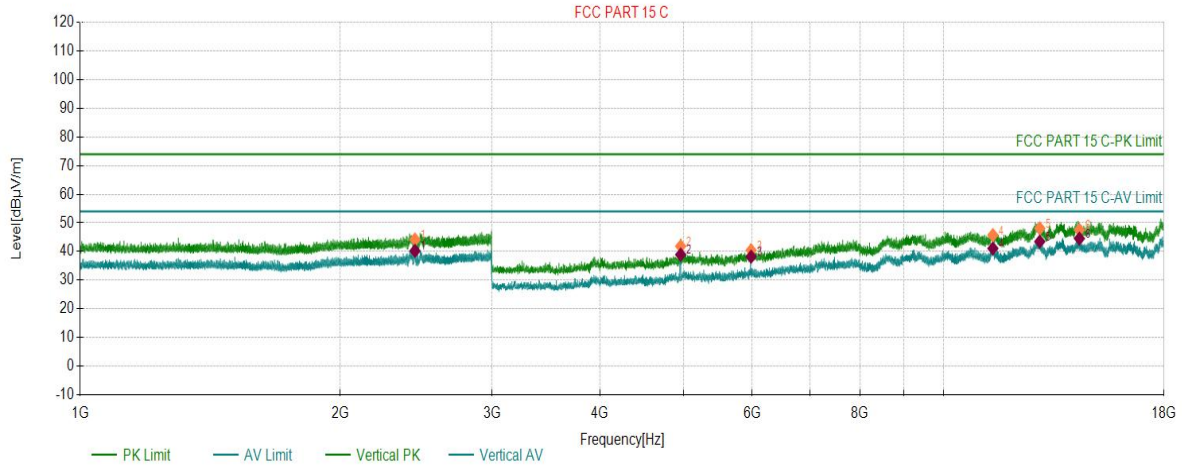

PK Final Data List

NO.	Freq. (MHz)	Factor (dB)	PK Value (dBµV/m)	PK Limit (dBµV/m)	PK Margin (dB)	Height (cm)	Angle (°)	Polarity
1	2442.0721	7.37	44.22	74.00	29.78	150	217	Vertical
2	4959.8480	-8.89	41.86	74.00	32.14	150	36	Vertical
3	5985.1493	-5.94	40.48	74.00	33.52	150	119	Vertical
4	11404.9202	6.42	45.76	74.00	28.24	150	244	Vertical
5	12922.9962	9.37	48.11	74.00	25.89	150	36	Vertical
6	14363.0682	11.14	47.55	74.00	26.45	150	215	Vertical

AV Final Data List

NO.	Freq. (MHz)	Factor (dB)	AV Value (dBµV/m)	AV Limit (dBµV/m)	AV Margin (dB)	Height (cm)	Angle (°)	Polarity
1	2442.0721	7.37	40.24	54.00	13.76	150	217	Vertical
2	4959.8480	-8.89	38.93	54.00	15.07	150	36	Vertical
3	5985.1493	-5.94	38.22	54.00	15.78	150	119	Vertical
4	11404.9202	6.42	41.09	54.00	12.91	150	244	Vertical
5	12922.9962	9.37	43.50	54.00	10.50	150	36	Vertical
6	14363.0682	11.14	44.54	54.00	9.46	150	215	Vertical

Test Report

Project Information			
EUT:	Wi-Fi Module Integrated Bluetooth	Environment:	22.9°C 46%
Model:	SKI.WB822CU.2	SN:	
Mode:	3DH5_2441	Voltage:	DC 3.3V
Customer:		Engineer:	Soho Liu
Remark:			

Start of Test: 2024-03-21 20:11:32

Test Graph

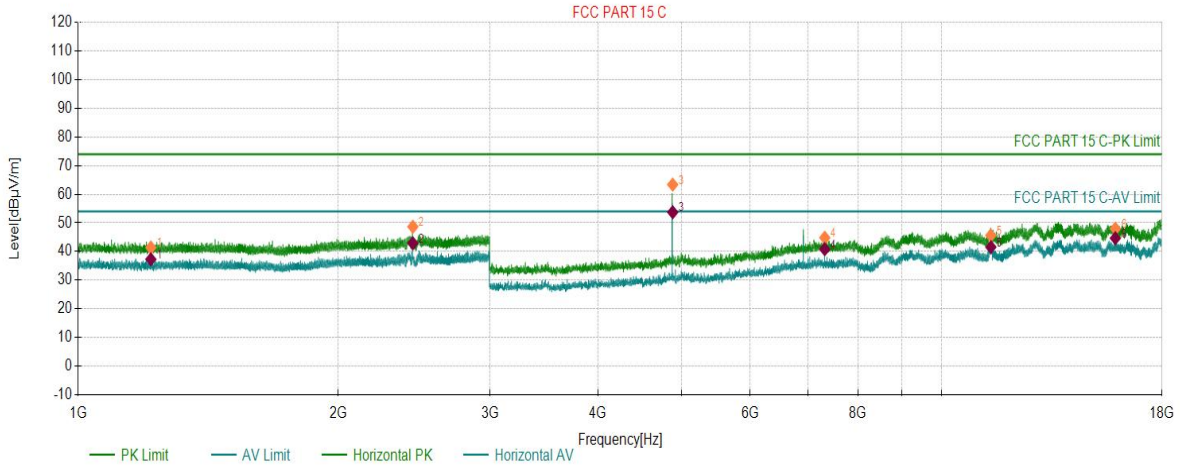

PK Final Data List								
NO.	Freq. (MHz)	Factor (dB)	PK Value (dBµV/m)	PK Limit (dBµV/m)	PK Margin (dB)	Height (cm)	Angle (°)	Polarity
1	1213.9107	2.33	41.40	74.00	32.60	150	233	Horizontal
2	2441.2721	7.37	48.66	74.00	25.34	150	51	Horizontal
3	4881.9641	-9.44	63.36	74.00	10.64	125.3	73.7	Horizontal
4	7323.2162	-1.25	44.82	74.00	29.18	150	272	Horizontal
5	11403.4202	6.44	45.65	74.00	28.35	150	262	Horizontal
6	15893.1447	12.29	47.99	74.00	26.01	150	353	Horizontal

AV Final Data List								
NO.	Freq. (MHz)	Factor (dB)	AV Value (dBµV/m)	AV Limit (dBµV/m)	AV Margin (dB)	Height (cm)	Angle (°)	Polarity
1	1213.9107	2.33	37.30	54.00	16.70	150	233	Horizontal
2	2441.2721	7.37	42.91	54.00	11.09	150	51	Horizontal
3	4881.9641	-9.44	53.72	54.00	0.28	125.3	73.7	Horizontal
4	7323.2162	-1.25	40.84	54.00	13.16	150	272	Horizontal
5	11403.4202	6.44	41.57	54.00	12.43	150	262	Horizontal
6	15893.1447	12.29	44.69	54.00	9.31	150	353	Horizontal

Test Report

Project Information			
EUT:	Wi-Fi Module Integrated Bluetooth	Environment:	22.9°C 46%
Model:	SKI.WB822CU.2	SN:	
Mode:	3DH5_2441	Voltage:	DC 3.3V
Customer:		Engineer:	Soho Liu
Remark:			

Start of Test: 2024-03-21 20:13:05

Test Graph

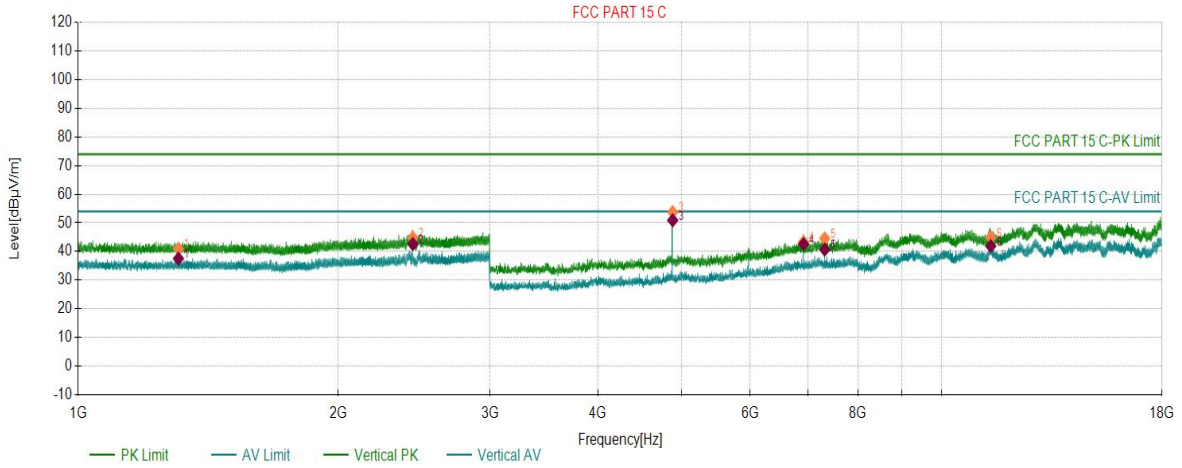

PK Final Data List

NO.	Freq. (MHz)	Factor (dB)	PK Value (dBµV/m)	PK Limit (dBµV/m)	PK Margin (dB)	Height (cm)	Angle (°)	Polarity
1	1306.6153	2.69	41.00	74.00	33.00	150	310	Vertical
2	2441.2721	7.37	44.87	74.00	29.13	150	360	Vertical
3	4881.8441	-9.45	53.76	74.00	20.24	150	319	Vertical
4	6919.6960	-2.45	43.35	74.00	30.65	150	328	Vertical
5	7322.4661	-1.25	44.58	74.00	29.42	150	48	Vertical
6	11400.4200	6.47	44.90	74.00	29.10	150	77	Vertical

AV Final Data List

NO.	Freq. (MHz)	Factor (dB)	AV Value (dBµV/m)	AV Limit (dBµV/m)	AV Margin (dB)	Height (cm)	Angle (°)	Polarity
1	1306.6153	2.69	37.56	54.00	16.44	150	310	Vertical
2	2441.2721	7.37	42.63	54.00	11.37	150	360	Vertical
3	4881.8441	-9.45	50.91	54.00	3.09	150	319	Vertical
4	6919.6960	-2.45	42.61	54.00	11.39	150	328	Vertical
5	7322.4661	-1.25	40.69	54.00	13.31	150	48	Vertical
6	11400.4200	6.47	41.92	54.00	12.08	150	77	Vertical

Test Report

Project Information			
EUT:	Wi-Fi Module Integrated Bluetooth	Environment:	22.1°C 48%
Model:	SKI.WB822CU.2	SN:	
Mode:	BT_DH5_2402	Voltage:	DC 3.3V
Customer:		Engineer:	Winnie Meng
Remark:			

Start of Test: 2024-03-05 17:49:56

Test Graph

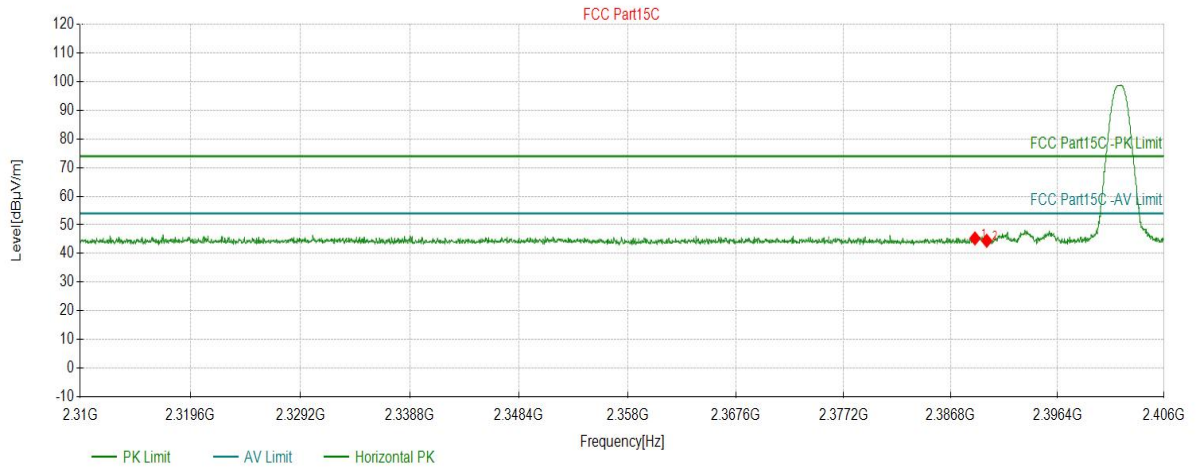

Suspected Data List

NO.	Freq. (MHz)	Level (dBµV/m)	Factor (dB)	Limit (dBµV/m)	Margin (dB)	Height (cm)	Angle (°)	Detector	Polarity
1	2388.9703	45.30	5.65	74.00	28.70	150	337	PK	Horizont
2	2390.0267	44.47	5.65	74.00	29.53	150	353	PK	Horizont

Test Report

Project Information			
EUT:	Wi-Fi Module Integrated Bluetooth	Environment:	22.1°C 48%
Model:	SKI.WB822CU.2	SN:	
Mode:	BT_DH5_2402	Voltage:	DC 3.3V
Customer:		Engineer:	Winnie Meng
Remark:			

Start of Test: 2024-03-05 17:50:49

Test Graph

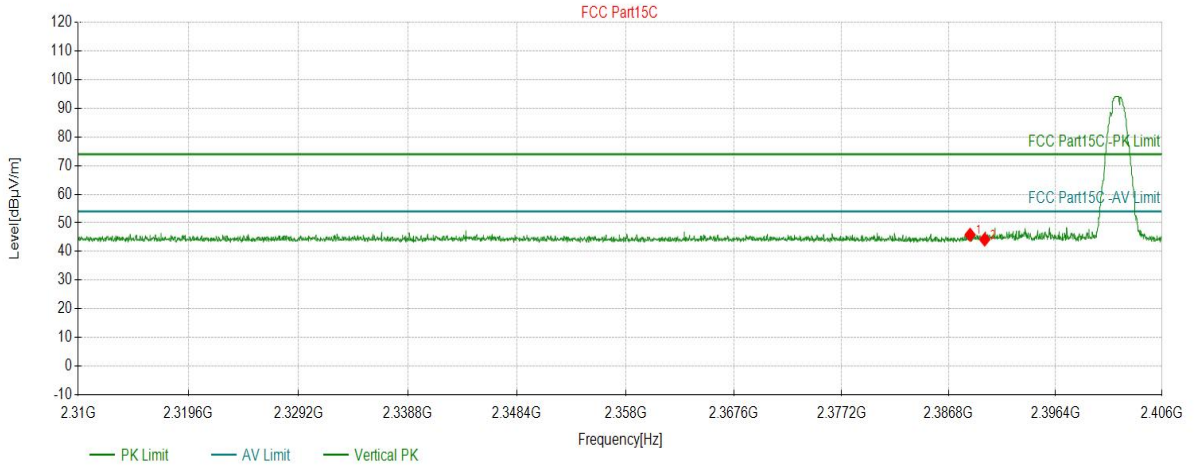

Suspected Data List

NO.	Freq. (MHz)	Level (dBµV/m)	Factor (dB)	Limit (dBµV/m)	Margin (dB)	Height (cm)	Angle (°)	Detector	Polarity
1	2388.7142	45.86	5.65	74.00	28.14	150	70	PK	Vertical
2	2390.0267	44.21	5.65	74.00	29.79	150	153	PK	Vertical

Test Report

Project Information			
EUT:	Wi-Fi Module Integrated Bluetooth	Environment:	22.1°C 48%
Model:	SKI.WB822CU.2	SN:	
Mode:	BT_DH5_2480	Voltage:	DC 3.3V
Customer:		Engineer:	Winnie Meng
Remark:			

Start of Test: 2024-03-05 17:55:40

Test Graph

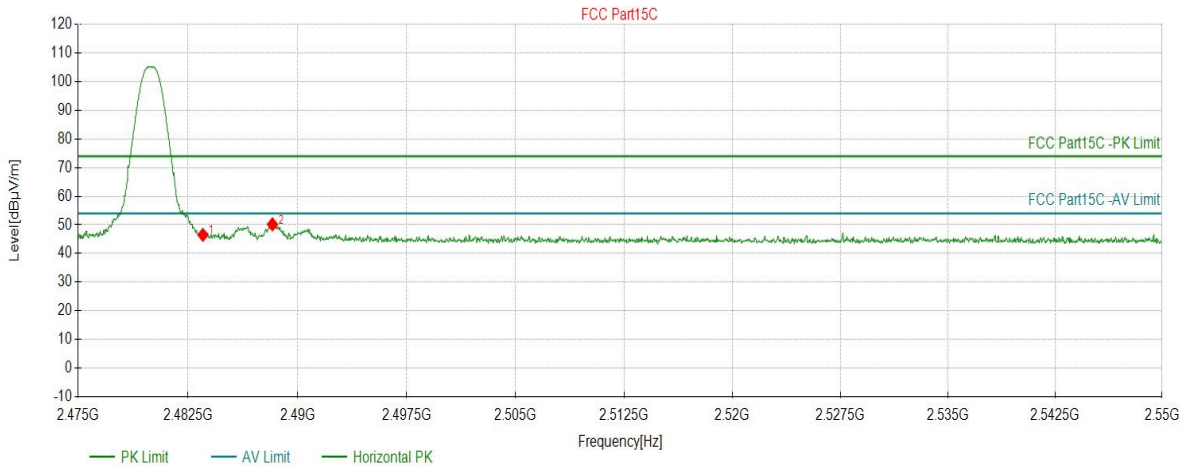

Suspected Data List

NO.	Freq. (MHz)	Level (dBµV/m)	Factor (dB)	Limit (dBµV/m)	Margin (dB)	Height (cm)	Angle (°)	Detector	Polarity
1	2483.5168	46.53	6.24	74.00	27.47	150	271	PK	Horizont
2	2488.2816	50.20	6.28	74.00	23.80	150	210	PK	Horizont

Test Report

Project Information			
EUT:	Wi-Fi Module Integrated Bluetooth	Environment:	22.1°C 48%
Model:	SKI.WB822CU.2	SN:	
Mode:	BT_DH5_2480	Voltage:	DC 3.3V
Customer:		Engineer:	Winnie Meng
Remark:			

Start of Test: 2024-03-05 17:56:28

Test Graph

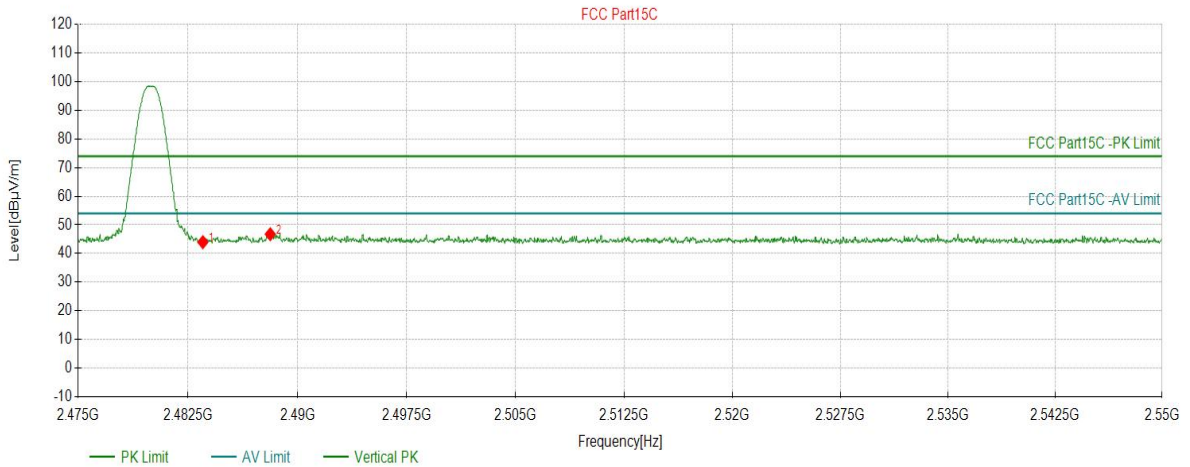

Suspected Data List

NO.	Freq. (MHz)	Level (dBµV/m)	Factor (dB)	Limit (dBµV/m)	Margin (dB)	Height (cm)	Angle (°)	Detector	Polarity
1	2483.5168	43.99	6.24	74.00	30.01	150	124	PK	Vertical
2	2488.1316	46.75	6.27	74.00	27.25	150	50	PK	Vertical

Test Report

Project Information			
EUT:	Wi-Fi Module Integrated Bluetooth	Environment:	22.1°C 48%
Model:	SKI.WB822CU.2	SN:	
Mode:	BT_2DH5_2402	Voltage:	DC 3.3V
Customer:		Engineer:	Winnie Meng
Remark:			

Start of Test: 2024-03-05 18:16:48

Test Graph

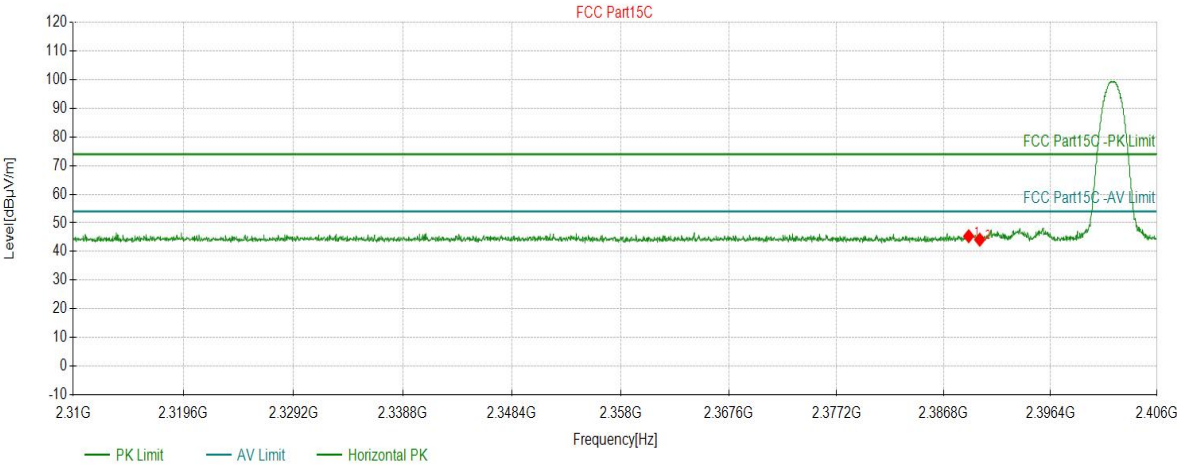

Suspected Data List									
NO.	Freq. (MHz)	Level (dBµV/m)	Factor (dB)	Limit (dBµV/m)	Margin (dB)	Height (cm)	Angle (°)	Detector	Polarity
1	2389.0343	45.36	5.65	74.00	28.64	150	328	PK	Horizont
2	2390.0267	44.15	5.65	74.00	29.85	150	104	PK	Horizont

Test Report

Project Information			
EUT:	Wi-Fi Module Integrated Bluetooth	Environment:	22.1°C 48%
Model:	SKI.WB822CU.2	SN:	
Mode:	BT_2DH5_2402	Voltage:	DC 3.3V
Customer:		Engineer:	Winnie Meng
Remark:			

Start of Test: 2024-03-05 18:17:49

Test Graph

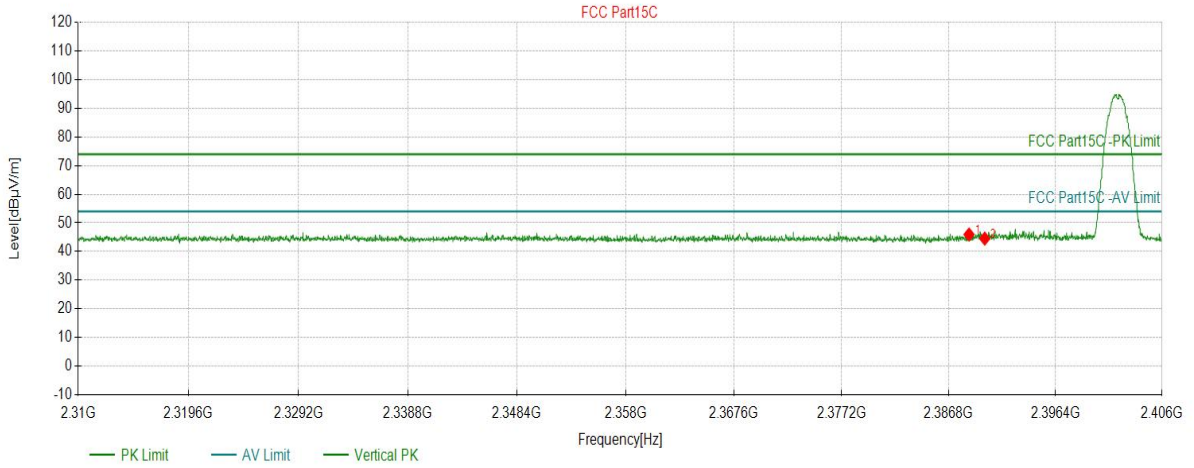

Suspected Data List

NO.	Freq. (MHz)	Level (dBµV/m)	Factor (dB)	Limit (dBµV/m)	Margin (dB)	Height (cm)	Angle (°)	Detector	Polarity
1	2388.6182	45.97	5.65	74.00	28.03	150	100	PK	Vertical
2	2390.0267	44.53	5.65	74.00	29.47	150	222	PK	Vertical

Test Report

Project Information			
EUT:	Wi-Fi Module Integrated Bluetooth	Environment:	22.1°C 48%
Model:	SKI.WB822CU.2	SN:	
Mode:	BT_2DH5_2480	Voltage:	DC 3.3V
Customer:		Engineer:	Winnie Meng
Remark:			

Start of Test: 2024-03-05 18:20:25

Test Graph

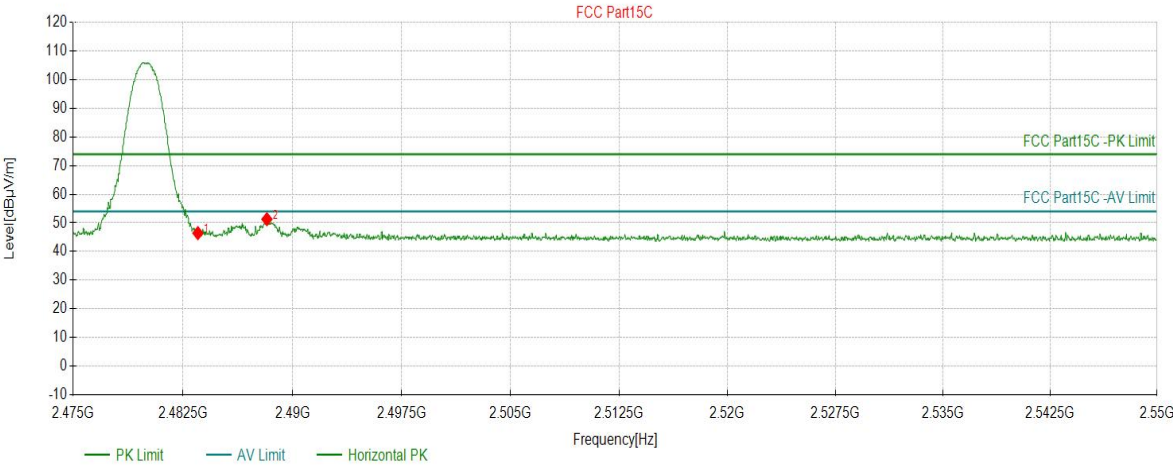

Suspected Data List									
NO.	Freq. (MHz)	Level (dBµV/m)	Factor (dB)	Limit (dBµV/m)	Margin (dB)	Height (cm)	Angle (°)	Detector	Polarity
1	2483.5168	46.43	6.24	74.00	27.57	150	207	PK	Horizont
2	2488.2441	51.29	6.28	74.00	22.71	150	210	PK	Horizont

Test Report

Project Information			
EUT:	Wi-Fi Module Integrated Bluetooth	Environment:	22.1°C 48%
Model:	SKI.WB822CU.2	SN:	
Mode:	BT_2DH5_2480	Voltage:	DC 3.3V
Customer:		Engineer:	Winnie Meng
Remark:			

Start of Test: 2024-03-05 18:21:14

Test Graph

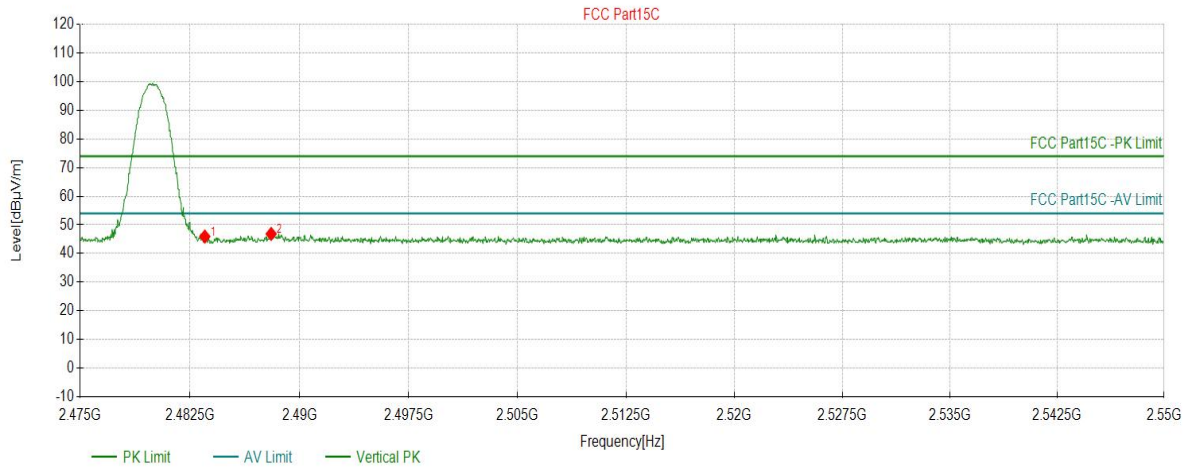

Suspected Data List									
NO.	Freq. (MHz)	Level (dBµV/m)	Factor (dB)	Limit (dBµV/m)	Margin (dB)	Height (cm)	Angle (°)	Detector	Polarity
1	2483.5168	45.94	6.24	74.00	28.06	150	257	PK	Vertical
2	2488.0565	46.86	6.27	74.00	27.14	150	24	PK	Vertical

Test Report

Project Information			
EUT:	Wi-Fi Module Integrated Bluetooth	Environment:	22.1°C 48%
Model:	SKI.WB822CU.2	SN:	
Mode:	BT_3DH5_2402	Voltage:	DC 3.3V
Customer:		Engineer:	Winnie Meng
Remark:			

Start of Test: 2024-03-05 18:23:19

Test Graph

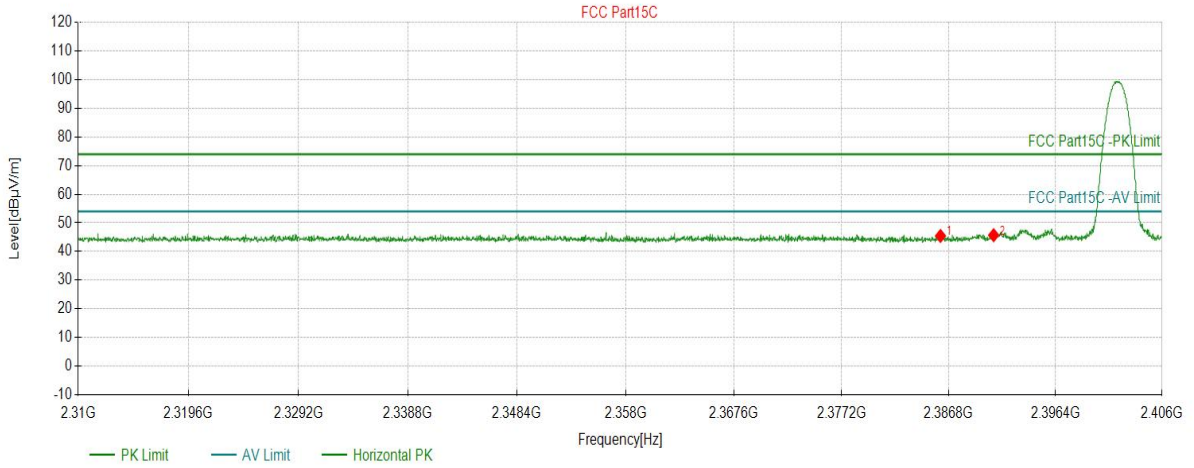

Suspected Data List

NO.	Freq. (MHz)	Level (dBµV/m)	Factor (dB)	Limit (dBµV/m)	Margin (dB)	Height (cm)	Angle (°)	Detector	Polarity
1	2386.0574	45.46	5.65	74.00	28.54	150	141	PK	Horizont
2	2390.8269	45.72	5.65	74.00	28.28	150	121	PK	Horizont

Test Report

Project Information			
EUT:	Wi-Fi Module Integrated Bluetooth	Environment:	22.1°C 48%
Model:	SKI.WB822CU.2	SN:	
Mode:	BT_3DH5_2402	Voltage:	DC 3.3V
Customer:		Engineer:	Winnie Meng
Remark:			

Start of Test: 2024-03-05 18:24:20

Test Graph

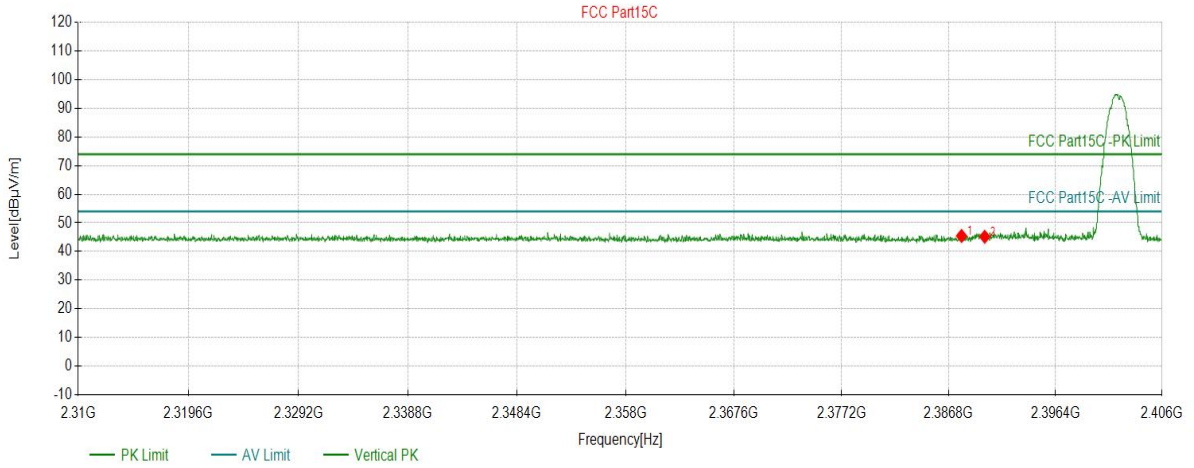

Suspected Data List

NO.	Freq. (MHz)	Level (dBµV/m)	Factor (dB)	Limit (dBµV/m)	Margin (dB)	Height (cm)	Angle (°)	Detector	Polarity
1	2387.9460	45.46	5.65	74.00	28.54	150	330	PK	Vertical
2	2390.0267	45.17	5.65	74.00	28.83	150	125	PK	Vertical

Test Report

Project Information			
EUT:	Wi-Fi Module Integrated Bluetooth	Environment:	22.1°C 48%
Model:	SKI.WB822CU.2	SN:	
Mode:	BT_3DH5_2402	Voltage:	DC 3.3V
Customer:		Engineer:	Winnie Meng
Remark:	power set : 0xef		

Start of Test: 2024-03-05 18:50:26

Test Graph

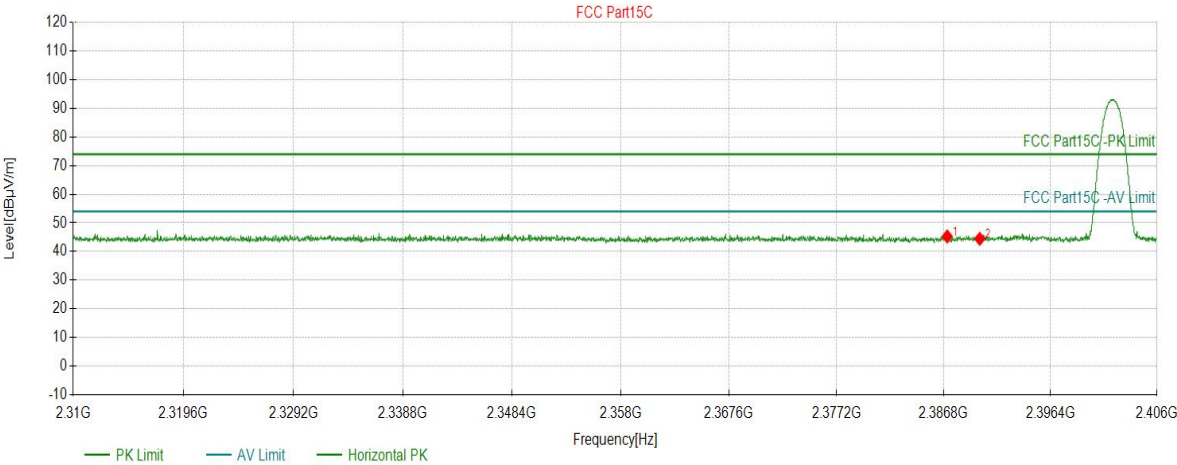

Suspected Data List

NO.	Freq. (MHz)	Level (dBµV/m)	Factor (dB)	Limit (dBµV/m)	Margin (dB)	Height (cm)	Angle (°)	Detector	Polarity
1	2387.1137	45.27	5.65	74.00	28.73	150	317	PK	Horizont
2	2390.0267	44.43	5.65	74.00	29.57	150	358	PK	Horizont

Test Report

Project Information			
EUT:	Wi-Fi Module Integrated Bluetooth	Environment:	22.1°C 48%
Model:	SKI.WB822CU.2	SN:	
Mode:	BT_3DH5_2402	Voltage:	DC 3.3V
Customer:		Engineer:	Winnie Meng
Remark:	power set : 0xef		

Start of Test: 2024-03-05 18:51:18

Test Graph

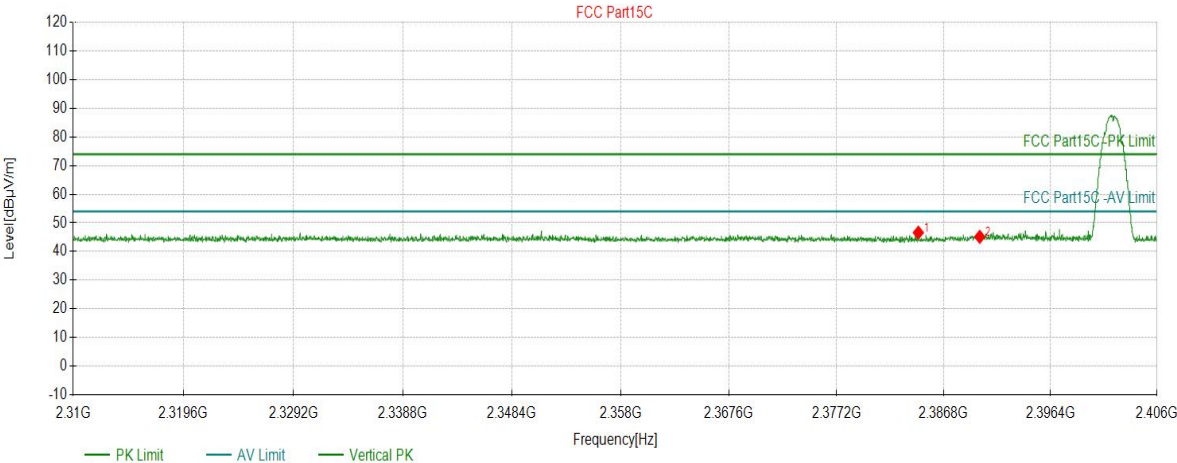

Suspected Data List									
NO.	Freq. (MHz)	Level (dBµV/m)	Factor (dB)	Limit (dBµV/m)	Margin (dB)	Height (cm)	Angle (°)	Detector	Polarity
1	2384.5208	46.60	5.66	74.00	27.40	150	68	PK	Vertical
2	2390.0267	45.14	5.65	74.00	28.86	150	110	PK	Vertical

Test Report

Project Information			
EUT:	Wi-Fi Module Integrated Bluetooth	Environment:	22.1°C 48%
Model:	SKI.WB822CU.2	SN:	
Mode:	BT_3DH5_2480	Voltage:	DC 3.3V
Customer:		Engineer:	Winnie Meng
Remark:	power set : 0xef		

Start of Test: 2024-03-05 18:54:53

Test Graph

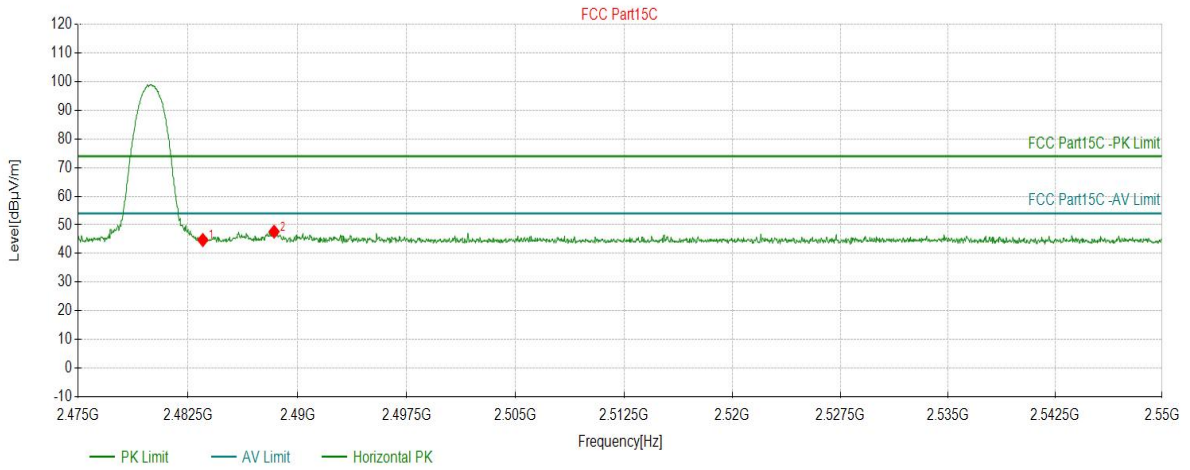

Suspected Data List

NO.	Freq. (MHz)	Level (dBµV/m)	Factor (dB)	Limit (dBµV/m)	Margin (dB)	Height (cm)	Angle (°)	Detector	Polarity
1	2483.5168	44.73	6.24	74.00	29.27	150	209	PK	Horizont
2	2488.3942	47.64	6.28	74.00	26.36	150	317	PK	Horizont

Test Report

Project Information			
EUT:	Wi-Fi Module Integrated Bluetooth	Environment:	22.1°C 48%
Model:	SKI.WB822CU.2	SN:	
Mode:	BT_3DH5_2480	Voltage:	DC 3.3V
Customer:		Engineer:	Winnie Meng
Remark:	power set : 0xef		

Start of Test: 2024-03-05 18:55:43

Test Graph

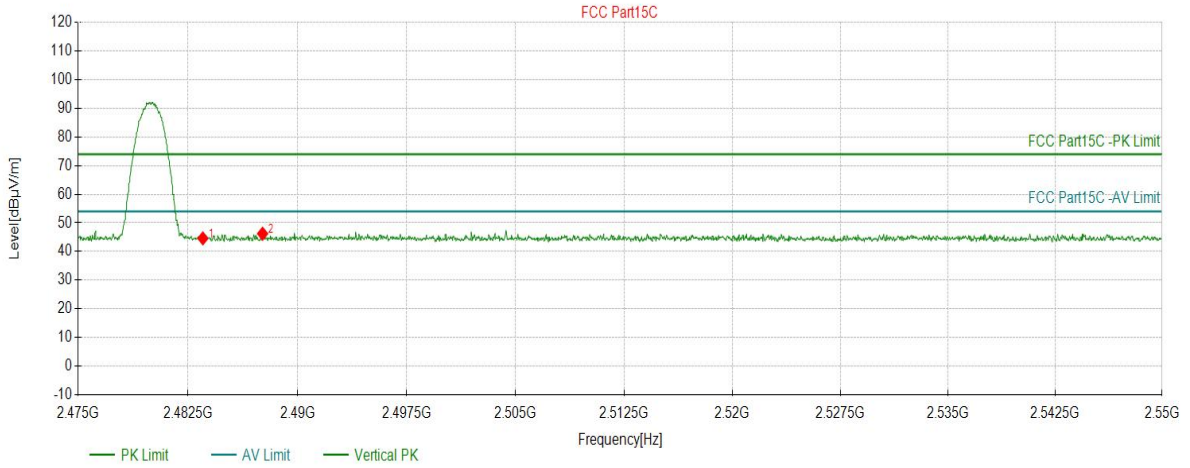

Suspected Data List									
NO.	Freq. (MHz)	Level (dBµV/m)	Factor (dB)	Limit (dBµV/m)	Margin (dB)	Height (cm)	Angle (°)	Detector	Polarity
1	2483.5168	44.61	6.24	74.00	29.39	150	267	PK	Vertical
2	2487.6063	46.24	6.27	74.00	27.76	150	116	PK	Vertical

END OF REPORT