

承 认 书

客户：合肥京东方视讯科技有限公司

品名：WIFI-2 天线组件

料号：61005-00497

型号：ANT Cable_接收线__320mm(黑) / _散装料_VIZIO_ 中天
迅_SKD

机种：VIZIO D32

日期：2022-04-13

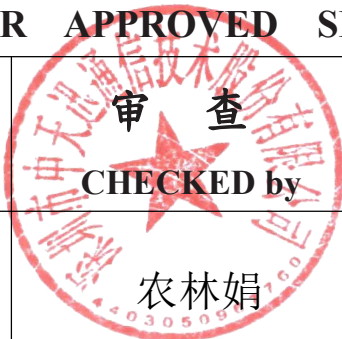
供 应 商 签 核		
SUPPLIER APPROVED SIGNATURES		
担 当 PREPARED by	审 查 CHECKED by	核 准 APPROVED by
赖宁平	 农林娟	邹国华

供应商名称：深圳市中天迅通信技术股份有限公司

供应商地址：深圳市宝安区石岩镇石龙大道 34 号(腾达工业园)

供应商电话：0755-27588320

供应商传真：0755-27588045

产品环保要求:

请在方框内打勾确认

是 否 无卤 HF(Br<900ppm, Cl<900ppm, Br+Cl<1500ppm)

SPECIFICATION

SHEET FOR APPROVAL

(Revision: R: A2)

CUSTOMER(客户名称)	合肥京东方视讯科技有限公司	
CS P/N(客户机种)	VIZIO D32	TD32
PART NAME(品名)	WIFI-2 天线组件	
FREQUENCY(频率)	2.4~2.5GHz+5.15~5.85GHz	
ZTX NO.(物料编号)	2.00005462	
DATE(日期)	2022-04-13	

CUSTOMER			
QA CHECKED	ME CHECKED	RF CHECKED	MANAGER CHECKED

Remark(备注):

Sign(客户确认签字盖章): _____

ZHONG TIAN XUN TECHNOLOGY CO., LTD				
MANAGER CHECKED	MANAGER CHECKED	ME CHECKED	RF CHECKED	LISTER
		赖宁平	农林娟	



深圳市中天迅通信技术股份有限公司

SHENZHEN ZHONGTIAN XUN Communication Technology Co., Ltd.

地址: 深圳市宝安区石岩镇石龙大道 34 号(腾达工业园) 邮编: 518000

电话: 0755-27588320 传真: 0755-27588045 <http://www.chinaztx.com>

ANTENNA SPECIFICATION

CUS P/N :VIZIO D32 WIFI-2 天线组件

ApplicationDate:APR,13,2022

Rev: R:A2

ZTX P/N :VIZIO D32 WIFI-2 天线组件

Editor:

Index

	承认书封页	1
	规格变更履历表	2
	产品环保要求	3
	项目信息表	4
	Index	5
1	Mechanical Specification	6
1-1	Mechanical Specification (WIFI-2 天线组件)	6
2	Reliability Test Report	7~11
3	Test equipment	12
4	Antenna test data	13
4-1	VSWR	13
4-2	No-source test data	13
4-3	Directional drawing of horizontal plane of&3D radiation drawing	14~15
4-4	产品实物图	15
5	产品成分表	16
6	RoHS 限用物质成分表	16
7	REACH 声明	17
8	符合性声明	18
9	Wire specification	19
10	RF CONNECTOR Product Specification	20~34
11	Shipping inspection reference book	35
12	The packing way	36

ANTENNA SPECIFICATION

CUS P/N :VIZIO D32 WIFI-2 天线组件
ZTX P/N :VIZIO D32 WIFI-2 天线组件

ApplicationDate:APR,13,2022
Editor:

Rev: R:A2

1. Mechanical Specification

1-1 Mechanical Configuration (WIFI-2 天线组件)

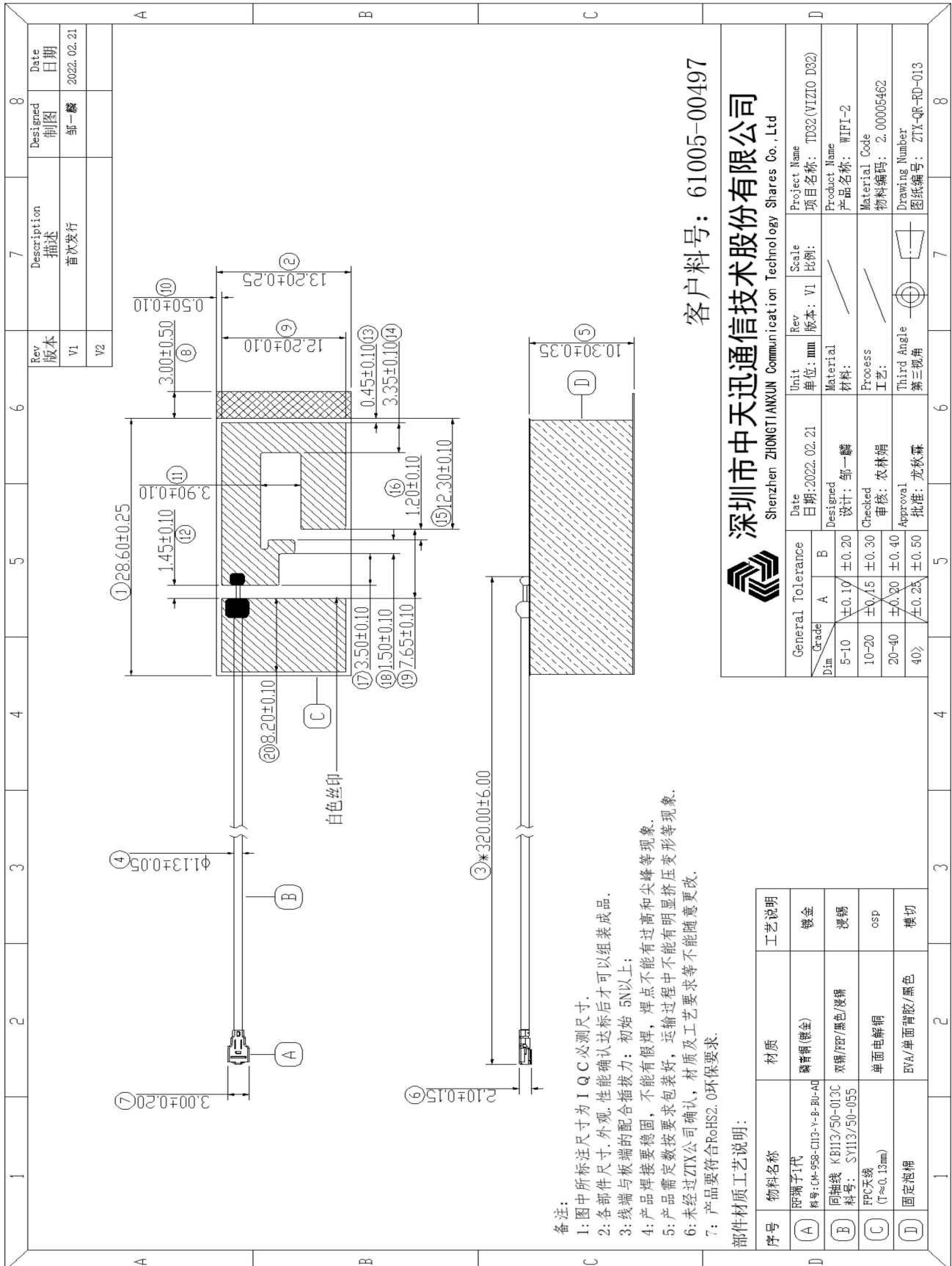

ANTENNA SPECIFICATION

CUS P/N :VIZIO D32 WIFI-2 天线组件
ZTX P/N :VIZIO D32 WIFI-2 天线组件

ApplicationDate:APR,13,2022
Editor:

Rev: R:A2

2. Reliability Test Report



样品检测报告

客户名称	京东方	产品名称	VIZIO D32 WIFI-2									数量	10PCS
产品材质	FPC+同轴线	材料颜色	同轴线+黑线									日期	2022/2/21
产品类型: <input checked="" type="checkbox"/> 新模样品 <input type="checkbox"/> 改模样品 <input type="checkbox"/> 量产 <input type="checkbox"/> 其它													
NO	工程图纸要求尺寸	实测尺寸										判定	备注
		1	2	3	4	5	6	7	8	9	10		
1	28.60±0.25	28.55	28.53	28.55	28.59	28.60	28.54	28.55	28.53	28.52	28.51	OK	
2	13.20±0.25	13.16	13.19	13.19	13.14	13.15	13.17	13.16	13.19	13.18	13.17	OK	
3	320±6.00	321	320	320	320	321	321	321	320	321	321	OK	
4	1.13±0.05	1.14	1.13	1.14	1.13	1.14	1.13	1.13	1.14	1.13	1.14	OK	
5	10.30±0.35	10.27	10.25	10.28	10.29	10.30	10.25	10.27	10.28	10.25	10.26	OK	
6	2.10±0.15	2.08	2.07	2.09	2.05	2.07	2.08	2.09	2.08	2.07	2.09	OK	
7	3.00±0.20	3.11	3.13	3.08	3.09	3.12	3.13	3.12	3.11	3.13	3.12	OK	
8	3.00±0.50	3.32	3.31	3.30	3.35	3.34	3.32	3.33	3.32	3.31	3.32	OK	
9	12.20±0.10	12.16	12.13	12.13	12.17	12.18	12.17	12.15	12.16	12.13	12.17	OK	
10	0.50±0.10	0.56	0.58	0.52	0.55	0.56	0.55	0.57	0.56	0.58	0.56	OK	
11	3.90±0.10	3.89	3.84	3.86	3.84	3.87	3.85	3.88	3.89	3.84	3.83	OK	
12	1.45±0.10	1.43	1.41	1.43	1.44	1.42	1.41	1.40	1.43	1.41	1.40	OK	
13	0.45±0.10	0.44	0.43	0.41	0.39	0.38	0.42	0.43	0.44	0.43	0.41	OK	
14	3.35±0.10	3.32	3.29	3.34	3.35	3.31	3.32	3.30	3.32	3.29	3.28	OK	
15	12.30±0.10	12.24	12.28	12.27	12.25	12.23	12.27	12.29	12.24	12.28	12.24	OK	
16	1.20±0.10	1.16	1.14	1.18	1.16	1.14	1.17	1.18	1.16	1.14	1.15	OK	
17	3.50±0.10	3.43	3.48	3.42	3.43	3.44	3.45	3.47	3.43	3.48	3.44	OK	
18	1.50±0.10	1.42	1.41	1.50	1.48	1.43	1.44	1.40	1.44	1.45	1.47	OK	
19	7.65±0.10	7.62	7.60	7.58	7.62	7.61	7.59	7.58	7.61	7.62	7.63	OK	
20	8.20±0.10	8.18	8.17	8.15	8.18	8.16	8.17	8.18	8.16	8.17	8.15	OK	
外观: OK													
其它:驻波一致性测试OK。													
总判定: <input checked="" type="checkbox"/> OK <input type="checkbox"/> NG													
批准:刘孙巧				审核: 易爱玲				作成: 习英丽					
备注:													

表单编号:ZTX-QR-QA-016 版本: A1





ANTENNA SPECIFICATION

CUS P/N :VIZIO D32 WIFI-2 天线组件
ZTX P/N :VIZIO D32 WIFI-2 天线组件

ApplicationDate:APR,13,2022
Editor:

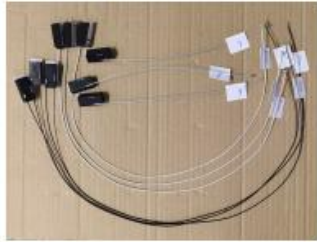
Rev: R:A2



测试报告(Test Report)							
样品名称 (Product name)	WIFI-1&2天线	样品型号 (Part Model)	VIZIO D32	环境温度 (Ambient temperature)	20±5℃	测试日期 (Date of test)	2021/11/29 18:00开始 2021/12/2 18:00结束
样品数量 (Specimens quantity)	3PCS	客户料号 (Customer number)	/	相对湿度 (Relative humidity)	50-60%RH	委托单位 (Client/Dept)	品质部
测试原因 (Test reasons)	<input checked="" type="checkbox"/> 新型号材料验证 <input type="checkbox"/> 新工艺验证 <input type="checkbox"/> ORT测试 <input type="checkbox"/> 过期物料 <input type="checkbox"/> 客户投诉/要求 <input type="checkbox"/> 高不良率 <input type="checkbox"/> 其他: _			测试依据 (Test documentation)	<input type="checkbox"/> 产品图纸 <input type="checkbox"/> 天线可靠性检验基准书 <input type="checkbox"/> 客户要求 <input checked="" type="checkbox"/> 出货检验基准书 <input type="checkbox"/> 其他:		
测试项目: (Test project)	高温储存试验						
测试条件: (Test condition)	高温: 85℃, 时间72H						
测试要求 (Test note)	试验后外观无变形, 变色, 起翘, 无脱落松动, 功能性能正常						
试验设备 (Test equipment)	设备名称	设备型号	校验日期	下次校验日期			
	恒温恒湿试验箱	PTH-11-100FS	2021/4/28	2022/4/27			
测试图片 (Test picture)	1.试验前样品图片			2.试验设备			
							
试验过程参数	3.试验过程参数			4.试验后样品检查图示			
							
试验结果 (Test result)	试验后外观无明显异常, 无变形, 无变色, 无起翘, 无脱落松动, 功能性能正常						
最终判定 (Final result)	<input checked="" type="checkbox"/> 合格 <input type="checkbox"/> 不合格						
备注(Comments):							
核准(Approved by): 胡春梅		审核(Checked by): 易爱玲		测试(Name of operator): 李丽华			

表单编号: ZTX-QR-QA-076 版本: A1



ANTENNA SPECIFICATION

CUS P/N :VIZIO D32 WIFI-2 天线组件
ZTX P/N :VIZIO D32 WIFI-2 天线组件

ApplicationDate:APR,13,2022
Editor:

Rev: R:A2

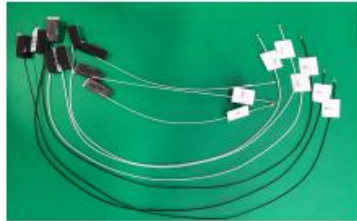

测试报告(Test Report)							
样品名称 (Product name)	WIFI-1&2天线	样品型号 (Part Model)	VIZIO D32	环境温度 (Ambient temperature)	20±5℃	测试日期 (Date of test)	2022/2/18 10:42开始 2022/2/21 10:42结束
样品数量 (Specimens quantity)	各3PCS	客户料号 (Customer number)	/	相对湿度 (Relative humidity)	50-60%RH	委托单位 (Client/Dept)	品质部
测试原因 (Test reasons)	<input checked="" type="checkbox"/> 新型号/材料验证 <input type="checkbox"/> 新工艺验证 <input type="checkbox"/> ORT测试 <input type="checkbox"/> 过期物料 <input type="checkbox"/> 客户投诉/要求 <input type="checkbox"/> 高不良率 <input type="checkbox"/> 其他: _			测试依据 (Test documentation)	<input type="checkbox"/> 产品图纸 <input type="checkbox"/> 天线可靠性检验基准书 <input type="checkbox"/> 客户要求 <input checked="" type="checkbox"/> 出货检验基准书 <input type="checkbox"/> 其他:		
测试项目: (Test project)	低温储存试验						
测试条件: (Test condition)	低温: -40℃±2℃, 时间72H						
测试要求 (Test note)	试验后外观无变形, 变色, 起翘, 无脱落松动, 功能性能正常						
试验设备 (Test equipment)	设备名称	设备型号	校验日期	下次校验日期			
	低温试验箱	DW-40	2021/4/28	2022/4/27			
测试图片 (Test picture)	1.试验前样品图片			2.试验设备			
							
测试图片 (Test picture)	5.试验过程参数			4.试验后样品检查图示			
							
试验结果 (Test result)	试验后外观无明显异常, 无变形, 无变色, 无起翘, 无脱落松动, 功能性能正常						
最终判定 (Final result)	<input checked="" type="checkbox"/> 合格 <input type="checkbox"/> 不合格						
备注(Comments):							
核准(Approved by): 胡春梅		审核(Checked by): 易爱玲		测试(Name of operator): 李丽华			

表单编号: ZTX-QR-QA-076 版本: A1



ANTENNA SPECIFICATION

CUS P/N :VIZIO D32 WIFI-2 天线组件
ZTX P/N :VIZIO D32 WIFI-2 天线组件

ApplicationDate:APR,13,2022
Editor:

Rev: R:A2



测试报告(Test Report)							
样品名称 (Product name)	WIFI-1&2天线	样品型号 (Part Model)	VIZIO D32	环境温度 (Ambient temperature)	20±5℃	测试日期 (Date of test)	2022/2/19 10:20开始 2022/2/21 10:20结束
样品数量 (Specimens quantity)	各3PCS	客户料号 (Customer number)	/	相对湿度 (Relative humidity)	50-60%RH	委托单位 (Client/Dept)	品质部
测试原因 (Test reasons)	<input checked="" type="checkbox"/> 新型号/材料验证 <input type="checkbox"/> 新工艺验证 <input type="checkbox"/> ORT测试 <input type="checkbox"/> 过期物料 <input type="checkbox"/> 客户投诉/要求 <input type="checkbox"/> 高不良率 <input type="checkbox"/> 其他: _			测试依据 (Test documentation)	<input type="checkbox"/> 产品图纸 <input type="checkbox"/> 天线可靠性检验基准书 <input type="checkbox"/> 客户要求 <input checked="" type="checkbox"/> 出货检验基准书 <input type="checkbox"/> 其他:		
测试项目: (Test project)	盐雾试验						
测试条件: (Test condition)	1. 将产品以30度±5度放置于试验箱 2. 调试好试验箱参数: NaCl (无水); 浓度5%±1%; pH值: 6.5~7.2; 试验室温度: 32-38℃; 压缩空气压力: 1.0±0.01 (KG/M2) 喷雾量: 1.0~2.0ML/80CM2/H. 相对湿度: 85%±2%; 试验品放置角度: 30度+/-10度 3. 放置时间为48小时. 4. 清洗后在室温条件下放置2H观察						
测试要求 (Test note)	要求: 天线无变形, 无起翘, 镀(涂)层无脱落、无裂纹、金属部位无氧化等不良现象;						
试验设备 (Test equipment)	设备名称	设备型号	校验日期	下次校验日期			
	盐雾测试机	HY-60	2021/4/28	2022/4/27			
测试图片 (Test picture)	1.试验前样品图片			2.试验设备			
							
测试图片 (Test picture)	3.试验过程参数			4.试验后样品检查图示			
							
试验结果 (Test result)	天线整体外观良好, 无变形, 无起翘, 无脱落、无裂纹、金属部位无氧化等不良现象;						
最终判定 (Final result)	<input checked="" type="checkbox"/> 合格 <input type="checkbox"/> 不合格						
备注(Comments):							
核准(Approved by): 胡春梅		审核(Checked by): 易爱玲		测试(Name of operator): 李丽华			

表单编号: ZTX-QR-QA-076 版本: A1

ANTENNA SPECIFICATION

CUS P/N :VIZIO D32 WIFI-2 天线组件
ZTX P/N :VIZIO D32 WIFI-2 天线组件

ApplicationDate:APR,13,2022
Editor:

Rev: R:A2



测试报告(Test Report)							
样品名称 (Product name)	WIFI-2天线	样品型号 (Part Model)	VIZIO D32	环境温度 (Ambient temperature)	20±5℃	测试日期 (Date of test)	2022/2/21
样品数量 (Specimens quantity)	3PCS	客户料号 (Customer number)	/	相对湿度 (Relative humidity)	50-60%RH	委托单位 (Client/Dept)	品质部
测试原因 (Test reasons)	<input checked="" type="checkbox"/> 新型号/材料验证 <input type="checkbox"/> 新工艺验证 <input type="checkbox"/> ORT测试 <input type="checkbox"/> 过期物料 <input type="checkbox"/> 客户投诉/要求 <input type="checkbox"/> 高不良率 <input type="checkbox"/> 其他: _			测试依据 (Test documentation)	<input type="checkbox"/> 产品图纸 <input type="checkbox"/> 天线可靠性检验基准书 <input type="checkbox"/> 客户要求 <input checked="" type="checkbox"/> 出货检验基准书 <input type="checkbox"/> 其他:		
测试项目: (Test project)	拉力测试						
测试条件: (Test condition)	1. 25N>Φ 1.13mm线径≥9.8N, 端子脱落后表盘数据大9.8N判定合格 2. 测试频率: 保持2S						
测试要求 (Test note)	要求: 天线无明显异常, 外观无开裂, 磨损等。						
试验设备 (Test equipment)	设备名称	设备型号	校验日期	下次校验日期			
	数显式推拉力计	HP-300	2021/4/28	2022/4/27			
测试图片 (Test picture)	1.试验过程图片 <div style="display: flex; justify-content: space-around; align-items: center;"> </div>						
试验结果 (Test result)	实验后端子脱落后表盘数据大于9.8N判定合格						
最终判定 (Final result)	<input checked="" type="checkbox"/> 合格 <input type="checkbox"/> 不合格						
备注(Comments):							
核准(Approved by): 胡春梅		审核(Checked by): 易爱玲			测试(Name of operator): 李丽华		

表单编号: ZTX-QR-QA-076 版本: A1

ANTENNA SPECIFICATION

CUS P/N :VIZIO D32 WIFI-2 天线组件
ZTX P/N :VIZIO D32 WIFI-2 天线组件

ApplicationDate:APR,13,2022
Editor:

Rev: R:A2

3. Test equipment

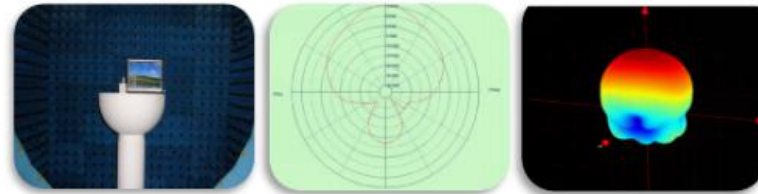
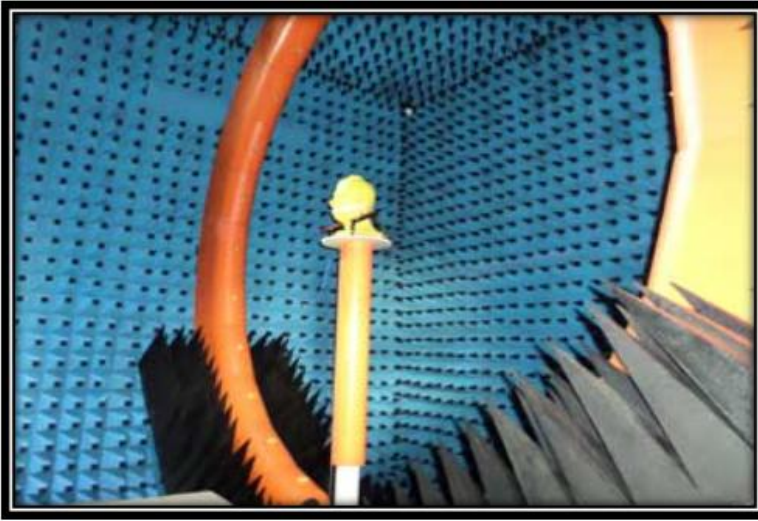

Owned 6 microwave dark room, equipped 2 sets world leading France Satimo SG24 OTA certification test systems (one in SHENZHEN, another one in Shanghai), ETS OTA Standard test system, Blue test reverberation test system which is High repeatability, high accuracy and high resolution. It can quickly provide accurate test reports, fully meet the CITA standards.

Testing range:

Support active, passive testing of GSM/CDMA/WCDMA/TD-SCDMA/LTE/WIFI/WLAN/WiMax/BT/GPS/MIMO/UWB within 0.4-6G.

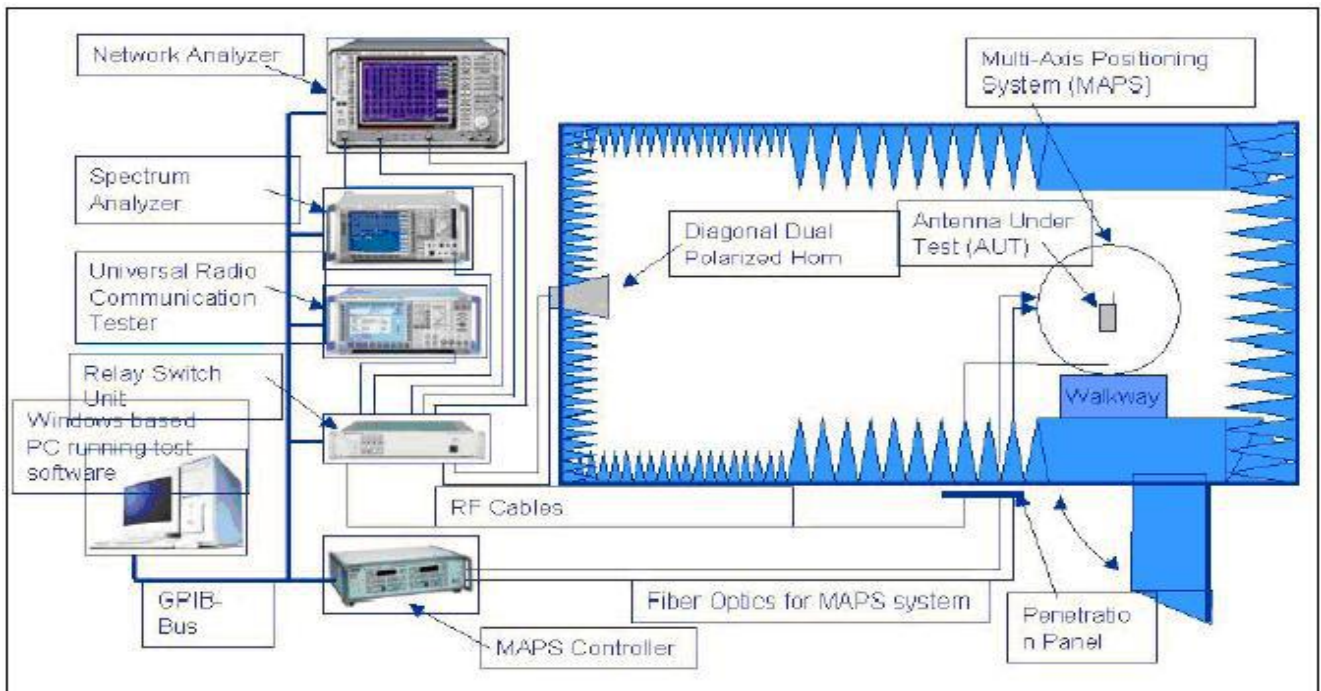

ANTENNA SPECIFICATION

CUS P/N :VIZIO D32 WIFI-2 天线组件
ZTX P/N :VIZIO D32 WIFI-2 天线组件

ApplicationDate:APR,13,2022
Editor:

Rev: R:A2

4.Antenna test data

4-1 VSWR

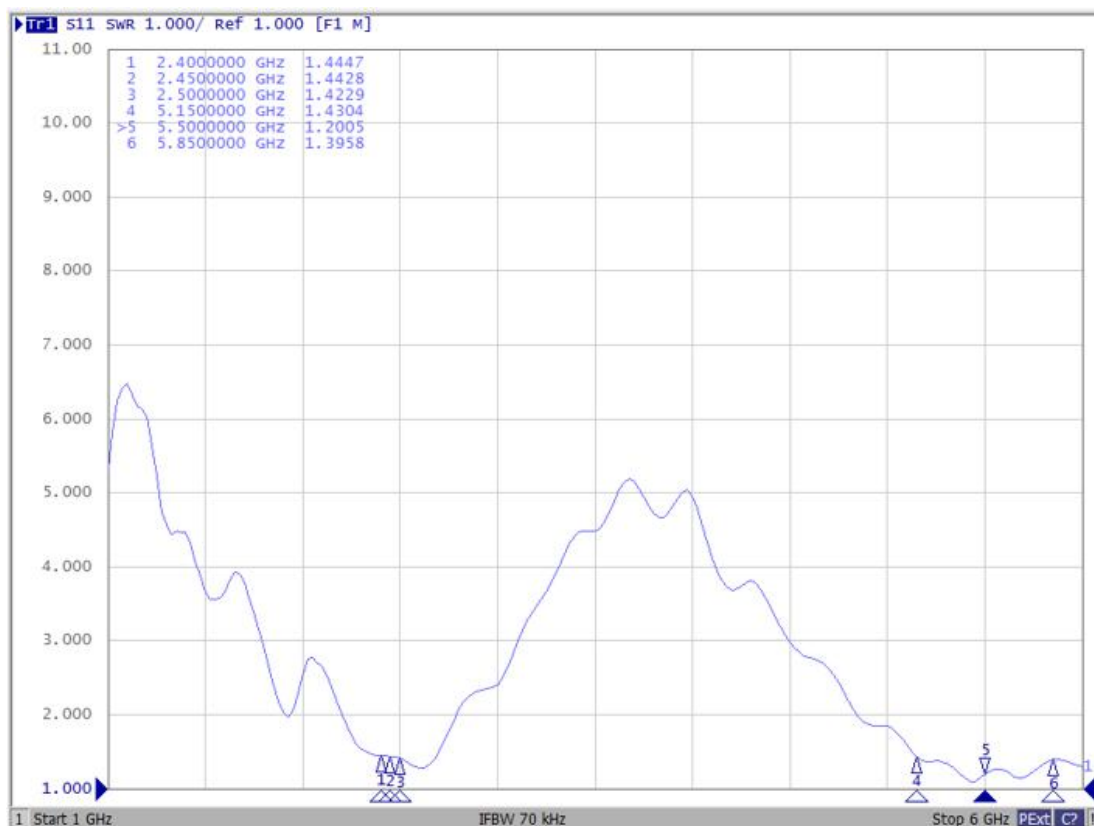

4-2 No-source test data

Frequency	Efficiency	Efficiency . dB	Gain . dB
2400000000	54%	-2.68	4.30
2410000000	52%	-2.85	4.17
2420000000	53%	-2.76	4.20
2430000000	55%	-2.60	4.43
2440000000	56%	-2.55	4.34
2450000000	54%	-2.66	4.32
2460000000	54%	-2.70	4.29
2470000000	55%	-2.61	4.19
2480000000	54%	-2.70	4.24
2490000000	53%	-2.79	4.04
2500000000	53%	-2.72	4.16
5150000000	52%	-2.86	2.47
5200000000	53%	-2.74	3.15
5250000000	52%	-2.80	3.26
5300000000	51%	-2.97	3.30
5350000000	50%	-2.99	3.52
5400000000	50%	-3.03	3.45
5450000000	53%	-2.74	3.95
5500000000	54%	-2.65	4.17
5550000000	52%	-2.85	4.34
5600000000	50%	-3.03	4.01
5650000000	50%	-3.04	4.00
5700000000	50%	-3.00	4.39
5750000000	52%	-2.81	4.42
5800000000	52%	-2.87	4.48
5850000000	51%	-2.94	4.60

ANTENNA SPECIFICATION

CUS P/N :VIZIO D32 WIFI-2 天线组件
ZTX P/N :VIZIO D32 WIFI-2 天线组件

ApplicationDate:APR,13,2022
Editor:

Rev: R:A2

4-3 Directional drawing of horizontal plane of&3D radiation drawing

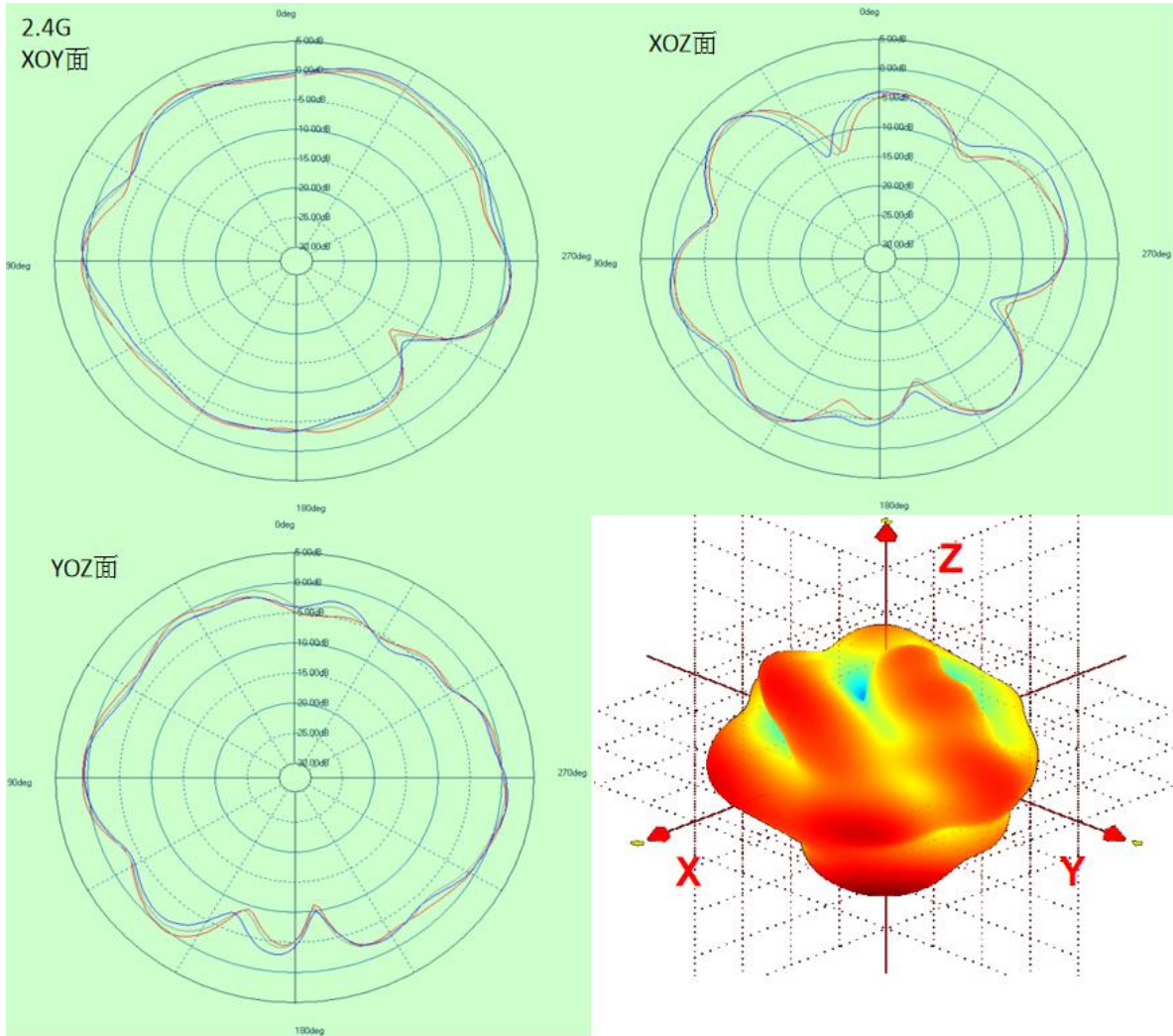

ANTENNA SPECIFICATION

CUS P/N :VIZIO D32 WIFI-2 天线组件
ZTX P/N :VIZIO D32 WIFI-2 天线组件

ApplicationDate:APR,13,2022
Editor:

Rev: R:A2

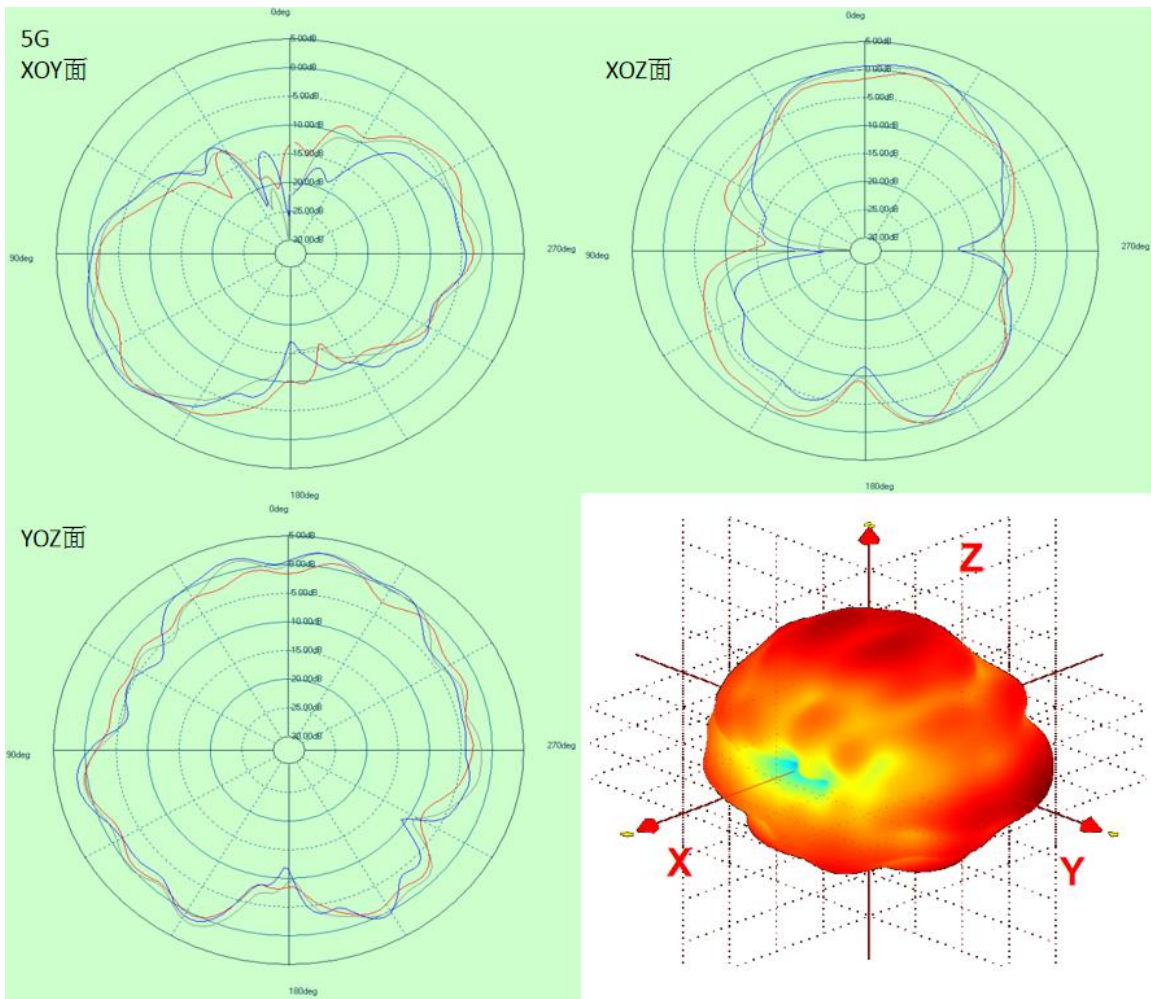

4-4 产品实物图



ANTENNA SPECIFICATION

CUS P/N :VIZIO D32 WIFI-2 天线组件
ZTX P/N :VIZIO D32 WIFI-2 天线组件

ApplicationDate:APR,13,2022
Editor:

Rev: R:A2

5.产品成分表

物料名称	型号规格	客户料号	物料名称	厂商	备注
WIFI-2 天线组件	VIZIO D32	61005-00497	FPC	DINGSHENG	符合 ROHS2.0
			1.13 双锡线	KAIBO	符合 ROHS2.0
			RF 一代端子	CM	符合 ROHS2.0
			固定泡棉/#513	JINHUI	符合 ROHS2.0

6. RoHS 限用物质成分表

Raw Material Detection List
原材料检测清单

序号	组成部件或零件 Parts or Components	材料名称或型号 Style/Item NO.	Pb 铅	Cd 镉	Hg 汞	Cr6+ 六价铬	PBBs 多溴联苯	PBDEs 多溴联苯醚	邻苯二甲 酸二(2-乙 基己)酯 DEHP	邻苯二甲 酸丁酯 DBP	邻苯二甲 酸丁苯酯 BBP	邻苯二甲 酸二异丁 酯DIBP	Br	Cl	测试报告编号 Test Report NO.	Test Lab 测试机构 名称	测试报告日 期	测试报告 有效期限	RoHS Report RoHS报告
1	FPC	基材	ND	ND	ND	ND	ND	ND	ND	ND	ND	ND			A2210414441101001C	CTI	2021/10/14	2022/9/5	ROHS报告.pdf
		油墨	ND	ND	ND	ND	ND	ND	ND	ND	ND	ND			ETR21805816	SGS	2021/9/6	2022/9/5	测试报告 报告编号: ETR21
		卤素	ND	ND	ND	ND	ND	ND	ND	ND	ND	ND	ND	434	ETR21805824	SGS	2021/9/6	2022/9/5	测试报告 报告编号: ETR21
		OSP	ND	ND	ND	ND	ND	ND	ND	ND	ND	ND			WTH21H07065433CC	HCT	2021/7/9	2022/7/8	测试报告 报告编号: WTH21
		背胶3M9471	ND	ND	ND	ND	ND	ND	ND	ND	ND	ND			SHAEC2118730101	SGS	2021/9/4	2022/9/3	测试报告 报告编号: SHAEC21
2	固定泡棉胶	EVA	ND	ND	ND	ND	ND	ND	ND	ND	ND			CANEC2124348309	SGS	2022/1/10	2023/1/9	测试报告 报告编号: CANEC21	
		DS513	ND	ND	ND	ND	ND	ND	ND	ND	ND	ND	62	CANEC2117509326	SGS	2021/10/8	2022/10/7	测试报告 报告编号: CANEC21	
4	同轴线 双锡/FEP/黑色	双锡铜线	ND	ND	ND	ND	ND	ND	ND	ND	ND	ND			A2210168238101E	SGS	2021/5/15	2022/5/14	测试报告 报告编号: A2210168238101E
		FEP绝缘	ND	ND	ND	ND	ND	ND	ND	ND	ND	ND	ND	ND	SHAEC2127178503	SGS	2021/12/21	2022/12/21	测试报告 报告编号: SHAEC2127178503
		FEP护套	ND	ND	ND	ND	ND	ND	ND	ND	ND	ND	ND	ND	SHAEC2200415801	SGS	2022/1/15	2023/1/14	测试报告 报告编号: SHAEC2200415801
		色母黑色	ND	ND	ND	ND	ND	ND	ND	ND	ND	ND			SHAEC2203753901	SGS	2022/3/10	2023/3/9	测试报告 报告编号: SHAEC2203753901
4	RF端子 1代	C5210	ND	ND	ND	ND	ND	ND	ND	ND	ND			CANEC2201952008	SGS	2022/2/18	2023/2/17	测试报告 报告编号: CANEC2201952008	
		镍镀层	ND	ND	ND	ND	ND	ND	ND	ND	ND			A2210394436101002C	CTI	2021/9/22	2022/9/21	测试报告 报告编号: A2210394436101002C	
		金镀层	ND	ND	ND	ND	ND	ND	ND	ND	ND			ETR21801381	SGS	2021/8/13	2022/8/14	测试报告 报告编号: ETR21801381	
		PBT	7.25	ND	ND	ND	ND	ND	ND	ND	ND	ND	ND	ND	ETR21801381	SGS	2021/8/13	2022/8/14	测试报告 报告编号: ETR21801381

ANTENNA SPECIFICATION

CUS P/N :VIZIO D32 WIFI-2 天线组件
ZTX P/N :VIZIO D32 WIFI-2 天线组件

ApplicationDate:APR,13,2022
Editor:

Rev: R:A2

7.REACH 声明

REACH 声明

承诺方：深圳市中天迅通信技术股份有限公司

我司充分认识到环境保护的重要性：并积极、努力的推进地球环境保护；响应客户目标，生产对环境无害的产品，为了达成环境保护品质目标，我们誓约诚实地执行下列事项：

- 1：我司生产的产品完全符合最新 REACH 法规要求。
- 2：若因我司提供的产品超出 REACH 法规要求，造成客户经济方面的损失或其他不可预计的费用均由本公司承担。

公司名称：深圳市中天迅通信技术股份有限公司

签署代表：

签署时间：2019.7.22



ANTENNA SPECIFICATION

CUS P/N :VIZIO D32 WIFI-2 天线组件
ZTX P/N :VIZIO D32 WIFI-2 天线组件

ApplicationDate:APR,13,2022
Editor:

Rev: R:A2

8.符合性声明

符合性声明

本企业对所出货之零件做如下郑重声明：

- 1、本企业产品规格书填写内容及所提供检测报告、检测样品等真实有效；
- 2、本企业产品原辅材料来自于合格供应方，符合输入国或地区的法规（**确认检验报告每年提供一次**）及技术标准的要求；
- 3、本企业产品规格书提供的尺寸数据及出货检查等质量报告真实，准确，满足客户设计要求；
- 4、本企业承诺如有虚假将承担与此有关的一切法律责任。

签名：杨万里
日期：2021/03/25



ANTENNA SPECIFICATION

CUS P/N :VIZIO D32 WIFI-2 天线组件
ZTX P/N :VIZIO D32 WIFI-2 天线组件

ApplicationDate:APR,13,2022
Editor:

Rev: R:A2

9.Wire specification

单位/Unit:mm

项目/Item		详细资料/Details
导体/Conductor	材料/Material	镀锡铜线 Tinned copper
	构成(根/mm)/Composition(No./mm)	7/0.08±0.005
	标称直径/NOM. O. D	0.24±0.01
绝缘层 /Insulation	材料/Material	聚全氟乙丙烯/FEP
	标称外径/NOM. O. D	0.7±0.03
	颜色/Color	Natural
编织层/Braid Shield	材料/Material	镀锡铜线 Tinned copper
	构成/Composition	16/4/0.05±0.005
	目数/Mesh	32±2
	遮蔽率/ Shielding rate	≥90%
	标称直径/NOM. O. D	0.92±0.03
护套/Jacket	材料/Material	聚全氟乙丙烯/FEP
	标称外径/NOM. O. D	1.13±0.05
	颜色/Color	/

3. 电气特性(20℃时)/Electrical Properties(at 20℃)

项目/Item	单位/Unit	详细资料/Details	
电容/Capacitance	pF/m	98	
特性阻抗/Conductor Resistance	Ω	50±3.0	
耐压强度/Dielectric Strength	A. C V/lmin	1000	
最大工作频率/Max. oper. frequency	MHz	6000	
抗拉强度/Tensile strength	kgf/mm ²	1.76	
工作温度范围/Operating Temp.	℃	-55to200	
衰减/Attenuation	/	频率 /Frequency (MHz)	dB/1m
		1000	≤2.23
		2000	≤3.15
		3000	≤3.96
		4000	≤4.6
		5000	≤5.15
		6000	≤5.7
驻波比/Standing wave(0-6GHz)	/	≤1.4	

ANTENNA SPECIFICATION

CUS P/N :VIZIO D32 WIFI-2 天线组件
ZTX P/N :VIZIO D32 WIFI-2 天线组件

ApplicationDate:APR,13,2022
Editor:

Rev: R:A2

10.RF CONNECTOR Product Specification

第一章 性能要求

Table I: Performance Requirements

Items	Requirements	Test Methods
1. Examination of Product 产品检测	Product shall be conforming to the requirements of applicable product drawing. 产品必须满足相关文件的规定	Visually, dimensions and functionally inspected per applicable product drawing. 目视, 尺寸及功能依产品图面检查。
2. Contact Resistance (Low Level) 接触阻抗	中心导体: 初值最大 20 mΩ 外部导体: 初值最大 20 mΩ (单位: mΩ) Inner contact :20mΩ Max. Initial Ground contact :20mΩ Max. Initial (Unit: mΩ)	Subject mated contacts assembled in housing to closed circuit of 10 mA max. at open circuit voltage of 20 mV max. 所述固定在外壳里的端子联结到一个封闭回路中 测试: 电流 1mA, 电压 20 mV max.。
3. Insulation Resistance 绝缘阻抗	1000 MΩ Min. 1000 MΩ 最小	Measure by applying test potential between the adjacent contacts, and between the contacts and ground in the mated connector. MIL-STD-202, Method 302, Condition B (100 V DC±10%). 测试产品端子间以及端子与接地间的电阻, 适用: MIL-STD-202,方法302,条件B (100V DC±10%)。
4. Dielectric Strength 耐电压	Connector must withstand test potential of 100 V AC for 1 minute.Current leakage must be 0.5 mA max.. 样品必须承受测试电 100V AC, 时间一分钟, 漏电流不大于 2 mA.	Measure by applying test potential between the adjacent contacts, and between the contacts and ground in the mated connector. MIL-STD-202, Method 301. 测试产品端子间以及端子与接地间的电压, 适用: MIL-STD-202, 方法 301。
5.Unmating Force 拔出力	Total unmate force: Initial 7N min. after 30 cycles 3Nmin. 综合拔出力: 初始 5N 以上, 插拔 30 次以后 3N 以上	Unmate the receptacle at a speed 25 ± 3mm/m by the push-on/pull-off machine 以每分钟 25 ± 3mm 速度在插拔力测试机进行插拔。
6. Durability (Repeated Mating/Unmating) 耐久力	Contact Resistance: 30mΩ Max. after testing 完成插拔测试后接触阻抗不大于 30mΩ	Mate and unmate connector for 30 cycle . 同配合产品进行 30 次插拔。
7. Crimp strength 引张强度	10N min 10N 以上	Pull the cable as shown at a speed 25 ± 3mm/m by tensile strength machine. 通过引张试验设备以每分钟 25 ± 3mm/m 的速度拉线材部分。

ANTENNA SPECIFICATION

CUS P/N :VIZIO D32 WIFI-2 天线组件
ZTX P/N :VIZIO D32 WIFI-2 天线组件

ApplicationDate:APR,13,2022 Rev: R:A2
Editor:

<p>8. Vibration Sinusoidal Low Frequency 低频正弦振动</p>	<p>No electrical discontinuity greater than 1 μsec (s) shall occur. Contact resistance: 30 mΩ max. 不允许出现超过 1 μsec (s) 的瞬间断开, 接触阻抗: 30 mΩ最大;</p>	<p>Subject mated connector to 10-55-10 Hz traversed in 1 minute at 1.5 mm amplitude 2 hours each of 3 mutually perpendicular plane, 10 mA applied MIL-STD-202, Method 201. 对测试样品, 在频率变化每分钟从 10-55-10 Hz, 振幅 1.5 mm 条件下, 在互相垂直的三个面上, 每个面 2 小时下测量, 电流 10 mA; 适用: MIL-STD-202, 方法 201。</p>
<p>9. Thermal shock 热冲击</p>	<p>No damage, Contact Resistance (Low Level) (Final) 30 mΩ max. 产品无损坏, 接触阻抗: 30mΩ最大</p>	<p>Temperature range from -55$^{\circ}$C to +85$^{\circ}$C .Start from -55$^{\circ}$C,after 30 min. change to +85$^{\circ}$C;change time is no more than 30 seconds. Total 5 cycles. MIL-STD-202, Method 107D,condition A. 温度变化范围: -55$^{\circ}$C~+85$^{\circ}$C; 从 -55$^{\circ}$C 开始, 30 分钟后换到+85$^{\circ}$C; 转换时间不超过 30 秒; 共 5 个循环。适用: MIL-STD-202, 方法 107D, 条件 A。</p>
<p>10 Humidity 恒温恒湿</p>	<p>No damage, Contact Resistance (Low Level) (Final) 30 mΩ max.. Dielectric Strength should be OK, Insulation Resistance should be 200 MΩ min. 产品无损坏, 接触阻抗: 30mΩ最大; 耐电压测试 OK, 绝缘阻抗 100MΩ最小;</p>	<p>Temperature :40\pm2$^{\circ}$C 48 hours. Relative Humidity : 90-95%; Duration :96 Hours. MIL-STD-202, Method 103, 温度: 40\pm2$^{\circ}$C 96 小时; 相对湿度 : 90-95%; 时间: 48 小时; MIL-STD-202, 方法 103。</p>
<p>11. Salt Spray 盐雾</p>	<p>Contact Resistance (Low Level) (Final)100 mΩmax. 接触阻抗(末态) 100 mΩmax.</p>	<p>5\pm1% salt concentration 48\pm4 hours 35\pm2$^{\circ}$C MIL-STD-202, Method 101 Condition B. 盐水浓度 (重量比) 5\pm1%, 时间 48 小时, 温度 35\pm2$^{\circ}$C; MIL-STD-202, 方法 101, 条件 B。</p>
<p>12. High temperature 高温</p>	<p>Contact resistance: 100 mΩmax. 接触阻抗 100 mΩmax.</p>	<p>Subject product to 85\pm2$^{\circ}$C for 96 hours continuously. MIL-STD-202, Method 108. 产品置于 85\pm2$^{\circ}$C 连续 96 小时, 适用 MIL-STD-202, 方法 108。</p>
<p>13. VSWR 驻波比</p>	<p>在 0.1GHz~3GHz 之间, 驻波比最大 1.3;在 3GHz~6GHz 之间, 驻波比最大 1.5. 1.3max. at 0.1GHz~3GHz; 1.5max. at 3GHz~6GHz</p>	<p>以网络分析仪测量驻波比, 分析频率: 100MHz~6GHz Measure the VSWR as shown by the network,analyzer Frequency:100MHz~6GHz</p>

ANTENNA SPECIFICATION

CUS P/N :VIZIO D32 WIFI-2 天线组件
ZTX P/N :VIZIO D32 WIFI-2 天线组件

ApplicationDate:APR,13,2022
Editor:

Rev: R:A2

第二章 产品认证测试

Table II: Product Qualification Test Sequence

Test Description	Test Group											
	A	B	C	D	E	F	G	H	I	J	K	I
1. Examination of Product 产品检查	1,3	1.3	1,5	1,5	1,5	1,5	1,9	1,9	1.4	1.7	1.3	1.3
2. Contact Resistance (Low Level) 接触阻抗	2		2,4	2,4	2,4	2,4	2.8	2.8	2.5	2.5		
3. Insulation Resistance 绝缘阻抗							3.6	3.6		3.6		
4. Dielectric Strength 耐电压							4.7	4.7				
5. Unmating Force 拔出力		2										
6. Durability 耐久力			3									
7. Crimp strength 引张强度				3							2	
8. Vibration Sinusoidal Low Frequency 低频正弦振动					3							
9. Thermal shock 热冲击						3	5					
10. Humidity 恒温恒湿								5				
11. Salt Spray 盐雾									3			
12. High temperature 高温										4		
13. VSWR 驻波比												1

一、申明 DECLARE

本报告仅对彩美电子生产的RF连接器测试样品负责。本报告共13页（含封面）缺少任何一页，报告无效。

This report bears only responsibility for test samples. Report has 13 pages together (cover included); it is of no effect without any one page.

二、测试原因 TEST REASON

- 新品验证 New product validate
- 量产产品定期测试 Mass-produce product test
- 产品审核 Product auditing
- 客诉验证 Customer complain validate
- 工程设计变更 Engineering design change
- 其他 Other

三、测试结果摘要 TEST RESULT SUMMARY

ANTENNA SPECIFICATION

CUS P/N :VIZIO D32 WIFI-2 天线组件
ZTX P/N :VIZIO D32 WIFI-2 天线组件

ApplicationDate:APR,13,2022
Editor:

Rev: R:A2

测试群组编号 Test Group NO.	测试内容 Test content	测试结果 Test Result	备注 Comments	页数 Page NO.
Group A	耐电压 Dielectric withstanding voltage	合格 Pass		5~6
Group B	拔去力 Unmating force	合格 Pass		6
Group C	耐久性 Durability	合格 Pass		6
Group D	对线缆施力 Give force to cable	合格 Pass		6~7
Group E	振动 Vibration	合格 Pass		7
Group F	物理冲击 Physical shock	合格 Pass		7~8
Group G	热冲击 Thermal shock	合格 Pass		8~9
Group H	耐湿性 Humidity	合格 Pass		9~10
Group I	盐水喷雾 Salt sprav	合格 Pass		10
Group J	温度寿命 Temperature life	合格 Pass		10~11
Group K	引张强度 Crimp strength	合格 Pass		11
Group L	驻波比 VSWR	合格 Pass		11

四、 测试内容 TEST CONTENT

1. 适用范围 SCOPE

本测试报告使用于彩美RF 连接器 其包含品质要求、测试方法、测试顺序、测试 设备、测试结果。

The qualification test report covers the quality requirements, test procedure, test sequence, test equipment, test results on the RF CONNECTOR

2. 参考文件 APPLICABLE DOCUMENT

以下文件作为规范在此指定范围的一部分。如果规范要求与产品图有冲突，以产品图优先。如果规范要求 与参考文件有冲突，以规范要求优先。

参考文件: MIL-STD-202, EIA-364, 产品规范

The following documents form a part of this specification to the extent specified herein. In the event of conflict between the requirements of this specification and the product drawing, the product drawing shall take precedence. In the event of conflict between the requirements of this specification and the referenced documents, this specification shall take precedence.

Applicable Document: MIL-STD-202, EIA-364, Product Specification

3. 测试条件 TEST CONDITIONS

除非有其他规定，否则测试和检查将按以下条件执行。

Unless otherwise specified, tests and examinations are conducted under conditions within the following range:

温度(Temperature): 15~25℃

相对湿度(Relative Humidity): 20%~70%

ANTENNA SPECIFICATION

CUS P/N :VIZIO D32 WIFI-2 天线组件
 ZTX P/N :VIZIO D32 WIFI-2 天线组件

ApplicationDate:APR,13,2022
 Editor:

Rev: R:A2

测试项目 Test Description	测试顺序 Test Sequence											
	A	B	C	D	E	F	G	H	I	J	K	L
产品检查 Examination of product	1,3	1,3	1,5	1,5	1,5	1,5	1,9	1,9	1,5	1,7	1	1,3
低功率接触阻抗 Contact resistance (Low Level)			2,4	2,4	2,4	2,4	2,8	2,8	2,4	2,6		
绝缘阻抗 Insulation resistance							3,6	3,6		3,5		
耐电压 Dielectric withstanding voltage	2						4,7	4,7				
拔去力 Unmating force		2										
引张强度 Crimp strength											2	
耐久性Durability			3									
对线缆施力 Give force to cable				3								
振动 Vibration					3							
物理冲击 Physical shock						3						
热冲击 Thermal shock							5					
耐湿性 Humidity								5				
盐水喷雾 Salt spray									3			
温度寿命 Temperature life										4		
驻波比 VSWR												2
每组样品数Specimen size per test group	5	5	5	5	5	5	5	5	5	5	5	5

ANTENNA SPECIFICATION

CUS P/N :VIZIO D32 WIFI-2 天线组件
ZTX P/N :VIZIO D32 WIFI-2 天线组件

ApplicationDate:APR,13,2022
Editor:

Rev: R:A2

5. 测试方法 TEST METHOD

项目 Item	测试项目 Test Description	测试方法 Test Method	参考标准 Reference Standard
1	产品检查 Examination of product	依据品质检查计划外观检查 Visual according to applicable quality inspection plan.	产品规范 Product Specification
2	低功率接触阻抗 Low Level Contact Resistance	公母端连接器配合后使用最 20mV 开路电压,以最大10mA 电流进行测试。 Apply the level condition of 20mV max. for the open circuit voltage and 10mA max. test current. then measure them that between each coupled terminal mated	MIL-STD-202 Method 307
3	绝缘阻抗 Insulation Resistance	使用直流100V, 保持1 分钟, 测试端子与铜壳间。 100V DC is applied for one minute between Inner contact and Ground contact.	MIL-STD-202 Method 302
4	耐电压 Dielectric Withstanding Voltage	使用交流100V, 保持1 分钟, 测试端子与铜壳间。 100V AC is applied for one minute between Inner contact and Ground contact.	MIL-STD-202 Method 301
5	驻波比 VSWR	以网络分析仪测量驻波比, 分析频率: 100MHz~6GHz Measure the VSWR as shown by the network analyzer Frequency:100MHz~6GHz	产品规范 Product Specification
6	振动 Vibration	公母端连接器配合固定在振动仪上, 15 分钟内振动频率为 10-100-10 Hz , 振幅 1.5mm, 三个相互垂直的方向进行振动, 各方向振动 5 次(共 75 分钟), 测试过程中加载5mA 直流电。 Mated connectors are fixed on the vibration tester's 3 mutually perpendicular planes. Vibration frequency traverse from	产品规范 Product Specification
6		10Hz to 100Hz , then to 10Hz in 15 minute at 1.5mm amplitude. Test duration for each plane is 5 cycles (approx 75min). 5mA DC shall be carried to all contacts during the test with an electrical discontinuity monitor.	
7	物理冲击 Physical Shock	公母端连接器配合固定在冲击试验机上,以75g 的加速度半正弦冲击波的波形和 11 毫秒的冲击时间进行测试。冲击次数: 正反三个相互垂直方向各 冲击3 次, 共 18 次。测试过程中加载 100mA 直流电。 Mated connectors are fixed on the shock tester's 3 mutually perpendicular planes. Dropping 3 times each to normal and reversed 3 mutually perpendicular planes (total of 18 times). The test condition: acceleration 75g max., during of the plus: 11 ms .100mA DC shall be carried to all contacts during the test with an electrical discontinuity monitor.	MIL-STD-202G Method 213 Condition B

ANTENNA SPECIFICATION

CUS P/N :VIZIO D32 WIFI-2 天线组件
ZTX P/N :VIZIO D32 WIFI-2 天线组件

ApplicationDate:APR,13,2022
Editor:

Rev: R:A2

8	耐插拔 Durability	<p>母端连接器焊接在板上以每分钟 25mm±3mm 的速度插拔30 次。</p> <p>Mating and Unmating the samples for 30 times at a speed of 25±3mm per minute.</p>	产品规范 Product Specification
9	拔去力 Unmating	<p>以每分钟25±3mm 的速度插拔公母连接器</p> <p>Mating and unmating the connectors at a speed of 25±3mm per minute.</p>	产品规范 Product Specification
10	对线缆施力 Give force to cable	<p>施力于Fig.1 方向测试期间工作电流100mADC, 检查瞬间电流中断。</p> <p>Apply force on the cable as shown in Fig.1, During the testing, run 100mA DC to check electrical discontinuity.</p>	产品规范 Product Specification
11	引张强度 Crimp strength	<p>以每分钟25±3mm/分钟速度拉线材部分</p> <p>Pull the cable as shown at a speed 25±3mm per minute</p>	产品规范 Product Specification
12	热冲击 Thermal Shock	<p>公母配合后,暴露在以下条件测试5个循环。一个循环条件如温度变化范围: -55°C~ +85°C; 从 -55°C开始, 30分钟后换到+85°C; 转换时间不超过30秒; 共5个循环。</p>	产品规范 Product Specification
13	盐水喷雾 Salt Spray	<p>公母连接器配合后,在温度 35°C±2°C和氯化钠溶液浓度为5±1%的条件下测试48 小时。</p> <p>The mated connectors are exposed to the temperature of 35°C±2°C, 5±1% NaCl solution for 48 hours.</p>	MIL-STD-202G Method 101 Condition B
14	耐湿性 Humidity	<p>公母连接器配合后,在温度为 40±2°C,相对湿度为90~95%的条件下测试48 小时。</p> <p>The mated connectors are exposed to the temperature of 40±2°C, 90~95% relative</p>	MIL-STD-202G Method 103 Condition B
15	温度寿命 Temperature Life	<p>公母连接器配合后,在温度为 90°C±2°C的条件下测试96 小时。</p> <p>The mated connectors are exposed to the temperature of 90°C±2°C for 96 hours,</p>	产品规范 Product Specification

ANTENNA SPECIFICATION

CUS P/N :VIZIO D32 WIFI-2 天线组件
ZTX P/N :VIZIO D32 WIFI-2 天线组件

ApplicationDate:APR,13,2022
Editor:

Rev: R:A2

6. 测试结果 THE TEST RESULT

6.1 图示 FIGURE

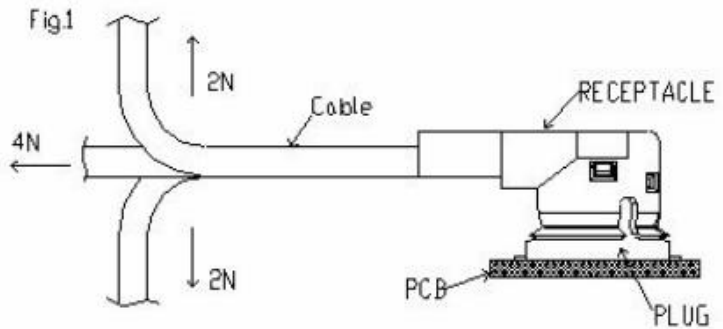

对线缆施加力图示 Fig.1

6.2 测试结果概要 THE SUMMARY OF THE TEST RESULT

GROUP A:

测试项目 Test Description	要求 Requirement	结果 Result	评定 Rate
1. 产品检查 Examination of Product	符合产品要求 Meet the requirements of product	符合产品要求 Meet the requirements of product	合格 Pass
2. 耐电压 Dielectric withstanding voltage	不能有电火花产生，漏电流不能超过2mA。 No creeping discharge or flash over shall occur, Current	通过规格要求 Pass the specified requirement	合格 Pass
3. 产品检查 Examination of Product	符合产品要求 Meet the requirements of product	符合产品要求 Meet the requirements of product	合格 Pass

GROUP B & C:

测试项目 Test Description	要求 Requirement	结果 Result				评定 Rate
1. 产品检查 Examination of Product	符合产品要求 Meet the requirements of product	符合产品要求 Meet the requirements of product				合格 Pass
2. 低功率接触 阻抗 Contact resistance	中心导体: 初值最大 20 mΩ 外部导体: 初值最大 10 mΩ (单位: mΩ)	Item	Max.	Min.	Averag	合格 Pass
	Inner contact: 20mΩ Max. Initial	Inner contact	8.6	7.8	8.2	
	Ground contact: 10mΩ Max. Initial	Ground contact	4.0	3.6	3.8	

ANTENNA SPECIFICATION

CUS P/N :VIZIO D32 WIFI-2 天线组件
ZTX P/N :VIZIO D32 WIFI-2 天线组件

ApplicationDate:APR,13,2022 Rev: R:A2
Editor:

3. 拔去力 Unmating force	综合拔去力:初回拔去力 8N 以上, Total unmating force: Initial 8N Min. 中心导体:初回拔去 0.15N 以上, Inner contact Unmating	Item	Max.	Min.	Averag	合格 Pass
		Total	14.5	11.22	12.86	
		Inner	0.40	0.26	0.33	
4. 耐插拔 Durability	30 次插拔后外观无异常。 After 30 cycles appearances have	外观无异常 Appearances have no abnormality.				合格 Pass
5. 拔去力 Unmating force	综合拔去力: 终回拔去力 5N 以上, Total unmating force: Final 5N Min. 中心导体:终回拔去力 0.1N 以上, Inner contact Unmating	Item	Max.	Min.	Averag	合格 Pass
		Total	10.10	9.4	9.75	
		Inner	0.36	0.24	0.30	
6. 低功率接触 阻抗 Contact resistance (Low Level)	中心导体: 终值最大 25 mΩ 外部导体: 终值最大 15 mΩ (单位: mΩ) Inner contact: 25mΩ Max. Final Ground contact: 15mΩ Max. Final (Unit: mΩ)	Item	Max.	Min.	Averag	合格 Pass
		Inner contact	12.10	8.0	10.0	
		Ground contact	4.8	3.5	4.15	
7. 产品检查 Examination of Product	符合产品要求 Meet the requirements of product	符合产品要求 Meet the requirements of product				合格 Pass

GROUP D:

测试项目 Test Description	要求 Requirement	结果 Result				评定 Rate
1. 产品检查 Examination of Product	符合产品要求 Meet the requirements of product	符合产品要求 Meet the requirements of product				合格 Pass
2. 低功率接触 阻抗 Contact resistance	中心导体: 初值最大 20 mΩ 外部导体: 初值最大 10 mΩ (单位: mΩ) Inner contact: 20mΩ Max. Initial Ground contact: 10mΩMax. Initial	Item	Max.	Min.	Averag e	合格 Pass
		Inner contact	10.0	7.8	8.9	
		Ground contact	4.4	3.4	3.9	
3. 对线缆施力 Give force to cable	外观无异常,瞬断小于 1 微秒 Appearances have no abnormality. Electrical discontinuity less than 1 u sec.	外观无异常,瞬断小于 1 微秒 Appearances have no abnormality. Electrical discontinuity less than 1 u sec.				合格 Pass
4. 低功率接触 阻抗 Contact resistance (Low Level)	中心导体: 终值最大 25 mΩ 外部导体: 终值最大 15 mΩ (单位: mΩ) Inner contact: 25mΩ Max. Final Ground contact: 15mΩ Max. Final	Item	Max.	Min.	Averag e	合格 Pass
		Inner contact	10.4	8.5	9.45	
		Ground contact	4.7	3.6	4.15	
5. 产品检查 Examination of Product	符合产品要求 Meet the requirements of product	符合产品要求 Meet the requirements of product				合格 Pass

GROUP E:

ANTENNA SPECIFICATION

CUS P/N :VIZIO D32 WIFI-2 天线组件
ZTX P/N :VIZIO D32 WIFI-2 天线组件

ApplicationDate:APR,13,2022
Editor:

Rev: R:A2

GROUP E:

测试项目 Test Description	要求 Requirement	结果 Result				评定 Rate
1. 产品检查 Examination of Product	符合产品要求 Meet the requirements of	符合产品要求 Meet the requirements of product				合格 Pass
2. 低功率接触阻抗 Contact resistance (Low Level)	中心导体: 初值最大 20 mΩ 外部导体: 初值最大 10 mΩ (单位: mΩ) Inner contact :20mΩ Max. Initial Groundcontact:10mΩMax. Initial	Item	Max.	Min.	Average	合格 Pass
		Inner contact	8.7	7.7	8.2	
		Ground contact	3.6	3.3	3.45	
3. 振动 Vibration	外观无异常,瞬断小于 1 微秒 Appearances have no abnormality. Electrical	外观无异常,瞬断小于 1 微秒 Appearances have no abnormality. Electrical discontinuity less than 1 u sec.				合格 Pass
4. 低功率接触阻抗 Contact resistance (Low Level)	中心导体: 终值最大 25 mΩ 外部导体: 终值最大 15 mΩ (单位: mΩ) Inner contact: 25mΩ Max. Final Ground contact: 15mΩ Max. Final	Item	Max.	Min.	Average	合格 Pass
		Inner contact	10.8	6.9	8.85	
		Ground contact	3.9	3.6	3.75	
5. 产品检查 Examination	符合产品要求 Meet the requirements of	符合产品要求 Meet the requirements of product				合格 Pass

GROUP F:

测试项目	要求	结果				评定
目	Requirement	Result				Rate
1. 产品检查 Examination of	符合产品要求 Meet the requirements of	符合产品要求 Meet the requirements of product				合格 Pass
2. 低功率接触阻抗 Contact resistance (Low Level)	中心导体: 初值最大 20 mΩ 外部导体: 初值最大 10 mΩ (单位: mΩ) Inner contact: 20mΩ Max. Initial Ground contact: 10mΩMax. Initial	Item	Max.	Min.	Aver	合格 Pass
		Inner contact	9.0	7.4	8.	
		Ground contact	3.9	3.3	3	
3. 物理冲击 Physic	外观无异常,瞬断小于 1 微秒 Appearances have no abnormality. Electrical	外观无异常,瞬断小于 1 微秒 Appearances have no abnormality. Electrical discontinuity less than 1 u sec.				合格 Pass
4. 低功率接触阻抗 Contact resistance (Low Level)	中心导体: 终值最大 25 mΩ 外部导体: 终值最大 15 mΩ (单位: mΩ) Inner contact 25mΩ Max. Final Ground contact: 15mΩ Max. Final	Item	Max.	Min.	Aver	合格 Pass
		Inner contact	9.5	7.8	8.	
		Ground contact	4.9	3.6	4	
5. 产品检查 Examination of Product	符合产品要求 Meet the requirements of	符合产品要求 Meet the requirements of product				合格 Pass

ANTENNA SPECIFICATION

CUS P/N :VIZIO D32 WIFI-2 天线组件
ZTX P/N :VIZIO D32 WIFI-2 天线组件

ApplicationDate:APR,13,2022
Editor:

Rev: R:A2

GROUP G:

测试项目	要求 Requirement	结果 Result				评定 Rate
1. 产品检查 Examination of Product	符合产品要求 Meet the requirements of product	符合产品要求 Meet the requirements of product				合格 Pass
2. 低功率接触阻抗 Contact resistance (Low Level)	中心导体: 初值最大 20 mΩ 外部导体: 初值最大 10 mΩ (单位: mΩ) Inner contact: 20mΩ Max. Initial Ground contact: 10mΩMax. Initial	Item	Max.	Min.	Average	合格 Pass
		Inner contact	8.4	7.3	7.85	
		Ground contact	3.7	3.3	3.5	
3. 绝缘阻抗 Insulation resistance	最小 500 MΩ 500MΩ Min. Initial	通过规格要求 Pass the specified requirement				合格 Pass
4. 耐电压 Dielectric withstanding	不能有电火花产生, 漏电流不能超过 2mA。 No creeping discharge or flash over shall occur, Current	通过规格要求 Pass the specified requirement				合格 Pass

5. 热冲击 Thermal shock	外观无异常 Appearances have no	外观无异常 Appearances have no abnormality				合格 Pass
6. 绝缘阻抗 Insulation resistance	最小 100 MΩ 100MΩ Min. Final	通过规格要求 Pass the specified requirement				合格 Pass
7. 耐电压 Dielectric withstanding voltage	不能有电火花产生, 漏电流不能超过 2mA。 No creeping discharge or flash over shall occur, Current	通过规格要求 Pass the specified requirement				合格 Pass
8. 低功率接触阻抗 Contact resistance (Low Level)	中心导体: 终值最大 25 mΩ 外部导体: 终值最大 15 mΩ (单位: mΩ) Inner contact: 25mΩ Max. Final Ground contact: 15mΩ Max Final	Item	Max.	Min.	Aver	合格 Pass
		Inner contact	9.6	7.4	8	
		Ground contact	4.8	4.2	4	
9. 产品检查 Examination of Product	符合产品要求 Meet the requirements of	符合产品要求 Meet the requirements of product				合格 Pass

ANTENNA SPECIFICATION

CUS P/N :VIZIO D32 WIFI-2 天线组件
ZTX P/N :VIZIO D32 WIFI-2 天线组件

ApplicationDate:APR,13,2022
Editor:

Rev: R:A2

GROUP H:

测试项目 Test Description	要求 Requirement	结果 Result				评定 Rate
1. 产品检查 Examination of Product	符合产品要求 Meet the requirements of product	符合产品要求 Meet the requirements of product				合格 Pass
2. 低功率接触阻抗 Contact resistance (Low Level)	中心导体: 初值最大 20 mΩ 外部导体: 初值最大 10 mΩ (单位: mΩ) Inner contact: 20mΩ Max. Initial Ground contact: 10mΩ Max. Initial	Item	Max.	Min.	Ave	合格 Pass
		Inner contact	9.1	8.7	8	
		Ground contact	3.7	2.8	3	
3. 绝缘阻抗 Insulation resistance	最小 500 MΩ 500MΩ Min. Initial	通过规格要求 Pass the specified requirement				合格 Pass
4. 耐电压 Dielectric withstanding voltage	不能有电火花产生, 漏电流不能超过 2mA。 No creeping discharge or flash over shall occur, Current	通过规格要求 Pass the specified requirement				合格 Pass
5. 耐湿性 Humidity	外观无异常 Appearances have no	外观无异常 Appearances have no abnormality				合格 Pass
6. 绝缘阻抗 Insulation resistance	最小 100 MΩ 100MΩ Min. Final	通过规格要求 Pass the specified requirement				合格 Pass
7. 耐电压 Dielectric withstanding voltage	不能有电火花产生, 漏电流不能超过 2mA。 No creeping discharge or flash	通过规格要求 Pass the specified requirement				合格 Pass

	leakage: 2mA Max.					
8. 低功率接触阻抗 Contact resistance (Low Level)	中心导体: 终值最大 25 mΩ 外部导体: 终值最大 15 mΩ (单位: mΩ) Inner contact: 25mΩ Max. Final Ground contact: 15mΩ Max. Final	Item	Max.	Min.	Average	合格 Pass
		Inner contact	10.7	9.0	9.85	
		Ground contact	4.5	3.7	4.1	
9. 产品检查 Examination of Product	符合产品要求 Meet the requirements of product	符合产品要求 Meet the requirements of product				合格 Pass

ANTENNA SPECIFICATION

CUS P/N :VIZIO D32 WIFI-2 天线组件
ZTX P/N :VIZIO D32 WIFI-2 天线组件

ApplicationDate:APR,13,2022
Editor:

Rev: R:A2

GROUP I:

测试项目 Test Description	要求 Requirement	结果 Result				评定 Rate
1. 产品检查 Examination of Product	符合产品要求 Meet the requirements of	符合产品要求 Meet the requirements of product				合格 Pass
2. 低功率接触阻抗 Contact resistance (Low Level)	中心导体: 初值最大 20 mΩ 外部导体: 初值最大 10 mΩ (单位: mΩ)	Item	Max.	Min.	Averag	合格 Pass
	Inner contact: 20mΩ Max. Initial	Inner contact	7.7	6.8	7.25	
	Ground contact: 10mΩMax. Initial	Ground contact	3.8	3.6	3.7	
3. 盐水喷雾 Salt spray	样品试验后无明显腐蚀, 且通过以下步骤测试要求。 No evident corrosion, and the specimens shall pass the requirements of following test items.	无腐蚀现象, 其他见以下测试 No corrosion occur ,and see the following test items..				合格 Pass
4. 低功率接触阻抗 Contact resistance (Low Level)	中心导体: 终值最大 25 mΩ 外部导体: 终值最大 15 mΩ (单位: mΩ)	Item	Max.	Min.	Averag	合格 Pass
	Inner contact: 25mΩ Max. Final	Inner contact	10.2	8.1	9.15	
	Ground contact: 15mΩ Max. Final	Ground contact	4.2	3.8	4.0	
5. 产品检查 Examination of Product	符合产品要求 Meet the requirements of	符合产品要求 Meet the requirements of product				合格 Pass

GROUP J:

测试项目 Test Description	要求 Requirement	结果 Result				评定 Rate
1. 产品检查 Examination of Product	符合产品要求 Meet the requirements of	符合产品要求 Meet the requirements of product				合格 Pass
2. 绝缘阻抗 Insulation resistance	最小 500 MΩ 500MΩ Min. Initial	通过规格要求 Pass the specified requirement				合格 Pass
3. 低功率接触阻抗 Contact	中心导体: 初值最大 20 mΩ 外部导体: 初值最大 10 mΩ	Item	Max.	Min.	Averag	合格 Pass

	(Unit: mΩ)					
4. 温度寿命 Temperature life	外观无异常 Appearances have no	外观无异常 Appearances have no abnormality				合格 Pass
5. 绝缘阻抗 Insulation resistance	最小 100 MΩ 100MΩ Min. Final	通过规格要求 Pass the specified requirement				合格 Pass

ANTENNA SPECIFICATION

CUS P/N :VIZIO D32 WIFI-2 天线组件
ZTX P/N :VIZIO D32 WIFI-2 天线组件

ApplicationDate:APR,13,2022 Rev: R:A2
Editor:

6.低功率接触阻抗 Contact resistance (Low Level)	中心导体: 终值最大 25 mΩ 外部导体: 终值最大 15 mΩ (单位: mΩ) Inner contact: 25mΩ Max. Final Ground contact: 15mΩ Max. Final	Item	Max.	Min.	Averag	合格 Pass
		Inner contact	10.3	8.6	9.45	
		Ground contact	6.1	4.7	5.4	
7. 产品检查 Examination of Product	符合产品要求 Meet the requirements of	符合产品要求 Meet the requirements of product				合格 Pass

GROUP K:

测试项目 Test Description	要求 Requirement	结果 Result			评定 Rate
1. 产品检查 Examination of Product	符合产品要求 Meet the requirements of	符合产品要求 Meet the requirements of product			合格 Pass
2. 引张强度 Crimp strength	15N 以上 15N MIN	Max.	Min.	Average	合格
		28.5	26.1	27.3.	Pass

GROUP L:

测试项目 Test Description	要求 Requirement	结果 Result			评定 Rate
1. 产品检查 Examination of Product	符合产品要求 Meet the requirements of	符合产品要求 Meet the requirements of product			合格 Pass
2. 驻波比 VSWR	在 0.1GHz~3GHz 之间, 驻波比最大为 1.3; 在 3GHz~6GHz 之间, 驻波比最大为 1.5 1.3Max. at 0.1 GHz~3GHz ; 1.5Max. at 3 GHz~6GHz.	Sample	0.1GHz~3GHz	3GHz~6GHz	合格 Pass
		1	1.16	1.32	
		2	1.14	1.27	
		3	1.16	1.28	
		4	1.15	1.26	
5	1.14	1.29			
3. 产品检查 Examination of Product	符合产品要求 Meet the requirements of	符合产品要求 Meet the requirements of product			合格 Pass

ANTENNA SPECIFICATION

CUS P/N :VIZIO D32 WIFI-2 天线组件

ApplicationDate:APR,13,2022

Rev: R:A2

ZTX P/N :VIZIO D32 WIFI-2 天线组件

Editor:

7. ANNEX----Pictures of the test equipments

		
<p align="center">Milliohm Meter (Contact resistance test)</p>	<p align="center">Electrical Safety Analyzer (Insulation resistance test, Dielectric withstanding voltage)</p>	<p align="center">Salt Spray Tester</p>
		
<p align="center">Insert/Withdrawal Force Tester (Mating/unmating force test, Durability test)</p>	<p align="center">Programable Temperature & Humidity Tester (Humidity test)</p>	<p align="center">Thermal Shock Tester</p>
		
<p align="center">Dry Oven (Temperature life test)</p>		

ANTENNA SPECIFICATION

CUS P/N :VIZIO D32 WIFI-2 天线组件
ZTX P/N :VIZIO D32 WIFI-2 天线组件

ApplicationDate:APR,13,2022
Editor:

Rev: R:A2

11.Shipping inspection reference book



标题		焊接天线检验基准书		文件编号		ZTX-QR-SP-010	
制定部门	品质部	制订日期	2017/1/13	版本	A3	页次	2/2
一、检验依据： 1、客户承认之规格书、限度样板 2、工程图档 /承认书/样品 3、部品外观检验标准				二、抽样水准： 1、外观：GB/T2828.1-2012/ISO2859-1:1999抽样水准（II级水准）单次正常抽样方案。 2、尺寸/性能：N=10，C=0 3. 汽车产品：按照C=0抽样方案进行			
三、检验条件： 1. 灯光&视力：照明度800Lux-1500Lux 纠正后视力1.0以上 2. 目视时间：10秒钟内确认缺陷 3. 目视距离：肉眼与被测物距离30cm至45cm 4. 目视角度：与被测物成30度至45度角范围内							
四、作业内容：							
三、作业内容：							
检验范围		检验工具		判定标准			
				主要缺陷	次要缺陷	轻微缺陷	备注
外观	外皮破损		目视	●			1、三个轻微缺陷累计为一个次要缺陷，三个次要缺陷累计为一个主要缺陷。 2、根据客户对外观的要求程度，可适当调整检验标准，以满足客户的要求。
	线材内芯断开			●			
	线材内芯未上锡			●			
	线材/接头色差			●			
	接头内芯变形			●			
	接头内芯绝缘体损坏			●			
	接头外观变形			●			
	接头与线材铆接牢固			●			
	接头与承认样品不一致（客诉）			●			
	字迹不清/少字/多字			●			
	虚焊/假焊			●			
	少装配部件/多装配部件			●			
	弹片变形/PCB/FPC毛刺超出0.5mm			●			
	电镀不良/PCB镀层氧化			●			
		●					
尺寸/性能	依据受控之《工程图》档中，所标注之重点管控尺寸（IQC必测等级）予以测量，及依据客户承认之规格书/样品测试性能的一致性		二次元/硬度计/千分尺/卡尺/网分等		所有尺寸/性能偏差判定为主要缺陷		
可靠性测试	依据受控之《工程图》档、客户书面其他要求，对可靠性要求予以测试。		盐雾机/3M膜等		所有可靠性测试未能通过即判定为主要缺陷		
HSF符合性	1、报告符合性检验		荧光光谱分析仪		报告未在更新期内及产品含量超标即为主要缺陷		
	2、外箱及内包装标识		目视		所有标识不清或未标识即为主要缺陷		
说明：1、如发现尺寸超差时，须与其他配件实配确认，并与主机板实配确认。 2、可靠性测试抽样标准为随机抽取样品3PCS。 3、公司所有物料均要求符合HSF要求（RoHS要求）。							



ANTENNA SPECIFICATION

CUS P/N :VIZIO D32 WIFI-2 天线组件
ZTX P/N :VIZIO D32 WIFI-2 天线组件

ApplicationDate:APR,13,2022
Editor:

Rev: R:A2

12.The packing way

包装信息表

包装信息				
零件编码	61005-00497 TD32 WIFI 2 (CKD)			
包装外尺寸	500mm*400mm*390mm			
纸箱装入数	2500 PCS			
单箱净重	7 KG			
单箱毛重	8.4 KG			
辅料信息				
序号	名称	规格	材质	用量
1	TD32 天线PC黑色	FPC 哑光 OSP工艺 28.6*13.2*0.13mm ROHS2.0	电解铜	1
2	TD32 固定泡棉黑色	EVA 38度 (皇冠*513) / 单面带胶 28.4*13*10.3mm ROHS2.0	EVA	1
3	TD32 WIFI-2同抽线黑色	双锡Φ1.13*320mm (凯博) 带RF端子1代 ROHS2.0	线材	1
4	PE开口袋	240*160*0.05mm	PE	1/25
5	PE封口袋	360*280*0.10mm	PE	1/100
6	干燥剂5g	硅胶透明 无纺布包装袋 5g	干燥剂	1/25
7	干燥剂15g	硅胶透明 无纺布包装袋 15g	干燥剂	1/100
8	小标签白色	40*25mm (GSD专用) 5000张/卷	铜版纸	1/20
9	平卡	A3B 42*30CM	包装纸	1/1000
10	纸箱	K=K 45*32.5*21CM 中性 (英文纸箱带丝印安全标识图标)	纸箱	1/2500
11	标签纸	80*60mm 白色 (不干胶)	铜版纸	1/100
12	ROHS标绿色	铜版纸 20*13mm	铜版纸	1/2500

1. 包装步骤展示

通过包装测试: 跌落 (1A) 冲击 碰撞 振动 路跑 (三级公路/300km)

环境测试 (测试条件:) 提供所做测试的报告

承诺: 供货方 (零件厂商名) 需保证包装设计的可靠性, 若该物料在海外运输中, 因包装保护不足导致品质异常, 皆由供货方 (零件厂商名) 承担。

供货方工程主管: 党非非
供货方品质主管: 赵翔