



FCC TEST REPORT

According to

CFR47 §15.407

Applicant : Guangzhou Shikun Electronics Co., Ltd
Address : NO.6 Liankun Road,Huangpu District,Guangzhou,China
Manufacturer : Guangzhou Shikun Electronics Co., Ltd
Address : NO.6 Liankun Road,Huangpu District,Guangzhou,China
Equipment : IEEE 802.11a/b/g/n 2T2R USB Wi-Fi Module
Model No. : SKI.WB7638U.1_MT7638BU
Brand : N/A
FCC ID : 2AR82-SKIWB7638U1
Test Period : Dec. 17, 2019~Jan. 03, 2020

- The test result refers exclusively to the test presented test model / sample.
- Without written approval of **CerpPASS Technology (Suzhou) Co., Ltd.**, the test report shall not be reproduced exc- ept in full.
- The test report must not be used by the clients to claim product certification approval by any agency of the Government.

I **HEREBY CERTIFY THAT** :

The measurements shown in this test report were made in accordance with the procedures given in **ANSI C63.10 – 2013& FCC Part15.407** and the energy emitted by this equipment was **passed**.

Approved by:

Miro Chueh
EMC/RF Manager

Laboratory Accreditation:

CerpPASS Technology Corporation Test Laboratory

TAF LAB Code: 1439

CerpPASS Technology (SuZhou) Co., Ltd.

CNAS LAB Code: L5515



CONTENTS

- 1. Summary of Test Procedure and Test Results5
 - 1.1. Applicable Standards5
- 2. Test Configuration of Equipment under Test6
 - 2.1. Feature of Equipment under Test.....6
 - 2.2. Carrier Frequency of Channels7
 - 2.3. Test Mode and Test Software8
 - 2.4. Description of Test System.....8
 - 2.5. General Information of Test.....9
 - 2.6. Measurement Uncertainty10
- 3. Test Equipment and Ancillaries Used for Tests11
- 4. Antenna Requirements.....12
 - 4.1. Standard Applicable12
 - 4.2. Antenna Construction and Directional Gain.....12
- 5. Test of AC Power Line Conducted Emission13
 - 5.1. Test Limit13
 - 5.2. Test Procedures13
 - 5.3. Typical Test Setup14
 - 5.4. Test Result and Data15
- 6. Test of Spurious Emission (Radiated)23
 - 6.1. Test Limit23
 - 6.2. Test Procedures23
 - 6.3. Typical Test Setup24
 - 6.4. Test Result and Data (9kHz ~ 30MHz).....25
 - 6.5. Test Result and Data (30MHz ~ 1GHz).....25
 - 6.6. Test Result and Data (1GHz ~ 40GHz).....29
 - 6.7. Restricted Bands of Operation62
- 7. On Time, Duty Cycle and Measurement methods63
 - 7.1. Test Limit63
 - 7.2. Test Procedure63
 - 7.3. Test Setup Layout63
 - 7.4. Test Result and Data63
 - 7.5. Measurement Methods63
- 8. 6dB Bandwidth & 99% Bandwidth.....65
 - 8.1. Test Limit65
 - 8.2. Test Procedure65
 - 8.3. Test Setup Layout65
 - 8.4. Test Result and Data (6dB Bandwidth)66
 - 8.5. Test Result and Data (99% Bandwidth)70
- 9. 26dB Bandwidth & 99% Bandwidth.....74
 - 9.1. Test Limit74
 - 9.2. Test Procedure74
 - 9.3. Test Setup Layout74
 - 9.4. Test Result and Data74
- 10. Average Power86



- 10.1. Test Limit86
- 10.2. Test Procedure87
- 10.3. Test Setup Layout87
- 10.4. Test Result and Data88
- 11. PPSD.....90
 - 11.1. Test Limit90
 - 11.2. Test Procedure90
 - 11.3. Test Setup Layout90
 - 11.4. Test Result and Data91
- 12. Frequency Stability106
 - 12.1. Test Procedure106
 - 12.2. Test Setup Layout106
 - 12.3. Test Result and Data107
- 13. Automatically Discontinue Transmission.....108
 - 13.1. Limit of Automatically Discontinue Transmission108
 - 13.2. Test Result of Automatically Discontinue Transmission108
- 14. Dynamic Frequency Selection109
 - 14.1. List of Measurement and Examinations109
 - 14.2. Test Setup111
 - 14.3. Non-Occupancy Period113
 - 14.4. DFS Detection Threshold115
 - 14.5. Channel Availability Check116
 - 14.6. U-NII Detection Bandwidth117
 - 14.7. Uniform Spreading118
 - 14.8. In-Service Monitoring119
 - 14.9. Statistical Performance Check121
 - 14.10. EUT Setup Photos121



History of this test report

Report No.	Issue Date	Description
SEDL2001042	Jan. 03, 2020	Original



1. Summary of Test Procedure and Test Results

1.1. Applicable Standards

ANSI C63.4:2014
ANSI C63.10:2013
FCC Rules and Regulations Part 15 Subpart E §15.407
First R&O 14-30
KDB662911
KDB789033
KDB644545

FCC Rule	Description of Test	Result
15.203	Antenna Requirement	Pass
15.207(a)	AC Power Line Conducted Emission	Pass
15.407(b) 15.209	Radiated Spurious Emission	Pass
15.407(a)	26 dB Occupied Bandwidth	Pass
15.407	6 dB Bandwidth	Pass
15.407 (a) & (a)(3)	Average Power	Pass
15.407(a)	Output and PPSD	Pass
15.407(g)	Frequency Stability	Pass
15.407(c)	Automatically Discontinue Transmission	Pass
2.1091	Radio Frequency Exposure	Pass



2. Test Configuration of Equipment under Test

2.1. Feature of Equipment under Test

Equipment	IEEE 802.11a/b/g/n 2T2R USB Wi-Fi Module
Model No.	SKI.WB7638U.1_MT7638BU
Model Discrepancy	N/A
IEEE Standards	IEEE 802.11a/b/g/n
Operating Frequencies	5.15~5.85GHz
Modulation	802.11b: CCK, DQPSK, DBPSK 802.11a/g: 64-QAM,16-QAM, QPSK, BPSK 802.11n: 64-QAM,16-QAM, QPSK, BPSK
Wireless Data Rate	802.11b: 1, 2 ,5.5,11Mbps 802.11a/g: 6,9,12,18,24,36,48,54Mbps 802.11n: HT20 reach up to144.4Mbps, HT40 reach up to300Mbps

Note: For a more detailed features description, please refer to the manufacturer’s specifications or the User’s Manual.

**2.2. Carrier Frequency of Channels**

Band 1: 5150MHz-5250MHz

802.11a, 802.11n HT20

Channel	Frequency(MHz)	Channel	Frequency(MHz)
*36	5180	*44	5220
40	5200	*48	5240

802.11n HT40

Channel	Frequency(MHz)	Channel	Frequency(MHz)
*38	5190	*46	5230

Band 2: 5250MHz -5350MHz

802.11a, 802.11n HT20

Channel	Frequency(MHz)	Channel	Frequency(MHz)
*52	5260	*60	5300
56	5280	*64	5320

802.11n HT40

Channel	Frequency(MHz)	Channel	Frequency(MHz)
*54	5270	*62	5310

Band 3: 5470MHz -5725MHz

802.11a, 802.11n HT20

Channel	Frequency(MHz)	Channel	Frequency(MHz)
*100	5500	124	5620
104	5520	128	5640
108	5540	132	5660
112	5560	136	5680
*116	5580	*140	5700
120	5600		

802.11n HT40

Channel	Frequency(MHz)	Channel	Frequency(MHz)
*102	5510	126	5630
*110	5550	*134	5670
118	5590		

Band 4: 5725MHz -5850MHz

802.11a, 802.11n HT20

Channel	Frequency(MHz)	Channel	Frequency(MHz)
*149	5745	161	5805
153	5765	*165	5825
*157	5785		

802.11n HT40

Channel	Frequency(MHz)	Channel	Frequency(MHz)
*151	5755	*159	5795

Note: Channels remarked * are selected to perform test.



2.3. Test Mode and Test Software

- a. During testing, the interface cables and equipment positions were varied according to ANSI C63.4.
- b. The complete test system included remote workstation and EUT for RF test. The remote workstation included Notebook.

An executive program, " **QATool_Dbg .exe**" under WIN 7 was executed to transmit and receive data via WLAN.

- c. The following test modes were performed for the test:

Conducted Emissions from the AC mains power ports	
Test Mode	Operating Description
1	802.11a (6Mbps)
2	802.11n HT20 (6.5Mbps)
3	802.11n HT40 (13.5Mbps)
caused "Test Mode 1" generated the worst case, it was reported as the final data.	
Radiation Emissions (30MHz ~ 1GHz)	
Test Mode	Operating Description
1	802.11a (6Mbps)
2	802.11n HT20 (6.5Mbps)
3	802.11n HT40 (13.5Mbps)
caused "Test Mode 1" generated the worst case, they were reported as the final data.	
Radiation Emissions (1GHz ~ 40GHz)	
Test Mode	Operating Description
1	802.11a (6Mbps)
2	802.11n HT20 (6.5Mbps)
3	802.11n HT40 (13.5Mbps)
caused "Test Mode 1~3" generated the worst case, they were reported as the final data.	

2.4. Description of Test System

No	Device	Manufacturer	Model No.	Description
1	Notebook	SONY	PCG-71811P	R33021
2	Adapter	FLYPOWER	PS65IBCAY5000H	N/A

Use Cable:

No.	Cable	Quantity	Description
A	DC Cable	1	1.6 m Non Shielding with one core
B	USB Cable	1	1.0m Shielding



2.5. General Information of Test

<input type="checkbox"/>	Test Site	<p>CerpPASS Technology Corporation Test Laboratory Address: No.10, Ln. 2, Lianfu St., Luzhu Dist., Taoyuan City 33848, Taiwan (R.O.C.) Tel:+886-3-3226-888 Fax:+886-3-3226-881 Address: No.68-1, Shihbachongsi, Shihding Township, New Taipei City 223, Taiwan, R.O.C. Tel: +886-2-2663-8582</p>
	TAF	1439
	FCC	TW1079, TW1061
	IC	4934E-1, 4934E-2
	VCCI	T-2205 for Telecommunication Test C-4663 for Conducted emission test R-4399, R-4218 for Radiated emission test G-812, G-813 for radiated disturbance above 1GHz
<input checked="" type="checkbox"/>	Test Site	<p>CerpPASS Technology (Suzhou) Co.,Ltd Address: No.66,Tangzhuang Road, Suzhou Industrial Park, Jiangsu 215006, China Tel: +86-512-6917-5888 Fax: +86-512-6917-5666</p>
	CNAS	L5515
	FCC	CN1243
	A2LA	4981.01
	IC	7290A
VCCI	T-11945 for Telecommunication Test C-12919 for Conducted emission test R-12670 for Radiated emission test G-10227 for radiated disturbance above 1GHz	



2.6. Measurement Uncertainty

ISO/IEC 17025 requires that an estimate of the measurement uncertainties associated with the emissions test results be included in the report. The measurement uncertainties given below are based on a 95% confidence level (based on a coverage factor (k=2)).

RF Conducted Measurement

Test Item	Uncertainty	Limit
Radio Frequency	$\pm 8.7 \times 10^{-7}$	$\pm 1 \times 10^{-5}$
RF output power, conducted	$\pm 0.63 \text{dB}$	$\pm 1.5 \text{dB}$
Power density, conducted	$\pm 1.21 \text{dB}$	$\pm 3 \text{dB}$
Unwanted emissions, conducted	30-1000MHz	$\pm 0.51 \text{dB}$
	1-25GHz	$\pm 0.67 \text{dB}$
All emissions, radiated	30-1000MHz	$\pm 2.28 \text{dB}$
	1-25GHz	$\pm 2.59 \text{dB}$
Temperature	$\pm 0.8^\circ\text{C}$	$\pm 1^\circ\text{C}$
Humidity	$\pm 3\%$	$\pm 5\%$
DC and low frequency voltages	$\pm 3\%$	$\pm 3\%$

AC Conducted Measurement

Measurement	Frequency	Uncertainty
Conducted emissions(LINE)	9KHz-30MHz	+/- 0.7738 dB
Conducted emissions(NEUTRAL)	9KHz-30MHz	+/- 0.7886 dB
Conducted emissions(10Mbps)	150KHz-30MHz	+/- 1.3013dB
Conducted emissions(100Mbps)	150KHz-30MHz	+/- 1.3197 dB
Conducted emissions(1000Mbps)	150KHz-30MHz	+/- 1.2987 dB

Radiated Measurement

Measurement	Polarity	Frequency	Uncertainty
Radiated emissions	Horizontal	below 1GHz	+/- 3.8936 dB
	Vertical	below 1GHz	+/- 3.8928 dB
	Horizontal	above 1GHz	+/- 5.18858dB
	Vertical	above 1GHz	+/- 5.18928 dB



3. Test Equipment and Ancillaries Used for Tests

Instrument/Ancillary	Manufacturer	Model No.	Serial No.	Calibration Date	Valid Date.
EMI Receiver	R&S	ESCI3	100563	2019.06.21	2020.06.20
LISN	Schwarzbeck	NSLK 8127	8127-920	2019.08.22	2020.08.21
Pulse Limiter	R&S	ESH3-Z2	100529	2019.03.11	2020.03.10
Software	Farad	Ez-EMC	ver.ct3a1	N/A	N/A

Instrument/Ancillary	Manufacturer	Model No.	Serial No.	Calibration Date	Valid Date.
Bilog Antenna	Sunol	JB1	A072414-2 -2	2019.07.13	2020.07.13
EMI Receiver	R&S	ESCI3	101183	2019.06.28	2020.06.27
EMI Receiver	R&S	ESCI7	100968	2019.07.28	2020.07.27
Preamplifier	EM Electronics corp.	EM330	60618	2019.03.11	2020.03.10
Horn Antenna	Schwarzbeck	BBHA9120 D	9120D-619	2019.07.13	2020.07.13
Horn Antenna	Schwarzbeck	BBHA9170	9170-348	2019.06.23	2020.06.22
Spectrum Analyzer	R&S	FSP40	100324	2019.07.13	2020.07.12
Preamplifier	EMCI	EMCI 030-00-3230	SN016723	2019.03.11	2020.03.10
Preamplifier	EM Electronics corp.	EM01G18G	SN060714	2019.03.23	2020.03.22
Spectrum Analyzer	KEYSIGHT	N9010A	MY53400169	2019.08.22	2020.08.21
Software	E3	AUDIX	Version: 8.14.806b	N/A	N/A



4. Antenna Requirements

4.1. Standard Applicable

For intentional device, according to FCC 47 CFR Section 15.203, an intentional radiator shall be designed to ensure that no antenna other than that furnished by the responsible party shall be used with the device.

And according to FCC 47 CFR Section 15.407 (a), if transmitting antennas of directional gain greater than 6dBi are used, the power shall be reduced by the amount in dB that the directional gain of the antenna exceeds 6dBi.

4.2. Antenna Construction and Directional Gain

Antenna Type	PIFA Antenna
Antenna Gain	2400MHz-2500MHz: Chain 1: 1.5dBi ; Chain 2: 1.5dBi 5150MHz-5250MHz: Chain 1: 1.5dBi ; Chain 2: 1.5dBi 5250MHz-5350MHz: Chain 1: 1.5dBi ; Chain 2: 1.5dBi 5470MHz-5725MHz: Chain 1: 1.5dBi ; Chain 2: 1.5dBi 5725MHz-5850MHz: Chain 1: 1.5dBi ; Chain 2: 1.5dBi

2412-2462MHz
For Power directional gain= $G_{ant}=1.5dBi$ For PSD directional gain = $10 \log[(10^{G1/20} + 10^{G2/20})^2 / N_{ANT}]$ = 4.51 (dBi)
5150MHz -5250MHz
For Power directional gain= $G_{ant}=1.5dBi$ For PSD directional gain = $10 \log[(10^{G1/20} + 10^{G2/20})^2 / N_{ANT}]$ =4.51 (dBi)
5250MHz -5350MHz
For Power directional gain= $G_{ant}=1.5dBi$ For PSD directional gain = $10 \log[(10^{G1/20} + 10^{G2/20})^2 / N_{ANT}]$ =4.51 (dBi)
5470MHz -5725MHz
For Power directional gain= $G_{ant}=1.5dBi$ For PSD directional gain = $10 \log[(10^{G1/20} + 10^{G2/20})^2 / N_{ANT}]$ =4.51 (dBi)
5725MHz -5850MHz
For Power directional gain= $G_{ant}=1.5dBi$ For PSD directional gain = $10 \log[(10^{G1/20} + 10^{G2/20})^2 / N_{ANT}]$ =4.51 (dBi)



5. Test of AC Power Line Conducted Emission

5.1. Test Limit

Conducted Emissions were measured from 150 kHz to 30 MHz with a bandwidth of 9 KHz, according to the methods defined in ANSI C63.4-2014. The EUT was placed on a nonmetallic stand in a shielded room 0.8 meters above the ground plane. The interface cables and equipment positioning were varied within limits of reasonable applications to determine the position produced maximum conducted emissions.

Frequency (MHz)	Quasi Peak (dB μ V)	Average (dB μ V)
0.15 – 0.5	66-56*	56-46*
0.5 – 5.0	56	46
5.0 – 30.0	60	50

*Decreases with the logarithm of the frequency.

5.2. Test Procedures

- The EUT was placed 0.4 meter from the conducting wall of the shielding room was kept at least 80 centimeters from any other grounded conducting surface.
- Connect EUT to the power mains through a line impedance stabilization network (LISN).
- All the support units are connecting to the other LISN.
- The LISN provides 50 ohm coupling impedance for the measuring instrument.
- The FCC states that a 50 ohm, 50 micro-Henry LISN should be used.
- Both sides of AC line were checked for maximum conducted interference.
- The frequency range from 150 kHz to 30 MHz was searched.
- Set the test-receiver system to Peak Detect Function and Specified Bandwidth with Maximum Hold Mode.



5.3. Typical Test Setup

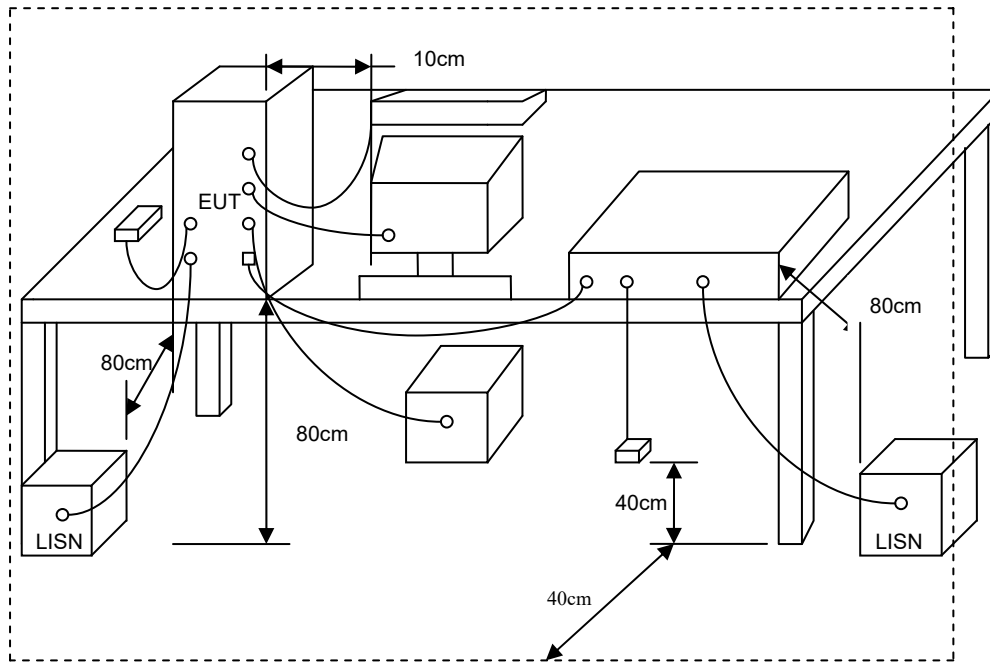



5.4. Test Result and Data

Test Mode :	Mode 1, Band 1		
AC Power :	AC 120V/60Hz	Phase:	LINE
Temperature :	26°C	Humidity:	60%
Pressure(mbar) :	1010	Date:	2020-01-02

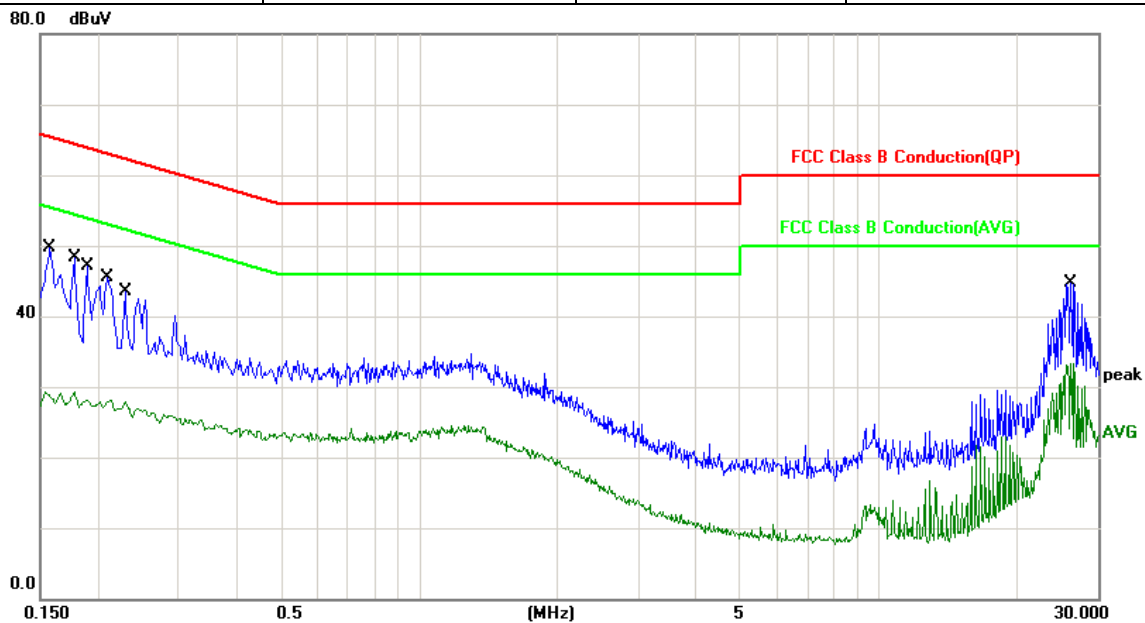

No.	Frequency (MHz)	Factor (dB)	Reading (dBuV)	Level (dBuV)	Limit (dBuV)	Margin (dB)	Detector
1	0.1580	10.06	33.79	43.85	65.56	-21.71	QP
2	0.1580	10.06	18.31	28.37	55.56	-27.19	AVG
3	0.1780	10.06	31.07	41.13	64.57	-23.44	QP
4	0.1780	10.06	17.79	27.85	54.57	-26.72	AVG
5	0.1900	10.06	29.08	39.14	64.03	-24.89	QP
6	0.1900	10.06	17.50	27.56	54.03	-26.47	AVG
7	0.2100	10.05	26.35	36.40	63.20	-26.80	QP
8	0.2100	10.05	16.95	27.00	53.20	-26.20	AVG
9	0.2300	10.04	24.38	34.42	62.45	-28.03	QP
10	0.2300	10.04	16.55	26.59	52.45	-25.86	AVG
11	26.1780	10.61	24.70	35.31	60.00	-24.69	QP
12	26.1780	10.61	16.42	27.03	50.00	-22.97	AVG

Note: Measurement Level = Reading Level + Correct Factor



Test Mode :	Mode 1, Band 1		
AC Power :	AC 120V/60Hz	Phase:	NEUTRAL
Temperature :	26°C	Humidity:	60%
Pressure(mbar) :	1010	Date:	2020-01-02

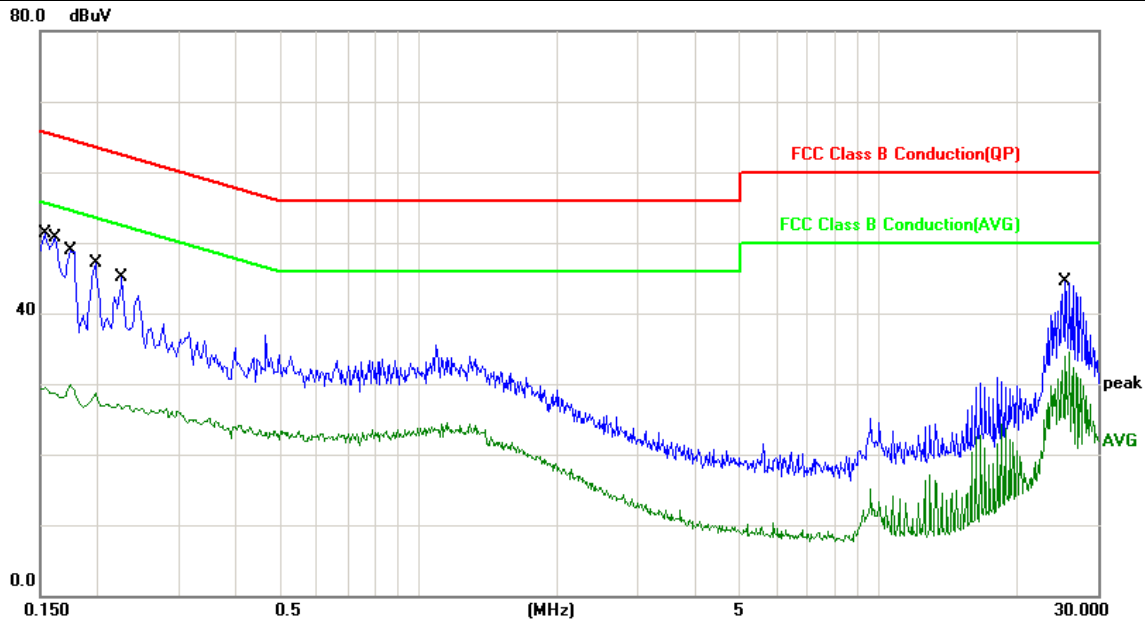

No.	Frequency (MHz)	Factor (dB)	Reading (dBuV)	Level (dBuV)	Limit (dBuV)	Margin (dB)	Detector
1	0.1539	10.06	35.05	45.11	65.78	-20.67	QP
2	0.1539	10.06	18.80	28.86	55.78	-26.92	AVG
3	0.1620	10.06	31.67	41.73	65.36	-23.63	QP
4	0.1620	10.06	18.26	28.32	55.36	-27.04	AVG
5	0.1740	10.06	31.25	41.31	64.76	-23.45	QP
6	0.1740	10.06	18.04	28.10	54.76	-26.66	AVG
7	0.1980	10.06	27.91	37.97	63.69	-25.72	QP
8	0.1980	10.06	17.37	27.43	53.69	-26.26	AVG
9	0.2260	10.05	24.96	35.01	62.59	-27.58	QP
10	0.2260	10.05	16.69	26.74	52.59	-25.85	AVG
11	25.5500	10.61	26.53	37.14	60.00	-22.86	QP
12	25.5500	10.61	20.84	31.45	50.00	-18.55	AVG

Note: Measurement Level = Reading Level + Correct Factor



Test Mode :	Mode 1, Band 2		
AC Power :	AC 120V/60Hz	Phase:	LINE
Temperature :	26°C	Humidity:	60%
Pressure(mbar) :	1010	Date:	2020-01-02

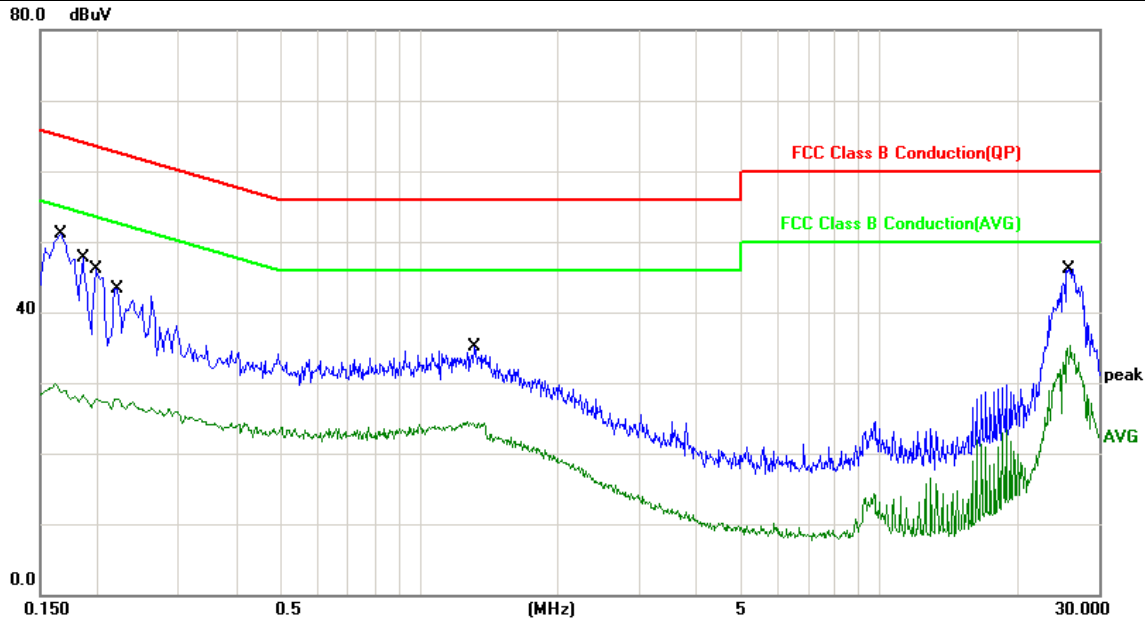

No.	Frequency (MHz)	Factor (dB)	Reading (dBuV)	Level (dBuV)	Limit (dBuV)	Margin (dB)	Detector
1	0.1660	10.06	31.34	41.40	65.15	-23.75	QP
2	0.1660	10.06	17.95	28.01	55.15	-27.14	AVG
3	0.1860	10.06	28.65	38.71	64.21	-25.50	QP
4	0.1860	10.06	17.48	27.54	54.21	-26.67	AVG
5	0.1980	10.06	28.60	38.66	63.69	-25.03	QP
6	0.1980	10.06	17.39	27.45	53.69	-26.24	AVG
7	0.2220	10.05	25.74	35.79	62.74	-26.95	QP
8	0.2220	10.05	16.76	26.81	52.74	-25.93	AVG
9	1.3300	10.44	18.49	28.93	56.00	-27.07	QP
10	1.3300	10.44	13.41	23.85	46.00	-22.15	AVG
11	25.7820	10.61	28.51	39.12	60.00	-20.88	QP
12	25.7820	10.61	18.88	29.49	50.00	-20.51	AVG

Note: Measurement Level = Reading Level + Correct Factor



Test Mode :	Mode 1, Band 2		
AC Power :	AC 120V/60Hz	Phase:	NEUTRAL
Temperature :	26°C	Humidity:	60%
Pressure(mbar) :	1010	Date:	2020-01-02

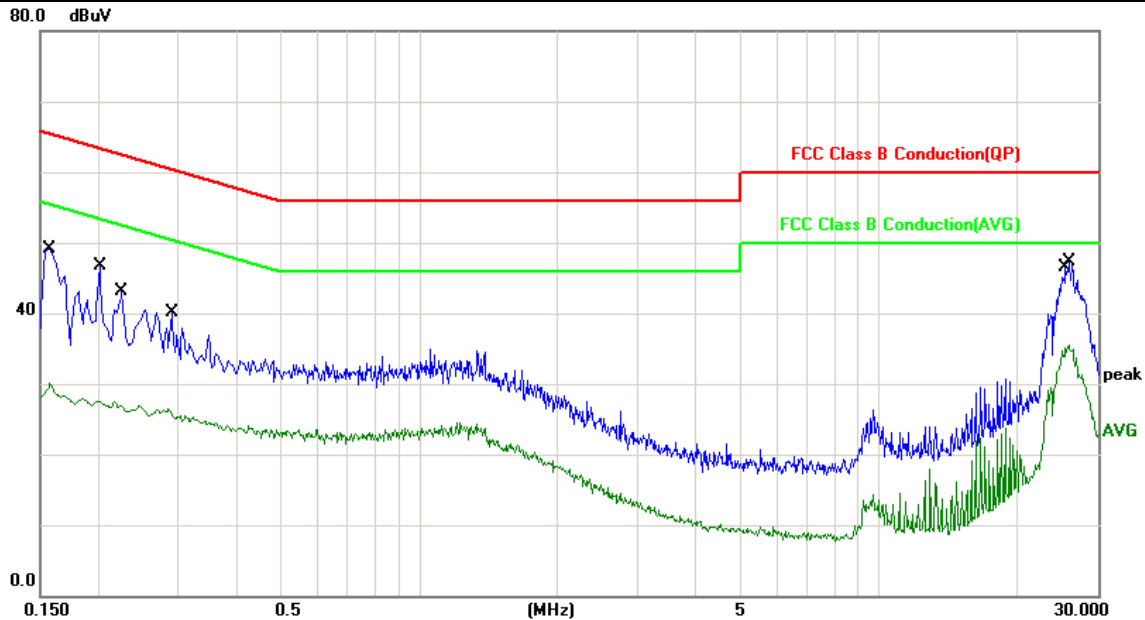

No.	Frequency (MHz)	Factor (dB)	Reading (dBuV)	Level (dBuV)	Limit (dBuV)	Margin (dB)	Detector
1	0.1580	10.06	33.28	43.34	65.56	-22.22	QP
2	0.1580	10.06	18.43	28.49	55.56	-27.07	AVG
3	0.2020	10.06	27.70	37.76	63.52	-25.76	QP
4	0.2020	10.06	17.14	27.20	53.52	-26.32	AVG
5	0.2260	10.05	25.44	35.49	62.59	-27.10	QP
6	0.2260	10.05	16.72	26.77	52.59	-25.82	AVG
7	0.2900	10.01	21.49	31.50	60.52	-29.02	QP
8	0.2900	10.01	15.49	25.50	50.52	-25.02	AVG
9	25.5540	10.61	30.02	40.63	60.00	-19.37	QP
10	25.5540	10.61	23.97	34.58	50.00	-15.42	AVG
11	25.8779	10.61	29.48	40.09	60.00	-19.91	QP
12	25.8779	10.61	22.27	32.88	50.00	-17.12	AVG

Note: Measurement Level = Reading Level + Correct Factor



Test Mode :	Mode 1, Band 3		
AC Power :	AC 120V/60Hz	Phase:	LINE
Temperature :	26°C	Humidity:	60%
Pressure(mbar) :	1010	Date:	2020-01-02

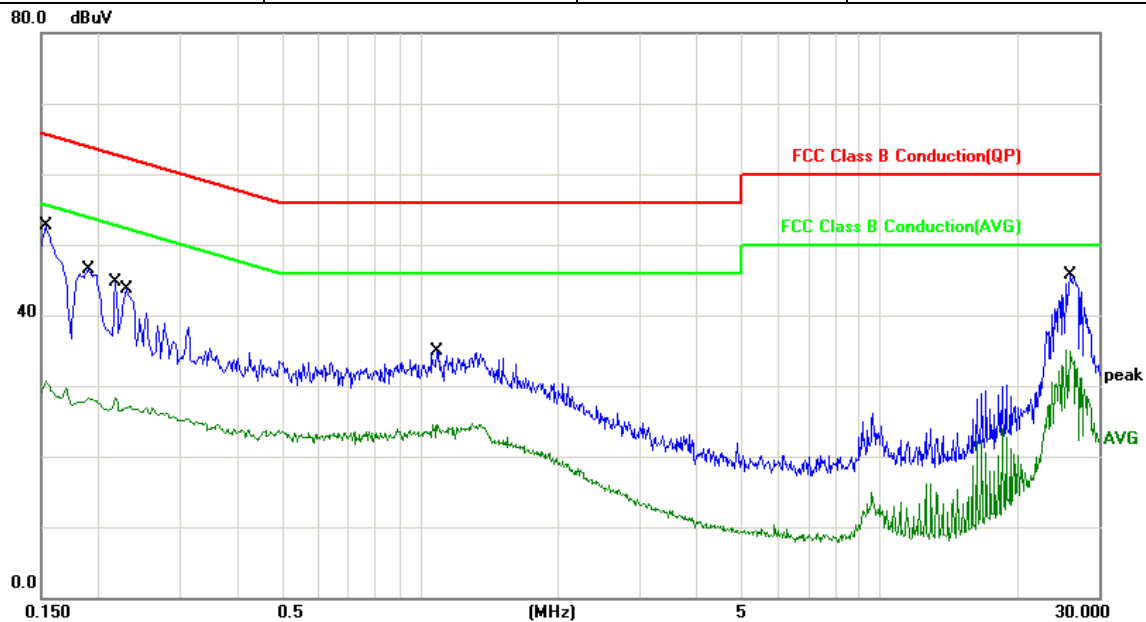

No.	Frequency (MHz)	Factor (dB)	Reading (dBuV)	Level (dBuV)	Limit (dBuV)	Margin (dB)	Detector
1	0.1539	10.06	33.71	43.77	65.78	-22.01	QP
2	0.1539	10.06	18.55	28.61	55.78	-27.17	AVG
3	0.1900	10.06	29.30	39.36	64.03	-24.67	QP
4	0.1900	10.06	17.47	27.53	54.03	-26.50	AVG
5	0.2180	10.05	26.12	36.17	62.89	-26.72	QP
6	0.2180	10.05	16.81	26.86	52.89	-26.03	AVG
7	0.2300	10.04	24.38	34.42	62.45	-28.03	QP
8	0.2300	10.04	16.66	26.70	52.45	-25.75	AVG
9	1.0900	10.21	18.03	28.24	56.00	-27.76	QP
10	1.0900	10.21	13.01	23.22	46.00	-22.78	AVG
11	26.0419	10.61	28.00	38.61	60.00	-21.39	QP
12	26.0419	10.61	20.09	30.70	50.00	-19.30	AVG

Note: Measurement Level = Reading Level + Correct Factor



Test Mode :	Mode 1, Band 3		
AC Power :	AC 120V/60Hz	Phase:	NEUTRAL
Temperature :	26°C	Humidity:	60%
Pressure(mbar) :	1010	Date:	2020-01-02

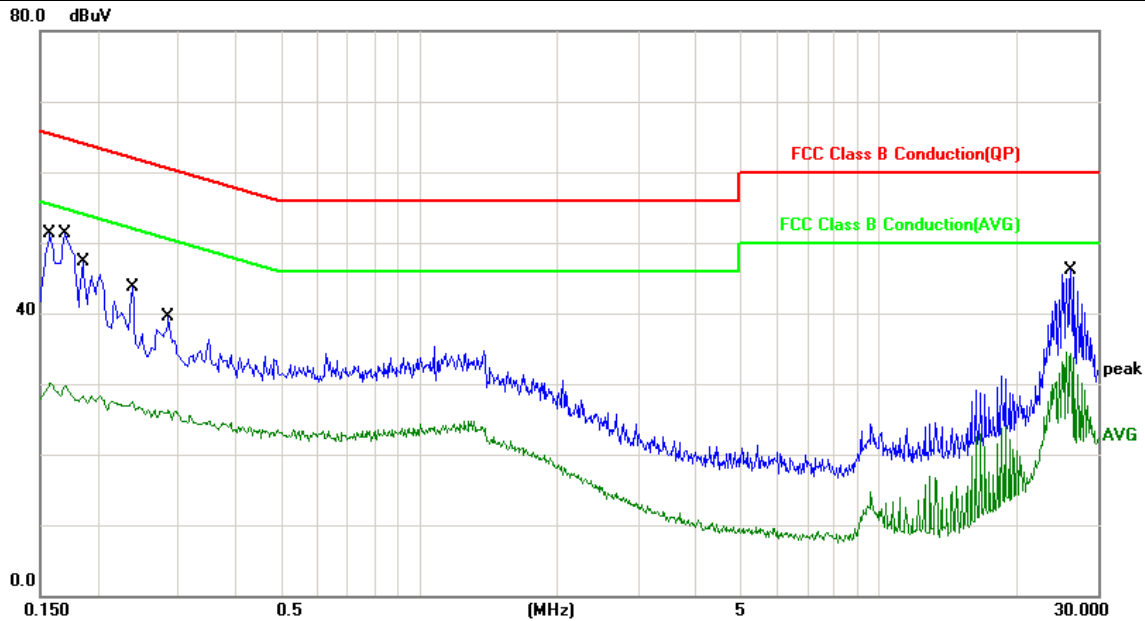

No.	Frequency (MHz)	Factor (dB)	Reading (dBuV)	Level (dBuV)	Limit (dBuV)	Margin (dB)	Detector
1	0.1580	10.06	33.38	43.44	65.56	-22.12	QP
2	0.1580	10.06	18.41	28.47	55.56	-27.09	AVG
3	0.1700	10.06	31.29	41.35	64.96	-23.61	QP
4	0.1700	10.06	17.91	27.97	54.96	-26.99	AVG
5	0.1860	10.06	27.79	37.85	64.21	-26.36	QP
6	0.1860	10.06	17.43	27.49	54.21	-26.72	AVG
7	0.2380	10.04	24.66	34.70	62.16	-27.46	QP
8	0.2380	10.04	16.40	26.44	52.16	-25.72	AVG
9	0.2860	10.01	21.47	31.48	60.64	-29.16	QP
10	0.2860	10.01	15.52	25.53	50.64	-25.11	AVG
11	26.1460	10.61	25.64	36.25	60.00	-23.75	QP
12	26.1460	10.61	16.82	27.43	50.00	-22.57	AVG

Note: Measurement Level = Reading Level + Correct Factor



Test Mode :	Mode 1, Band 4		
AC Power :	AC 120V/60Hz	Phase:	LINE
Temperature :	26°C	Humidity:	60%
Pressure(mbar) :	1010	Date:	2020-01-02

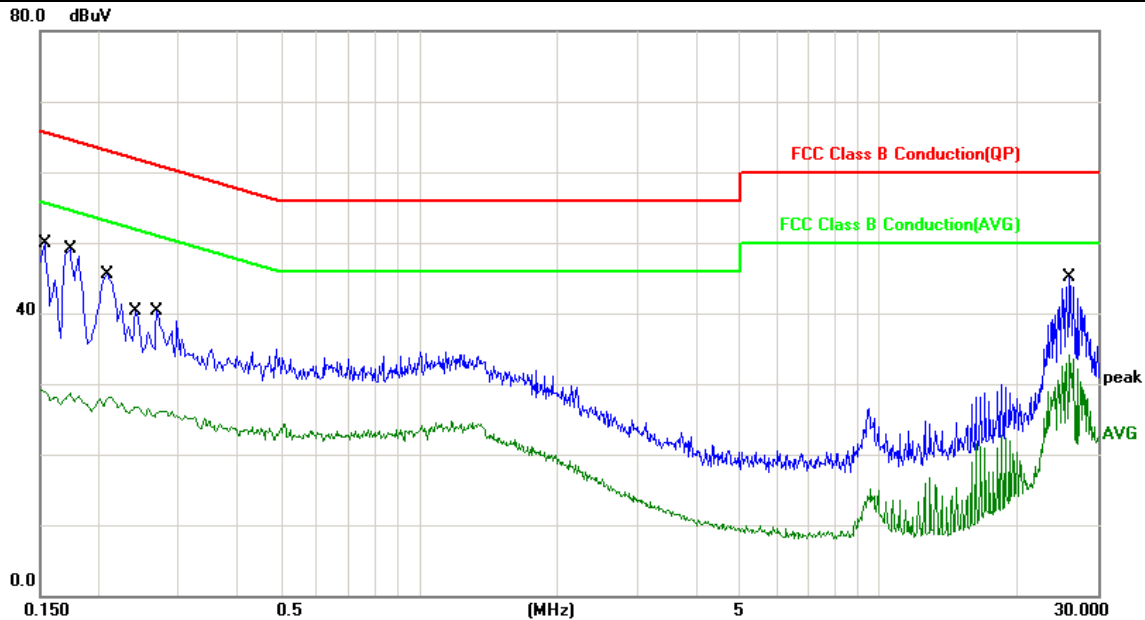

No.	Frequency (MHz)	Factor (dB)	Reading (dBuV)	Level (dBuV)	Limit (dBuV)	Margin (dB)	Detector
1	0.1539	10.06	35.23	45.29	65.78	-20.49	QP
2	0.1539	10.06	18.75	28.81	55.78	-26.97	AVG
3	0.1740	10.06	31.88	41.94	64.76	-22.82	QP
4	0.1740	10.06	17.93	27.99	54.76	-26.77	AVG
5	0.2100	10.05	27.01	37.06	63.20	-26.14	QP
6	0.2100	10.05	16.90	26.95	53.20	-26.25	AVG
7	0.2420	10.04	23.76	33.80	62.02	-28.22	QP
8	0.2420	10.04	16.42	26.46	52.02	-25.56	AVG
9	0.2700	10.02	22.57	32.59	61.12	-28.53	QP
10	0.2700	10.02	15.86	25.88	51.12	-25.24	AVG
11	26.1220	10.61	25.34	35.95	60.00	-24.05	QP
12	26.1220	10.61	17.06	27.67	50.00	-22.33	AVG

Note: Measurement Level = Reading Level + Correct Factor



Test Mode :	Mode 1, Band 4		
AC Power :	AC 120V/60Hz	Phase:	NEUTRAL
Temperature :	26°C	Humidity:	60%
Pressure(mbar) :	1010	Date:	2020-01-02

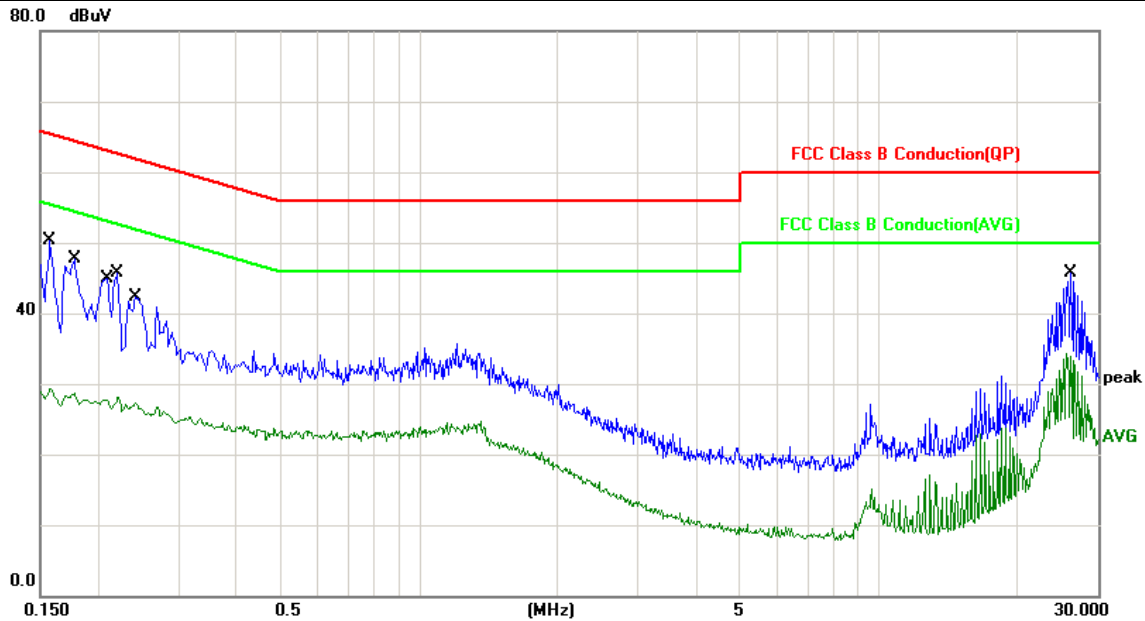

No.	Frequency (MHz)	Factor (dB)	Reading (dBuV)	Level (dBuV)	Limit (dBuV)	Margin (dB)	Detector
1	0.1580	10.06	32.81	42.87	65.56	-22.69	QP
2	0.1580	10.06	18.40	28.46	55.56	-27.10	AVG
3	0.1780	10.06	30.91	40.97	64.57	-23.60	QP
4	0.1780	10.06	17.86	27.92	54.57	-26.65	AVG
5	0.2100	10.05	25.90	35.95	63.20	-27.25	QP
6	0.2100	10.05	16.86	26.91	53.20	-26.29	AVG
7	0.2220	10.05	25.43	35.48	62.74	-27.26	QP
8	0.2220	10.05	16.75	26.80	52.74	-25.94	AVG
9	0.2420	10.04	23.66	33.70	62.02	-28.32	QP
10	0.2420	10.04	16.42	26.46	52.02	-25.56	AVG
11	26.2139	10.61	26.46	37.07	60.00	-22.93	QP
12	26.2139	10.61	16.23	26.84	50.00	-23.16	AVG

Note: Measurement Level = Reading Level + Correct Factor



6. Test of Spurious Emission (Radiated)

6.1. Test Limit

Undesirable emission limits. Except as shown in paragraph (b)(7) of this section, the maximum emissions outside of the frequency bands of operation shall be attenuated in accordance with the following limits:

- (1) For transmitters operating in the 5.15-5.25 GHz band: All emissions outside of the 5.15-5.35 GHz band shall not exceed an e.i.r.p. of -27 dBm/MHz.
- (2) For transmitters operating in the 5.25-5.35 GHz band: All emissions outside of the 5.15-5.35 GHz band shall not exceed an e.i.r.p. of -27 dBm/MHz.
- (3) For transmitters operating in the 5.47-5.725 GHz band: All emissions outside of the 5.47-5.725 GHz band shall not exceed an e.i.r.p. of -27 dBm/MHz.
- (4) For transmitters operating in the 5.725-5.85 GHz band:
All emissions shall be limited to a level of -27 dBm/MHz at 75 MHz or more above or below the band edge increasing linearly to 10 dBm/MHz at 25 MHz above or below the band edge, and from 25MHz above or below the band edge increasing linearly to a level of 15.6 dBm/MHz at 5 MHz above or below the band edge, and from 5 MHz above or below the band edge increasing linearly to a level of 27dBm/MHz at the band edge.
- (5) The emission measurements shall be performed using a minimum resolution bandwidth of 1 MHz. A lower resolution bandwidth may be employed near the band edge, when necessary, provided the measured energy is integrated to show the total power over 1 MHz.
- (6) Unwanted emissions below 1 GHz must comply with the general field strength limits set forth in §15.209. Further, any U-NII devices using an AC power line are required to comply also with the conducted limits set forth in §15.207.
- (7) The provisions of §15.205 apply to intentional radiators operating under this section.
- (8) When measuring the emission limits, the nominal carrier frequency shall be adjusted as close to the upper and lower frequency band edges as the design of the equipment permits.

6.2. Test Procedures

- a. The EUT was placed on a rotatable table top 0.8 meter above ground.
- b. The EUT was set 3 meters from the interference receiving antenna which was mounted on the top of a variable height antenna tower.
- c. The table was rotated 360 degrees to determine the position of the highest radiation.
- d. The antenna is a broadband antenna and its height is varied between one meter and four meters above ground to find the maximum value of the field strength both horizontal polarization and vertical polarization of the antenna are set to make the measurement.
- e. For each suspected emission the EUT was arranged to its worst case and then tune the antenna tower (from 1 M to 4 M) and turn table (from 0 degree to 360 degrees) to find the maximum reading.
- f. Set the test-receiver system to Peak or CISPR quasi-peak Detect Function and specified bandwidth with Maximum Hold Mode.
- g. If the emission level of the EUT in peak mode was 3 dB lower than the limit specified, then testing will be stopped and peak values of EUT will be reported, otherwise, the emissions which do not have 3 dB margin will be repeated one by one using the quasi-peak method and reported.
- h. For testing above 1GHz, the emission level of the EUT in peak mode was 20dB lower than average limit (that means the emission level in peak mode also complies with the limit in average mode), then testing will be stopped and peak values of EUT will be reported, otherwise, the emissions will be measured in average mode again and reported.
- i. "Cone of radiation" has been considered to be 3dB bandwidth of the measurement antenna.



6.3. Typical Test Setup

Below 30MHz test setup

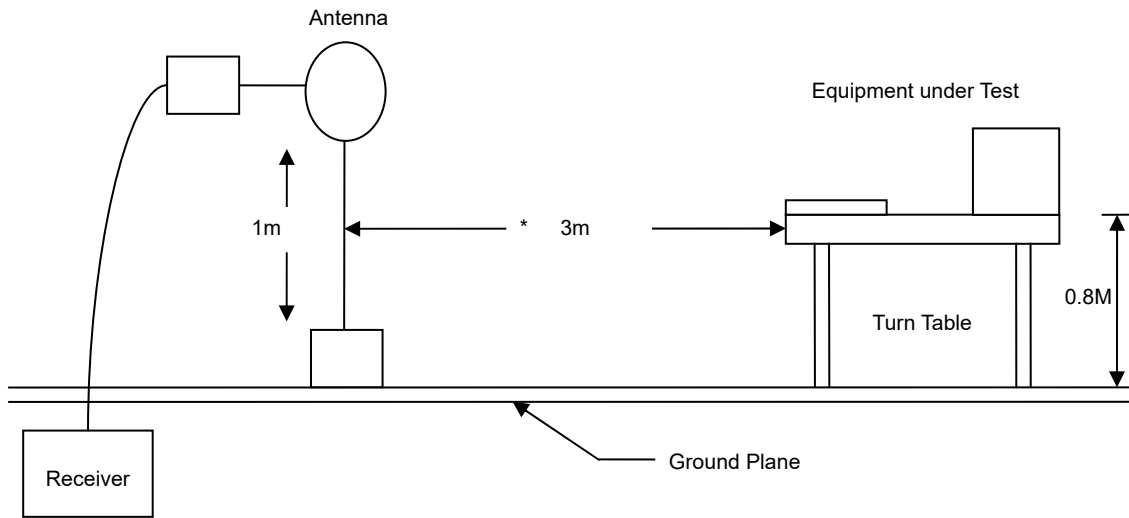

30MHz- 1GHz Test Setup

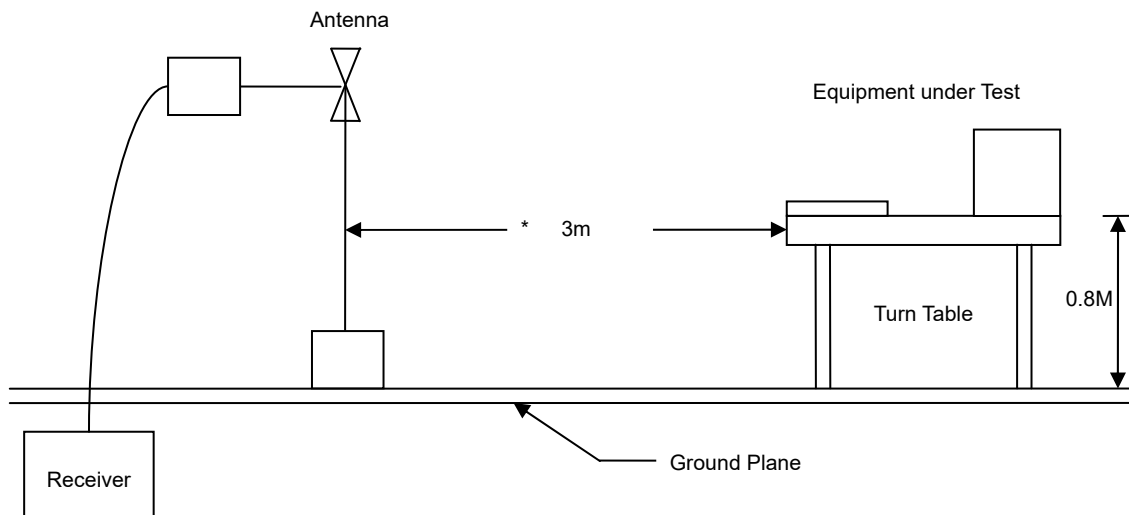

Above 1GHz Test Setup

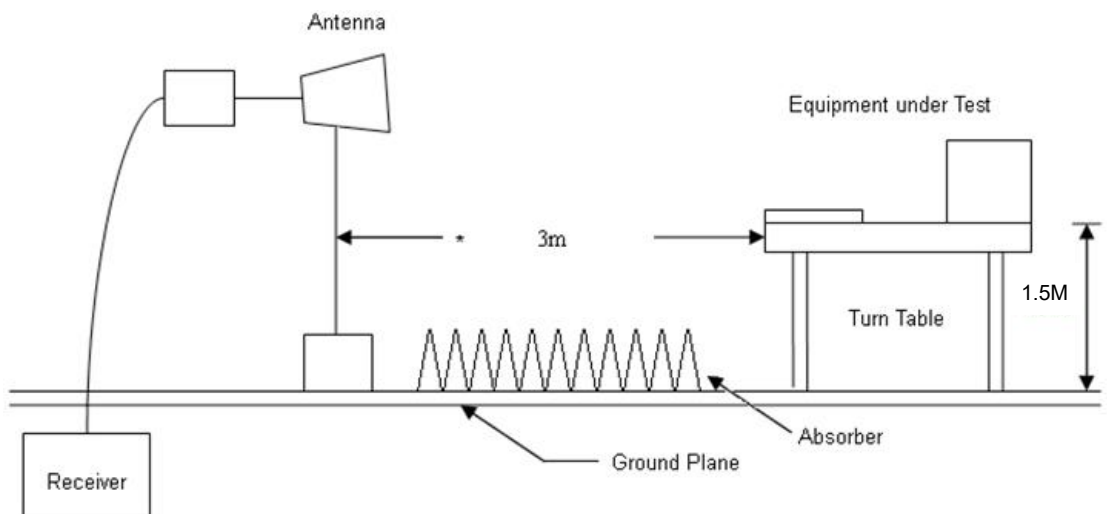

**6.4. Test Result and Data (9kHz ~ 30MHz)**

The 9kHz - 30MHz spurious emission is under limit 20dB more.

6.5. Test Result and Data (30MHz ~ 1GHz)

Power	: DC 3.3V	Temperature	: 24 °C
Test Mode	: Mode 1, Band 1	Humidity	: 54 %
Test date	: 2020-01-02	Atmospheric Pressure	: 1010 hpa

Frequency (MHz)	Correct Factor (dB)	Reading level (dBuV)	Measure Level (dBuV/m)	Limit 3m (dBuV/m)	Safe Margin (dB)	Detector mode (PK/QP)	AntPol. H/V
75.5899	-16.08	48.54	32.46	40.00	-7.54	peak	H
181.3200	-9.92	45.62	35.70	43.50	-7.80	peak	H
216.2400	-9.04	44.21	35.17	46.00	-10.83	peak	H
234.6700	-7.34	43.31	35.97	46.00	-10.03	peak	H
293.8399	-7.33	40.97	33.64	46.00	-12.36	peak	H
479.1100	-1.96	36.44	34.48	46.00	-11.52	peak	H
34.8500	-8.57	41.69	33.12	40.00	-6.88	peak	V
70.7400	-17.52	50.13	32.61	40.00	-7.39	peak	V
143.4900	-12.97	44.09	31.12	43.50	-12.38	peak	V
181.3200	-12.53	47.98	35.45	43.50	-8.05	peak	V
359.8000	-5.87	37.27	31.40	46.00	-14.60	peak	V
455.8300	-4.03	36.31	32.28	46.00	-13.72	peak	V

Note: Level = Reading + Factor

Margin = Level – Limit

Factor= Antenna Factor + Cable Loss - Amplifier Factor



Power	: DC 3.3V	Temperature	: 24 °C
Test Mode	: Mode 1, Band 2	Humidity	: 54 %
Test date	: 2020-01-02	Atmospheric Pressure	: 1010 hpa

Frequency (MHz)	Correct Factor (dB)	Reading level (dBuV)	Measure Level (dBuV/m)	Limit 3m (dBuV/m)	Safe Margin (dB)	Detector mode (PK/QP)	AntPol. H/V
70.7400	-17.52	51.14	33.62	40.00	-6.38	peak	H
182.2899	-9.94	46.39	36.45	43.50	-7.05	peak	H
234.6700	-7.34	44.43	37.09	46.00	-8.91	peak	H
294.8100	-7.49	40.74	33.25	46.00	-12.75	peak	H
478.1400	-2.00	36.18	34.18	46.00	-11.82	peak	H
504.3300	-3.01	36.47	33.46	46.00	-12.54	peak	H
33.8800	-7.99	40.22	32.23	40.00	-7.77	peak	V
72.6800	-16.88	50.07	33.19	40.00	-6.81	peak	V
143.4900	-12.97	44.12	31.15	43.50	-12.35	peak	V
182.2899	-12.25	47.88	35.63	43.50	-7.87	peak	V
359.8000	-5.87	37.16	31.29	46.00	-14.71	peak	V
455.8300	-4.03	37.04	33.01	46.00	-12.99	peak	V

Note: Level = Reading + Factor
Margin = Level – Limit
Factor= Antenna Factor + Cable Loss - Amplifier Factor



Power	: DC 3.3V	Temperature	: 24 °C
Test Mode	: Mode 1, Band 3	Humidity	: 54 %
Test date	: 2020-01-02	Atmospheric Pressure	: 1010 hpa

Frequency (MHz)	Correct Factor (dB)	Reading level (dBuV)	Measure Level (dBuV/m)	Limit 3m (dBuV/m)	Safe Margin (dB)	Detector mode (PK/QP)	AntPol. H/V
70.7400	-17.52	50.44	32.92	40.00	-7.08	peak	H
182.2899	-9.94	46.11	36.17	43.50	-7.33	peak	H
216.2400	-9.04	44.66	35.62	46.00	-10.38	peak	H
234.6700	-7.34	45.55	38.21	46.00	-7.79	peak	H
296.7500	-7.87	41.61	33.74	46.00	-12.26	peak	H
479.1100	-1.96	34.49	32.53	46.00	-13.47	peak	H
34.8500	-8.57	41.07	32.50	40.00	-7.50	peak	V
70.7400	-17.52	49.80	32.28	40.00	-7.72	peak	V
143.4900	-12.97	45.12	32.15	43.50	-11.35	peak	V
188.1100	-10.83	47.42	36.59	43.50	-6.91	peak	V
294.8100	-10.01	40.00	29.99	46.00	-16.01	peak	V
455.8300	-4.03	37.18	33.15	46.00	-12.85	peak	V

Note: Level = Reading + Factor
 Margin = Level – Limit
 Factor= Antenna Factor + Cable Loss - Amplifier Factor



Power	: DC 3.3V	Temperature	: 24 °C
Test Mode	: Mode 1, Band 4	Humidity	: 54 %
Test date	: 2020-01-02	Atmospheric Pressure	: 1010 hpa

Frequency (MHz)	Correct Factor (dB)	Reading level (dBuV)	Measure Level (dBuV/m)	Limit 3m (dBuV/m)	Safe Margin (dB)	Detector mode (PK/QP)	AntPol. H/V
70.7400	-17.52	50.89	33.37	40.00	-6.63	peak	H
181.3200	-9.92	46.50	36.58	43.50	-6.92	peak	H
216.2400	-9.04	45.94	36.90	46.00	-9.10	peak	H
234.6700	-7.34	43.03	35.69	46.00	-10.31	peak	H
295.7799	-7.69	41.06	33.37	46.00	-12.63	peak	H
478.1400	-2.00	34.87	32.87	46.00	-13.13	peak	H
34.8500	-8.57	42.50	33.93	40.00	-6.07	peak	V
72.6800	-16.88	50.52	33.64	40.00	-6.36	peak	V
189.0800	-10.63	45.46	34.83	43.50	-8.67	peak	V
359.8000	-5.87	36.62	30.75	46.00	-15.25	peak	V
455.8300	-4.03	37.39	33.36	46.00	-12.64	peak	V
504.3300	-3.01	35.25	32.24	46.00	-13.76	peak	V

Note: Level = Reading + Factor
Margin = Level – Limit
Factor= Antenna Factor + Cable Loss - Amplifier Factor

**6.6. Test Result and Data (1GHz ~ 40GHz)**

Power	:	DC 3.3V	Temperature	:	24 °C
Test Mode	:	Mode 1, CH36 Band 1	Humidity	:	54 %
Test date	:	2020-01-02	Atmospheric Pressure	:	1010 hpa

Frequency (MHz)	Factor (dB/m)	Reading (dBuV)	Level (dBuV/m)	Limit (dBuV/m)	Margin (dB)	Detector mode (PK/AVG)	AntPol. H/V
5150.000	1.73	38.32	40.05	74.00	-33.95	peak	H
5150.000	1.73	28.42	30.15	54.00	-23.85	AVG	H
10360.000	12.85	32.10	44.95	68.20	-23.25	peak	H
15540.000	25.25	27.70	52.95	74.00	-21.05	peak	H
15540.000	25.25	15.08	40.33	54.00	-13.67	AVG	H
5150.000	1.73	54.53	56.26	74.00	-17.74	peak	V
5150.000	1.73	38.70	40.43	54.00	-13.57	AVG	V
10360.000	12.85	32.68	45.53	68.20	-22.67	peak	V
15540.000	25.25	28.42	53.67	74.00	-20.33	peak	V
15540.000	25.25	16.28	41.53	54.00	-12.47	AVG	V

Note: Level = Reading + Factor

Margin = Level – Limit

Factor= Antenna Factor + Cable Loss - Amplifier Factor



Power	: DC 3.3V	Temperature	: 24 °C
Test Mode	: Mode 1, CH44 Band 1	Humidity	: 54 %
Test date	: 2020-01-02	Atmospheric Pressure	: 1010 hpa

Frequency (MHz)	Factor (dB/m)	Reading (dBuV)	Level (dBuV/m)	Limit (dBuV/m)	Margin (dB)	Detector mode (PK/AVG)	AntPol. H/V
5150.000	1.73	39.83	41.56	74.00	-32.44	peak	H
5150.000	1.73	28.46	30.19	54.00	-23.81	AVG	H
5350.000	1.89	40.14	42.03	74.00	-31.97	peak	H
5350.000	1.89	28.38	30.27	54.00	-23.73	AVG	H
10440.000	13.03	32.10	45.13	68.20	-23.07	peak	H
15660.000	25.30	27.65	52.95	74.00	-21.05	peak	H
15660.000	25.30	15.59	40.89	54.00	-13.11	AVG	H
5150.000	1.73	39.93	41.66	74.00	-32.34	peak	V
5150.000	1.73	28.45	30.18	54.00	-23.82	AVG	V
5350.000	1.89	39.83	41.72	74.00	-32.28	peak	V
5350.000	1.89	28.40	30.29	54.00	-23.71	AVG	V
10440.000	13.03	32.86	45.89	68.20	-22.31	peak	V
15660.000	25.30	28.43	53.73	74.00	-20.27	peak	V
15660.000	25.30	15.95	41.25	54.00	-12.75	AVG	V

Note: Level = Reading + Factor
Margin = Level – Limit
Factor= Antenna Factor + Cable Loss - Amplifier Factor



Power	:	DC 3.3V	Temperature	:	24 °C
Test Mode	:	Mode 1, CH48 band 1	Humidity	:	54 %
Test date	:	2020-01-02	Atmospheric Pressure	:	1010 hpa

Frequency (MHz)	Factor (dB/m)	Reading (dBuV)	Level (dBuV/m)	Limit (dBuV/m)	Margin (dB)	Detector mode (PK/AVG)	AntPol. H/V
5350.000	1.89	39.67	41.56	74.00	-32.44	peak	H
5350.000	1.89	27.98	29.87	54.00	-24.13	AVG	H
10480.000	13.12	31.74	44.86	68.20	-23.34	peak	H
15720.000	25.33	27.13	52.46	74.00	-21.54	peak	H
15720.000	25.33	15.35	40.68	54.00	-13.32	AVG	H
5350.000	1.89	39.76	41.65	74.00	-32.35	peak	V
5350.000	1.89	28.19	30.08	54.00	-23.92	AVG	V
10480.000	13.12	33.00	46.12	68.20	-22.08	peak	V
15720.000	25.33	28.52	53.85	74.00	-20.15	peak	V
15720.000	25.33	16.24	41.57	54.00	-12.43	AVG	V

Note: Level = Reading + Factor

Margin = Level – Limit

Factor= Antenna Factor + Cable Loss - Amplifier Factor



Power	:	DC 3.3V	Temperature	:	24 °C
Test Mode	:	Mode 1, CH52 Band 2	Humidity	:	54 %
Test date	:	2020-01-02	Atmospheric Pressure	:	1010 hpa

Frequency (MHz)	Factor (dB/m)	Reading (dBuV)	Level (dBuV/m)	Limit (dBuV/m)	Margin (dB)	Detector mode (PK/AVG)	AntPol. H/V
5350.000	1.89	39.68	41.57	74.00	-32.43	peak	H
5350.000	1.89	28.07	29.96	54.00	-24.04	AVG	H
10520.000	13.22	31.91	45.13	68.20	-23.07	peak	H
15780.000	25.36	27.42	52.78	74.00	-21.22	peak	H
15780.000	25.36	14.99	40.35	54.00	-13.65	AVG	H
5350.000	1.89	39.77	41.66	74.00	-32.34	peak	V
5350.000	1.89	28.35	30.24	54.00	-23.76	AVG	V
10520.000	13.22	32.60	45.82	68.20	-22.38	peak	V
15780.000	25.36	28.13	53.49	74.00	-20.51	peak	V
15780.000	25.36	15.69	41.05	54.00	-12.95	AVG	V

Note: Level = Reading + Factor

Margin = Level – Limit

Factor= Antenna Factor + Cable Loss - Amplifier Factor



Power	: DC 3.3V	Temperature	: 24 °C
Test Mode	: Mode 1, CH60 Band 2	Humidity	: 54 %
Test date	: 2020-01-02	Atmospheric Pressure	: 1010 hpa

Frequency (MHz)	Factor (dB/m)	Reading (dBuV)	Level (dBuV/m)	Limit (dBuV/m)	Margin (dB)	Detector mode (PK/AVG)	AntPol. H/V
5350.000	1.89	39.67	41.56	74.00	-32.44	peak	H
5350.000	1.89	28.18	30.07	54.00	-23.93	AVG	H
10600.000	13.46	31.37	44.83	74.00	-29.17	peak	H
10600.000	13.46	19.27	32.73	54.00	-21.27	AVG	H
15900.000	25.41	27.69	53.10	74.00	-20.90	peak	H
15900.000	25.41	15.13	40.54	54.00	-13.46	AVG	H
5350.000	1.89	40.00	41.89	74.00	-32.11	peak	V
5350.000	1.89	28.42	30.31	54.00	-23.69	AVG	V
10600.000	13.46	32.37	45.83	74.00	-28.17	peak	V
10600.000	13.46	19.49	32.95	54.00	-21.05	AVG	V
15900.000	25.41	28.27	53.68	74.00	-20.32	peak	V
15900.000	25.41	16.01	41.42	54.00	-12.58	AVG	V

Note: Level = Reading + Factor
Margin = Level – Limit
Factor= Antenna Factor + Cable Loss - Amplifier Factor



Power	: DC 3.3V	Temperature	: 24 °C
Test Mode	: Mode 1, CH64 Band 2	Humidity	: 54 %
Test date	: 2020-01-02	Atmospheric Pressure	: 1010 hpa

Frequency (MHz)	Factor (dB/m)	Reading (dBuV)	Level (dBuV/m)	Limit (dBuV/m)	Margin (dB)	Detector mode (PK/AVG)	AntPol. H/V
5350.000	1.89	48.56	50.45	74.00	-23.55	peak	H
5350.000	1.89	33.57	35.46	54.00	-18.54	AVG	H
10640.000	13.58	31.95	45.53	74.00	-28.47	peak	H
10640.000	13.58	19.60	33.18	54.00	-20.82	AVG	H
15960.000	25.44	27.58	53.02	74.00	-20.98	peak	H
15960.000	25.44	15.35	40.79	54.00	-13.21	AVG	H
5350.000	1.89	55.09	56.98	74.00	-17.02	peak	V
5350.000	1.89	39.48	41.37	54.00	-12.63	AVG	V
10640.000	13.58	32.64	46.22	74.00	-27.78	peak	V
10640.000	13.58	20.16	33.74	54.00	-20.26	AVG	V
15960.000	25.44	28.34	53.78	74.00	-20.22	peak	V
15960.000	25.44	16.18	41.62	54.00	-12.38	AVG	V

Note: Level = Reading + Factor
Margin = Level – Limit
Factor= Antenna Factor + Cable Loss - Amplifier Factor



Power	: DC 3.3V	Temperature	: 24 °C
Test Mode	: Mode 1, CH100 Band 3	Humidity	: 54 %
Test date	: 2020-01-02	Atmospheric Pressure	: 1010 hpa

Frequency (MHz)	Factor (dB/m)	Reading (dBuV)	Level (dBuV/m)	Limit (dBuV/m)	Margin (dB)	Detector mode (PK/AVG)	AntPol. H/V
5460.000	1.99	39.63	41.62	74.00	-32.38	peak	H
5460.000	1.99	27.87	29.86	54.00	-24.14	AVG	H
5470.000	1.99	44.36	46.35	68.20	-21.85	peak	H
11000.000	14.67	30.95	45.62	74.00	-28.38	peak	H
11000.000	14.67	18.84	33.51	54.00	-20.49	AVG	H
16500.000	29.95	23.24	53.19	68.20	-15.01	peak	H
5460.000	1.99	42.60	44.59	74.00	-29.41	peak	V
5460.000	1.99	28.44	30.43	54.00	-23.57	AVG	V
5470.000	1.99	53.05	55.04	68.20	-13.16	peak	V
11000.000	14.67	31.68	46.35	74.00	-27.65	peak	V
11000.000	14.67	19.17	33.84	54.00	-20.16	AVG	V
16500.000	29.95	23.81	53.76	68.20	-14.44	peak	V

Note: Level = Reading + Factor
Margin = Level – Limit
Factor= Antenna Factor + Cable Loss - Amplifier Factor



Power	: DC 3.3V	Temperature	: 24 °C
Test Mode	: Mode 1, CH116 Band 3	Humidity	: 54 %
Test date	: 2020-01-02	Atmospheric Pressure	: 1010 hpa

Frequency (MHz)	Factor (dB/m)	Reading (dBuV)	Level (dBuV/m)	Limit (dBuV/m)	Margin (dB)	Detector mode (PK/AVG)	AntPol. H/V
5460.000	1.99	39.60	41.59	74.00	-32.41	peak	H
5460.000	1.99	28.12	30.11	54.00	-23.89	AVG	H
5470.000	1.99	39.76	41.75	68.20	-26.45	peak	H
5725.000	2.58	39.07	41.65	68.20	-26.55	peak	H
11160.000	15.05	30.84	45.89	74.00	-28.11	peak	H
11160.000	15.05	18.42	33.47	54.00	-20.53	AVG	H
16740.000	29.65	23.09	52.74	68.20	-15.46	peak	H
5460.000	1.99	39.69	41.68	74.00	-32.32	peak	V
5460.000	1.99	28.19	30.18	54.00	-23.82	AVG	V
5470.000	1.99	40.22	42.21	68.20	-25.99	peak	V
5725.000	2.58	39.25	41.83	68.20	-26.37	peak	V
11160.000	15.05	31.47	46.52	74.00	-27.48	peak	V
11160.000	15.05	19.33	34.38	54.00	-19.62	AVG	V
16740.000	29.65	24.27	53.92	68.20	-14.28	peak	V

Note: Level = Reading + Factor
Margin = Level – Limit
Factor= Antenna Factor + Cable Loss - Amplifier Factor



Power	:	DC 3.3V	Temperature	:	24 °C
Test Mode	:	Mode 1, CH140 Band 3	Humidity	:	54 %
Test date	:	2020-01-02	Atmospheric Pressure	:	1010 hpa

Frequency (MHz)	Factor (dB/m)	Reading (dBuV)	Level (dBuV/m)	Limit (dBuV/m)	Margin (dB)	Detector mode (PK/AVG)	AntPol. H/V
5725.000	2.58	55.31	57.89	68.20	-10.31	peak	H
11400.000	15.62	30.41	46.03	74.00	-27.97	peak	H
11400.000	15.62	18.10	33.72	54.00	-20.28	AVG	H
17100.000	29.73	23.08	52.81	68.20	-15.39	peak	H
5725.000	2.58	61.94	64.52	68.20	-3.68	peak	V
11400.000	15.62	31.50	47.12	74.00	-26.88	peak	V
11400.000	15.62	18.94	34.56	54.00	-19.44	AVG	V
17100.000	29.73	24.00	53.73	68.20	-14.47	peak	V

Note: Level = Reading + Factor

Margin = Level – Limit

Factor= Antenna Factor + Cable Loss - Amplifier Factor



Power	: DC 3.3V	Temperature	: 24 °C
Test Mode	: Mode 1, CH149 Band 4	Humidity	: 54 %
Test date	: 2020-01-02	Atmospheric Pressure	: 1010 hpa

Frequency (MHz)	Factor (dB/m)	Reading (dBuV)	Level (dBuV/m)	Limit (dBuV/m)	Margin (dB)	Detector mode (PK/AVG)	AntPol. H/V
5650.000	2.39	39.68	42.07	68.20	-26.13	peak	H
5700.000	2.52	39.01	41.53	105.20	-63.67	peak	H
5720.000	2.57	47.40	49.97	110.80	-60.83	peak	H
5725.000	2.58	59.13	61.71	122.20	-60.49	peak	H
11490.000	15.84	30.50	46.34	74.00	-27.66	peak	H
11490.000	15.84	18.04	33.88	54.00	-20.12	AVG	H
17235.000	30.26	23.31	53.57	68.20	-14.63	peak	H
5650.000	2.39	38.89	41.28	68.20	-26.92	peak	V
5700.000	2.52	41.53	44.05	105.20	-61.15	peak	V
5720.000	2.57	55.46	58.03	110.80	-52.77	peak	V
5725.000	2.58	64.85	67.43	122.20	-54.77	peak	V
11490.000	15.84	31.14	46.98	74.00	-27.02	peak	V
11490.000	15.84	18.91	34.75	54.00	-19.25	AVG	V
17235.000	30.26	24.36	54.62	68.20	-13.58	peak	V

Note: Level = Reading + Factor
Margin = Level – Limit
Factor= Antenna Factor + Cable Loss - Amplifier Factor



Power	: DC 3.3V	Temperature	: 24 °C
Test Mode	: Mode 1, CH157 Band 4	Humidity	: 54 %
Test date	: 2020-01-02	Atmospheric Pressure	: 1010 hpa

Frequency (MHz)	Factor (dB/m)	Reading (dBuV)	Level (dBuV/m)	Limit (dBuV/m)	Margin (dB)	Detector mode (PK/AVG)	AntPol. H/V
5650.000	2.39	39.24	41.63	68.20	-26.57	peak	H
5700.000	2.52	39.16	41.68	105.20	-63.52	peak	H
5720.000	2.57	38.96	41.53	110.80	-69.27	peak	H
5725.000	2.58	39.37	41.95	122.20	-80.25	peak	H
5850.000	2.89	38.99	41.88	122.20	-80.32	peak	H
5855.000	2.90	38.79	41.69	110.80	-69.11	peak	H
5875.000	2.95	38.97	41.92	105.20	-63.28	peak	H
5925.000	3.07	38.72	41.79	68.20	-26.41	peak	H
11570.000	16.00	30.32	46.32	74.00	-27.68	peak	H
11570.000	16.00	18.07	34.07	54.00	-19.93	AVG	H
17355.000	30.74	22.70	53.44	68.20	-14.76	peak	H
5650.000	2.39	39.14	41.53	68.20	-26.67	peak	V
5700.000	2.52	38.70	41.22	105.20	-63.98	peak	V
5720.000	2.57	39.29	41.86	110.80	-68.94	peak	V
5725.000	2.58	39.58	42.16	122.20	-80.04	peak	V
5850.000	2.89	39.09	41.98	122.20	-80.22	peak	V
5855.000	2.90	38.66	41.56	110.80	-69.24	peak	V
5875.000	2.95	38.64	41.59	105.20	-63.61	peak	V
5925.000	3.07	38.96	42.03	68.20	-26.17	peak	V
11570.000	16.00	31.12	47.12	74.00	-26.88	peak	V
11570.000	16.00	18.69	34.69	54.00	-19.31	AVG	V
17355.000	30.74	24.00	54.74	68.20	-13.46	peak	V

Note: Level = Reading + Factor

Margin = Level – Limit

Factor= Antenna Factor + Cable Loss - Amplifier Factor



Power	: DC 3.3V	Temperature	: 24 °C
Test Mode	: Mode 1, CH165 Band4	Humidity	: 54 %
Test date	: 2020-01-02	Atmospheric Pressure	: 1010 hpa

Frequency (MHz)	Factor (dB/m)	Reading (dBuV)	Level (dBuV/m)	Limit (dBuV/m)	Margin (dB)	Detector mode (PK/AVG)	AntPol. H/V
5850.000	2.89	49.93	52.82	122.20	-69.38	peak	H
5855.000	2.90	42.14	45.04	110.80	-65.76	peak	H
5875.000	2.95	39.71	42.66	105.20	-62.54	peak	H
5925.000	3.07	39.02	42.09	68.20	-26.11	peak	H
11650.000	16.16	30.04	46.20	74.00	-27.80	peak	H
11650.000	16.16	17.69	33.85	54.00	-20.15	AVG	H
17475.000	31.21	22.41	53.62	68.20	-14.58	peak	H
5850.000	2.89	55.35	58.24	122.20	-63.96	peak	V
5855.000	2.90	50.86	53.76	110.80	-57.04	peak	V
5875.000	2.95	40.43	43.38	105.20	-61.82	peak	V
5925.000	3.07	39.43	42.50	68.20	-25.70	peak	V
11650.000	16.16	30.75	46.91	74.00	-27.09	peak	V
11650.000	16.16	18.57	34.73	54.00	-19.27	AVG	V
17475.000	31.21	23.08	54.29	68.20	-13.91	peak	V

Note: Level = Reading + Factor

Margin = Level – Limit

Factor= Antenna Factor + Cable Loss - Amplifier Factor



Power	: DC 3.3V	Temperature	: 24 °C
Test Mode	: Mode 2, CH36 Band 1	Humidity	: 54 %
Test date	: 2020-01-02	Atmospheric Pressure	: 1010 hpa

Frequency (MHz)	Factor (dB/m)	Reading (dBuV)	Level (dBuV/m)	Limit (dBuV/m)	Margin (dB)	Detector mode (PK/AVG)	AntPol. H/V
5150.000	1.73	50.70	52.43	74.00	-21.57	peak	H
5150.000	1.73	28.39	30.12	54.00	-23.88	AVG	H
10360.000	12.85	32.17	45.02	68.20	-23.18	peak	H
15540.000	25.25	27.60	52.85	74.00	-21.15	peak	H
15540.000	25.25	14.91	40.16	54.00	-13.84	AVG	H
5150.000	1.73	58.68	60.41	74.00	-13.59	peak	V
5150.000	1.73	43.59	45.32	54.00	-8.68	AVG	V
10360.000	12.85	32.72	45.57	68.20	-22.63	peak	V
15540.000	25.25	28.47	53.72	74.00	-20.28	peak	V
15540.000	25.25	16.18	41.43	54.00	-12.57	AVG	V

Note: Level = Reading + Factor

Margin = Level – Limit

Factor= Antenna Factor + Cable Loss - Amplifier Factor



Power	: DC 3.3V	Temperature	: 24 °C
Test Mode	: Mode 2, CH44 Band 1	Humidity	: 54 %
Test date	: 2020-01-02	Atmospheric Pressure	: 1010 hpa

Frequency (MHz)	Factor (dB/m)	Reading (dBuV)	Level (dBuV/m)	Limit (dBuV/m)	Margin (dB)	Detector mode (PK/AVG)	AntPol. H/V
5150.000	1.73	39.02	40.75	74.00	-33.25	peak	H
5150.000	1.73	28.53	30.26	54.00	-23.74	AVG	H
5350.000	1.89	39.86	41.75	74.00	-32.25	peak	H
5350.000	1.89	28.07	29.96	54.00	-24.04	AVG	H
10440.000	13.03	32.19	45.22	68.20	-22.98	peak	H
15660.000	25.30	27.72	53.02	74.00	-20.98	peak	H
15660.000	25.30	15.54	40.84	54.00	-13.16	AVG	H
5150.000	1.73	39.84	41.57	74.00	-32.43	peak	V
5150.000	1.73	28.52	30.25	54.00	-23.75	AVG	V
5350.000	1.89	39.72	41.61	74.00	-32.39	peak	V
5350.000	1.89	28.51	30.40	54.00	-23.60	AVG	V
10440.000	13.03	32.70	45.73	68.20	-22.47	peak	V
15660.000	25.30	28.39	53.69	74.00	-20.31	peak	V
15660.000	25.30	16.02	41.32	54.00	-12.68	AVG	V

Note: Level = Reading + Factor

Margin = Level – Limit

Factor= Antenna Factor + Cable Loss - Amplifier Factor



Power	:	DC 3.3V	Temperature	:	24 °C
Test Mode	:	Mode 2, CH48 band 1	Humidity	:	54 %
Test date	:	2020-01-02	Atmospheric Pressure	:	1010 hpa

Frequency (MHz)	Factor (dB/m)	Reading (dBuV)	Level (dBuV/m)	Limit (dBuV/m)	Margin (dB)	Detector mode (PK/AVG)	AntPol. H/V
5350.000	1.89	39.93	41.82	74.00	-32.18	peak	H
5350.000	1.89	28.26	30.15	54.00	-23.85	AVG	H
10480.000	13.12	31.90	45.02	68.20	-23.18	peak	H
15720.000	25.33	27.29	52.62	74.00	-21.38	peak	H
15720.000	25.33	15.08	40.41	54.00	-13.59	AVG	H
5350.000	1.89	39.56	41.45	74.00	-32.55	peak	V
5350.000	1.89	28.03	29.92	54.00	-24.08	AVG	V
10480.000	13.12	32.83	45.95	68.20	-22.25	peak	V
15720.000	25.33	28.41	53.74	74.00	-20.26	peak	V
15720.000	25.33	16.17	41.50	54.00	-12.50	AVG	V

Note: Level = Reading + Factor

Margin = Level – Limit

Factor= Antenna Factor + Cable Loss - Amplifier Factor



Power	:	DC 3.3V	Temperature	:	24 °C
Test Mode	:	Mode 2, CH52 Band 2	Humidity	:	54 %
Test date	:	2020-01-02	Atmospheric Pressure	:	1010 hpa

Frequency (MHz)	Factor (dB/m)	Reading (dBuV)	Level (dBuV/m)	Limit (dBuV/m)	Margin (dB)	Detector mode (PK/AVG)	AntPol. H/V
5350.000	1.89	39.64	41.53	74.00	-32.47	peak	H
5350.000	1.89	28.35	30.24	54.00	-23.76	AVG	H
10520.000	13.22	32.11	45.33	68.20	-22.87	peak	H
15780.000	25.36	27.47	52.83	74.00	-21.17	peak	H
15780.000	25.36	15.39	40.75	54.00	-13.25	AVG	H
5350.000	1.89	39.65	41.54	74.00	-32.46	peak	V
5350.000	1.89	28.73	30.62	54.00	-23.38	AVG	V
10520.000	13.22	32.52	45.74	68.20	-22.46	peak	V
15780.000	25.36	28.15	53.51	74.00	-20.49	peak	V
15780.000	25.36	15.91	41.27	54.00	-12.73	AVG	V

Note: Level = Reading + Factor

Margin = Level – Limit

Factor= Antenna Factor + Cable Loss - Amplifier Factor



Power	: DC 3.3V	Temperature	: 24 °C
Test Mode	: Mode 2, CH60 Band 2	Humidity	: 54 %
Test date	: 2020-01-02	Atmospheric Pressure	: 1010 hpa

Frequency (MHz)	Factor (dB/m)	Reading (dBuV)	Level (dBuV/m)	Limit (dBuV/m)	Margin (dB)	Detector mode (PK/AVG)	AntPol. H/V
5350.000	1.89	39.67	41.56	74.00	-32.44	peak	H
5350.000	1.89	28.23	30.12	54.00	-23.88	AVG	H
10600.000	13.46	31.33	44.79	74.00	-29.21	peak	H
10600.000	13.46	18.99	32.45	54.00	-21.55	AVG	H
15900.000	25.41	27.77	53.18	74.00	-20.82	peak	H
15900.000	25.41	15.11	40.52	54.00	-13.48	AVG	H
5350.000	1.89	39.67	41.56	74.00	-32.44	peak	V
5350.000	1.89	28.31	30.20	54.00	-23.80	AVG	V
10600.000	13.46	32.33	45.79	74.00	-28.21	peak	V
10600.000	13.46	19.11	32.57	54.00	-21.43	AVG	V
15900.000	25.41	28.07	53.48	74.00	-20.52	peak	V
15900.000	25.41	15.92	41.33	54.00	-12.67	AVG	V

Note: Level = Reading + Factor

Margin = Level – Limit

Factor= Antenna Factor + Cable Loss - Amplifier Factor



Power	:	DC 3.3V	Temperature	:	24 °C
Test Mode	:	Mode 2, CH64 Band 2	Humidity	:	54 %
Test date	:	2020-01-02	Atmospheric Pressure	:	1010 hpa

Frequency (MHz)	Factor (dB/m)	Reading (dBuV)	Level (dBuV/m)	Limit (dBuV/m)	Margin (dB)	Detector mode (PK/AVG)	AntPol. H/V
5350.000	1.89	49.34	51.23	74.00	-22.77	peak	H
5350.000	1.89	33.77	35.66	54.00	-18.34	AVG	H
10640.000	13.58	32.01	45.59	74.00	-28.41	peak	H
10640.000	13.58	19.70	33.28	54.00	-20.72	AVG	H
15960.000	25.44	27.37	52.81	74.00	-21.19	peak	H
15960.000	25.44	15.23	40.67	54.00	-13.33	AVG	H
5350.000	1.89	58.25	60.14	74.00	-13.86	peak	V
5350.000	1.89	43.74	45.63	54.00	-8.37	AVG	V
10640.000	13.58	32.71	46.29	74.00	-27.71	peak	V
10640.000	13.58	19.90	33.48	54.00	-20.52	AVG	V
15960.000	25.44	28.18	53.62	74.00	-20.38	peak	V
15960.000	25.44	16.10	41.54	54.00	-12.46	AVG	V

Note: Level = Reading + Factor
Margin = Level – Limit
Factor= Antenna Factor + Cable Loss - Amplifier Factor



Power	: DC 3.3V	Temperature	: 24 °C
Test Mode	: Mode 2, CH100 Band 3	Humidity	: 54 %
Test date	: 2020-01-02	Atmospheric Pressure	: 1010 hpa

Frequency (MHz)	Factor (dB/m)	Reading (dBuV)	Level (dBuV/m)	Limit (dBuV/m)	Margin (dB)	Detector mode (PK/AVG)	AntPol. H/V
5460.000	1.99	39.32	41.31	74.00	-32.69	peak	H
5460.000	1.99	27.94	29.93	54.00	-24.07	AVG	H
5470.000	1.99	47.45	49.44	68.20	-18.76	peak	H
11000.000	14.67	31.00	45.67	74.00	-28.33	peak	H
11000.000	14.67	18.89	33.56	54.00	-20.44	AVG	H
16500.000	29.95	23.17	53.12	68.20	-15.08	peak	H
5460.000	1.99	45.13	47.12	74.00	-26.88	peak	V
5460.000	1.99	30.33	32.32	54.00	-21.68	AVG	V
5470.000	1.99	57.73	59.72	68.20	-8.48	peak	V
11000.000	14.67	31.90	46.57	74.00	-27.43	peak	V
11000.000	14.67	19.05	33.72	54.00	-20.28	AVG	V
16500.000	29.95	23.79	53.74	68.20	-14.46	peak	V

Note: Level = Reading + Factor

Margin = Level – Limit

Factor= Antenna Factor + Cable Loss - Amplifier Factor



Power	: DC 3.3V	Temperature	: 24 °C
Test Mode	: Mode 2, CH116 Band 3	Humidity	: 54 %
Test date	: 2020-01-02	Atmospheric Pressure	: 1010 hpa

Frequency (MHz)	Factor (dB/m)	Reading (dBUV)	Level (dBUV/m)	Limit (dBUV/m)	Margin (dB)	Detector mode (PK/AVG)	AntPol. H/V
5460.000	1.99	39.60	41.59	74.00	-32.41	peak	H
5460.000	1.99	28.24	30.23	54.00	-23.77	AVG	H
5470.000	1.99	39.86	41.85	68.20	-26.35	peak	H
5725.000	2.58	39.16	41.74	68.20	-26.46	peak	H
11160.000	15.05	30.57	45.62	74.00	-28.38	peak	H
11160.000	15.05	18.35	33.40	54.00	-20.60	AVG	H
16740.000	29.65	23.19	52.84	68.20	-15.36	peak	H
5460.000	1.99	39.40	41.39	74.00	-32.61	peak	V
5460.000	1.99	28.43	30.42	54.00	-23.58	AVG	V
5470.000	1.99	39.90	41.89	68.20	-26.31	peak	V
5725.000	2.58	39.14	41.72	68.20	-26.48	peak	V
11160.000	15.05	31.54	46.59	74.00	-27.41	peak	V
11160.000	15.05	19.47	34.52	54.00	-19.48	AVG	V
16740.000	29.65	24.16	53.81	68.20	-14.39	peak	V

Note: Level = Reading + Factor
Margin = Level – Limit
Factor= Antenna Factor + Cable Loss - Amplifier Factor



Power	:	DC 3.3V	Temperature	:	24 °C
Test Mode	:	Mode 2, CH140 Band 3	Humidity	:	54 %
Test date	:	2020-01-02	Atmospheric Pressure	:	1010 hpa

Frequency (MHz)	Factor (dB/m)	Reading (dBuV)	Level (dBuV/m)	Limit (dBuV/m)	Margin (dB)	Detector mode (PK/AVG)	AntPol. H/V
5725.000	2.58	58.74	61.32	68.20	-6.88	peak	H
11400.000	15.62	30.56	46.18	74.00	-27.82	peak	H
11400.000	15.62	18.27	33.89	54.00	-20.11	AVG	H
17100.000	29.73	22.72	52.45	68.20	-15.75	peak	H
5725.000	2.58	62.01	64.59	68.20	-3.61	peak	V
11400.000	15.62	31.31	46.93	74.00	-27.07	peak	V
11400.000	15.62	18.57	34.19	54.00	-19.81	AVG	V
17100.000	29.73	24.06	53.79	68.20	-14.41	peak	V

Note: Level = Reading + Factor

Margin = Level – Limit

Factor= Antenna Factor + Cable Loss - Amplifier Factor



Power	: DC 3.3V	Temperature	: 24 °C
Test Mode	: Mode 2, CH149 Band 4	Humidity	: 54 %
Test date	: 2020-01-02	Atmospheric Pressure	: 1010 hpa

Frequency (MHz)	Factor (dB/m)	Reading (dBuV)	Level (dBuV/m)	Limit (dBuV/m)	Margin (dB)	Detector mode (PK/AVG)	AntPol. H/V
5650.000	2.39	40.53	42.92	68.20	-25.28	peak	H
5700.000	2.52	39.24	41.76	105.20	-63.44	peak	H
5720.000	2.57	54.78	57.35	110.80	-53.45	peak	H
5725.000	2.58	64.58	67.16	122.20	-55.04	peak	H
11490.000	15.84	30.67	46.51	74.00	-27.49	peak	H
11490.000	15.84	17.80	33.64	54.00	-20.36	AVG	H
17235.000	30.26	23.46	53.72	68.20	-14.48	peak	H
5650.000	2.39	39.87	42.26	68.20	-25.94	peak	V
5700.000	2.52	41.38	43.90	105.20	-61.30	peak	V
5720.000	2.57	59.13	61.70	110.80	-49.10	peak	V
5725.000	2.58	65.69	68.27	122.20	-53.93	peak	V
11490.000	15.84	30.97	46.81	74.00	-27.19	peak	V
11490.000	15.84	18.77	34.61	54.00	-19.39	AVG	V
17235.000	30.26	24.57	54.83	68.20	-13.37	peak	V

Note: Level = Reading + Factor
Margin = Level – Limit
Factor= Antenna Factor + Cable Loss - Amplifier Factor



Power	: DC 3.3V	Temperature	: 24 °C
Test Mode	: Mode 2, CH157 Band 4	Humidity	: 54 %
Test date	: 2020-01-02	Atmospheric Pressure	: 1010 hpa

Frequency (MHz)	Factor (dB/m)	Reading (dBuV)	Level (dBuV/m)	Limit (dBuV/m)	Margin (dB)	Detector mode (PK/AVG)	AntPol. H/V
5650.000	2.39	39.24	41.63	68.20	-26.57	peak	H
5700.000	2.52	39.66	42.18	105.20	-63.02	peak	H
5720.000	2.57	38.99	41.56	110.80	-69.24	peak	H
5725.000	2.58	39.48	42.06	122.20	-80.14	peak	H
5850.000	2.89	39.06	41.95	122.20	-80.25	peak	H
5855.000	2.90	38.84	41.74	110.80	-69.06	peak	H
5875.000	2.95	39.11	42.06	105.20	-63.14	peak	H
5925.000	3.07	39.17	42.24	68.20	-25.96	peak	H
11570.000	16.00	30.57	46.57	74.00	-27.43	peak	H
11570.000	16.00	18.29	34.29	54.00	-19.71	AVG	H
17355.000	30.74	22.54	53.28	68.20	-14.92	peak	H
5650.000	2.39	39.46	41.85	68.20	-26.35	peak	V
5700.000	2.52	39.04	41.56	105.20	-63.64	peak	V
5720.000	2.57	39.15	41.72	110.80	-69.08	peak	V
5725.000	2.58	39.41	41.99	122.20	-80.21	peak	V
5850.000	2.89	39.14	42.03	122.20	-80.17	peak	V
5855.000	2.90	38.73	41.63	110.80	-69.17	peak	V
5875.000	2.95	38.77	41.72	105.20	-63.48	peak	V
5925.000	3.07	39.03	42.10	68.20	-26.10	peak	V
11570.000	16.00	31.32	47.32	74.00	-26.68	peak	V
11570.000	16.00	18.79	34.79	54.00	-19.21	AVG	V
17355.000	30.74	24.07	54.81	68.20	-13.39	peak	V

Note: Level = Reading + Factor

Margin = Level – Limit

Factor= Antenna Factor + Cable Loss - Amplifier Factor



Power	: DC 3.3V	Temperature	: 24 °C
Test Mode	: Mode 2, CH165 Band4	Humidity	: 54 %
Test date	: 2020-01-02	Atmospheric Pressure	: 1010 hpa

Frequency (MHz)	Factor (dB/m)	Reading (dBuV)	Level (dBuV/m)	Limit (dBuV/m)	Margin (dB)	Detector mode (PK/AVG)	AntPol. H/V
5850.000	2.89	49.45	52.34	122.20	-69.86	peak	H
5855.000	2.90	44.95	47.85	110.80	-62.95	peak	H
5875.000	2.95	39.31	42.26	105.20	-62.94	peak	H
5925.000	3.07	39.42	42.49	68.20	-25.71	peak	H
11650.000	16.16	33.37	49.53	74.00	-24.47	peak	H
11650.000	16.16	17.59	33.75	54.00	-20.25	AVG	H
17475.000	31.21	22.47	53.68	68.20	-14.52	peak	H
5850.000	2.89	58.77	61.66	122.20	-60.54	peak	V
5855.000	2.90	51.47	54.37	110.80	-56.43	peak	V
5875.000	2.95	39.98	42.93	105.20	-62.27	peak	V
5925.000	3.07	38.73	41.80	68.20	-26.40	peak	V
11650.000	16.16	31.06	47.22	74.00	-26.78	peak	V
11650.000	16.16	18.60	34.76	54.00	-19.24	AVG	V
17475.000	31.21	23.17	54.38	68.20	-13.82	peak	V

Note: Level = Reading + Factor
Margin = Level – Limit
Factor= Antenna Factor + Cable Loss - Amplifier Factor



Power	:	DC 3.3V	Temperature	:	24 °C
Test Mode	:	Mode 3, CH38 Band 1	Humidity	:	54 %
Test date	:	2020-01-02	Atmospheric Pressure	:	1010 hpa

Frequency (MHz)	Factor (dB/m)	Reading (dBuV)	Level (dBuV/m)	Limit (dBuV/m)	Margin (dB)	Detector mode (PK/AVG)	AntPol. H/V
5150.000	1.73	58.28	60.01	74.00	-13.99	peak	H
5150.000	1.73	45.80	47.53	54.00	-6.47	AVG	H
10380.000	12.89	31.97	44.86	68.20	-23.34	peak	H
15570.000	25.26	28.00	53.26	74.00	-20.74	peak	H
15570.000	25.26	25.26	50.52	54.00	-3.48	AVG	H
5150.000	1.73	62.13	63.86	74.00	-10.14	peak	V
5150.000	1.73	49.01	50.74	54.00	-3.26	AVG	V
10380.000	12.89	32.89	45.78	68.20	-22.42	peak	V
15570.000	25.26	28.46	53.72	74.00	-20.28	peak	V
15570.000	25.26	16.11	41.37	54.00	-12.63	AVG	V

Note: Level = Reading + Factor

Margin = Level – Limit

Factor= Antenna Factor + Cable Loss - Amplifier Factor



Power	: DC 3.3V	Temperature	: 24 °C
Test Mode	: Mode 3, CH46 Band 1	Humidity	: 54 %
Test date	: 2020-01-02	Atmospheric Pressure	: 1010 hpa

Frequency (MHz)	Factor (dB/m)	Reading (dBuV)	Level (dBuV/m)	Limit (dBuV/m)	Margin (dB)	Detector mode (PK/AVG)	AntPol. H/V
5350.000	1.89	40.46	42.35	74.00	-31.65	peak	H
5350.000	1.89	28.05	29.94	54.00	-24.06	AVG	H
10460.000	13.07	31.71	44.78	68.20	-23.42	peak	H
15690.000	25.32	27.39	52.71	74.00	-21.29	peak	H
15690.000	25.32	15.04	40.36	54.00	-13.64	AVG	H
5350.000	1.89	46.71	48.60	74.00	-25.40	peak	V
5350.000	1.89	33.78	35.67	54.00	-18.33	AVG	V
10460.000	13.07	32.81	45.88	68.20	-22.32	peak	V
15690.000	25.32	28.39	53.71	74.00	-20.29	peak	V
15690.000	25.32	16.21	41.53	54.00	-12.47	AVG	V

Note: Level = Reading + Factor

Margin = Level – Limit

Factor= Antenna Factor + Cable Loss - Amplifier Factor



Power	: DC 3.3V	Temperature	: 24 °C
Test Mode	: Mode 3, CH54 Band 2	Humidity	: 54 %
Test date	: 2020-01-02	Atmospheric Pressure	: 1010 hpa

Frequency (MHz)	Factor (dB/m)	Reading (dBuV)	Level (dBuV/m)	Limit (dBuV/m)	Margin (dB)	Detector mode (PK/AVG)	AntPol. H/V
5350.000	1.89	39.02	40.91	74.00	-33.09	peak	H
5350.000	1.89	28.23	30.12	54.00	-23.88	AVG	H
10540.000	13.28	31.58	44.86	68.20	-23.34	peak	H
15810.000	25.37	27.44	52.81	74.00	-21.19	peak	H
15810.000	25.37	15.20	40.57	54.00	-13.43	AVG	H
5350.000	1.89	45.86	47.75	74.00	-26.25	peak	V
5350.000	1.89	32.74	34.63	54.00	-19.37	AVG	V
10540.000	13.28	32.49	45.77	68.20	-22.43	peak	V
15810.000	25.37	18.19	43.56	74.00	-30.44	peak	V
15810.000	25.37	15.84	41.21	54.00	-12.79	AVG	V

Note: Level = Reading + Factor

Margin = Level – Limit

Factor= Antenna Factor + Cable Loss - Amplifier Factor



Power	: DC 3.3V	Temperature	: 24 °C
Test Mode	: Mode 3, CH62 Band 2	Humidity	: 54 %
Test date	: 2020-01-02	Atmospheric Pressure	: 1010 hpa

Frequency (MHz)	Factor (dB/m)	Reading (dBuV)	Level (dBuV/m)	Limit (dBuV/m)	Margin (dB)	Detector mode (PK/AVG)	AntPol. H/V
5350.000	1.89	60.21	62.10	74.00	-11.90	peak	H
5350.000	1.89	47.62	49.51	54.00	-4.49	AVG	H
10620.000	13.52	31.72	45.24	74.00	-28.76	peak	H
10620.000	13.52	19.27	32.79	54.00	-21.21	AVG	H
15930.000	25.43	27.24	52.67	74.00	-21.33	peak	H
15930.000	25.43	15.08	40.51	54.00	-13.49	AVG	H
5350.000	1.89	62.33	64.22	74.00	-9.78	peak	V
5350.000	1.89	49.13	51.02	54.00	-2.98	AVG	V
10620.000	13.52	32.65	46.17	74.00	-27.83	peak	V
10620.000	13.52	20.30	33.82	54.00	-20.18	AVG	V
15930.000	25.43	28.21	53.64	74.00	-20.36	peak	V
15930.000	25.43	15.87	41.30	54.00	-12.70	AVG	V

Note: Level = Reading + Factor
Margin = Level – Limit
Factor= Antenna Factor + Cable Loss - Amplifier Factor



Power	: DC 3.3V	Temperature	: 24 °C
Test Mode	: Mode 3, CH102 Band 3	Humidity	: 54 %
Test date	: 2020-01-02	Atmospheric Pressure	: 1010 hpa

Frequency (MHz)	Factor (dB/m)	Reading (dBuV)	Level (dBuV/m)	Limit (dBuV/m)	Margin (dB)	Detector mode (PK/AVG)	AntPol. H/V
5460.000	1.99	52.37	54.36	74.00	-19.64	peak	H
5460.000	1.99	40.20	42.19	54.00	-11.81	AVG	H
5470.000	1.99	58.54	60.53	68.20	-7.67	peak	H
11020.000	14.72	30.77	45.49	74.00	-28.51	peak	H
11020.000	14.72	18.45	33.17	54.00	-20.83	AVG	H
16530.000	29.91	22.78	52.69	68.20	-15.51	peak	H
5460.000	1.99	55.64	57.63	74.00	-16.37	peak	V
5460.000	1.99	43.30	45.29	54.00	-8.71	AVG	V
5470.000	1.99	62.54	64.53	68.20	-3.67	peak	V
11020.000	14.72	31.79	46.51	74.00	-27.49	peak	V
11020.000	14.72	19.56	34.28	54.00	-19.72	AVG	V
16530.000	29.91	24.04	53.95	68.20	-14.25	peak	V

Note: Level = Reading + Factor
Margin = Level – Limit
Factor= Antenna Factor + Cable Loss - Amplifier Factor



Power	: DC 3.3V	Temperature	: 24 °C
Test Mode	: Mode 3, CH110 Band 3	Humidity	: 54 %
Test date	: 2020-01-02	Atmospheric Pressure	: 1010 hpa

Frequency (MHz)	Factor (dB/m)	Reading (dBuV)	Level (dBuV/m)	Limit (dBuV/m)	Margin (dB)	Detector mode (PK/AVG)	AntPol. H/V
5460.000	1.99	39.63	41.62	74.00	-32.38	peak	H
5460.000	1.99	27.87	29.86	54.00	-24.14	AVG	H
5470.000	1.99	44.36	46.35	68.20	-21.85	peak	H
5725.000	2.58	38.86	41.44	68.20	-26.76	peak	H
11100.000	14.91	30.68	45.59	74.00	-28.41	peak	H
11100.000	14.91	18.52	33.43	54.00	-20.57	AVG	H
16650.000	29.76	23.15	52.91	68.20	-15.29	peak	H
5460.000	1.99	42.60	44.59	74.00	-29.41	peak	V
5460.000	1.99	28.44	30.43	54.00	-23.57	AVG	V
5470.000	1.99	53.05	55.04	68.20	-13.16	peak	V
5725.000	2.58	39.14	41.72	68.20	-26.48	peak	V
11100.000	14.91	31.83	46.74	74.00	-27.26	peak	V
11100.000	14.91	19.50	34.41	54.00	-19.59	AVG	V
16650.000	29.76	24.13	53.89	68.20	-14.31	peak	V

Note: Level = Reading + Factor
Margin = Level – Limit
Factor= Antenna Factor + Cable Loss - Amplifier Factor



Power	: DC 3.3V	Temperature	: 24 °C
Test Mode	: Mode 3, CH134 Band 3	Humidity	: 54 %
Test date	: 2020-01-02	Atmospheric Pressure	: 1010 hpa

Frequency (MHz)	Factor (dB/m)	Reading (dBuV)	Level (dBuV/m)	Limit (dBuV/m)	Margin (dB)	Detector mode (PK/AVG)	AntPol. H/V
5725.000	2.58	51.84	54.42	68.20	-13.78	peak	H
11340.000	15.48	30.15	45.63	74.00	-28.37	peak	H
11340.000	15.48	18.22	33.70	54.00	-20.30	AVG	H
17010.000	29.37	23.44	52.81	68.20	-15.39	peak	H
5725.000	2.58	58.27	60.85	68.20	-7.35	peak	V
11340.000	15.48	31.09	46.57	74.00	-27.43	peak	V
11340.000	15.48	18.70	34.18	54.00	-19.82	AVG	V
17010.000	29.37	24.42	53.79	68.20	-14.41	peak	V

Note: Level = Reading + Factor

Margin = Level – Limit

Factor= Antenna Factor + Cable Loss - Amplifier Factor



Power	: DC 3.3V	Temperature	: 24 °C
Test Mode	: Mode 3, CH151 Band 4	Humidity	: 54 %
Test date	: 2020-01-02	Atmospheric Pressure	: 1010 hpa

Frequency (MHz)	Factor (dB/m)	Reading (dBuV)	Level (dBuV/m)	Limit (dBuV/m)	Margin (dB)	Detector mode (PK/AVG)	AntPol. H/V
5650.000	2.39	40.41	42.80	68.20	-25.40	peak	H
5700.000	2.52	47.08	49.60	105.20	-55.60	peak	H
5720.000	2.57	62.34	64.91	110.80	-45.89	peak	H
5725.000	2.58	63.61	66.19	122.20	-56.01	peak	H
11510.000	15.88	30.63	46.51	74.00	-27.49	peak	H
11510.000	15.88	18.31	34.19	54.00	-19.81	AVG	H
17265.000	30.38	22.99	53.37	68.20	-14.83	peak	H
5650.000	2.39	39.80	42.19	68.20	-26.01	peak	V
5700.000	2.52	52.50	55.02	105.20	-50.18	peak	V
5720.000	2.57	64.15	66.72	110.80	-44.08	peak	V
5725.000	2.58	67.10	69.68	122.20	-52.52	peak	V
11510.000	15.88	31.49	47.37	74.00	-26.63	peak	V
11510.000	15.88	19.36	35.24	54.00	-18.76	AVG	V
17265.000	30.38	24.23	54.61	68.20	-13.59	peak	V

Note: Level = Reading + Factor
Margin = Level – Limit
Factor= Antenna Factor + Cable Loss - Amplifier Factor



Power	: DC 3.3V	Temperature	: 24 °C
Test Mode	: Mode 3, CH159 Band 4	Humidity	: 54 %
Test date	: 2020-01-02	Atmospheric Pressure	: 1010 hpa

Frequency (MHz)	Factor (dB/m)	Reading (dBuV)	Level (dBuV/m)	Limit (dBuV/m)	Margin (dB)	Detector mode (PK/AVG)	AntPol. H/V
5850.000	2.89	49.80	52.69	122.20	-69.51	peak	H
5855.000	2.90	43.74	46.64	110.80	-64.16	peak	H
5875.000	2.95	39.51	42.46	105.20	-62.74	peak	H
5925.000	3.07	39.25	42.32	68.20	-25.88	peak	H
11590.000	16.04	29.92	45.96	74.00	-28.04	peak	H
11590.000	16.04	17.71	33.75	54.00	-20.25	AVG	H
17385.000	30.85	22.58	53.43	68.20	-14.77	peak	H
5850.000	2.89	52.66	55.55	122.20	-66.65	peak	V
5855.000	2.90	51.15	54.05	110.80	-56.75	peak	V
5875.000	2.95	44.11	47.06	105.20	-58.14	peak	V
5925.000	3.07	38.98	42.05	68.20	-26.15	peak	V
11590.000	16.04	31.22	47.26	74.00	-26.74	peak	V
11590.000	16.04	19.09	35.13	54.00	-18.87	AVG	V
17385.000	30.85	23.77	54.62	68.20	-13.58	peak	V

Note: Level = Reading + Factor
Margin = Level – Limit
Factor= Antenna Factor + Cable Loss - Amplifier Factor



6.7. Restricted Bands of Operation

Only spurious emissions are permitted in any of the frequency bands listed below:

MHz	MHz	MHz	GHz
0.09000 – 0.11000	16.42000 – 16.42300	399.9 – 410.0	4.500 – 5.150
0.49500 – 0.505**	16.69475 – 16.69525	608.0 – 614.0	5.350 – 5.460
2.17350 – 2.19050	16.80425 – 16.80475	960.0 – 1240.0	7.250 – 7.750
4.12500 – 4.12800	25.50000 – 25.67000	1300.0 – 1427.0	8.025 – 8.500
4.17725 – 4.17775	37.50000 – 38.25000	1435.0 – 1626.5	9.000 – 9.200
4.20725 – 4.20775	73.00000 – 74.60000	1645.5 – 1646.5	9.300 – 9.500
6.21500 – 6.21800	74.80000 – 75.20000	1660.0 – 1710.0	10.600 – 12.700
6.26775 – 6.26825	108.00000 – 121.94000	1718.8 – 1722.2	13.250 – 13.400
6.31175 – 6.31225	123.00000 – 138.00000	2200.0 – 2300.0	14.470 – 14.500
8.29100 – 8.29400	149.90000 – 150.05000	2310.0 – 2390.0	15.350 – 16.200
8.36200 – 8.36600	156.52475 – 156.52525	2483.5 – 2500.0	17.700 – 21.400
8.37625 – 8.38675	156.70000 – 156.90000	2655.0 – 2900.0	22.010 – 23.120
8.41425 – 8.41475	162.01250 – 167.17000	3260.0 – 3267.0	23.600 – 24.000
12.29000 – 12.29300	167.72000 – 173.20000	3332.0 – 3339.0	31.200 – 31.800
12.51975 – 12.52025	240.00000 – 285.00000	3345.8 – 3358.0	36.430 – 36.500
12.57675 – 12.57725	322.00000 – 335.40000	3600.0 – 4400.0	Above 38.6
13.36000 – 13.41000			

** : Until February 1, 1999, this restricted band shall be 0.490-0.510 MHz



7. On Time, Duty Cycle and Measurement methods

7.1. Test Limit

None; for reporting purposes only.

7.2. Test Procedure

KDB 789033 Zero-Span Spectrum Analyzer Method.

7.3. Test Setup Layout

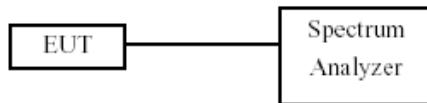

7.4. Test Result and Data

Temperature: 21°C

Humidity: 56%

Test Date: 2019-12-30

Modulation Type	On Time (msec)	Period Time (msec)	Duty Cycle (%)	1/T Minimum VBW(Hz)	Duty Cycle correction Factor (dB)
802.11a	100.00	100.00	100.00%	10.00	0.00
802.11n HT20	100.00	100.00	100.00%	10.00	0.00
802.11n HT40	100.00	100.00	100.00%	10.00	0.00

7.5. Measurement Methods

26 dB and 6dB Emission BW	KDB 789033 D02 v02r01, Section C
99% Occupied BW	KDB 789033 D02 v02r01, Section D
Conducted Output Power	KDB 789033 D02 v02r01, Section E.2.d and E.3.b (Method PM-G)
Power Spectral Density	KDB 789033 D02 v02r01, Section F
Unwanted emissions in restricted bands	KDB 789033 D02 v02r01, Sections G and H
Unwanted emissions in non-restricted bands	KDB 789033 D02 v02r01, Sections G and H



Modulation Standard: 802.11a (6Mbps)

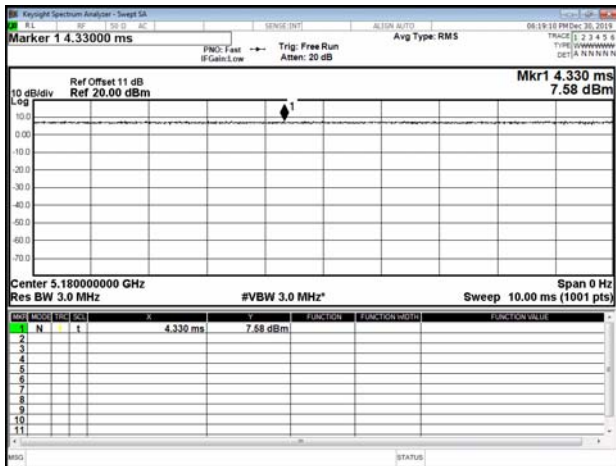

Modulation Standard: 802.11n HT20 (6.5Mbps)

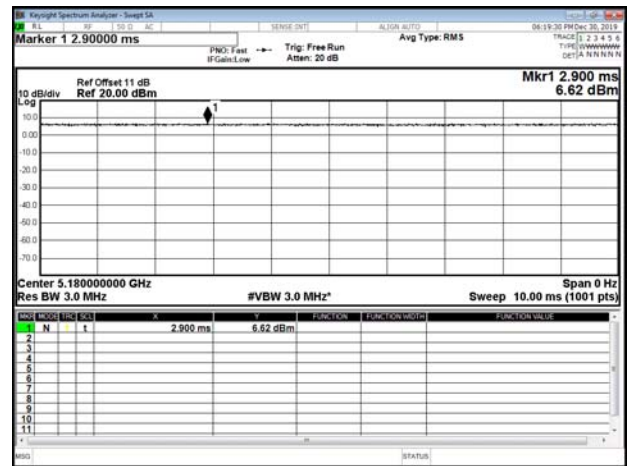

Modulation Standard: 802.11n HT40 (13.5Mbps)

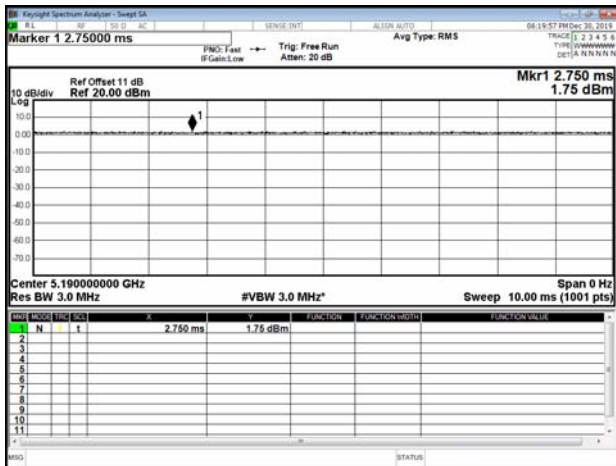



8. 6dB Bandwidth & 99% Bandwidth

8.1. Test Limit

FCC §15.407

The minimum 6 dB bandwidth shall be at least 500 kHz.

8.2. Test Procedure

Reference to 789033 D02 General UNII Test Procedures New Rules v01: The transmitter output is connected to a spectrum analyzer with the RBW set to 100KHz, the VBW $\geq 3 \times$ RBW, peak detector and max hold.

8.3. Test Setup Layout

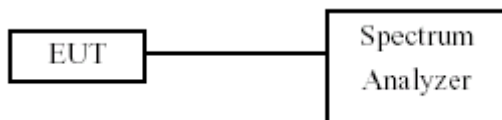



8.4. Test Result and Data (6dB Bandwidth)

Temperature: 21°C

Humidity: 56%

Test Date: 2019-12-30

In the 5.8G Band

Modulation Type	Channel	Frequency (MHz)	6dB Bandwidth (MHz)		Minimum Limit (MHz)
			Chain 1	Chain 2	
802.11a	149	5745	16.37	16.34	0.50
	157	5785	16.38	16.35	0.50
	165	5825	16.39	16.37	0.50
802.11n HT20	149	5745	17.62	17.58	0.50
	157	5785	17.60	17.57	0.50
	165	5825	17.63	17.60	0.50
802.11n HT40	155	5755	36.42	36.39	0.50
	159	5795	36.44	36.39	0.50



6dB Bandwidth
Chain 1
Modulation Standard: 802.11a
CH149

Modulation Standard: 802.11n HT20
CH149

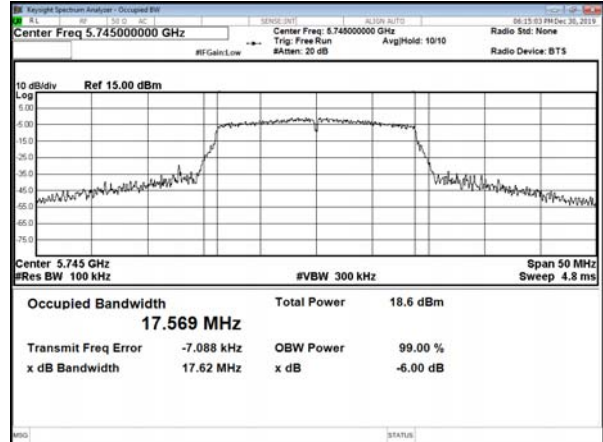
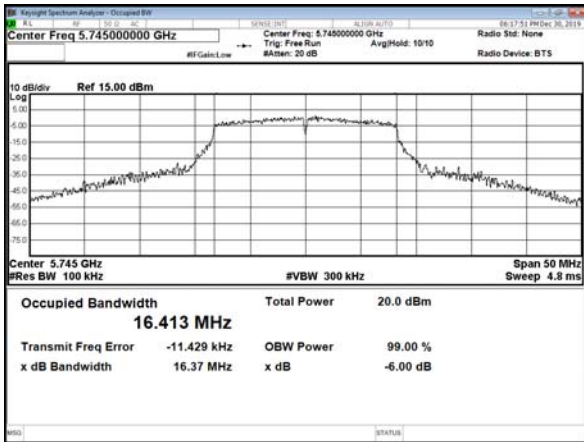

CH157

CH157

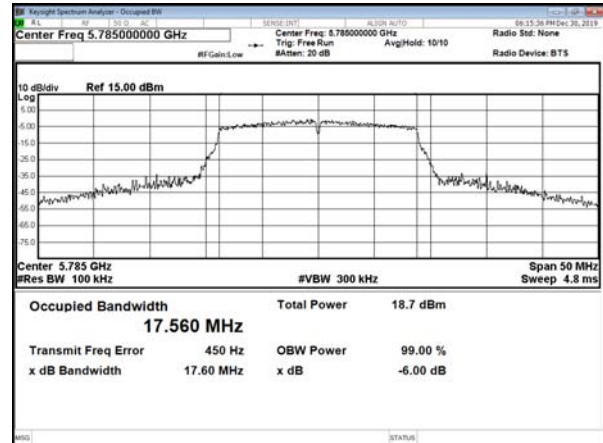
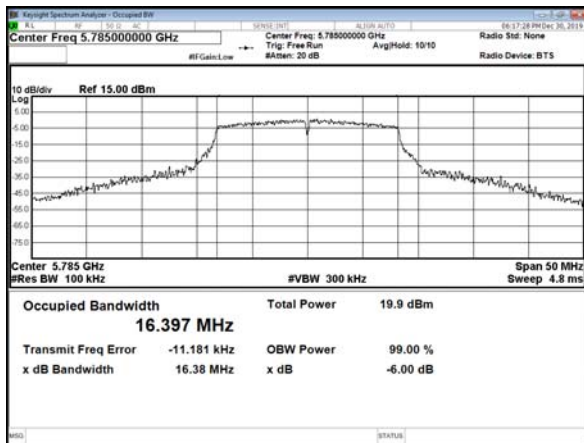

CH165

CH165

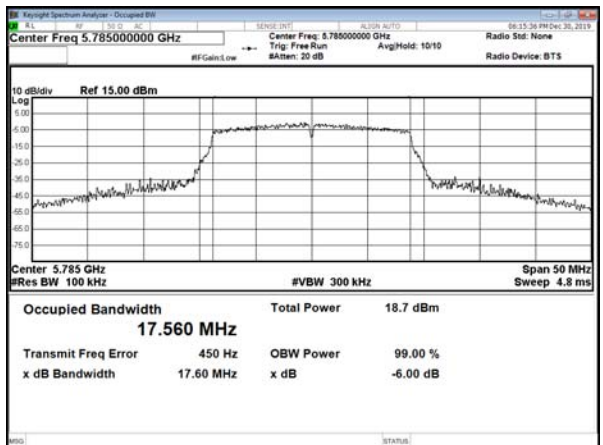
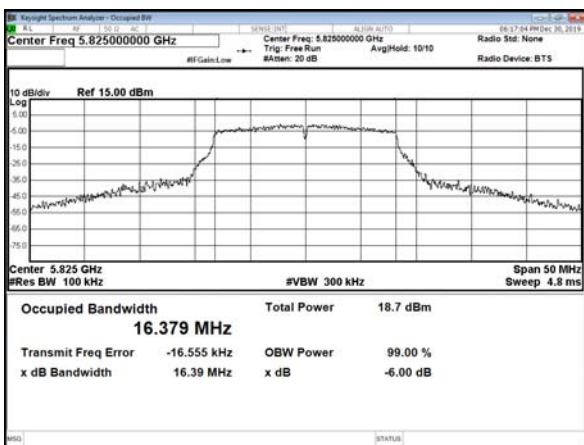



Modulation Standard: 802.11n HT40
CH151

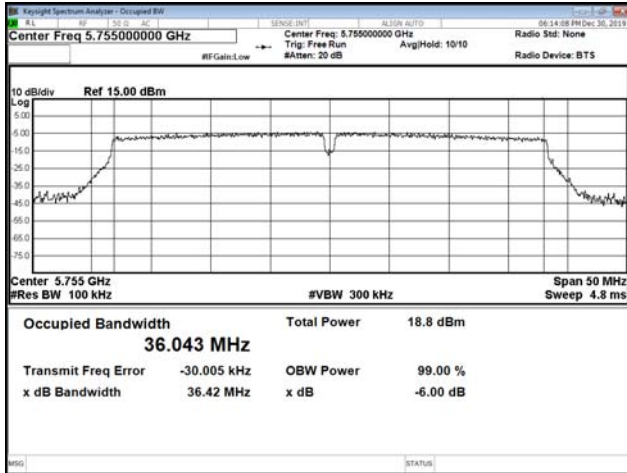

Chain 2
Modulation Standard: 802.11a
CH149

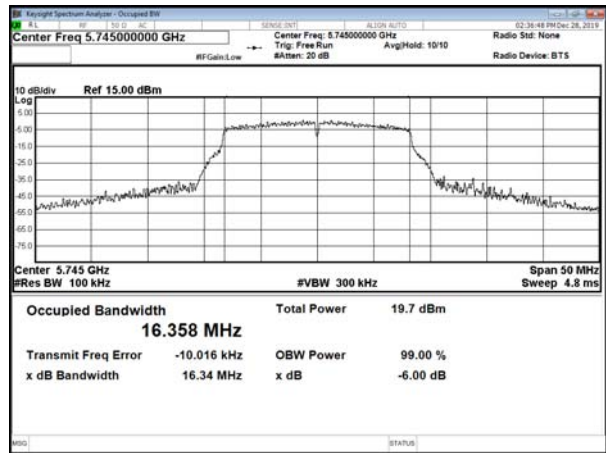

CH159

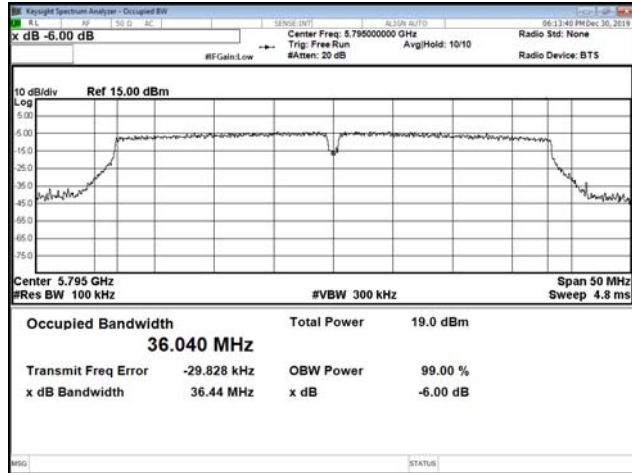

CH157

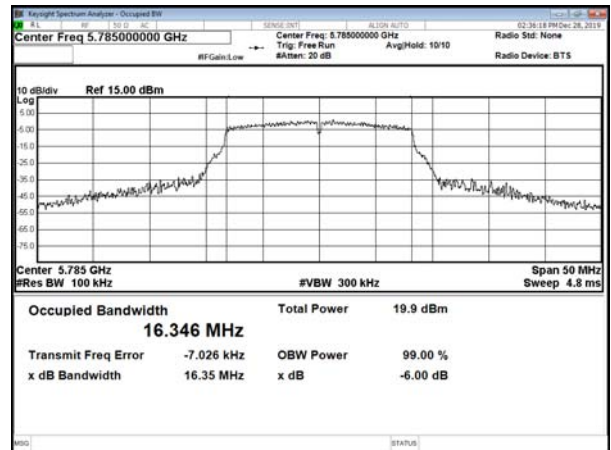

CH165

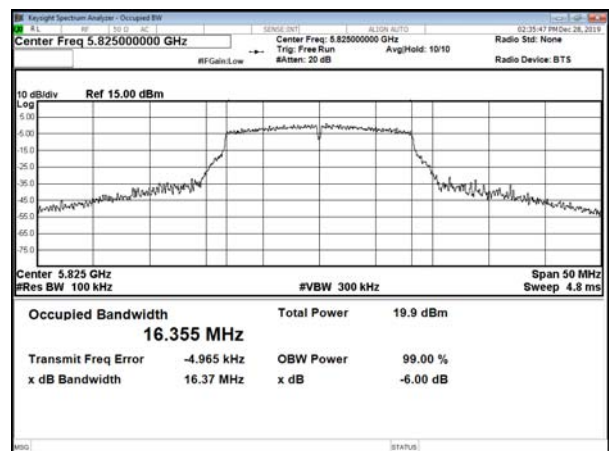



Modulation Standard: 802.11n HT20
CH149

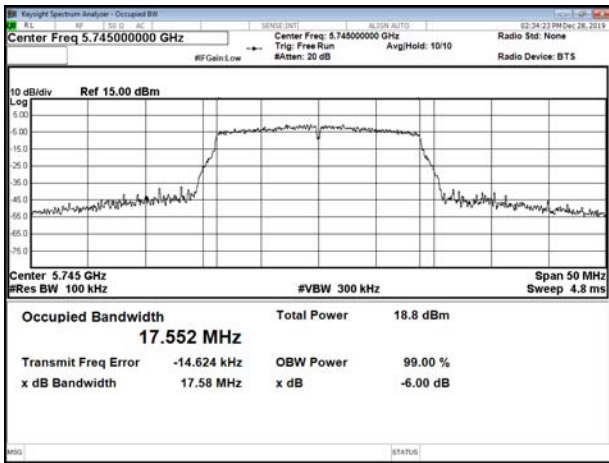

Modulation Standard: 802.11n HT40
CH151



CH157

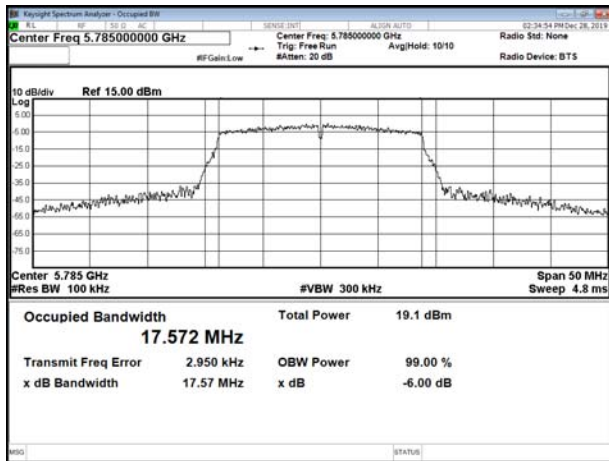

CH159

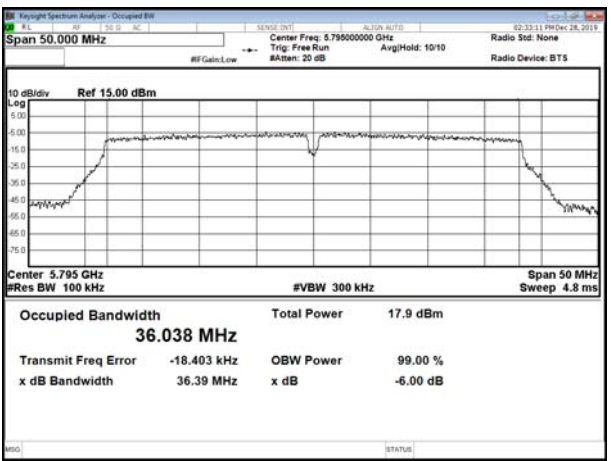

CH165

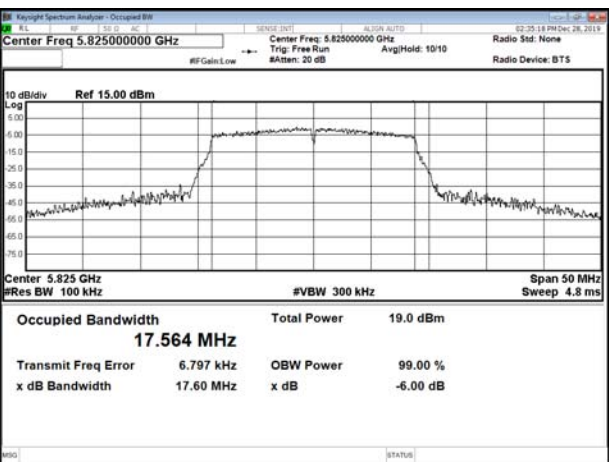



8.5. Test Result and Data (99% Bandwidth)

Temperature: 21°C

Humidity: 56%

Test Date: 2019-12-30

In the 5.8G Band

Modulation Type	Channel	Frequency (MHz)	99% Bandwidth (MHz)	
			Chain 1	Chain 2
802.11a	149	5745	16.49	16.46
	157	5785	16.52	16.42
	165	5825	16.50	16.43
802.11n HT20	149	5745	17.61	17.60
	157	5785	17.63	17.58
	165	5825	17.59	17.62
802.11n HT40	155	5755	36.14	36.22
	159	5795	36.23	36.12



99% Bandwidth
Chain 1
Modulation Standard: 802.11a
CH149

Modulation Standard: 802.11n HT20
CH149

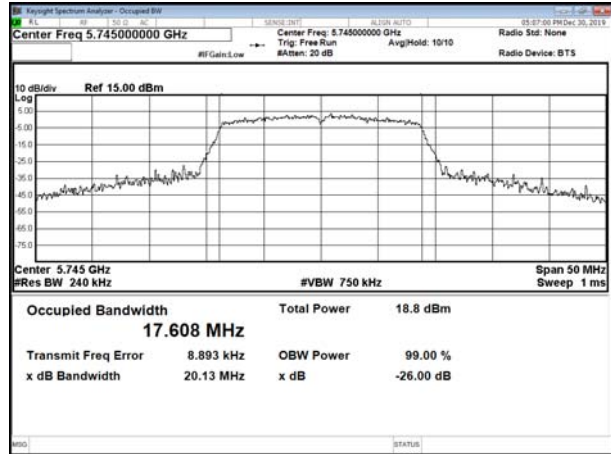
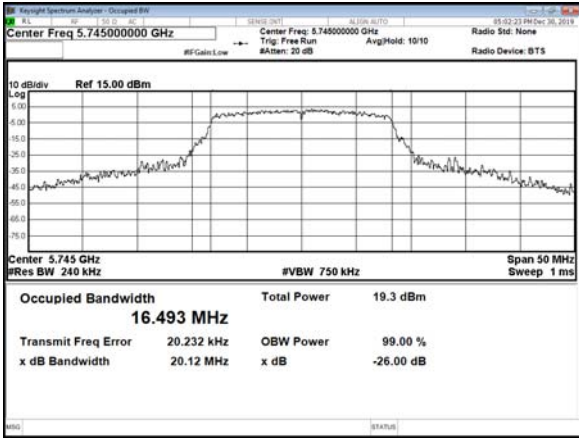

CH157

CH157

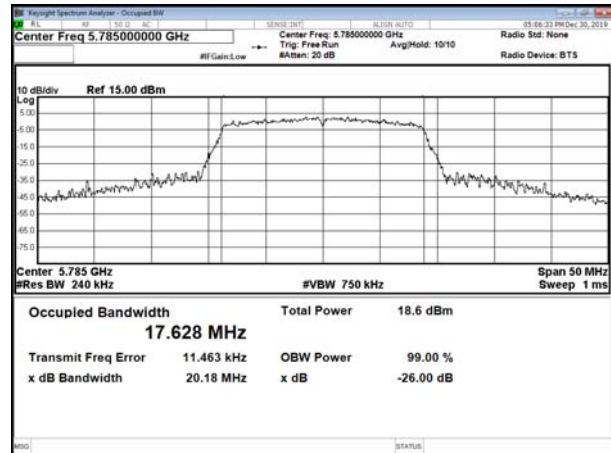
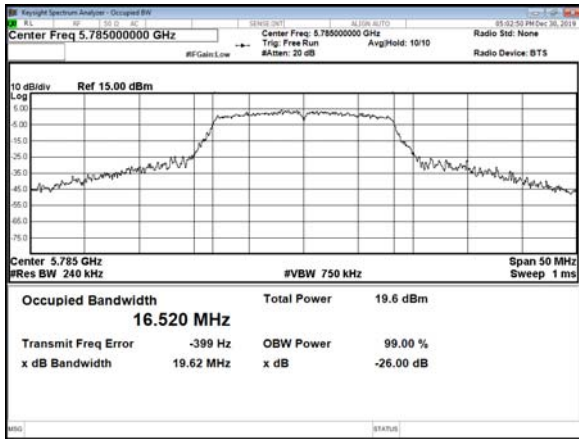

CH165

CH165

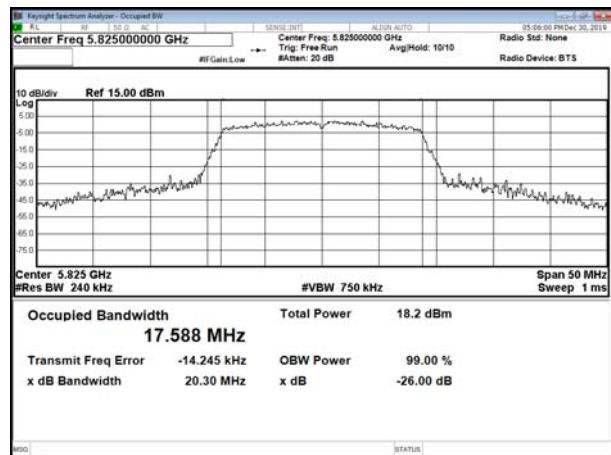
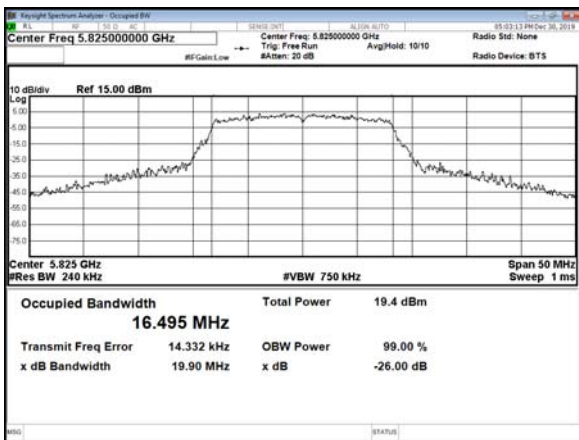



Modulation Standard: 802.11n HT40
CH151

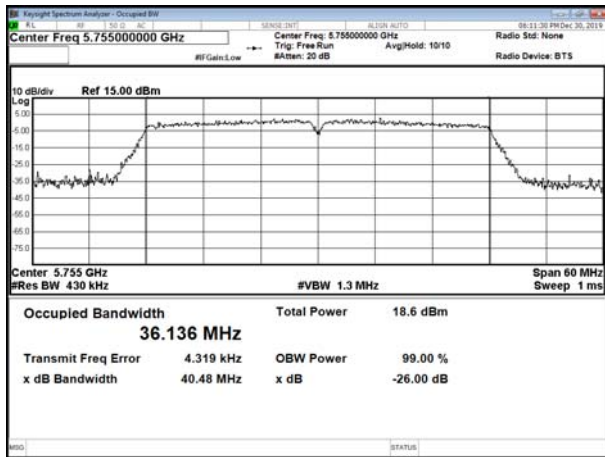

Chain 2
Modulation Standard: 802.11a
CH149

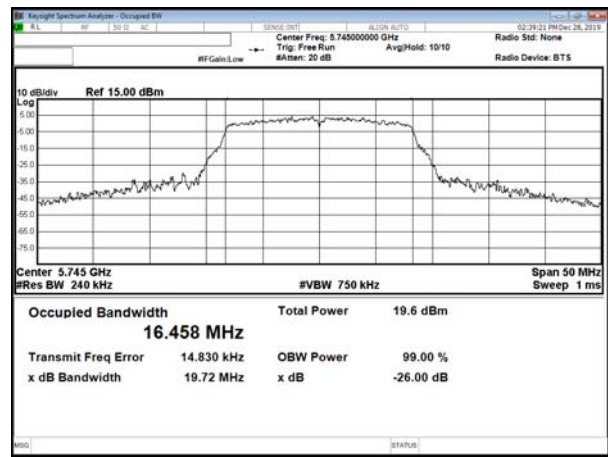

CH159

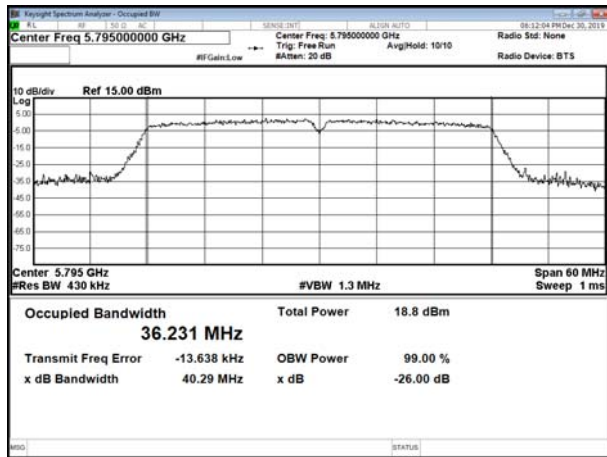

CH157

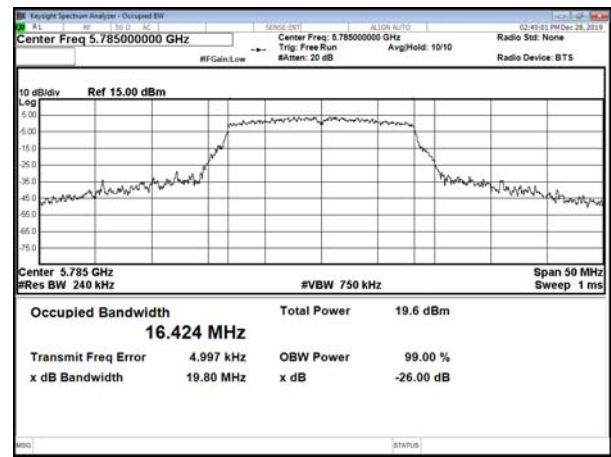

CH165

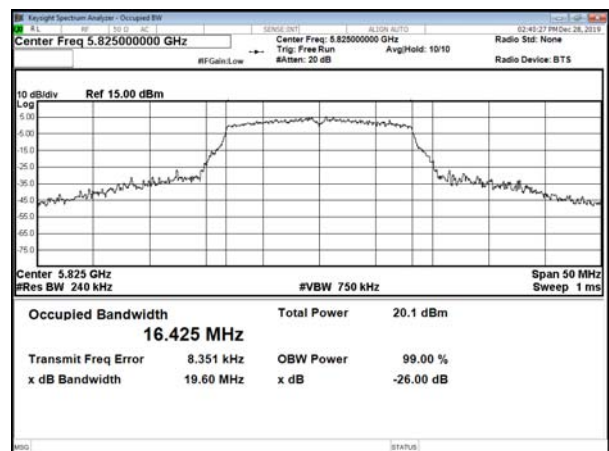



Modulation Standard: 802.11n HT20
CH149

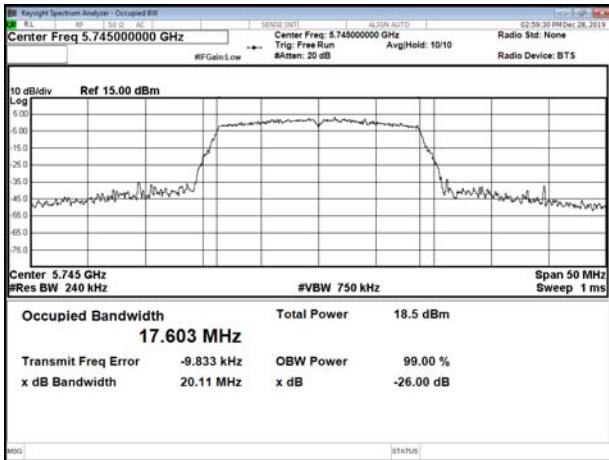

Modulation Standard: 802.11n HT40
CH151

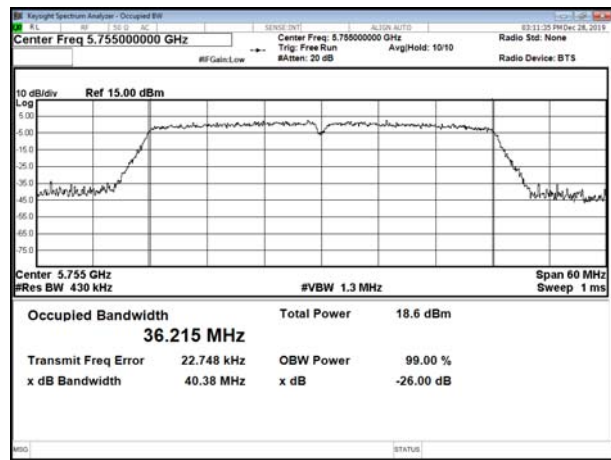

CH157

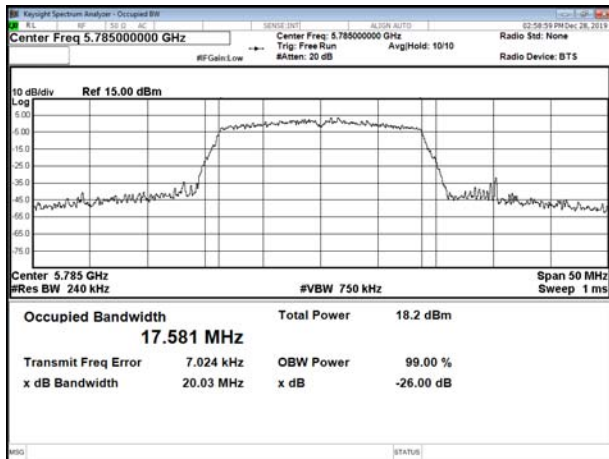

CH159

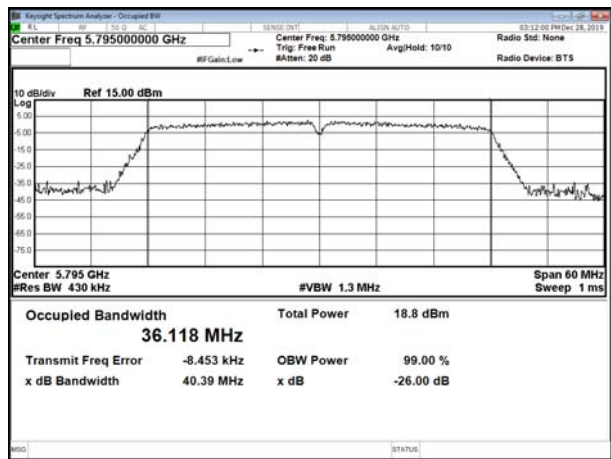

CH165

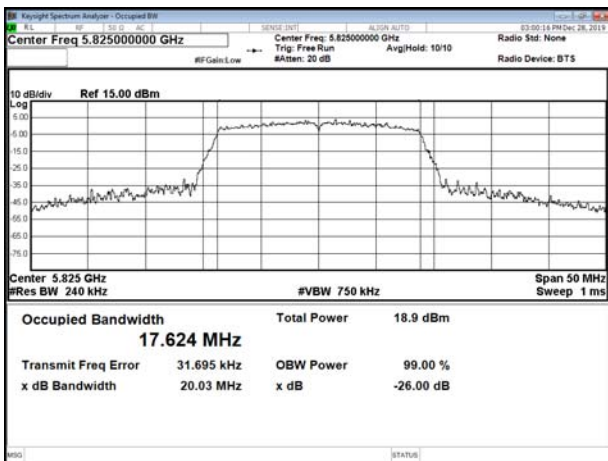



9. 26dB Bandwidth & 99% Bandwidth

9.1. Test Limit

None; for reporting purposes only.

9.2. Test Procedure

Reference to 789033 D02 General UNII Test Procedures New Rules v01: The transmitter output is connected to a spectrum analyzer with the RBW = approximately 1% of the emission bandwidth, the VBW $\geq 3 \times$ RBW, peak detector and max hold.

9.3. Test Setup Layout

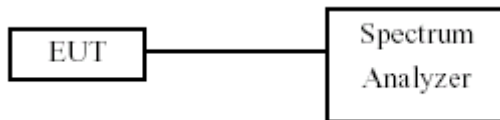

9.4. Test Result and Data

Temperature: 21°C

Humidity: 56%

Test Date: 2019-12-30

In the 5.2G Band

Modulation Type	Channel	Frequency (MHz)	26dB Bandwidth (MHz)		99% Occupied Bandwidth (MHz)	
			Chain 1	Chain 2	Chain 1	Chain 2
802.11a	36	5180	19.76	19.64	16.543	16.422
	44	5220	19.93	19.7	16.481	16.426
	48	5240	19.96	19.92	16.519	16.447
802.11n HT20	36	5180	20.3	20.28	17.607	17.601
	44	5220	20.44	20.16	17.663	17.639
	48	5240	20.34	20.21	17.656	17.57
802.11n HT40	38	5190	40.54	40.3	36.148	36.173
	46	5230	40.20	40.82	36.18	36.158

In the 5.3G Band

Modulation Type	Channel	Frequency (MHz)	26dB Bandwidth (MHz)		99% Occupied Bandwidth (MHz)	
			Chain 1	Chain 2	Chain 1	Chain 2
802.11a	52	5260	19.96	19.71	16.537	16.426
	60	5300	19.93	19.78	16.475	16.412
	64	5320	20	19.8	16.51	16.389
802.11n HT20	52	5260	20.12	20.33	17.626	17.628
	60	5300	20.15	20.27	17.613	17.574
	64	5320	20.23	20.19	17.6	17.605
802.11n HT40	54	5270	40.63	40.33	36.173	36.152
	62	5310	40.7	40.47	36.129	36.146



In the 5.5G Band

Modulation Type	Channel	Frequency (MHz)	26dB Bandwidth (MHz)		99% Occupied Bandwidth (MHz)	
			Chain 1	Chain 2	Chain 1	Chain 2
802.11a	100	5500	19.67	19.71	16.438	16.44
	116	5580	19.95	19.79	16.521	16.462
	140	5700	19.84	19.7	16.482	16.437
802.11n HT20	100	5500	20.45	20.29	17.636	17.596
	116	5580	20.25	20.19	17.67	17.62
	140	5700	20.27	20.17	17.626	17.599
802.11n HT40	102	5510	40.61	40.7	36.078	36.156
	110	5550	40.4	40.33	36.204	36.125
	134	5670	40.45	40.4	36.172	36.163



26dB Bandwidth & 99% Bandwidth
5.2G Band:
Chain 1
Modulation Standard: 802.11a
CH36

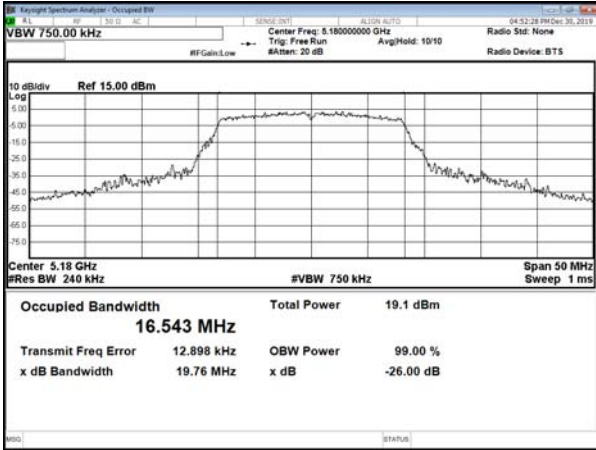

Modulation Standard: 802.11n HT20
CH36

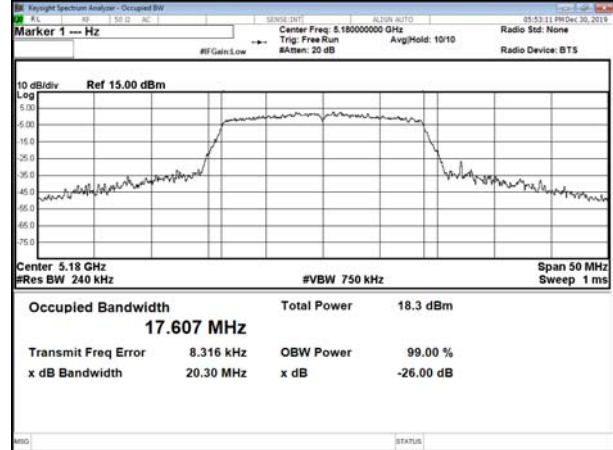

CH44

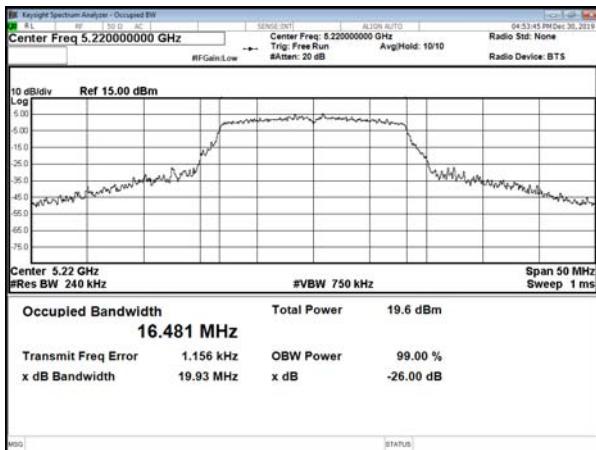

CH44

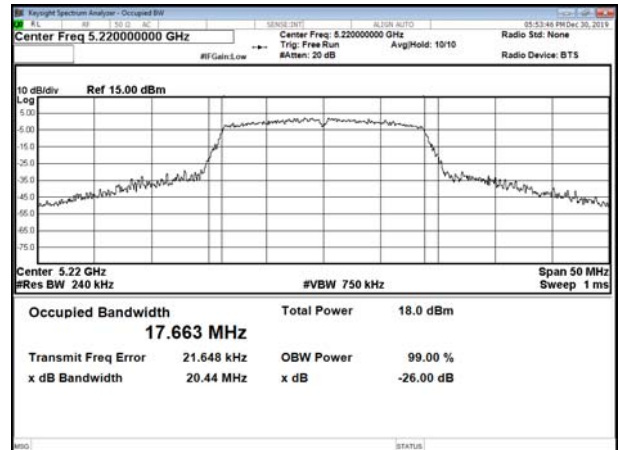

CH48

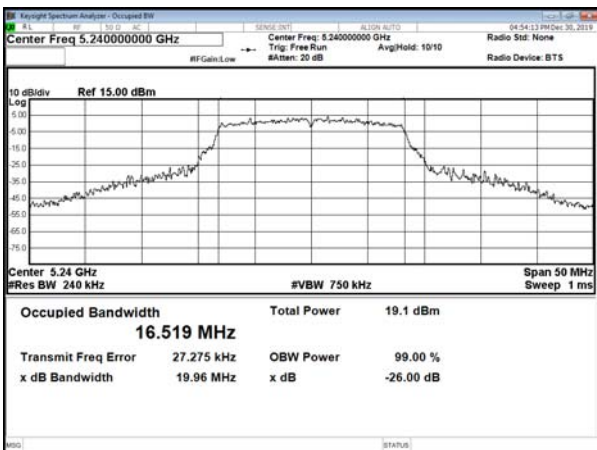

CH48

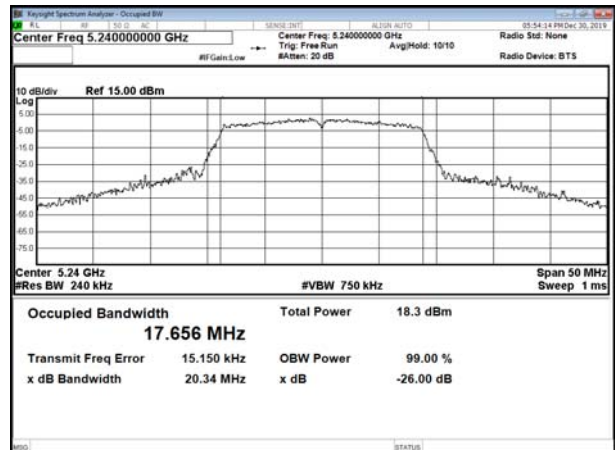



Modulation Standard: 802.11n HT40
CH38

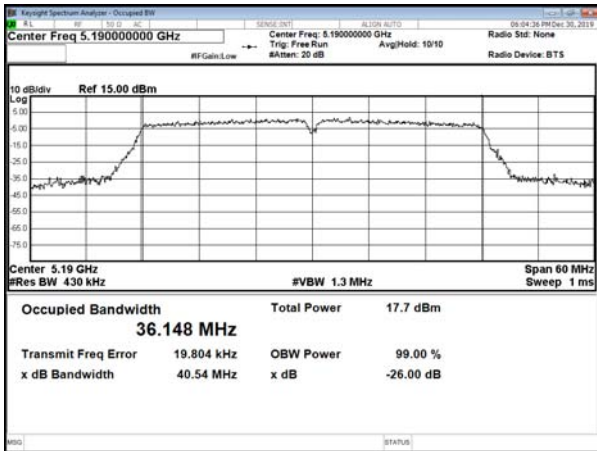

Chain 2
Modulation Standard: 802.11a
CH36

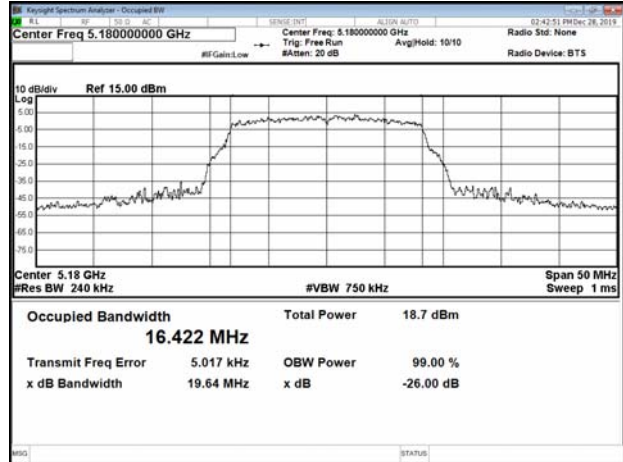

CH46

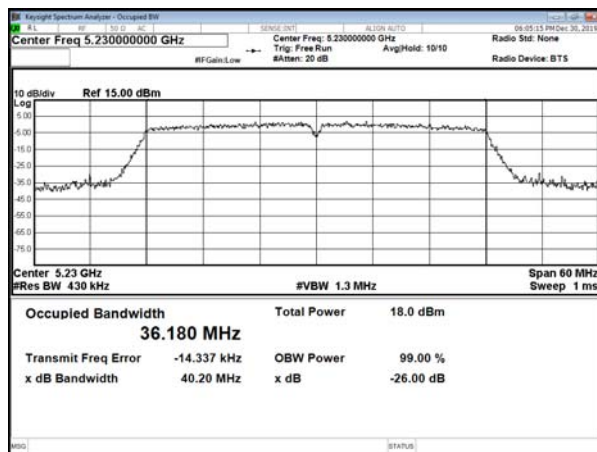

CH44

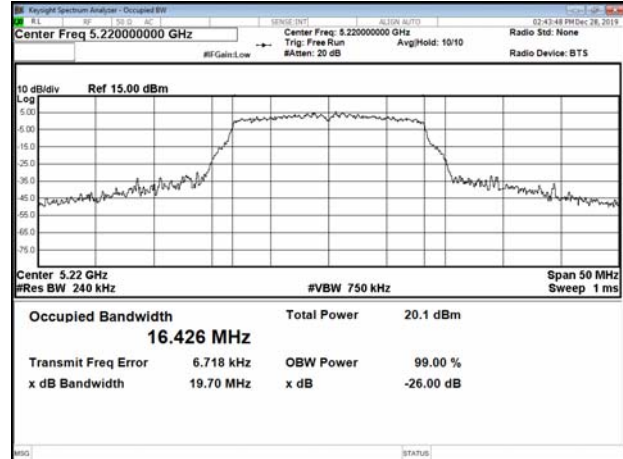

CH48





Modulation Standard: 802.11n HT20
CH36

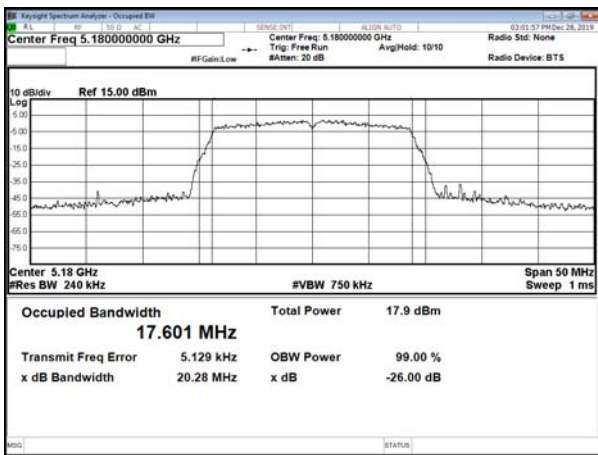

Modulation Standard: 802.11n HT40
CH38

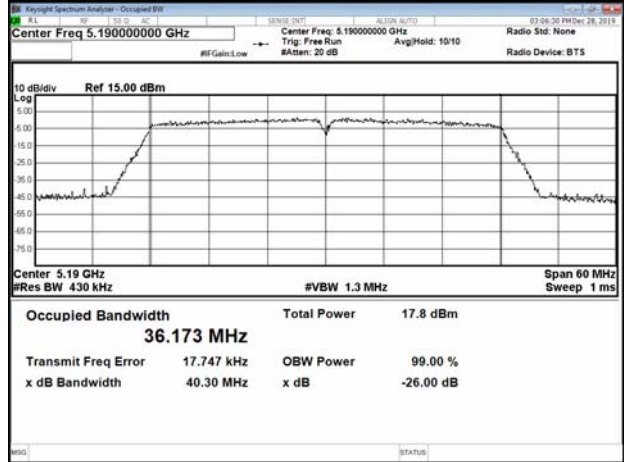

CH44

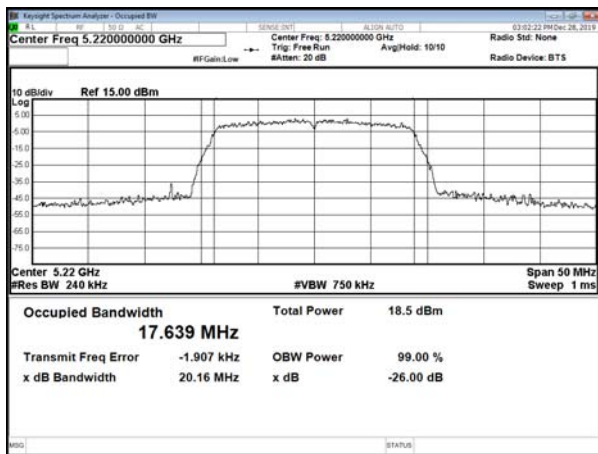

CH46

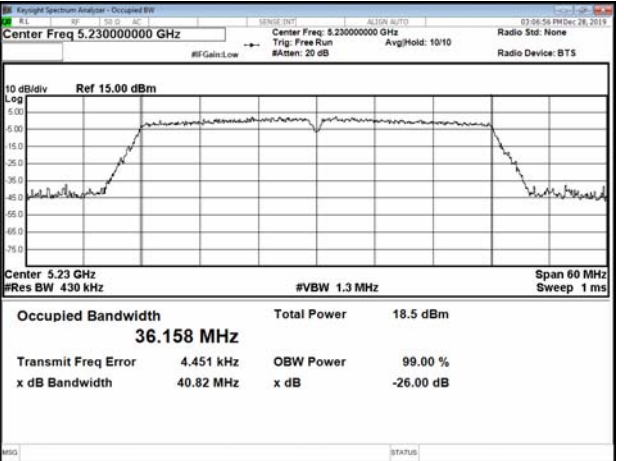

CH48





5.3G Band:
Chain 1
Modulation Standard: 802.11a
CH52

Modulation Standard: 802.11n HT20
CH52

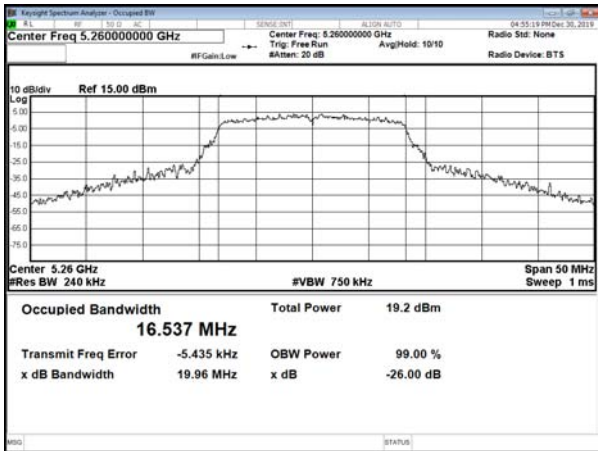

CH60

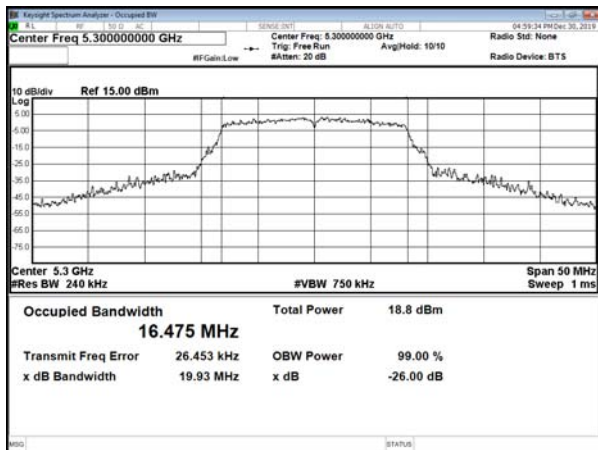

CH60

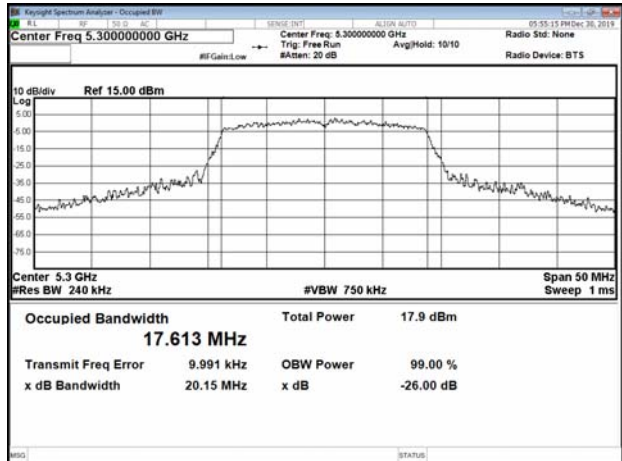

CH64

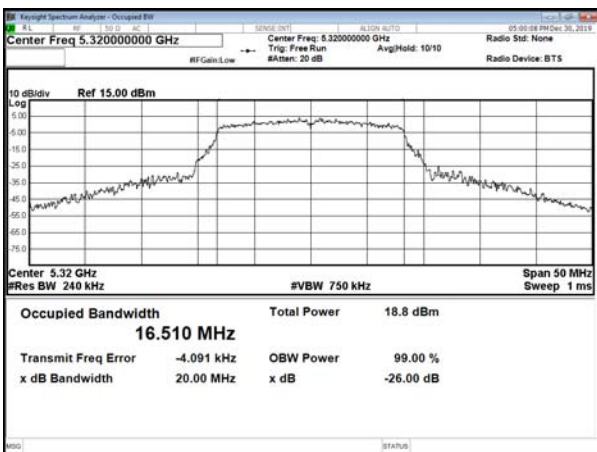

CH64

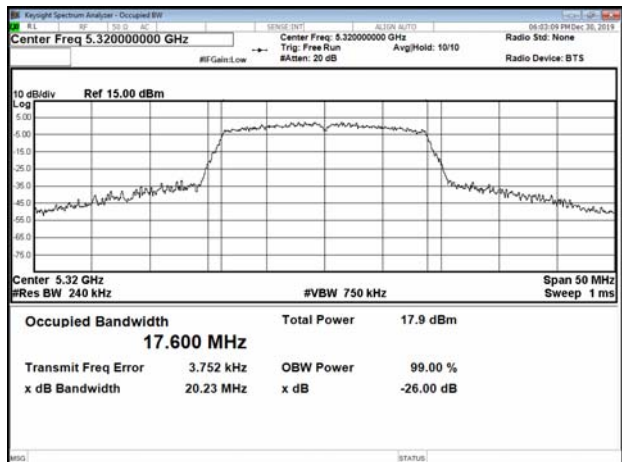



Modulation Standard: 802.11n HT40
CH54

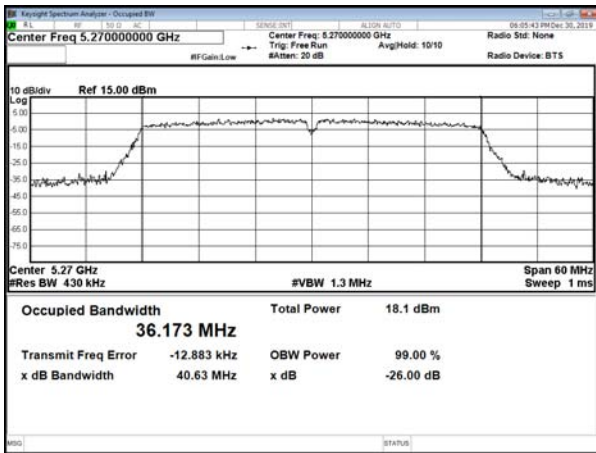

Chain 2
Modulation Standard: 802.11a
CH52

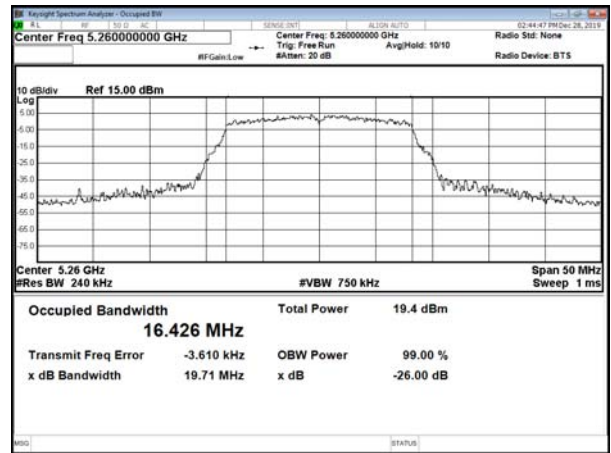

CH62

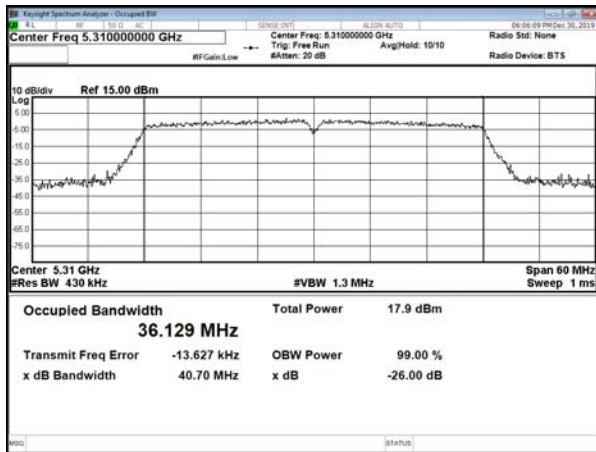

CH60

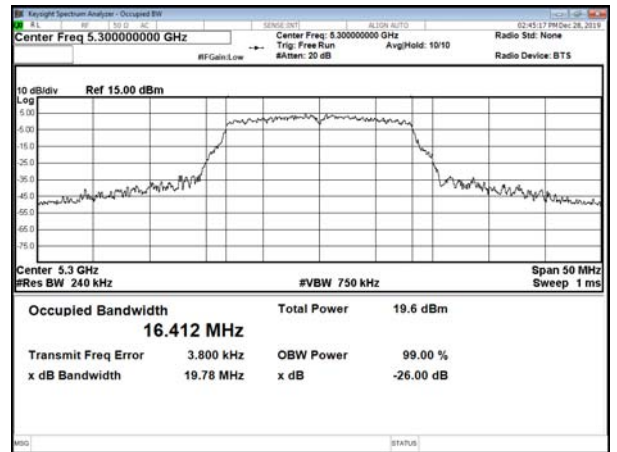

CH64

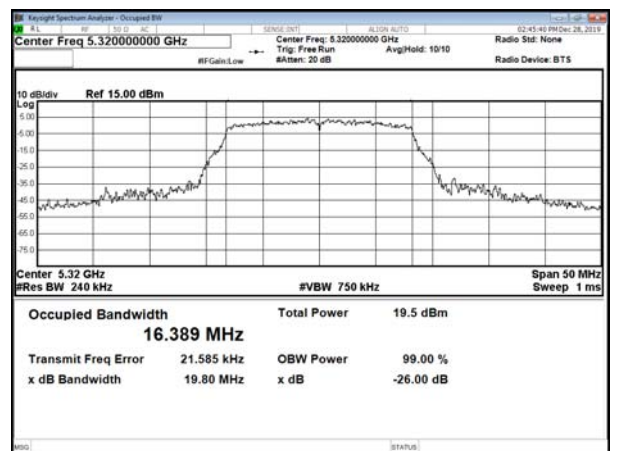



Modulation Standard: 802.11n HT20 CH52

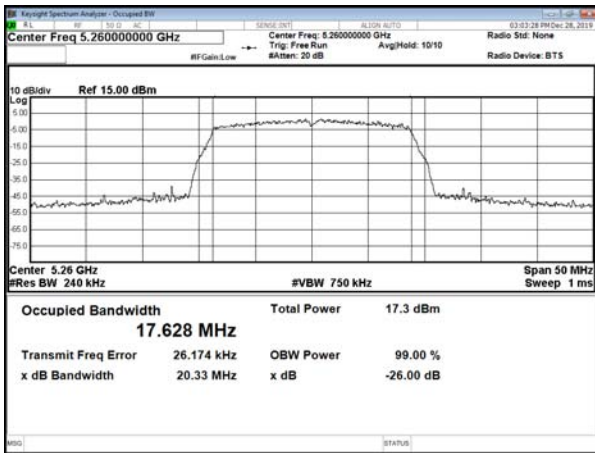

Modulation Standard: 802.11n HT40 CH54

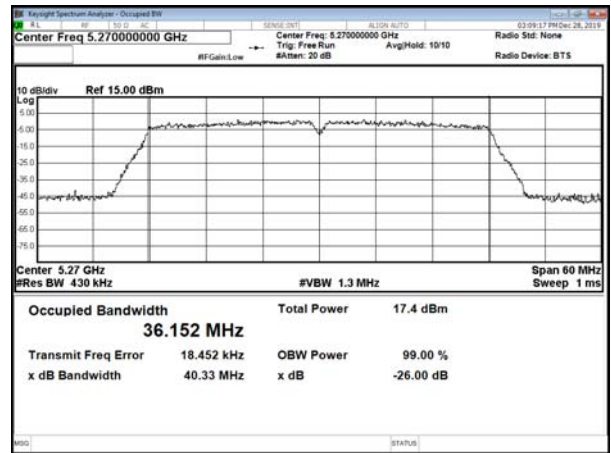

CH60

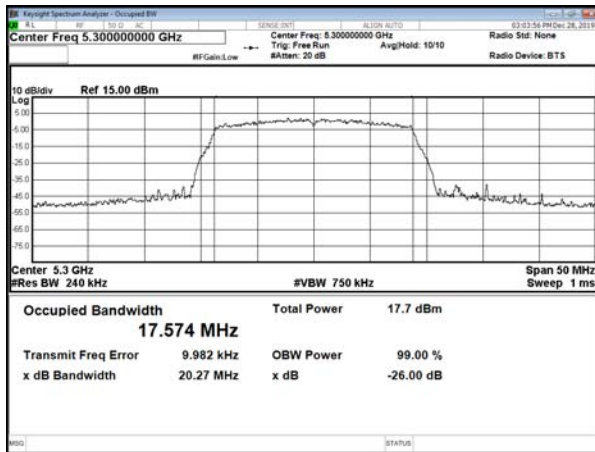

CH62

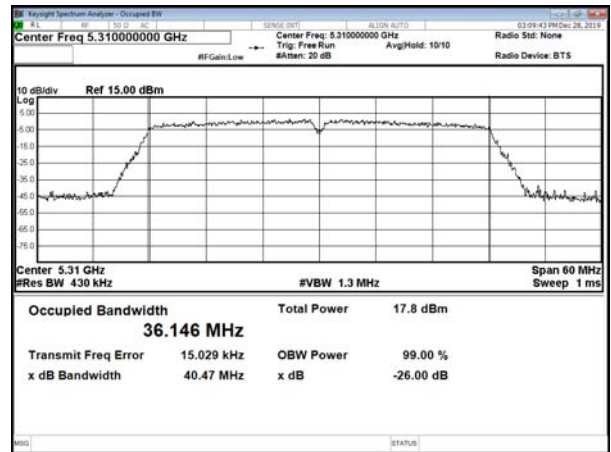

CH64

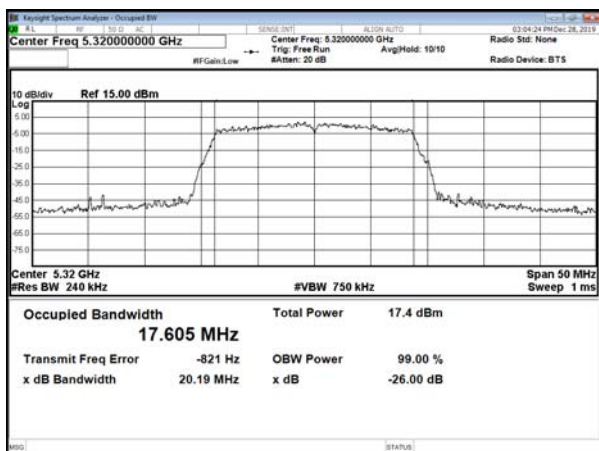



5.5G Band:
Chain 1
Modulation Standard: 802.11a
CH100

Modulation Standard: 802.11n HT20
CH100

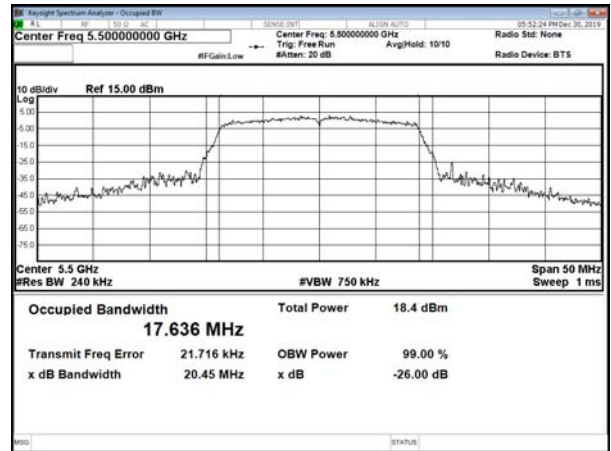
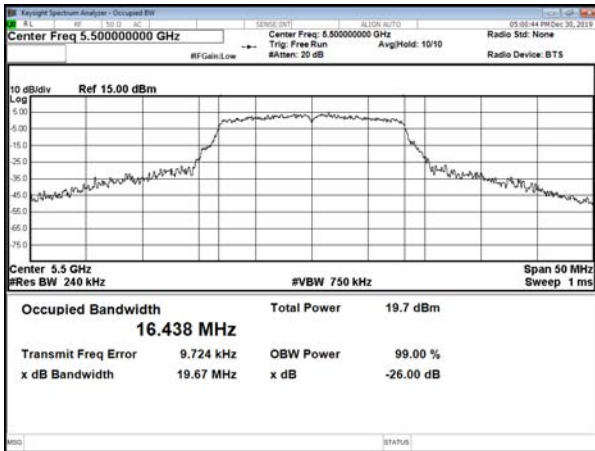

CH116

CH116

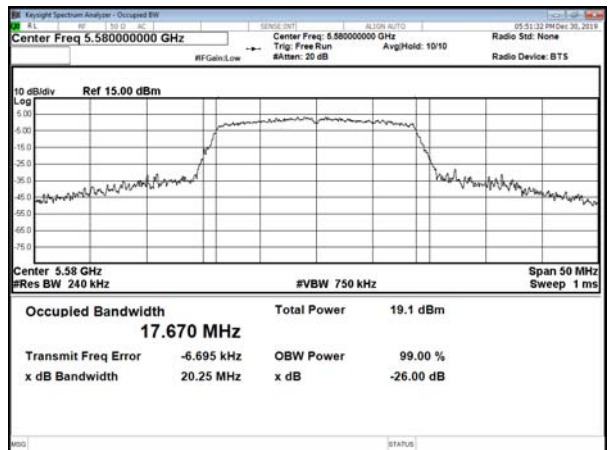
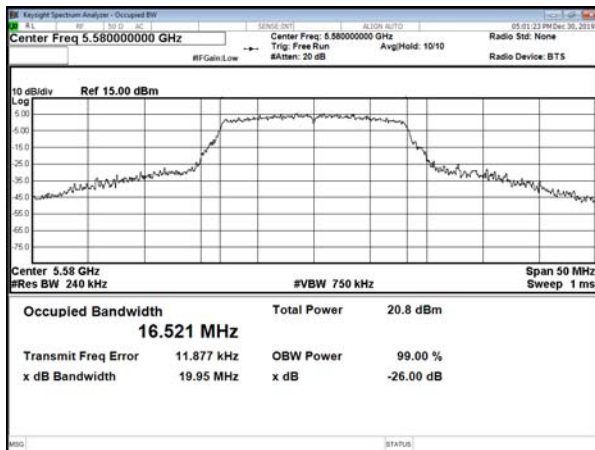

CH140

CH140

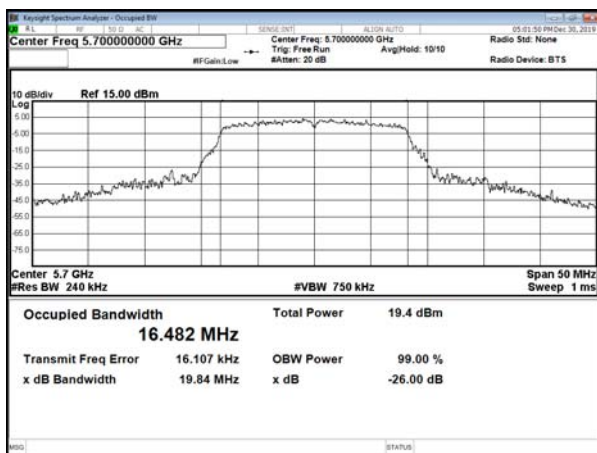



Modulation Standard: 802.11n HT40
CH102

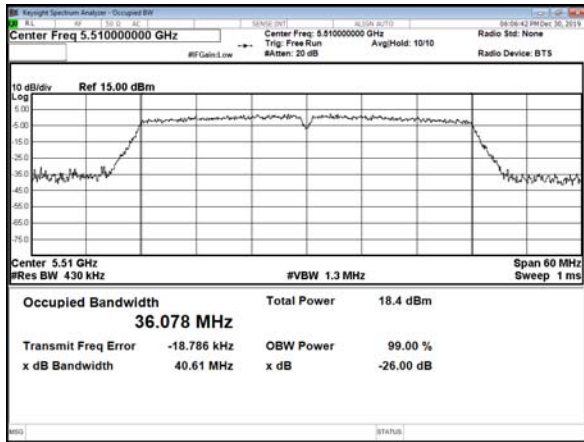

CH110

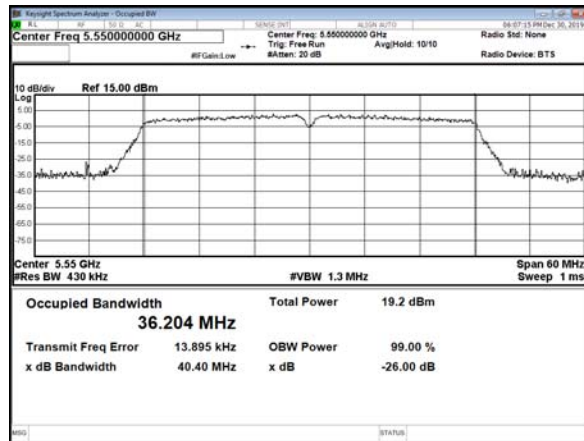

CH134

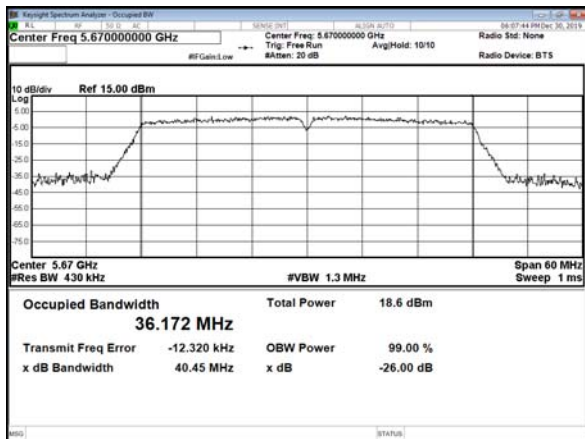



Chain 2
Modulation Standard: 802.11a
CH100

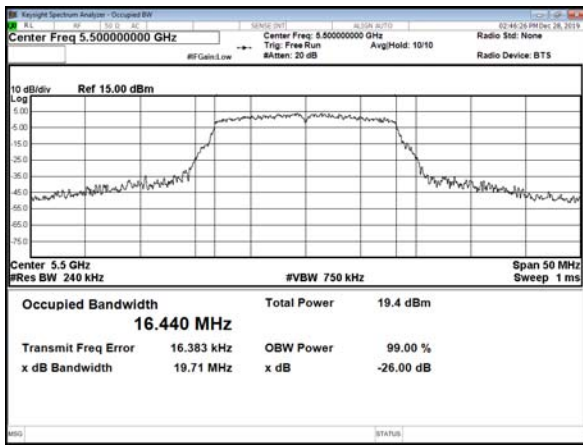

Modulation Standard: 802.11n HT20
CH100

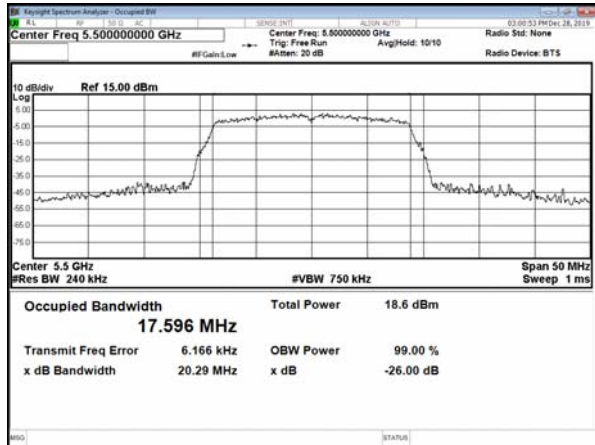

CH116

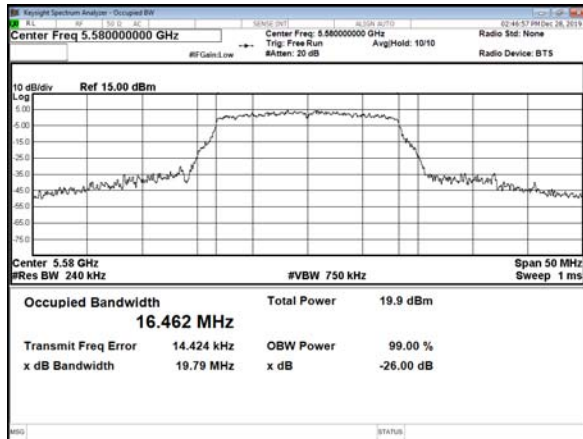

CH116



CH140

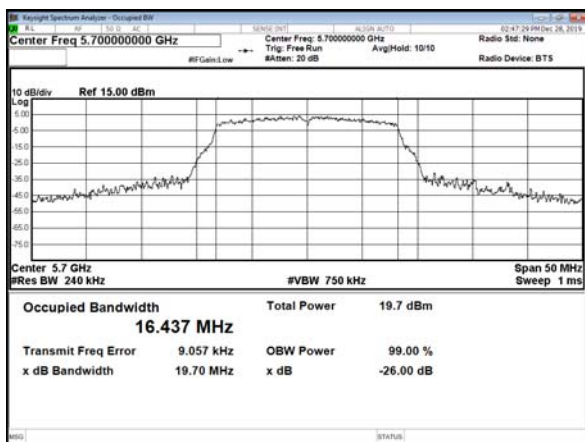

CH140

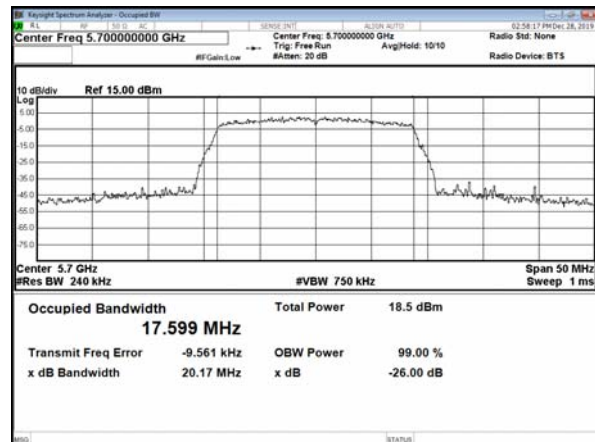



Modulation Standard: 802.11n HT40
CH102

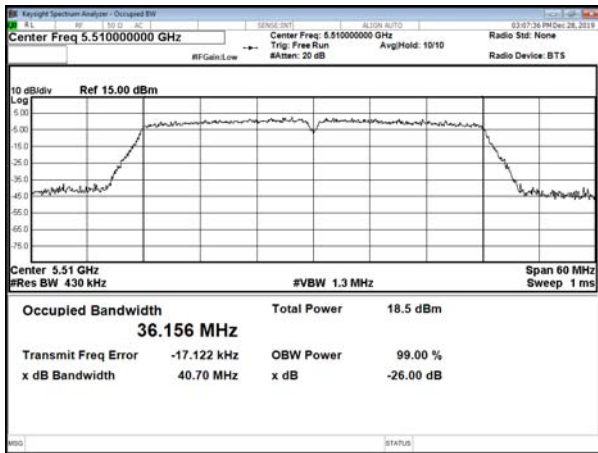

CH110

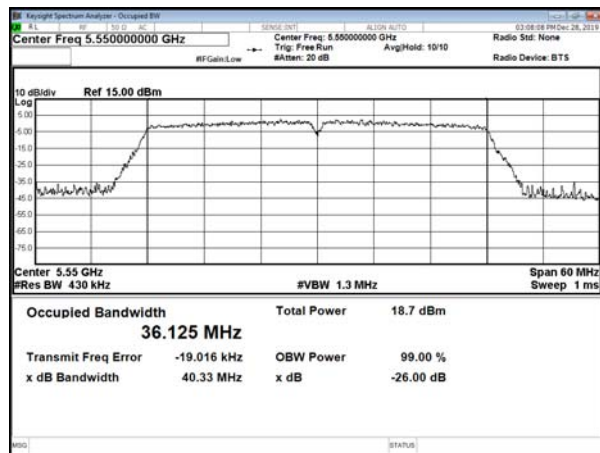

CH134

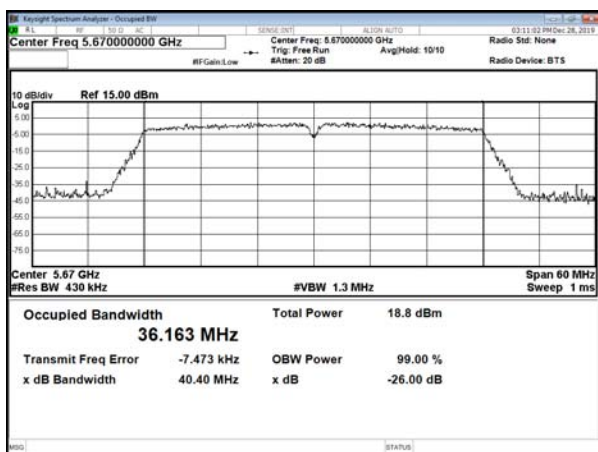



10. Average Power

10.1. Test Limit

Output Power:

Frequency Band	Limit	
<input checked="" type="checkbox"/> 5.15~5.25GHz		
	Operating Mode	
<input type="checkbox"/>	Outdoor access point	The maximum conducted output power over the frequency band of operation shall not exceed 1 W (30dBm) provided the maximum antenna gain does not exceed 6 dBi. If transmitting antennas of directional gain greater than 6 dBi are used, both the maximum conducted output power and the maximum power spectral density shall be reduced by the amount in dB that the directional gain of the antenna exceeds 6 dBi. The maximum e.i.r.p. at any elevation angle above 30degrees as measured from the horizon must not exceed 125 mW (21 dBm).
<input type="checkbox"/>	Indoor access point	The maximum conducted output power over the frequency band of operation shall not exceed 1 W (30dBm) provided the maximum antenna gain does not exceed 6 dBi. If transmitting antennas of directional gain greater than 6 dBi are used, both the maximum conducted output power and the maximum power spectral density shall be reduced by the amount in dB that the directional gain of the antenna exceeds 6 dBi.
<input type="checkbox"/>	Fixed point-to-point access points	The maximum conducted output power over the frequency band of operation shall not exceed 1 W (30dBm). Fixed point-to-point U-NII devices may employ antennas with directional gain up to 23 dBi without any corresponding reduction in the maximum conducted output power or maximum power spectral density. For fixed point-to-point transmitters that employ a directional antenna gain greater than 23 dBi, a 1 dB reduction in maximum conducted output power and maximum power spectral density is required for each 1 dB of antenna gain in excess of 23 dBi.
<input checked="" type="checkbox"/>	client devices	The maximum conducted output power over the frequency band of operation shall not exceed 250 mW (24dBm) provided the maximum antenna gain does not exceed 6 dBi. If transmitting antennas of directional gain greater than 6 dBi are used, both the maximum conducted output power and the maximum power spectral density shall be reduced by the amount in dB that the directional gain of the antenna exceeds 6 dBi.



Frequency Band		Limit
<input checked="" type="checkbox"/>	5.25-5.35 GHz	The maximum conducted output power over the frequency bands of operation shall not exceed the lesser of 250 mW (24dBm) or 11 dBm 10 log B, where B is the 26 dB emission bandwidth in megahertz. If transmitting antennas of directional gain greater than 6 dBi are used, both the maximum conducted output power and the maximum power spectral density shall be reduced by the amount in dB that the directional gain of the antenna exceeds 6 dBi.
<input checked="" type="checkbox"/>	5.470-5.725 GHz	
<input checked="" type="checkbox"/>	5.725~5.85 GHz	The maximum conducted output power over the frequency band of operation shall not exceed 1 W (30dBm). If transmitting antennas of directional gain greater than 6 dBi are used, both the maximum conducted output power and the maximum power spectral density shall be reduced by the amount in dB that the directional gain of the antenna exceeds 6 dBi. However, fixed point-to-point U-NII devices operating in this band may employ transmitting antennas with directional gain greater than 6 dBi without any corresponding reduction in transmitter conducted power.

10.2. Test Procedure

The transmitter output is connected to a power meter.

The cable assembly insertion loss of 11 dB (including 10 dB pad and 1 dB cable) was entered as an offset in the power meter to allow for direct reading of power.

10.3. Test Setup Layout

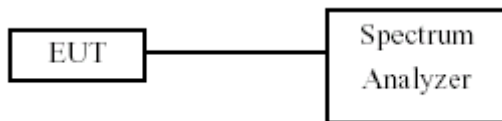

**10.4. Test Result and Data**

Temperature: 21°C

Humidity: 56%

Test Date: 2019-12-30

In the 5.2G Band

Modulation Type	Channel	Frequency (MHz)	Avg Power Output (dBm)		Total Power (dBm)	Total Power (mW)	Power Limit (dBm)
			Chain 1	Chain 2			
802.11a	36	5180	13.14	12.44	15.81	38.145	24.00
	44	5220	13.81	12.75	16.32	42.880	24.00
	48	5240	13.85	13.17	16.53	45.015	24.00
802.11n HT20	36	5180	12.01	11.45	14.75	29.849	24.00
	44	5220	12.95	11.98	15.50	35.500	24.00
	48	5240	12.62	12.2	15.43	34.877	24.00
802.11n HT40	38	5190	12.35	11.52	14.97	31.370	24.00
	46	5230	12.72	12.03	15.40	34.666	24.00

In the 5.3G Band

Modulation Type	Channel	Frequency (MHz)	Avg Power Output (dBm)		Total Power (dBm)	Total Power (mW)	Power Limit (dBm)
			Chain 1	Chain 2			
802.11a	52	5260	13.92	12.62	16.33	42.941	24.00
	60	5300	13.51	12.62	16.10	40.720	24.00
	64	5320	13.51	12.91	16.23	41.982	24.00
802.11n HT20	52	5260	13.06	11.31	15.28	33.751	24.00
	60	5300	12.3	11.39	14.88	30.755	24.00
	64	5320	12.27	11.43	14.88	30.765	24.00
802.11n HT40	54	5270	13.1	11.33	15.31	34.001	24.00
	62	5310	12.7	11.58	15.19	33.009	24.00

In the 5.5G Band

Modulation Type	Channel	Frequency (MHz)	Avg Power Output (dBm)		Total Power (dBm)	Total Power (mW)	Power Limit (dBm)
			Chain 1	Chain 2			
802.11a	100	5500	14.17	13.82	17.01	50.221	24.00
	116	5580	14.81	13.62	17.27	53.284	24.00
	140	5700	14.21	13.46	16.86	48.545	24.00
802.11n HT20	100	5500	13.01	12.32	15.69	37.059	24.00
	116	5580	13.73	12.36	16.11	40.823	24.00
	140	5700	12.94	11.85	15.44	34.990	24.00
802.11n HT40	102	5510	13.13	12.32	15.75	37.620	24.00
	110	5550	13.71	12.41	16.12	40.914	24.00
	134	5670	13.22	12.63	15.95	39.313	24.00



In the 5.8G Band

Modulation Type	Channel	Frequency (MHz)	Avg Power Output (dBm)		Total Power (dBm)	Total Power (mW)	Power Limit (dBm)
			Chain 1	Chain 2			
802.11a	149	5745	14.09	13.63	16.88	48.752	30.00
	157	5785	14.11	13.50	16.83	48.150	30.00
	165	5825	13.65	13.49	16.58	45.510	30.00
802.11n HT20	149	5745	13.26	12.62	15.96	39.465	30.00
	157	5785	13.03	12.56	15.81	38.121	30.00
	165	5825	12.21	12.74	15.49	35.427	30.00
802.11n HT40	151	5755	13.01	12.57	15.81	38.070	30.00
	159	5795	13.49	12.53	16.05	40.242	30.00



11. PPSD

11.1.Test Limit

PSD:

Frequency Band		Limit
<input checked="" type="checkbox"/>	5.15~5.25GHz	
	Operating Mode	
<input type="checkbox"/>	Outdoor access point	17 dBm/MHz
<input type="checkbox"/>	Indoor access point	17 dBm/MHz
<input type="checkbox"/>	Fixed point-to-point access points	17 dBm/MHz
<input checked="" type="checkbox"/>	Mobile and portable client devices	11 dBm/MHz
<input checked="" type="checkbox"/>	5.725~5.85 GHz	11 dBm/MHz
<input checked="" type="checkbox"/>	5.470-5.725 GHz	11 dBm/MHz
<input checked="" type="checkbox"/>	5.725~5.85 GHz	30 dBm/500kHz

11.2.Test Procedure

Reference to KDB789033 D02 General UNII Test Procedures New Rules v02r01

11.3.Test Setup Layout

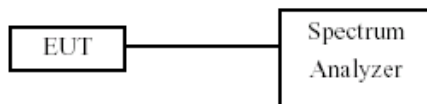

**11.4. Test Result and Data**

Temperature: 21°C

Humidity: 56%

Test Date: 2019-12-30

In the 5.2G Band

Modulation Type	CH	Freq. (MHz)	Meas PPSD (dBm/MHz)		Sum chain (dBm)	Duty Cycle CF(dB)	Total Corr'd PPSD (dBm/MHz)	PPSD Limit (dBm/MHz)
			Chain 1	Chain 2				
802.11a	36	5180	2.885	2.631	5.77	0.00	5.77	11.00
	44	5220	3.420	2.792	6.13	0.00	6.13	11.00
	48	5240	3.467	2.979	6.24	0.00	6.24	11.00
802.11n HT20	36	5180	1.764	1.057	4.44	0.00	4.44	11.00
	44	5220	1.637	1.748	4.70	0.00	4.70	11.00
	48	5240	1.850	1.912	4.89	0.00	4.89	11.00
802.11n HT40	38	5190	-1.735	-2.421	0.95	0.00	0.95	11.00
	46	5230	-0.499	-1.288	2.13	0.00	2.13	11.00

In the 5.3G Band

Modulation Type	CH	Freq. (MHz)	Meas PPSD (dBm/MHz)		Sum chain (dBm)	Duty Cycle CF(dB)	Total Corr'd PPSD (dBm/MHz)	PPSD Limit (dBm/MHz)
			Chain 1	Chain 2				
802.11a	52	5260	3.479	2.204	5.90	0.00	5.90	11.00
	60	5300	3.167	2.500	5.86	0.00	5.86	11.00
	64	5320	3.324	2.304	5.85	0.00	5.85	11.00
802.11n HT20	52	5260	2.048	1.639	4.86	0.00	4.86	11.00
	60	5300	1.886	1.215	4.57	0.00	4.57	11.00
	64	5320	1.633	0.902	4.29	0.00	4.29	11.00
802.11n HT40	54	5270	-0.685	-2.204	1.63	0.00	1.63	11.00
	62	5310	-1.164	-1.956	1.47	0.00	1.47	11.00

**In the 5.5G Band**

Modulation Type	CH	Freq. (MHz)	Meas PPSD (dBm/MHz)		Sum chain (dBm)	Duty Cycle CF(dB)	Total Corr'd PPSD (dBm/MHz)	PPSD Limit (dBm/MHz)
			Chain 1	Chain 2				
802.11a	100	5500	3.872	3.268	6.59	0.00	6.59	11.00
	116	5580	4.725	2.686	6.83	0.00	6.83	11.00
	140	5700	3.511	2.903	6.23	0.00	6.23	11.00
802.11n HT20	100	5500	2.180	1.915	5.06	0.00	5.06	11.00
	116	5580	3.272	1.844	5.63	0.00	5.63	11.00
	140	5700	2.336	1.981	5.17	0.00	5.17	11.00
802.11n HT40	102	5510	-0.815	-1.743	1.76	0.00	1.76	11.00
	110	5550	-0.196	-1.419	2.25	0.00	2.25	11.00
	134	5670	-0.371	-1.138	2.27	0.00	2.27	11.00

In the 5.8G Band

Modulation Type	CH	Freq. (MHz)	Meas PPSD (dBm/MHz)		Sum chain (dBm)	Duty Cycle CF(dB)	10log(500K Hz/RBW) CF (dB)	Total Corr'd PPSD (dBm/500kHz)	PPSD Limit (dBm/500kHz)
			Chain 1	Chain 2					
802.11a	149	5745	3.557	3.18	6.38	0.00	6.38	3.557	30.00
	157	5785	3.489	3.351	6.43	0.00	6.43	3.489	30.00
	165	5825	3.169	3.326	6.26	0.00	6.26	3.169	30.00
802.11n HT20	149	5745	2.330	2.047	5.20	0.00	5.20	2.33	30.00
	157	5785	3.121	2.118	5.66	0.00	5.66	3.121	30.00
	165	5825	1.646	2.463	5.08	0.00	5.08	1.646	30.00
802.11n HT40	155	5755	-0.481	-1.396	2.10	0.00	2.10	-0.481	30.00
	159	5795	-0.380	-1.236	2.22	0.00	2.22	-0.380	30.00



5.2G Band:
Chain 1
Modulation Standard: 802.11a
CH36

Modulation Standard: 802.11n HT20
CH36

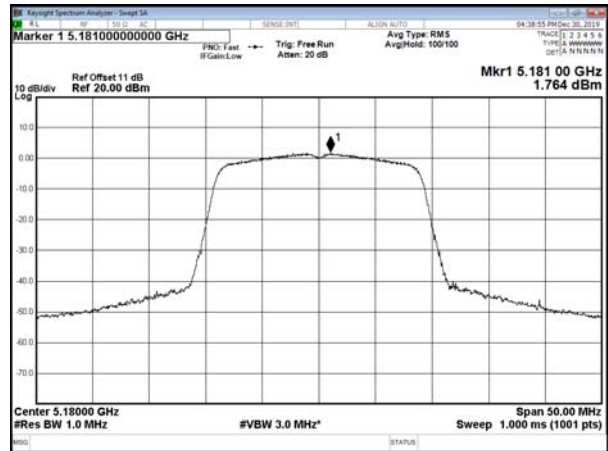
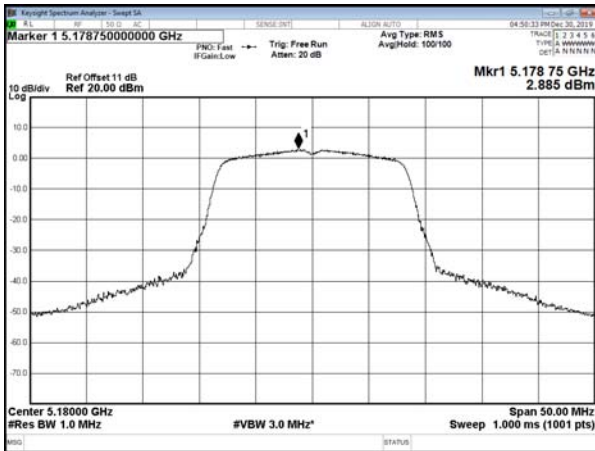

CH44

CH44

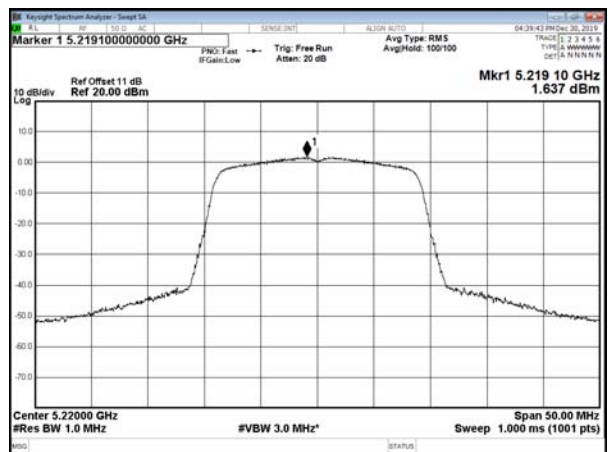
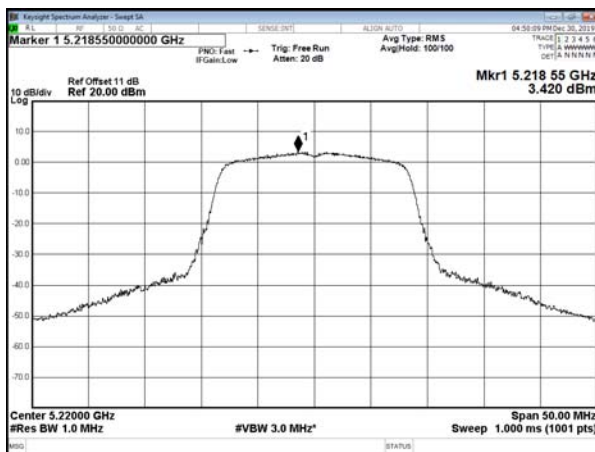

CH48

CH48

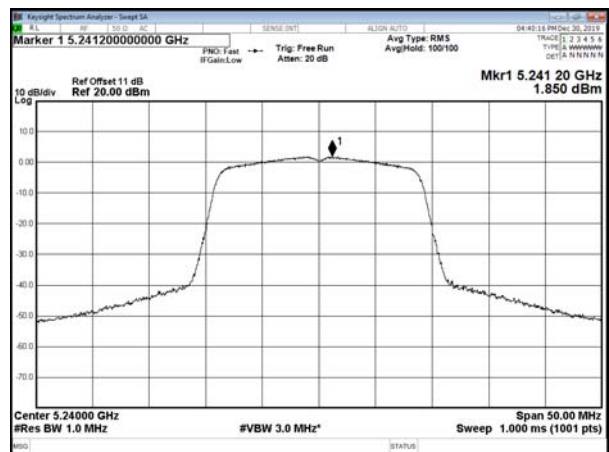
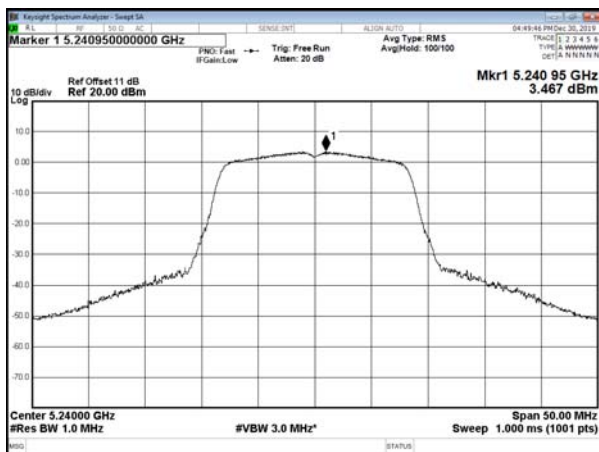



Modulation Standard: 802.11n HT40
CH38

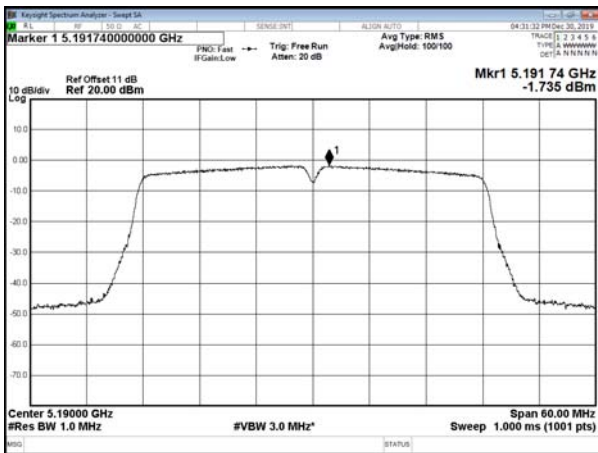

Chain 2
Modulation Standard: 802.11a
CH36

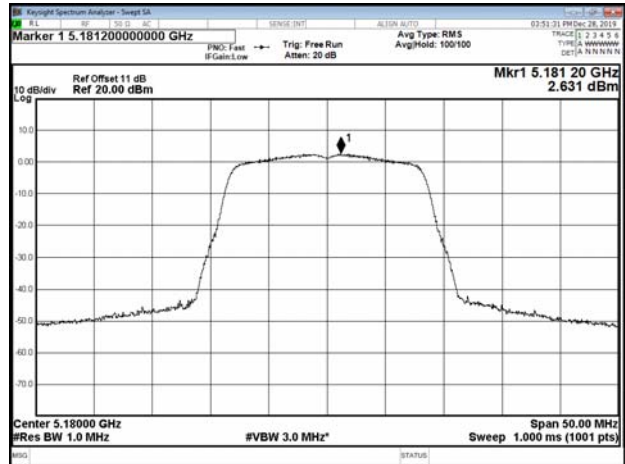

CH46

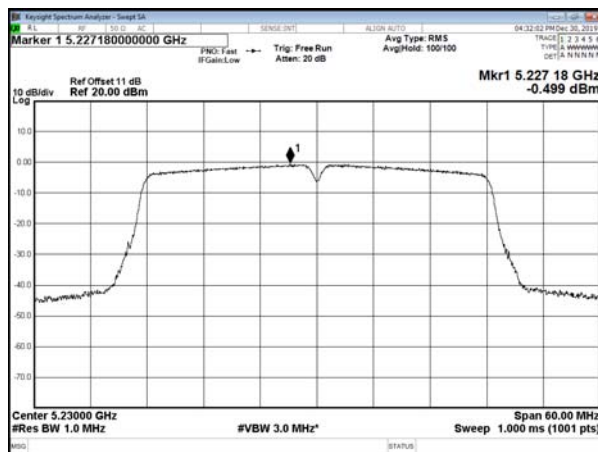

CH44

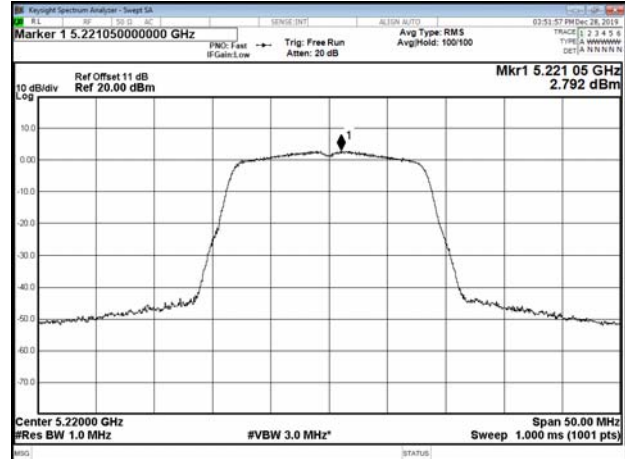

CH48

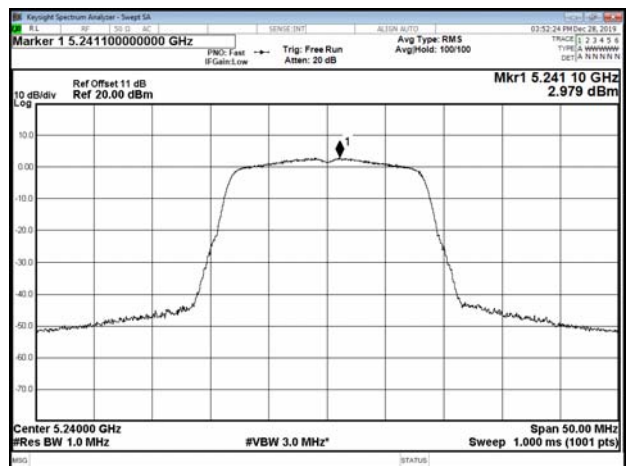



Modulation Standard: 802.11n HT20
CH36

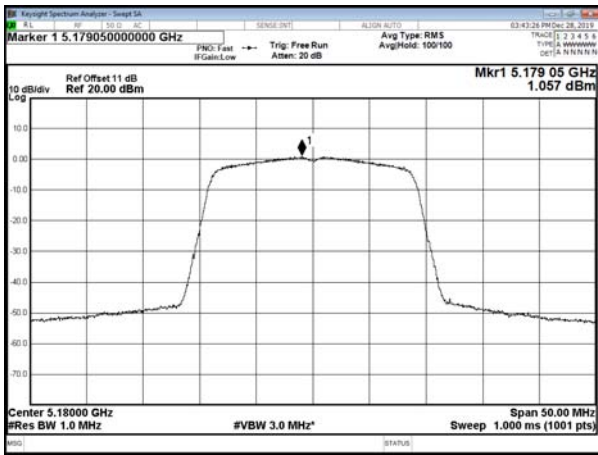

Modulation Standard: 802.11n HT40
CH38

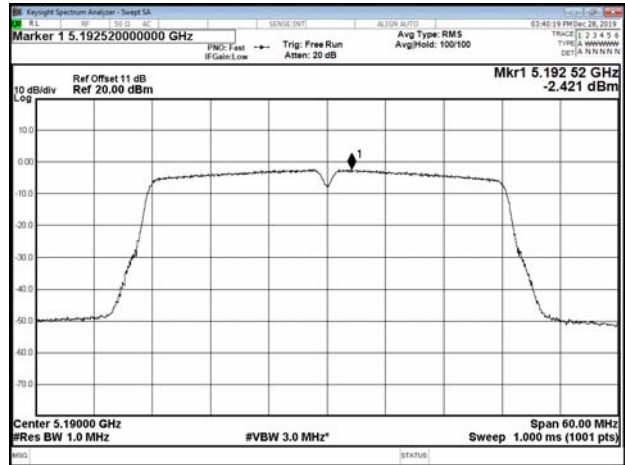

CH44

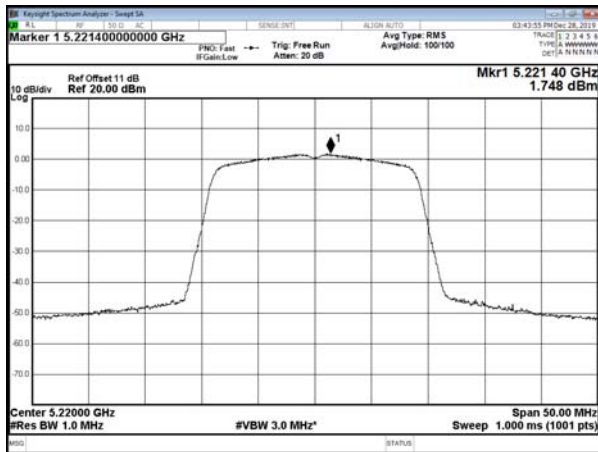

CH46

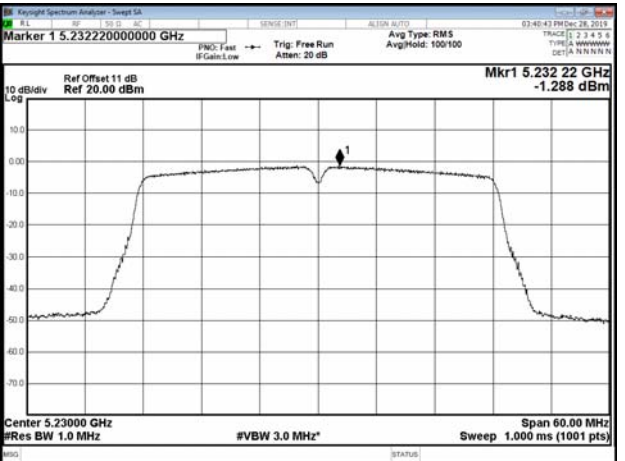

CH48

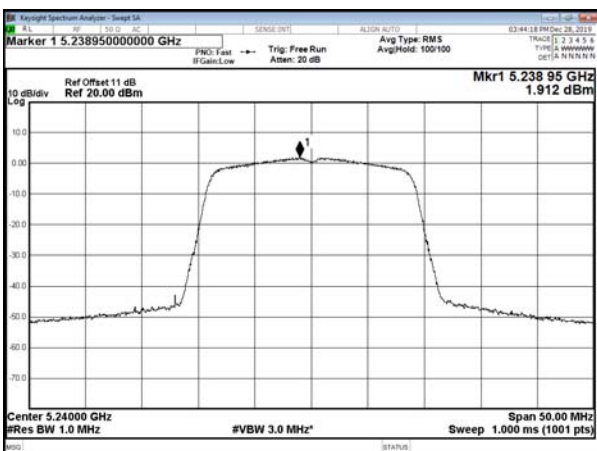



5.3G Band:
Chain 1
Modulation Standard: 802.11a
CH52

Modulation Standard: 802.11n HT20
CH52

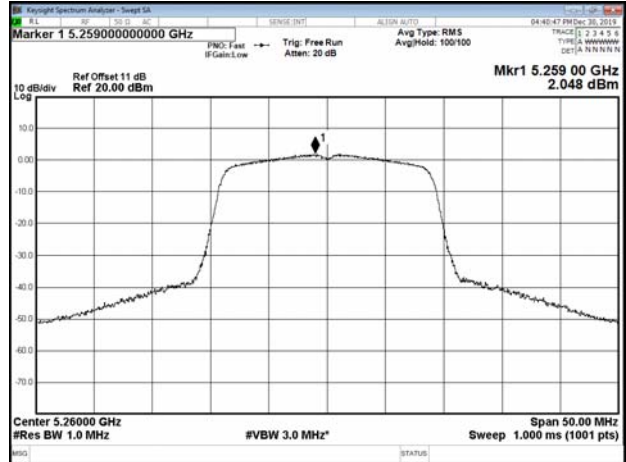
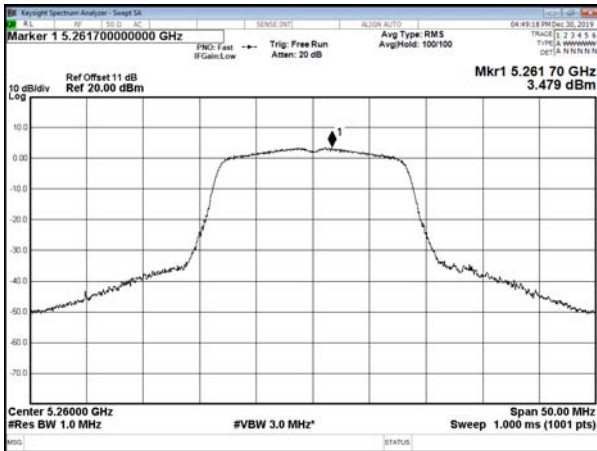

CH60

CH60

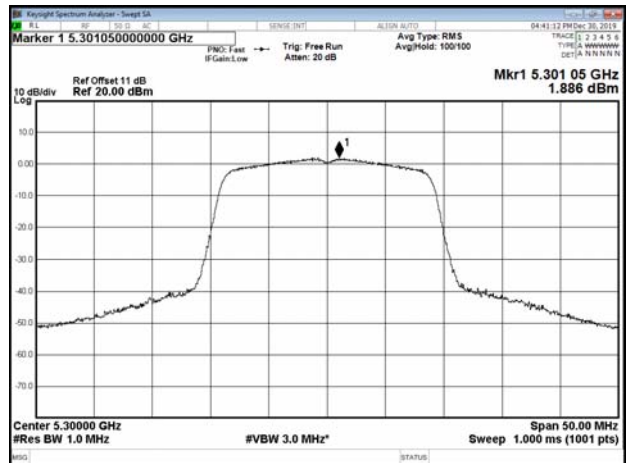
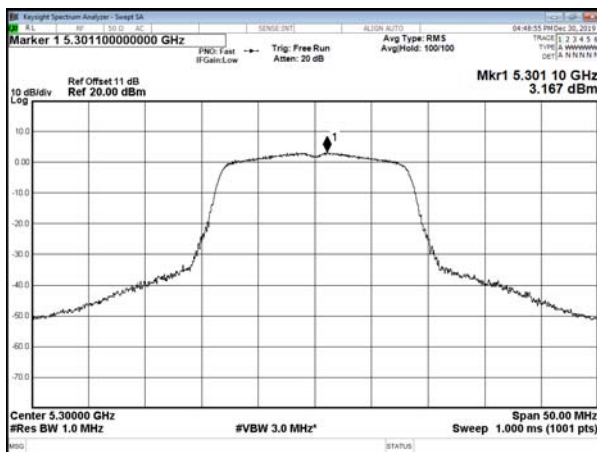

CH64

CH64

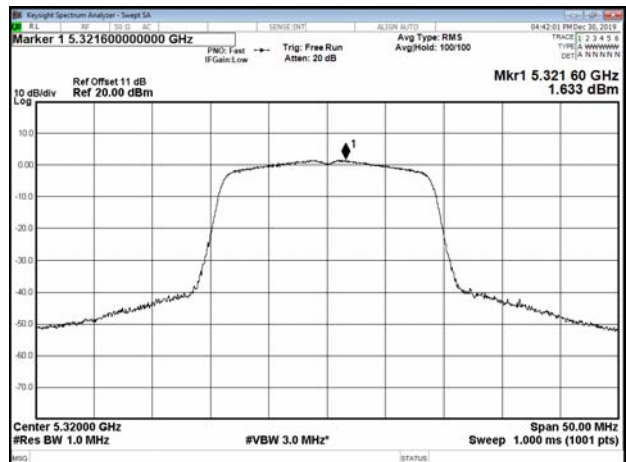
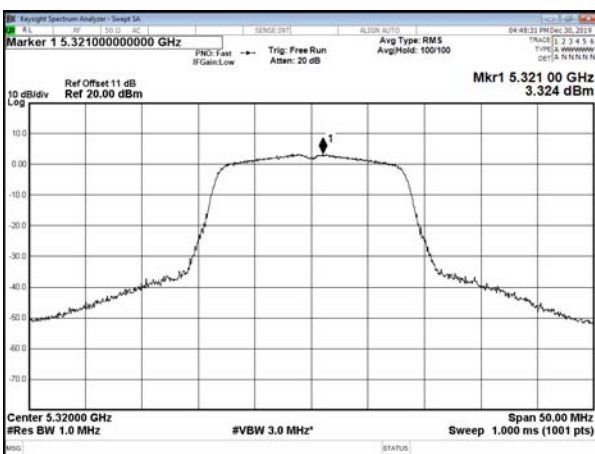



Modulation Standard: 802.11n HT40
CH54

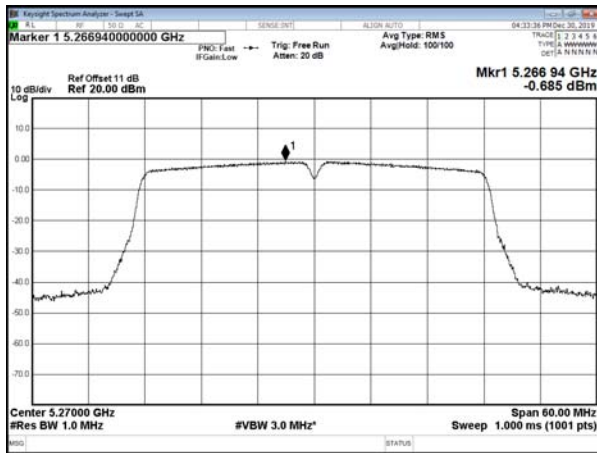

Chain 2
Modulation Standard: 802.11a
CH52

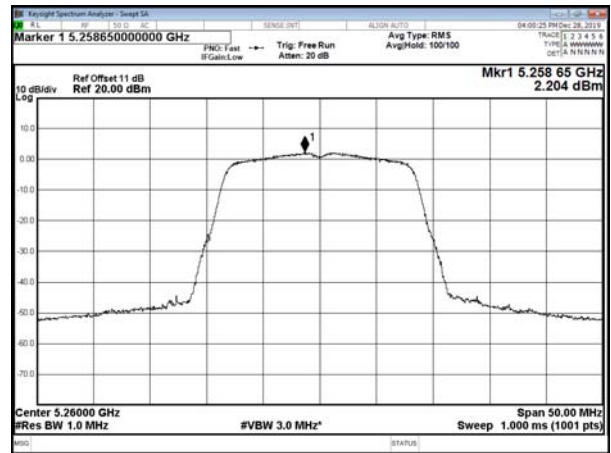

CH62

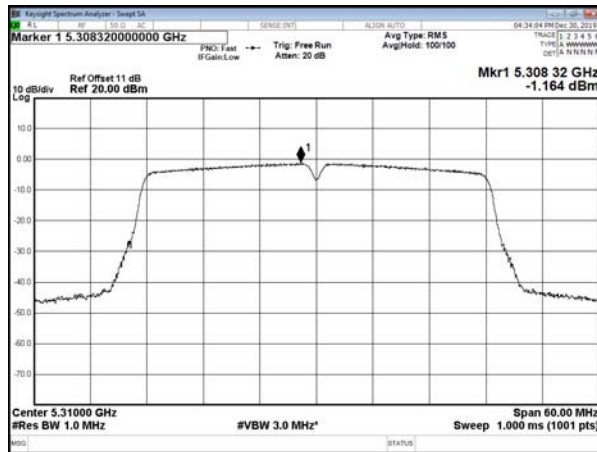

CH60

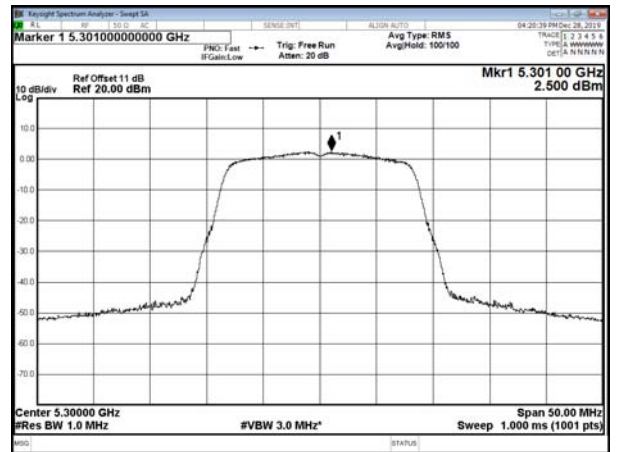

CH64

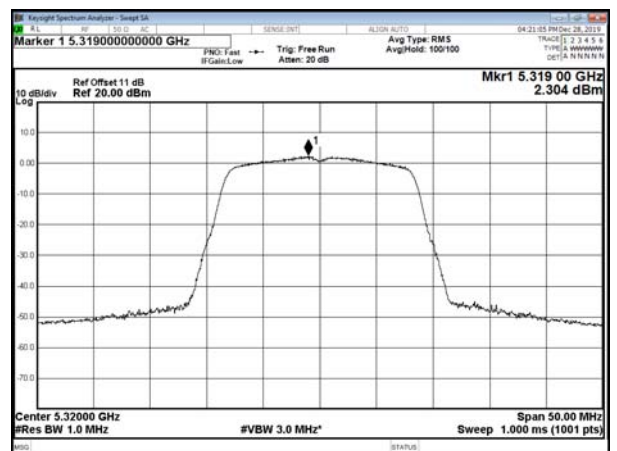



Modulation Standard: 802.11n HT20
CH52

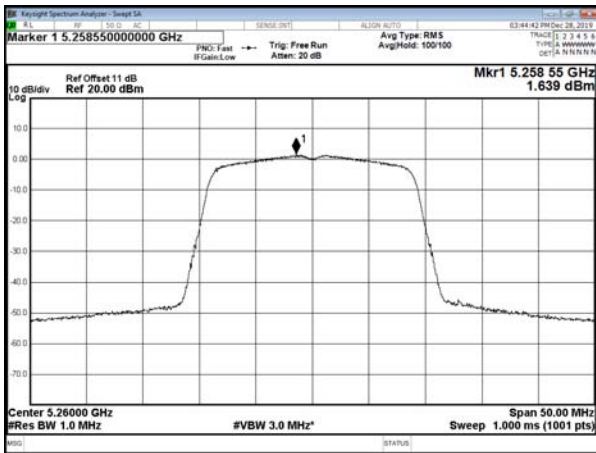

Modulation Standard: 802.11n HT40
CH54

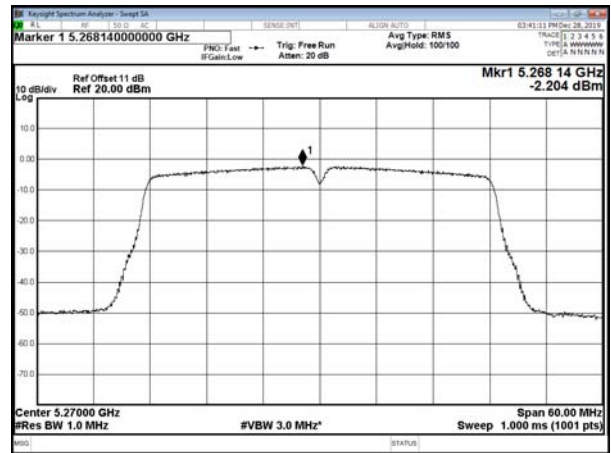

CH60

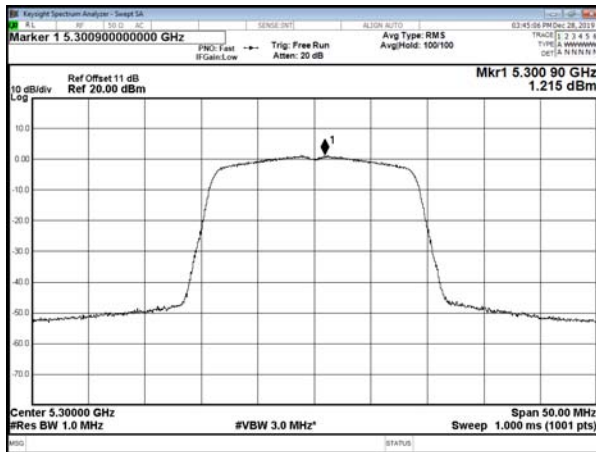

CH62

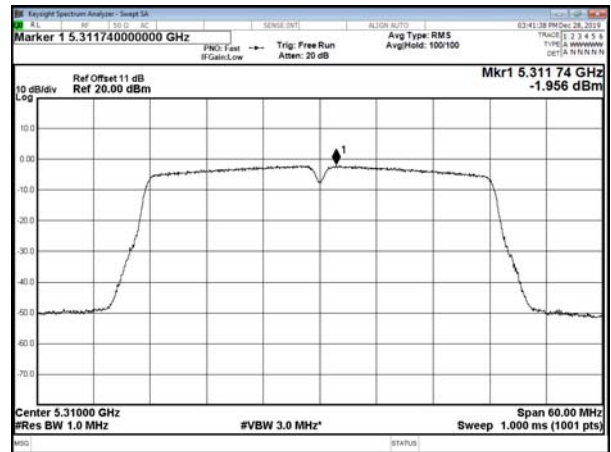

CH64

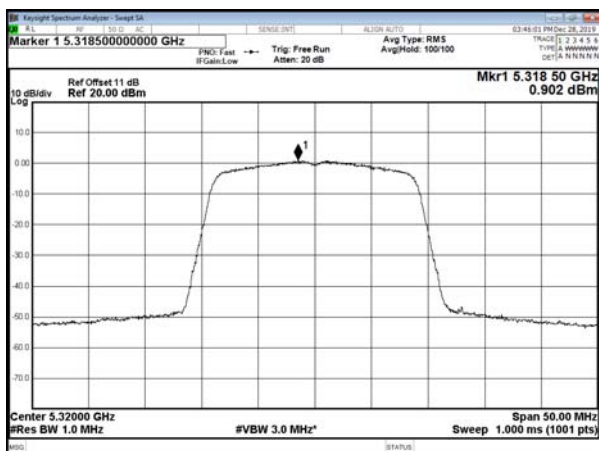



5.5G Band:
Chain 1
Modulation Standard: 802.11a
CH100

Modulation Standard: 802.11n HT20
CH100

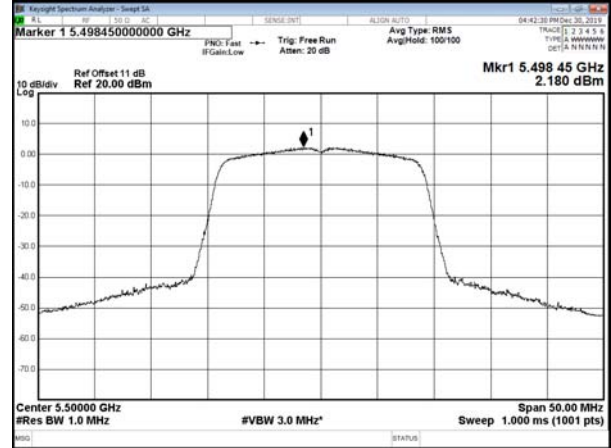
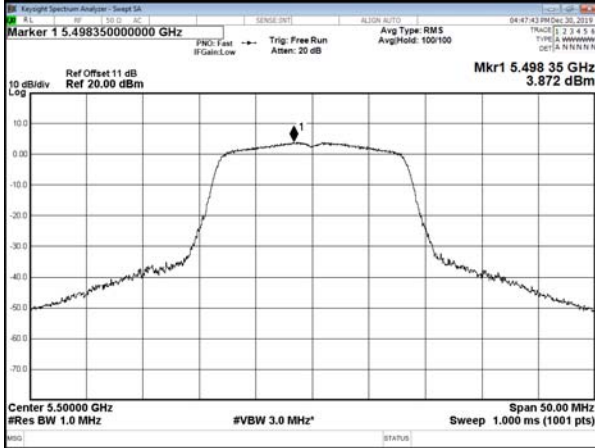

CH116

CH116

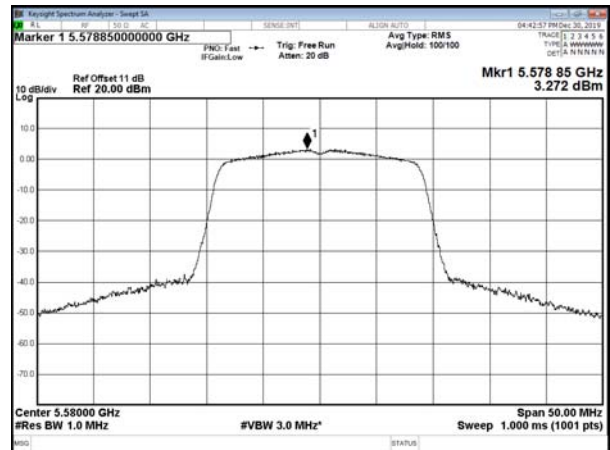
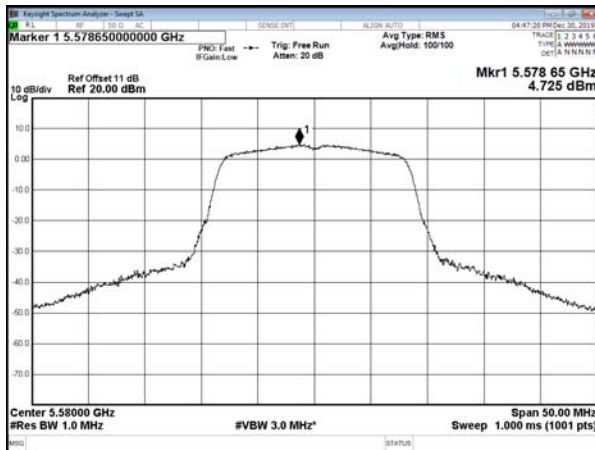

CH140

CH140

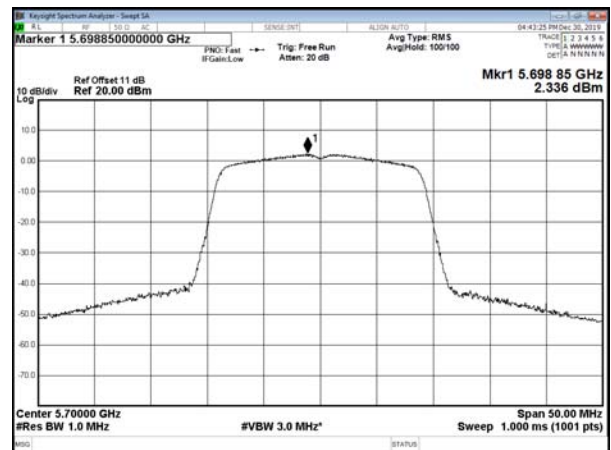
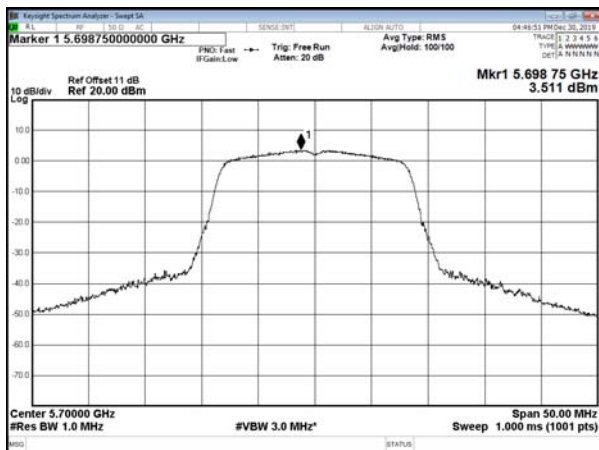



Modulation Standard: 802.11n HT40
CH102

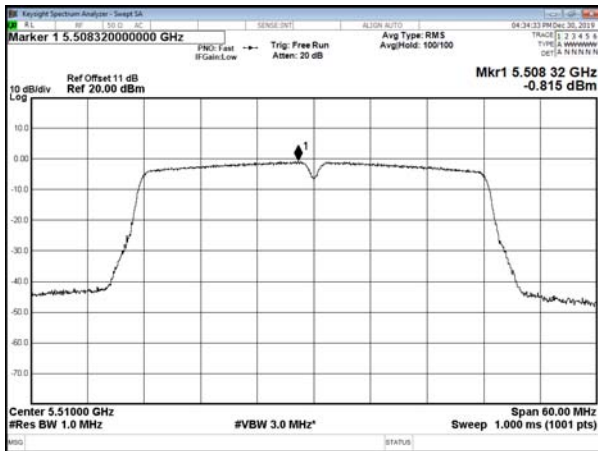

CH110

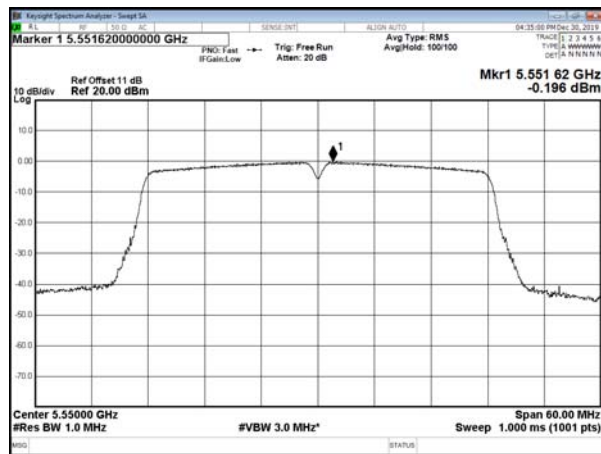

CH134

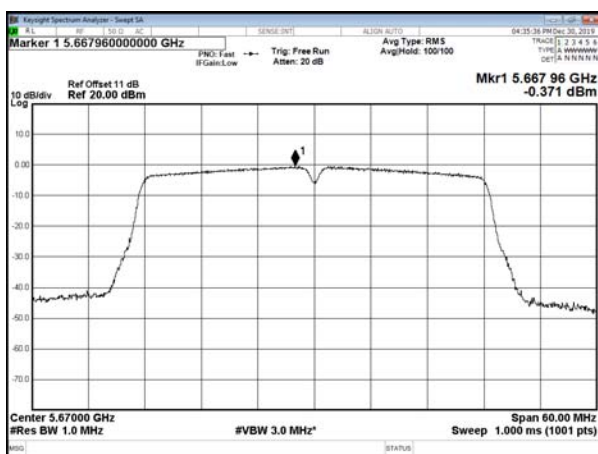



Chain 2
Modulation Standard: 802.11a
CH100

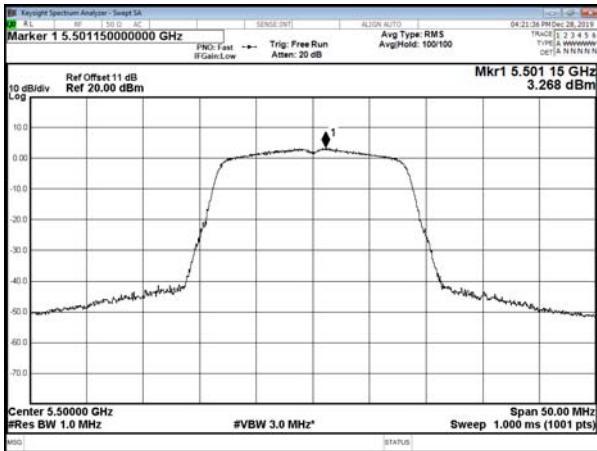

Modulation Standard: 802.11n HT20
CH100

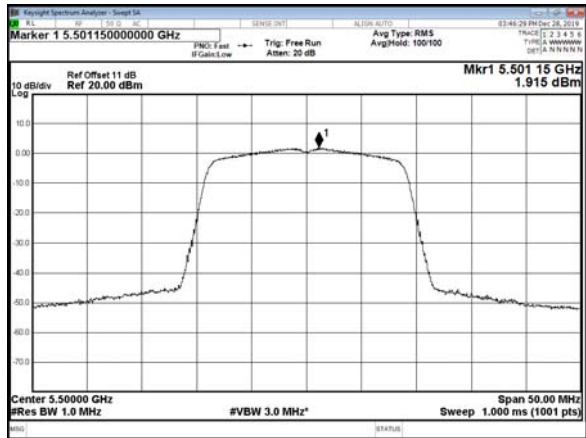

CH116

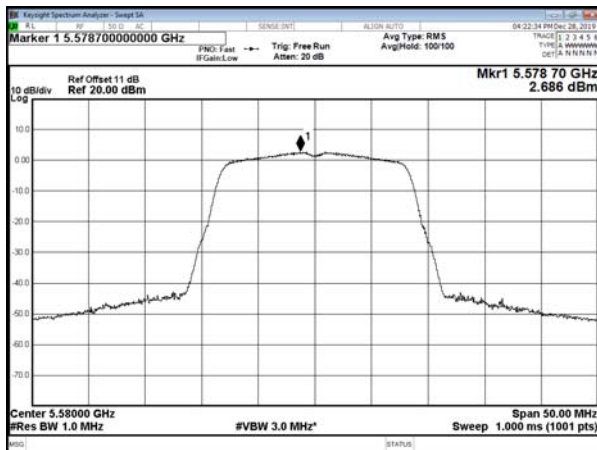

CH116

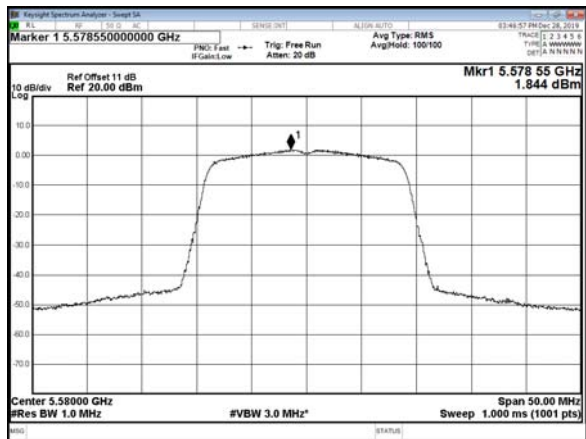

CH140

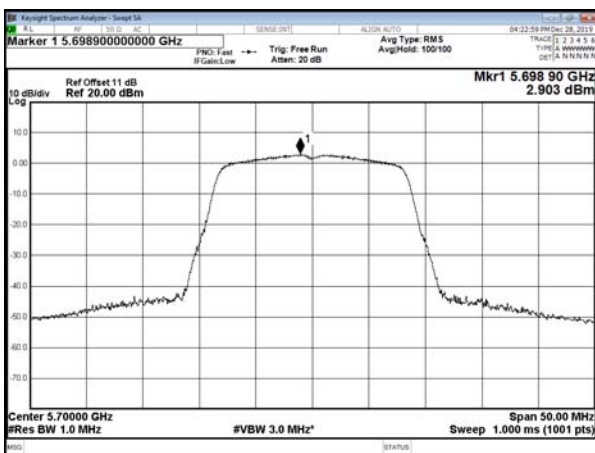

CH140

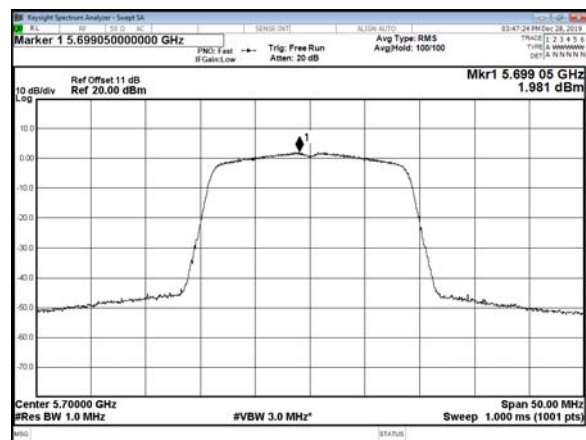



Modulation Standard: 802.11n HT40
CH102

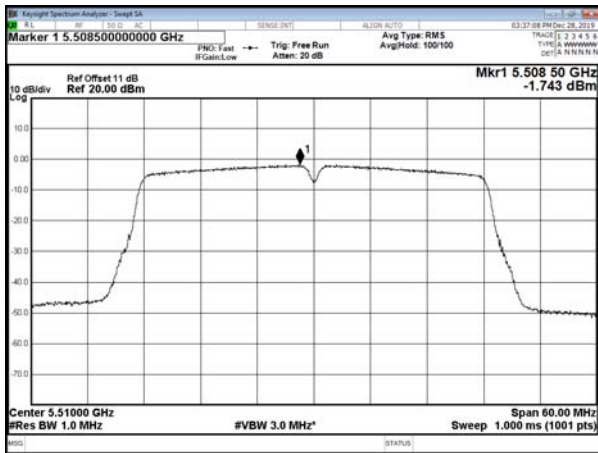

CH110

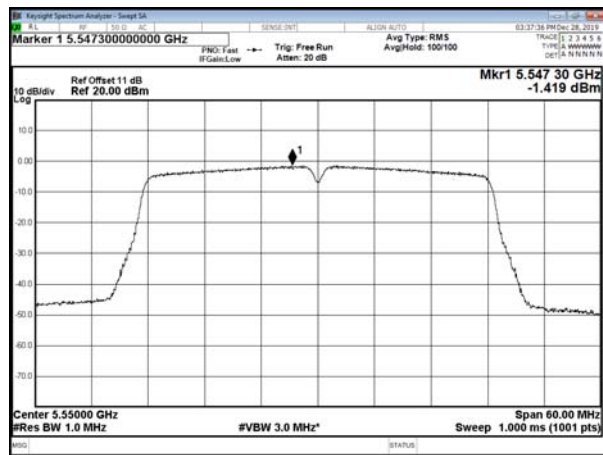

CH134

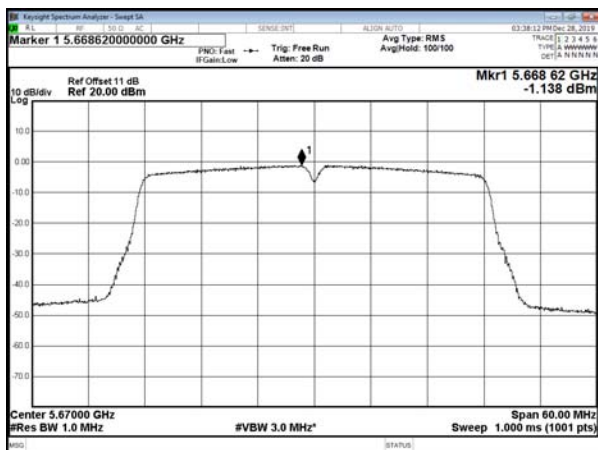



5.8G Band:
Chain 1
Modulation Standard: 802.11a
CH149

Modulation Standard: 802.11n HT20
CH149

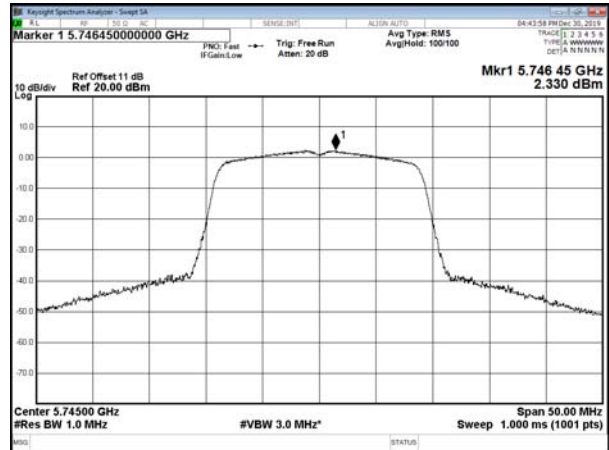
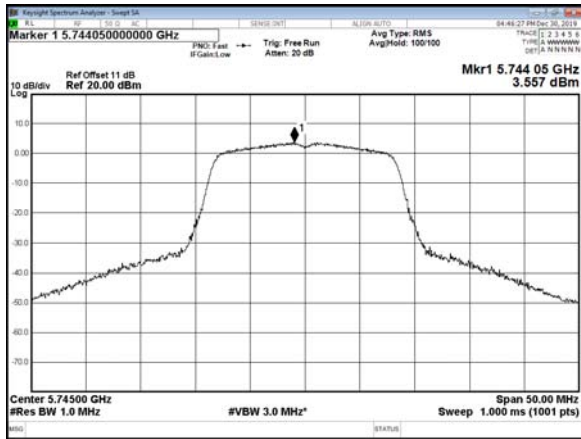

CH157

CH157

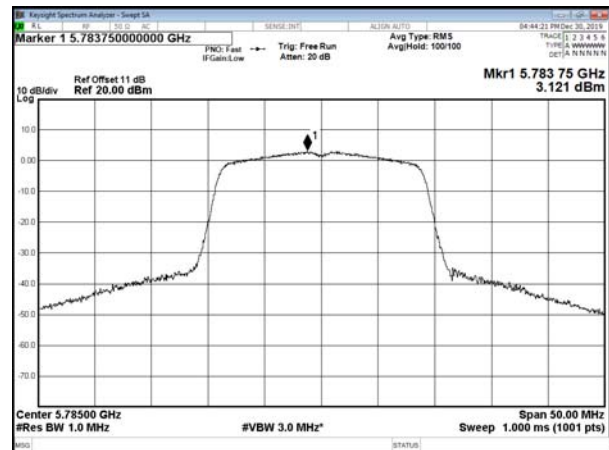
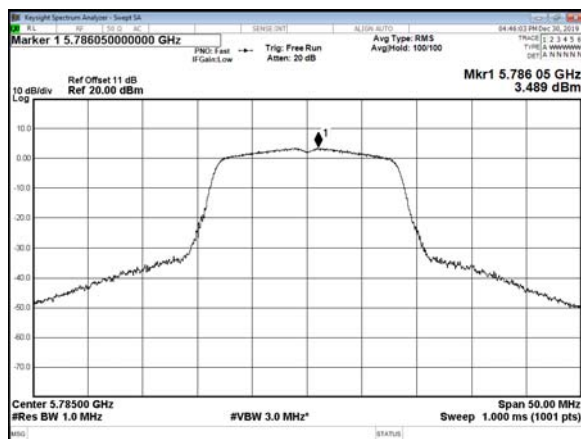

CH165

CH165

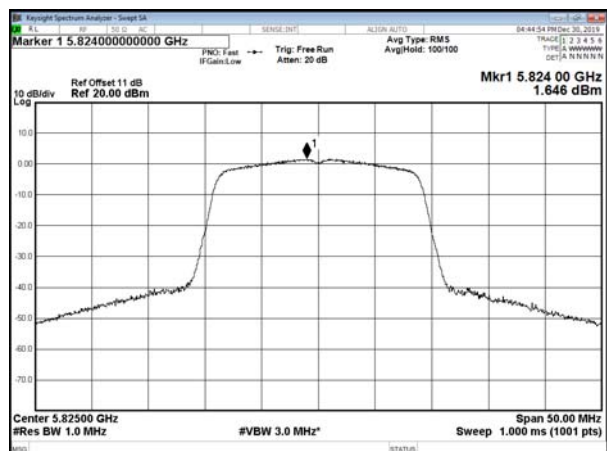
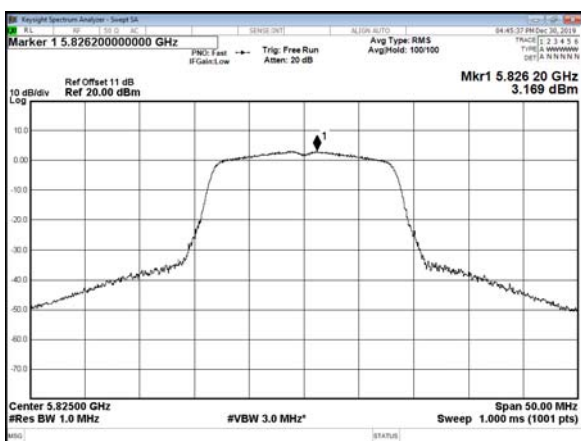



Modulation Standard: 802.11n HT40
CH151

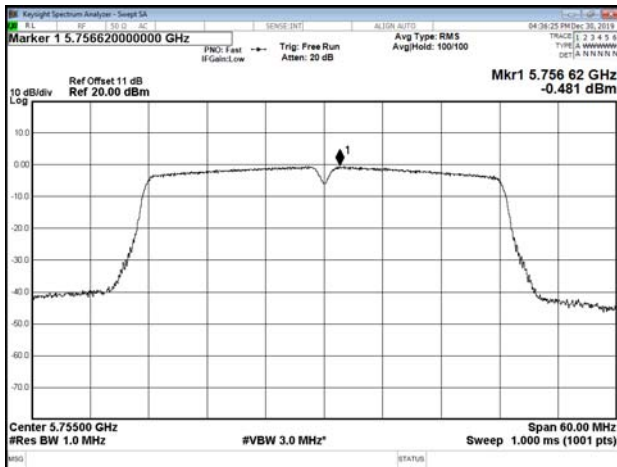

Chain 2
Modulation Standard: 802.11a
CH149

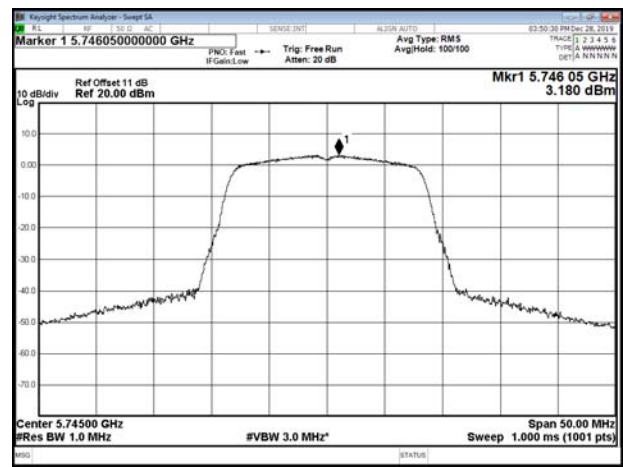

CH159

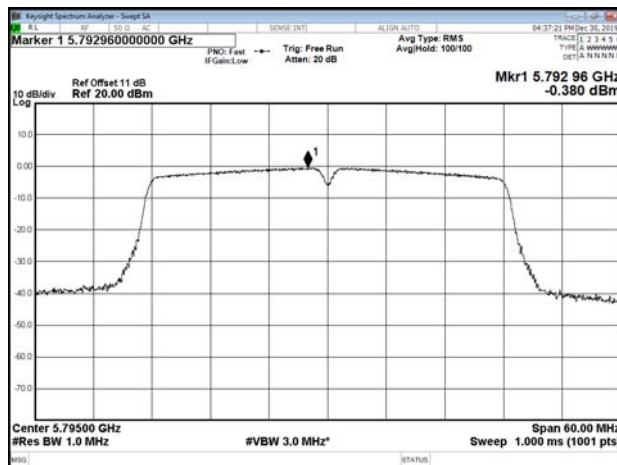

CH157

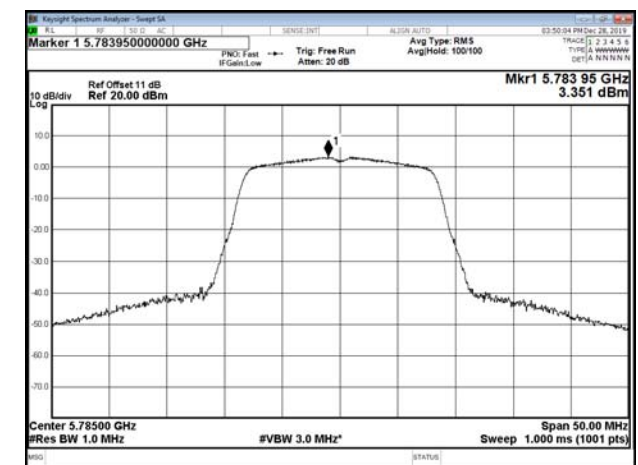

CH165

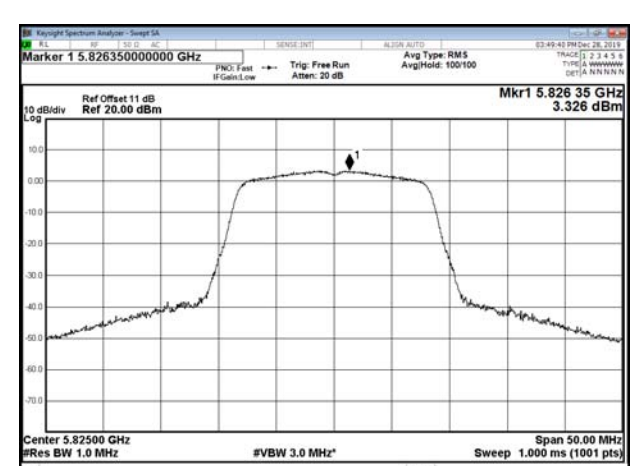



Modulation Standard: 802.11n HT20
CH149

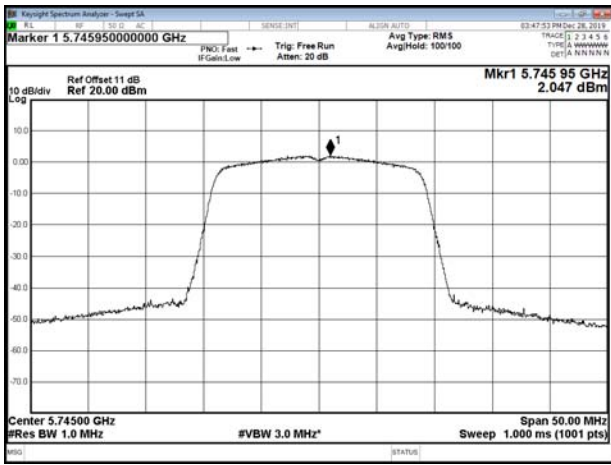

Modulation Standard: 802.11n HT40
CH151

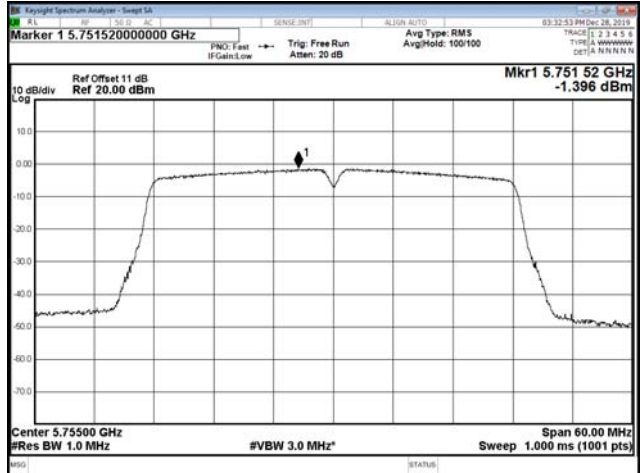

CH157

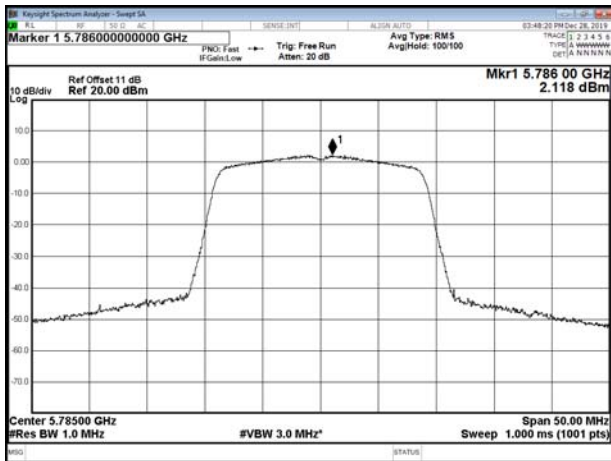

CH159

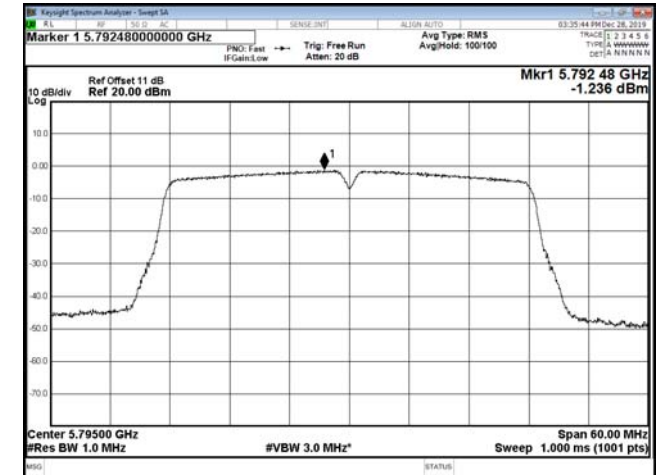

CH165

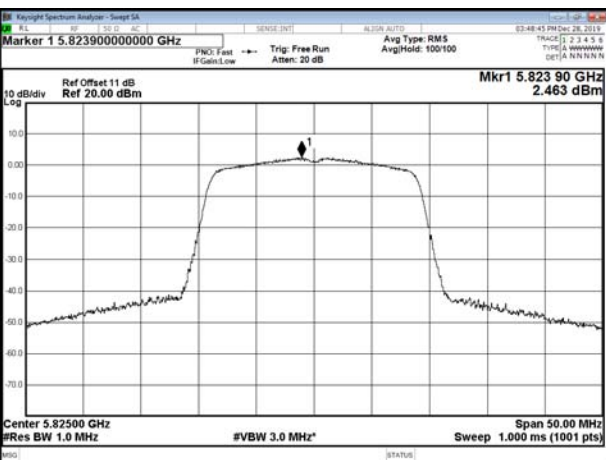



12. Frequency Stability

12.1. Test Procedure

1. The EUT was placed inside the Temperature and Humidity chamber.
2. The transmitter output was connected to spectrum analyzer.
3. Turn the EUT on and couple its output to a spectrum analyzer.
4. Turn the EUT off and set the chamber to the highest temperature specified.
5. Allow sufficient time (approximately 30 min) for the temperature of the chamber to stabilize, turn the EUT on and measure the operating frequency after 2, 5, and 10 minutes.
6. Repeat step 2 and 3 with the temperature chamber set to the lowest temperature.
7. The test chamber was allowed to stabilize at +20 degree C for a minimum of 30 minutes. The supply voltage was then adjusted on the EUT from 85% to 115% and the frequency record.

12.2. Test Setup Layout

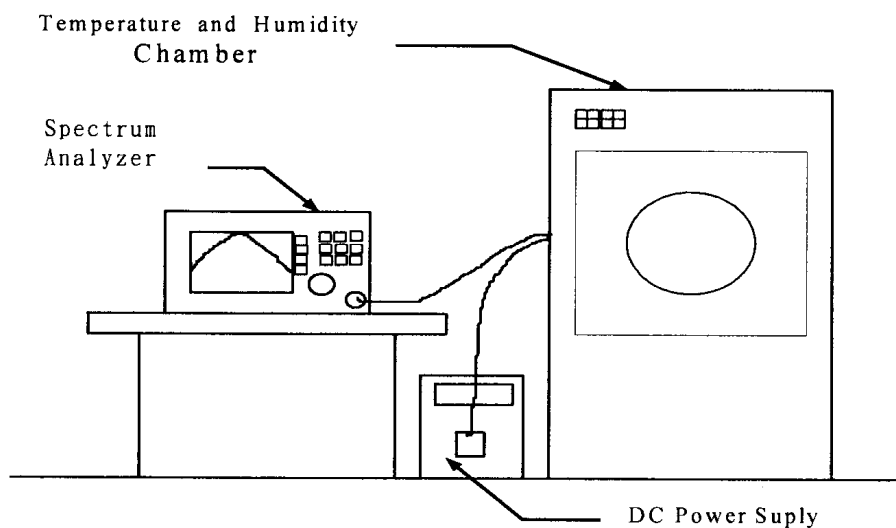

**12.3. Test Result and Data**

Temperature: 21°C

Humidity: 58%

Test Date: Dec. 30, 2019

Operating frequency: 5180 MHz							
Temp	Power supply	2 minute		5 minute		10 minute	
(°C)	(V)	(MHz)	(%)	(MHz)	(%)	(MHz)	(%)
40	3.6	5179.9996	-0.000008	5179.9801	-0.000384	5179.9805	-0.003764
	3.3	5179.9997	-0.000006	5179.9800	-0.000386	5179.9806	-0.003745
	3.0	5179.9997	-0.000006	5179.9801	-0.000384	5179.9805	-0.003764
30	3.6	5179.9922	-0.000151	5179.9905	-0.000183	5179.9906	-0.001815
	3.3	5179.9921	-0.000153	5179.9905	-0.000183	5179.9906	-0.001815
	3.0	5179.9922	-0.000151	5179.9904	-0.000185	5179.9905	-0.001834
20	3.6	5179.9882	-0.000228	5179.9889	-0.000214	5179.9895	-0.002027
	3.3	5179.9880	-0.000232	5179.9890	-0.000212	5179.9895	-0.002027
	3.0	5179.9880	-0.000232	5179.9890	-0.000212	5179.9894	-0.002046
10	3.6	5179.9954	-0.000089	5179.9950	-0.000097	5179.9948	-0.001004
	3.3	5179.9954	-0.000089	5179.9950	-0.000097	5179.9948	-0.001004
	3.0	5179.9952	-0.000093	5179.9951	-0.000095	5179.9948	-0.001004
0	3.6	5180.0302	0.000583	5180.0300	0.000579	5180.0299	0.000577
	3.3	5180.0302	0.000583	5180.0299	0.000577	5180.0299	0.000577
	3.0	5180.0301	0.000581	5180.0300	0.000579	5180.0298	0.000575

Limit:

Manufacturers of U-NII devices are responsible for ensuring frequency stability such that an emission is maintained within the band of operation under all conditions of normal operation as specified in the users manual.



13. Automatically Discontinue Transmission

13.1.Limit of Automatically Discontinue Transmission

The device shall automatically discontinue transmission in case of either absence of information to transmit or operational failure. These provisions are not intended to preclude the transmission of control or signaling information or the use of repetitive codes used by certain digital technologies to complete frame or burst intervals. Applicants shall include in their application for equipment authorization to describe how this requirement is met.

13.2.Test Result of Automatically Discontinue Transmission

While the EUT is not transmitting any information, the EUT can automatically discontinue transmission and become standby mode for power saving. The EUT can detect the controlling signal of ACK message transmitting from remote device and verify whether it shall resend or discontinue transmission.



14. Dynamic Frequency Selection

14.1. List of Measurement and Examinations

EUT Applicability of DFS requirements and Frequency Range

Operation Mode		Operating Frequency Range	
		5250-5350MHz	5470-5725MHz (5600MHz-5650MHz will be disable)
Master	--	--	--
Client without radar detection	√	√	√
Client with radar detection	--	--	--

DEVICES WITH RADAR DETECTION

MAXIMUM TRANSMIT POWER	VALUE (SEE Note 1 and 2)
≥ 200 milliwatt	-64 dBm
EIRP < 200 milliwatt and power spectral density < 10 dBm/MHz	-62 dBm
EIRP < 200 milliwatt that do not meet the power spectral density requirement	-64 dBm

Note 1: This is the level at the input of the receiver assuming a 0 dBi receive antenna.
 Note 2: Throughout these test procedures an additional 1 dB has been added to the amplitude of the test transmission waveforms to account for variations in measurement equipment. This will ensure that the test signal is at or above the detection threshold level to trigger a DFS response.
 Note3: EIRP is based on the highest antenna gain. For MIMO devices refer to KDB Publication 662911

Table1: Applicability of DFS requirements prior to use of a channel

REQUIREMENT RADAR	OPERATIONAL MODE		
	MASTER	CLIENT WITHOUT RADAR DETECTION	CLIENT WITH RADAR DETECTION
Non-Occupancy Period	V	V _{Note}	V
DFS Detection Threshold	V	Not required	V
Channel Availability Check Time	V	Not required	Not required
U-NII Detection Bandwidth	V	Not required	V

Note: Regarding KDB 905462 D03 Client Without DFS New Rules section (b)(5/6),
 If the client moves with the master, the device is considered compliant if nothing appears in the client non-occupancy period test. For devices that shut down (rather than moving channels), no beacons should appear. An analyzer plot that contains a single 30-minute sweep on the original channel.

**Table2: Applicability of DFS requirements during normal operation**

REQUIREMENT RADAR	OPERATIONAL MODE		
	MASTER	CLIENT WITHOUT RADAR DETECTION	CLIENT WITH RADAR DETECTION
DFS Detection Threshold	√	Not required	√
Channel Closing Transmission Time	√	√	√
Channel Move Time	√	√	√
U-NII Detection Bandwidth	√	Not required	√

Additional requirements for devices with multiple bandwidth modes	Master or Client with radar detection	Client without radar detection
U-NII Detection Bandwidth and Statistical Performance Check	All BW modes must be tested	Not required
Channel Move Time and Channel Closing Transmission Time	Test using widest BW mode available	Test using the widest BW mode available for the link
All other	Any single BW mode	Not required

Note: Frequencies selected for statistical performance check (Section 7.8.4) should include several frequencies within the radar detection bandwidth and frequencies near the edge of the radar detection bandwidth. For 802.11 devices it is suggested to select frequencies in each of the bonded 20 MHz channels and the channel center frequency.

14.2. Test Setup

Setup for Master with injection at the Master

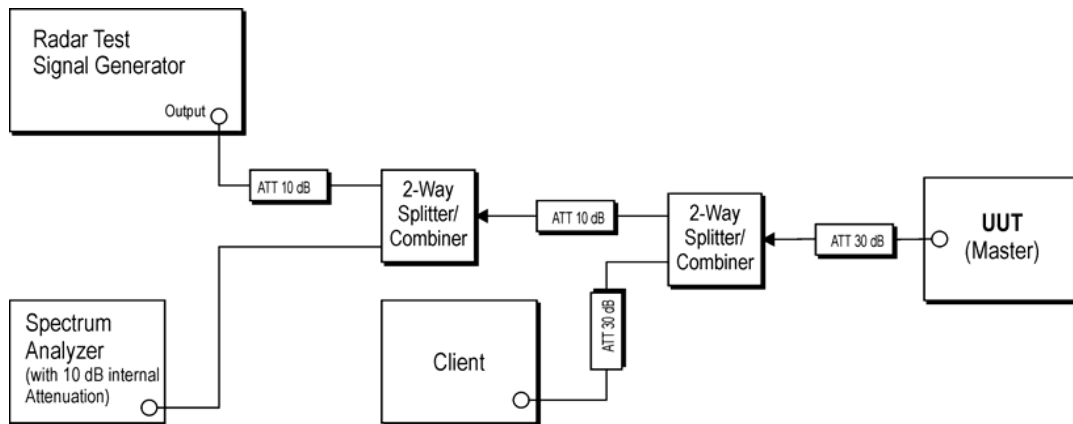

Figure 1: Example Conducted Setup where UUT is a Master and Radar Test Waveforms are injected into the Master

Setup for Client with injection at the Master

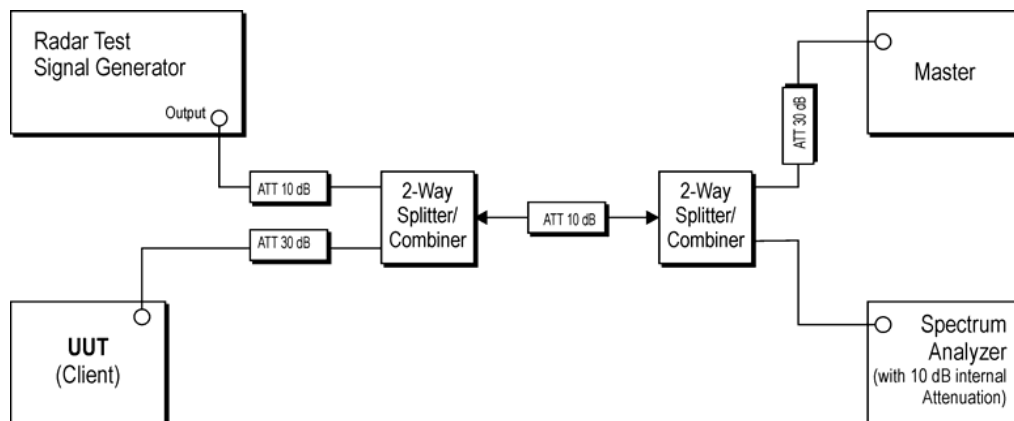

Figure 2: Example Conducted Setup where UUT is a Client and Radar Test Waveforms are injected into the Master



Setup for Client with injection at the Client

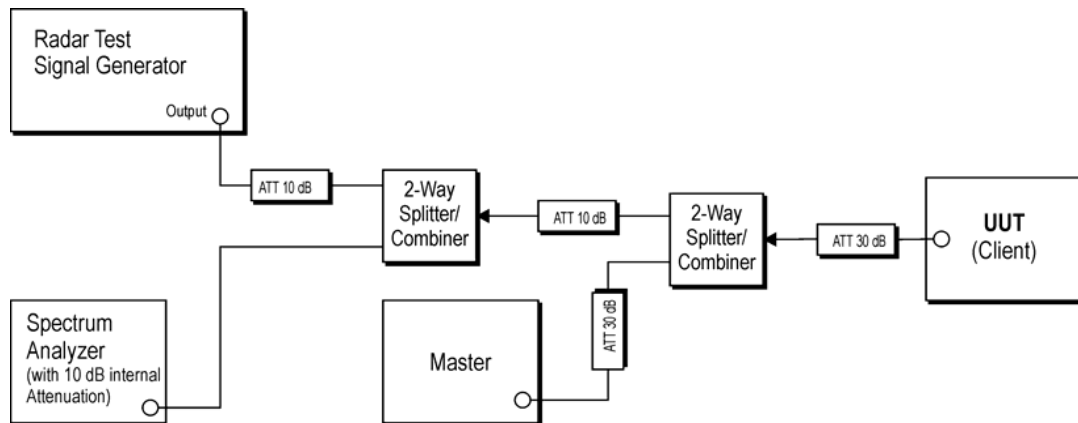

Figure 3: Example Conducted Setup where UUT is a Client and Radar Test Waveforms are injected into the Client



14.3. Non-Occupancy Period

The Channel Shutdown is defined as the process initiated by the RLAN device immediately after a radar signal has been detected on an Operating Channel.

The master device shall instruct all associated slave devices to stop transmitting on this channel, which they shall do within the Channel Move Time.

Slave devices with a Radar Interference Detection function, shall stop their own transmissions within the Channel Move Time.

The aggregate duration of all transmissions of the RLAN device on this channel during the Channel Move Time shall be limited to the Channel Closing Transmission Time. The aggregate duration of all transmissions shall not include quiet periods in between transmissions.

14.3.1. Test Limit

Radar Test Signal	Master (min)	Client (min)
0	> 30	> 30

14.3.2. Channel Loading

Timing plots are required with calculations demonstrating a minimum channel loading of approximately 17% or greater. For example, channel loading can be estimated by setting the spectrum analyzer for zero span and approximate the Time On/ (Time On + Off Time). This can be done with any appropriate channel BW and modulation type

Modulation Standard: 802.11n HT20

Time On/ (Time On + Off Time) = 6.836ms/15.567ms=43.9%

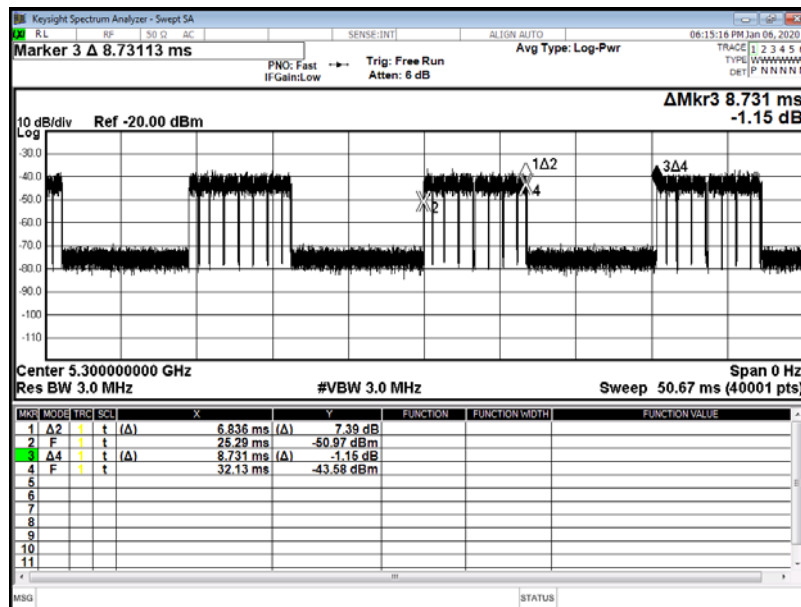



14.3.3. Test Result of Non-Occupancy Period

Modulation Standard: 802.11n HT20

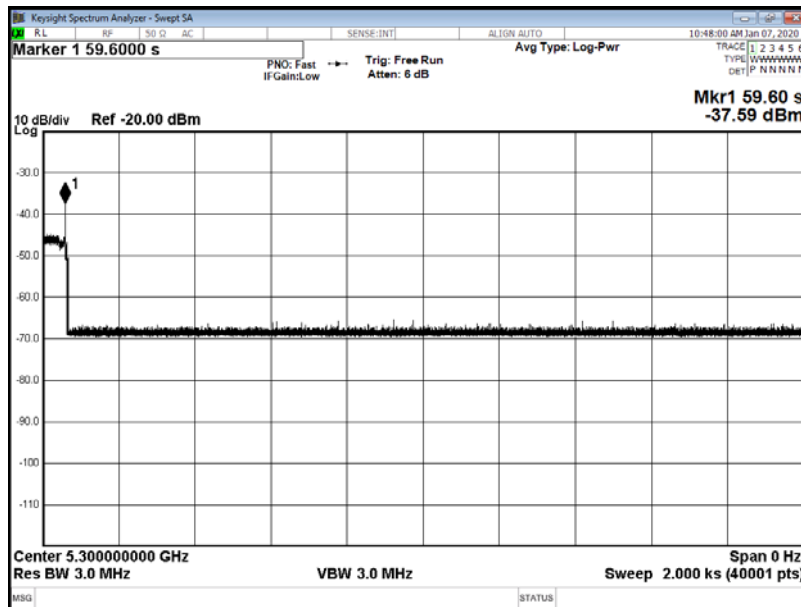



14.4.DFS Detection Threshold

DFS Detection Threshold is the level used by the DFS mechanism to detect radar interference.

14.4.1. Test Limit

Limits Clause 4.7.2.1.2

DFS Detection Thresholds for Master Devices and Client Devices with Radar Detection

MAXIMUM TRANSMIT POWER	VALUE (SEE Note 1 and 2)
≥ 200 milliwatt	-64 dBm
EIRP < 200 milliwatt and power spectral density < 10 dBm/MHz	-62 dBm
EIRP < 200 milliwatt that do not meet the power spectral density requirement	-64 dBm

Note 1: This is the level at the input of the receiver assuming a 0 dBi receive antenna.
 Note 2: Throughout these test procedures an additional 1 dB has been added to the amplitude of the test transmission waveforms to account for variations in measurement equipment. This will ensure that the test signal is at or above the detection threshold level to trigger a DFS response.
 Note3: EIRP is based on the highest antenna gain. For MIMO devices refer to KDB Publication 662911

14.4.2. Test Result of DFS Detection Threshold

EIRP < 200 milliwatt and power spectral density < 10 dBm/MHz, Radar 0 VALUE -62dBm

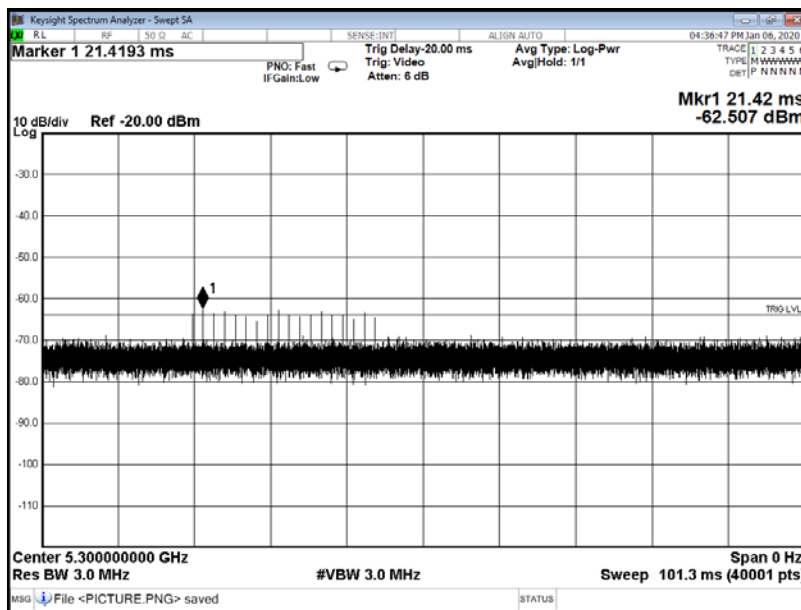



14.5.Channel Availability Check

The Channel Availability Check is defined as the mechanism by which an RLAN device checks a channel for the presence of radar signals.

There shall be no transmissions by the device within the channel being checked during this process. If no radars have been detected, the channel becomes an Available Channel valid for a period of time.

The RLAN shall only start transmissions on Available Channels.

At power-up, the RLAN is assumed to have no Available Channels.

14.5.1. Test Limit

Limits Clause 4.7.2.1.2

Table D.2: DFS requirement values

Parameter	Value
Channel Availability Check	> 60s

14.5.2. Test Result of Channel Availability Check

Not required



14.6.U-NII Detection Bandwidth

14.6.1. Test Limit

Limits Clause 4.7.2.1.2 Table D.2: DFS requirement values

Parameter	Value
U-NII Detection Bandwidth	Minimum 100% of the U-NII 99% transmission
Note : During the U-NII Detection Bandwidth detection test, radar type 0 should be used. For each frequency step the minimum percentage of detection is 90 percent. Measurements are performed with no data traffic.	

14.6.2. Test Result of U-NII Detection Bandwidth

Not required



14.7.Uniform Spreading

The UUT will select channel by random mode and remember this channel when detect radar signal, so that will select unused channel by random mode.

14.7.1. Test Result of Uniform Spreading

Not required



14.8.In-Service Monitoring

The In-Service Monitoring is defined as the process by which an RLAN monitors the Operating Channel for the presence of radar signals.

14.8.1. Test Limit

Parameter	Value
Channel Move Time	< 10 s (See Note 1)
Channel Closing Transmission Time	< 200 ms+ an aggregate of 60 milliseconds over remaining 10 second period. (See Notes 1 and Notes 2.)
Note 1: Channel Move Time and the Channel Closing Transmission Time should be performed with Radar Type 0. The measurement timing begins at the end of the Radar Type 0 burst. Note 2: The Channel Closing Transmission Time is comprised of 200 milliseconds starting at the beginning of the Channel Move Time plus any additional intermittent control signals required to facilitate a Channel move (an aggregate of 60 milliseconds) during the remainder of the 10 second period. The aggregate duration of control signals will not count quiet periods in between transmissions.	

Limits Clause 4.7.2.2.2

The In-Service Monitoring shall be used to continuously monitor an Operating Channel.

The In-Service-Monitoring shall start immediately after the RLAN has started transmissions on an Operating Channel.



14.8.2. Test Result of In-Service Monitoring

Signal 0 at 5300MHz, n HT20

	Value	Limit
Channel Move Time	8.1498s	<10 s
Channel Closing Transmission Time	105.87ms	< 200 ms

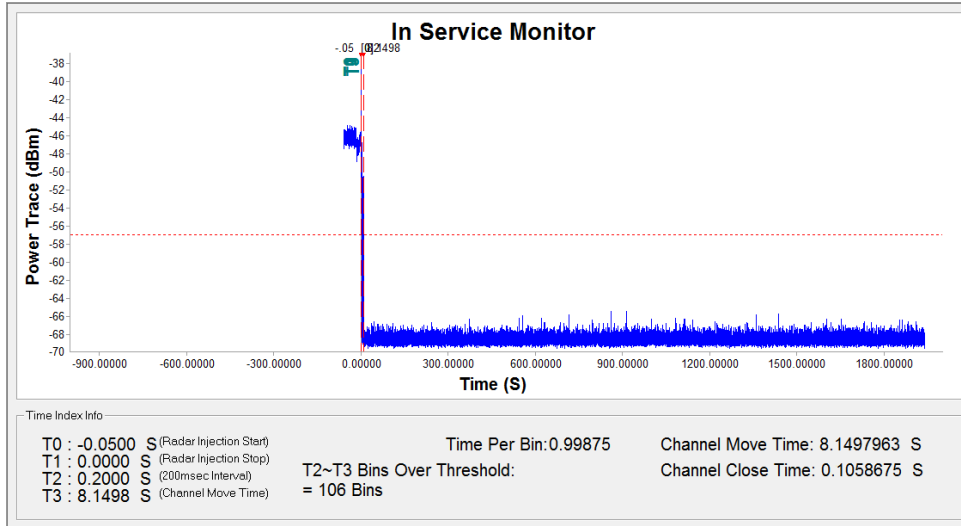



14.9.Statistical Performance Check

Not required

14.10. EUT Setup Photos

Radar Calibration Setup Photo

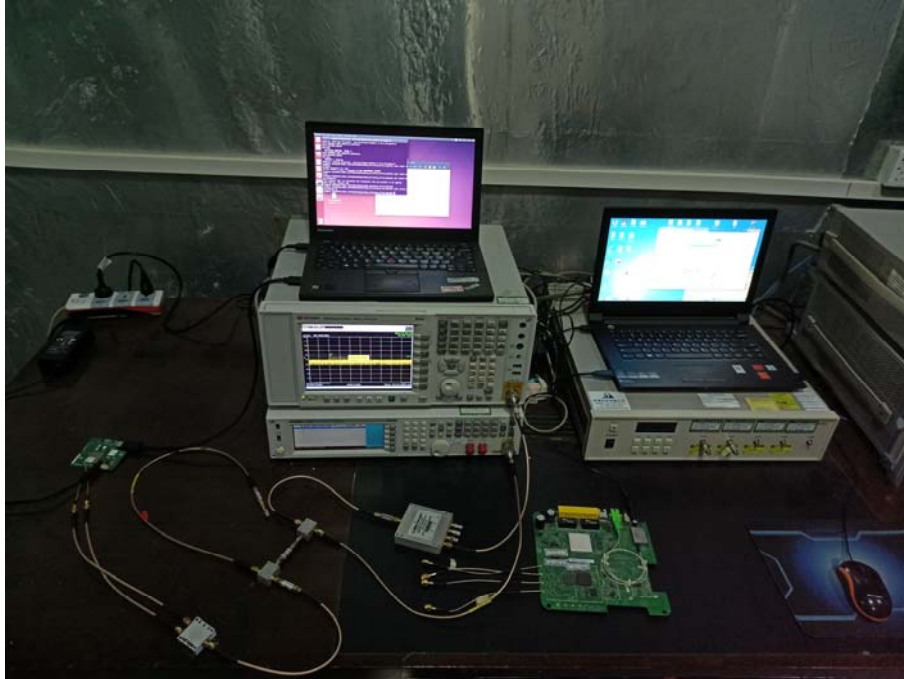

Test Setup Photo

