



**CFR 47 FCC PART 15 SUBPART E  
ISED RSS-247 ISSUE 2**

**TEST REPORT**

*For*

**IEEE 802.11b/g/n/a/ac 2T2R USB WiFi Module  
Integrated BT 2.1+EDR/4.2/5.0**

**MODEL NUMBER: SKI.WB638BU.2\_668BU**

**FCC ID: 2AR82-SKIWB668BU2  
IC: 24728-SKIWB668BU2**

**REPORT NUMBER: 4789476783-4**

**ISSUE DATE: June 3, 2020**

*Prepared for*

**Guangzhou Shikun Electronics Co., Ltd  
NO.6 Liankun Road,Huangpu District,Guangzhou,China**

*Prepared by*

**UL Verification Services (Guangzhou) Co., Ltd, Song Shan Lake Branch  
Building 10, Innovation Technology Park, No. 1, Li Bin Road, Song Shan Lake  
Hi-Tech Development Zone Dongguan, People's Republic of China**

**Tel: +86 769 22038881**

**Fax: +86 769 33244054**

**Website: [www.ul.com](http://www.ul.com)**



Revision History

<u>Rev.</u>	<u>Issue Date</u>	<u>Revisions</u>	<u>Revised By</u>
V0	06/3/2020	Initial Issue	



Summary of Test Results			
Clause	Test Items	FCC/IC Rules	Test Results
1	6dB/26dB Bandwidth	FCC 15.407 (a)&(e) RSS-247 Clause 6.2	PASS
2	99% Occupied Bandwidth	RSS-Gen Clause 6.6	PASS
3	Maximum Conducted Output Power	FCC 15.407 (a) RSS-247 Clause 6.2	PASS
4	Power Spectral Density	FCC 15.407 (a) RSS-247 Clause 6.2	PASS
5	Radiated Bandedge and Spurious Emission	FCC 15.407 (b) FCC 15.209 FCC 15.205 RSS-247 Clause 6.2 RSS-GEN Clause 8.9	PASS
6	Conducted Emission Test For AC Power Port	FCC 15.207 RSS-GEN Clause 8.8	PASS
7	Frequency Stability	FCC 15.407 (g)	PASS
8	Dynamic Frequency Selection	FCC 15.407 (h) RSS-247 Clause 6.3	PASS
9	Antenna Requirement	FCC 15.203 RSS-GEN Clause 8.3	PASS
<b>Note:</b> 1. This test report is only published to and used by the applicant, and it is not for evidence purpose in China. 2. The measurement result for the sample received is <Pass> according to < CFR 47 FCC PART 15 SUBPART E >< ISED RSS-247 > when <Accuracy Method> decision rule is applied.			



## TABLE OF CONTENTS

<b>1. ATTESTATION OF TEST RESULTS .....</b>	<b>7</b>
<b>2. TEST METHODOLOGY .....</b>	<b>8</b>
<b>3. FACILITIES AND ACCREDITATION .....</b>	<b>8</b>
<b>4. CALIBRATION AND UNCERTAINTY .....</b>	<b>9</b>
4.1. <i>MEASURING INSTRUMENT CALIBRATION .....</i>	<i>9</i>
4.2. <i>MEASUREMENT UNCERTAINTY.....</i>	<i>9</i>
<b>5. EQUIPMENT UNDER TEST .....</b>	<b>10</b>
5.1. <i>DESCRIPTION OF EUT .....</i>	<i>10</i>
5.2. <i>MAXIMUM EIRP .....</i>	<i>11</i>
5.3. <i>CHANNEL LIST.....</i>	<i>12</i>
5.4. <i>THE WORSE CASE POWER SETTING PARAMETER.....</i>	<i>14</i>
5.5. <i>THE WORSE CASE CONFIGURATIONS .....</i>	<i>16</i>
5.6. <i>DESCRIPTION OF AVAILABLE ANTENNAS .....</i>	<i>17</i>
5.7. <i>DESCRIPTION OF TEST SETUP.....</i>	<i>18</i>
<b>6. MEASURING INSTRUMENT AND SOFTWARE USED .....</b>	<b>19</b>
<b>7. ANTENNA PORT TEST RESULTS.....</b>	<b>21</b>
7.1. <i>ON TIME AND DUTY CYCLE.....</i>	<i>21</i>
7.2. <i>6/26/99% dB BANDWIDTH.....</i>	<i>22</i>
7.3. <i>MAXIMUM CONDUCTED OUTPUT POWER.....</i>	<i>25</i>
7.4. <i>POWER SPECTRAL DENSITY.....</i>	<i>27</i>
<b>8. RADIATED TEST RESULTS.....</b>	<b>29</b>
8.1. <i>802.11a 20 MODE.....</i>	<i>35</i>
8.1.1. <i>UNII-1 BAND .....</i>	<i>35</i>
8.1.2. <i>UNII-2A BAND .....</i>	<i>51</i>
8.1.3. <i>UNII-2C BAND.....</i>	<i>67</i>
8.1.4. <i>STRADDLE CHANNEL 144.....</i>	<i>85</i>
8.1.5. <i>UNII-3 BAND .....</i>	<i>89</i>
8.2. <i>802.11ac VHT20 MODE .....</i>	<i>105</i>
8.2.1. <i>UNII-1 BAND .....</i>	<i>105</i>
8.2.2. <i>UNII-2A BAND .....</i>	<i>121</i>
8.2.3. <i>UNII-2C BAND.....</i>	<i>137</i>
8.2.4. <i>STRADDLE CHANNEL 144.....</i>	<i>155</i>
8.2.5. <i>UNII-3 BAND .....</i>	<i>159</i>
8.3. <i>802.11ac VHT40 MODE .....</i>	<i>175</i>
8.3.1. <i>UNII-1 BAND .....</i>	<i>175</i>



8.3.2.	UNII-2A BAND .....	187
8.3.3.	UNII-2C BAND.....	199
8.3.4.	STRADDLE CHANNEL 142.....	217
8.3.1.	UNII-3 BAND .....	221
8.4.	<i>802.11ac VHT80 MODE</i> .....	233
8.4.1.	UNII-1 BAND .....	233
8.4.2.	UNII-2A BAND .....	241
8.4.3.	UNII-2C BAND.....	249
8.4.1.	STRADDLE CHANNEL 138.....	263
8.4.2.	UNII-3 BAND .....	267
8.5.	<i>WORST-CASE CO-LOCATION</i> .....	273
8.5.1.	BT 8DPSK MODE AND 802.11n HT20 MODE .....	273
8.6.	<i>SPURIOUS EMISSIONS 18~26GHz</i> .....	277
8.6.1.	802.11a 20 MOD .....	277
8.7.	<i>SPURIOUS EMISSIONS 26~40GHz</i> .....	279
8.7.1.	802.11a 20 MODE .....	279
8.8.	<i>SPURIOUS EMISSIONS 30M ~ 1 GHz</i> .....	281
8.8.1.	802.11a 20 MODE .....	281
8.9.	<i>SPURIOUS EMISSIONS BELOW 30M</i> .....	283
8.9.1.	802.11a 20 MODE .....	283
<b>9.</b>	<b>AC POWER LINE CONDUCTED EMISSIONS .....</b>	<b>286</b>
9.1.	<i>802.11n 20 MODE</i> .....	287
<b>10.</b>	<b>FREQUENCY STABILITY.....</b>	<b>289</b>
<b>11.</b>	<b>DYNAMIC FREQUENCY SELECTION .....</b>	<b>291</b>
<b>12.</b>	<b>ANTENNA REQUIREMENTS .....</b>	<b>295</b>
<b>13.</b>	<b>APPENDIX.....</b>	<b>296</b>
13.1.	<i>Appendix A1: 26dB Emission Bandwidth</i> .....	296
13.1.1.	Test Result.....	296
13.1.2.	Test Graphs .....	298
13.2.	<i>Appendix A2: 99% Occupied channel bandwidth</i> .....	340
13.2.1.	Test Result .....	340
13.2.2.	Test Graphs .....	342
13.3.	<i>Appendix A3: 6dB Emission bandwidth</i> .....	370
13.3.1.	Test Result.....	370
13.3.2.	Test Graphs .....	371
13.4.	<i>Appendix B: Maximum conducted output power</i> .....	379
13.4.1.	Test Result.....	379
13.4.2.	Test Graphs .....	382
13.5.	<i>Appendix C: Maximum power spectral density</i> .....	394
13.5.1.	Test Result.....	394
13.5.2.	Test Graphs .....	396



---

13.6.	<i>Appendix D: Duty Cycle</i> .....	442
13.6.1.	Test Result.....	442
13.6.2.	Test Graphs .....	443
13.7.	<i>Appendix E: Frequency Stability</i> .....	445
13.7.1.	Test Result.....	445
13.8.	<i>Appendix F: Dynamic Frequency Selection</i> .....	446
13.8.1.	Test Result.....	446



# 1. ATTESTATION OF TEST RESULTS

## Applicant Information

Company Name: Guangzhou Shikun Electronics Co., Ltd  
Address: NO.6 Liankun Road,Huangpu District,Guangzhou,China

## Manufacturer Information

Company Name: Guangzhou Shikun Electronics Co., Ltd  
Address: NO.6 Liankun Road,Huangpu District,Guangzhou,China

## EUT Description

Product Name IEEE 802.11b/g/n/a/ac 2T2R USB WiFi Module  
Integrated BT 2.1+EDR/4.2/5.0  
Model Name SKI.WB638BU.2\_668BU  
Sample Status Normal  
Sample ID 3047339  
Sample Received date May 7, 2020  
Date Tested May 8 ~ 30, 2020

APPLICABLE STANDARDS	
STANDARD	TEST RESULTS
CFR 47 FCC PART 15 SUBPART E	PASS
ISED RSS-247 Issue 2	PASS
ISED RSS-GEN Issue 5	PASS

Prepared By:

Kebo Zhang  
Project Engineer

Checked By:

Shawn Wen  
Laboratory Leader

Approved By:

Stephen Guo  
Laboratory Manager



## 2. TEST METHODOLOGY

The tests documented in this report were performed in accordance with ANSI C63.10-2013, CFR 47 FCC Part 2, CFR 47 FCC Part 15, KDB 789033 D02 v02r01, RSS-GEN Issue 5, RSS-247 Issue 2, KDB414788 D01 Radiated Test Site v01, KDB 905462 D02 UNII DFS Compliance Procedures New Rules v02 and KDB 905462 D03 UNII clients without radar detection New Rules v01r02. KDB 905462 D04 Operational Modes for DFS Testing New Rules v01

## 3. FACILITIES AND ACCREDITATION

Accreditation Certificate	<p><b>A2LA (Certificate No.: 4102.01)</b> UL Verification Services (Guangzhou) Co., Ltd. Song Shan Lake Branch. has been assessed and proved to be in compliance with A2LA.</p> <p><b>FCC (FCC Designation No.: CN1187)</b> UL Verification Services (Guangzhou) Co., Ltd. Song Shan Lake Branch. Has been recognized to perform compliance testing on equipment subject to the Commission's Declaration of Conformity (DoC) and Certification rules</p> <p><b>ISED(Company No.: 21320)</b> UL Verification Services (Guangzhou) Co., Ltd. Song Shan Lake Branch. has been registered and fully described in a report filed with ISED. The Company Number is 21320.</p> <p><b>VCCI (Registration No.: G-20019, R-20004, C-20012 and T-20011)</b> UL Verification Services (Guangzhou) Co., Ltd. Song Shan Lake Branch. has been assessed and proved to be in compliance with VCCI, the Membership No. is 3793. Facility Name: Chamber D, the VCCI registration No. is G-20019 and R-20004 Shielding Room B , the VCCI registration No. is C-20012 and T-20011</p>
---------------------------	---

Note 1: All tests measurement facilities use to collect the measurement data are located at Building 10, Innovation Technology Park, Song Shan Lake Hi tech Development Zone, Dongguan, 523808, China

Note 2: The test anechoic chamber in UL Verification Services (Guangzhou) Co., Ltd. Song Shan Lake Branch had been calibrated and compared to the open field sites and the test anechoic chamber is shown to be equivalent to or worst case from the open field site.

Note 3: For below 30MHz, lab had performed measurements at test anechoic chamber and comparing to measurements obtained on an open field site. And these measurements below 30MHz had been correlated to measurements performed on an OFS.





## 4. CALIBRATION AND UNCERTAINTY

### 4.1. MEASURING INSTRUMENT CALIBRATION

The measuring equipment utilized to perform the tests documented in this report has been calibrated in accordance with the manufacturer's recommendations, and is traceable to recognize national standards.

### 4.2. MEASUREMENT UNCERTAINTY

Where relevant, the following measurement uncertainty levels have been estimated for tests performed on the apparatus:

Test Item	Uncertainty
Uncertainty for Conduction emission test	3.62dB
Uncertainty for Radiation Emission test(include Fundamental emission) (9KHz-30MHz)	2.2dB
Uncertainty for Radiation Emission test(include Fundamental emission) (30MHz-1GHz)	4.00dB
Uncertainty for Radiation Emission test (1GHz to 26GHz)( include Fundamental emission)	5.78dB (1GHz-18GHz)
	5.23dB (18GHz-26GHz)
	5.64dB (26GHz-40GHz)
Note: This uncertainty represents an expanded uncertainty expressed at approximately the 95% confidence level using a coverage factor of k=2.	



## 5. EQUIPMENT UNDER TEST

### 5.1. DESCRIPTION OF EUT

EUT Name	IEEE 802.11b/g/n/a/ac 2T2R USB WiFi Module Integrated BT 2.1+EDR/4.2/5.0
Model	SKI.WB638BU.2_668BU
Radio Technology	IEEE802.11a 20 IEEE802.11n HT20/n HT40 IEEE802.11ac VHT20/VHT40/VHT80
Operation frequency	UNII-1/UNII-2A/UNII-2C/UNII-3
Modulation	OFDM(BPSK,QPSK,16QAM,64QAM, 256QAM only for 11 ac mode)
Rated Input	DC 3.3V



## 5.2. MAXIMUM EIRP

### UNII-1 BAND

IEE Std.	Frequency (MHz)	Max Power (dBm)	Max EIRP (dBm)
802.11a 20	5150-5250	16.09	18.62
802.11n HT20	5150-5250	14.23	19.95
802.11n HT40	5150-5250	16.44	22.16
802.11ac VHT20	5150-5250	14.19	19.90
802.11ac VHT40	5150-5250	16.17	21.88
802.11ac VHT80	5150-5250	15.95	21.66

### UNII-2A BAND

IEE Std.	Frequency (MHz)	Max Power (dBm)
802.11a 20	5250-5350	15.65
802.11n HT20	5250-5350	17.80
802.11n HT40	5250-5350	17.32
802.11ac VHT20	5250-5350	17.78
802.11ac VHT40	5250-5350	17.41
802.11ac VHT80	5250-5350	15.17

### UNII-2C BAND

IEE Std.	Frequency (MHz)	Max Power (dBm)
802.11a 20	5470-5725	15.76
802.11n HT20	5470-5725	17.75
802.11n HT40	5470-5725	17.67
802.11ac VHT20	5470-5725	17.76
802.11ac VHT40	5470-5725	17.59
802.11ac VHT80	5470-5725	15.87

### UNII-3 BAND

IEE Std. 802.11	Frequency (MHz)	Max Power (dBm)
802.11a 20	5725-5850	15.08
802.11n HT20	5725-5850	16.86
802.11n HT40	5725-5850	17.19
802.11ac VHT20	5725-5850	16.98
802.11ac VHT40	5725-5850	16.99
802.11ac VHT80	5725-5850	15.64



### 5.3. CHANNEL LIST

20 MHz Bandwidth Channel frequencies		
Band	Channel	Frequency (MHz)
UNII-1	36	5180
	40	5200
	44	5220
	48	5240
UNII-2A	52	5260
	56	5280
	60	5300
	64	5320
UNII-2C	100	5500
	104	5520
	108	5540
	112	5560
	116	5580
	132	5660
	136	5680
	140	5700
UNII-3	149	5745
	153	5765
	157	5785
	161	5805
	165	5825

40 MHz Bandwidth Channel frequencies		
Band	Channel	Frequency (MHz)
UNII-1	38	5190
	46	5230
UNII-2	54	5270
	62	5310
UNII-2C	102	5510
	110	5550
	134	5670
UNII-3	151	5755
	159	5795



80 MHz Bandwidth Channel frequencies		
Band	Channel	Frequency (MHz)
UNII-1	42	5210
UNII-2A	58	5290
UNII-2C	106	5530
	122	5610
UNII-3	155	5775

Straddle Channel frequencies		
Bandwidth	Channel	Frequency (MHz)
20MHz	144	5720
40MHz	142	5710
80MHz	138	5690



### 5.4. THE WORSE CASE POWER SETTING PARAMETER

The Worse Case Power Setting Parameter	
Test Software	QA tool

#### UNII-1

Mode	Rate	Channel	Soft set value	
			ANT1	ANT2
11a	6M	36	1C	1C
		40	1C	1C
		48	1C	1C
11n HT20	MCS0	36	17	17
		40	15	15
		48	15	15
11n HT40	MCS0	38	16	16
		46	1A	1A
11ac VHT20	MCS0	36	16	16
		40	15	15
		48	15	15
11ac VHT40	MCS0	38	15	15
		46	19	19
11ac VHT80	MCS0	42	1C	1C

#### UNII-2A

Mode	Rate	Channel	Soft set value	
			ANT1	ANT2
11a	6M	52	1D	1D
		60	1D	1D
		64	1D	1D
11n HT20	MCS0	52	1D	1D
		60	1D	1D
		64	1D	1D
11n HT40	MCS0	54	1D	1D
		62	19	19
11ac VHT20	MCS0	52	1D	1D
		60	1D	1D
		64	1D	1D
11ac VHT40	MCS0	54	1D	1D
		62	18	18
11ac VHT80	MCS0	58	1C	1C



UNII-2C

Mode	Rate	Channel	Soft set value	
			ANT1	ANT2
11a	6M	100	1D	1D
		120	1D	1D
		140	1D	1D
11n HT20	MCS0	100	1D	1D
		120	1D	1D
		140	1D	1D
11n HT40	MCS0	102	15	15
		118	1D	1D
		134	1D	1D
11ac VHT20	MCS0	100	1D	1D
		120	1D	1D
		140	1D	1D
11ac VHT40	MCS0	102	14	14
		118	1D	1D
		134	1D	1D
11ac VHT80	MCS0	106	16	16
		122	1D	1D

UNII-3

Mode	Rate	Channel	Soft set value	
			ANT1	ANT2
11a	6M	149	1D	1D
		157	1D	1D
		165	1D	1D
11n HT20	MCS0	149	1D	1D
		157	1D	1D
		165	1D	1D
11n HT40	MCS0	151	1D	1D
		159	1D	1D
11ac VHT20	MCS0	149	1D	1D
		157	1D	1D
		165	1D	1D
11ac VHT40	MCS0	151	1D	1D
		159	1D	1D
11ac VHT80	MCS0	155	1D	1D



## 5.5. THE WORSE CASE CONFIGURATIONS

For SISO modes, there are two transmission antennas. The antenna used in any given time can be either ANTENNA 1 or ANTENNA 2. The output power measurement for SISO modes on both antennas are reported.

For 2TX MIMO modes, ANTENNA 1 and ANTENNA 2, used at the same time.

SISO mode and MIMO mode have the same power setting, so only the worst-case MIMO mode will be record in the report.

Worst-case data rates as provided by the client were:

802.11a mode: 6 Mbps

802.11n HT20 mode: MCS0

802.11n HT40 mode: MCS0

802.11ac VHT20 mode: MCS0

802.11ac VHT40 mode: MCS0

802.11ac VHT80 mode: MCS0

802.11ac VHT20 and VHT40 mode are different from 802.11nHT20 and HT40 only in control messages, so for these 4 modes, only 802.11ac VHT20 and 802.11ac VHT40 worst case power modes data are recorded in the report .

802.11ac VHT20/VHT40 SISO mode and MIMO mode have the same power setting, so only the worst case MIMO mode will be record in the report.

802.11a support SISO mode, two antenna have the same power setting, so only the worst data for antenna 1 are recorded in the report.





### 5.6. DESCRIPTION OF AVAILABLE ANTENNAS

Antenna No.	Frequency Band	Antenna Type	Max Antenna Gain (dBi)	Directional Gain (dBi)
1(WIFI0)	UNII1	PIFA	2.87	5.718
2(WIFI1)	UNII1	PIFA	2.53	
1(WIFI0)	UNII-2A	PIFA	3.45	6.117
2(WIFI1)	UNII-2A	PIFA	2.75	
1(WIFI0)	UNII-2C	PIFA	5.45	8.180
2(WIFI1)	UNII-2C	PIFA	4.88	
1(WIFI0)	UNII3	PIFA	5.20	7.54
2(WIFI1)	UNII3	PIFA	4.53	

Note: Directional gain=  $10 \log[(10^{G1/20} + 10^{G2/20})^2 / N_{ANT}]$  dBi  
 $N_{ANT}$  : Antenna numbers

IEE Std. 802.11	Transmit and Receive Mode	Description
802.11a	<input checked="" type="checkbox"/> 2TX, 2RX	ANT 1, 2 can be used as transmitting/receiving antenna.
802.11n HT20	<input checked="" type="checkbox"/> 2TX, 2RX	ANT 1, 2 can be used as transmitting/receiving antenna.
802.11n HT40	<input checked="" type="checkbox"/> 2TX, 2RX	ANT 1, 2 can be used as transmitting/receiving antenna.
802.11ac VHT20	<input checked="" type="checkbox"/> 2TX, 2RX	ANT 1, 2 can be used as transmitting/receiving antenna.
802.11ac VHT40	<input checked="" type="checkbox"/> 2TX, 2RX	ANT 1, 2 can be used as transmitting/receiving antenna.
802.11ac VHT80	<input checked="" type="checkbox"/> 2TX, 2RX	ANT 1, 2 can be used as transmitting/receiving antenna.

Note:

1. Only 802.11a does not support MIMO mode
3. BT&WLAN 2.4G, BT& WLAN 5G can transmit simultaneously. (declared by client)

Note: The value of the antenna gain was declared by customer.

## 5.7. DESCRIPTION OF TEST SETUP

### SUPPORT EQUIPMENT

Item	Equipment	Brand Name	Model Name	Remarks
1	Laptop	ThinkPad	X230i	/
2	Test fixture	/	/	/
3	AC/DC adapter	HUAWEI	HW-120150E2W	INPUT:100-240V~50/60Hz, 0.5A OUTPUT:12.0V, 1.5A

### I/O CABLES

Cable No	Port	Connector Type	Cable Type	Cable Length(m)	Remarks
1	USB	N/A	N/A	1	N/A

### ACCESSORIES

Item	Accessory	Brand Name	Model Name	Description
1	/	/	/	/

### TEST SETUP

The EUT can work in engineering mode with a software through a Laptop.

### SETUP DIAGRAM FOR TESTS

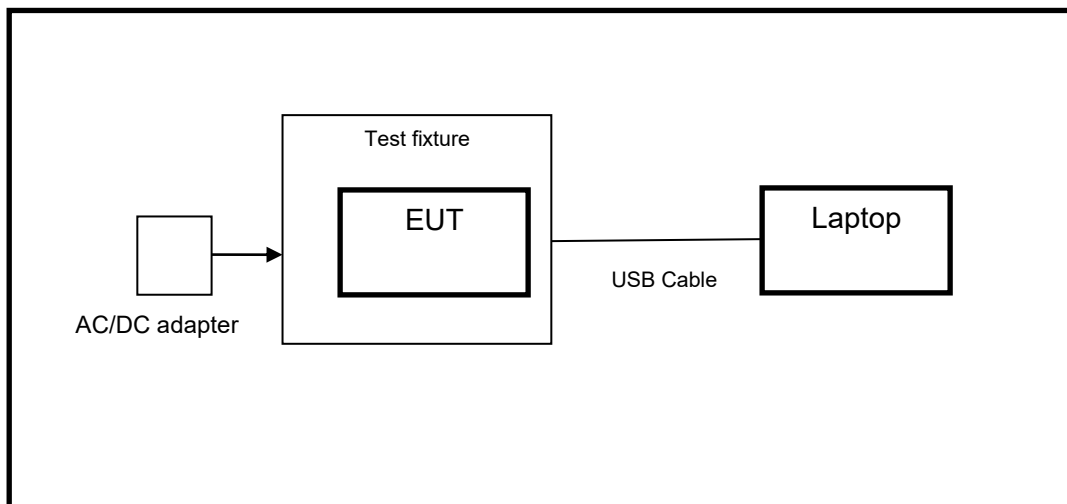



## 6. MEASURING INSTRUMENT AND SOFTWARE USED

Conducted Emissions						
Instrument						
Used	Equipment	Manufacturer	Model No.	Serial No.	Last Cal.	Next Cal.
<input checked="" type="checkbox"/>	EMI Test Receiver	R&S	ESR3	101961	Dec.05,2019	Dec.05,2020
<input checked="" type="checkbox"/>	Two-Line V-Network	R&S	ENV216	101983	Dec.05,2019	Dec.05,2020
<input checked="" type="checkbox"/>	Artificial Mains Networks	Schwarzbeck	NSLK 8126	8126465	Dec.05,2019	Dec.05,2020
Software						
Used	Description	Manufacturer	Name	Version		
<input checked="" type="checkbox"/>	Test Software for Conducted disturbance	Farad	EZ-EMC	Ver. UL-3A1		
Radiated Emissions						
Instrument						
Used	Equipment	Manufacturer	Model No.	Serial No.	Last Cal.	Next Cal.
<input checked="" type="checkbox"/>	MXE EMI Receiver	KESIGHT	N9038A	MY56400036	Dec.06,2019	Dec.06,2020
<input checked="" type="checkbox"/>	Hybrid Log Periodic Antenna	TDK	HLP-3003C	130960	Sep.17, 2018	Sep.17, 2021
<input checked="" type="checkbox"/>	Preamplifier	HP	8447D	2944A09099	Dec.05,2019	Dec.05,2020
<input checked="" type="checkbox"/>	EMI Measurement Receiver	R&S	ESR26	101377	Dec.05,2019	Dec.05,2020
<input checked="" type="checkbox"/>	Horn Antenna	TDK	HRN-0118	130939	Sep.17, 2018	Sep.17, 2021
<input checked="" type="checkbox"/>	High Gain Horn Antenna	Schwarzbeck	BBHA-9170	691	Aug.11, 2018	Aug.11, 2021
<input checked="" type="checkbox"/>	Preamplifier	TDK	PA-02-0118	TRS-305-00066	Dec.05,2019	Dec.05,2020
<input checked="" type="checkbox"/>	Preamplifier	TDK	PA-02-2	TRS-307-00003	Dec.05,2019	Dec.05,2020
<input checked="" type="checkbox"/>	Preamplifier	TDK	PA-02-3	TRS-308-00002	Dec.05,2019	Dec.05,2020
<input checked="" type="checkbox"/>	Loop antenna	Schwarzbeck	1519B	00008	Jan.07, 2019	Jan.07, 2022
<input checked="" type="checkbox"/>	Band Reject Filter	Wainwright	WRCJV12-5695-5725-5850-5880-40SS	4	Dec.05,2019	Dec.05,2020
<input checked="" type="checkbox"/>	Band Reject Filter	Wainwright	WRCJV20-5120-5150-5350-5380-60SS	2	Dec.05,2019	Dec.05,2020
<input checked="" type="checkbox"/>	Band Reject Filter	Wainwright	WRCJV20-5440-5470-5725-5755-	1	Dec.05,2019	Dec.05,2020



			60SS			
<input checked="" type="checkbox"/>	High Pass Filter	Wainwright	WHKX10-5850-6500-1800-40SS	4	Dec.05,2019	Dec.05,2020
<b>Software</b>						
Used	Description		Manufacturer	Name		Version
<input checked="" type="checkbox"/>	Test Software for Radiated disturbance		Farad	EZ-EMC		Ver. UL-3A1
<b>Other instruments</b>						
Used	Equipment	Manufacturer	Model No.	Serial No.	Last Cal.	Next Cal.
<input checked="" type="checkbox"/>	Spectrum Analyzer	Keysight	N9030A	MY55410512	Dec.06,2019	Dec.06,2020
<input checked="" type="checkbox"/>	Power sensor, Power Meter	R&S	OSP120	100921	Dec.06,2019	Dec.06,2020



## 7. ANTENNA PORT TEST RESULTS

### 7.1. ON TIME AND DUTY CYCLE

#### LIMITS

None; for reporting purposes only

#### TEST SETUP

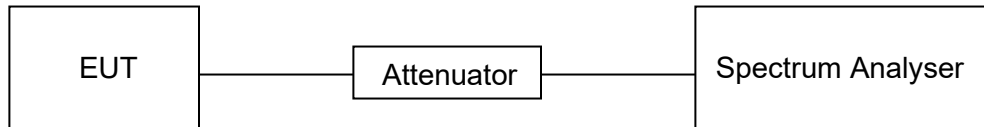

#### TEST ENVIRONMENT

Temperature	25.5°C	Relative Humidity	59%
Atmosphere Pressure	101kPa	Test Voltage	DC 3.3V

#### RESULTS

Please refer to Appendix D.



## 7.2. 6/26/99% dB BANDWIDTH

### LIMITS

CFR 47 FCC Part15, Subpart E ISED RSS-247		
Test Item	Limit	Frequency Range (MHz)
Bandwidth	26 dB Bandwidth	5150-5250
	26 dB Bandwidth	5250-5350
	26 dB Bandwidth	For FCC:5470-5725 For IC:5470-5600 5650-5725
	Minimum 500kHz 6dB Bandwidth	5725-5850

ISED RSS-247		
RSS-Gen Clause 6.6	99% Bandwidth	For reporting purposes only.

### TEST PROCEDURE

Connect the UUT to the spectrum analyser and use the following settings:

Center Frequency	The center frequency of the channel under test
Detector	Peak
RBW	For 6dB Bandwidth: RBW=100kHz For 26dB Bandwidth: approximately 1% of the emission bandwidth. For 99dB Bandwidth: approximately 1%~5% of the emission bandwidth.
VBW	For 6dB Bandwidth : VBW=300kHz For 26dB Bandwidth : >3RBW For 99%dB Bandwidth : >3RBW
Trace	Max hold
Sweep	Auto couple

Allow the trace to stabilize and measure the maximum width of the emission that is constrained by the frequencies associated with the two outermost amplitude points (upper and lower frequencies) that are attenuated by 6dB/26dB&99% Occupied Bandwidth relative to the maximum level measured in the fundamental emission.



Note:

Calculation for 99% Bandwidth of UNII-2C and UNII-3 Straddle Channel.

- ex) Fundamental frequency:5720
  - >99% BW: 21.00MHz
  - >Turning Frequency: 5725MHz
  - >99% Bandwidth of UNII-2C band Portion  
=  $(5725-(5720-(21.00/2))) = 15.50\text{MHz}$
  - >99% Bandwidth of UNII-3 band Portion  
=  $(5720+(21.00/2)-5725)=5.50\text{MHz}$

Calculation for 26dB Bandwidth of UNII-2C Straddle Channel.

- ex) Fundamental frequency:5720
  - >26dB BW: 20.00MHz
  - FL:5710.16MHz
  - FH:5730.16MHz
  - >Turning Frequency: 5725MHz
  - >26dB Bandwidth of UNII-2C band Portion  
=  $5725-5710.16=14.84\text{MHz}$

Calculation for 6dB Bandwidth of UNII-3 Straddle Channel.

- ex) Fundamental frequency:5720
  - >6dB BW: 16.44MHz
  - FL:5711.76MHz
  - FH:5728.2MHz
  - >Turning Frequency: 5725MHz
  - >6dB Bandwidth of UNII-3 band Portion  
=  $5728.2-5725=3.2\text{MHz}$



**TEST SETUP**

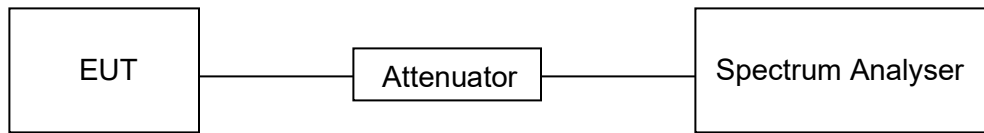

**TEST ENVIRONMENT**

Temperature	26.5°C	Relative Humidity	63%
Atmosphere Pressure	101kPa	Test Voltage	DC 3.3V

**RESULTS**

Please refer to Appendix A1&A2&A3.





### 7.3. MAXIMUM CONDUCTED OUTPUT POWER

#### LIMITS

CFR 47 FCC Part15, Subpart E		
Test Item	Limit	Frequency Range (MHz)
Conducted Output Power	For FCC client devices:250mW (24dBm)	5150-5250
	Not exceed the lesser of 250 mW or 11 dBm + 10 log B whichever is less where B is the 26 dB emission bandwidth in megahertz	5250-5350
	Not exceed the lesser of 250 mW or 11 dBm + 10 log B whichever is less where B is the 26 dB emission bandwidth in megahertz	5470-5725
	1 Watt (30dBm)	5725-5850

ISED RSS-247		
Test Item	Limit	Frequency Range (MHz)
Conducted Output Power	Maximum e.i.r.p. shall not exceed 200 mW or 10 + 10 log <sub>10</sub> B, dBm, whichever is less where B is the 99% emission bandwidth in megahertz	5150-5250
	Not exceed 250 mW or 11 + 10 log <sub>10</sub> B, where B is the 99% emission bandwidth in megahertz	5250-5350
	Not exceed 250 mW or 11 + 10 log <sub>10</sub> B, where B is the 99% emission bandwidth in megahertz	5470-5600 5650-5725
	1 Watt (30dBm)	5725-5850

Note: If transmitting antennas of directional gain greater than 6 dBi are used, the maximum conducted output power shall be reduced by the amount in dB that the directional gain of the antenna exceeds 6dBi.



**TEST PROCEDURE**

Refer to KDB 789033 D02 General UNII Test Procedures New Rules v02r01

Connect the EUT to the a broadband average RF power meter, the power meter shall have a video bandwidth that is greater than or equal to the bandwidth and shall utilize a fast-responding diode detector.

Straddle channel power is measured using PXA spectrum analyzer.

**TEST SETUP**

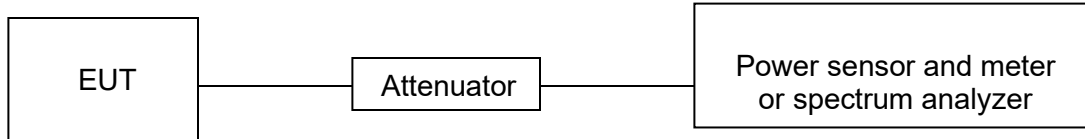

**TEST ENVIRONMENT**

Temperature	24°C	Relative Humidity	62%
Atmosphere Pressure	101kPa	Test Voltage	DC 3.3V

**RESULTS**

Please refer to Appendix B.



## 7.4. POWER SPECTRAL DENSITY

### LIMITS

CFR 47 FCC Part15, Subpart E ISED RSS-247		
Test Item	Limit	Frequency Range (MHz)
Power Spectral Density	For FCC: Other than Mobile and portable:17dBm/MHz Mobile and portable:11dBm/MHz	5150-5250
	For RSS: e.i.r.p. 10dBm/MHz	
	11dBm/MHz	5250-5350
	11dBm/MHz	For FCC:5470-5725 For IC:5470-5600 5650-5725
	30dBm/500kHz	5725-5850
<p>Note: 1. If transmitting antennas of directional gain greater than 6 dBi are used, both the maximum conducted output power and the maximum power spectral density shall be reduced by the amount in dB that the directional gain of the antenna exceeds 6dBi.</p>		

### TEST PROCEDURE

Connect the UUT to the spectrum analyser and use the following settings:

For U-NII-1, U-NII-2A and U-NII-2C band:

Center Frequency	The center frequency of the channel under test
Detector	RMS
RBW	1MHz
VBW	$\geq 3 \times \text{RBW}$
Span	Encompass the entire emissions bandwidth (EBW) of the signal
Trace	Max hold
Sweep time	Auto

For U-NII-3:

Center Frequency	The center frequency of the channel under test
Detector	RMS
RBW	500kHz
VBW	$\geq 3 \times \text{RBW}$
Span	Encompass the entire emissions bandwidth (EBW) of the signal
Trace	Max hold
Sweep time	Auto

Allow trace to fully stabilize and use the peak marker function to determine the maximum amplitude level within the RBW.



**TEST SETUP**

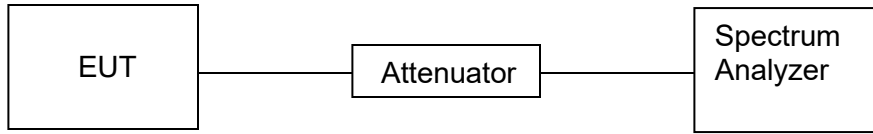

**TEST ENVIRONMENT**

Temperature	23.5°C	Relative Humidity	63%
Atmosphere Pressure	101kPa	Test Voltage	DC 3.3V

**RESULTS**

Please refer to Appendix C.



7.4.1.

**8. RADIATED TEST RESULTS**

**LIMITS**

Please refer to CFR 47 FCC §15.205, §15.209 and §15.407(b) (4)

Please refer to ISED RSS-GEN Clause 8.9

Radiation Disturbance Test Limit for FCC (Class B)(9kHz-1GHz)

Frequency (MHz)	Field Strength (microvolts/meter)	Measurement Distance (meters)
0.009~0.490	2400/F(kHz)	300
0.490~1.705	24000/F(kHz)	30
1.705~30.0	30	30
30~88	100	3
88~216	150	3
216~960	200	3
960~1000	500	3

Note: 1) At frequencies at or above 30 MHz, measurements may be performed at a distance other than what is specified provided: measurements are not made in the near field except where it can be shown that near field measurements are appropriate due to the characteristics of the device; and it can be demonstrated that the signal levels needed to be measured at the distance employed can be detected by the measurement equipment. Measurements shall not be performed at a distance greater than 30 meters unless it can be further demonstrated that measurements at a distance of 30 meters or less are impractical. When performing measurements at a distance other than that specified, the results shall be extrapolated to the specified distance using an extrapolation factor of 20 dB/decade (inverse linear-distance for field strength measurements; inverse-linear-distance-squared for power density measurements).

(2) At frequencies below 30 MHz, measurements may be performed at a distance closer than that specified in the regulations; however, an attempt should be made to avoid making measurements in the near field. Pending the development of an appropriate measurement procedure for measurements performed below 30 MHz, when performing measurements at a closer distance than specified, the results shall be extrapolated to the specified distance by either making measurements at a minimum of two distances on at least one radial to determine the proper extrapolation factor or by using the square of an inverse linear distance extrapolation factor (40 dB/decade). This paragraph (f) shall not apply to Access BPL devices operating below 30 MHz.



ISED General field strength limits at frequencies below 30 MHz

Table 6 – General field strength limits at frequencies below 30 MHz		
Frequency	Magnetic field strength (H-Field) (µA/m)	Measurement distance (m)
9 - 490 kHz <sup>Note 1</sup>	6.37/F (F in kHz)	300
490 - 1705 kHz	63.7/F (F in kHz)	30
1.705 - 30 MHz	0.08	30

**Note 1:** The emission limits for the ranges 9-90 kHz and 110-490 kHz are based on measurements employing a linear average detector.

IC Restricted bands please refer to ISED RSS-GEN Clause 8.10.  
FCC Restricted bands please refer to CFR 47 FCC 15.209.

Radiated emissions which fall in the restricted bands must comply with the radiated emission limits specified as below table.

LIMITS OF RADIATED EMISSION MEASUREMENT (Below 1GHz)			
Frequency Range (MHz)	Field Strength Limit (uV/m) at 3 m	Field Strength Limit (dBuV/m) at 3 m	
		Quasi-Peak	
30 - 88	100	40	
88 - 216	150	43.5	
216 - 960	200	46	
Above 960	500	54	
Above 1000	500	Peak	Average
		74	54

Limits of unwanted emission out of the restricted bands

LIMITS OF RADIATED EMISSION MEASUREMENT ( Above 1GHz)		
Frequency Range (MHz)	EIRP Limit	Field Strength Limit (dBuV/m) at 3 m
5150~5250 MHz	PK:-27 (dBm/MHz)	PK:68.2(dBµV/m)
5250~5350 MHz		
5470~5725 MHz		
5725~5850 MHz	PK:-27 (dBm/MHz) *1 PK:10 (dBm/MHz) *2 PK:15.6 (dBm/MHz) *3 PK:27 (dBm/MHz) *4	PK: 68.2(dBµV/m) *1 PK:105.2 (dBµV/m) *2 PK: 110.8(dBµV/m) *3 PK:122.2 (dBµV/m) *4

**Note:**  
 \*1 beyond 75 MHz or more above of the band edge.  
 \*2 below the band edge increasing linearly to 10 dBm/MHz at 25 MHz above.  
 \*3 below the band edge increasing linearly to a level of 15.6 dBm/MHz at 5 MHz above.  
 \*4 from 5 MHz above or below the band edge increasing linearly to a level of 27 dBm/MHz at the band edge.

## TEST SETUP AND PROCEDURE

Below 30MHz

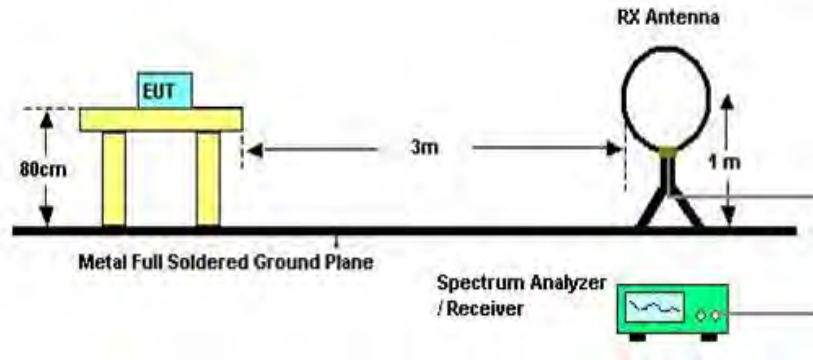

The setting of the spectrum analyser

RBW	200Hz (From 9kHz to 0.15MHz)/ 9kHz (From 0.15MHz to 30MHz)
VBW	200Hz (From 9kHz to 0.15MHz)/ 9kHz (From 0.15MHz to 30MHz)
Sweep	Auto
Detector	Peak/QP/ Average
Trace	Max hold

1. The testing follows the guidelines in ANSI C63.10-2013
2. The EUT was arranged to its worst case and then turntable (from 0 degree to 360 degrees) to find the maximum reading. A pre-amp and a high pass filter are used for the test in order to get better signal level. Both Horizontal, Face-on and Face-off polarizations of the antenna are set to make the measurement.
3. The EUT was placed on a turntable with 0.8 meter above ground.
4. The EUT was set 3 meters from the interference receiving antenna, which was mounted on the top of a variable height antenna tower.
5. For measurement below 1GHz, the initial step in collecting conducted emission data is a spectrum analyzer peak detector mode pre-scanning the measurement frequency range. Significant peaks are then marked and then Quasi Peak detector mode re-measured. If the emission level of the EUT measured by the peak detector is 3 dB lower than the applicable limit, the peak emission level will be reported. Otherwise, the emission measurement will be repeated using the quasi-peak detector and reported.
6. Although these tests were performed other than open field site, adequate comparison measurements were confirmed against 30m open field site. Therefore sufficient tests were made to demonstrate that the alternative site produces results that correlate with the ones of tests made in an open field site based on KDB 414788.

Below 1G

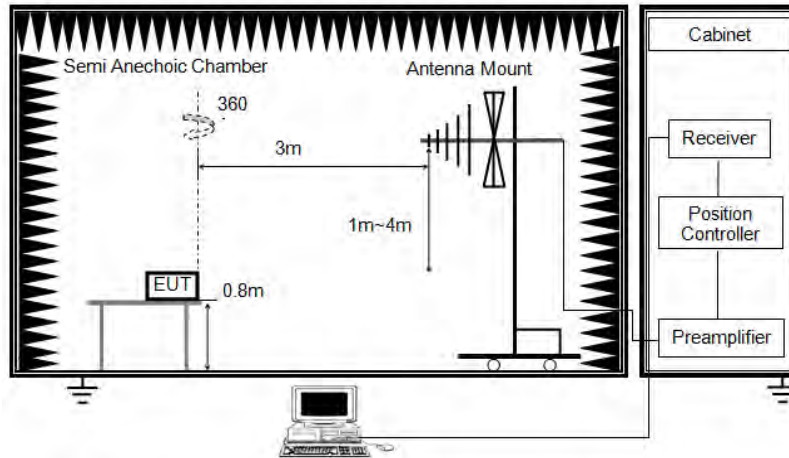

The setting of the spectrum analyser

RBW	120kHz
VBW	300kHz
Sweep	Auto
Detector	Peak/QP
Trace	Max hold

1. The testing follows the guidelines in ANSI C63.10-2013.
2. The EUT was arranged to its worst case and then tune the antenna tower (from 1 m to 4 m) and turntable (from 0 degree to 360 degrees) to find the maximum reading. A pre-amp and a high pass filter are used for the test in order to get better signal level. Both horizontal and vertical polarizations of the antenna are set to make the measurement.
3. The EUT was placed on a turntable with 0.8 meter above ground.
4. The EUT was set 3 meters from the interference receiving antenna, which was mounted on the top of a variable height antenna tower.
5. For measurement below 1GHz, the initial step in collecting conducted emission data is a spectrum analyzer peak detector mode pre-scanning the measurement frequency range. Significant peaks are then marked and then Quasi Peak detector mode re-measured. If the emission level of the EUT measured by the peak detector is 3 dB lower than the applicable limit, the peak emission level will be reported. Otherwise, the emission measurement will be repeated using the quasi-peak detector and reported.



Above 1G

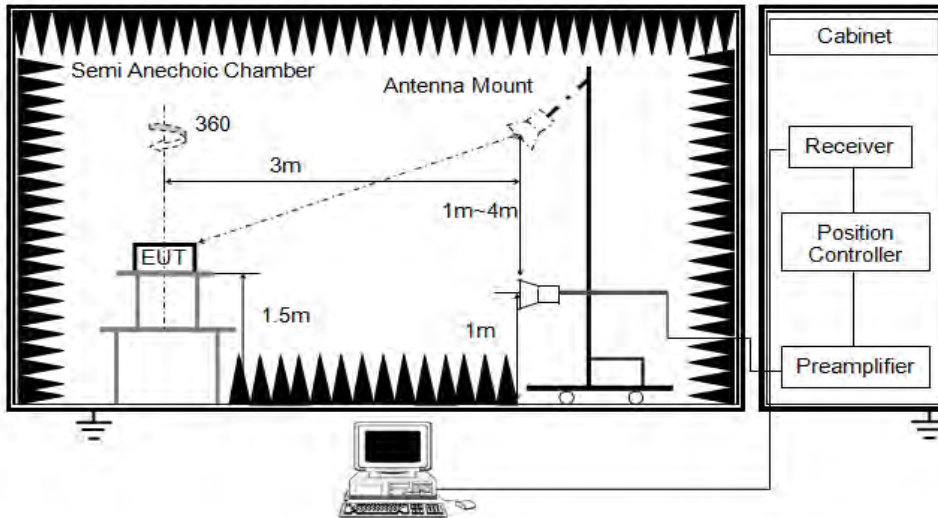

The setting of the spectrum analyser

RBW	1MHz
VBW	PEAK: 3MHz AVG: see note 6
Sweep	Auto
Detector	Peak
Trace	Max hold

1. The testing follows the guidelines in ANSI C63.10-2013.
2. The EUT was arranged to its worst case and then tune the antenna tower (from 1 m to 4 m) and turntable (from 0 degree to 360 degrees) to find the maximum reading. A pre-amp and a high pass filter are used for the test in order to get better signal level. Both horizontal and vertical polarizations of the antenna are set to make the measurement.
3. The EUT was placed on a turntable with 1.5m above ground.
4. The EUT was set 3 meters from the interference receiving antenna, which was mounted on the top of a variable height antenna tower.
5. For measurement above 1GHz, the emission measurement will be measured by the peak detector. This peak level, once corrected, must comply with the limit specified in Section 15.209.
6. For measurements above 1 GHz the resolution bandwidth is set to 1 MHz, then the video bandwidth is set to 3 MHz for peak measurements and 1 MHz resolution bandwidth with 1/T video bandwidth with peak detector for average measurements. For the Duty Cycle please refer to clause 7.1.ON TIME AND DUTY CYCLE.

X axis, Y axis, Z axis positions:

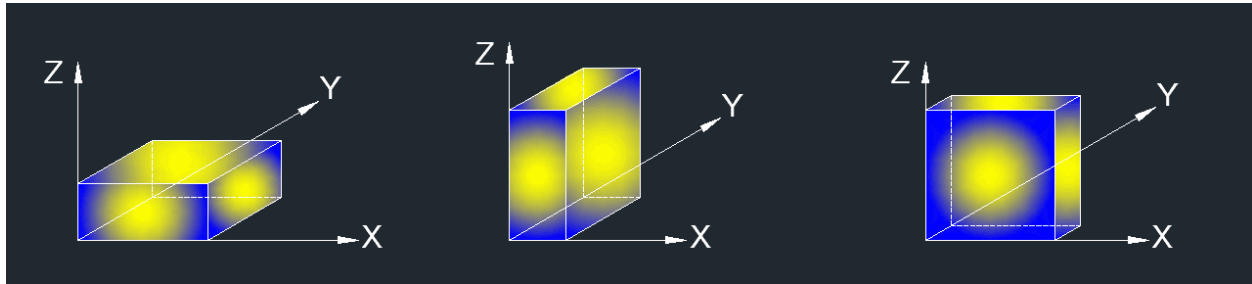

Note 1: For all radiated test, EUT in each of three orthogonal axis emissions had been tested, but only the worst case (X axis) data recorded in the report.

Note 2: All the EUT's emissions had been evaluated for simultaneous transmission with the other WIFI 2.4GHz, WIFI 5GHz and BT transmitter and there were no any additional or worse emissions found. The worst case data has been recorded in the WIFI test report. (4789476783-3/-4).

**TEST ENVIRONMENT**

Temperature	24.7°C	Relative Humidity	61%
Atmosphere Pressure	101kPa	Test Voltage	DC 3.3V



**8.1. 802.11a 20 MODE**

**8.1.1. UNII-1 BAND  
WORST CASE FOR ANT1**

**RESTRICTED BANDEDGE LOW CHANNEL**

**HORIZONTAL RESULTS  
PEAK**

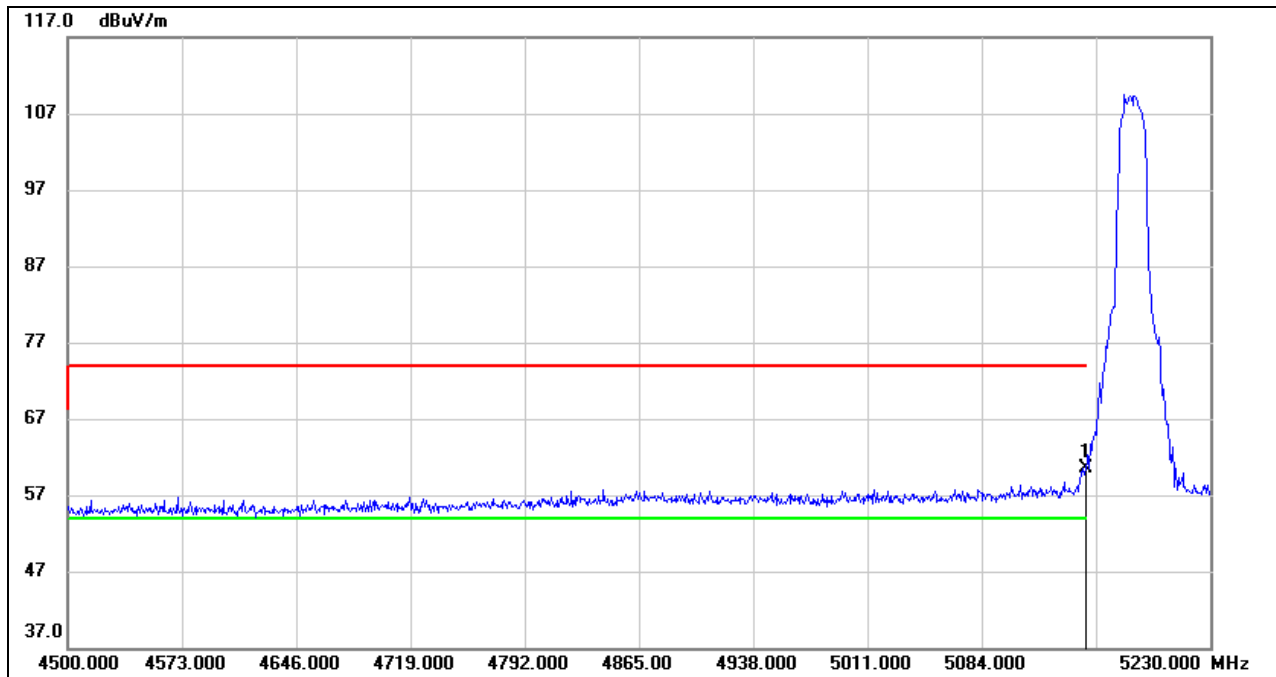

No.	Frequency (MHz)	Reading (dBuV)	Correct (dB/m)	Result (dBuV/m)	Limit (dBuV/m)	Margin (dB)	Remark
1	5150.000	20.01	40.46	60.47	74.00	-13.53	peak

- Note: 1. Measurement = Reading Level + Correct Factor.  
 2. If Peak Result complies with AV limit, AV Result is deemed to comply with AV limit.  
 3. Peak: Peak detector.  
 4. Only the worst case emission will be recorder, if it complies with the limit, the other emissions deemed to comply with the limit.



**AVG**

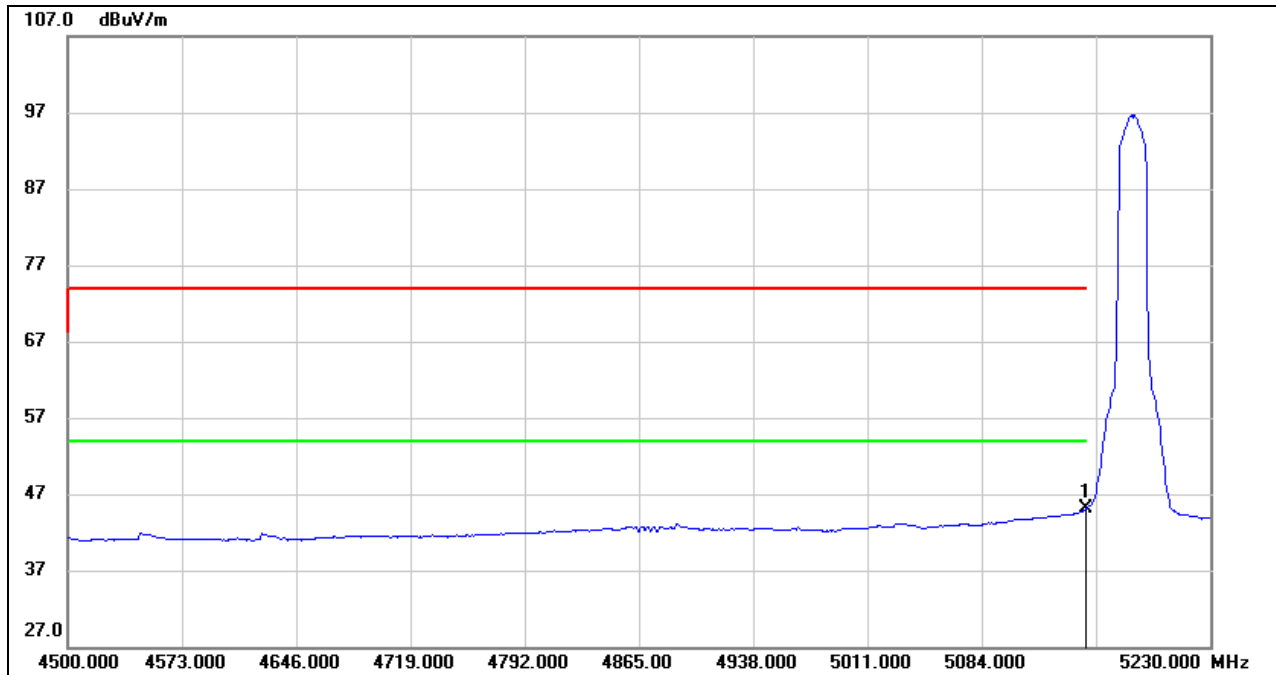

No.	Frequency (MHz)	Reading (dBuV)	Correct (dB/m)	Result (dBuV/m)	Limit (dBuV/m)	Margin (dB)	Remark
1	5150.000	4.60	40.46	45.06	54.00	-8.94	AVG

- Note: 1. Measurement = Reading Level + Correct Factor.  
 2. AVG: VBW=1/Ton where: ton is transmit duration.  
 3. For duty cycle, please refer to clause 7.1.  
 4. Only the worst case emission will be recorder, if it complies with the limit, the other emissions deemed to comply with the limit.



**VERTICAL RESULTS**  
**PEAK**

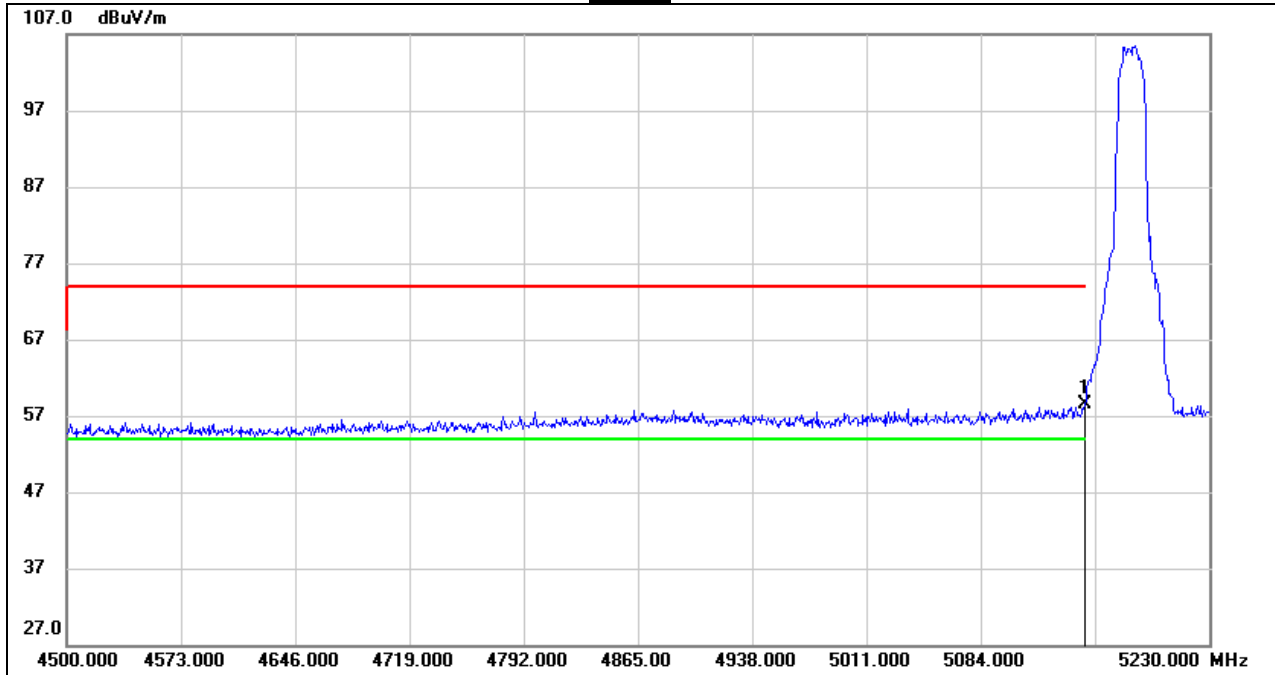

No.	Frequency (MHz)	Reading (dBuV)	Correct (dB/m)	Result (dBuV/m)	Limit (dBuV/m)	Margin (dB)	Remark
1	5150.000	18.00	40.46	58.46	74.00	-15.54	peak

- Note: 1. Measurement = Reading Level + Correct Factor.  
 2. If Peak Result complies with AV limit, AV Result is deemed to comply with AV limit.  
 3. Peak: Peak detector.  
 4. Only the worst case emission will be recorder, if it complies with the limit, the other emissions deemed to comply with the limit.



**AVG**

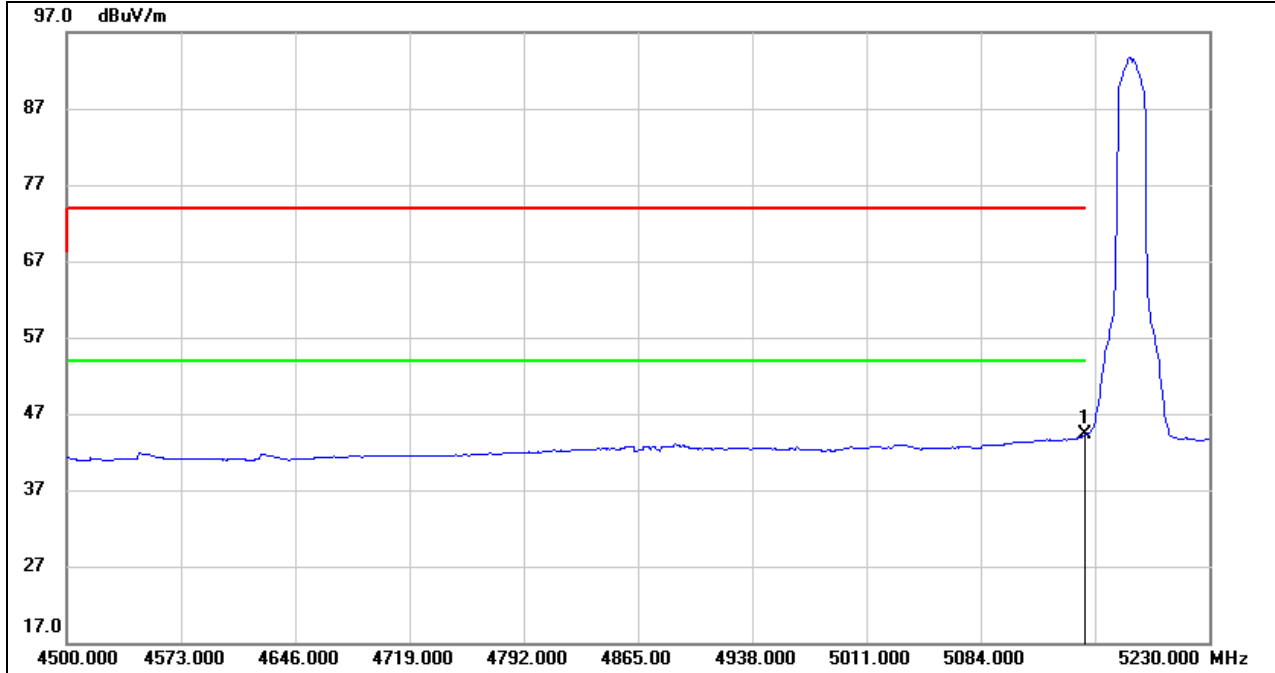

No.	Frequency (MHz)	Reading (dBuV)	Correct (dB/m)	Result (dBuV/m)	Limit (dBuV/m)	Margin (dB)	Remark
1	5150.000	3.75	40.46	44.21	54.00	-9.79	AVG

- Note:
1. Measurement = Reading Level + Correct Factor.
  2. AVG: VBW=1/Ton where: ton is transmit duration.
  3. For duty cycle, please refer to clause 7.1.
  4. Only the worst case emission will be recorder, if it complies with the limit, the other emissions deemed to comply with the limit.



**HARMONICS AND SPURIOUS EMISSIONS LOW CHANNEL**

**HORIZONTAL RESULTS**  
**1-7GHz**

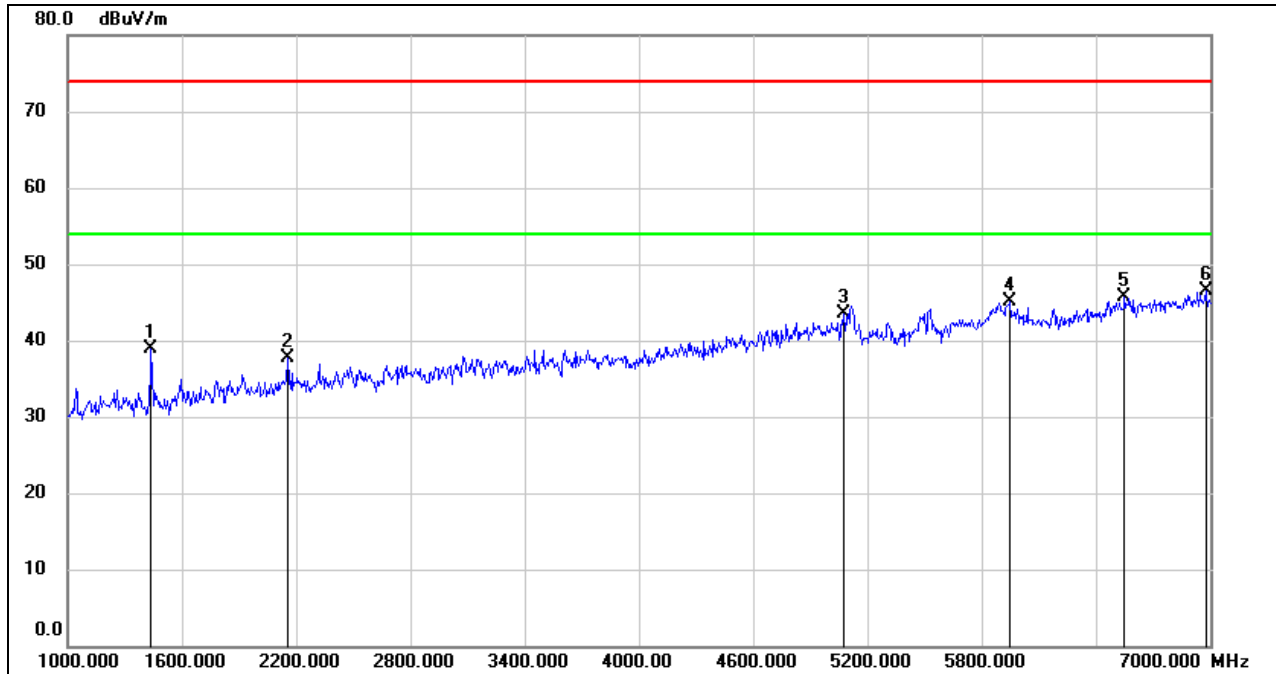

No.	Frequency (MHz)	Reading (dBuV)	Correct (dB/m)	Result (dBuV/m)	Limit (dBuV/m)	Margin (dB)	Remark
1	1438.000	51.91	-12.99	38.92	74.00	-35.08	peak
2	2158.000	47.56	-9.83	37.73	74.00	-36.27	peak
3	5074.000	42.73	0.75	43.48	74.00	-30.52	peak
4	5950.000	41.58	3.47	45.05	74.00	-28.95	peak
5	6550.000	40.85	4.76	45.61	74.00	-28.39	peak
6	6976.000	41.27	5.25	46.52	74.00	-27.48	peak

Note: 1. Measurement = Reading Level + Correct Factor.  
 2. If Peak Result complies with AV limit, AV Result is deemed to comply with AV limit.  
 3. Peak: Peak detector.  
 4. Filter losses were only considered in the spurious frequency bands and the authorized band was not corrected for Band reject filter losses.  
 5. Proper operation of the transmitter prior to adding the filter to the measurement chain.  
 6. Owing to the highest peak level of unwanted emission out of the restricted bands complies with the lowest limit(54dBuV/m), so all the test point was deemed to comply with the limits list in the standard.



**7-18GHz**

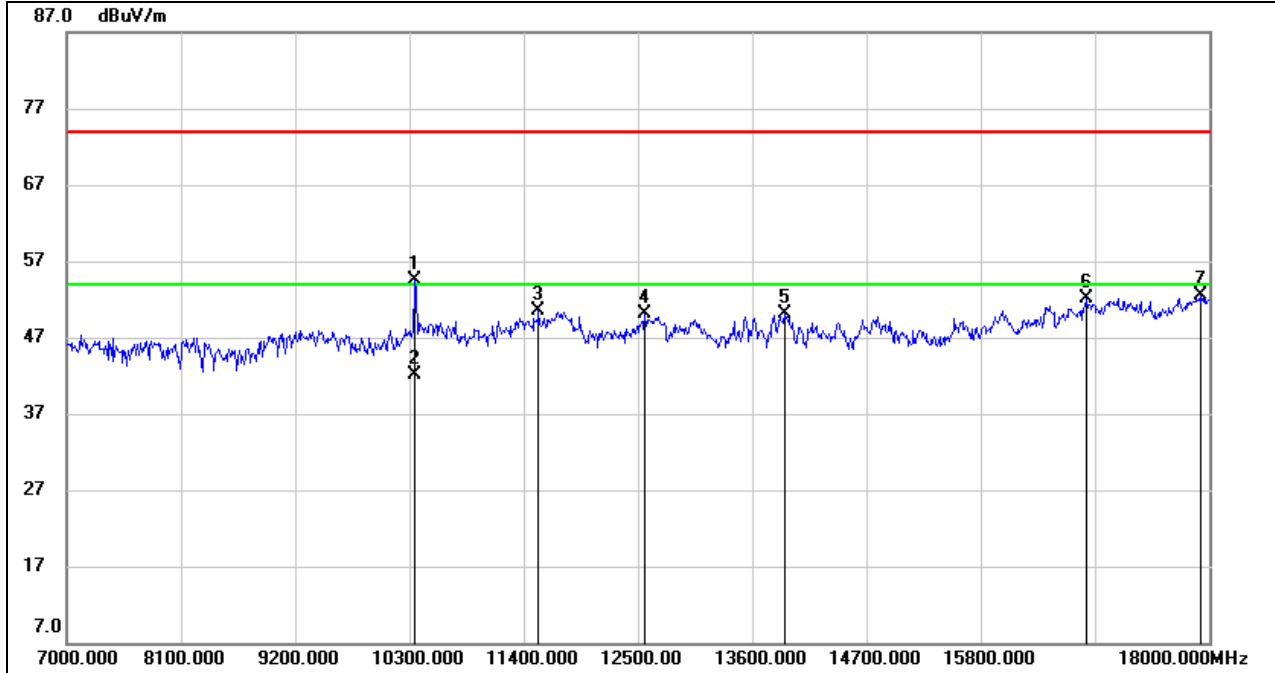

No.	Frequency (MHz)	Reading (dBuV)	Correct (dB/m)	Result (dBuV/m)	Limit (dBuV/m)	Margin (dB)	Remark
1	10357.997	43.53	10.94	54.47	74.00	-19.53	peak
2	10357.997	31.10	10.94	42.04	54.00	-11.96	AVG
3	11543.000	36.91	13.63	50.54	74.00	-23.46	peak
4	12566.000	34.92	15.10	50.02	74.00	-23.98	peak
5	13908.000	33.80	16.26	50.06	74.00	-23.94	peak
6	16823.000	32.00	20.17	52.17	74.00	-21.83	peak
7	17923.000	28.97	23.61	52.58	74.00	-21.42	peak

Note: 1. Measurement = Reading Level + Correct Factor.  
 2. If Peak Result complies with AV limit, AV Result is deemed to comply with AV limit.  
 3. Peak: Peak detector.  
 4. Filter losses were only considered in the spurious frequency bands and the authorized band was not corrected for HPF losses.  
 5. Proper operation of the transmitter prior to adding the filter to the measurement chain.  
 6. Owing to the highest peak level of unwanted emission out of the restricted bands complies with the lowest limit(54dBuV/m), so all the test point was deemed to comply with the limits list in the standard.





**VERTICAL RESULTS**  
**1-7GHz**

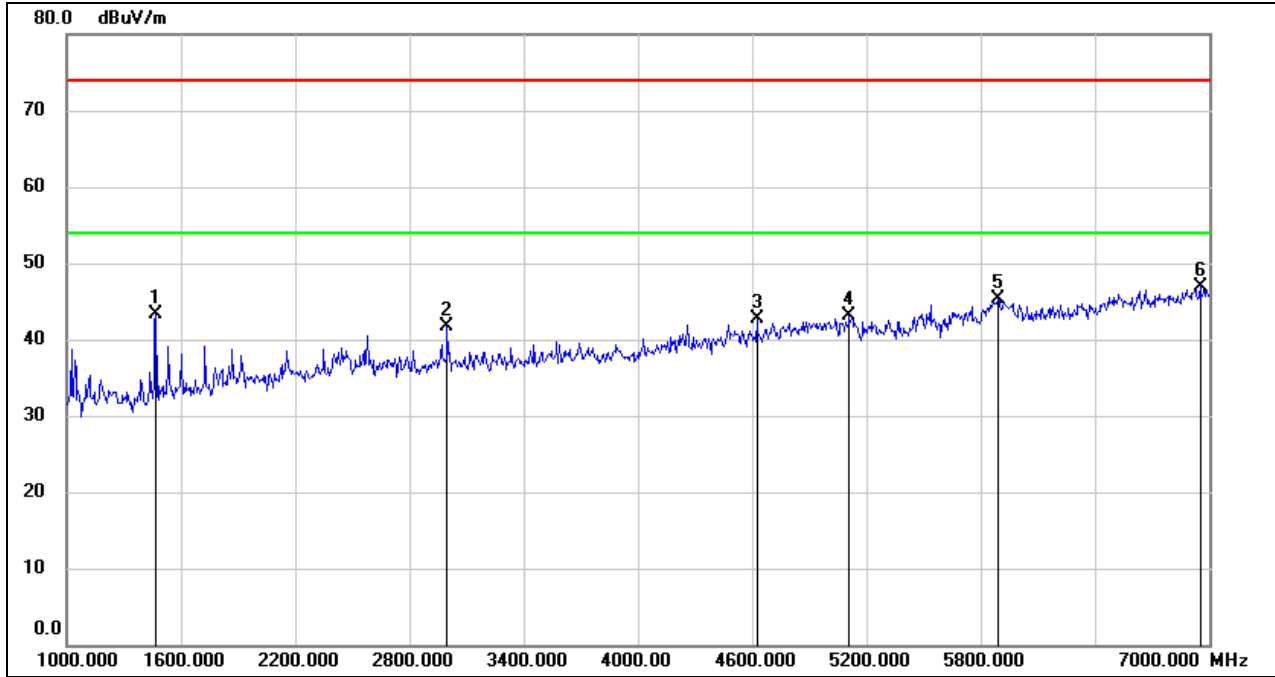

No.	Frequency (MHz)	Reading (dBuV)	Correct (dB/m)	Result (dBuV/m)	Limit (dBuV/m)	Margin (dB)	Remark
1	1468.000	56.27	-12.93	43.34	74.00	-30.66	peak
2	2998.000	47.91	-6.29	41.62	74.00	-32.38	peak
3	4624.000	44.07	-1.42	42.65	74.00	-31.35	peak
4	5110.000	42.36	0.81	43.17	74.00	-30.83	peak
5	5890.000	41.07	4.15	45.22	74.00	-28.78	peak
6	6952.000	41.77	5.23	47.00	74.00	-27.00	peak

Note: 1. Measurement = Reading Level + Correct Factor.  
 2. If Peak Result complies with AV limit, AV Result is deemed to comply with AV limit.  
 3. Peak: Peak detector.  
 4. Filter losses were only considered in the spurious frequency bands and the authorized band was not corrected for Band reject filter losses.  
 5. Proper operation of the transmitter prior to adding the filter to the measurement chain.  
 6. Owing to the highest peak level of unwanted emission out of the restricted bands complies with the lowest limit(54dBuV/m), so all the test point was deemed to comply with the limits list in the standard.



**7-18GHz**

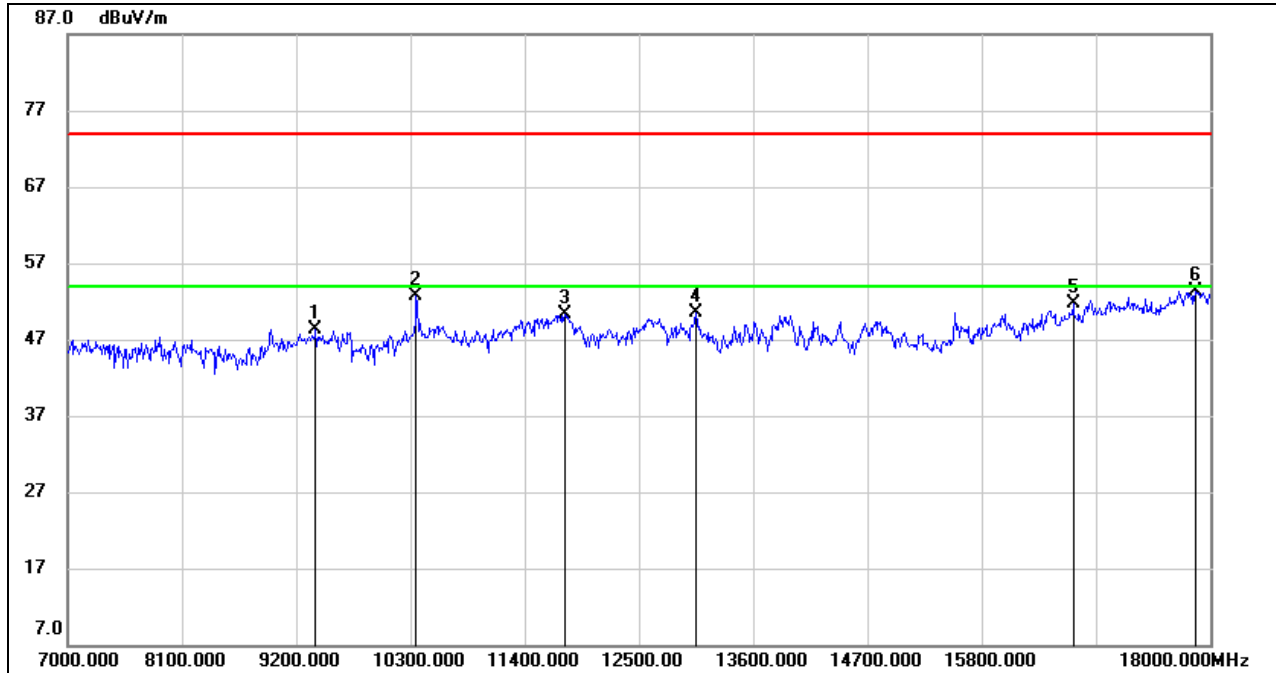

No.	Frequency (MHz)	Reading (dBuV)	Correct (dB/m)	Result (dBuV/m)	Limit (dBuV/m)	Margin (dB)	Remark
1	9387.000	38.33	9.94	48.27	74.00	-25.73	peak
2	10355.000	41.84	10.94	52.78	74.00	-21.22	peak
3	11785.000	35.83	14.47	50.30	74.00	-23.70	peak
4	13050.000	34.95	15.55	50.50	74.00	-23.50	peak
5	16680.000	31.75	20.01	51.76	74.00	-22.24	peak
6	17857.000	29.70	23.55	53.25	74.00	-20.75	peak

Note: 1. Measurement = Reading Level + Correct Factor.  
 2. If Peak Result complies with AV limit, AV Result is deemed to comply with AV limit.  
 3. Peak: Peak detector.  
 4. Filter losses were only considered in the spurious frequency bands and the authorized band was not corrected for HPF losses.  
 5. Proper operation of the transmitter prior to adding the filter to the measurement chain.  
 6. Owing to the highest peak level of unwanted emission out of the restricted bands complies with the lowest limit(54dBuV/m), so all the test point was deemed to comply with the limits list in the standard.



**HARMONICS AND SPURIOUS EMISSIONS MID CHANNEL**

**HORIZONTAL RESULTS**  
**1-7GHz**

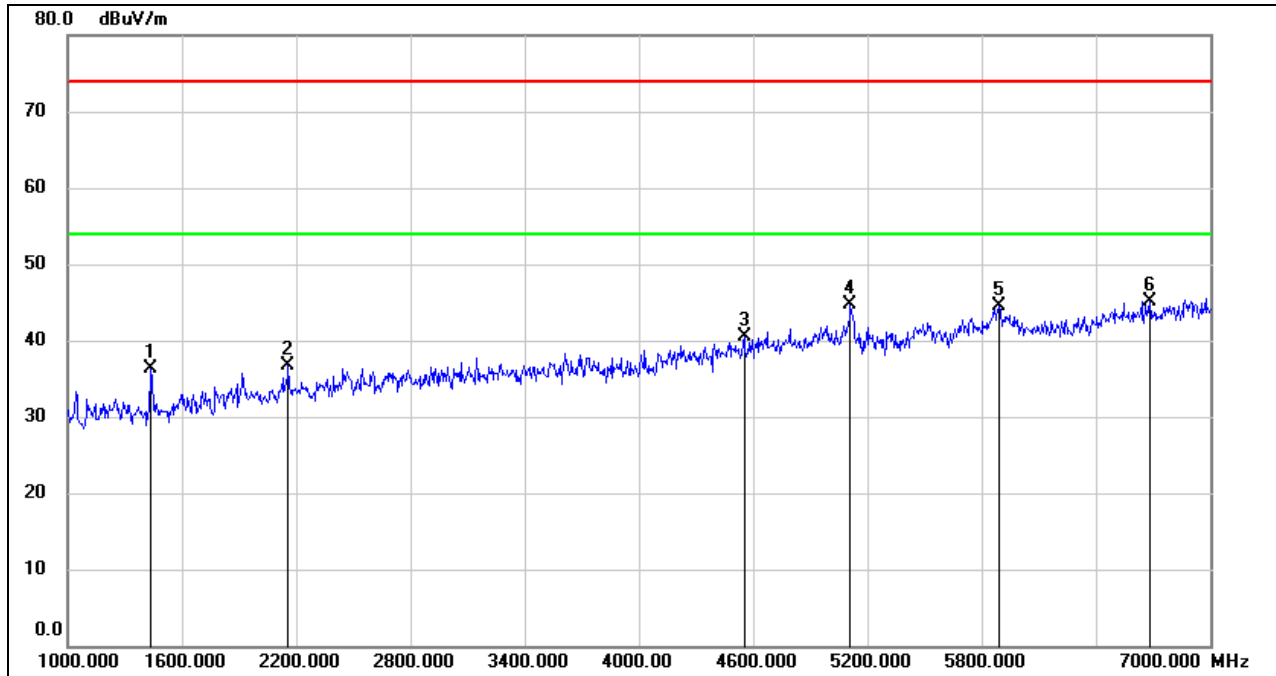

No.	Frequency (MHz)	Reading (dBuV)	Correct (dB/m)	Result (dBuV/m)	Limit (dBuV/m)	Margin (dB)	Remark
1	1438.000	49.24	-12.99	36.25	74.00	-37.75	peak
2	2158.000	46.54	-9.83	36.71	74.00	-37.29	peak
3	4552.000	42.10	-1.68	40.42	74.00	-33.58	peak
4	5110.000	43.83	0.81	44.64	74.00	-29.36	peak
5	5890.000	40.40	4.15	44.55	74.00	-29.45	peak
6	6682.000	40.54	4.59	45.13	74.00	-28.87	peak

Note: 1. Measurement = Reading Level + Correct Factor.  
 2. If Peak Result complies with AV limit, AV Result is deemed to comply with AV limit.  
 3. Peak: Peak detector.  
 4. Filter losses were only considered in the spurious frequency bands and the authorized band was not corrected for Band reject filter losses.  
 5. Proper operation of the transmitter prior to adding the filter to the measurement chain.  
 6. Owing to the highest peak level of unwanted emission out of the restricted bands complies with the lowest limit(54dBuV/m), so all the test point was deemed to comply with the limits list in the standard.



**7-18GHz**

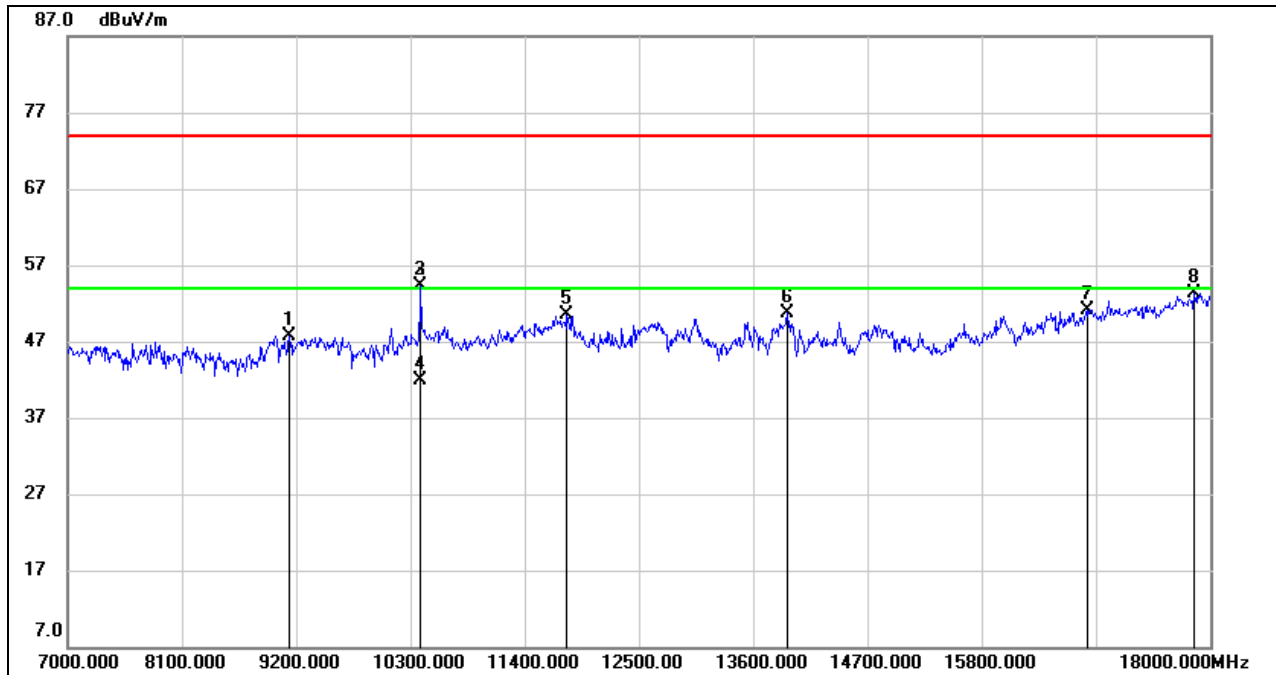

No.	Frequency (MHz)	Reading (dBuV)	Correct (dB/m)	Result (dBuV/m)	Limit (dBuV/m)	Margin (dB)	Remark
1	9134.000	38.25	9.46	47.71	74.00	-26.29	peak
2	10399.000	43.12	11.11	54.23	74.00	-19.77	peak
3	10400.049	43.12	11.11	54.23	74.00	-19.77	peak
4	10400.049	30.76	11.11	41.87	54.00	-12.13	AVG
5	11807.000	36.04	14.52	50.56	74.00	-23.44	peak
6	13930.000	34.37	16.24	50.61	74.00	-23.39	peak
7	16812.000	30.99	20.14	51.13	74.00	-22.87	peak
8	17846.000	29.68	23.54	53.22	74.00	-20.78	peak

Note: 1. Measurement = Reading Level + Correct Factor.  
 2. If Peak Result complies with AV limit, AV Result is deemed to comply with AV limit.  
 3. Peak: Peak detector.  
 4. Filter losses were only considered in the spurious frequency bands and the authorized band was not corrected for HPF losses.  
 5. Proper operation of the transmitter prior to adding the filter to the measurement chain.  
 6. Owing to the highest peak level of unwanted emission out of the restricted bands complies with the lowest limit(54dBuV/m), so all the test point was deemed to comply with the limits list in the standard.



**VERTICAL RESULTS**  
**1-7GHz**

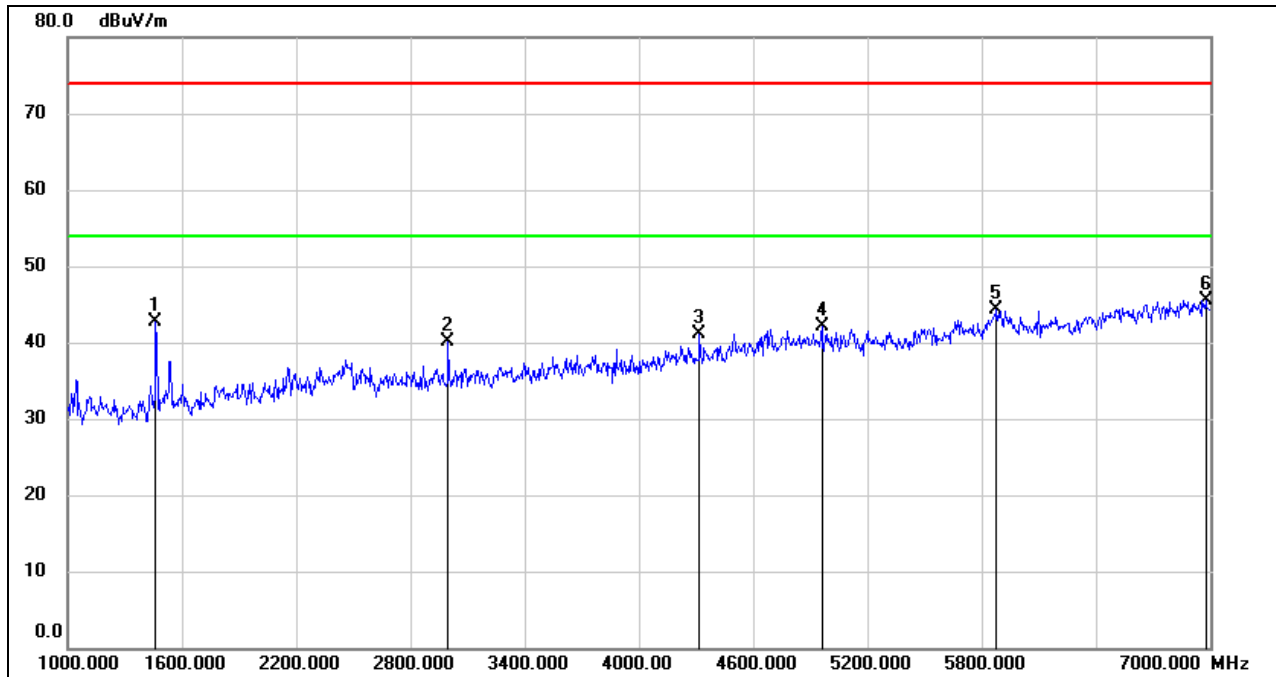

No.	Frequency (MHz)	Reading (dBuV)	Correct (dB/m)	Result (dBuV/m)	Limit (dBuV/m)	Margin (dB)	Remark
1	1462.000	55.66	-12.94	42.72	74.00	-31.28	peak
2	2998.000	46.44	-6.29	40.15	74.00	-33.85	peak
3	4318.000	44.10	-3.05	41.05	74.00	-32.95	peak
4	4960.000	41.78	0.37	42.15	74.00	-31.85	peak
5	5878.000	40.46	3.92	44.38	74.00	-29.62	peak
6	6976.000	40.30	5.25	45.55	74.00	-28.45	peak

Note: 1. Measurement = Reading Level + Correct Factor.  
 2. If Peak Result complies with AV limit, AV Result is deemed to comply with AV limit.  
 3. Peak: Peak detector.  
 4. Filter losses were only considered in the spurious frequency bands and the authorized band was not corrected for Band reject filter losses.  
 5. Proper operation of the transmitter prior to adding the filter to the measurement chain.  
 6. Owing to the highest peak level of unwanted emission out of the restricted bands complies with the lowest limit(54dBuV/m), so all the test point was deemed to comply with the limits list in the standard.



**7-18GHz**

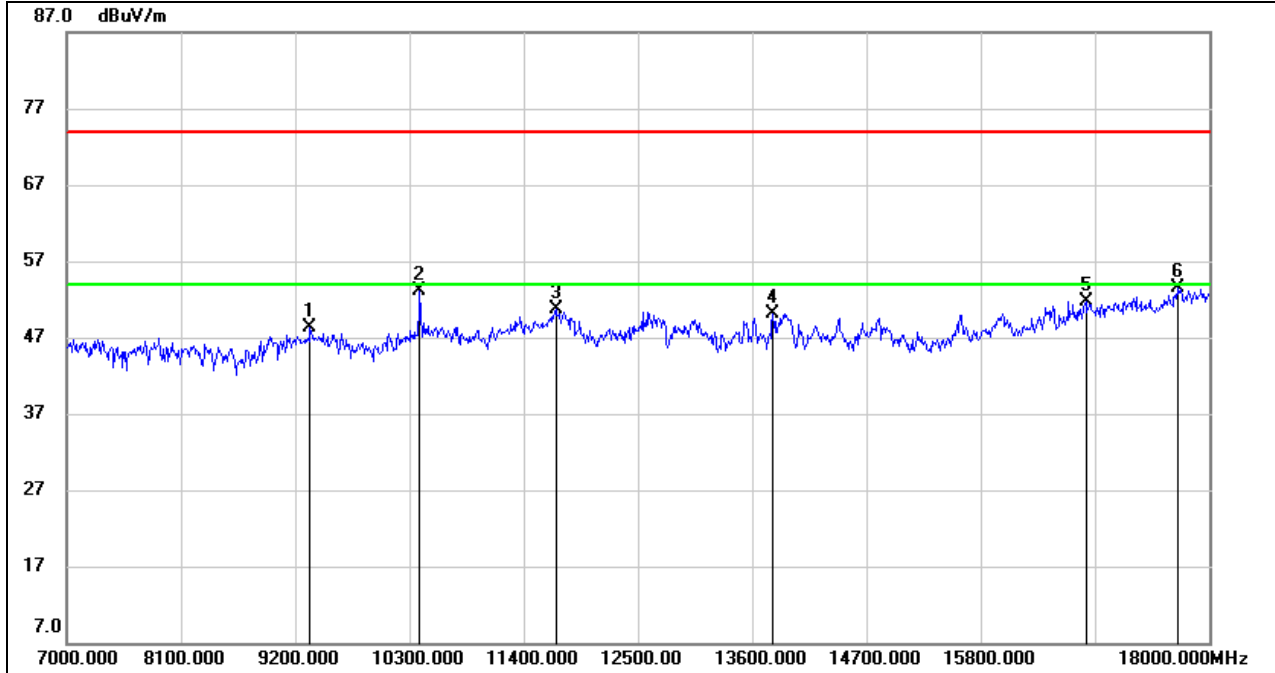

No.	Frequency (MHz)	Reading (dBuV)	Correct (dB/m)	Result (dBuV/m)	Limit (dBuV/m)	Margin (dB)	Remark
1	9343.000	38.49	9.73	48.22	74.00	-25.78	peak
2	10399.000	41.97	11.11	53.08	74.00	-20.92	peak
3	11708.000	36.49	14.16	50.65	74.00	-23.35	peak
4	13798.000	33.73	16.44	50.17	74.00	-23.83	peak
5	16812.000	31.57	20.14	51.71	74.00	-22.29	peak
6	17692.000	30.81	22.69	53.50	74.00	-20.50	peak

Note: 1. Measurement = Reading Level + Correct Factor.  
 2. If Peak Result complies with AV limit, AV Result is deemed to comply with AV limit.  
 3. Peak: Peak detector.  
 4. Filter losses were only considered in the spurious frequency bands and the authorized band was not corrected for HPF losses.  
 5. Proper operation of the transmitter prior to adding the filter to the measurement chain.  
 6. Owing to the highest peak level of unwanted emission out of the restricted bands complies with the lowest limit(54dBuV/m), so all the test point was deemed to comply with the limits list in the standard.



**HARMONICS AND SPURIOUS EMISSIONS HIGH CHANNEL**

**HORIZONTAL RESULTS**  
**1-7GHz**

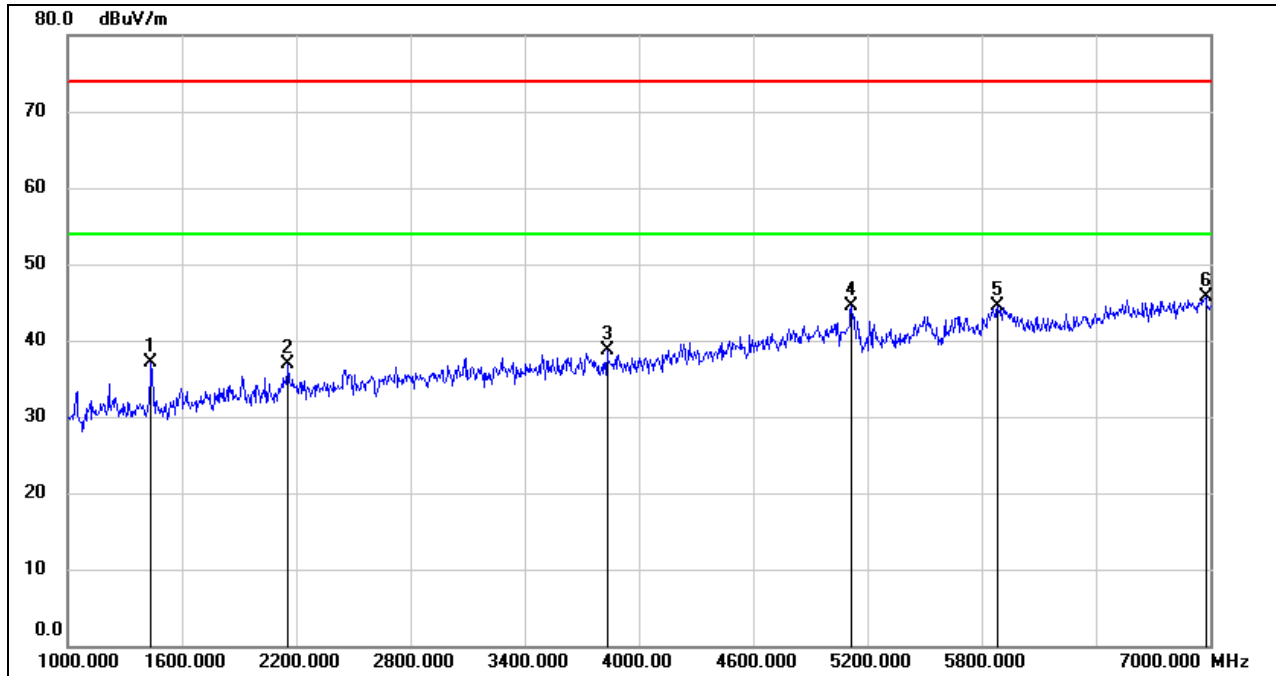

No.	Frequency (MHz)	Reading (dBuV)	Correct (dB/m)	Result (dBuV/m)	Limit (dBuV/m)	Margin (dB)	Remark
1	1438.000	50.05	-12.99	37.06	74.00	-36.94	peak
2	2158.000	46.74	-9.83	36.91	74.00	-37.09	peak
3	3832.000	43.04	-4.29	38.75	74.00	-35.25	peak
4	5116.000	43.63	0.86	44.49	74.00	-29.51	peak
5	5884.000	40.47	4.03	44.50	74.00	-29.50	peak
6	6976.000	40.38	5.25	45.63	74.00	-28.37	peak

Note: 1. Measurement = Reading Level + Correct Factor.  
 2. If Peak Result complies with AV limit, AV Result is deemed to comply with AV limit.  
 3. Peak: Peak detector.  
 4. Filter losses were only considered in the spurious frequency bands and the authorized band was not corrected for Band reject filter losses.  
 5. Proper operation of the transmitter prior to adding the filter to the measurement chain.  
 6. Owing to the highest peak level of unwanted emission out of the restricted bands complies with the lowest limit(54dBuV/m), so all the test point was deemed to comply with the limits list in the standard.



**7-18GHz**

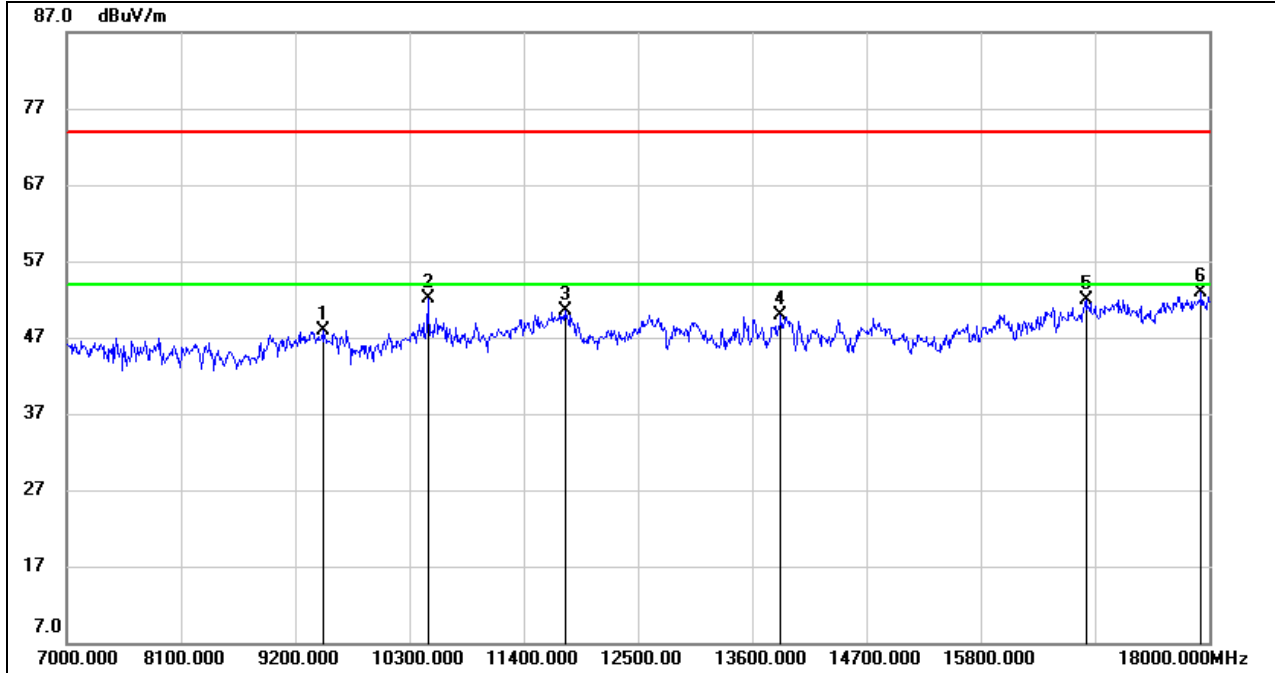

No.	Frequency (MHz)	Reading (dBuV)	Correct (dB/m)	Result (dBuV/m)	Limit (dBuV/m)	Margin (dB)	Remark
1	9464.000	37.60	10.21	47.81	74.00	-26.19	peak
2	10476.000	40.72	11.44	52.16	74.00	-21.84	peak
3	11796.000	35.99	14.52	50.51	74.00	-23.49	peak
4	13875.000	33.60	16.33	49.93	74.00	-24.07	peak
5	16812.000	31.78	20.14	51.92	74.00	-22.08	peak
6	17923.000	29.26	23.61	52.87	74.00	-21.13	peak

Note: 1. Measurement = Reading Level + Correct Factor.  
 2. If Peak Result complies with AV limit, AV Result is deemed to comply with AV limit.  
 3. Peak: Peak detector.  
 4. Filter losses were only considered in the spurious frequency bands and the authorized band was not corrected for HPF losses.  
 5. Proper operation of the transmitter prior to adding the filter to the measurement chain.  
 6. Owing to the highest peak level of unwanted emission out of the restricted bands complies with the lowest limit(54dBuV/m), so all the test point was deemed to comply with the limits list in the standard.





**VERTICAL RESULTS**  
**1-7GHz**

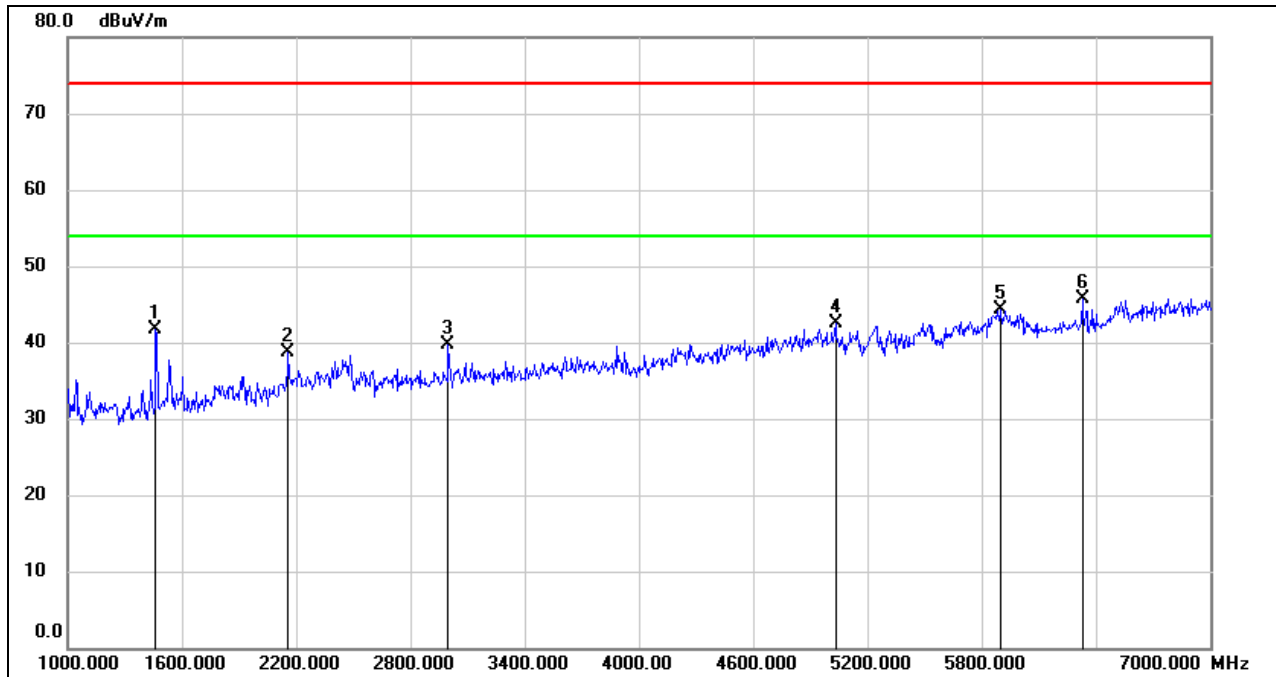

No.	Frequency (MHz)	Reading (dBuV)	Correct (dB/m)	Result (dBuV/m)	Limit (dBuV/m)	Margin (dB)	Remark
1	1462.000	54.70	-12.94	41.76	74.00	-32.24	peak
2	2158.000	48.56	-9.83	38.73	74.00	-35.27	peak
3	2998.000	46.09	-6.29	39.80	74.00	-34.20	peak
4	5032.000	41.70	0.73	42.43	74.00	-31.57	peak
5	5896.000	40.04	4.25	44.29	74.00	-29.71	peak
6	6328.000	42.21	3.41	45.62	74.00	-28.38	peak

Note: 1. Measurement = Reading Level + Correct Factor.  
 2. If Peak Result complies with AV limit, AV Result is deemed to comply with AV limit.  
 3. Peak: Peak detector.  
 4. Filter losses were only considered in the spurious frequency bands and the authorized band was not corrected for Band reject filter losses.  
 5. Proper operation of the transmitter prior to adding the filter to the measurement chain.  
 6. Owing to the highest peak level of unwanted emission out of the restricted bands complies with the lowest limit(54dBuV/m), so all the test point was deemed to comply with the limits list in the standard.



**7-18GHz**

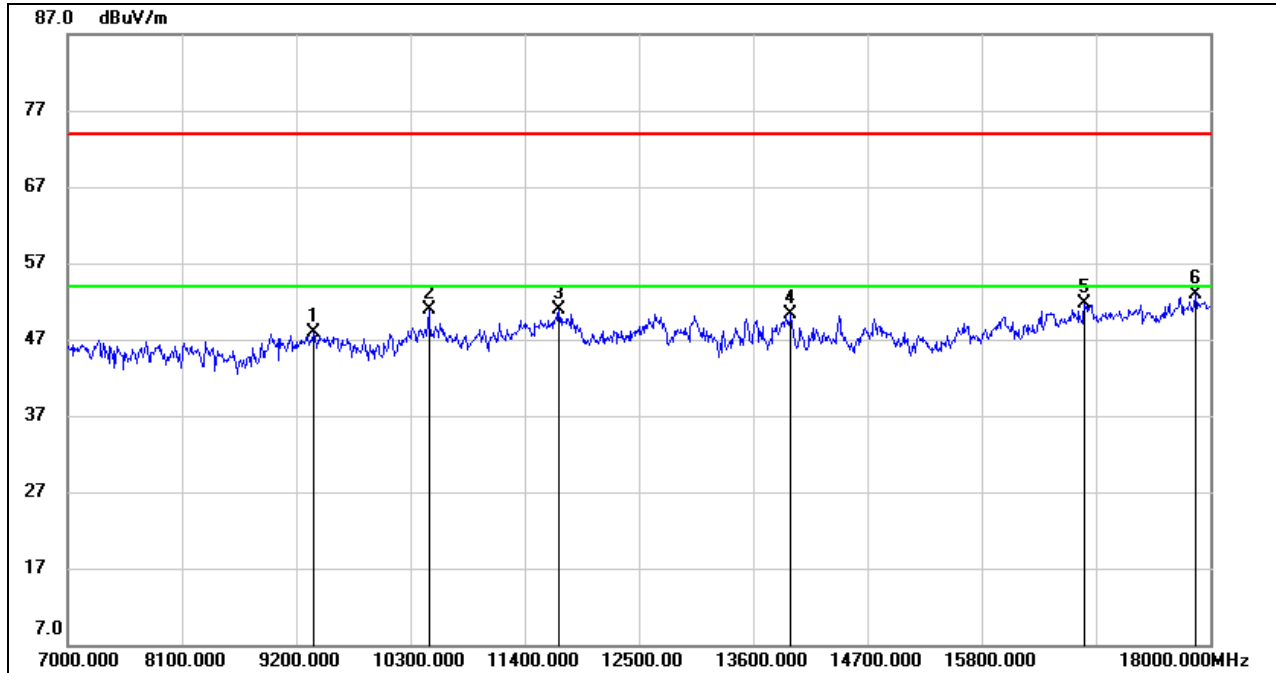

No.	Frequency (MHz)	Reading (dBuV)	Correct (dB/m)	Result (dBuV/m)	Limit (dBuV/m)	Margin (dB)	Remark
1	9365.000	38.12	9.84	47.96	74.00	-26.04	peak
2	10476.000	39.49	11.44	50.93	74.00	-23.07	peak
3	11730.000	36.62	14.25	50.87	74.00	-23.13	peak
4	13963.000	34.18	16.17	50.35	74.00	-23.65	peak
5	16790.000	31.67	20.11	51.78	74.00	-22.22	peak
6	17857.000	29.43	23.55	52.98	74.00	-21.02	peak

Note: 1. Measurement = Reading Level + Correct Factor.  
 2. If Peak Result complies with AV limit, AV Result is deemed to comply with AV limit.  
 3. Peak: Peak detector.  
 4. Filter losses were only considered in the spurious frequency bands and the authorized band was not corrected for HPF losses.  
 5. Proper operation of the transmitter prior to adding the filter to the measurement chain.  
 6. Owing to the highest peak level of unwanted emission out of the restricted bands complies with the lowest limit(54dBuV/m), so all the test point was deemed to comply with the limits list in the standard.



**8.1.2. UNII-2A BAND  
WORST CASE FOR ANT1**

**RESTRICTED BANDEDGE HIGH CHANNEL**

**HORIZONTAL RESULTS  
PEAK**

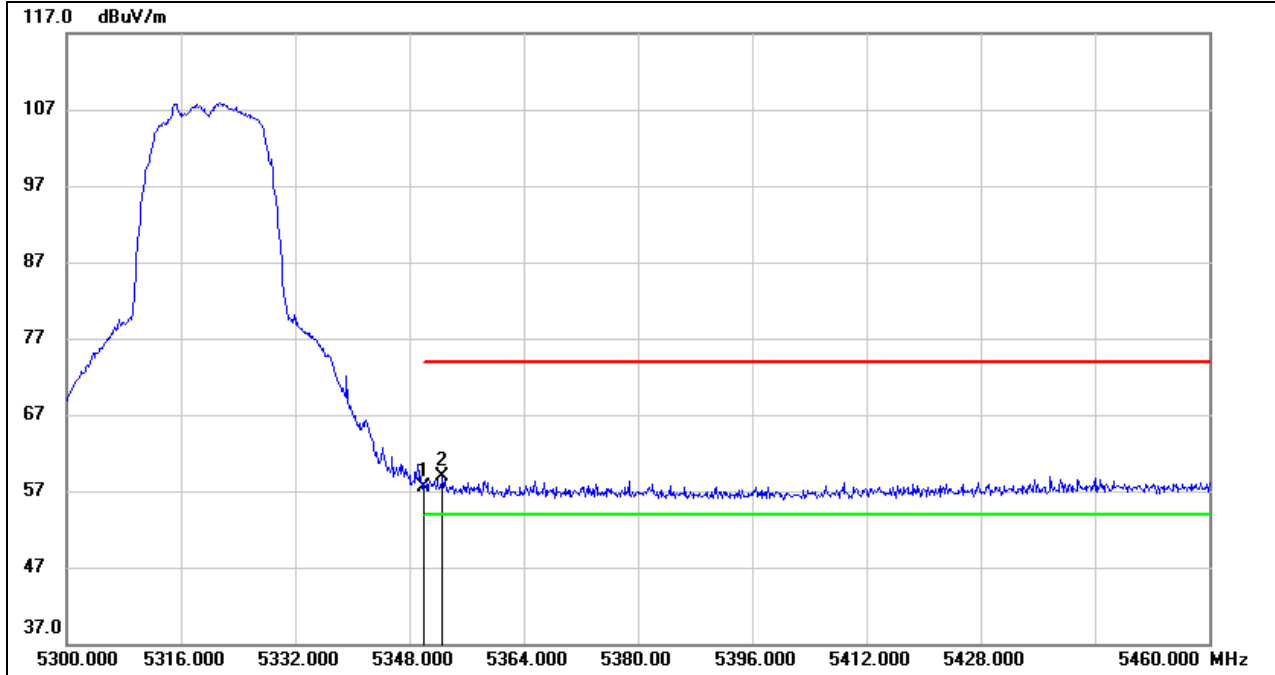

No.	Frequency (MHz)	Reading (dBuV)	Correct (dB/m)	Result (dBuV/m)	Limit (dBuV/m)	Margin (dB)	Remark
1	5350.000	16.79	40.64	57.43	74.00	-16.57	peak
2	5352.640	18.25	40.63	58.88	74.00	-15.12	peak

Note: 1. Measurement = Reading Level + Correct Factor.  
 2. If Peak Result complies with AV limit, AV Result is deemed to comply with AV limit.  
 3. Peak: Peak detector.  
 4. Only the worst case emission will be recorder, if it complies with the limit, the other emissions deemed to comply with the limit.



**AVG**

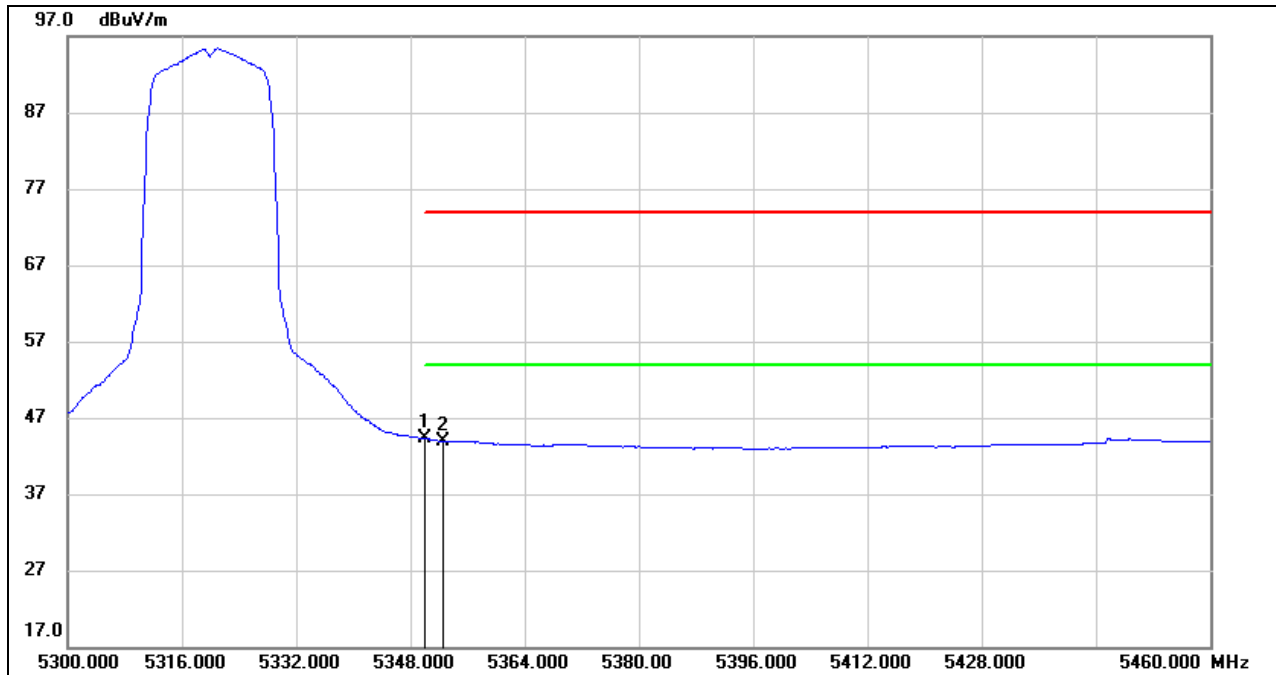

No.	Frequency (MHz)	Reading (dBuV)	Correct (dB/m)	Result (dBuV/m)	Limit (dBuV/m)	Margin (dB)	Remark
1	5350.000	3.63	40.64	44.27	54.00	-9.73	AVG
2	5352.640	3.34	40.63	43.97	54.00	-10.03	AVG

- Note: 1. Measurement = Reading Level + Correct Factor.  
 2. AVG: VBW=1/Ton where: ton is transmit duration.  
 3. For duty cycle, please refer to clause 7.1.  
 4. Only the worst case emission will be recorder, if it complies with the limit, the other emissions deemed to comply with the limit.



**VERTICAL RESULTS**  
**PEAK**

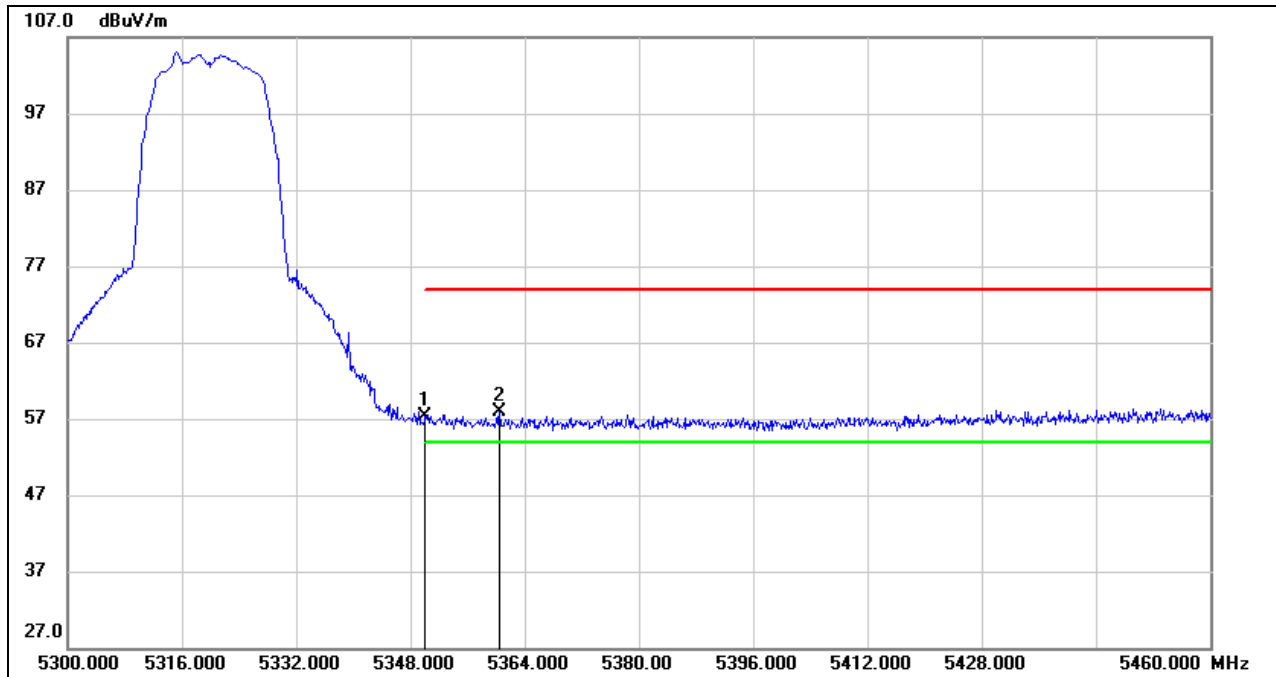

No.	Frequency (MHz)	Reading (dBuV)	Correct (dB/m)	Result (dBuV/m)	Limit (dBuV/m)	Margin (dB)	Remark
1	5350.000	16.75	40.64	57.39	74.00	-16.61	peak
2	5360.480	17.27	40.61	57.88	74.00	-16.12	peak

- Note: 1. Measurement = Reading Level + Correct Factor.  
 2. If Peak Result complies with AV limit, AV Result is deemed to comply with AV limit.  
 3. Peak: Peak detector.  
 4. Only the worst case emission will be recorder, if it complies with the limit, the other emissions deemed to comply with the limit.



**AVG**

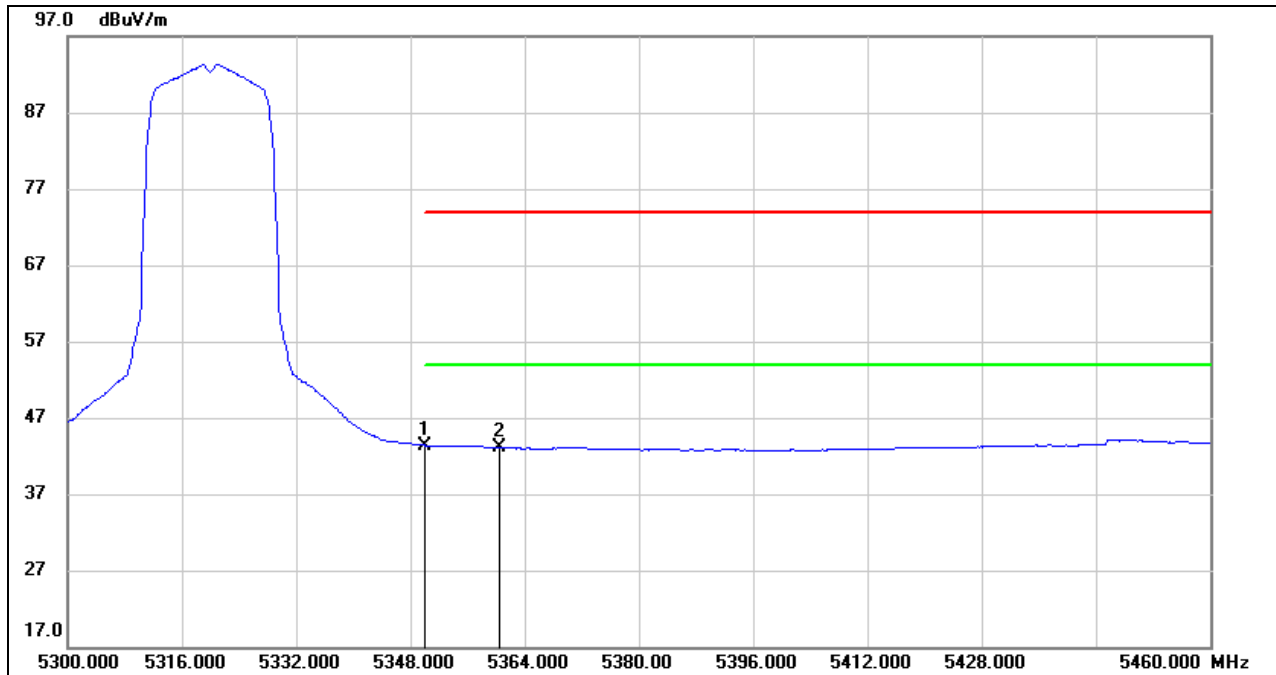

No.	Frequency (MHz)	Reading (dBuV)	Correct (dB/m)	Result (dBuV/m)	Limit (dBuV/m)	Margin (dB)	Remark
1	5350.000	2.76	40.64	43.40	54.00	-10.60	AVG
2	5360.480	2.45	40.61	43.06	54.00	-10.94	AVG

- Note: 1. Measurement = Reading Level + Correct Factor.  
 2. AVG: VBW=1/Ton where: ton is transmit duration.  
 3. For duty cycle, please refer to clause 7.1.  
 4. Only the worst case emission will be recorder, if it complies with the limit, the other emissions deemed to comply with the limit.



**HARMONICS AND SPURIOUS EMISSIONS LOW CHANNEL**

**HORIZONTAL RESULTS**  
**1-7GHz**

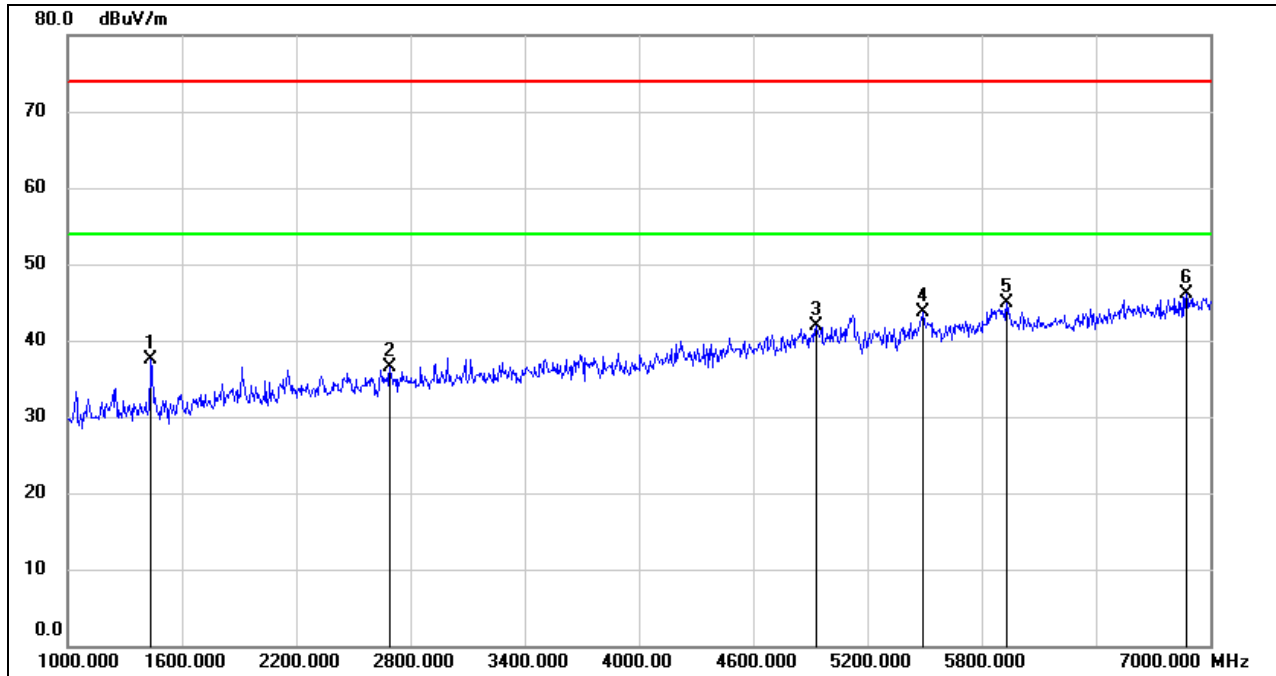

No.	Frequency (MHz)	Reading (dBuV)	Correct (dB/m)	Result (dBuV/m)	Limit (dBuV/m)	Margin (dB)	Remark
1	1438.000	50.46	-12.99	37.47	74.00	-36.53	peak
2	2692.000	44.42	-7.91	36.51	74.00	-37.49	peak
3	4930.000	41.76	0.12	41.88	74.00	-32.12	peak
4	5494.000	41.38	2.29	43.67	74.00	-30.33	peak
5	5932.000	41.14	3.77	44.91	74.00	-29.09	peak
6	6874.000	41.06	5.02	46.08	74.00	-27.92	peak

- Note: 1. Measurement = Reading Level + Correct Factor.  
 2. If Peak Result complies with AV limit, AV Result is deemed to comply with AV limit.  
 3. Peak: Peak detector.  
 4. Filter losses were only considered in the spurious frequency bands and the authorized band was not corrected for Band reject filter losses.  
 5. Proper operation of the transmitter prior to adding the filter to the measurement chain.  
 6. Owing to the highest peak level of unwanted emission out of the restricted bands complies with the lowest limit(54dBuV/m), so all the test point was deemed to comply with the limits list in the standard.



**7-18GHz**

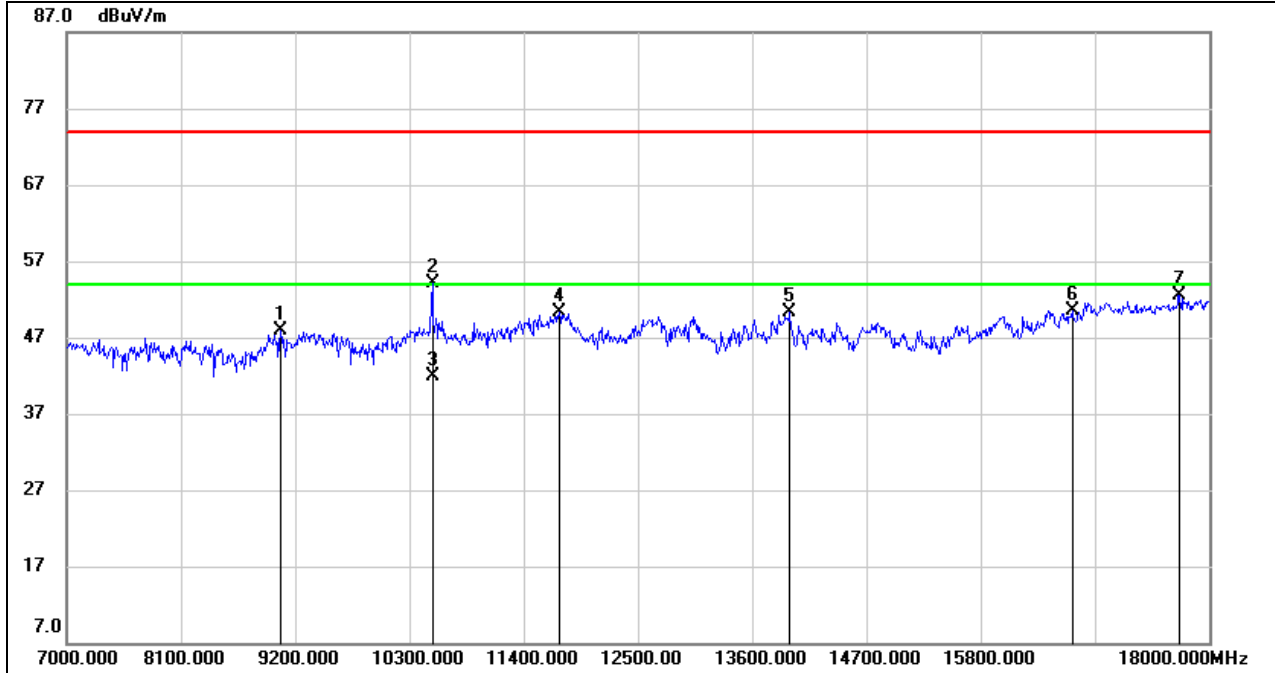

No.	Frequency (MHz)	Reading (dBuV)	Correct (dB/m)	Result (dBuV/m)	Limit (dBuV/m)	Margin (dB)	Remark
1	9057.000	37.96	9.89	47.85	74.00	-26.15	peak
2	10520.050	42.48	11.60	54.08	74.00	-19.92	peak
3	10520.050	30.32	11.60	41.92	54.00	-12.08	AVG
4	11741.000	35.92	14.29	50.21	74.00	-23.79	peak
5	13963.000	34.07	16.17	50.24	74.00	-23.76	peak
6	16680.000	30.48	20.01	50.49	74.00	-23.51	peak
7	17714.000	29.66	22.85	52.51	74.00	-21.49	peak

Note: 1. Measurement = Reading Level + Correct Factor.  
 2. If Peak Result complies with AV limit, AV Result is deemed to comply with AV limit.  
 3. Peak: Peak detector.  
 4. Filter losses were only considered in the spurious frequency bands and the authorized band was not corrected for HPF losses.  
 5. Proper operation of the transmitter prior to adding the filter to the measurement chain.  
 6. Owing to the highest peak level of unwanted emission out of the restricted bands complies with the lowest limit(54dBuV/m), so all the test point was deemed to comply with the limits list in the standard.





**VERTICAL RESULTS**  
**1-7GHz**

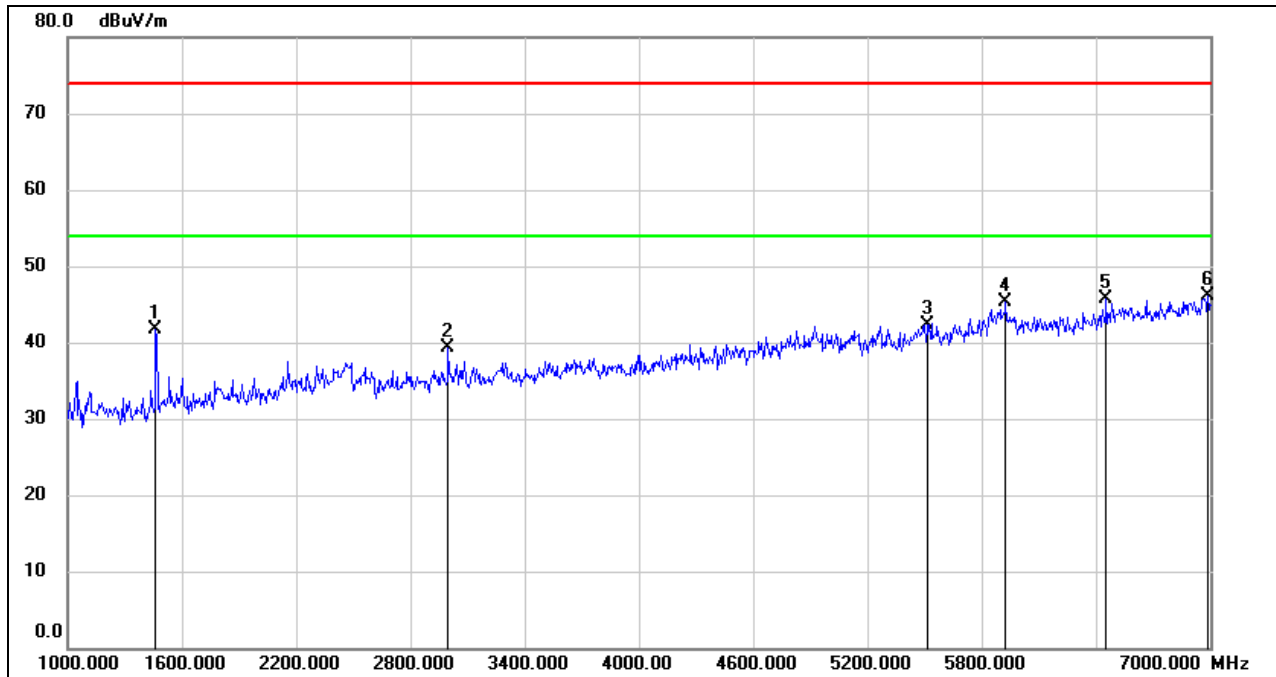

No.	Frequency (MHz)	Reading (dBuV)	Correct (dB/m)	Result (dBuV/m)	Limit (dBuV/m)	Margin (dB)	Remark
1	1462.000	54.56	-12.94	41.62	74.00	-32.38	peak
2	2998.000	45.61	-6.29	39.32	74.00	-34.68	peak
3	5518.000	40.07	2.30	42.37	74.00	-31.63	peak
4	5926.000	41.41	3.87	45.28	74.00	-28.72	peak
5	6454.000	41.26	4.37	45.63	74.00	-28.37	peak
6	6988.000	40.83	5.26	46.09	74.00	-27.91	peak

Note: 1. Measurement = Reading Level + Correct Factor.  
 2. If Peak Result complies with AV limit, AV Result is deemed to comply with AV limit.  
 3. Peak: Peak detector.  
 4. Filter losses were only considered in the spurious frequency bands and the authorized band was not corrected for Band reject filter losses.  
 5. Proper operation of the transmitter prior to adding the filter to the measurement chain.  
 6. Owing to the highest peak level of unwanted emission out of the restricted bands complies with the lowest limit(54dBuV/m), so all the test point was deemed to comply with the limits list in the standard.



**7-18GHz**

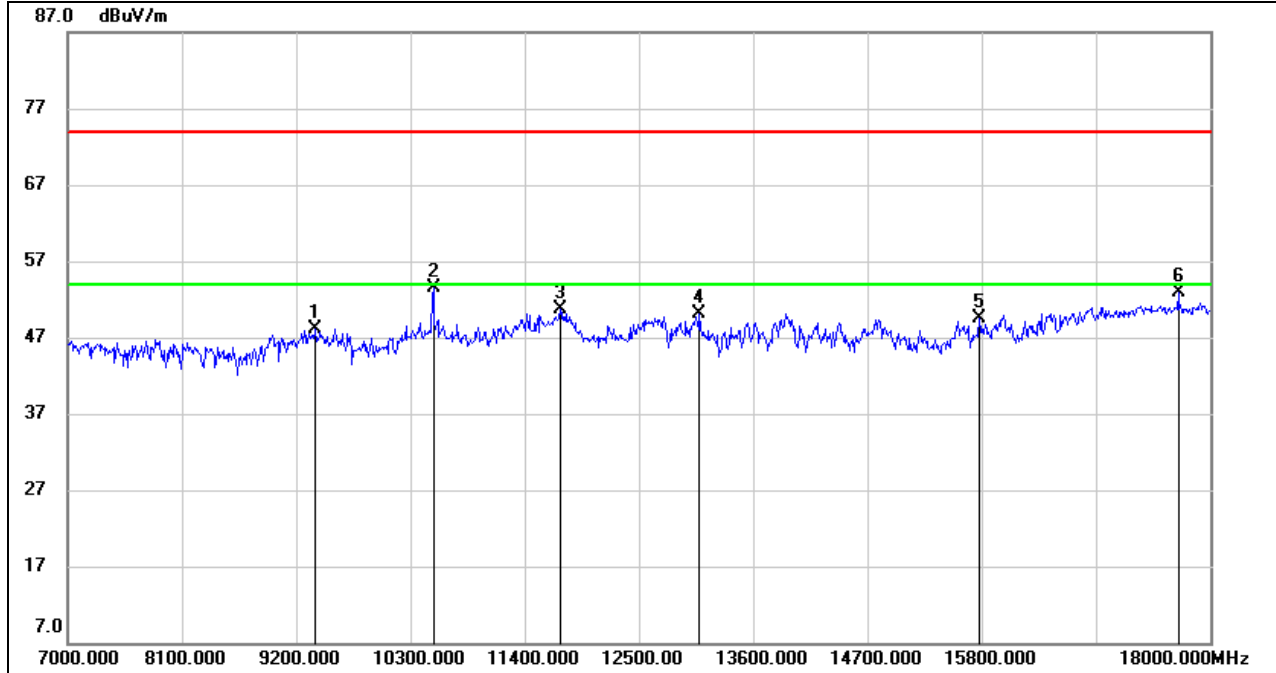

No.	Frequency (MHz)	Reading (dBuV)	Correct (dB/m)	Result (dBuV/m)	Limit (dBuV/m)	Margin (dB)	Remark
1	9387.000	38.11	9.94	48.05	74.00	-25.95	peak
2	10520.000	41.82	11.60	53.42	74.00	-20.58	peak
3	11741.000	36.35	14.29	50.64	74.00	-23.36	peak
4	13083.000	34.56	15.50	50.06	74.00	-23.94	peak
5	15778.000	32.55	16.86	49.41	74.00	-24.59	peak
6	17692.000	30.14	22.69	52.83	74.00	-21.17	peak

Note: 1. Measurement = Reading Level + Correct Factor.  
 2. If Peak Result complies with AV limit, AV Result is deemed to comply with AV limit.  
 3. Peak: Peak detector.  
 4. Filter losses were only considered in the spurious frequency bands and the authorized band was not corrected for HPF losses.  
 5. Proper operation of the transmitter prior to adding the filter to the measurement chain.  
 6. Owing to the highest peak level of unwanted emission out of the restricted bands complies with the lowest limit(54dBuV/m), so all the test point was deemed to comply with the limits list in the standard.



**HARMONICS AND SPURIOUS EMISSIONS MID CHANNEL**

**HORIZONTAL RESULTS**  
**1-7GHz**

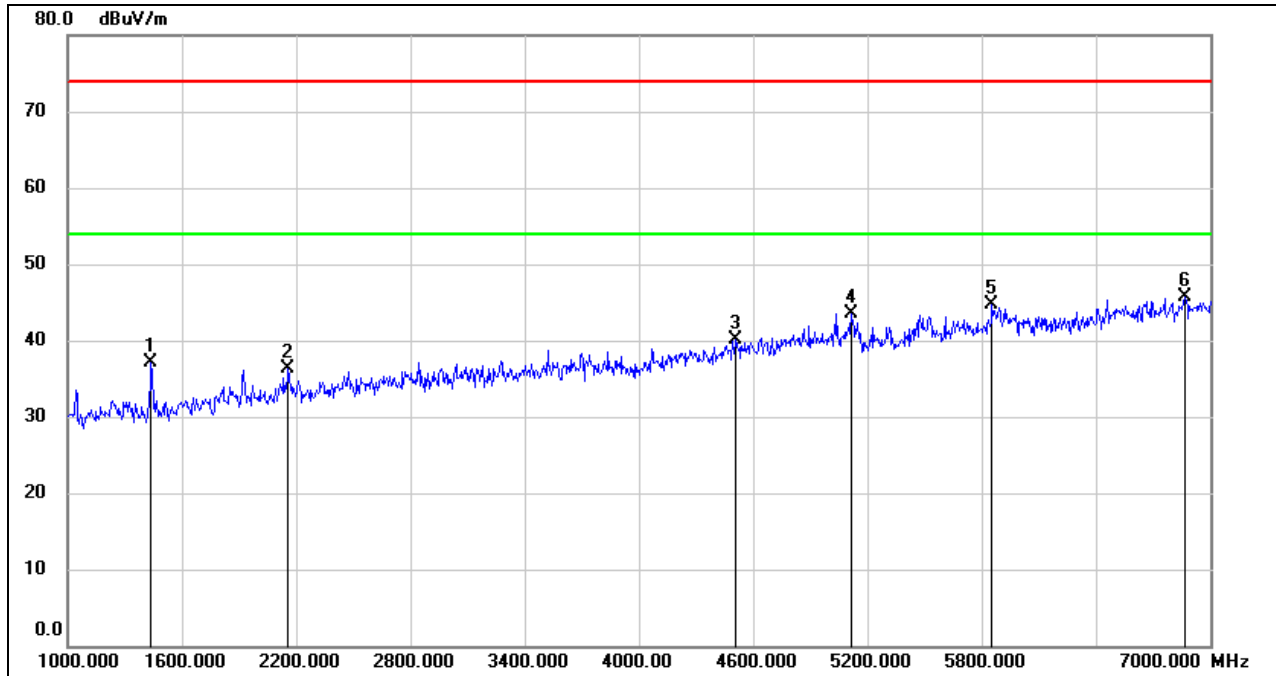

No.	Frequency (MHz)	Reading (dBuV)	Correct (dB/m)	Result (dBuV/m)	Limit (dBuV/m)	Margin (dB)	Remark
1	1438.000	50.19	-12.99	37.20	74.00	-36.80	peak
2	2158.000	46.06	-9.83	36.23	74.00	-37.77	peak
3	4510.000	41.77	-1.75	40.02	74.00	-33.98	peak
4	5116.000	42.73	0.86	43.59	74.00	-30.41	peak
5	5854.000	41.23	3.48	44.71	74.00	-29.29	peak
6	6868.000	40.72	4.98	45.70	74.00	-28.30	peak

- Note: 1. Measurement = Reading Level + Correct Factor.  
 2. If Peak Result complies with AV limit, AV Result is deemed to comply with AV limit.  
 3. Peak: Peak detector.  
 4. Filter losses were only considered in the spurious frequency bands and the authorized band was not corrected for Band reject filter losses.  
 5. Proper operation of the transmitter prior to adding the filter to the measurement chain.  
 6. Owing to the highest peak level of unwanted emission out of the restricted bands complies with the lowest limit(54dBuV/m), so all the test point was deemed to comply with the limits list in the standard.



**7-18GHz**

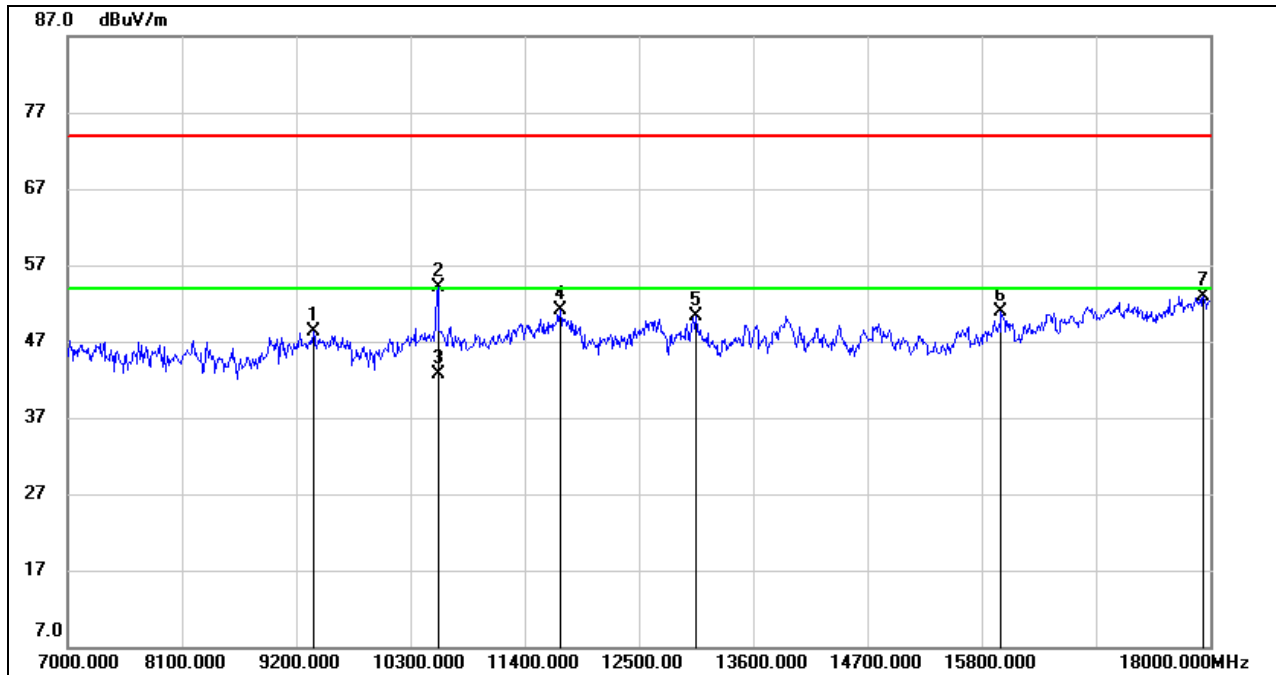

No.	Frequency (MHz)	Reading (dBuV)	Correct (dB/m)	Result (dBuV/m)	Limit (dBuV/m)	Margin (dB)	Remark
1	9365.000	38.47	9.84	48.31	74.00	-25.69	peak
2	10560.154	42.37	11.74	54.11	74.00	-19.89	peak
3	10560.154	31.03	11.74	42.77	54.00	-11.23	AVG
4	11741.000	36.79	14.29	51.08	74.00	-22.92	peak
5	13050.000	34.78	15.55	50.33	74.00	-23.67	peak
6	15987.000	33.16	17.68	50.84	74.00	-23.16	peak
7	17934.000	29.29	23.62	52.91	74.00	-21.09	peak

Note: 1. Measurement = Reading Level + Correct Factor.  
 2. If Peak Result complies with AV limit, AV Result is deemed to comply with AV limit.  
 3. Peak: Peak detector.  
 4. Filter losses were only considered in the spurious frequency bands and the authorized band was not corrected for HPF losses.  
 5. Proper operation of the transmitter prior to adding the filter to the measurement chain.  
 6. Owing to the highest peak level of unwanted emission out of the restricted bands complies with the lowest limit(54dBuV/m), so all the test point was deemed to comply with the limits list in the standard.



**VERTICAL RESULTS**  
**1-7GHz**

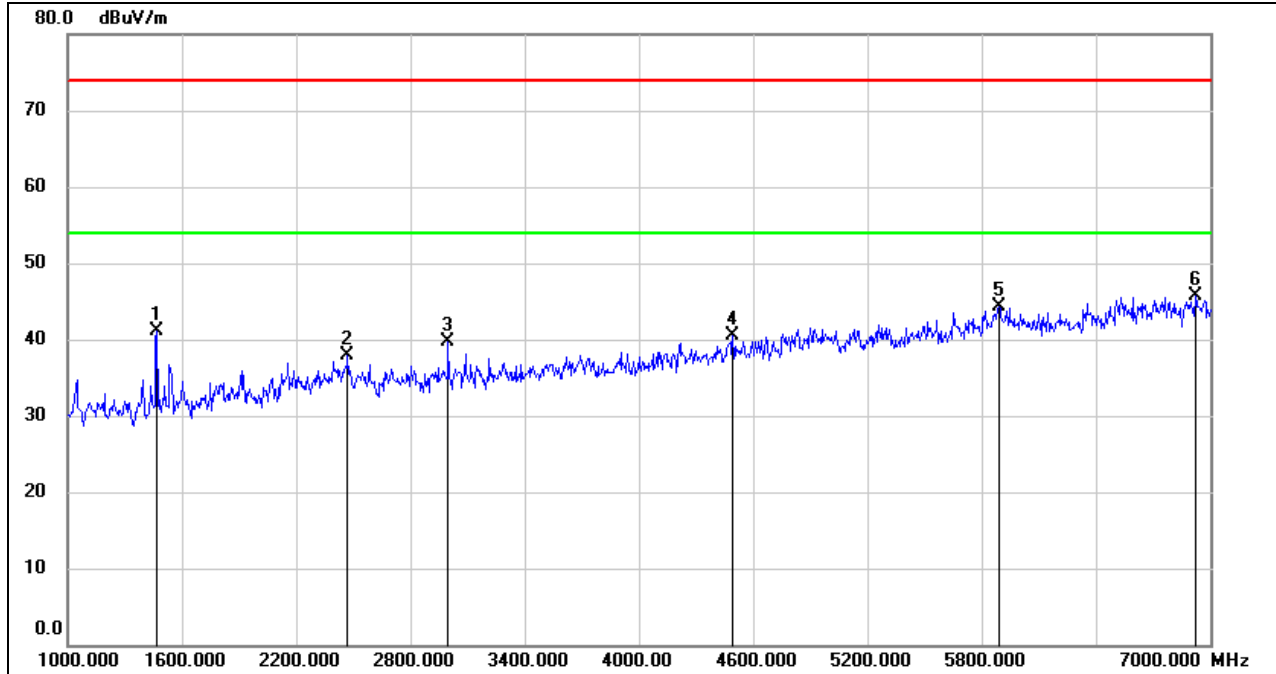

No.	Frequency (MHz)	Reading (dBuV)	Correct (dB/m)	Result (dBuV/m)	Limit (dBuV/m)	Margin (dB)	Remark
1	1468.000	54.11	-12.93	41.18	74.00	-32.82	peak
2	2470.000	46.17	-8.33	37.84	74.00	-36.16	peak
3	2998.000	45.96	-6.29	39.67	74.00	-34.33	peak
4	4492.000	42.32	-1.83	40.49	74.00	-33.51	peak
5	5890.000	40.06	4.15	44.21	74.00	-29.79	peak
6	6922.000	40.42	5.21	45.63	74.00	-28.37	peak

Note: 1. Measurement = Reading Level + Correct Factor.  
 2. If Peak Result complies with AV limit, AV Result is deemed to comply with AV limit.  
 3. Peak: Peak detector.  
 4. Filter losses were only considered in the spurious frequency bands and the authorized band was not corrected for Band reject filter losses.  
 5. Proper operation of the transmitter prior to adding the filter to the measurement chain.  
 6. Owing to the highest peak level of unwanted emission out of the restricted bands complies with the lowest limit(54dBuV/m), so all the test point was deemed to comply with the limits list in the standard.



**7-18GHz**

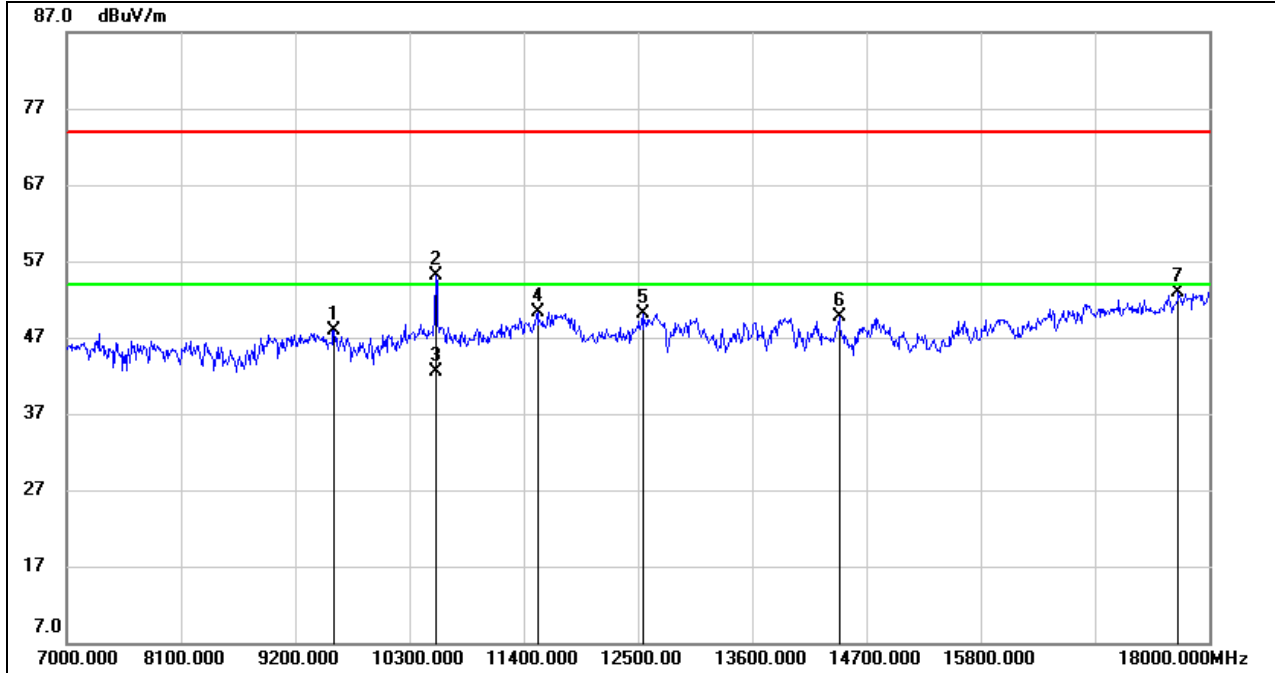

No.	Frequency (MHz)	Reading (dBuV)	Correct (dB/m)	Result (dBuV/m)	Limit (dBuV/m)	Margin (dB)	Remark
1	9574.000	37.50	10.49	47.99	74.00	-26.01	peak
2	10559.983	43.32	11.74	55.06	74.00	-18.94	peak
3	10559.983	30.77	11.74	42.51	54.00	-11.49	AVG
4	11532.000	36.63	13.62	50.25	74.00	-23.75	peak
5	12544.000	35.04	15.05	50.09	74.00	-23.91	peak
6	14436.000	33.57	16.10	49.67	74.00	-24.33	peak
7	17703.000	30.21	22.77	52.98	74.00	-21.02	peak

Note: 1. Measurement = Reading Level + Correct Factor.  
 2. If Peak Result complies with AV limit, AV Result is deemed to comply with AV limit.  
 3. Peak: Peak detector.  
 4. Filter losses were only considered in the spurious frequency bands and the authorized band was not corrected for HPF losses.  
 5. Proper operation of the transmitter prior to adding the filter to the measurement chain.  
 6. Owing to the highest peak level of unwanted emission out of the restricted bands complies with the lowest limit(54dBuV/m), so all the test point was deemed to comply with the limits list in the standard.



**HARMONICS AND SPURIOUS EMISSIONS HIGH CHANNEL**

**HORIZONTAL RESULTS**  
**1-7GHz**

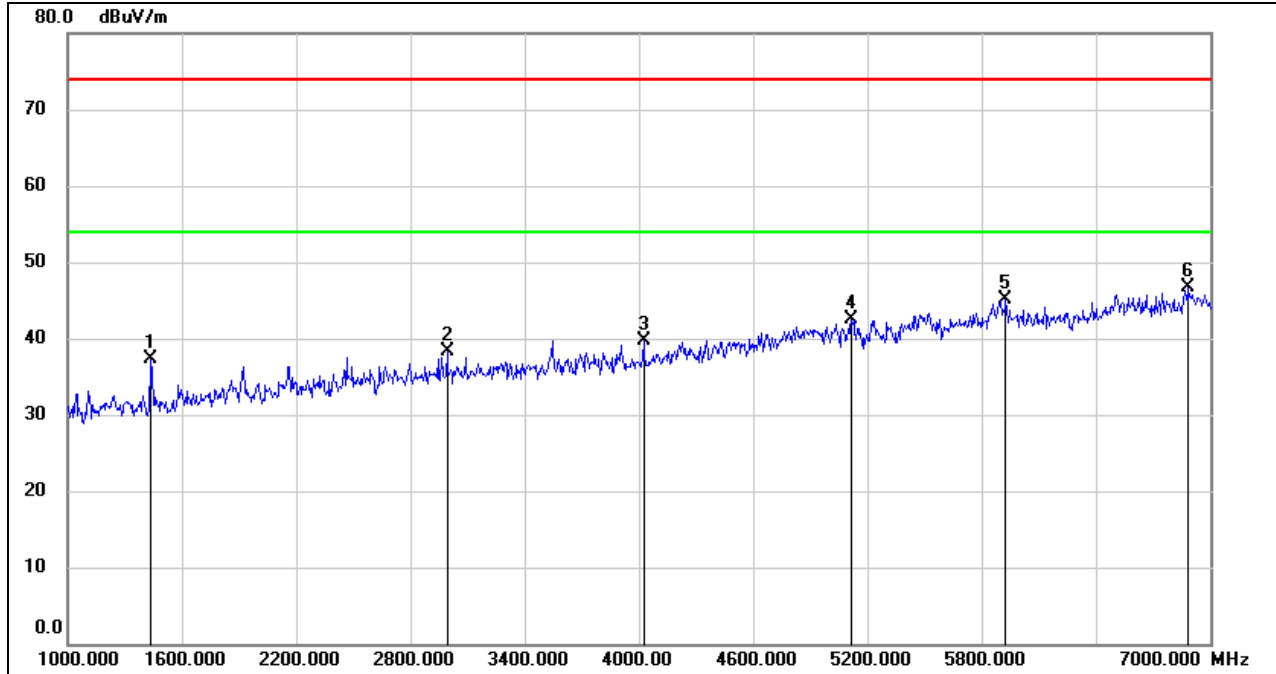

No.	Frequency (MHz)	Reading (dBuV)	Correct (dB/m)	Result (dBuV/m)	Limit (dBuV/m)	Margin (dB)	Remark
1	1438.000	50.34	-12.99	37.35	74.00	-36.65	peak
2	2992.000	44.56	-6.31	38.25	74.00	-35.75	peak
3	4024.000	43.80	-4.12	39.68	74.00	-34.32	peak
4	5116.000	41.64	0.86	42.50	74.00	-31.50	peak
5	5926.000	41.29	3.87	45.16	74.00	-28.84	peak
6	6886.000	41.58	5.10	46.68	74.00	-27.32	peak

Note: 1. Measurement = Reading Level + Correct Factor.  
 2. If Peak Result complies with AV limit, AV Result is deemed to comply with AV limit.  
 3. Peak: Peak detector.  
 4. Filter losses were only considered in the spurious frequency bands and the authorized band was not corrected for Band reject filter losses.  
 5. Proper operation of the transmitter prior to adding the filter to the measurement chain.  
 6. Owing to the highest peak level of unwanted emission out of the restricted bands complies with the lowest limit(54dBuV/m), so all the test point was deemed to comply with the limits list in the standard.



**7-18GHz**

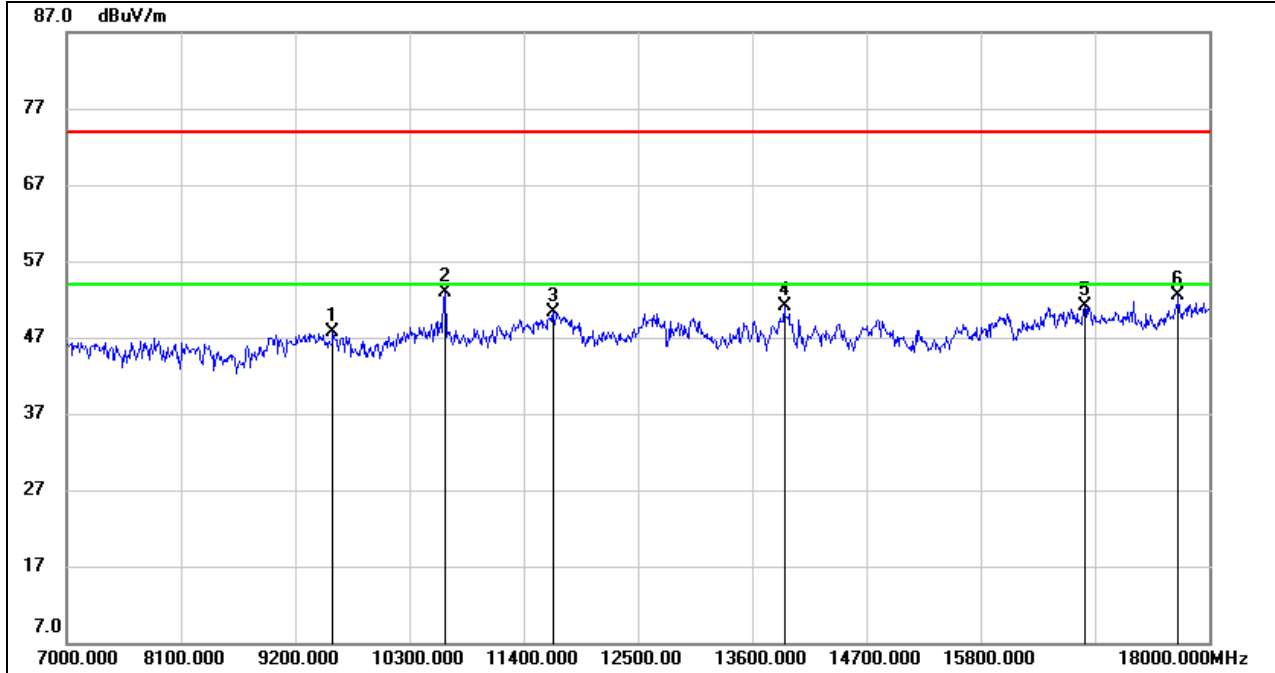

No.	Frequency (MHz)	Reading (dBuV)	Correct (dB/m)	Result (dBuV/m)	Limit (dBuV/m)	Margin (dB)	Remark
1	9563.000	37.29	10.46	47.75	74.00	-26.25	peak
2	10641.000	40.99	11.91	52.90	74.00	-21.10	peak
3	11686.000	36.26	14.07	50.33	74.00	-23.67	peak
4	13908.000	34.90	16.26	51.16	74.00	-22.84	peak
5	16801.000	31.01	20.12	51.13	74.00	-22.87	peak
6	17703.000	29.68	22.77	52.45	74.00	-21.55	peak

Note: 1. Measurement = Reading Level + Correct Factor.  
 2. If Peak Result complies with AV limit, AV Result is deemed to comply with AV limit.  
 3. Peak: Peak detector.  
 4. Filter losses were only considered in the spurious frequency bands and the authorized band was not corrected for HPF losses.  
 5. Proper operation of the transmitter prior to adding the filter to the measurement chain.  
 6. Owing to the highest peak level of unwanted emission out of the restricted bands complies with the lowest limit(54dBuV/m), so all the test point was deemed to comply with the limits list in the standard.





**VERTICAL RESULTS**  
**1-7GHz**

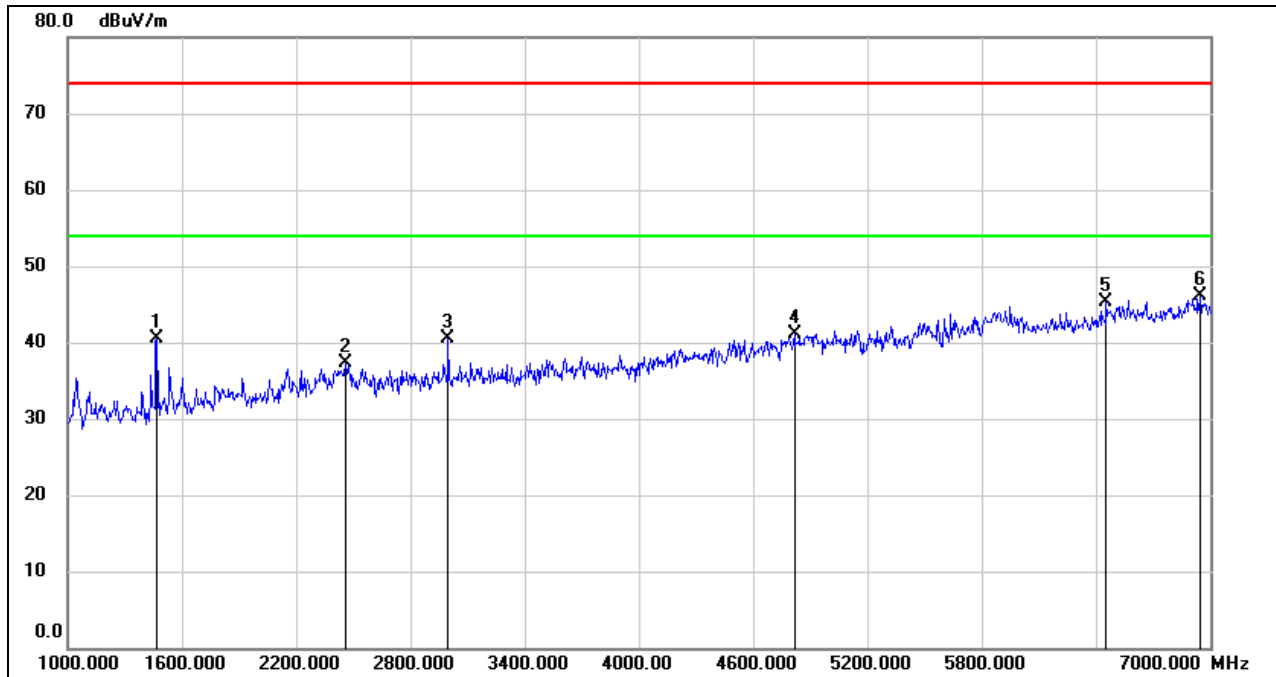

No.	Frequency (MHz)	Reading (dBuV)	Correct (dB/m)	Result (dBuV/m)	Limit (dBuV/m)	Margin (dB)	Remark
1	1468.000	53.52	-12.93	40.59	74.00	-33.41	peak
2	2458.000	45.76	-8.44	37.32	74.00	-36.68	peak
3	2998.000	46.84	-6.29	40.55	74.00	-33.45	peak
4	4816.000	41.41	-0.30	41.11	74.00	-32.89	peak
5	6454.000	40.88	4.37	45.25	74.00	-28.75	peak
6	6946.000	40.94	5.22	46.16	74.00	-27.84	peak

Note: 1. Measurement = Reading Level + Correct Factor.  
 2. If Peak Result complies with AV limit, AV Result is deemed to comply with AV limit.  
 3. Peak: Peak detector.  
 4. Filter losses were only considered in the spurious frequency bands and the authorized band was not corrected for Band reject filter losses.  
 5. Proper operation of the transmitter prior to adding the filter to the measurement chain.  
 6. Owing to the highest peak level of unwanted emission out of the restricted bands complies with the lowest limit(54dBuV/m), so all the test point was deemed to comply with the limits list in the standard.



**7-18GHz**

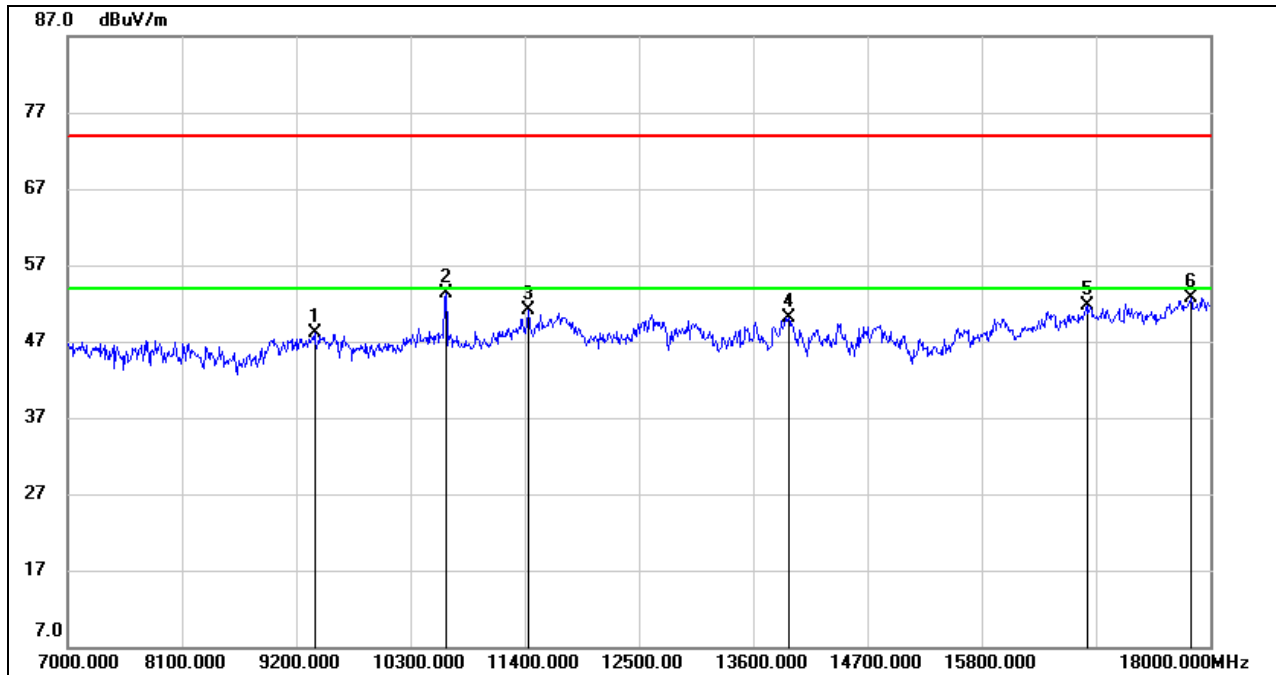

No.	Frequency (MHz)	Reading (dBuV)	Correct (dB/m)	Result (dBuV/m)	Limit (dBuV/m)	Margin (dB)	Remark
1	9376.000	38.21	9.89	48.10	74.00	-25.90	peak
2	10641.000	41.40	11.91	53.31	74.00	-20.69	peak
3	11433.000	37.55	13.50	51.05	74.00	-22.95	peak
4	13941.000	33.98	16.21	50.19	74.00	-23.81	peak
5	16812.000	31.56	20.14	51.70	74.00	-22.30	peak
6	17813.000	29.15	23.50	52.65	74.00	-21.35	peak

Note: 1. Measurement = Reading Level + Correct Factor.  
 2. If Peak Result complies with AV limit, AV Result is deemed to comply with AV limit.  
 3. Peak: Peak detector.  
 4. Filter losses were only considered in the spurious frequency bands and the authorized band was not corrected for HPF losses.  
 5. Proper operation of the transmitter prior to adding the filter to the measurement chain.  
 6. Owing to the highest peak level of unwanted emission out of the restricted bands complies with the lowest limit(54dBuV/m), so all the test point was deemed to comply with the limits list in the standard.



**8.1.3. UNII-2C BAND  
WORST CASE FOR ANT1**

**RESTRICTED BANDEDGE LOW CHANNEL**

**HORIZONTAL RESULTS  
PEAK**

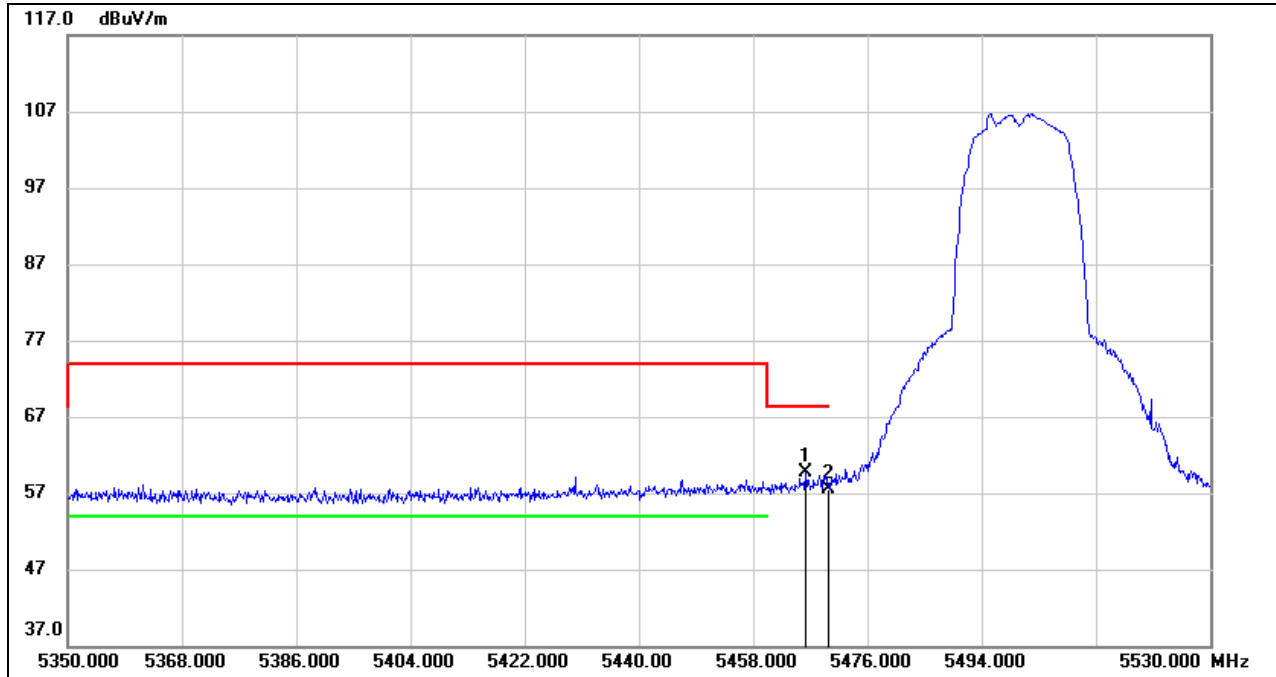

No.	Frequency (MHz)	Reading (dBuV)	Correct (dB/m)	Result (dBuV/m)	Limit (dBuV/m)	Margin (dB)	Remark
1	5466.280	18.32	41.37	59.69	68.20	-8.51	peak
2	5470.000	16.18	41.41	57.59	68.20	-10.61	peak

Note: 1. Measurement = Reading Level + Correct Factor.  
 2. If Peak Result complies with AV limit, AV Result is deemed to comply with AV limit.  
 3. Peak: Peak detector.  
 4.\*indicates frequency out of the restricted bands  
 5. Only the worst case emission will be recorder, if it complies with the limit, the other emissions deemed to comply with the limit.



**AVG**

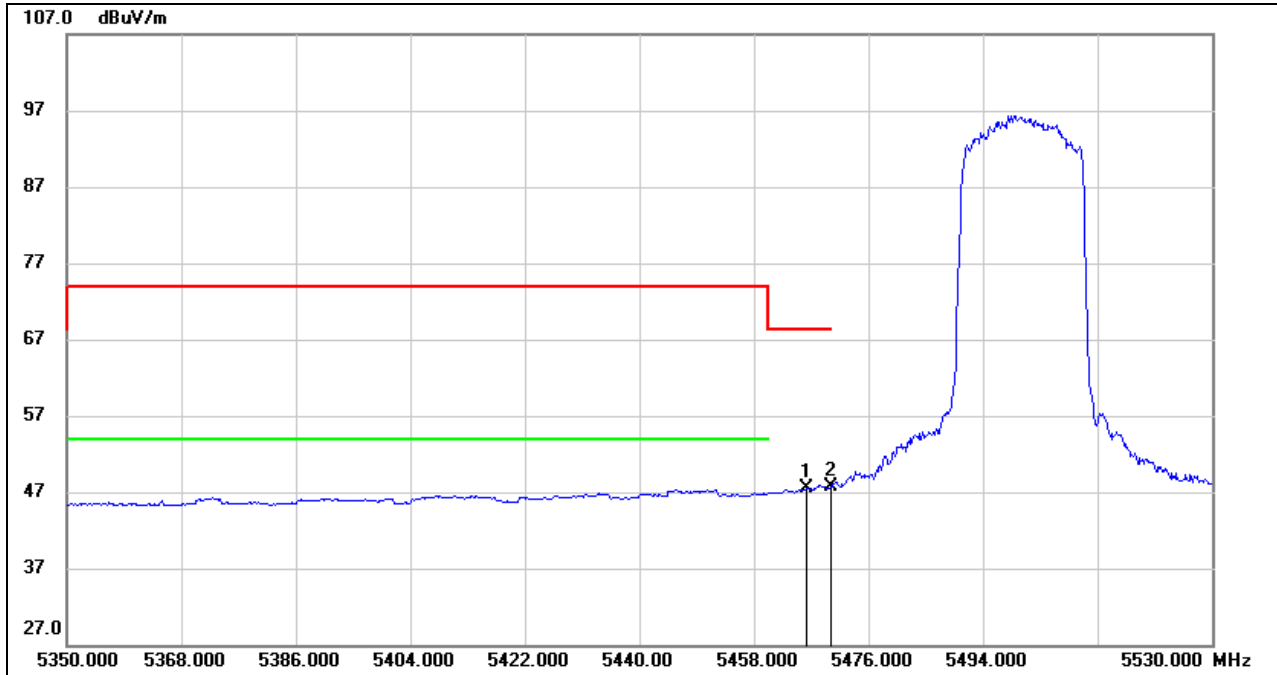

No.	Frequency (MHz)	Reading (dBuV)	Correct (dB/m)	Result (dBuV/m)	Limit (dBuV/m)	Margin (dB)	Remark
1	5466.280	6.08	41.37	47.45	68.20	-20.75	AVG
2	5470.000	6.25	41.41	47.66	68.20	-20.54	AVG

- Note:
1. Measurement = Reading Level + Correct Factor.
  2. AVG:  $VBW=1/Ton$  where: ton is transmit duration.
  3. For duty cycle, please refer to clause 7.1.
  4. Only the worst case emission will be recorder, if it complies with the limit, the other emissions deemed to comply with the limit.



**VERTICAL RESULTS**  
**PEAK**

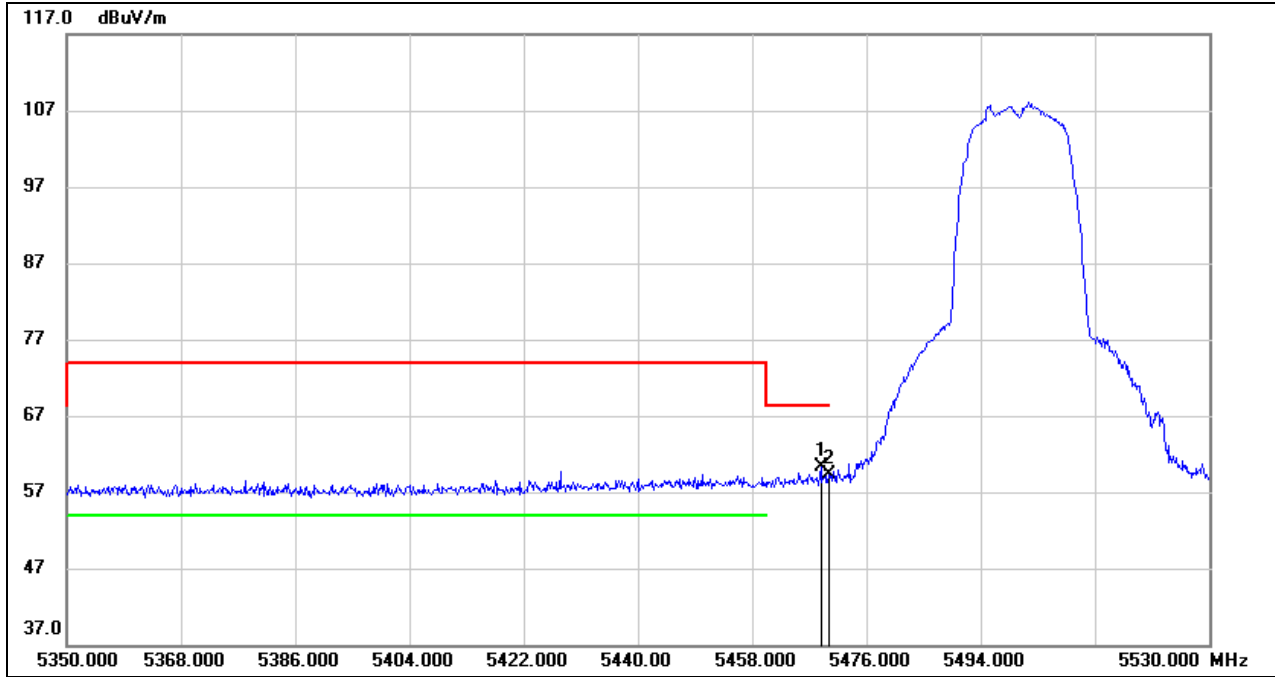

No.	Frequency (MHz)	Reading (dBuV)	Correct (dB/m)	Result (dBuV/m)	Limit (dBuV/m)	Margin (dB)	Remark
1	5468.800	18.93	41.39	60.32	68.20	-7.88	peak
2	5470.000	17.86	41.41	59.27	68.20	-8.93	peak

- Note: 1. Measurement = Reading Level + Correct Factor.  
 2. If Peak Result complies with AV limit, AV Result is deemed to comply with AV limit.  
 3. Peak: Peak detector.  
 4.\*indicates frequency out of the restricted bands  
 5. Only the worst case emission will be recorder, if it complies with the limit, the other emissions deemed to comply with the limit.



**AVG**

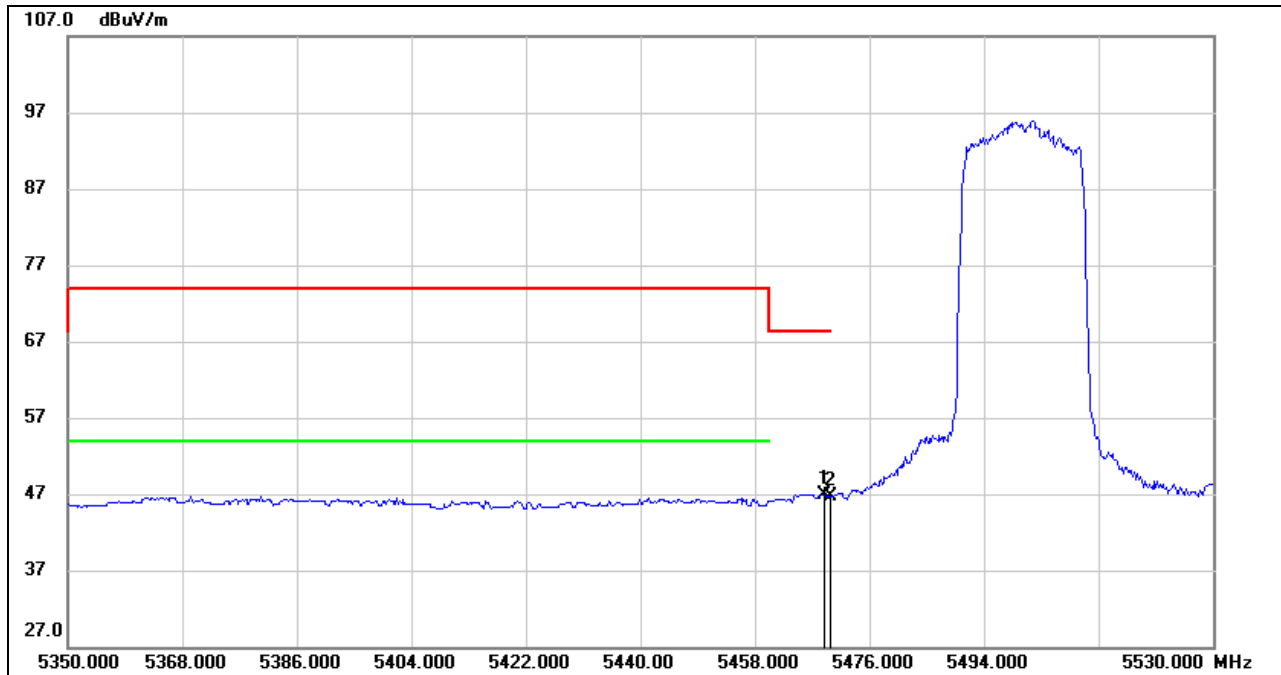

No.	Frequency (MHz)	Reading (dBuV)	Correct (dB/m)	Result (dBuV/m)	Limit (dBuV/m)	Margin (dB)	Remark
1	5468.800	5.58	41.39	46.97	68.20	-21.23	AVG
2	5470.000	5.26	41.41	46.67	68.20	-21.53	AVG

- Note: 1. Measurement = Reading Level + Correct Factor.  
 2. AVG: VBW=1/Ton where: ton is transmit duration.  
 3. For duty cycle, please refer to clause 7.1.  
 4. Only the worst case emission will be recorder, if it complies with the limit, the other emissions deemed to comply with the limit.



**RESTRICTED BANDEGE HIGH CHANNEL**

**HORIZONTAL RESULTS**  
**PEAK**

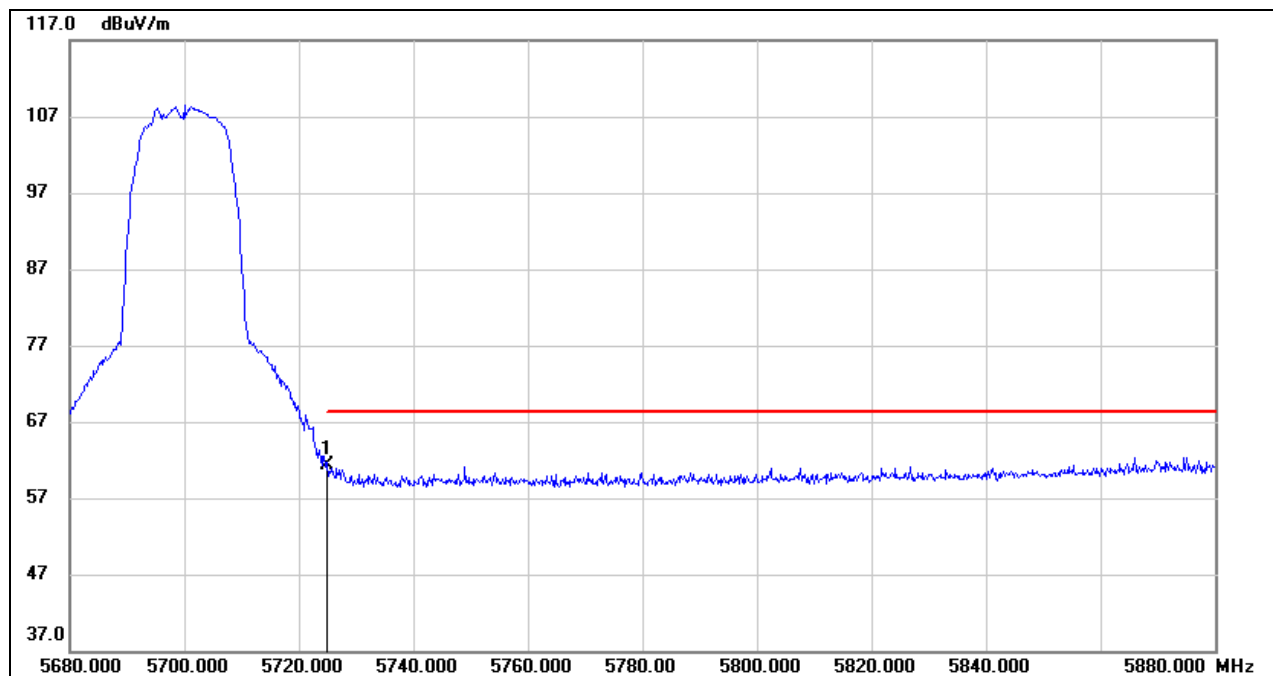

No.	Frequency (MHz)	Reading (dBuV)	Correct (dB/m)	Result (dBuV/m)	Limit (dBuV/m)	Margin (dB)	Remark
1	5725.000	19.71	41.61	61.32	68.20	-6.88	peak

- Note:
1. Measurement = Reading Level + Correct Factor.
  2. If Peak Result complies with AV limit, AV Result is deemed to comply with AV limit.
  3. Peak: Peak detector.
  4. Only the worst case emission will be recorder, if it complies with the limit, the other emissions deemed to comply with the limit.



**VERTICAL RESULTS**  
**PEAK**

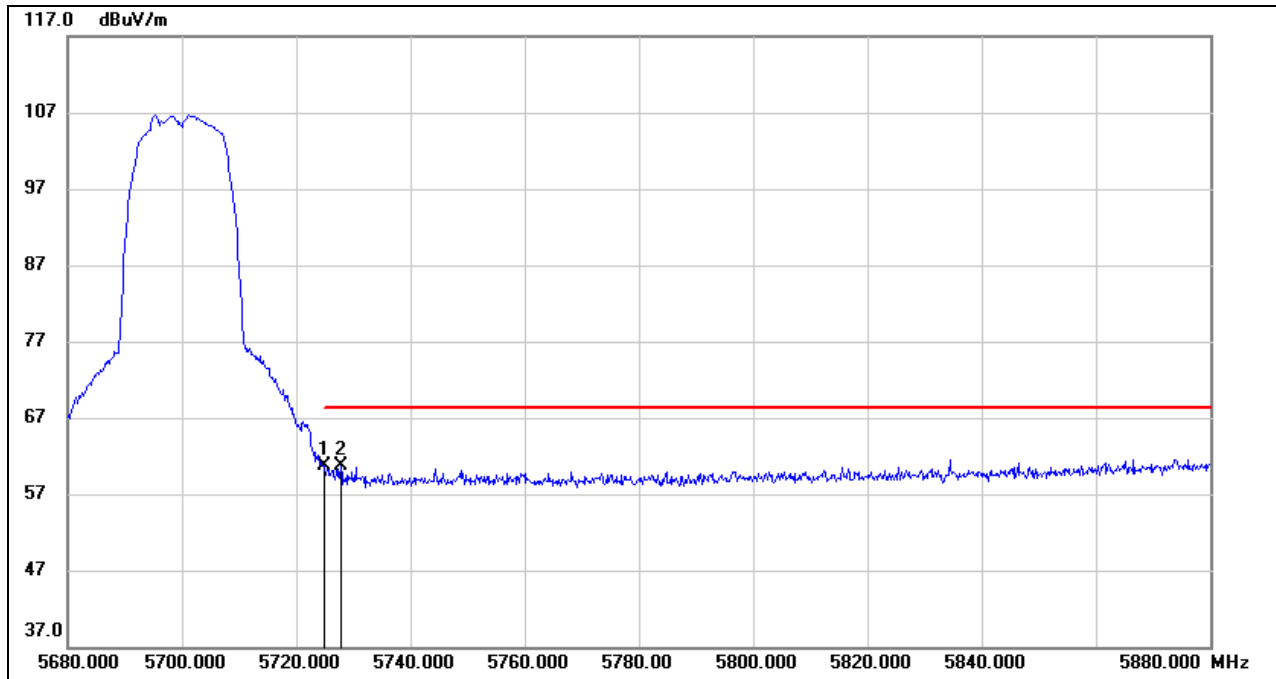

No.	Frequency (MHz)	Reading (dBuV)	Correct (dB/m)	Result (dBuV/m)	Limit (dBuV/m)	Margin (dB)	Remark
1	5725.000	19.12	41.61	60.73	68.20	-7.47	peak
2	5727.800	19.18	41.62	60.80	68.20	-7.40	peak

- Note: 1. Measurement = Reading Level + Correct Factor.  
 2. If Peak Result complies with AV limit, AV Result is deemed to comply with AV limit.  
 3. Peak: Peak detector.  
 4. Only the worst case emission will be recorder, if it complies with the limit, the other emissions deemed to comply with the limit.





**HARMONICS AND SPURIOUS EMISSIONS LOW CHANNEL**

**HORIZONTAL RESULTS**  
**1-7GHz**

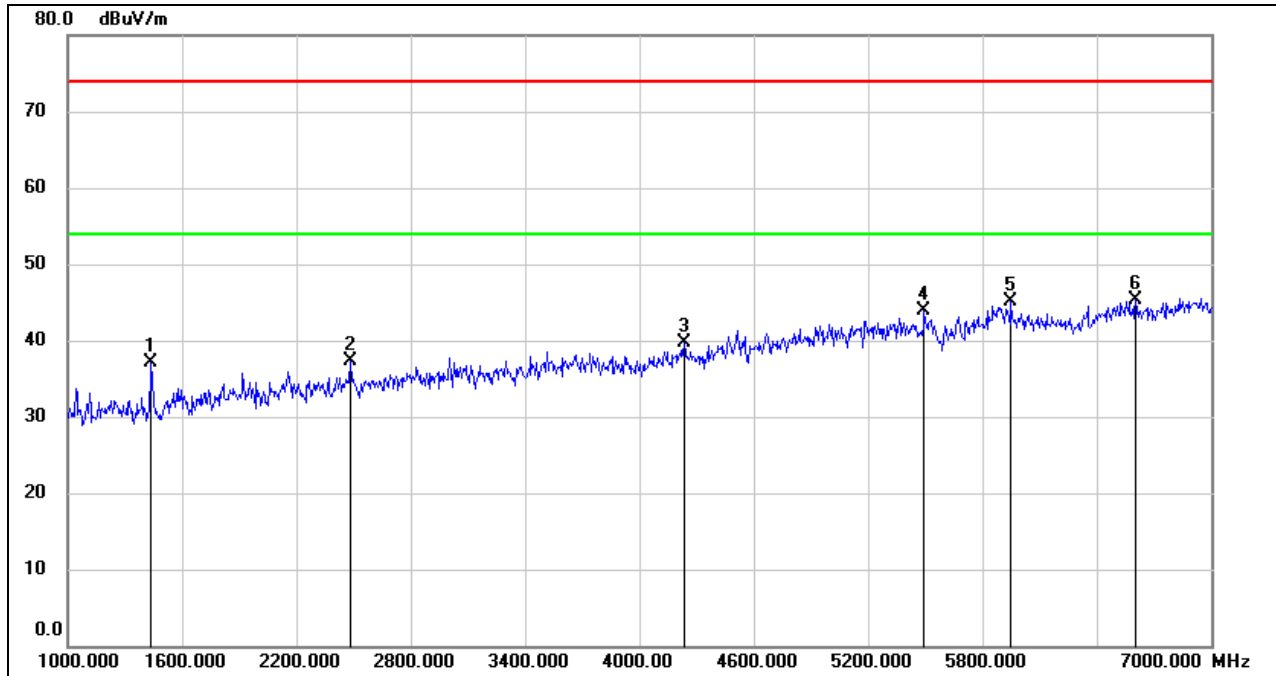

No.	Frequency (MHz)	Reading (dBuV)	Correct (dB/m)	Result (dBuV/m)	Limit (dBuV/m)	Margin (dB)	Remark
1	1438.000	50.03	-12.99	37.04	74.00	-36.96	peak
2	2482.000	45.55	-8.22	37.33	74.00	-36.67	peak
3	4234.000	42.63	-2.85	39.78	74.00	-34.22	peak
4	5494.000	41.64	2.29	43.93	74.00	-30.07	peak
5	5950.000	41.56	3.47	45.03	74.00	-28.97	peak
6	6604.000	40.81	4.56	45.37	74.00	-28.63	peak

Note: 1. Measurement = Reading Level + Correct Factor.  
 2. If Peak Result complies with AV limit, AV Result is deemed to comply with AV limit.  
 3. Peak: Peak detector.  
 4. Filter losses were only considered in the spurious frequency bands and the authorized band was not corrected for Band reject filter losses.  
 5. Proper operation of the transmitter prior to adding the filter to the measurement chain.  
 6. Owing to the highest peak level of unwanted emission out of the restricted bands complies with the lowest limit(54dBuV/m), so all the test point was deemed to comply with the limits list in the standard.



**HORIZONTAL RESULTS**  
**7-18GHz**

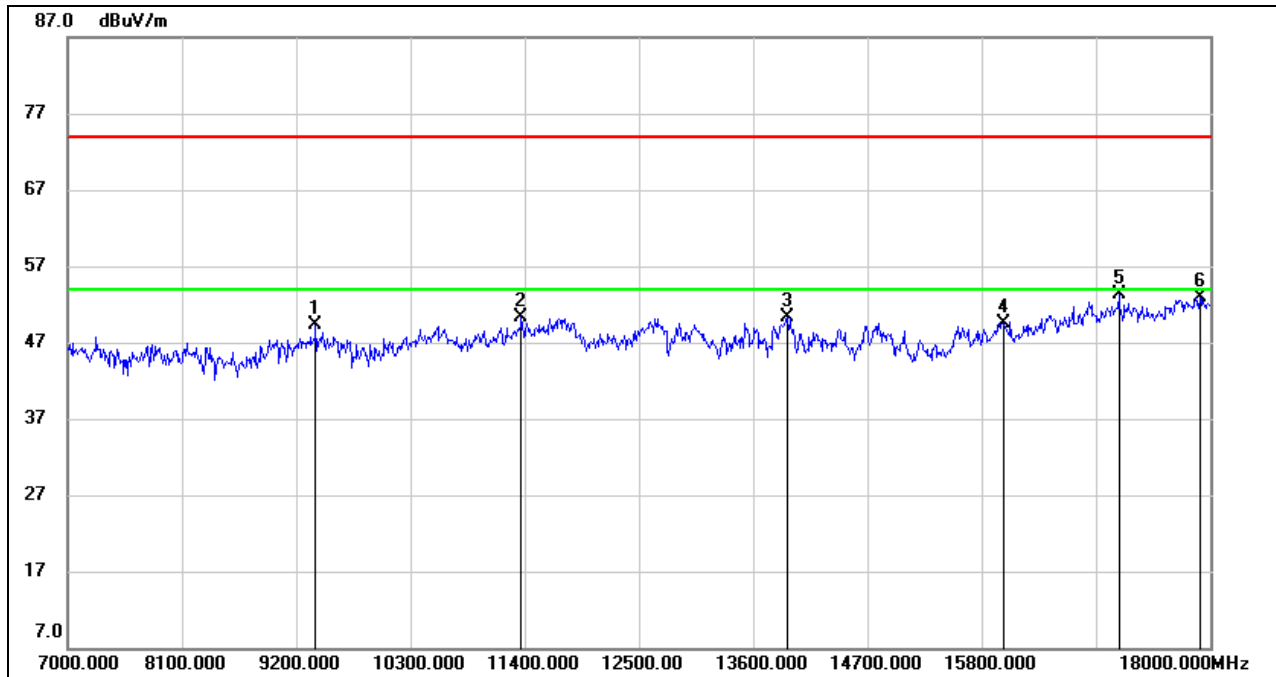

No.	Frequency (MHz)	Reading (dBuV)	Correct (dB/m)	Result (dBuV/m)	Limit (dBuV/m)	Margin (dB)	Remark
1	9387.000	39.37	9.94	49.31	74.00	-24.69	peak
2	11367.000	36.95	13.38	50.33	74.00	-23.67	peak
3	13930.000	34.08	16.24	50.32	74.00	-23.68	peak
4	16009.000	31.72	17.74	49.46	74.00	-24.54	peak
5	17120.000	32.04	21.20	53.24	74.00	-20.76	peak
6	17901.000	29.27	23.59	52.86	74.00	-21.14	peak

Note: 1. Measurement = Reading Level + Correct Factor.  
 2. If Peak Result complies with AV limit, AV Result is deemed to comply with AV limit.  
 3. Peak: Peak detector.  
 4. Filter losses were only considered in the spurious frequency bands and the authorized band was not corrected for HPF losses.  
 5. Proper operation of the transmitter prior to adding the filter to the measurement chain.  
 6. Owing to the highest peak level of unwanted emission out of the restricted bands complies with the lowest limit(54dBuV/m), so all the test point was deemed to comply with the limits list in the standard.



**VERTICAL RESULTS**  
**1-7GHz**

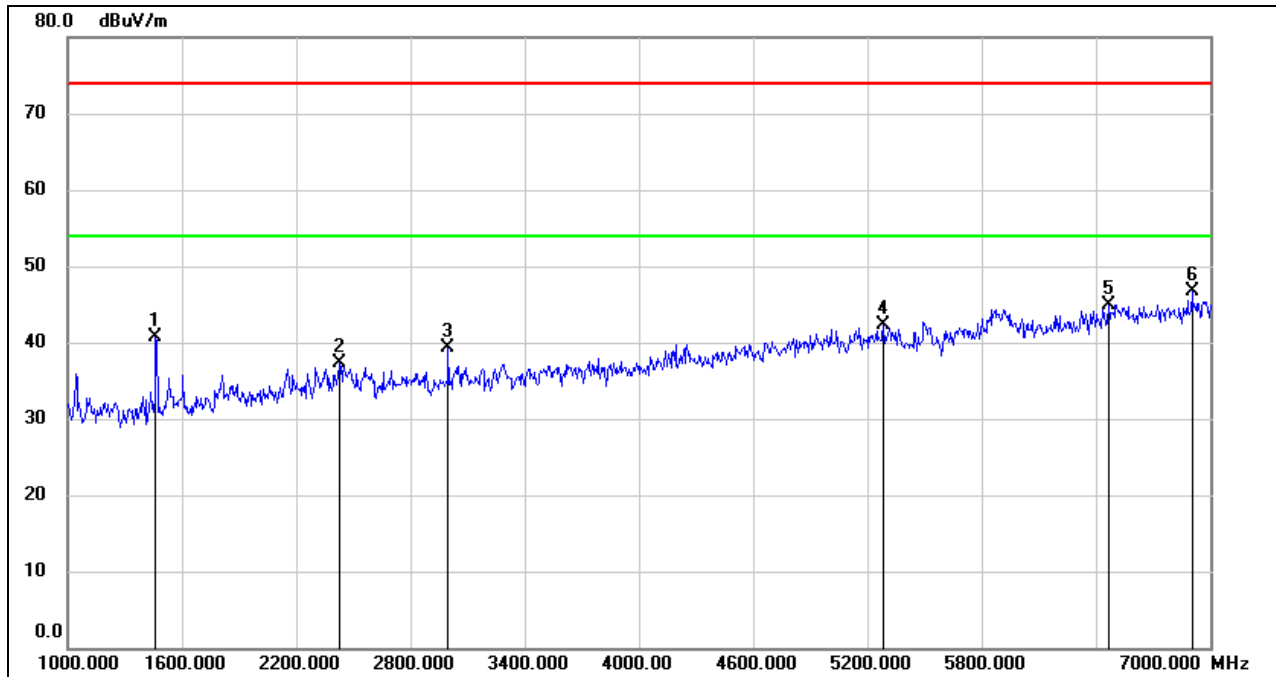

No.	Frequency (MHz)	Reading (dBuV)	Correct (dB/m)	Result (dBuV/m)	Limit (dBuV/m)	Margin (dB)	Remark
1	1462.000	53.56	-12.94	40.62	74.00	-33.38	peak
2	2428.000	45.90	-8.69	37.21	74.00	-36.79	peak
3	2998.000	45.66	-6.29	39.37	74.00	-34.63	peak
4	5284.000	40.87	1.36	42.23	74.00	-31.77	peak
5	6466.000	40.31	4.52	44.83	74.00	-29.17	peak
6	6904.000	41.42	5.20	46.62	74.00	-27.38	peak

Note: 1. Measurement = Reading Level + Correct Factor.  
 2. If Peak Result complies with AV limit, AV Result is deemed to comply with AV limit.  
 3. Peak: Peak detector.  
 4. Filter losses were only considered in the spurious frequency bands and the authorized band was not corrected for Band reject filter losses.  
 5. Proper operation of the transmitter prior to adding the filter to the measurement chain.  
 6. Owing to the highest peak level of unwanted emission out of the restricted bands complies with the lowest limit(54dBuV/m), so all the test point was deemed to comply with the limits list in the standard.



**7-18GHz**

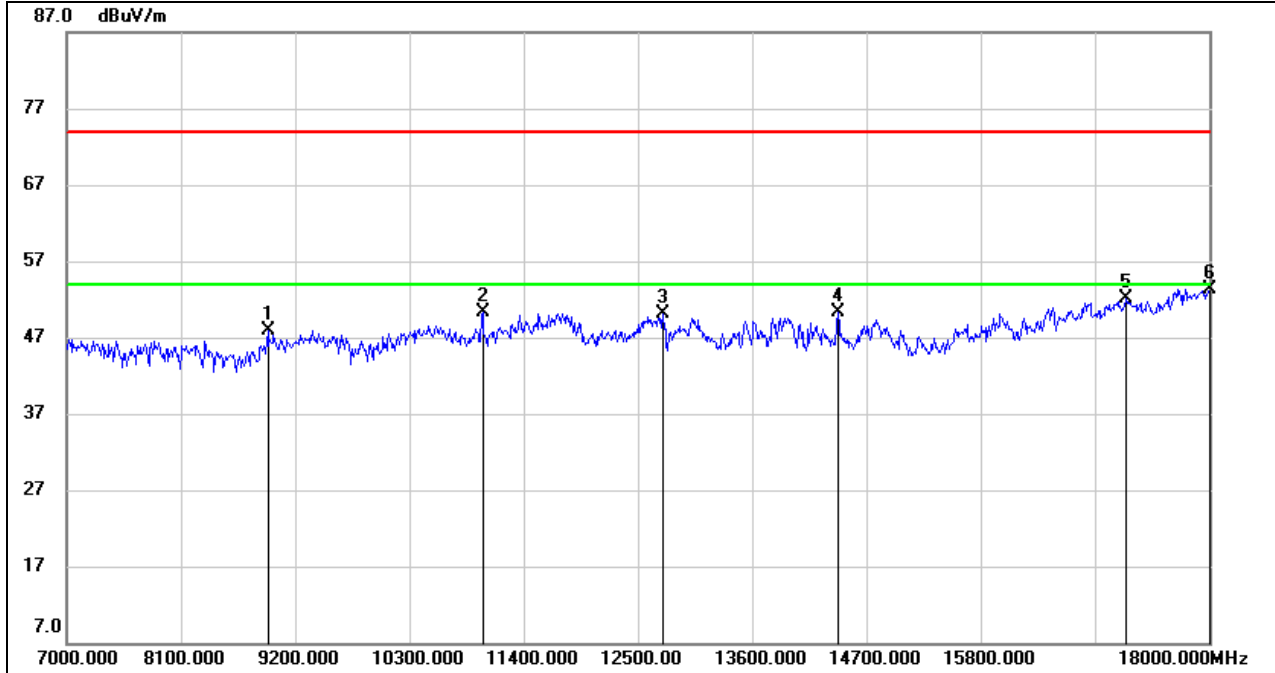

No.	Frequency (MHz)	Reading (dBuV)	Correct (dB/m)	Result (dBuV/m)	Limit (dBuV/m)	Margin (dB)	Remark
1	8936.000	38.40	9.53	47.93	74.00	-26.07	peak
2	11004.000	37.61	12.63	50.24	74.00	-23.76	peak
3	12742.000	34.81	15.28	50.09	74.00	-23.91	peak
4	14425.000	34.27	16.11	50.38	74.00	-23.62	peak
5	17197.000	30.39	21.68	52.07	74.00	-21.93	peak
6	18000.000	29.67	23.69	53.36	74.00	-20.64	peak

Note: 1. Measurement = Reading Level + Correct Factor.  
 2. If Peak Result complies with AV limit, AV Result is deemed to comply with AV limit.  
 3. Peak: Peak detector.  
 4. Filter losses were only considered in the spurious frequency bands and the authorized band was not corrected for HPF losses.  
 5. Proper operation of the transmitter prior to adding the filter to the measurement chain.  
 6. Owing to the highest peak level of unwanted emission out of the restricted bands complies with the lowest limit(54dBuV/m), so all the test point was deemed to comply with the limits list in the standard.



**HARMONICS AND SPURIOUS EMISSIONS MID CHANNEL**

**HORIZONTAL RESULTS**  
**1-7GHz**

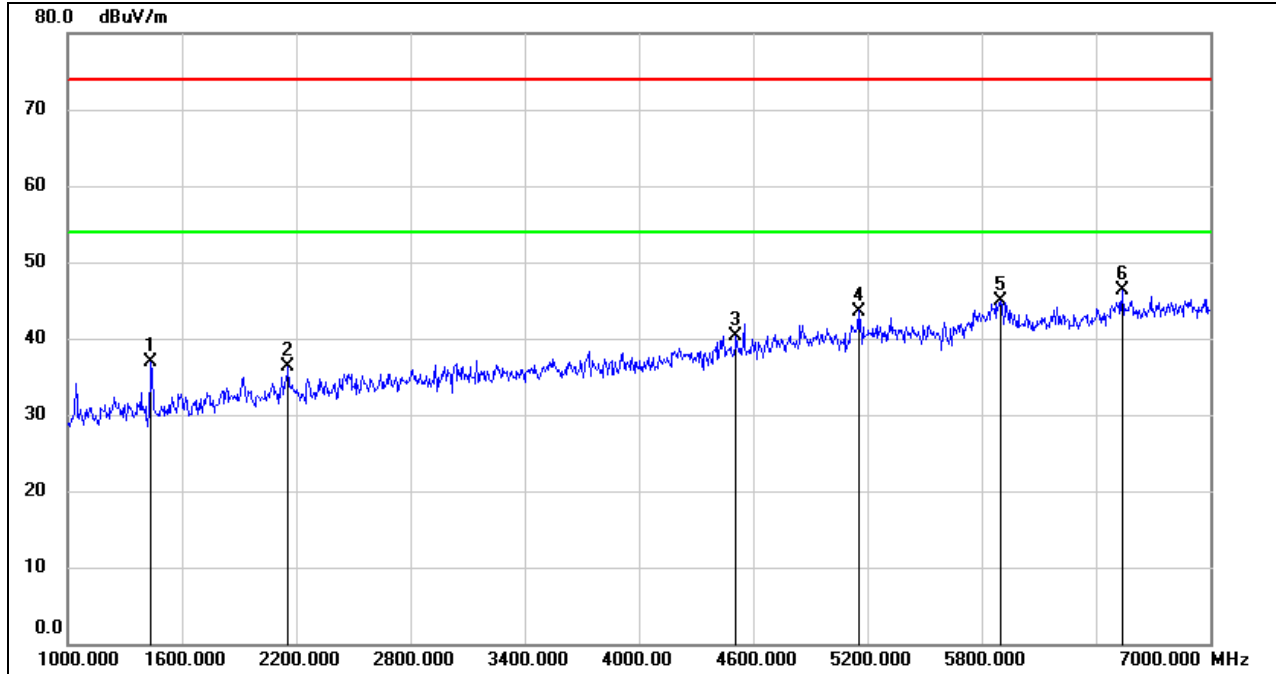

No.	Frequency (MHz)	Reading (dBuV)	Correct (dB/m)	Result (dBuV/m)	Limit (dBuV/m)	Margin (dB)	Remark
1	1438.000	49.82	-12.99	36.83	74.00	-37.17	peak
2	2158.000	46.20	-9.83	36.37	74.00	-37.63	peak
3	4510.000	42.08	-1.75	40.33	74.00	-33.67	peak
4	5152.000	42.52	1.08	43.60	74.00	-30.40	peak
5	5902.000	40.72	4.28	45.00	74.00	-29.00	peak
6	6538.000	41.56	4.82	46.38	74.00	-27.62	peak

Note: 1. Measurement = Reading Level + Correct Factor.  
 2. If Peak Result complies with AV limit, AV Result is deemed to comply with AV limit.  
 3. Peak: Peak detector.  
 4. Filter losses were only considered in the spurious frequency bands and the authorized band was not corrected for Band reject filter losses.  
 5. Proper operation of the transmitter prior to adding the filter to the measurement chain.  
 6. Owing to the highest peak level of unwanted emission out of the restricted bands complies with the lowest limit(54dBuV/m), so all the test point was deemed to comply with the limits list in the standard.



**HORIZONTAL RESULTS**  
**7-18GHz**

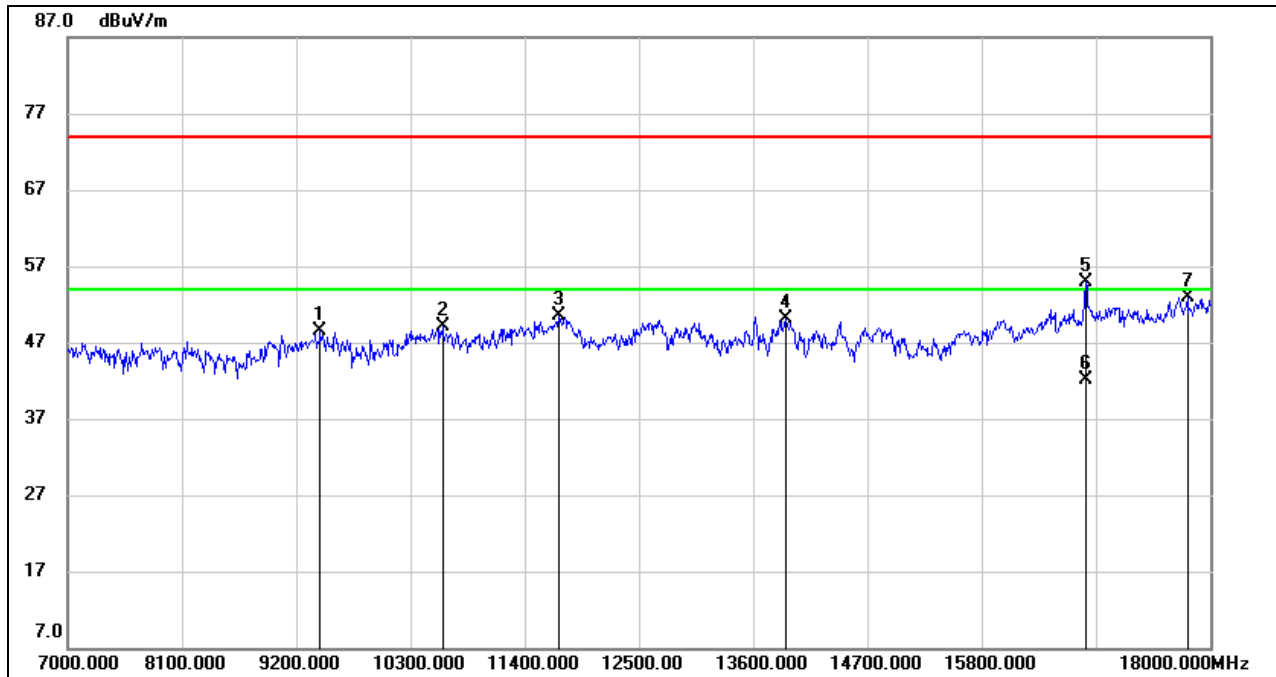

No.	Frequency (MHz)	Reading (dBuV)	Correct (dB/m)	Result (dBuV/m)	Limit (dBuV/m)	Margin (dB)	Remark
1	9431.000	38.44	10.09	48.53	74.00	-25.47	peak
2	10608.000	37.22	11.86	49.08	74.00	-24.92	peak
3	11730.000	36.29	14.25	50.54	74.00	-23.46	peak
4	13908.000	33.88	16.26	50.14	74.00	-23.86	peak
5	16800.000	34.84	20.12	54.96	74.00	-19.04	peak
6	16800.000	22.04	20.12	42.16	54.00	-11.84	AVG
7	17780.000	29.58	23.35	52.93	74.00	-21.07	peak

Note: 1. Measurement = Reading Level + Correct Factor.  
 2. If Peak Result complies with AV limit, AV Result is deemed to comply with AV limit.  
 3. Peak: Peak detector.  
 4. Filter losses were only considered in the spurious frequency bands and the authorized band was not corrected for HPF losses.  
 5. Proper operation of the transmitter prior to adding the filter to the measurement chain.  
 6. Owing to the highest peak level of unwanted emission out of the restricted bands complies with the lowest limit(54dBuV/m), so all the test point was deemed to comply with the limits list in the standard.



**VERTICAL RESULTS**  
**1-7GHz**

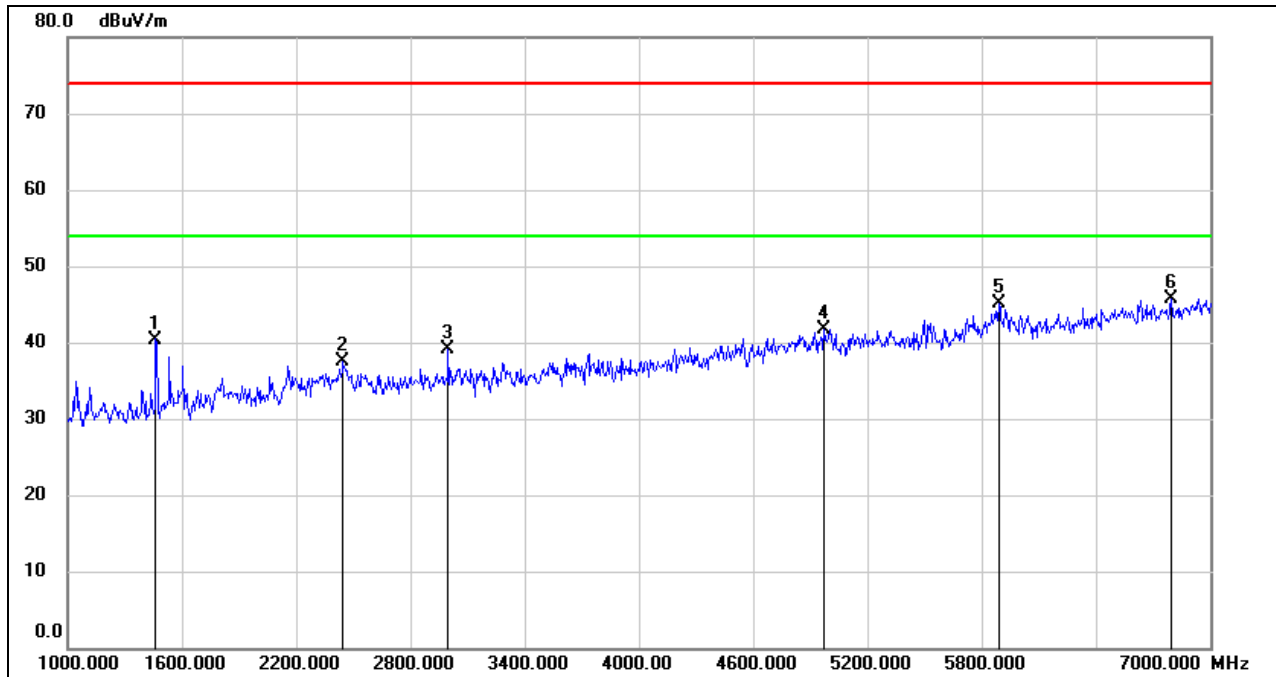

No.	Frequency (MHz)	Reading (dBuV)	Correct (dB/m)	Result (dBuV/m)	Limit (dBuV/m)	Margin (dB)	Remark
1	1462.000	53.34	-12.94	40.40	74.00	-33.60	peak
2	2446.000	45.95	-8.54	37.41	74.00	-36.59	peak
3	2998.000	45.42	-6.29	39.13	74.00	-34.87	peak
4	4972.000	41.19	0.48	41.67	74.00	-32.33	peak
5	5890.000	40.93	4.15	45.08	74.00	-28.92	peak
6	6796.000	41.24	4.54	45.78	74.00	-28.22	peak

Note: 1. Measurement = Reading Level + Correct Factor.  
 2. If Peak Result complies with AV limit, AV Result is deemed to comply with AV limit.  
 3. Peak: Peak detector.  
 4. Filter losses were only considered in the spurious frequency bands and the authorized band was not corrected for Band reject filter losses.  
 5. Proper operation of the transmitter prior to adding the filter to the measurement chain.  
 6. Owing to the highest peak level of unwanted emission out of the restricted bands complies with the lowest limit(54dBuV/m), so all the test point was deemed to comply with the limits list in the standard.



**7-18GHz**

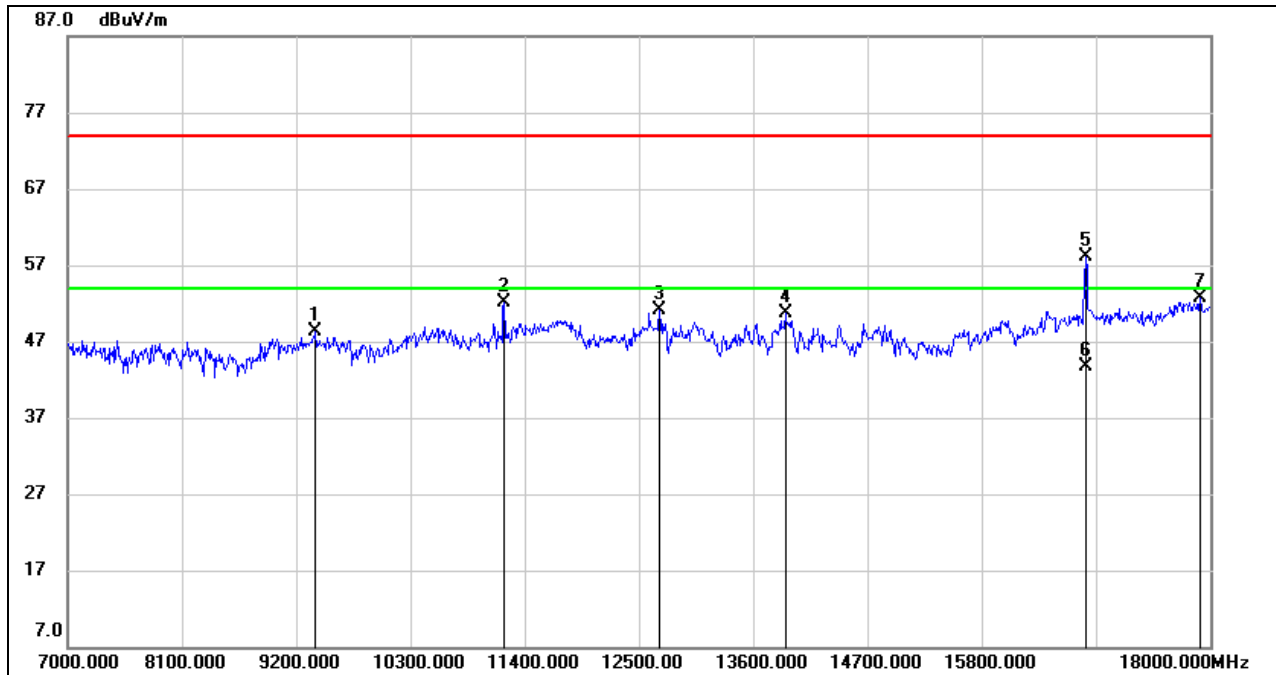

No.	Frequency (MHz)	Reading (dBuV)	Correct (dB/m)	Result (dBuV/m)	Limit (dBuV/m)	Margin (dB)	Remark
1	9387.000	38.37	9.94	48.31	74.00	-25.69	peak
2	11202.000	39.08	13.04	52.12	74.00	-21.88	peak
3	12698.000	35.88	15.25	51.13	74.00	-22.87	peak
4	13908.000	34.49	16.26	50.75	74.00	-23.25	peak
5	16800.000	37.89	20.12	58.01	74.00	-15.99	peak
6	16800.000	23.60	20.12	43.72	54.00	-10.28	AVG
7	17901.000	29.04	23.59	52.63	74.00	-21.37	peak

Note: 1. Measurement = Reading Level + Correct Factor.  
 2. If Peak Result complies with AV limit, AV Result is deemed to comply with AV limit.  
 3. Peak: Peak detector.  
 4. Filter losses were only considered in the spurious frequency bands and the authorized band was not corrected for HPF losses.  
 5. Proper operation of the transmitter prior to adding the filter to the measurement chain.  
 6. Owing to the highest peak level of unwanted emission out of the restricted bands complies with the lowest limit(54dBuV/m), so all the test point was deemed to comply with the limits list in the standard.





**HARMONICS AND SPURIOUS EMISSIONS HIGH CHANNEL**

**HORIZONTAL RESULTS**  
**1-7GHz**

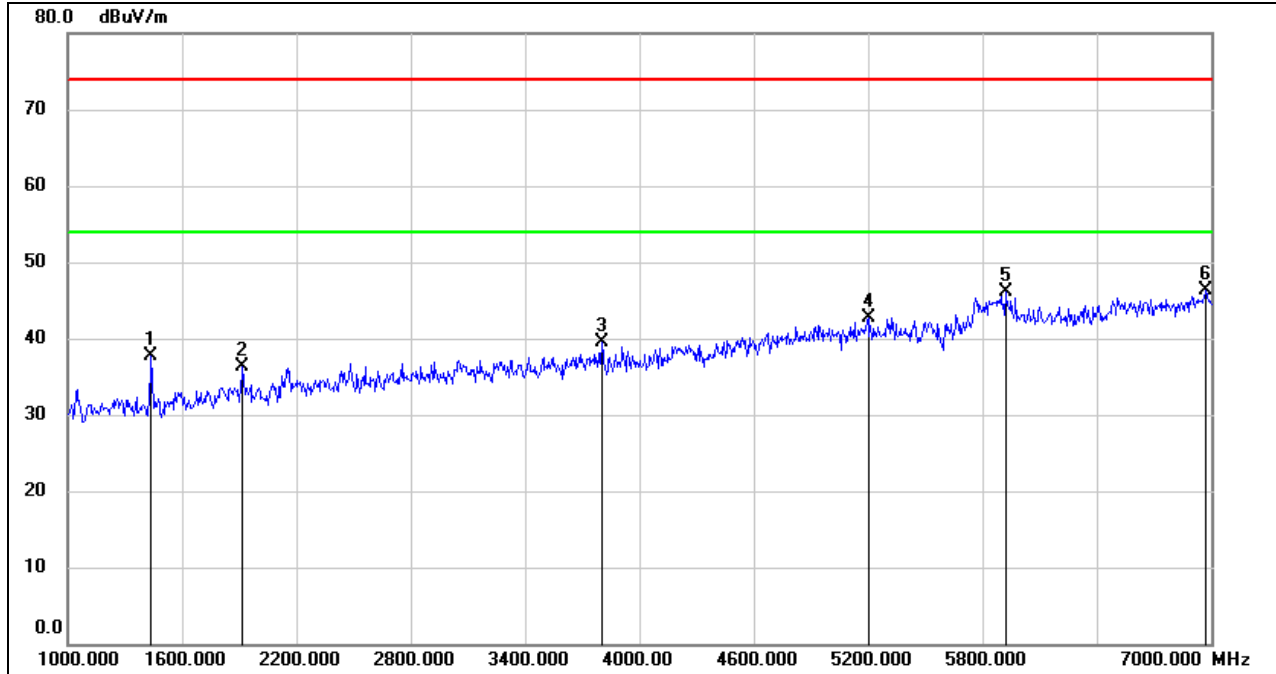

No.	Frequency (MHz)	Reading (dBuV)	Correct (dB/m)	Result (dBuV/m)	Limit (dBuV/m)	Margin (dB)	Remark
1	1438.000	50.62	-12.99	37.63	74.00	-36.37	peak
2	1918.000	47.02	-10.65	36.37	74.00	-37.63	peak
3	3802.000	43.76	-4.30	39.46	74.00	-34.54	peak
4	5200.000	41.31	1.38	42.69	74.00	-31.31	peak
5	5920.000	42.08	3.98	46.06	74.00	-27.94	peak
6	6970.000	41.07	5.25	46.32	74.00	-27.68	peak

- Note: 1. Measurement = Reading Level + Correct Factor.  
 2. If Peak Result complies with AV limit, AV Result is deemed to comply with AV limit.  
 3. Peak: Peak detector.  
 4. Filter losses were only considered in the spurious frequency bands and the authorized band was not corrected for Band reject filter losses.  
 5. Proper operation of the transmitter prior to adding the filter to the measurement chain.  
 6. Owing to the highest peak level of unwanted emission out of the restricted bands complies with the lowest limit(54dBuV/m), so all the test point was deemed to comply with the limits list in the standard.



**HORIZONTAL RESULTS**  
**7-18GHz**

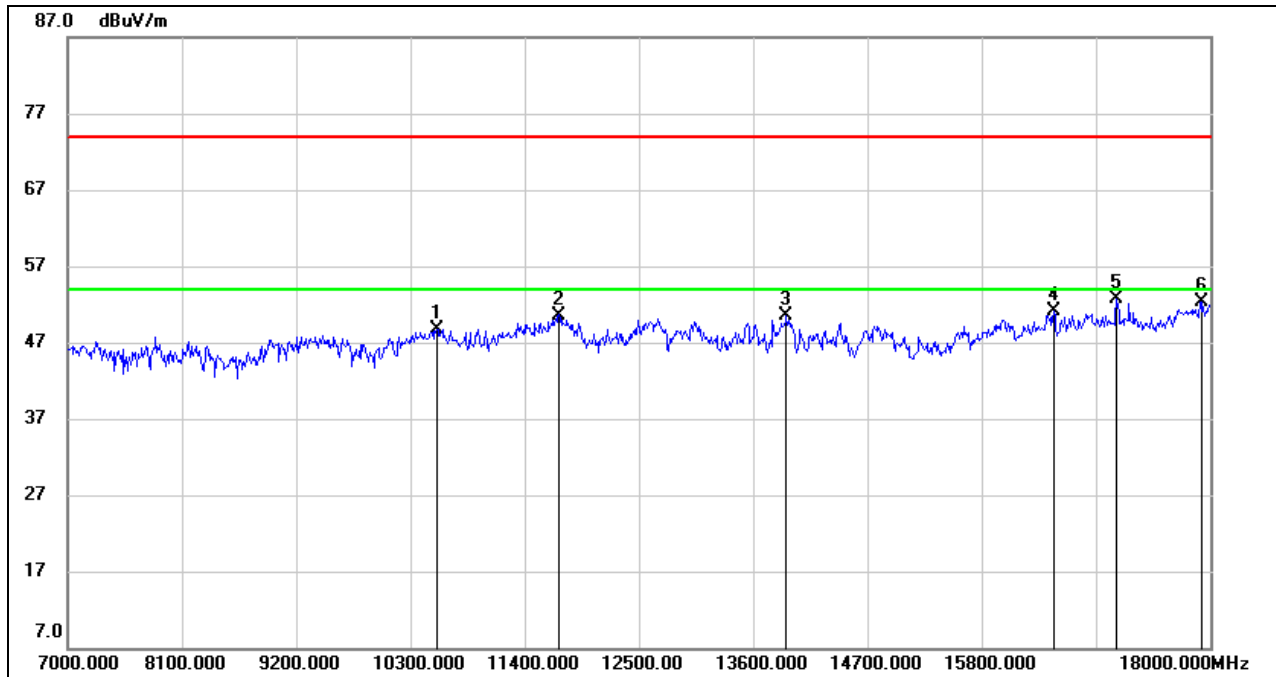

No.	Frequency (MHz)	Reading (dBuV)	Correct (dB/m)	Result (dBuV/m)	Limit (dBuV/m)	Margin (dB)	Remark
1	10553.000	37.03	11.70	48.73	74.00	-25.27	peak
2	11730.000	36.35	14.25	50.60	74.00	-23.40	peak
3	13919.000	34.35	16.24	50.59	74.00	-23.41	peak
4	16493.000	31.67	19.42	51.09	74.00	-22.91	peak
5	17098.000	31.65	21.07	52.72	74.00	-21.28	peak
6	17923.000	28.76	23.61	52.37	74.00	-21.63	peak

Note: 1. Measurement = Reading Level + Correct Factor.  
 2. If Peak Result complies with AV limit, AV Result is deemed to comply with AV limit.  
 3. Peak: Peak detector.  
 4. Filter losses were only considered in the spurious frequency bands and the authorized band was not corrected for HPF losses.  
 5. Proper operation of the transmitter prior to adding the filter to the measurement chain.  
 6. Owing to the highest peak level of unwanted emission out of the restricted bands complies with the lowest limit(54dBuV/m), so all the test point was deemed to comply with the limits list in the standard.



**VERTICAL RESULTS**  
**1-7GHz**

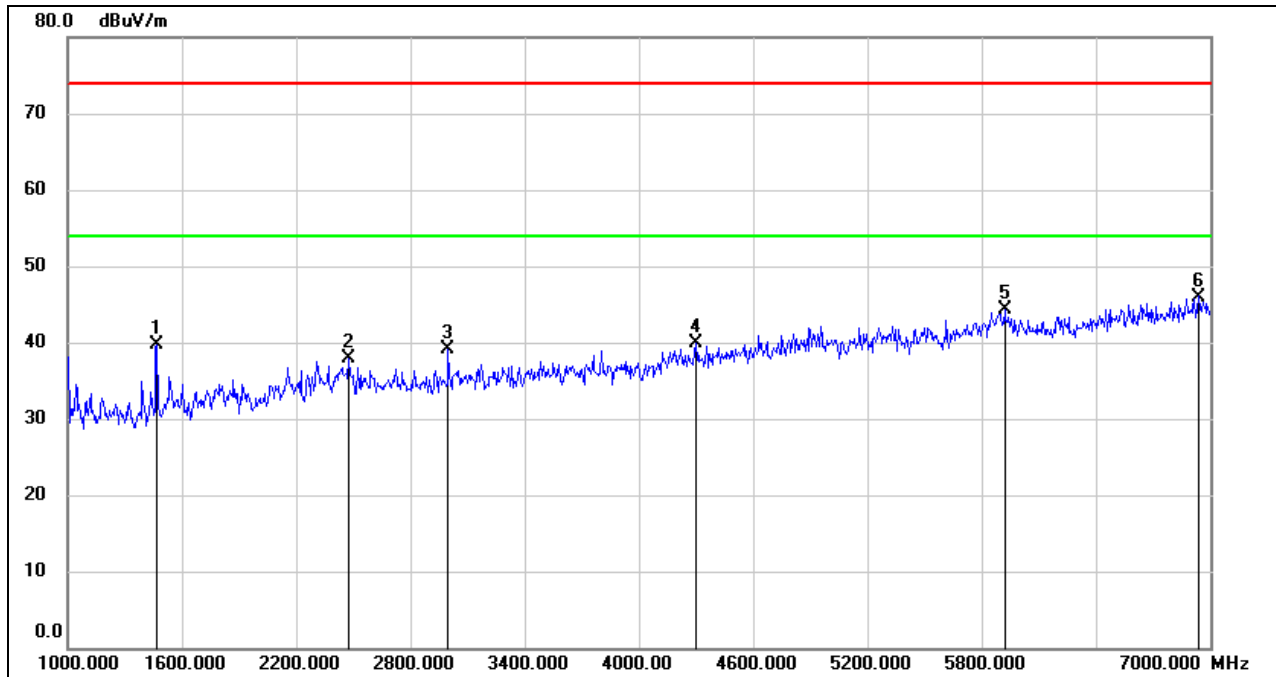

No.	Frequency (MHz)	Reading (dBuV)	Correct (dB/m)	Result (dBuV/m)	Limit (dBuV/m)	Margin (dB)	Remark
1	1468.000	52.67	-12.93	39.74	74.00	-34.26	peak
2	2476.000	46.21	-8.28	37.93	74.00	-36.07	peak
3	2998.000	45.36	-6.29	39.07	74.00	-34.93	peak
4	4300.000	43.05	-3.12	39.93	74.00	-34.07	peak
5	5920.000	40.32	3.98	44.30	74.00	-29.70	peak
6	6940.000	40.78	5.22	46.00	74.00	-28.00	peak

Note: 1. Measurement = Reading Level + Correct Factor.  
 2. If Peak Result complies with AV limit, AV Result is deemed to comply with AV limit.  
 3. Peak: Peak detector.  
 4. Filter losses were only considered in the spurious frequency bands and the authorized band was not corrected for Band reject filter losses.  
 5. Proper operation of the transmitter prior to adding the filter to the measurement chain.  
 6. Owing to the highest peak level of unwanted emission out of the restricted bands complies with the lowest limit(54dBuV/m), so all the test point was deemed to comply with the limits list in the standard.



**7-18GHz**

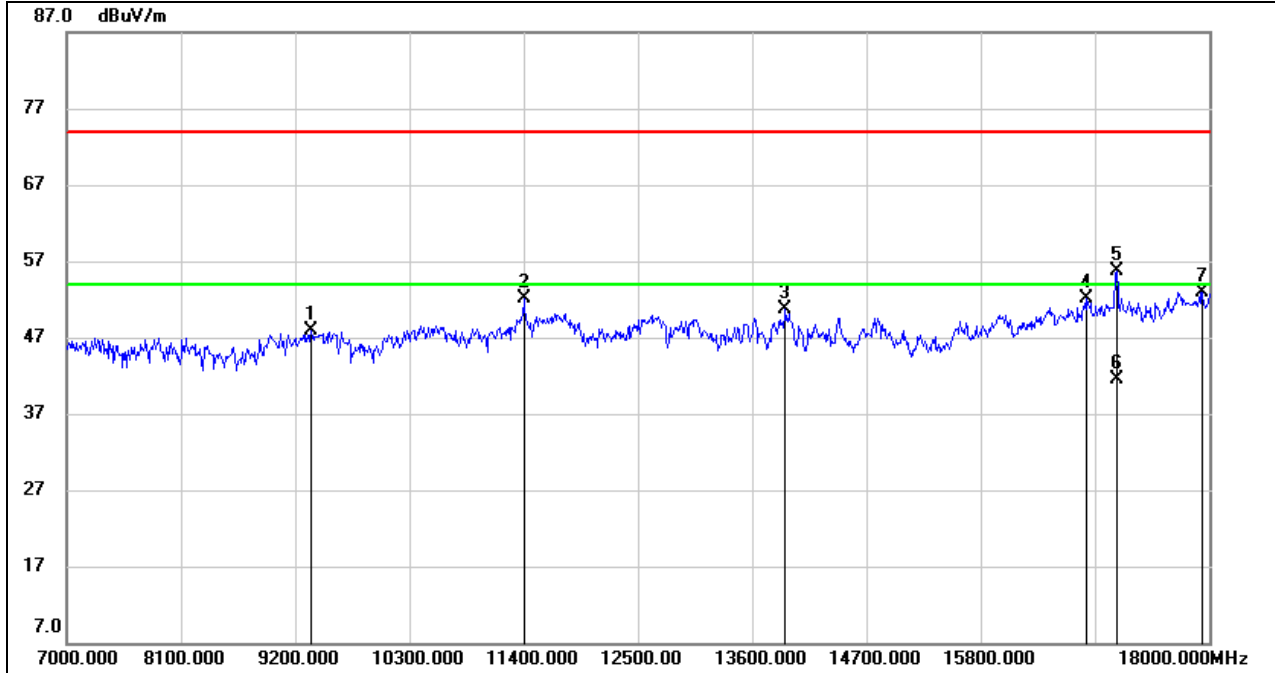

No.	Frequency (MHz)	Reading (dBuV)	Correct (dB/m)	Result (dBuV/m)	Limit (dBuV/m)	Margin (dB)	Remark
1	9354.000	38.05	9.78	47.83	74.00	-26.17	peak
2	11400.000	38.60	13.45	52.05	74.00	-21.95	peak
3	13919.000	34.39	16.24	50.63	74.00	-23.37	peak
4	16812.000	31.91	20.14	52.05	74.00	-21.95	peak
5	17100.000	34.54	21.08	55.62	74.00	-18.38	peak
6	17100.000	20.50	21.08	41.58	54.00	-12.42	AVG
7	17934.000	29.37	23.62	52.99	74.00	-21.01	peak

Note: 1. Measurement = Reading Level + Correct Factor.  
 2. If Peak Result complies with AV limit, AV Result is deemed to comply with AV limit.  
 3. Peak: Peak detector.  
 4. Filter losses were only considered in the spurious frequency bands and the authorized band was not corrected for HPF losses.  
 5. Proper operation of the transmitter prior to adding the filter to the measurement chain.  
 6. Owing to the highest peak level of unwanted emission out of the restricted bands complies with the lowest limit(54dBuV/m), so all the test point was deemed to comply with the limits list in the standard.



### 8.1.4. STRADDLE CHANNEL 144

#### HARMONICS AND SPURIOUS EMISSIONS HIGH CHANNEL

#### HORIZONTAL RESULTS 1-7GHz

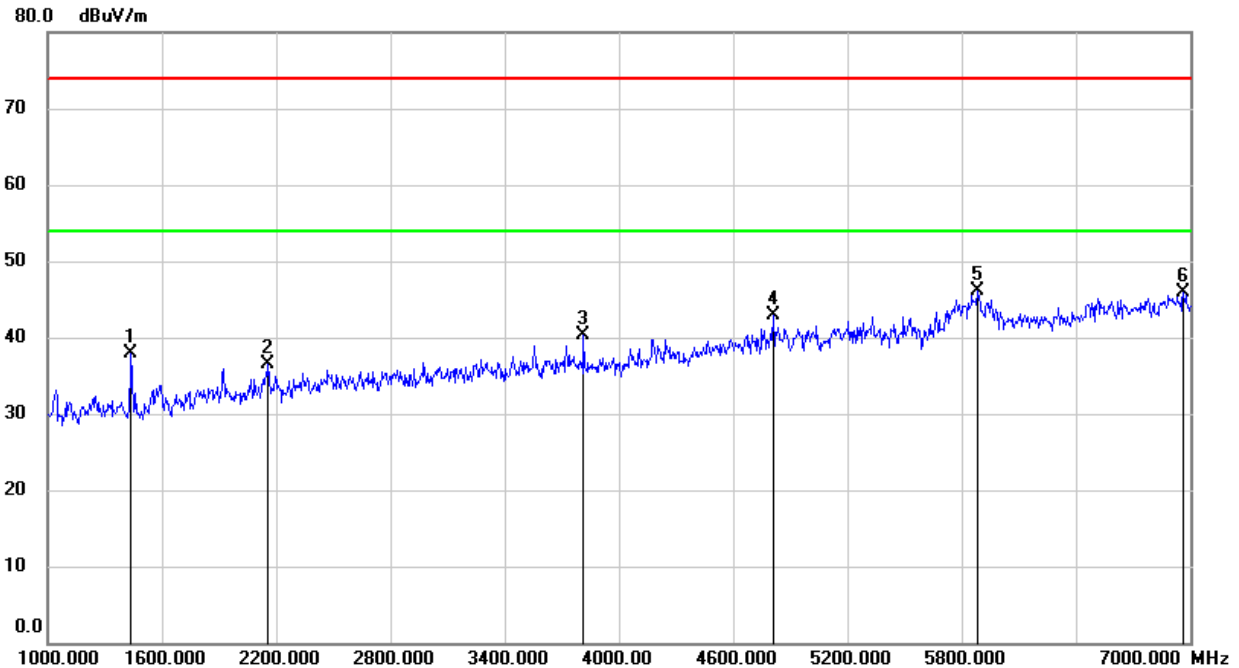

No.	Frequency (MHz)	Reading (dBuV)	Correct (dB/m)	Result (dBuV/m)	Limit (dBuV/m)	Margin (dB)	Remark
1	1438.000	50.90	-12.99	37.91	74.00	-36.09	peak
2	2158.000	46.43	-9.83	36.60	74.00	-37.40	peak
3	3814.000	44.58	-4.29	40.29	74.00	-33.71	peak
4	4810.000	43.15	-0.33	42.82	74.00	-31.18	peak
5	5884.000	42.06	4.03	46.09	74.00	-27.91	peak
6	6964.000	40.61	5.25	45.86	74.00	-28.14	peak

Note: 1. Measurement = Reading Level + Correct Factor.  
 2. If Peak Result complies with AV limit, AV Result is deemed to comply with AV limit.  
 3. Peak: Peak detector.  
 4. Filter losses were only considered in the spurious frequency bands and the authorized band was not corrected for Band reject filter losses.  
 5. Proper operation of the transmitter prior to adding the filter to the measurement chain.  
 6. Owing to the highest peak level of unwanted emission out of the restricted bands complies with the lowest limit(54dBuV/m), so all the test point were deemed to comply with the limits list in the standard.



**HORIZONTAL RESULTS**  
**7-18GHz**

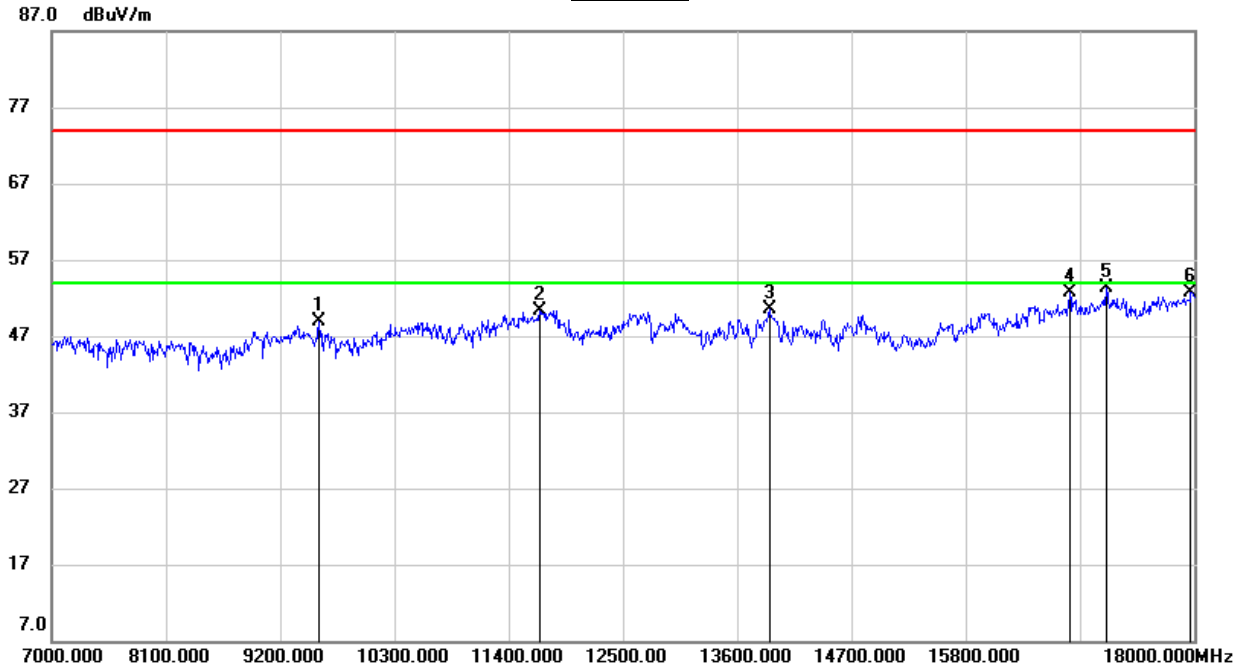

No.	Frequency (MHz)	Reading (dBuV)	Correct (dB/m)	Result (dBuV/m)	Limit (dBuV/m)	Margin (dB)	Remark
1	9574.000	38.36	10.49	48.85	74.00	-25.15	peak
2	11697.000	36.16	14.11	50.27	74.00	-23.73	peak
3	13908.000	34.31	16.26	50.57	74.00	-23.43	peak
4	16801.000	32.52	20.12	52.64	74.00	-21.36	peak
5	17153.000	31.86	21.40	53.26	74.00	-20.74	peak
6	17967.000	29.07	23.65	52.72	74.00	-21.28	peak

Note: 1. Measurement = Reading Level + Correct Factor.  
 2. If Peak Result complies with AV limit, AV Result is deemed to comply with AV limit.  
 3. Peak: Peak detector.  
 4. Filter losses were only considered in the spurious frequency bands and the authorized band was not corrected for HPF losses.  
 5. Proper operation of the transmitter prior to adding the filter to the measurement chain.  
 6. Owing to the highest peak level of unwanted emission out of the restricted bands complies with the lowest limit(54dBuV/m), so all the test point were deemed to comply with the limits list in the standard.



**VERTICAL RESULTS**  
**1-7GHz**

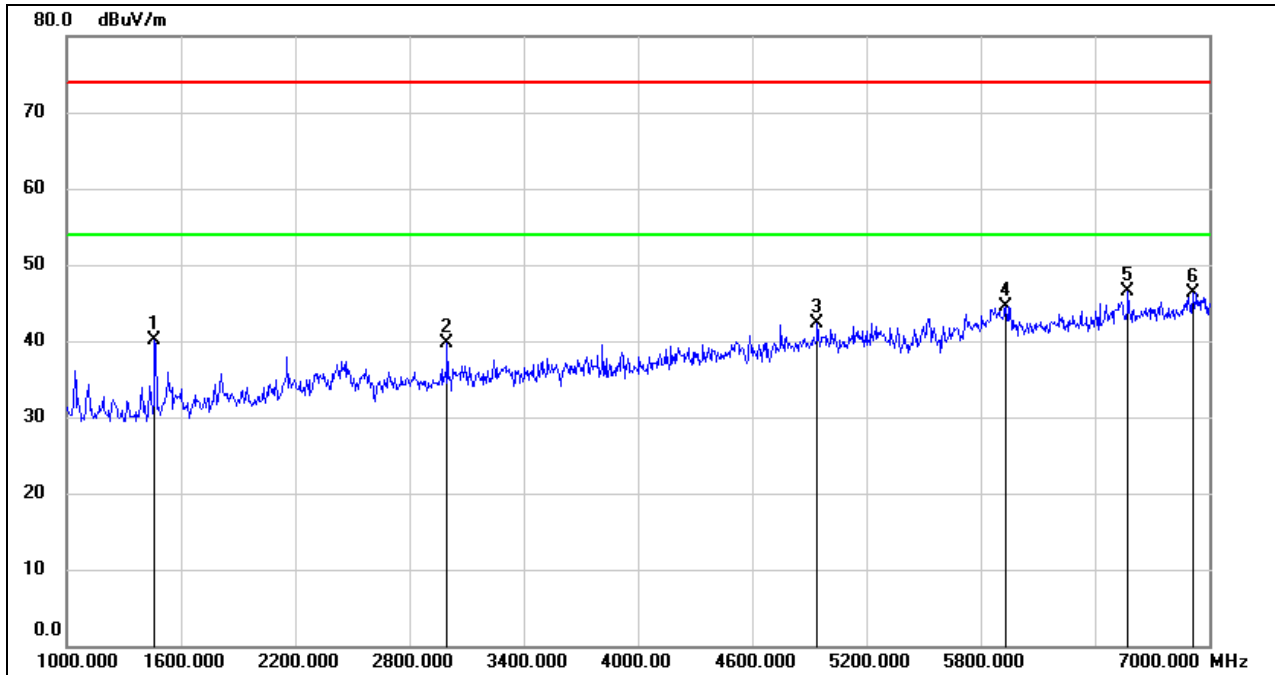

No.	Frequency (MHz)	Reading (dBuV)	Correct (dB/m)	Result (dBuV/m)	Limit (dBuV/m)	Margin (dB)	Remark
1	1462.000	53.06	-12.94	40.12	74.00	-33.88	peak
2	2998.000	46.02	-6.29	39.73	74.00	-34.27	peak
3	4942.000	42.11	0.22	42.33	74.00	-31.67	peak
4	5932.000	40.72	3.77	44.49	74.00	-29.51	peak
5	6574.000	41.81	4.66	46.47	74.00	-27.53	peak
6	6916.000	41.18	5.20	46.38	74.00	-27.62	peak

Note: 1. Measurement = Reading Level + Correct Factor.  
 2. If Peak Result complies with AV limit, AV Result is deemed to comply with AV limit.  
 3. Peak: Peak detector.  
 4. Filter losses were only considered in the spurious frequency bands and the authorized band was not corrected for Band reject filter losses.  
 5. Proper operation of the transmitter prior to adding the filter to the measurement chain.  
 6. Owing to the highest peak level of unwanted emission out of the restricted bands complies with the lowest limit(54dBuV/m), so all the test point were deemed to comply with the limits list in the standard.



**7-18GHz**

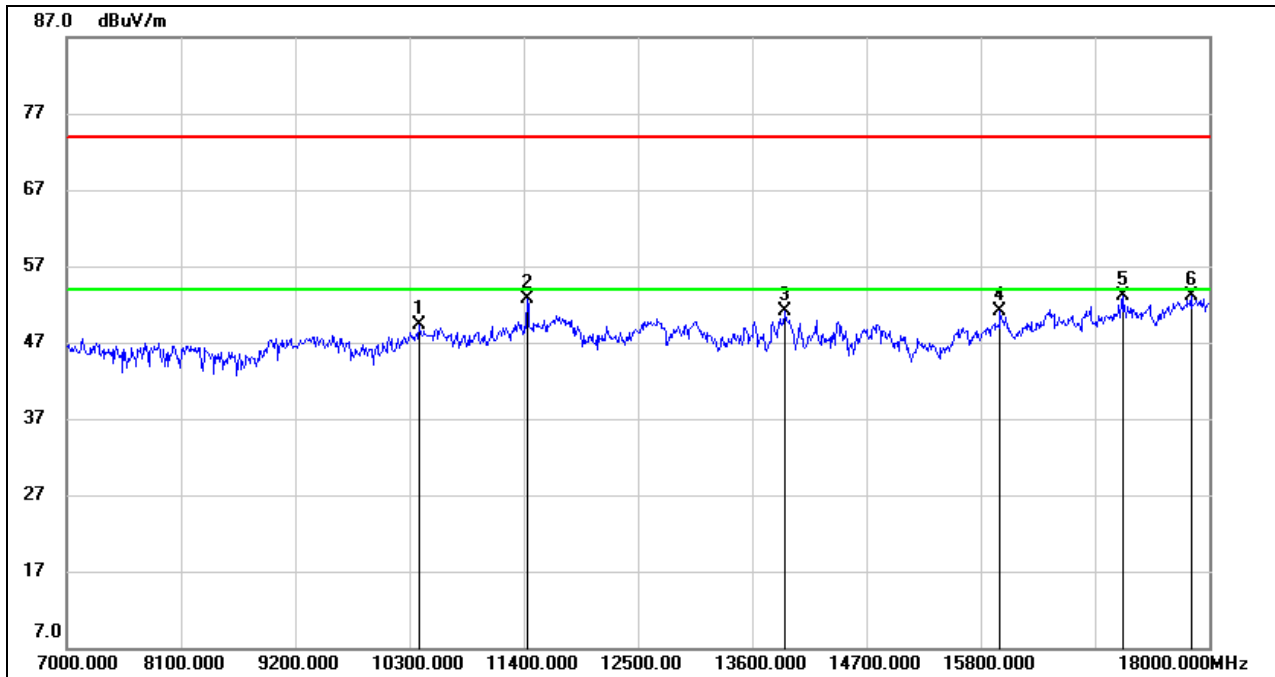

No.	Frequency (MHz)	Reading (dBuV)	Correct (dB/m)	Result (dBuV/m)	Limit (dBuV/m)	Margin (dB)	Remark
1	10388.000	38.23	11.06	49.29	74.00	-24.71	peak
2	11433.000	39.11	13.50	52.61	74.00	-21.39	peak
3	13919.000	34.91	16.24	51.15	74.00	-22.85	peak
4	15987.000	33.40	17.68	51.08	74.00	-22.92	peak
5	17164.000	31.69	21.47	53.16	74.00	-20.84	peak
6	17824.000	29.63	23.52	53.15	74.00	-20.85	peak

Note: 1. Measurement = Reading Level + Correct Factor.  
 2. If Peak Result complies with AV limit, AV Result is deemed to comply with AV limit.  
 3. Peak: Peak detector.  
 4. Filter losses were only considered in the spurious frequency bands and the authorized band was not corrected for HPF losses.  
 5. Proper operation of the transmitter prior to adding the filter to the measurement chain.  
 6. Owing to the highest peak level of unwanted emission out of the restricted bands complies with the lowest limit(54dBuV/m), so all the test point were deemed to comply with the limits list in the standard.





**8.1.5. UNII-3 BAND**  
**WORST CASE FOR ANT1**

**RESTRICTED BANDEDGE LOW CHANNEL**

**HORIZONTAL RESULTS**  
**PEAK**

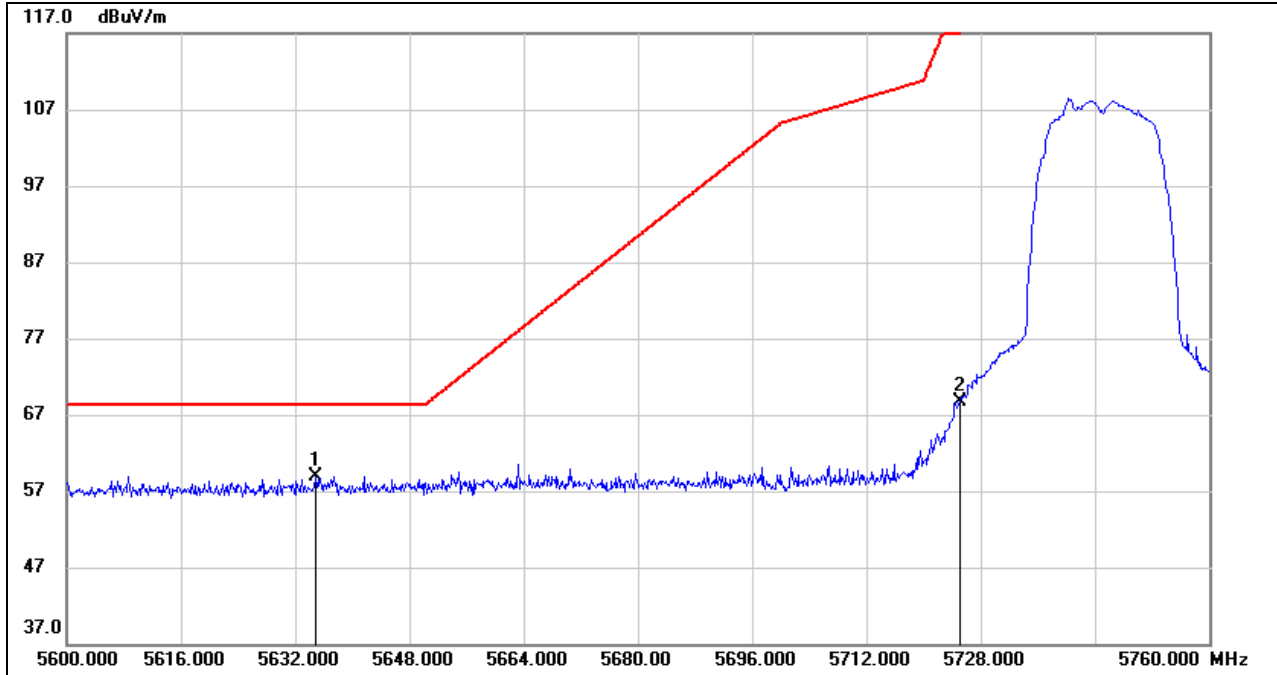

No.	Frequency (MHz)	Reading (dBuV)	Correct (dB/m)	Result (dBuV/m)	Limit (dBuV/m)	Margin (dB)	Remark
1	5634.880	17.42	41.47	58.89	68.20	-9.31	peak
2	5725.000	27.13	41.61	68.74	122.20	-53.46	peak

Note: 1. Measurement = Reading Level + Correct Factor.



**VERTICAL RESULTS**  
**PEAK**

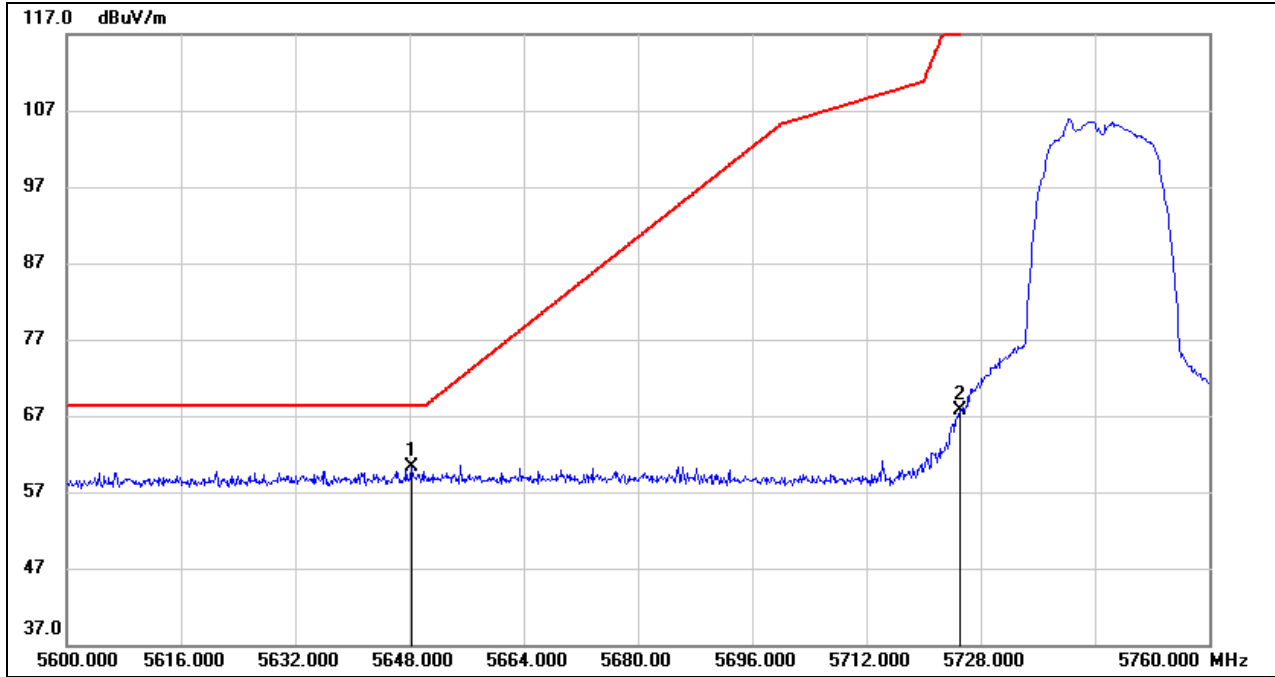

No.	Frequency (MHz)	Reading (dBuV)	Correct (dB/m)	Result (dBuV/m)	Limit (dBuV/m)	Margin (dB)	Remark
1	5648.320	18.86	41.48	60.34	68.20	-7.86	peak
2	5725.000	26.13	41.61	67.74	122.20	-54.46	peak

Note: 1. Measurement = Reading Level + Correct Factor.



**RESTRICTED BANDEDGE HIGH CHANNEL**

**HORIZONTAL RESULTS**  
**PEAK**

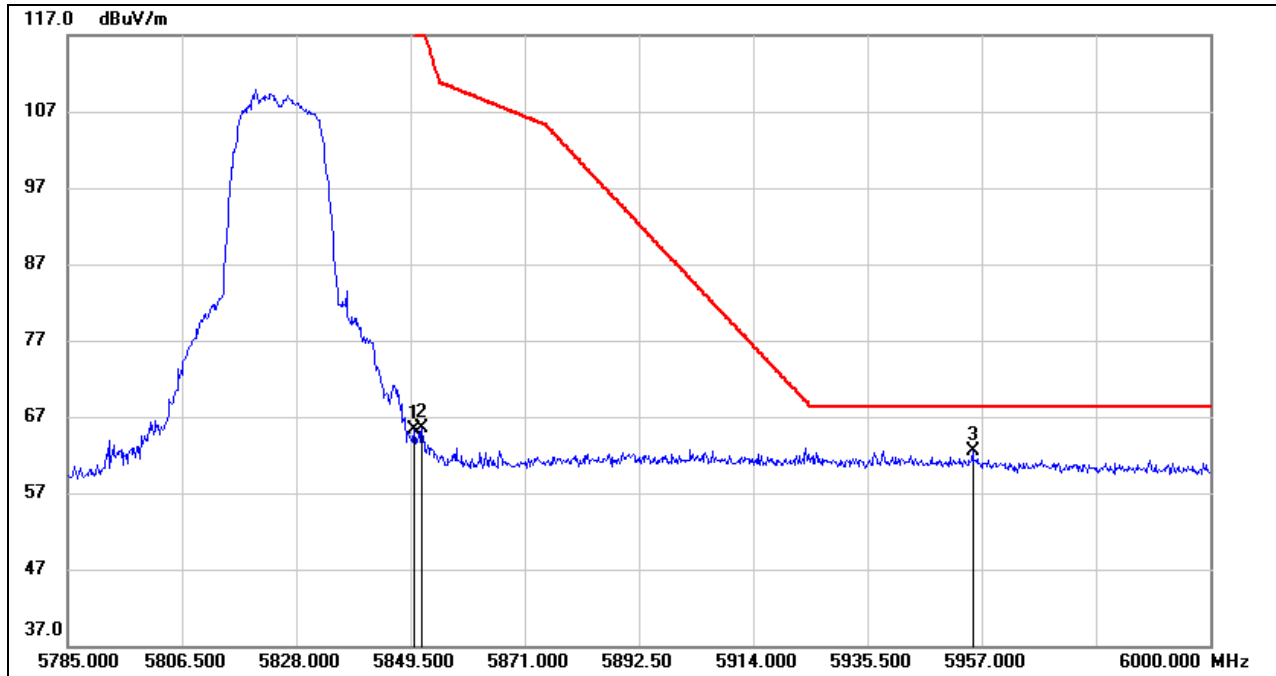

No.	Frequency (MHz)	Reading (dBuV)	Correct (dB/m)	Result (dBuV/m)	Limit (dBuV/m)	Margin (dB)	Remark
1	5850.000	22.38	42.89	65.27	122.20	-56.93	peak
2	5851.650	22.51	42.92	65.43	118.44	-53.01	peak
3	5955.280	19.68	42.91	62.59	68.20	-5.61	peak

Note: 1. Measurement = Reading Level + Correct Factor.



**VERTICAL RESULTS**  
**PEAK**

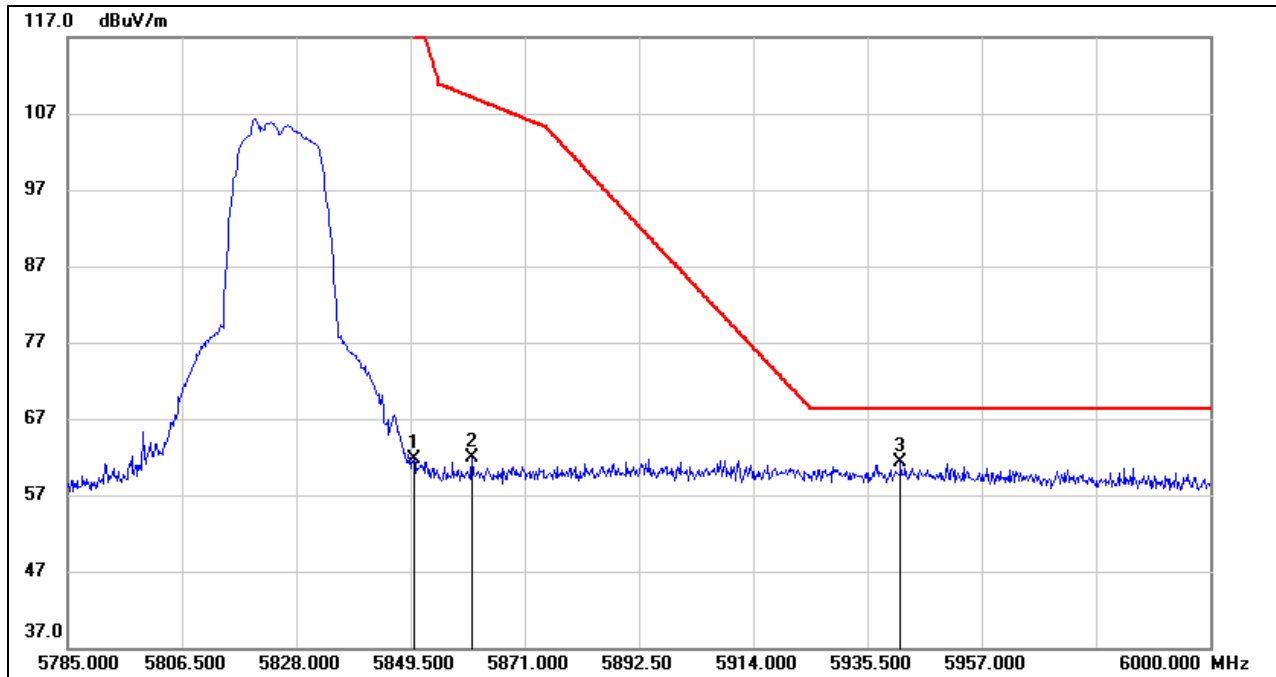

No.	Frequency (MHz)	Reading (dBuV)	Correct (dB/m)	Result (dBuV/m)	Limit (dBuV/m)	Margin (dB)	Remark
1	5850.000	18.82	42.89	61.71	122.20	-60.49	peak
2	5861.110	18.81	43.10	61.91	109.09	-47.18	peak
3	5941.735	18.09	43.14	61.23	68.20	-6.97	peak

Note: 1. Measurement = Reading Level + Correct Factor.



**HARMONICS AND SPURIOUS EMISSIONS LOW CHANNEL**

**HORIZONTAL RESULTS  
1-7GHz**

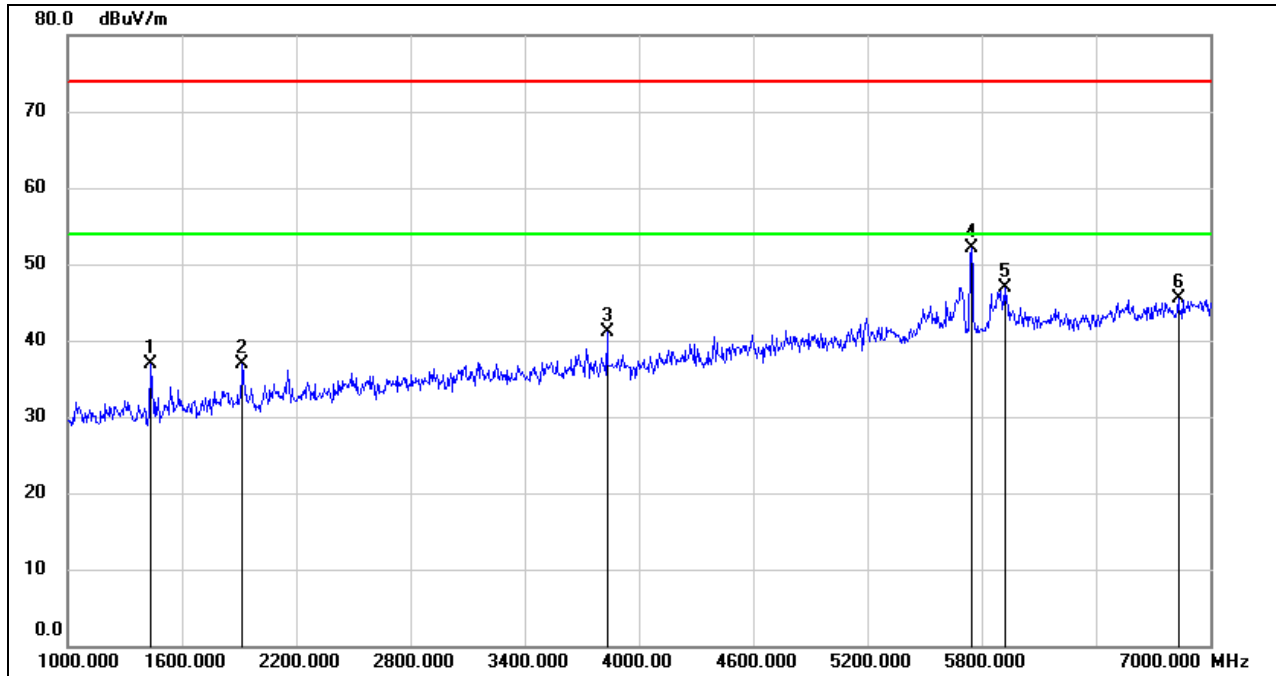

No.	Frequency (MHz)	Reading (dBuV)	Correct (dB/m)	Result (dBuV/m)	Limit (dBuV/m)	Margin (dB)	Remark
1	1438.000	49.86	-12.99	36.87	74.00	-37.13	peak
2	1918.000	47.58	-10.65	36.93	74.00	-37.07	peak
3	3832.000	45.38	-4.29	41.09	74.00	-32.91	peak
4	5746.000	49.82	2.22	52.04	74.00	-21.96	peak
5	5920.000	43.01	3.98	46.99	74.00	-27.01	peak
6	6832.000	40.75	4.76	45.51	74.00	-28.49	peak

Note: 1. Measurement = Reading Level + Correct Factor.  
 2. If Peak Result complies with AV limit, AV Result is deemed to comply with AV limit.  
 3. Peak: Peak detector.  
 4. Filter losses were only considered in the spurious frequency bands and the authorized band was not corrected for Band reject filter losses.  
 5. Proper operation of the transmitter prior to adding the filter to the measurement chain.  
 6. Owing to the highest peak level of unwanted emission out of the restricted bands complies with the lowest limit(54dBuV/m), so all the test point was deemed to comply with the limits list in the standard.



**HORIZONTAL RESULTS**  
**7-18GHz**

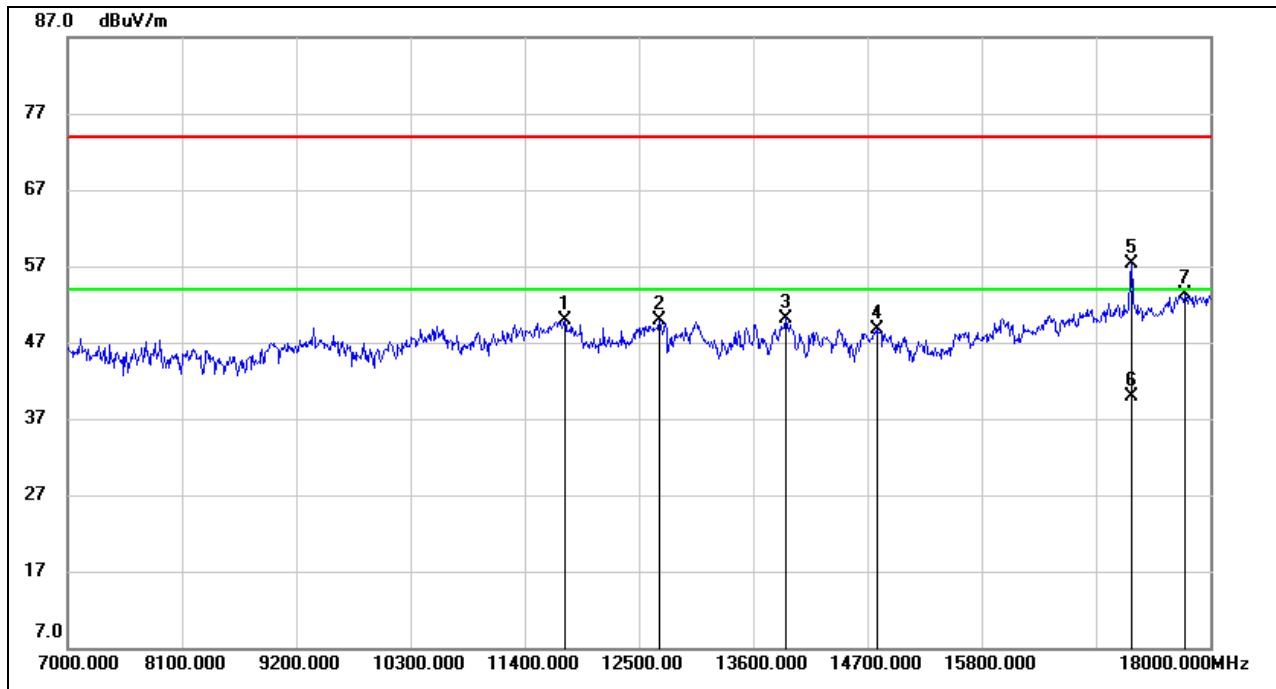

No.	Frequency (MHz)	Reading (dBuV)	Correct (dB/m)	Result (dBuV/m)	Limit (dBuV/m)	Margin (dB)	Remark
1	11785.000	35.45	14.47	49.92	74.00	-24.08	peak
2	12698.000	34.62	15.25	49.87	74.00	-24.13	peak
3	13908.000	33.94	16.26	50.20	74.00	-23.80	peak
4	14799.000	32.66	16.03	48.69	74.00	-25.31	peak
5	17235.000	35.68	21.60	57.28	74.00	-16.72	peak
6	17235.000	18.39	21.60	39.99	54.00	-14.01	AVG
7	17758.000	30.05	23.19	53.24	74.00	-20.76	peak

Note: 1. Measurement = Reading Level + Correct Factor.  
 2. If Peak Result complies with AV limit, AV Result is deemed to comply with AV limit.  
 3. Peak: Peak detector.  
 4. Filter losses were only considered in the spurious frequency bands and the authorized band was not corrected for HPF losses.  
 5. Proper operation of the transmitter prior to adding the filter to the measurement chain.  
 6. Owing to the highest peak level of unwanted emission out of the restricted bands complies with the lowest limit(54dBuV/m), so all the test point was deemed to comply with the limits list in the standard.



**VERTICAL RESULTS**  
**1-7GHz**

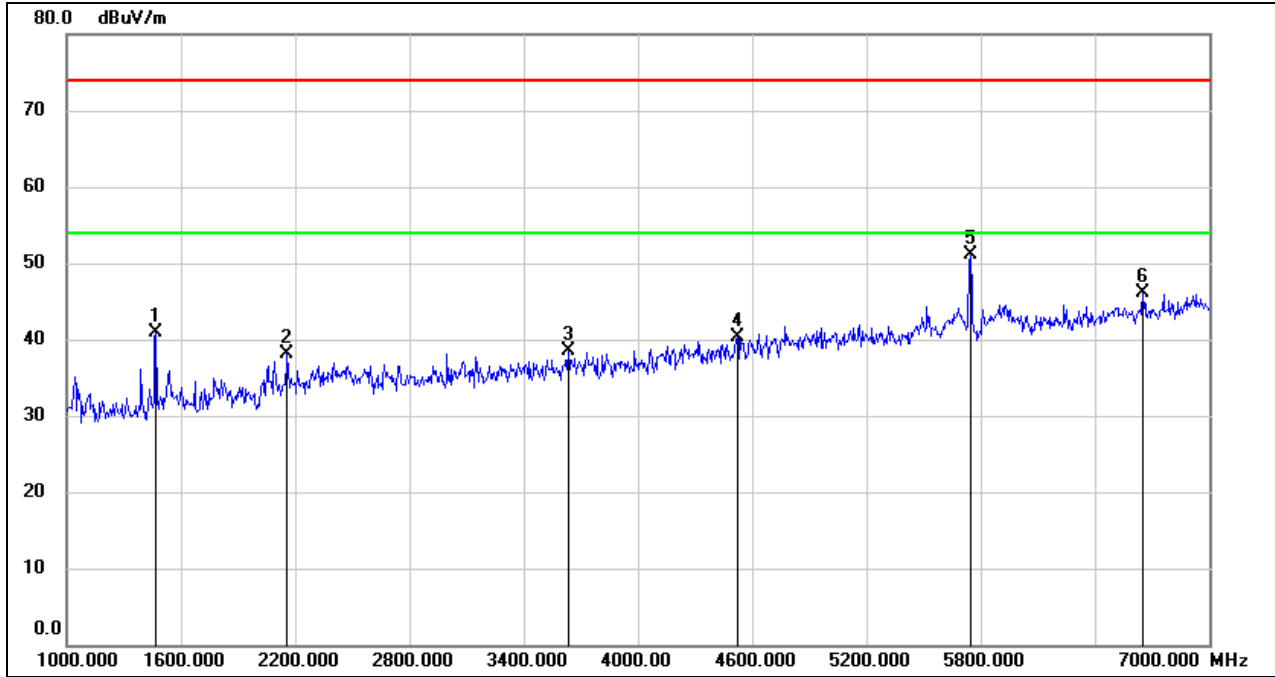

No.	Frequency (MHz)	Reading (dBuV)	Correct (dB/m)	Result (dBuV/m)	Limit (dBuV/m)	Margin (dB)	Remark
1	1468.000	53.88	-12.93	40.95	74.00	-33.05	peak
2	2158.000	47.84	-9.83	38.01	74.00	-35.99	peak
3	3634.000	43.17	-4.65	38.52	74.00	-35.48	peak
4	4522.000	41.97	-1.72	40.25	74.00	-33.75	peak
5	5746.000	48.84	2.22	51.06	74.00	-22.94	peak
6	6652.000	41.49	4.57	46.06	74.00	-27.94	peak

Note: 1. Measurement = Reading Level + Correct Factor.  
 2. If Peak Result complies with AV limit, AV Result is deemed to comply with AV limit.  
 3. Peak: Peak detector.  
 4. Filter losses were only considered in the spurious frequency bands and the authorized band was not corrected for Band reject filter losses.  
 5. Proper operation of the transmitter prior to adding the filter to the measurement chain.  
 6. Owing to the highest peak level of unwanted emission out of the restricted bands complies with the lowest limit(54dBuV/m), so all the test point was deemed to comply with the limits list in the standard.



**7-18GHz**

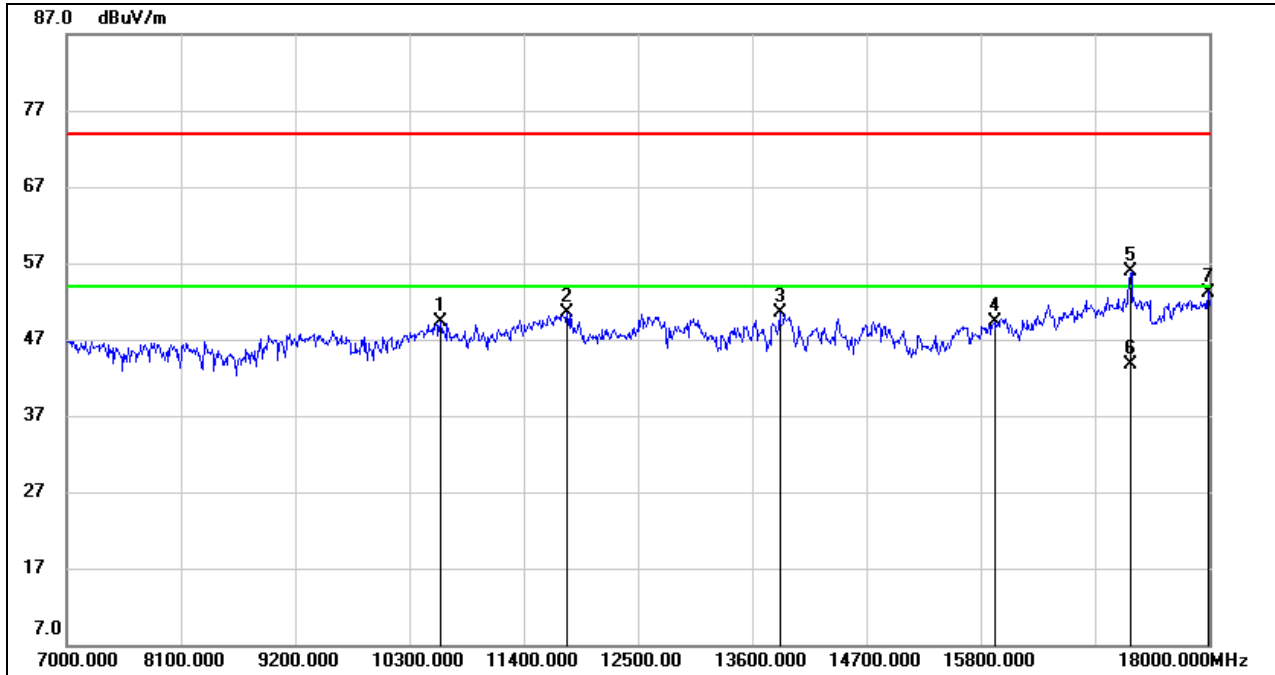

No.	Frequency (MHz)	Reading (dBuV)	Correct (dB/m)	Result (dBuV/m)	Limit (dBuV/m)	Margin (dB)	Remark
1	10597.000	37.39	11.85	49.24	74.00	-24.76	peak
2	11818.000	35.91	14.50	50.41	74.00	-23.59	peak
3	13864.000	34.22	16.33	50.55	74.00	-23.45	peak
4	15932.000	31.86	17.43	49.29	74.00	-24.71	peak
5	17235.000	34.29	21.60	55.89	74.00	-18.11	peak
6	17235.000	22.08	21.60	43.68	54.00	-10.32	AVG
7	17989.000	29.53	23.67	53.20	74.00	-20.80	peak

Note: 1. Measurement = Reading Level + Correct Factor.  
 2. If Peak Result complies with AV limit, AV Result is deemed to comply with AV limit.  
 3. Peak: Peak detector.  
 4. Filter losses were only considered in the spurious frequency bands and the authorized band was not corrected for HPF losses.  
 5. Proper operation of the transmitter prior to adding the filter to the measurement chain.  
 6. Owing to the highest peak level of unwanted emission out of the restricted bands complies with the lowest limit(54dBuV/m), so all the test point was deemed to comply with the limits list in the standard.





**HARMONICS AND SPURIOUS EMISSIONS MID CHANNEL**

**HORIZONTAL RESULTS**  
**1-7GHz**

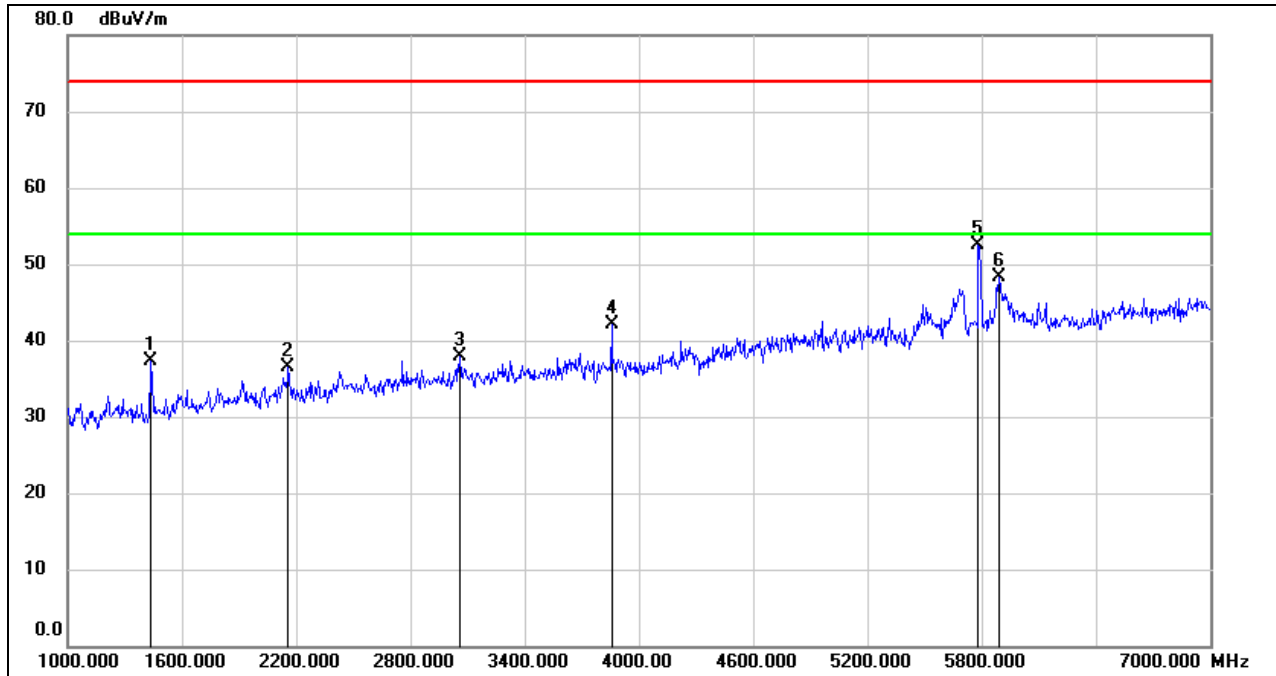

No.	Frequency (MHz)	Reading (dBuV)	Correct (dB/m)	Result (dBuV/m)	Limit (dBuV/m)	Margin (dB)	Remark
1	1438.000	50.27	-12.99	37.28	74.00	-36.72	peak
2	2158.000	46.35	-9.83	36.52	74.00	-37.48	peak
3	3058.000	43.74	-5.91	37.83	74.00	-36.17	peak
4	3856.000	46.41	-4.28	42.13	74.00	-31.87	peak
5	5782.000	50.15	2.41	52.56	74.00	-21.44	peak
6	5890.000	44.20	4.15	48.35	74.00	-25.65	peak

Note: 1. Measurement = Reading Level + Correct Factor.  
 2. If Peak Result complies with AV limit, AV Result is deemed to comply with AV limit.  
 3. Peak: Peak detector.  
 4. Filter losses were only considered in the spurious frequency bands and the authorized band was not corrected for Band reject filter losses.  
 5. Proper operation of the transmitter prior to adding the filter to the measurement chain.  
 6. Owing to the highest peak level of unwanted emission out of the restricted bands complies with the lowest limit(54dBuV/m), so all the test point was deemed to comply with the limits list in the standard.



**HORIZONTAL RESULTS**  
**7-18GHz**

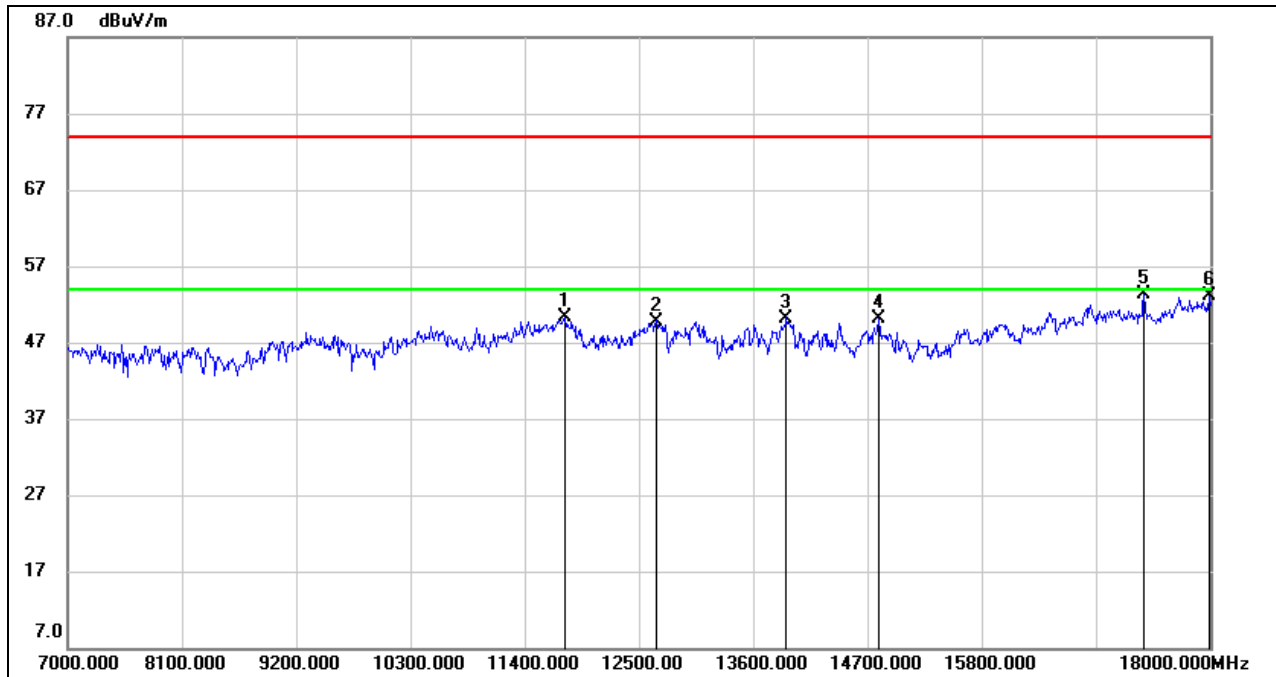

No.	Frequency (MHz)	Reading (dBuV)	Correct (dB/m)	Result (dBuV/m)	Limit (dBuV/m)	Margin (dB)	Remark
1	11785.000	35.86	14.47	50.33	74.00	-23.67	peak
2	12665.000	34.58	15.22	49.80	74.00	-24.20	peak
3	13919.000	33.96	16.24	50.20	74.00	-23.80	peak
4	14810.000	34.04	16.03	50.07	74.00	-23.93	peak
5	17362.000	32.04	21.26	53.30	74.00	-20.70	peak
6	17989.000	29.48	23.67	53.15	74.00	-20.85	peak

Note: 1. Measurement = Reading Level + Correct Factor.  
 2. If Peak Result complies with AV limit, AV Result is deemed to comply with AV limit.  
 3. Peak: Peak detector.  
 4. Filter losses were only considered in the spurious frequency bands and the authorized band was not corrected for HPF losses.  
 5. Proper operation of the transmitter prior to adding the filter to the measurement chain.  
 6. Owing to the highest peak level of unwanted emission out of the restricted bands complies with the lowest limit(54dBuV/m), so all the test point was deemed to comply with the limits list in the standard.



**VERTICAL RESULTS**  
**1-7GHz**

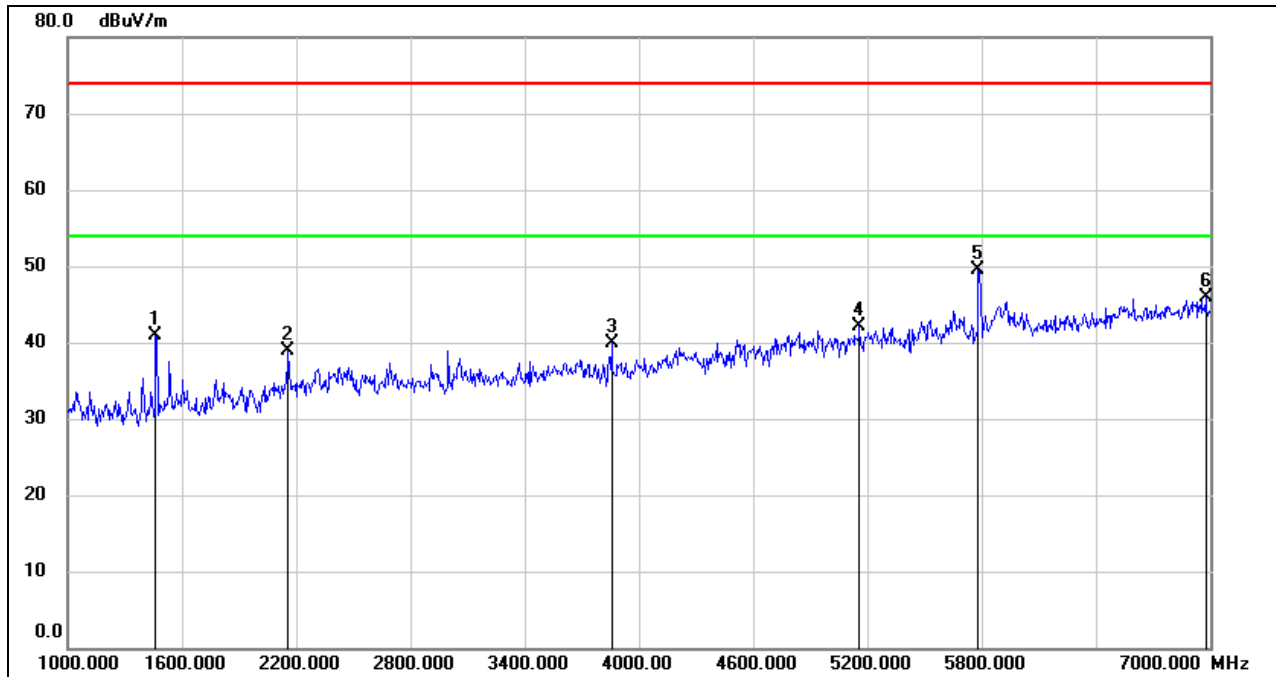

No.	Frequency (MHz)	Reading (dBuV)	Correct (dB/m)	Result (dBuV/m)	Limit (dBuV/m)	Margin (dB)	Remark
1	1462.000	53.88	-12.94	40.94	74.00	-33.06	peak
2	2158.000	48.69	-9.83	38.86	74.00	-35.14	peak
3	3856.000	44.10	-4.28	39.82	74.00	-34.18	peak
4	5158.000	41.02	1.12	42.14	74.00	-31.86	peak
5	5782.000	47.00	2.41	49.41	74.00	-24.59	peak
6	6976.000	40.62	5.25	45.87	74.00	-28.13	peak

Note: 1. Measurement = Reading Level + Correct Factor.  
 2. If Peak Result complies with AV limit, AV Result is deemed to comply with AV limit.  
 3. Peak: Peak detector.  
 4. Filter losses were only considered in the spurious frequency bands and the authorized band was not corrected for Band reject filter losses.  
 5. Proper operation of the transmitter prior to adding the filter to the measurement chain.  
 6. Owing to the highest peak level of unwanted emission out of the restricted bands complies with the lowest limit(54dBuV/m), so all the test point was deemed to comply with the limits list in the standard.



**7-18GHz**

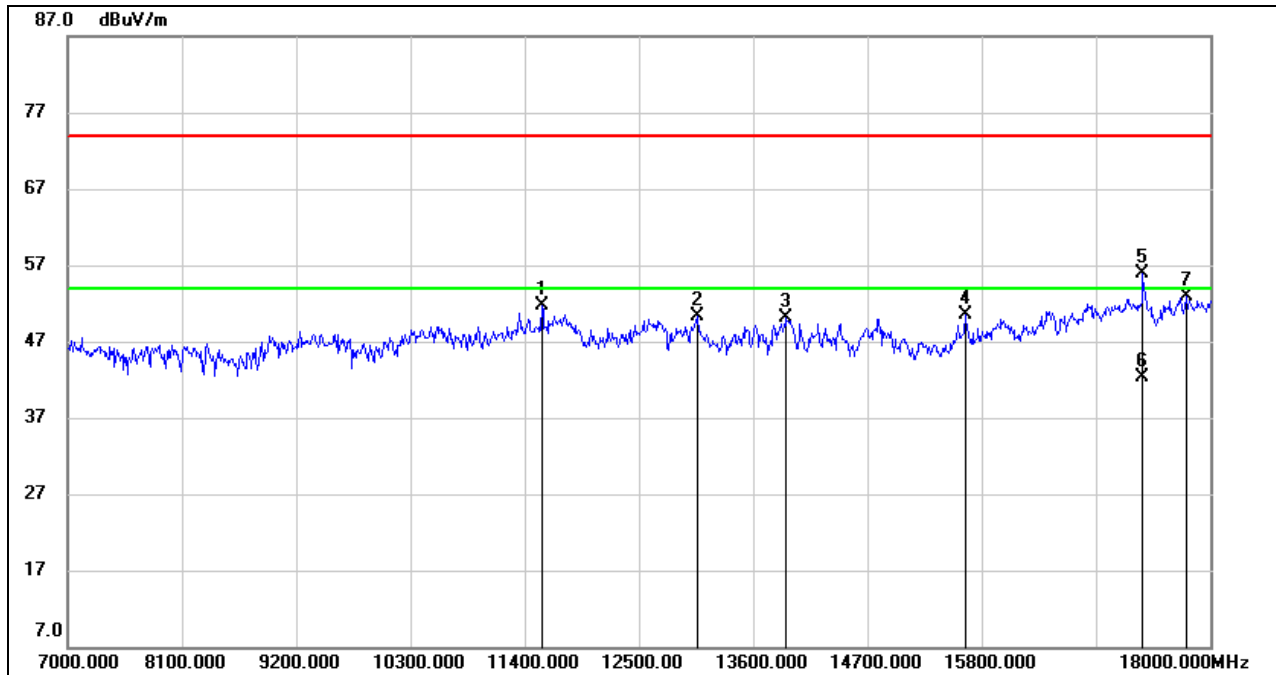

No.	Frequency (MHz)	Reading (dBuV)	Correct (dB/m)	Result (dBuV/m)	Limit (dBuV/m)	Margin (dB)	Remark
1	11565.000	38.02	13.66	51.68	74.00	-22.32	peak
2	13061.000	34.77	15.52	50.29	74.00	-23.71	peak
3	13919.000	33.79	16.24	50.03	74.00	-23.97	peak
4	15646.000	33.66	16.77	50.43	74.00	-23.57	peak
5	17355.000	34.57	21.28	55.85	74.00	-18.15	peak
6	17355.000	20.93	21.28	42.21	54.00	-11.79	AVG
7	17769.000	29.60	23.26	52.86	74.00	-21.14	peak

Note: 1. Measurement = Reading Level + Correct Factor.  
 2. If Peak Result complies with AV limit, AV Result is deemed to comply with AV limit.  
 3. Peak: Peak detector.  
 4. Filter losses were only considered in the spurious frequency bands and the authorized band was not corrected for HPF losses.  
 5. Proper operation of the transmitter prior to adding the filter to the measurement chain.  
 6. Owing to the highest peak level of unwanted emission out of the restricted bands complies with the lowest limit(54dBuV/m), so all the test point was deemed to comply with the limits list in the standard.



**HARMONICS AND SPURIOUS EMISSIONS HIGH CHANNEL**

**HORIZONTAL RESULTS**  
**1-7GHz**

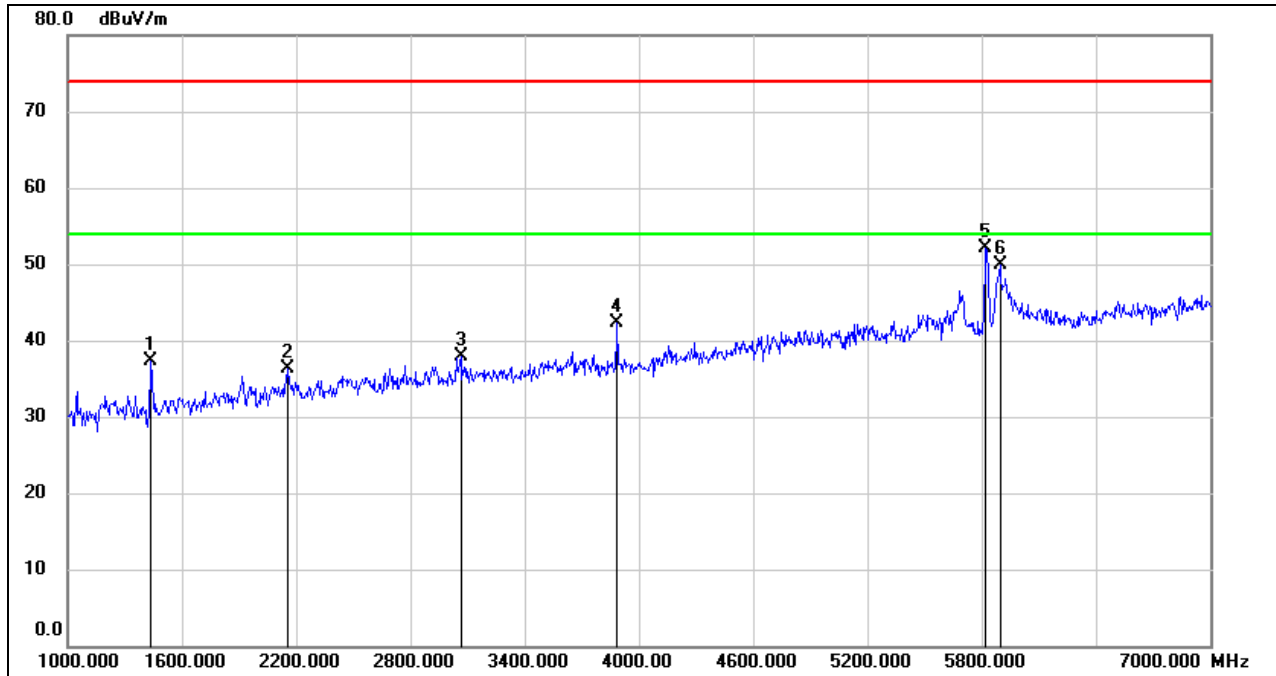

No.	Frequency (MHz)	Reading (dBuV)	Correct (dB/m)	Result (dBuV/m)	Limit (dBuV/m)	Margin (dB)	Remark
1	1438.000	50.36	-12.99	37.37	74.00	-36.63	peak
2	2158.000	46.18	-9.83	36.35	74.00	-37.65	peak
3	3064.000	43.71	-5.88	37.83	74.00	-36.17	peak
4	3886.000	46.63	-4.26	42.37	74.00	-31.63	peak
5	5818.000	49.23	2.83	52.06	74.00	-21.94	peak
6	5896.000	45.59	4.25	49.84	74.00	-24.16	peak

- Note: 1. Measurement = Reading Level + Correct Factor.  
 2. If Peak Result complies with AV limit, AV Result is deemed to comply with AV limit.  
 3. Peak: Peak detector.  
 4. Filter losses were only considered in the spurious frequency bands and the authorized band was not corrected for Band reject filter losses.  
 5. Proper operation of the transmitter prior to adding the filter to the measurement chain.  
 6. Owing to the highest peak level of unwanted emission out of the restricted bands complies with the lowest limit(54dBuV/m), so all the test point was deemed to comply with the limits list in the standard.



**HORIZONTAL RESULTS**  
**7-18GHz**

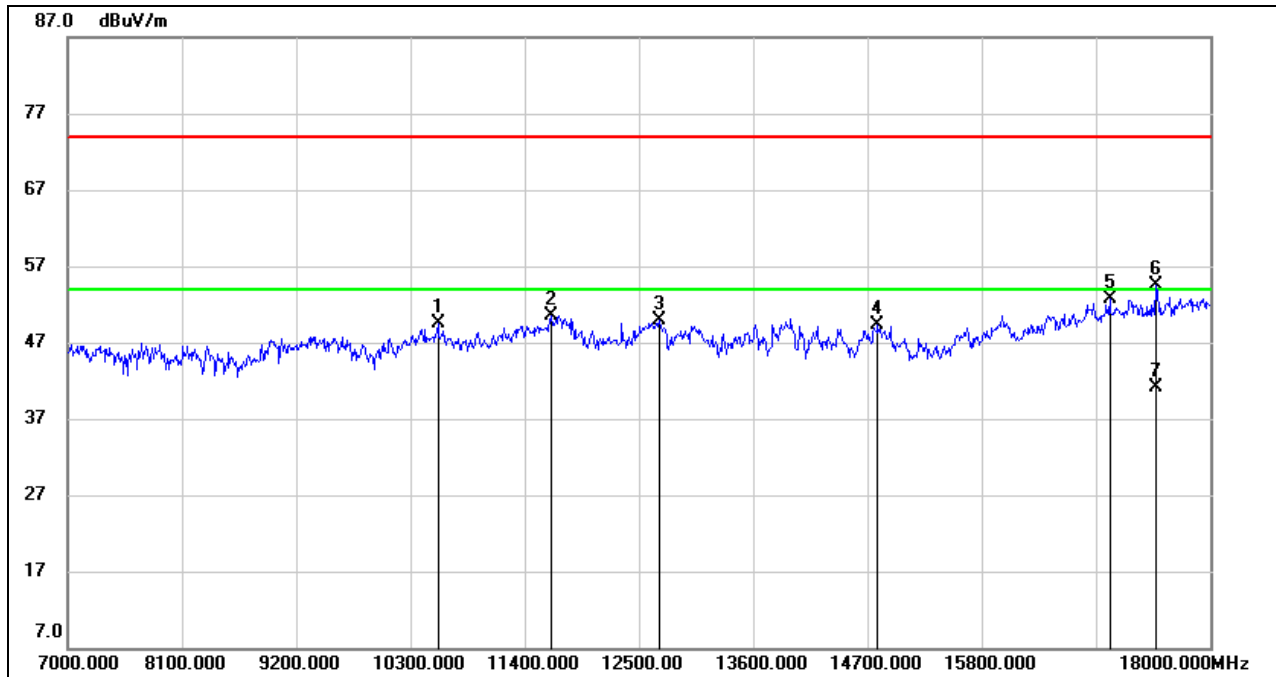

No.	Frequency (MHz)	Reading (dBuV)	Correct (dB/m)	Result (dBuV/m)	Limit (dBuV/m)	Margin (dB)	Remark
1	10564.000	37.83	11.75	49.58	74.00	-24.42	peak
2	11653.000	36.57	13.93	50.50	74.00	-23.50	peak
3	12698.000	34.70	15.25	49.95	74.00	-24.05	peak
4	14799.000	33.22	16.03	49.25	74.00	-24.75	peak
5	17032.000	32.12	20.67	52.79	74.00	-21.21	peak
6	17475.000	33.13	21.39	54.52	74.00	-19.48	peak
7	17475.000	19.69	21.39	41.08	54.00	-12.92	AVG

Note: 1. Measurement = Reading Level + Correct Factor.  
 2. If Peak Result complies with AV limit, AV Result is deemed to comply with AV limit.  
 3. Peak: Peak detector.  
 4. Filter losses were only considered in the spurious frequency bands and the authorized band was not corrected for HPF losses.  
 5. Proper operation of the transmitter prior to adding the filter to the measurement chain.  
 6. Owing to the highest peak level of unwanted emission out of the restricted bands complies with the lowest limit(54dBuV/m), so all the test point was deemed to comply with the limits list in the standard.



**VERTICAL RESULTS**  
**1-7GHz**

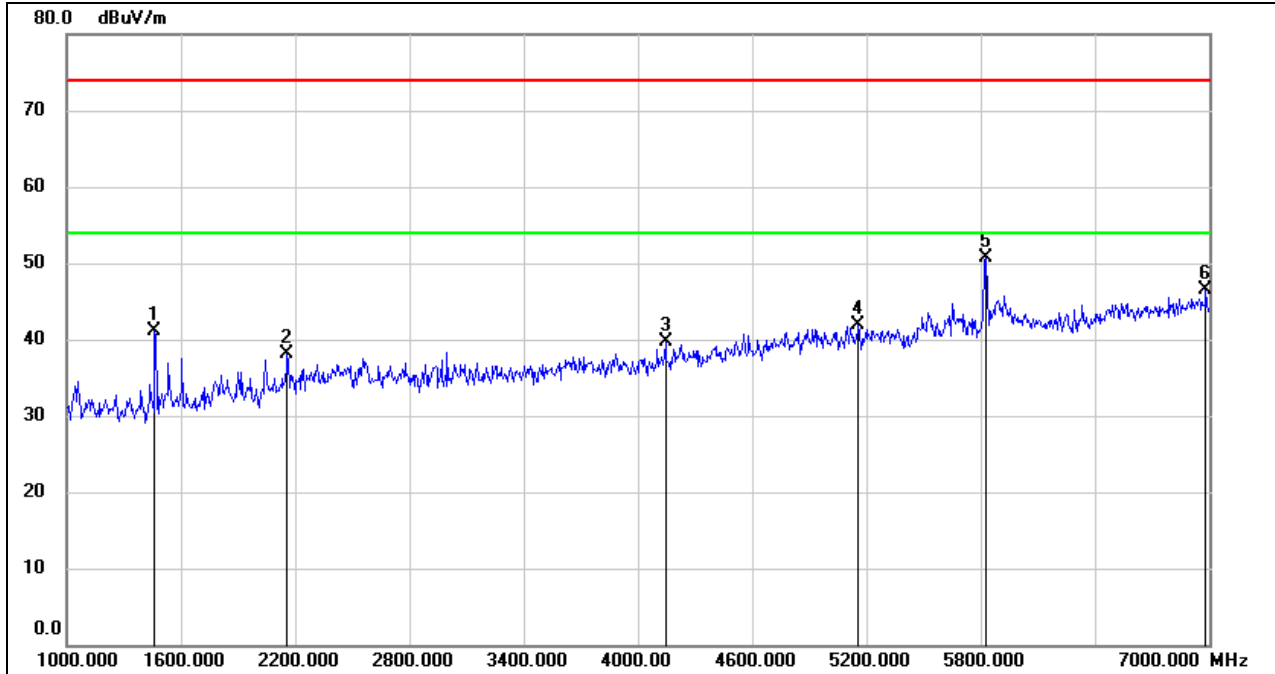

No.	Frequency (MHz)	Reading (dBuV)	Correct (dB/m)	Result (dBuV/m)	Limit (dBuV/m)	Margin (dB)	Remark
1	1462.000	54.00	-12.94	41.06	74.00	-32.94	peak
2	2158.000	48.01	-9.83	38.18	74.00	-35.82	peak
3	4144.000	43.04	-3.39	39.65	74.00	-34.35	peak
4	5158.000	40.81	1.12	41.93	74.00	-32.07	peak
5	5830.000	47.58	3.06	50.64	74.00	-23.36	peak
6	6982.000	41.31	5.26	46.57	74.00	-27.43	peak

Note: 1. Measurement = Reading Level + Correct Factor.  
 2. If Peak Result complies with AV limit, AV Result is deemed to comply with AV limit.  
 3. Peak: Peak detector.  
 4. Filter losses were only considered in the spurious frequency bands and the authorized band was not corrected for Band reject filter losses.  
 5. Proper operation of the transmitter prior to adding the filter to the measurement chain.  
 6. Owing to the highest peak level of unwanted emission out of the restricted bands complies with the lowest limit(54dBuV/m), so all the test point was deemed to comply with the limits list in the standard.



**7-18GHz**

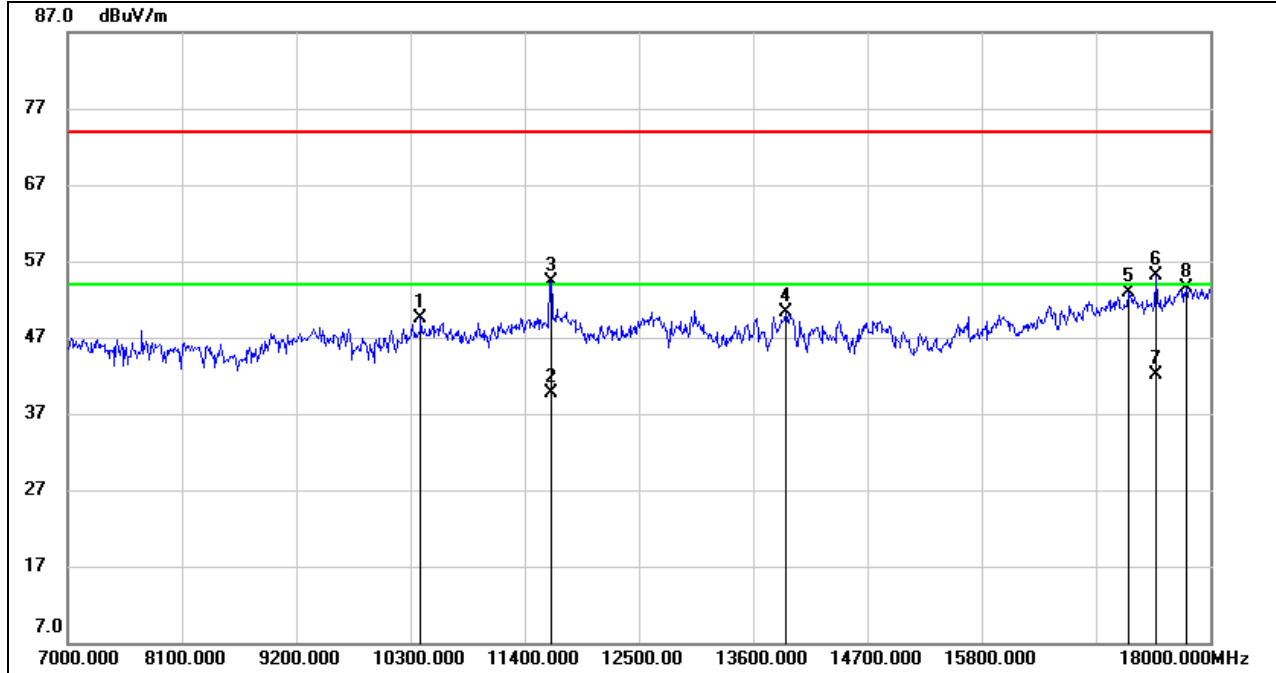

No.	Frequency (MHz)	Reading (dBuV)	Correct (dB/m)	Result (dBuV/m)	Limit (dBuV/m)	Margin (dB)	Remark
1	10399.000	38.37	11.11	49.48	74.00	-24.52	peak
2	11650.000	25.88	13.92	39.80	54.00	-14.20	AVG
3	11653.000	40.37	13.93	54.30	74.00	-19.70	peak
4	13919.000	34.12	16.24	50.36	74.00	-23.64	peak
5	17219.000	31.31	21.64	52.95	74.00	-21.05	peak
6	17475.000	33.65	21.39	55.04	74.00	-18.96	peak
7	17475.000	20.74	21.39	42.13	54.00	-11.87	AVG
8	17769.000	30.26	23.26	53.52	74.00	-20.48	peak

Note: 1. Measurement = Reading Level + Correct Factor.  
 2. If Peak Result complies with AV limit, AV Result is deemed to comply with AV limit.  
 3. Peak: Peak detector.  
 4. Filter losses were only considered in the spurious frequency bands and the authorized band was not corrected for HPF losses.  
 5. Proper operation of the transmitter prior to adding the filter to the measurement chain.  
 6. Owing to the highest peak level of unwanted emission out of the restricted bands complies with the lowest limit(54dBuV/m), so all the test point was deemed to comply with the limits list in the standard.





## 8.2. 802.11ac VHT20 MODE

### 8.2.1. UNII-1 BAND

#### RESTRICTED BANDEDGE LOW CHANNEL

#### HORIZONTAL RESULTS PEAK

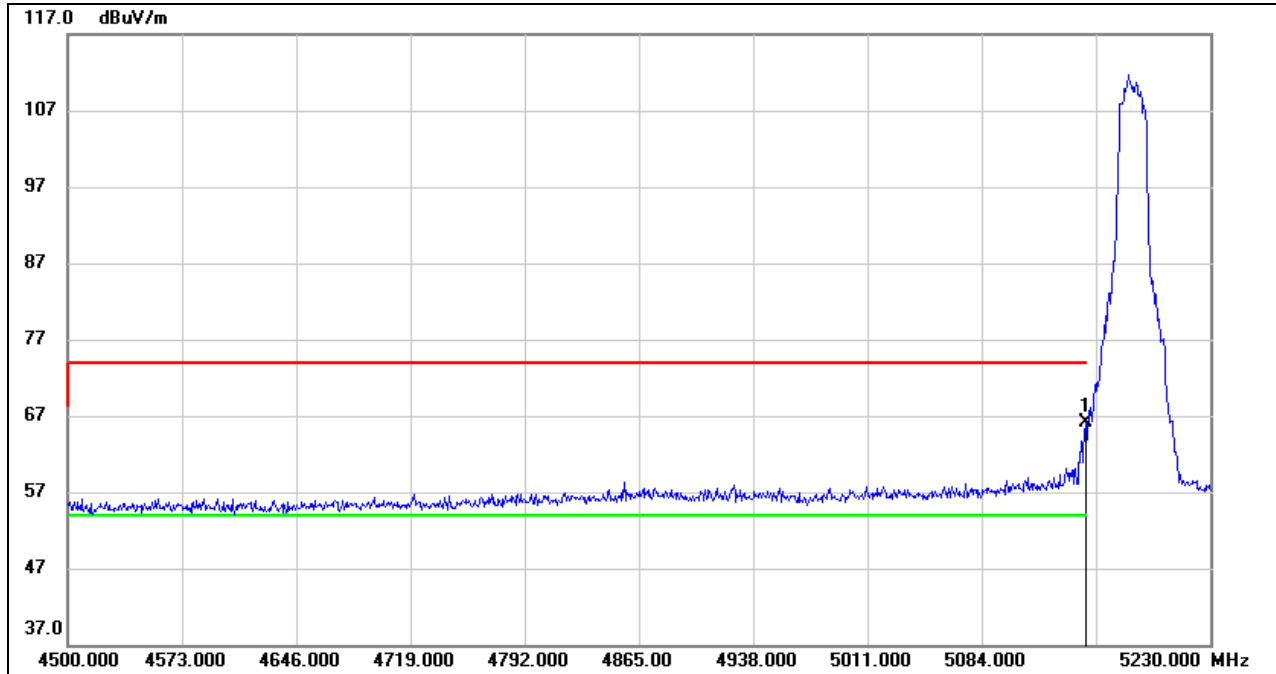

No.	Frequency (MHz)	Reading (dBuV)	Correct (dB/m)	Result (dBuV/m)	Limit (dBuV/m)	Margin (dB)	Remark
1	5150.000	25.72	40.46	66.18	74.00	-7.82	peak

- Note:
1. Measurement = Reading Level + Correct Factor.
  2. If Peak Result complies with AV limit, AV Result is deemed to comply with AV limit.
  3. Peak: Peak detector.
  4. Only the worst case emission will be recorder, if it complies with the limit, the other emissions deemed to comply with the limit.



**AVG**

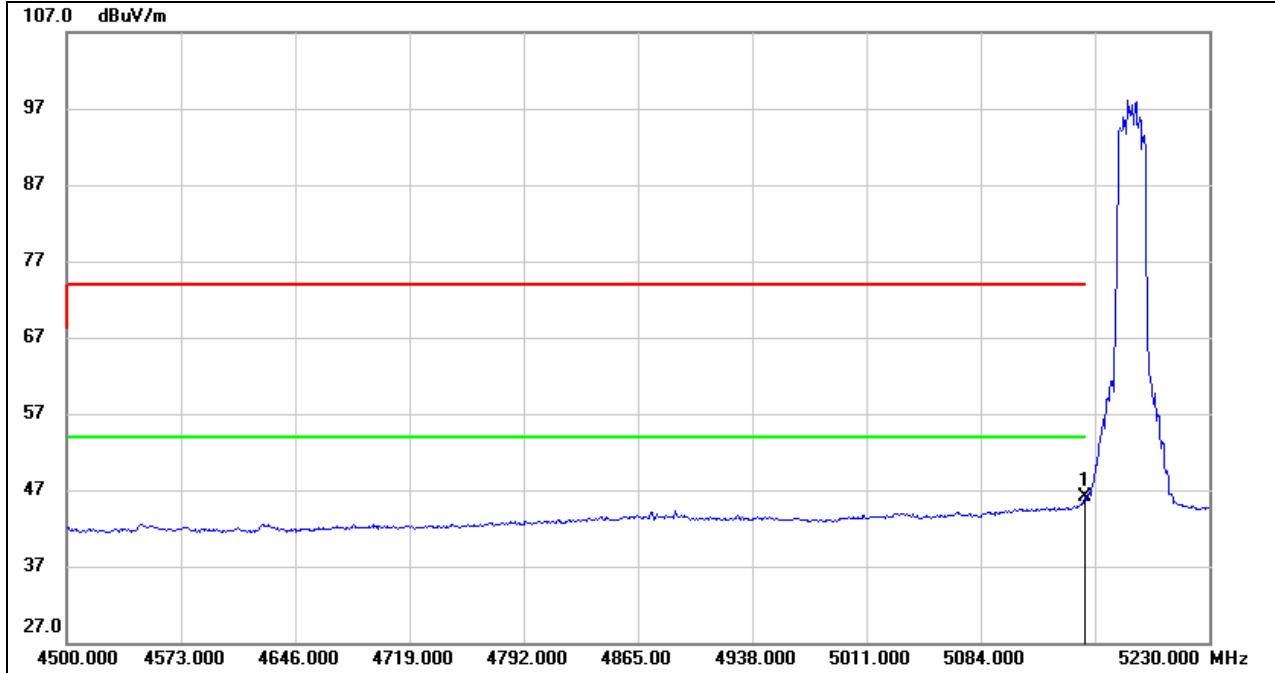

No.	Frequency (MHz)	Reading (dBuV)	Correct (dB/m)	Result (dBuV/m)	Limit (dBuV/m)	Margin (dB)	Remark
1	5150.000	5.55	40.46	46.01	54.00	-7.99	AVG

- Note:
1. Measurement = Reading Level + Correct Factor.
  2. AVG: VBW=1/Ton where: ton is transmit duration.
  3. For duty cycle, please refer to clause 7.1.
  4. Only the worst case emission will be recorder, if it complies with the limit, the other emissions deemed to comply with the limit.



**VERTICAL RESULTS**  
**PEAK**

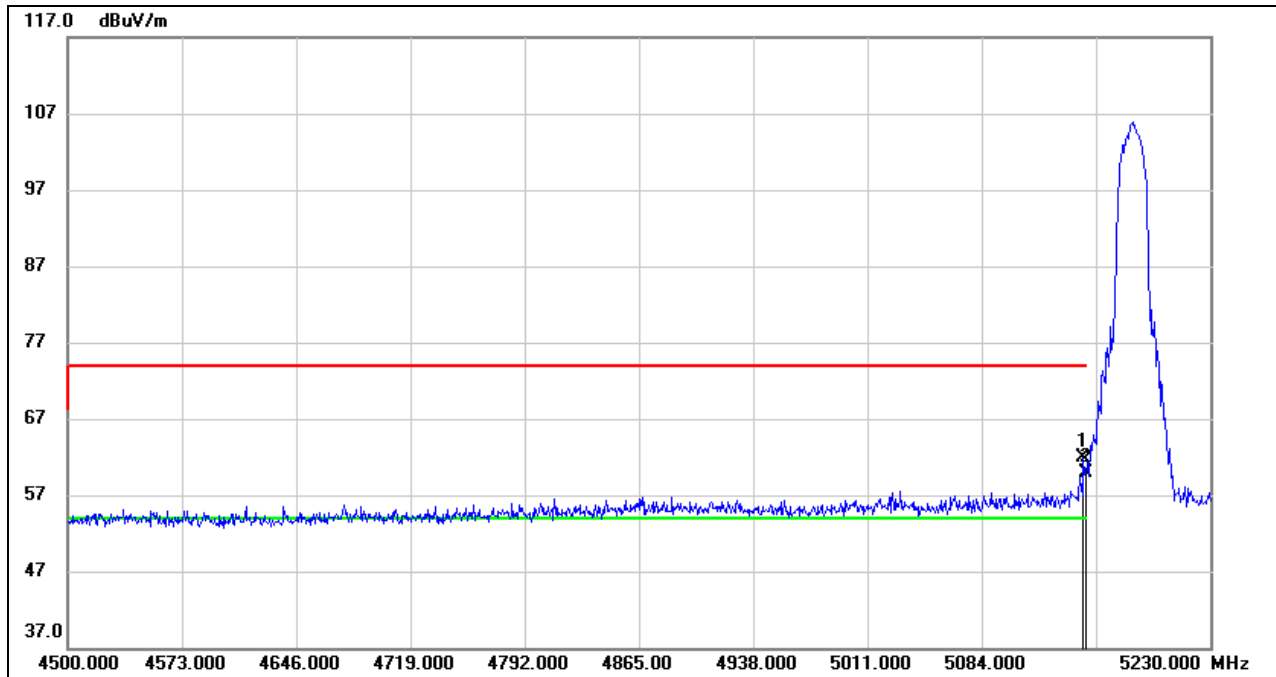

No.	Frequency (MHz)	Reading (dBuV)	Correct (dB/m)	Result (dBuV/m)	Limit (dBuV/m)	Margin (dB)	Remark
1	5148.970	21.35	40.46	61.81	74.00	-12.19	peak
2	5150.000	19.47	40.46	59.93	74.00	-14.07	peak

- Note: 1. Measurement = Reading Level + Correct Factor.  
2. If Peak Result complies with AV limit, AV Result is deemed to comply with AV limit.  
3. Peak: Peak detector.  
4. Only the worst case emission will be recorder, if it complies with the limit, the other emissions deemed to comply with the limit.



**AVG**

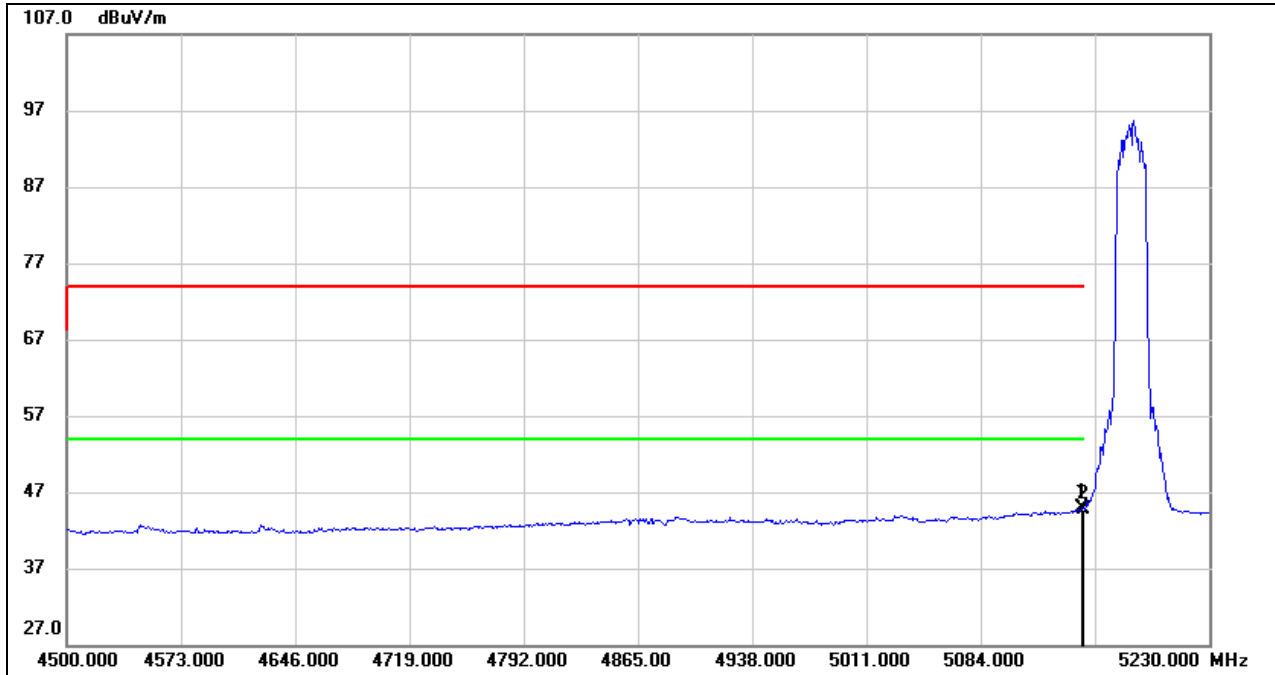

No.	Frequency (MHz)	Reading (dBuV)	Correct (dB/m)	Result (dBuV/m)	Limit (dBuV/m)	Margin (dB)	Remark
1	5148.970	4.37	40.46	44.83	54.00	-9.17	AVG
2	5150.000	4.25	40.46	44.71	54.00	-9.29	AVG

- Note: 1. Measurement = Reading Level + Correct Factor.  
 2. AVG: VBW=1/Ton where: ton is transmit duration.  
 3. For duty cycle, please refer to clause 7.1.  
 4. Only the worst case emission will be recorder, if it complies with the limit, the other emissions deemed to comply with the limit.



**HARMONICS AND SPURIOUS EMISSIONS LOW CHANNEL**

**HORIZONTAL RESULTS**  
**1-7GHz**

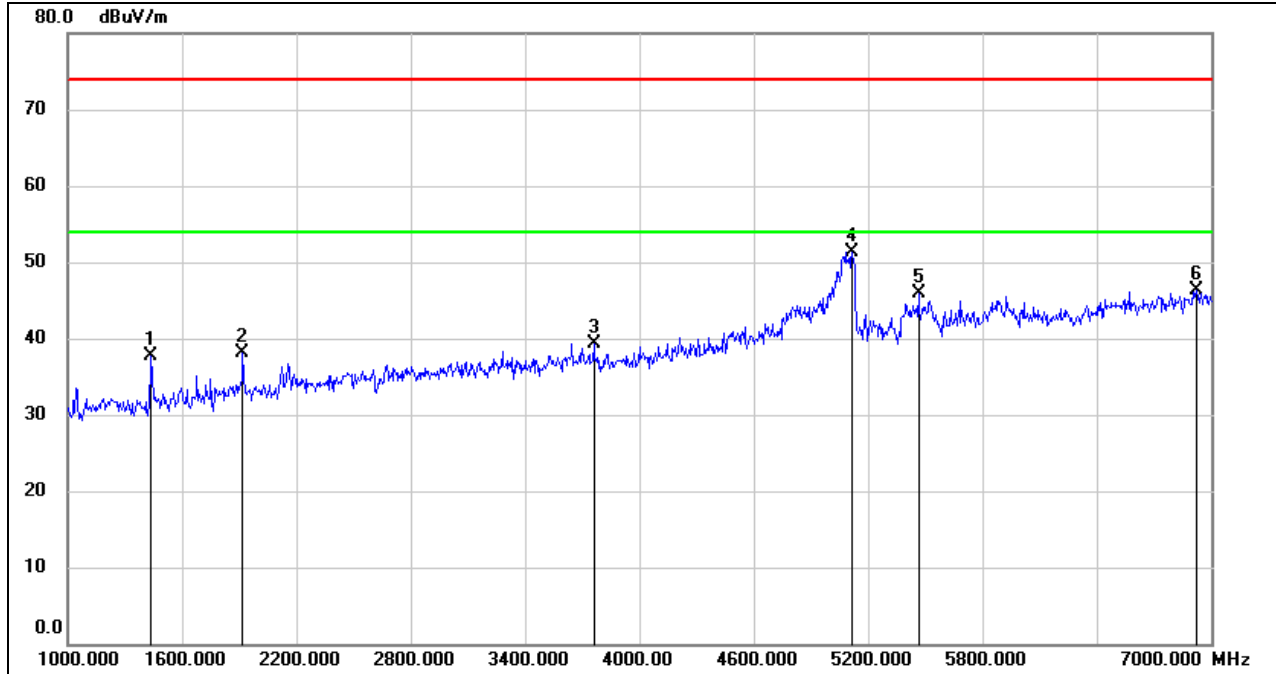

No.	Frequency (MHz)	Reading (dBuV)	Correct (dB/m)	Result (dBuV/m)	Limit (dBuV/m)	Margin (dB)	Remark
1	1438.000	50.77	-12.99	37.78	74.00	-36.22	peak
2	1918.000	48.77	-10.65	38.12	74.00	-35.88	peak
3	3760.000	43.50	-4.23	39.27	74.00	-34.73	peak
4	5116.000	50.41	0.86	51.27	74.00	-22.73	peak
5	5464.000	43.97	1.90	45.87	74.00	-28.13	peak
6	6922.000	41.18	5.21	46.39	74.00	-27.61	peak

Note: 1. Measurement = Reading Level + Correct Factor.  
 2. If Peak Result complies with AV limit, AV Result is deemed to comply with AV limit.  
 3. Peak: Peak detector.  
 4. Filter losses were only considered in the spurious frequency bands and the authorized band was not corrected for Band reject filter losses.  
 5. Proper operation of the transmitter prior to adding the filter to the measurement chain.  
 6. Owing to the highest peak level of unwanted emission out of the restricted bands complies with the lowest limit(54dBuV/m), so all the test point was deemed to comply with the limits list in the standard.



**HORIZONTAL RESULTS**  
**7-18GHz**

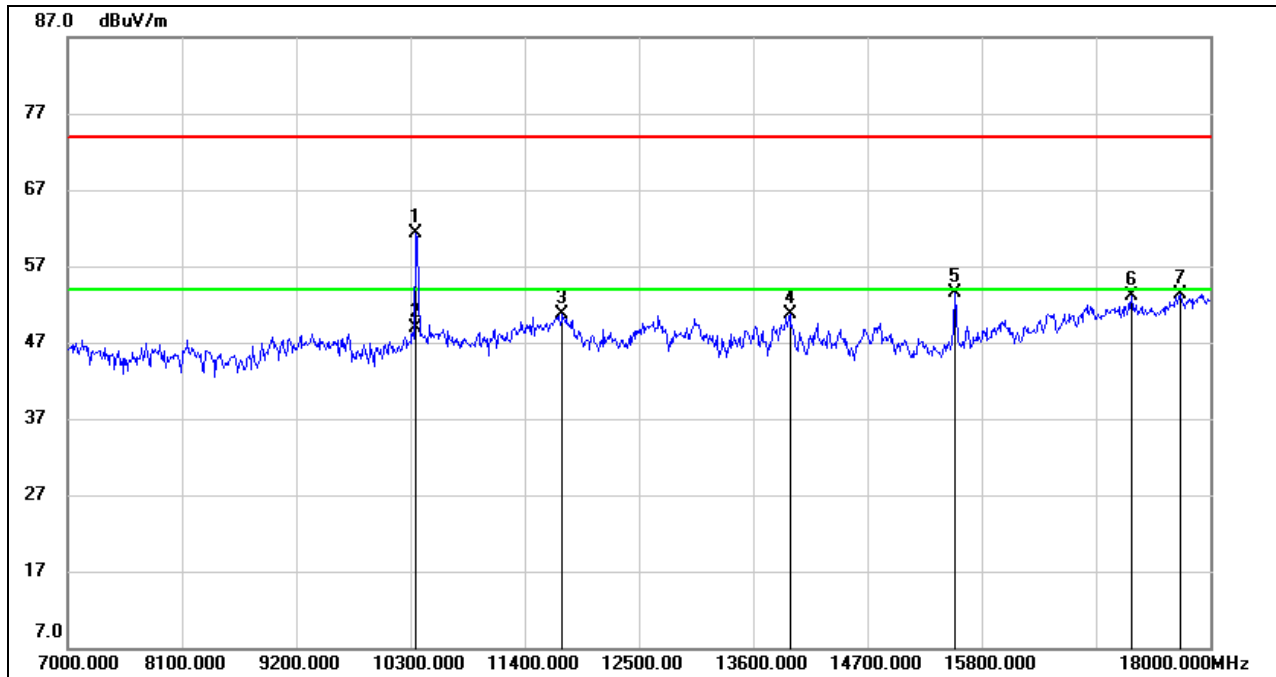

No.	Frequency (MHz)	Reading (dBuV)	Correct (dB/m)	Result (dBuV/m)	Limit (dBuV/m)	Margin (dB)	Remark
1	10360.000	50.36	10.97	61.33	74.00	-12.67	peak
2	10360.000	38.03	10.97	49.00	54.00	-5.00	AVG
3	11763.000	36.37	14.37	50.74	74.00	-23.26	peak
4	13952.000	34.48	16.19	50.67	74.00	-23.33	peak
5	15536.000	36.97	16.49	53.46	74.00	-20.54	peak
6	17241.000	31.46	21.58	53.04	74.00	-20.96	peak
7	17714.000	30.38	22.85	53.23	74.00	-20.77	peak

- Note: 1. Measurement = Reading Level + Correct Factor.  
 2. If Peak Result complies with AV limit, AV Result is deemed to comply with AV limit.  
 3. Peak: Peak detector.  
 4. Filter losses were only considered in the spurious frequency bands and the authorized band was not corrected for HPF losses.  
 5. Proper operation of the transmitter prior to adding the filter to the measurement chain.  
 6. Owing to the highest peak level of unwanted emission out of the restricted bands complies with the lowest limit(54dBuV/m), so all the test point was deemed to comply with the limits list in the standard.



**VERTICAL RESULTS**  
**1-7GHz**

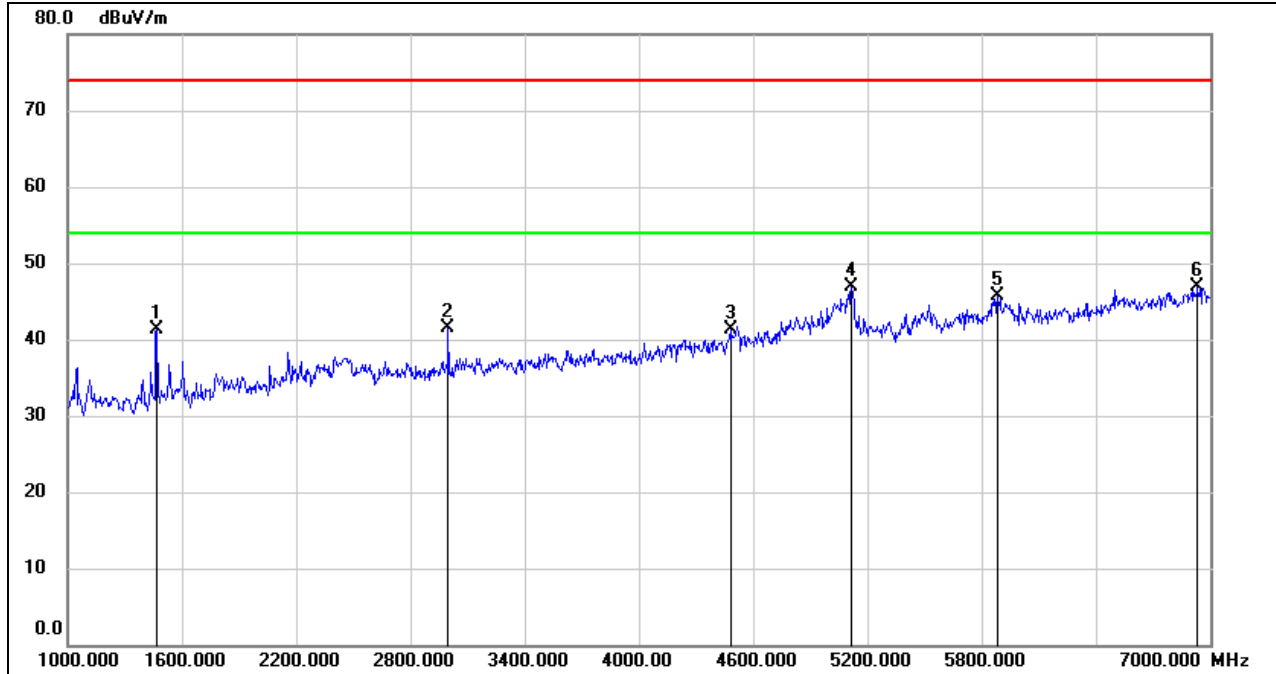

No.	Frequency (MHz)	Reading (dBuV)	Correct (dB/m)	Result (dBuV/m)	Limit (dBuV/m)	Margin (dB)	Remark
1	1468.000	54.29	-12.93	41.36	74.00	-32.64	peak
2	2998.000	47.79	-6.29	41.50	74.00	-32.50	peak
3	4480.000	43.21	-1.96	41.25	74.00	-32.75	peak
4	5116.000	46.03	0.86	46.89	74.00	-27.11	peak
5	5884.000	41.69	4.03	45.72	74.00	-28.28	peak
6	6934.000	41.62	5.22	46.84	74.00	-27.16	peak

Note: 1. Measurement = Reading Level + Correct Factor.  
 2. If Peak Result complies with AV limit, AV Result is deemed to comply with AV limit.  
 3. Peak: Peak detector.  
 4. Filter losses were only considered in the spurious frequency bands and the authorized band was not corrected for Band reject filter losses.  
 5. Proper operation of the transmitter prior to adding the filter to the measurement chain.  
 6. Owing to the highest peak level of unwanted emission out of the restricted bands complies with the lowest limit(54dBuV/m), so all the test point was deemed to comply with the limits list in the standard.



**7-18GHz**

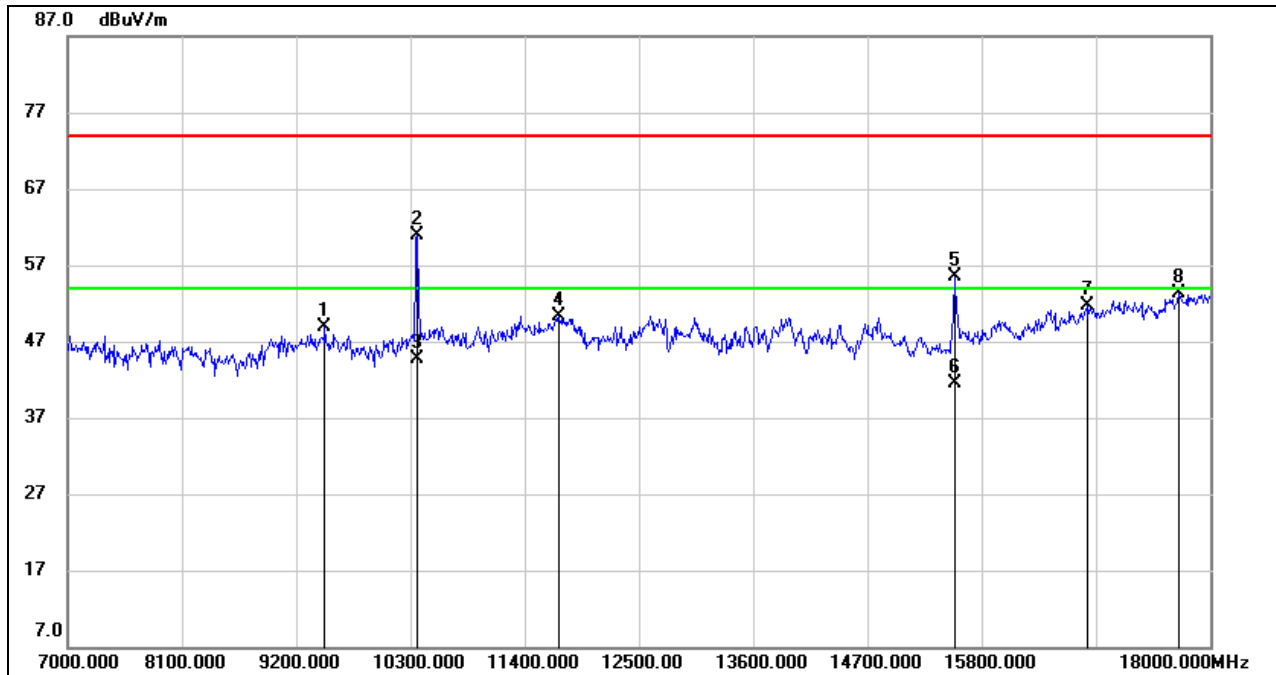

No.	Frequency (MHz)	Reading (dBuV)	Correct (dB/m)	Result (dBuV/m)	Limit (dBuV/m)	Margin (dB)	Remark
1	9475.000	38.64	10.25	48.89	74.00	-25.11	peak
2	10360.406	49.99	10.97	60.96	74.00	-13.04	peak
3	10360.406	33.71	10.97	44.68	54.00	-9.32	AVG
4	11730.000	36.02	14.25	50.27	74.00	-23.73	peak
5	15536.000	39.09	16.49	55.58	74.00	-18.42	peak
6	15536.000	24.95	16.49	41.44	54.00	-12.56	AVG
7	16812.000	31.55	20.14	51.69	74.00	-22.31	peak
8	17692.000	30.53	22.69	53.22	74.00	-20.78	peak

Note: 1. Measurement = Reading Level + Correct Factor.  
 2. If Peak Result complies with AV limit, AV Result is deemed to comply with AV limit.  
 3. Peak: Peak detector.  
 4. Filter losses were only considered in the spurious frequency bands and the authorized band was not corrected for HPF losses.  
 5. Proper operation of the transmitter prior to adding the filter to the measurement chain.  
 6. Owing to the highest peak level of unwanted emission out of the restricted bands complies with the lowest limit(54dBuV/m), so all the test point was deemed to comply with the limits list in the standard.





**HARMONICS AND SPURIOUS EMISSIONS MID CHANNEL**

**HORIZONTAL RESULTS**  
**1-7GHz**

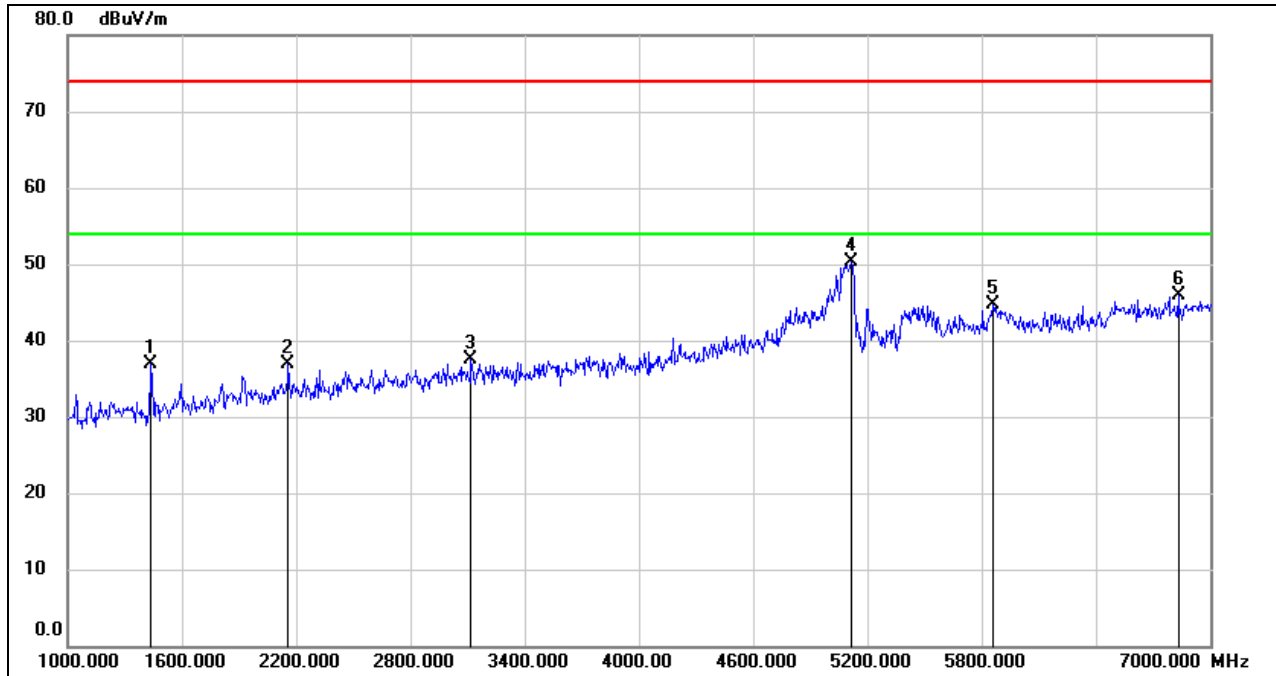

No.	Frequency (MHz)	Reading (dBuV)	Correct (dB/m)	Result (dBuV/m)	Limit (dBuV/m)	Margin (dB)	Remark
1	1438.000	49.97	-12.99	36.98	74.00	-37.02	peak
2	2158.000	46.80	-9.83	36.97	74.00	-37.03	peak
3	3118.000	43.25	-5.73	37.52	74.00	-36.48	peak
4	5116.000	49.54	0.86	50.40	74.00	-23.60	peak
5	5860.000	41.13	3.60	44.73	74.00	-29.27	peak
6	6832.000	41.20	4.76	45.96	74.00	-28.04	peak

- Note: 1. Measurement = Reading Level + Correct Factor.  
 2. If Peak Result complies with AV limit, AV Result is deemed to comply with AV limit.  
 3. Peak: Peak detector.  
 4. Filter losses were only considered in the spurious frequency bands and the authorized band was not corrected for Band reject filter losses.  
 5. Proper operation of the transmitter prior to adding the filter to the measurement chain.  
 6. Owing to the highest peak level of unwanted emission out of the restricted bands complies with the lowest limit(54dBuV/m), so all the test point was deemed to comply with the limits list in the standard.



**HORIZONTAL RESULTS**  
**7-18GHz**

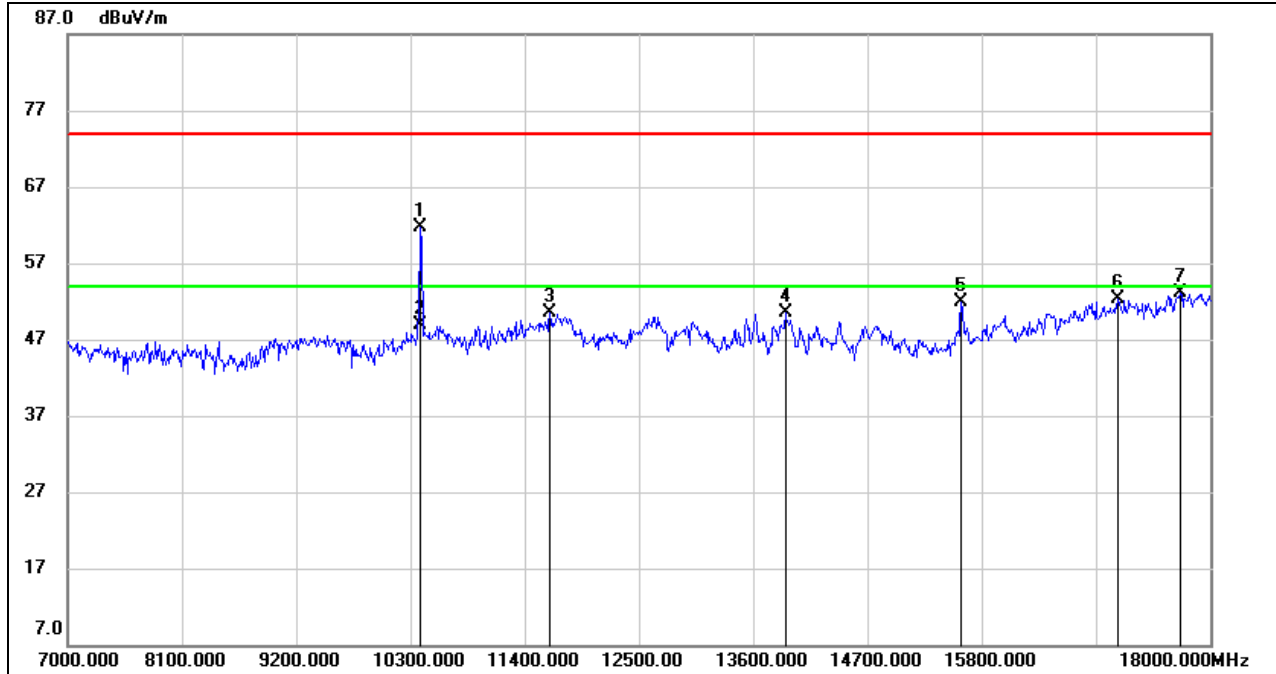

No.	Frequency (MHz)	Reading (dBuV)	Correct (dB/m)	Result (dBuV/m)	Limit (dBuV/m)	Margin (dB)	Remark
1	10399.500	50.58	11.11	61.69	74.00	-12.31	peak
2	10399.500	37.77	11.11	48.88	54.00	-5.12	AVG
3	11642.000	36.67	13.89	50.56	74.00	-23.44	peak
4	13908.000	34.24	16.26	50.50	74.00	-23.50	peak
5	15602.000	35.21	16.74	51.95	74.00	-22.05	peak
6	17109.000	31.10	21.13	52.23	74.00	-21.77	peak
7	17714.000	30.23	22.85	53.08	74.00	-20.92	peak

- Note: 1. Measurement = Reading Level + Correct Factor.  
 2. If Peak Result complies with AV limit, AV Result is deemed to comply with AV limit.  
 3. Peak: Peak detector.  
 4. Filter losses were only considered in the spurious frequency bands and the authorized band was not corrected for HPF losses.  
 5. Proper operation of the transmitter prior to adding the filter to the measurement chain.  
 6. Owing to the highest peak level of unwanted emission out of the restricted bands complies with the lowest limit(54dBuV/m), so all the test point was deemed to comply with the limits list in the standard.



**VERTICAL RESULTS**  
**1-7GHz**

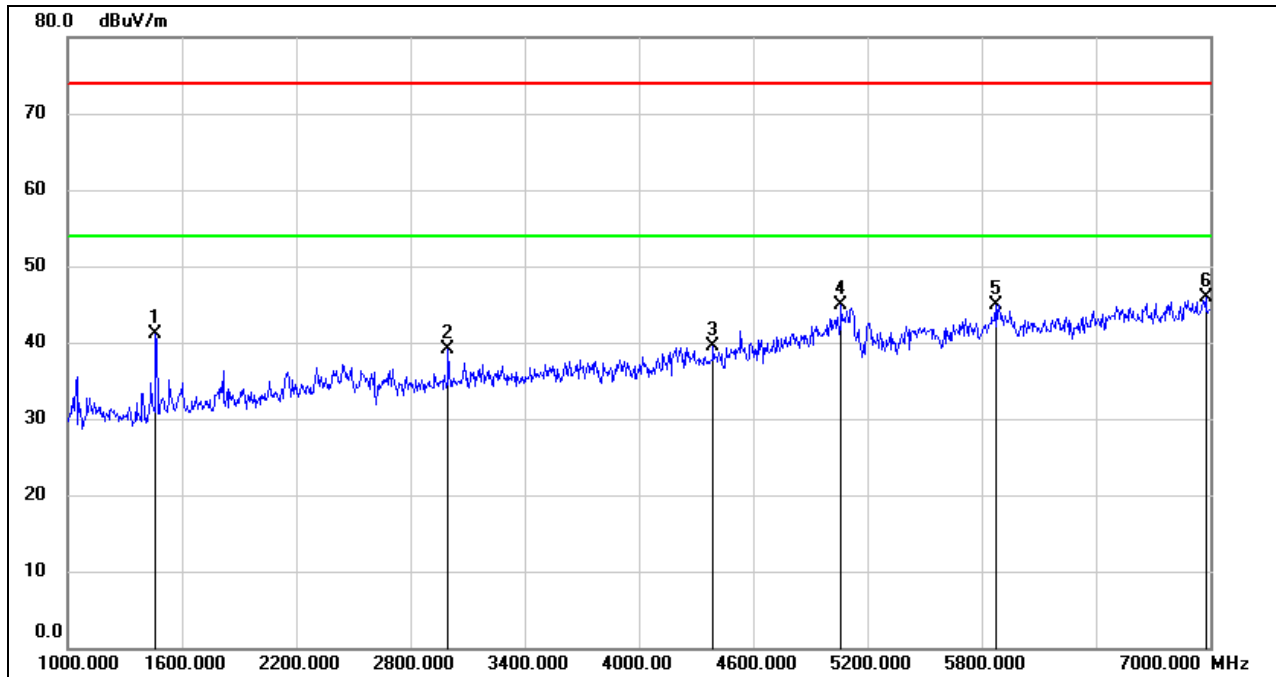

No.	Frequency (MHz)	Reading (dBuV)	Correct (dB/m)	Result (dBuV/m)	Limit (dBuV/m)	Margin (dB)	Remark
1	1462.000	54.04	-12.94	41.10	74.00	-32.90	peak
2	2998.000	45.41	-6.29	39.12	74.00	-34.88	peak
3	4390.000	42.38	-2.79	39.59	74.00	-34.41	peak
4	5062.000	44.17	0.74	44.91	74.00	-29.09	peak
5	5872.000	41.09	3.82	44.91	74.00	-29.09	peak
6	6976.000	40.60	5.25	45.85	74.00	-28.15	peak

Note: 1. Measurement = Reading Level + Correct Factor.  
 2. If Peak Result complies with AV limit, AV Result is deemed to comply with AV limit.  
 3. Peak: Peak detector.  
 4. Filter losses were only considered in the spurious frequency bands and the authorized band was not corrected for Band reject filter losses.  
 5. Proper operation of the transmitter prior to adding the filter to the measurement chain.  
 6. Owing to the highest peak level of unwanted emission out of the restricted bands complies with the lowest limit(54dBuV/m), so all the test point was deemed to comply with the limits list in the standard.



**7-18GHz**

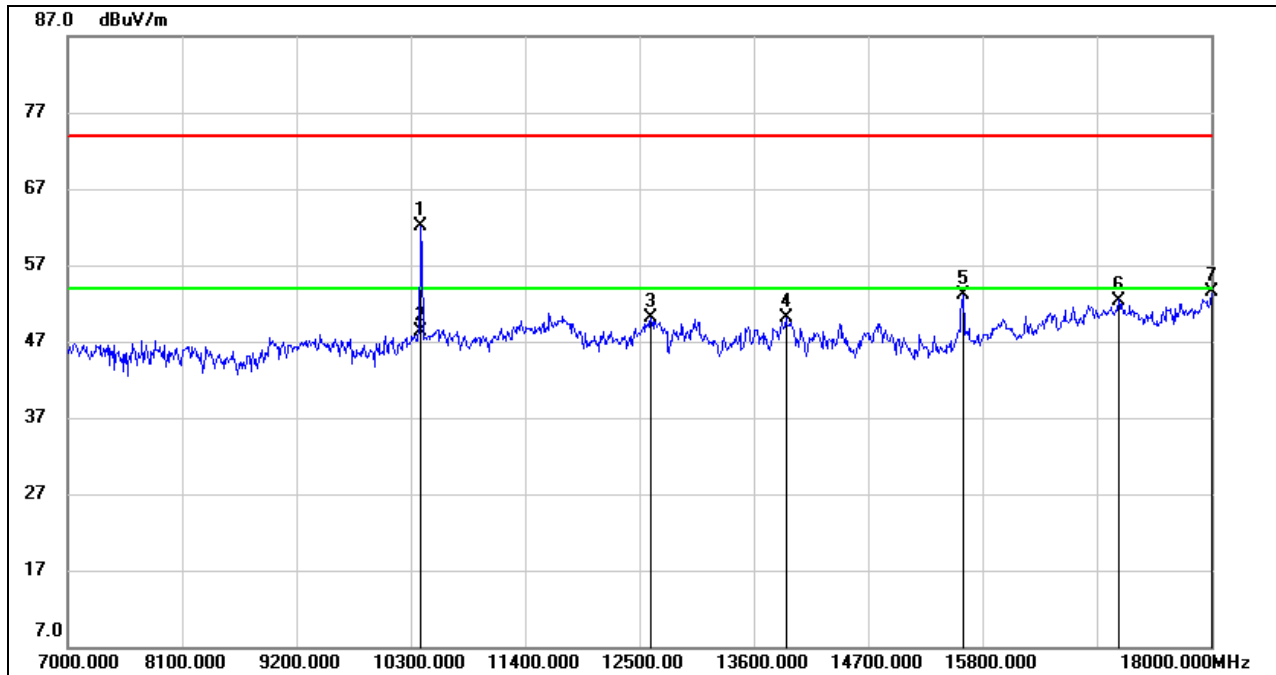

No.	Frequency (MHz)	Reading (dBuV)	Correct (dB/m)	Result (dBuV/m)	Limit (dBuV/m)	Margin (dB)	Remark
1	10400.898	51.05	11.11	62.16	74.00	-11.84	peak
2	10400.898	37.11	11.11	48.22	54.00	-5.78	AVG
3	12610.000	34.94	15.17	50.11	74.00	-23.89	peak
4	13908.000	33.93	16.26	50.19	74.00	-23.81	peak
5	15613.000	36.35	16.76	53.11	74.00	-20.89	peak
6	17109.000	31.27	21.13	52.40	74.00	-21.60	peak
7	18000.000	29.84	23.69	53.53	74.00	-20.47	peak

Note: 1. Measurement = Reading Level + Correct Factor.  
 2. If Peak Result complies with AV limit, AV Result is deemed to comply with AV limit.  
 3. Peak: Peak detector.  
 4. Filter losses were only considered in the spurious frequency bands and the authorized band was not corrected for HPF losses.  
 5. Proper operation of the transmitter prior to adding the filter to the measurement chain.  
 6. Owing to the highest peak level of unwanted emission out of the restricted bands complies with the lowest limit(54dBuV/m), so all the test point was deemed to comply with the limits list in the standard.



**HARMONICS AND SPURIOUS EMISSIONS HIGH CHANNEL**

**HORIZONTAL RESULTS**  
**1-7GHz**

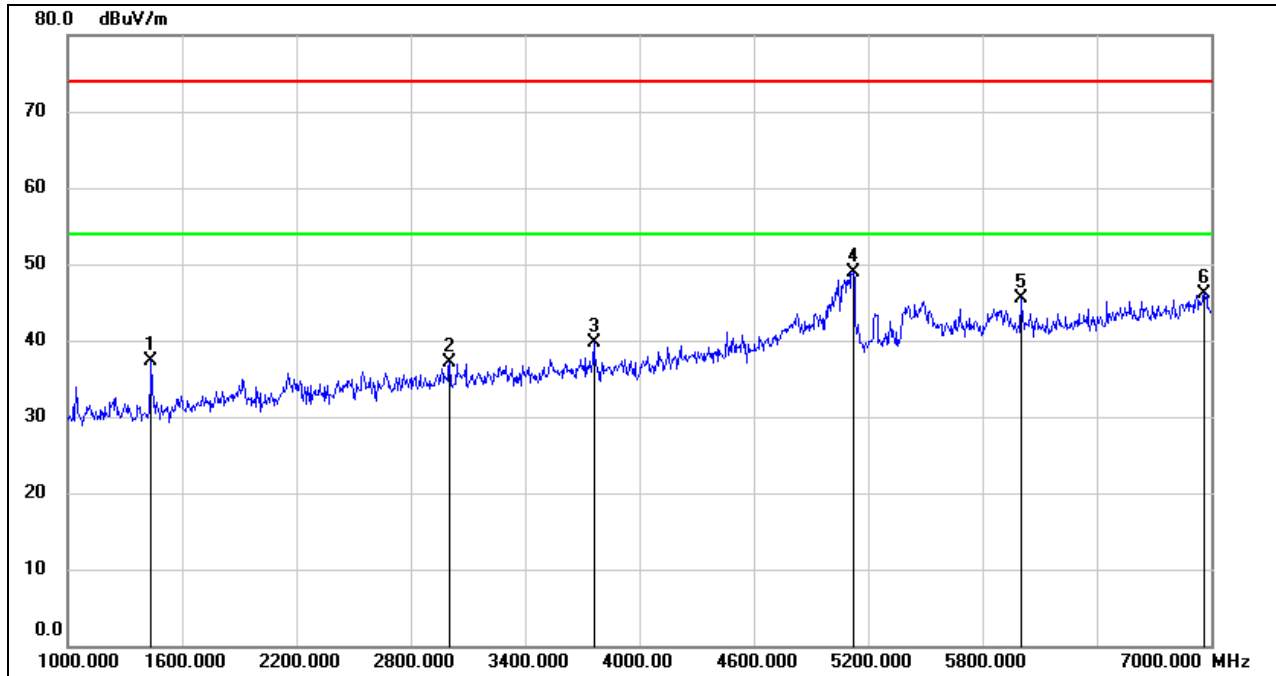

No.	Frequency (MHz)	Reading (dBuV)	Correct (dB/m)	Result (dBuV/m)	Limit (dBuV/m)	Margin (dB)	Remark
1	1438.000	50.33	-12.99	37.34	74.00	-36.66	peak
2	3004.000	43.44	-6.26	37.18	74.00	-36.82	peak
3	3760.000	43.89	-4.23	39.66	74.00	-34.34	peak
4	5122.000	48.07	0.90	48.97	74.00	-25.03	peak
5	6004.000	42.95	2.61	45.56	74.00	-28.44	peak
6	6964.000	40.87	5.25	46.12	74.00	-27.88	peak

- Note: 1. Measurement = Reading Level + Correct Factor.  
 2. If Peak Result complies with AV limit, AV Result is deemed to comply with AV limit.  
 3. Peak: Peak detector.  
 4. Filter losses were only considered in the spurious frequency bands and the authorized band was not corrected for Band reject filter losses.  
 5. Proper operation of the transmitter prior to adding the filter to the measurement chain.  
 6. Owing to the highest peak level of unwanted emission out of the restricted bands complies with the lowest limit(54dBuV/m), so all the test point was deemed to comply with the limits list in the standard.



**HORIZONTAL RESULTS**  
**7-18GHz**

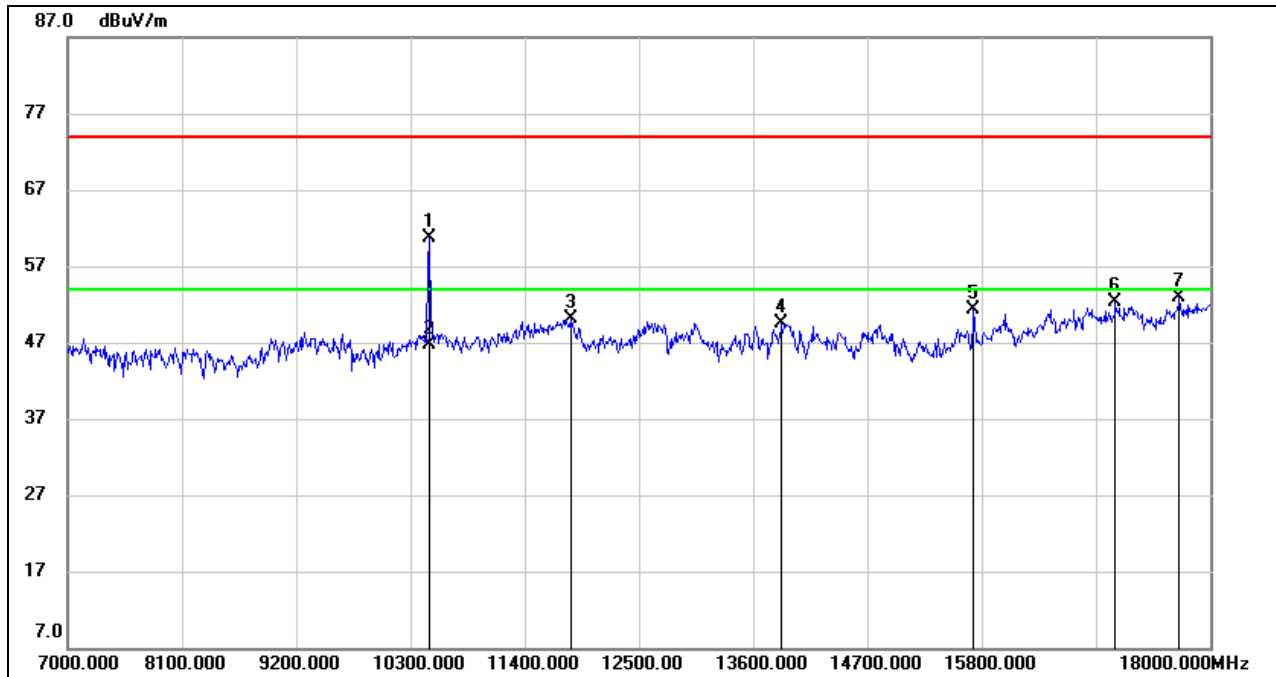

No.	Frequency (MHz)	Reading (dBuV)	Correct (dB/m)	Result (dBuV/m)	Limit (dBuV/m)	Margin (dB)	Remark
1	10480.735	49.21	11.46	60.67	74.00	-13.33	peak
2	10480.735	35.30	11.46	46.76	54.00	-7.24	AVG
3	11851.000	35.63	14.45	50.08	74.00	-23.92	peak
4	13875.000	33.22	16.33	49.55	74.00	-24.45	peak
5	15723.000	34.45	16.82	51.27	74.00	-22.73	peak
6	17087.000	31.23	21.00	52.23	74.00	-21.77	peak
7	17703.000	30.06	22.77	52.83	74.00	-21.17	peak

- Note: 1. Measurement = Reading Level + Correct Factor.  
 2. If Peak Result complies with AV limit, AV Result is deemed to comply with AV limit.  
 3. Peak: Peak detector.  
 4. Filter losses were only considered in the spurious frequency bands and the authorized band was not corrected for HPF losses.  
 5. Proper operation of the transmitter prior to adding the filter to the measurement chain.  
 6. Owing to the highest peak level of unwanted emission out of the restricted bands complies with the lowest limit(54dBuV/m), so all the test point was deemed to comply with the limits list in the standard.



**VERTICAL RESULTS**  
**1-7GHz**

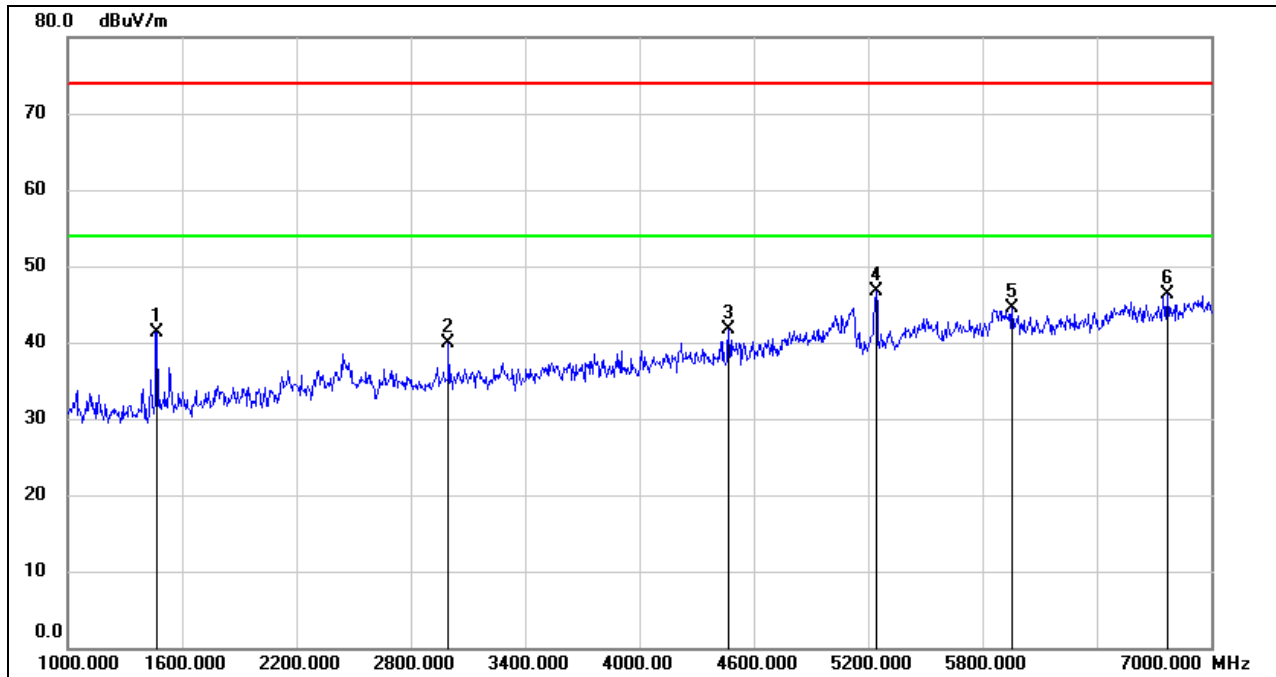

No.	Frequency (MHz)	Reading (dBuV)	Correct (dB/m)	Result (dBuV/m)	Limit (dBuV/m)	Margin (dB)	Remark
1	1468.000	54.30	-12.93	41.37	74.00	-32.63	peak
2	2998.000	46.28	-6.29	39.99	74.00	-34.01	peak
3	4468.000	43.85	-2.08	41.77	74.00	-32.23	peak
4	5242.000	45.40	1.37	46.77	74.00	-27.23	peak
5	5956.000	41.16	3.36	44.52	74.00	-29.48	peak
6	6772.000	41.74	4.55	46.29	74.00	-27.71	peak

Note: 1. Measurement = Reading Level + Correct Factor.  
 2. If Peak Result complies with AV limit, AV Result is deemed to comply with AV limit.  
 3. Peak: Peak detector.  
 4. Filter losses were only considered in the spurious frequency bands and the authorized band was not corrected for Band reject filter losses.  
 5. Proper operation of the transmitter prior to adding the filter to the measurement chain.  
 6. Owing to the highest peak level of unwanted emission out of the restricted bands complies with the lowest limit(54dBuV/m), so all the test point was deemed to comply with the limits list in the standard.



**7-18GHz**

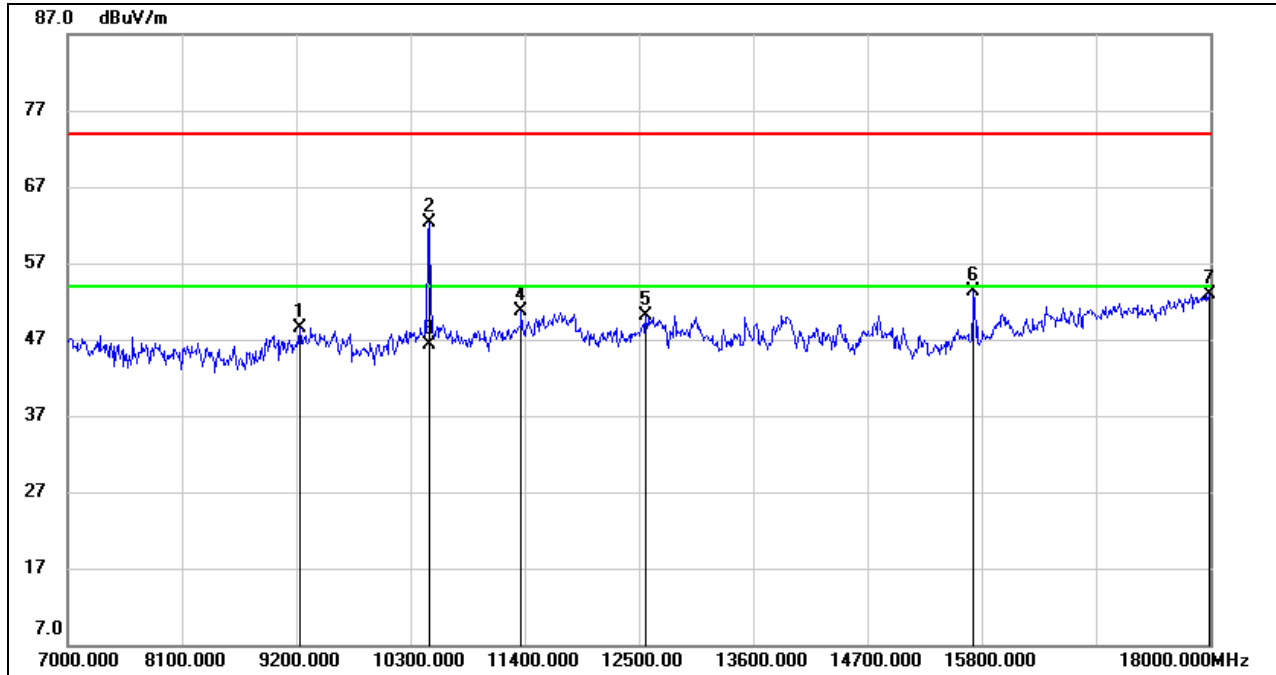

No.	Frequency (MHz)	Reading (dBuV)	Correct (dB/m)	Result (dBuV/m)	Limit (dBuV/m)	Margin (dB)	Remark
1	9233.000	39.28	9.24	48.52	74.00	-25.48	peak
2	10480.000	50.79	11.45	62.24	74.00	-11.76	peak
3	10480.000	34.94	11.45	46.39	54.00	-7.61	AVG
4	11367.000	37.25	13.38	50.63	74.00	-23.37	peak
5	12566.000	35.03	15.10	50.13	74.00	-23.87	peak
6	15723.000	36.57	16.82	53.39	74.00	-20.61	peak
7	17989.000	29.23	23.67	52.90	74.00	-21.10	peak

Note: 1. Measurement = Reading Level + Correct Factor.  
 2. If Peak Result complies with AV limit, AV Result is deemed to comply with AV limit.  
 3. Peak: Peak detector.  
 4. Filter losses were only considered in the spurious frequency bands and the authorized band was not corrected for HPF losses.  
 5. Proper operation of the transmitter prior to adding the filter to the measurement chain.  
 6. Owing to the highest peak level of unwanted emission out of the restricted bands complies with the lowest limit(54dBuV/m), so all the test point was deemed to comply with the limits list in the standard.





8.2.2. UNII-2A BAND

**RESTRICTED BANDEDGE HIGH CHANNEL**

**HORIZONTAL RESULTS**  
**PEAK**

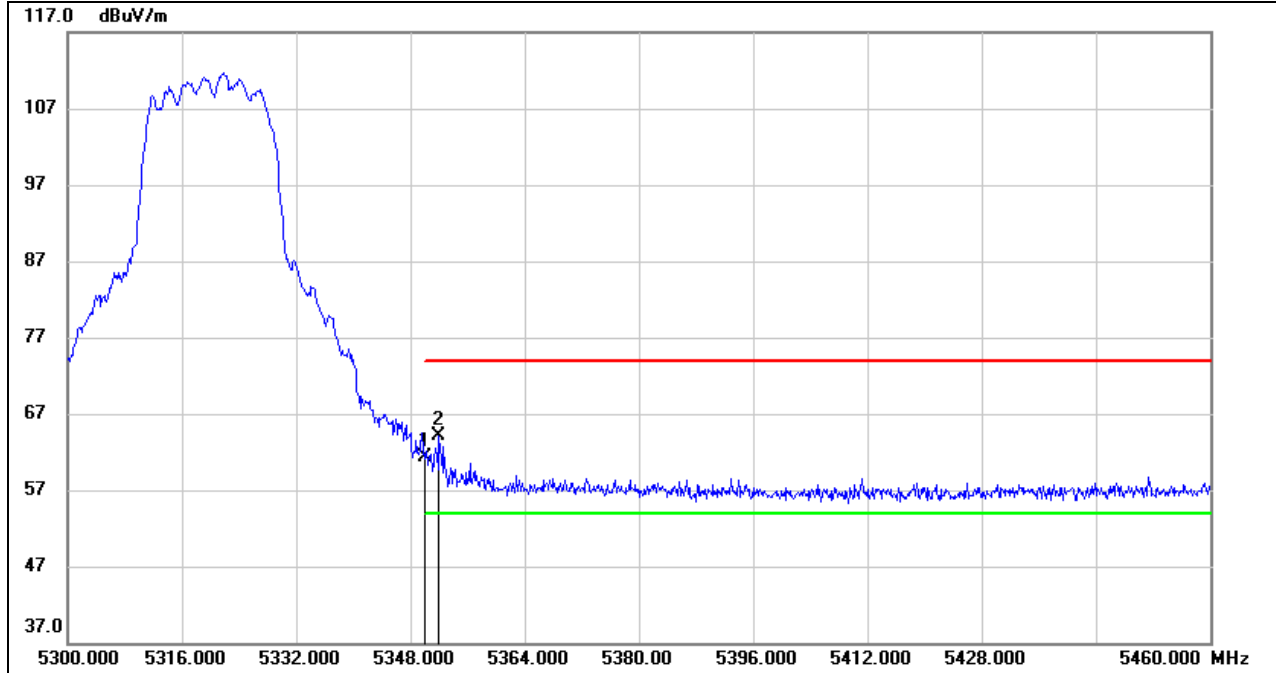

No.	Frequency (MHz)	Reading (dBuV)	Correct (dB/m)	Result (dBuV/m)	Limit (dBuV/m)	Margin (dB)	Remark
1	5350.000	20.68	40.64	61.32	74.00	-12.68	peak
2	5352.000	23.44	40.63	64.07	74.00	-9.93	peak

- Note: 1. Measurement = Reading Level + Correct Factor.  
 2. If Peak Result complies with AV limit, AV Result is deemed to comply with AV limit.  
 3. Peak: Peak detector.  
 4. Only the worst case emission will be recorder, if it complies with the limit, the other emissions deemed to comply with the limit.



**AVG**

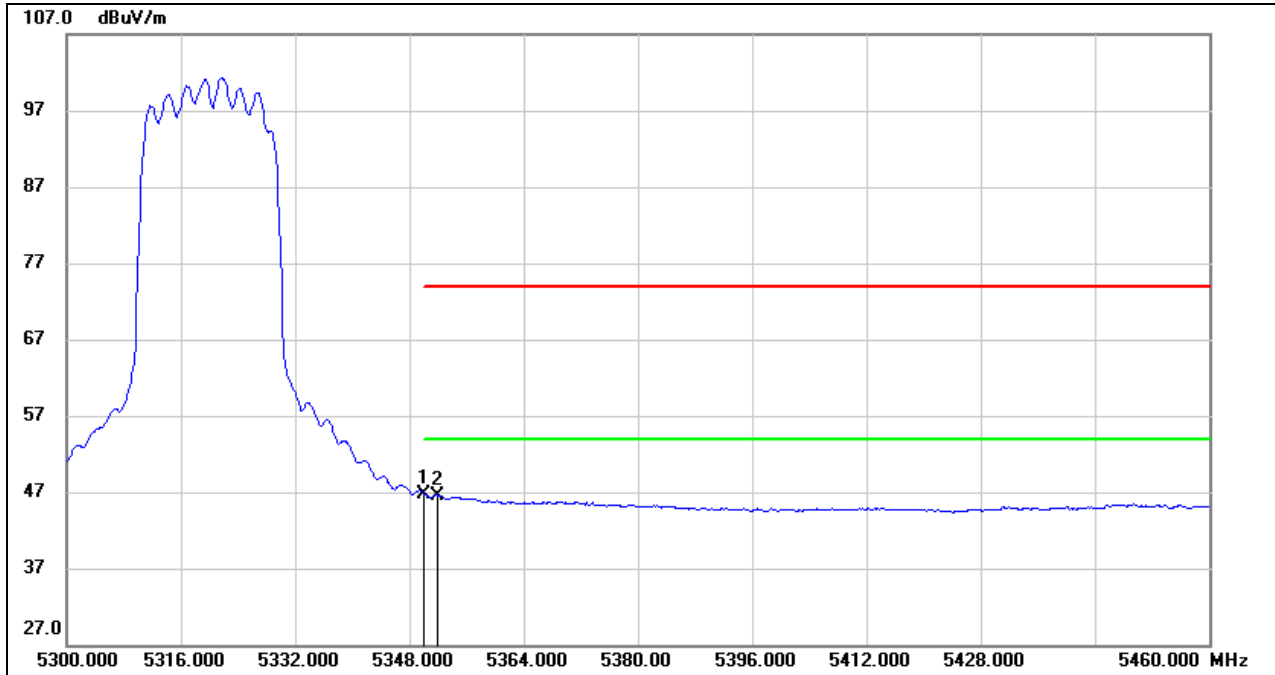

No.	Frequency (MHz)	Reading (dBuV)	Correct (dB/m)	Result (dBuV/m)	Limit (dBuV/m)	Margin (dB)	Remark
1	5350.000	6.16	40.64	46.80	54.00	-7.20	AVG
2	5352.000	5.90	40.63	46.53	54.00	-7.47	AVG

- Note: 1. Measurement = Reading Level + Correct Factor.  
 2. AVG: VBW=1/Ton where: ton is transmit duration.  
 3. For duty cycle, please refer to clause 7.1.  
 4. Only the worst case emission will be recorder, if it complies with the limit, the other emissions deemed to comply with the limit.



**VERTICAL RESULTS**  
**PEAK**

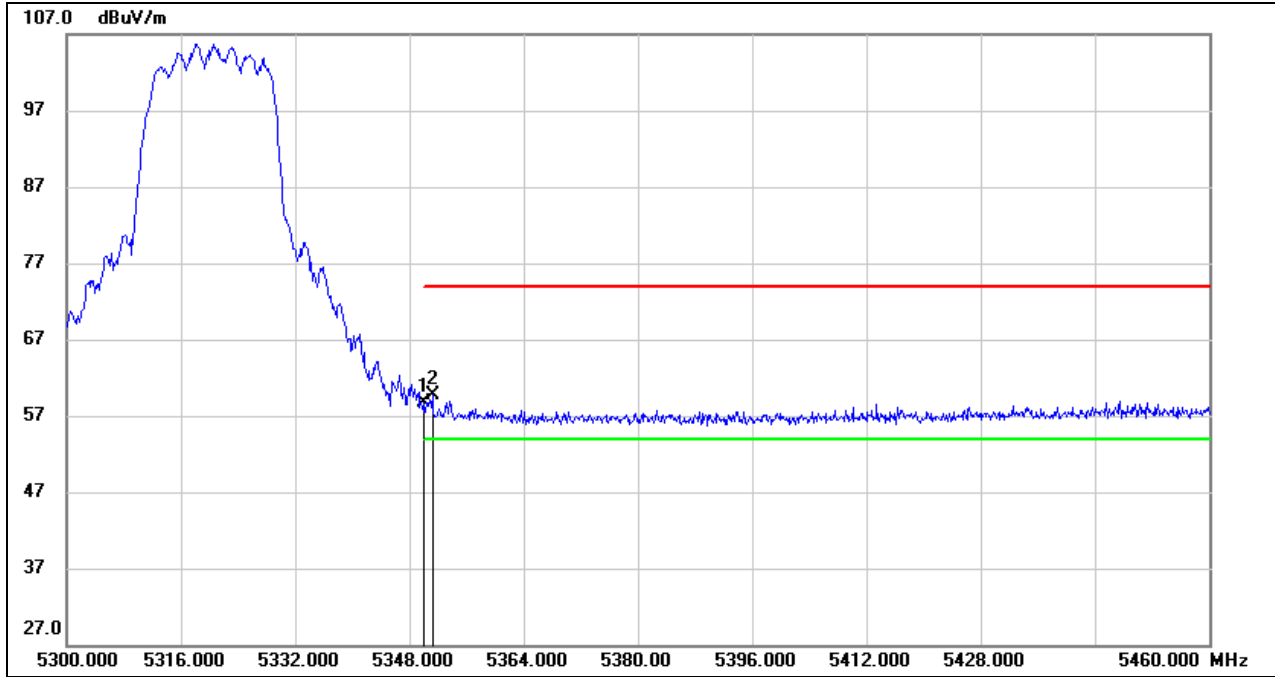

No.	Frequency (MHz)	Reading (dBuV)	Correct (dB/m)	Result (dBuV/m)	Limit (dBuV/m)	Margin (dB)	Remark
1	5350.000	18.11	40.64	58.75	74.00	-15.25	peak
2	5351.200	19.14	40.64	59.78	74.00	-14.22	peak

- Note: 1. Measurement = Reading Level + Correct Factor.  
 2. If Peak Result complies with AV limit, AV Result is deemed to comply with AV limit.  
 3. Peak: Peak detector.  
 4. Only the worst case emission will be recorder, if it complies with the limit, the other emissions deemed to comply with the limit.



**AVG**

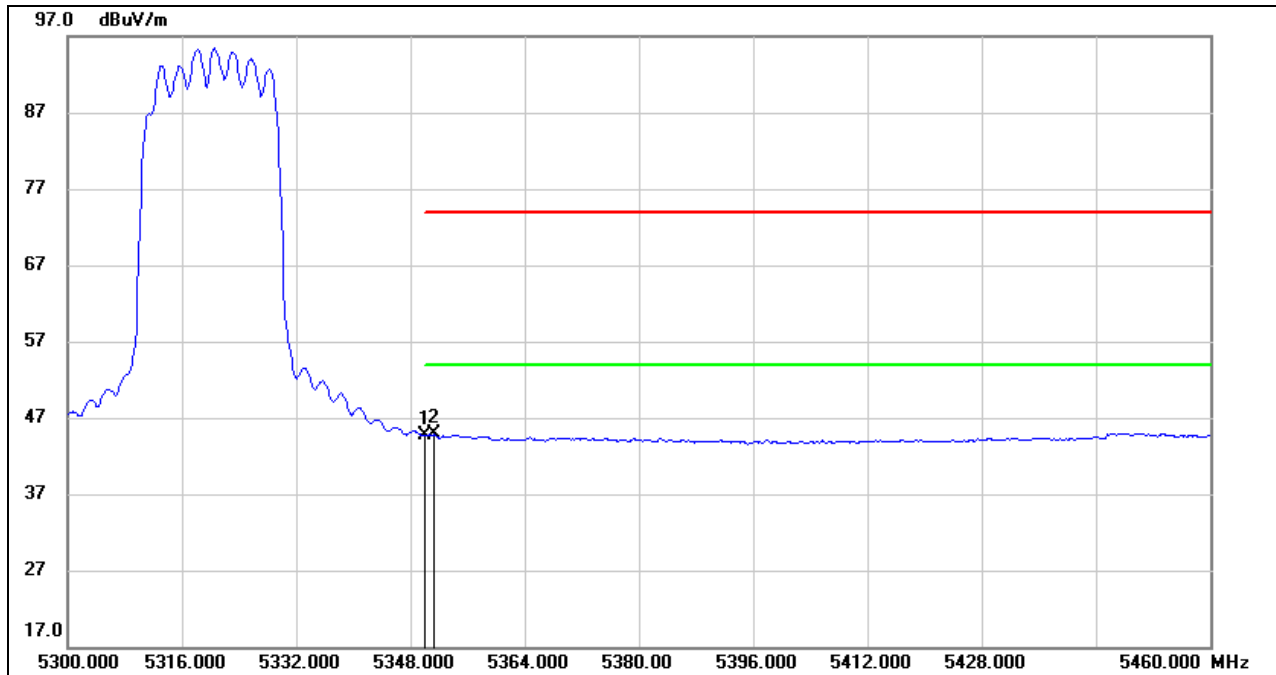

No.	Frequency (MHz)	Reading (dBuV)	Correct (dB/m)	Result (dBuV/m)	Limit (dBuV/m)	Margin (dB)	Remark
1	5350.000	4.16	40.64	44.80	54.00	-9.20	AVG
2	5351.200	4.19	40.64	44.83	54.00	-9.17	AVG

- Note: 1. Measurement = Reading Level + Correct Factor.  
 2. AVG: VBW=1/Ton where: ton is transmit duration.  
 3. For duty cycle, please refer to clause 7.1.  
 4. Only the worst case emission will be recorder, if it complies with the limit, the other emissions deemed to comply with the limit.



**HARMONICS AND SPURIOUS EMISSIONS LOW CHANNEL**

**HORIZONTAL RESULTS**  
**1-7GHz**

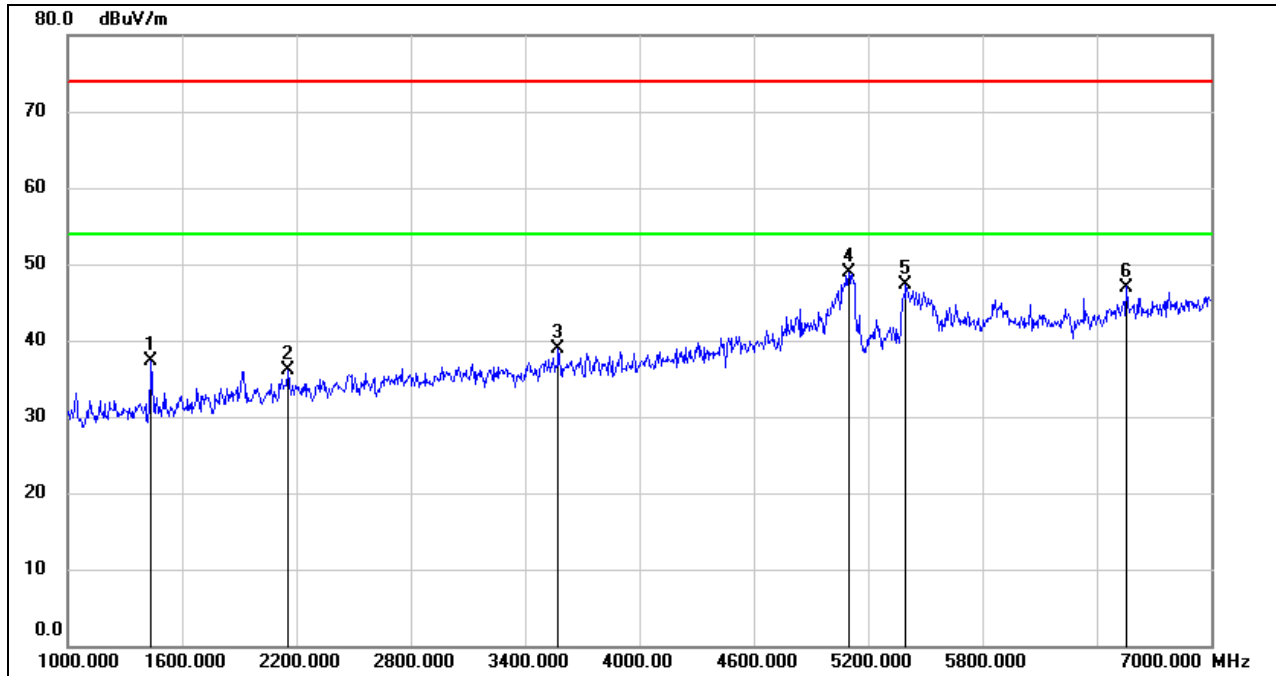

No.	Frequency (MHz)	Reading (dBuV)	Correct (dB/m)	Result (dBuV/m)	Limit (dBuV/m)	Margin (dB)	Remark
1	1438.000	50.31	-12.99	37.32	74.00	-36.68	peak
2	2158.000	45.88	-9.83	36.05	74.00	-37.95	peak
3	3574.000	43.91	-5.07	38.84	74.00	-35.16	peak
4	5098.000	48.22	0.76	48.98	74.00	-25.02	peak
5	5398.000	46.16	1.06	47.22	74.00	-26.78	peak
6	6556.000	42.26	4.74	47.00	74.00	-27.00	peak

Note: 1. Measurement = Reading Level + Correct Factor.  
 2. If Peak Result complies with AV limit, AV Result is deemed to comply with AV limit.  
 3. Peak: Peak detector.  
 4. Filter losses were only considered in the spurious frequency bands and the authorized band was not corrected for Band reject filter losses.  
 5. Proper operation of the transmitter prior to adding the filter to the measurement chain.  
 6. Owing to the highest peak level of unwanted emission out of the restricted bands complies with the lowest limit(54dBuV/m), so all the test point was deemed to comply with the limits list in the standard.



**HORIZONTAL RESULTS**  
**7-18GHz**

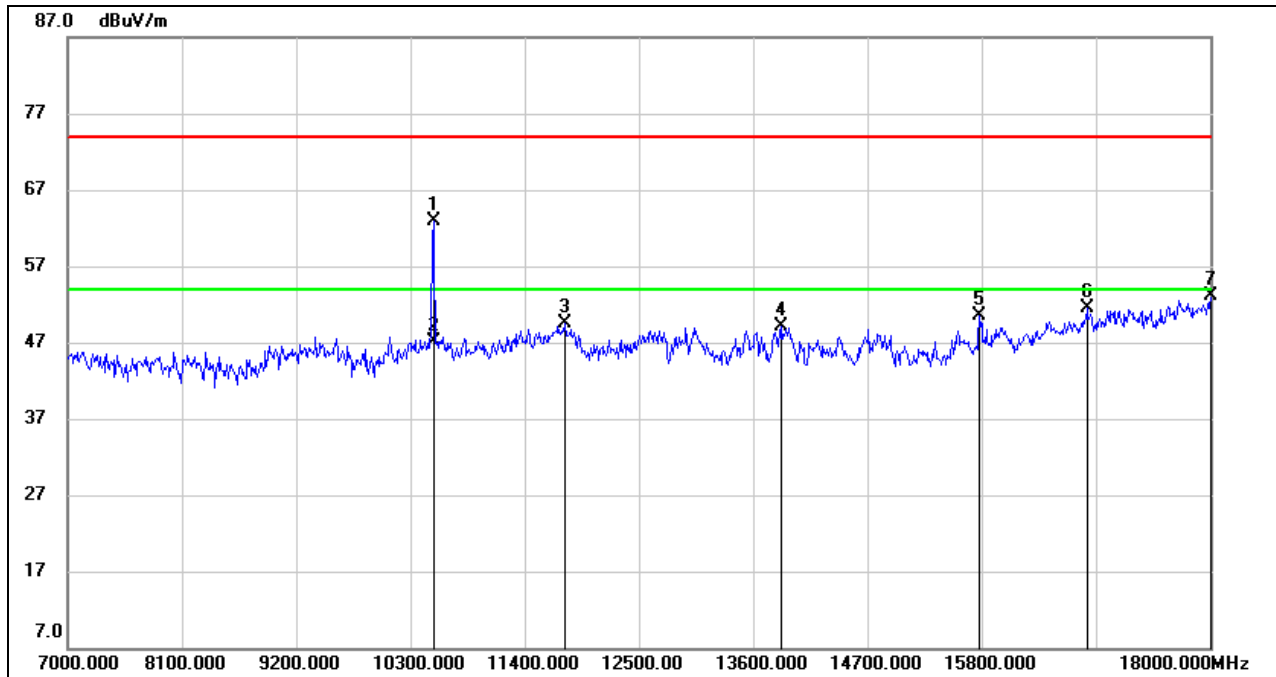

No.	Frequency (MHz)	Reading (dBuV)	Correct (dB/m)	Result (dBuV/m)	Limit (dBuV/m)	Margin (dB)	Remark
1	10520.000	51.32	11.60	62.92	74.00	-11.08	peak
2	10520.000	35.59	11.60	47.19	54.00	-6.81	AVG
3	11785.000	35.08	14.47	49.55	74.00	-24.45	peak
4	13875.000	32.68	16.33	49.01	74.00	-24.99	peak
5	15778.000	33.55	16.86	50.41	74.00	-23.59	peak
6	16812.000	31.41	20.14	51.55	74.00	-22.45	peak
7	18000.000	29.34	23.69	53.03	74.00	-20.97	peak

- Note: 1. Measurement = Reading Level + Correct Factor.  
 2. If Peak Result complies with AV limit, AV Result is deemed to comply with AV limit.  
 3. Peak: Peak detector.  
 4. Filter losses were only considered in the spurious frequency bands and the authorized band was not corrected for HPF losses.  
 5. Proper operation of the transmitter prior to adding the filter to the measurement chain.  
 6. Owing to the highest peak level of unwanted emission out of the restricted bands complies with the lowest limit(54dBuV/m), so all the test point was deemed to comply with the limits list in the standard.



**VERTICAL RESULTS**  
**1-7GHz**

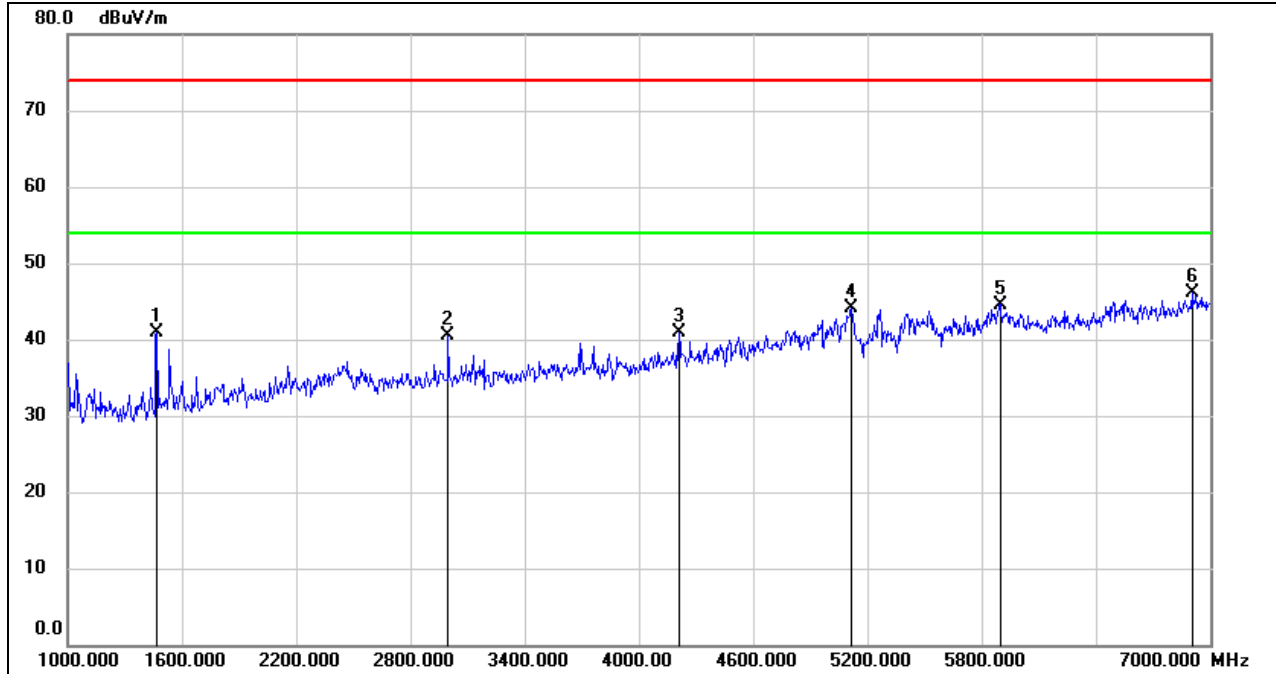

No.	Frequency (MHz)	Reading (dBuV)	Correct (dB/m)	Result (dBuV/m)	Limit (dBuV/m)	Margin (dB)	Remark
1	1468.000	53.87	-12.93	40.94	74.00	-33.06	peak
2	2998.000	46.82	-6.29	40.53	74.00	-33.47	peak
3	4210.000	43.60	-2.75	40.85	74.00	-33.15	peak
4	5116.000	43.20	0.86	44.06	74.00	-29.94	peak
5	5896.000	40.35	4.25	44.60	74.00	-29.40	peak
6	6904.000	40.81	5.20	46.01	74.00	-27.99	peak

Note: 1. Measurement = Reading Level + Correct Factor.  
 2. If Peak Result complies with AV limit, AV Result is deemed to comply with AV limit.  
 3. Peak: Peak detector.  
 4. Filter losses were only considered in the spurious frequency bands and the authorized band was not corrected for Band reject filter losses.  
 5. Proper operation of the transmitter prior to adding the filter to the measurement chain.  
 6. Owing to the highest peak level of unwanted emission out of the restricted bands complies with the lowest limit(54dBuV/m), so all the test point was deemed to comply with the limits list in the standard.



**7-18GHz**

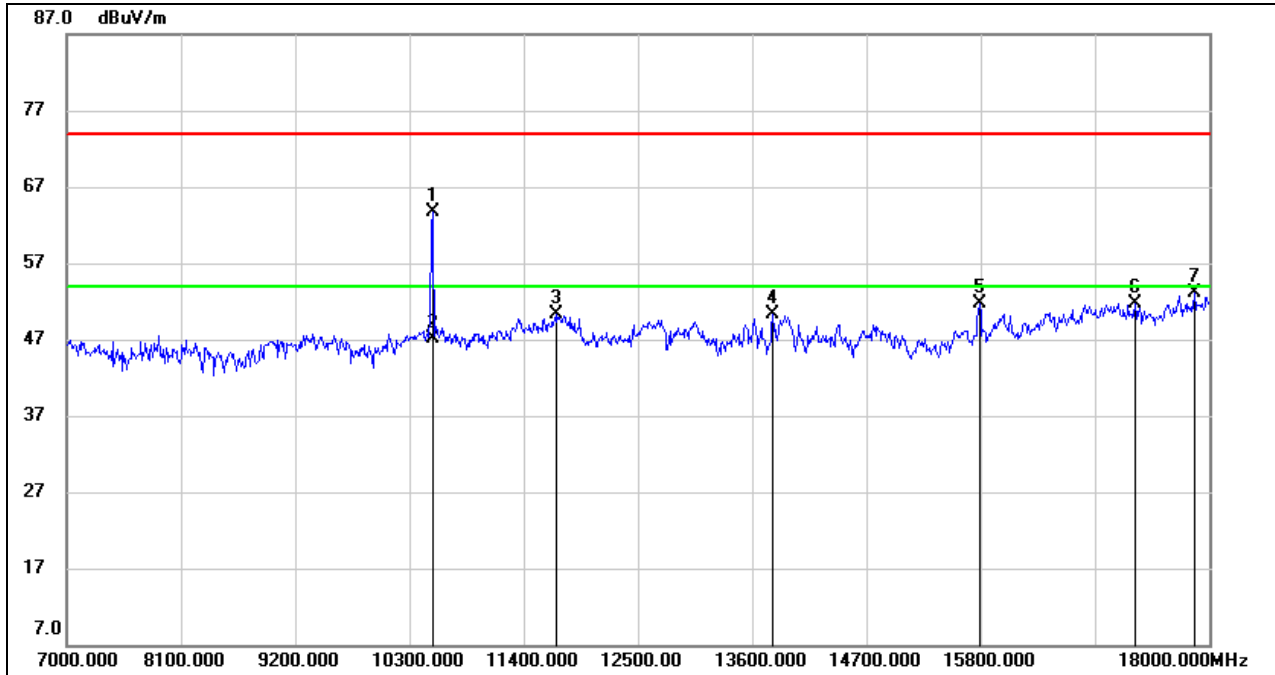

No.	Frequency (MHz)	Reading (dBuV)	Correct (dB/m)	Result (dBuV/m)	Limit (dBuV/m)	Margin (dB)	Remark
1	10520.000	52.03	11.60	63.63	74.00	-10.37	peak
2	10520.000	35.51	11.60	47.11	54.00	-6.89	AVG
3	11708.000	36.18	14.16	50.34	74.00	-23.66	peak
4	13798.000	33.89	16.44	50.33	74.00	-23.67	peak
5	15789.000	34.85	16.86	51.71	74.00	-22.29	peak
6	17285.000	30.23	21.47	51.70	74.00	-22.30	peak
7	17857.000	29.49	23.55	53.04	74.00	-20.96	peak

Note: 1. Measurement = Reading Level + Correct Factor.  
 2. If Peak Result complies with AV limit, AV Result is deemed to comply with AV limit.  
 3. Peak: Peak detector.  
 4. Filter losses were only considered in the spurious frequency bands and the authorized band was not corrected for HPF losses.  
 5. Proper operation of the transmitter prior to adding the filter to the measurement chain.  
 6. Owing to the highest peak level of unwanted emission out of the restricted bands complies with the lowest limit(54dBuV/m), so all the test point was deemed to comply with the limits list in the standard.





**HARMONICS AND SPURIOUS EMISSIONS MID CHANNEL**

**HORIZONTAL RESULTS**  
**1-7GHz**

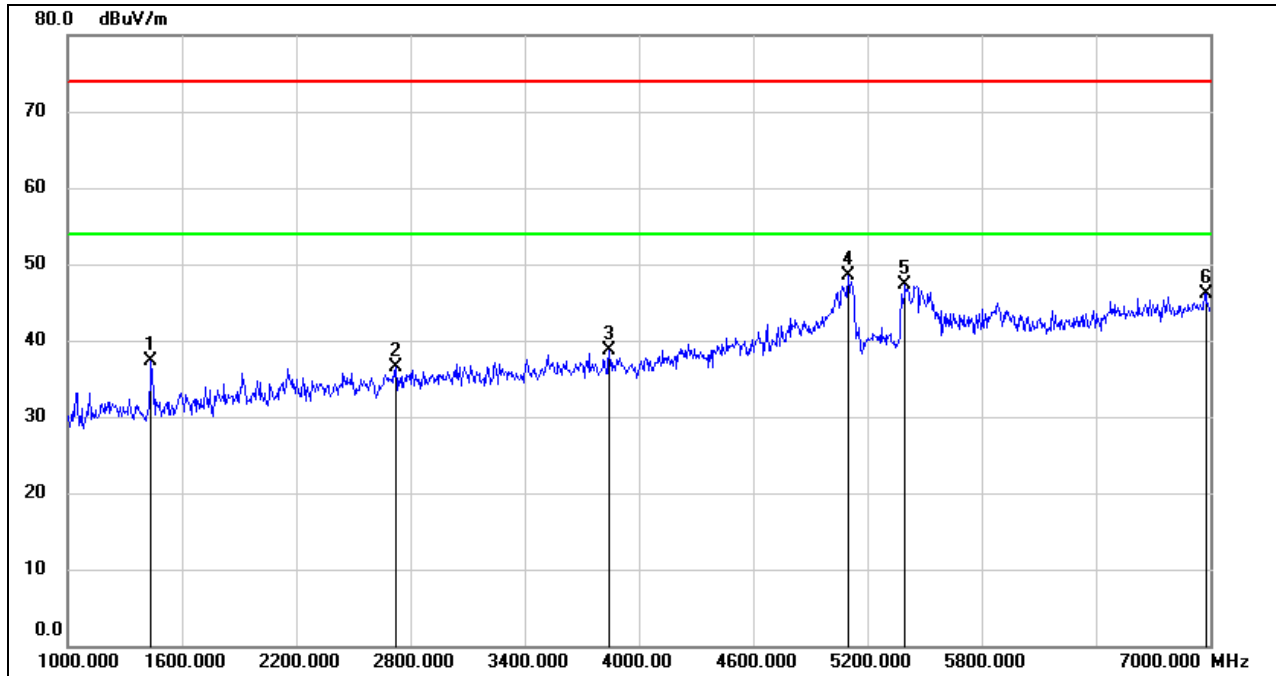

No.	Frequency (MHz)	Reading (dBuV)	Correct (dB/m)	Result (dBuV/m)	Limit (dBuV/m)	Margin (dB)	Remark
1	1438.000	50.33	-12.99	37.34	74.00	-36.66	peak
2	2722.000	44.29	-7.72	36.57	74.00	-37.43	peak
3	3844.000	43.07	-4.27	38.80	74.00	-35.20	peak
4	5098.000	47.74	0.76	48.50	74.00	-25.50	peak
5	5398.000	46.34	1.06	47.40	74.00	-26.60	peak
6	6976.000	40.82	5.25	46.07	74.00	-27.93	peak

Note: 1. Measurement = Reading Level + Correct Factor.  
 2. If Peak Result complies with AV limit, AV Result is deemed to comply with AV limit.  
 3. Peak: Peak detector.  
 4. Filter losses were only considered in the spurious frequency bands and the authorized band was not corrected for Band reject filter losses.  
 5. Proper operation of the transmitter prior to adding the filter to the measurement chain.  
 6. Owing to the highest peak level of unwanted emission out of the restricted bands complies with the lowest limit(54dBuV/m), so all the test point was deemed to comply with the limits list in the standard.



**HORIZONTAL RESULTS**  
**7-18GHz**

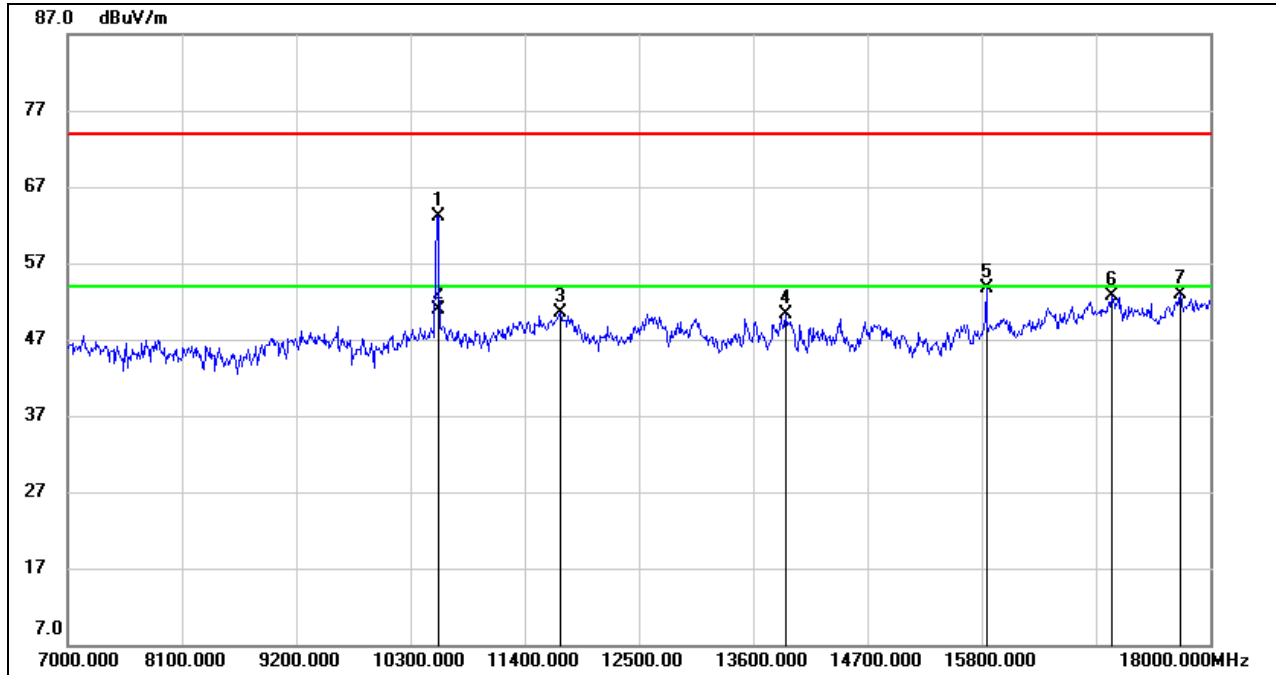

No.	Frequency (MHz)	Reading (dBuV)	Correct (dB/m)	Result (dBuV/m)	Limit (dBuV/m)	Margin (dB)	Remark
1	10561.902	51.42	11.74	63.16	74.00	-10.84	peak
2	10561.902	39.24	11.74	50.98	54.00	-3.02	AVG
3	11741.000	36.29	14.29	50.58	74.00	-23.42	peak
4	13908.000	34.02	16.26	50.28	74.00	-23.72	peak
5	15844.000	36.56	17.06	53.62	74.00	-20.38	peak
6	17054.000	31.99	20.79	52.78	74.00	-21.22	peak
7	17714.000	30.04	22.85	52.89	74.00	-21.11	peak

Note: 1. Measurement = Reading Level + Correct Factor.  
 2. If Peak Result complies with AV limit, AV Result is deemed to comply with AV limit.  
 3. Peak: Peak detector.  
 4. Filter losses were only considered in the spurious frequency bands and the authorized band was not corrected for HPF losses.  
 5. Proper operation of the transmitter prior to adding the filter to the measurement chain.  
 6. Owing to the highest peak level of unwanted emission out of the restricted bands complies with the lowest limit(54dBuV/m), so all the test point was deemed to comply with the limits list in the standard.



**VERTICAL RESULTS**  
**1-7GHz**

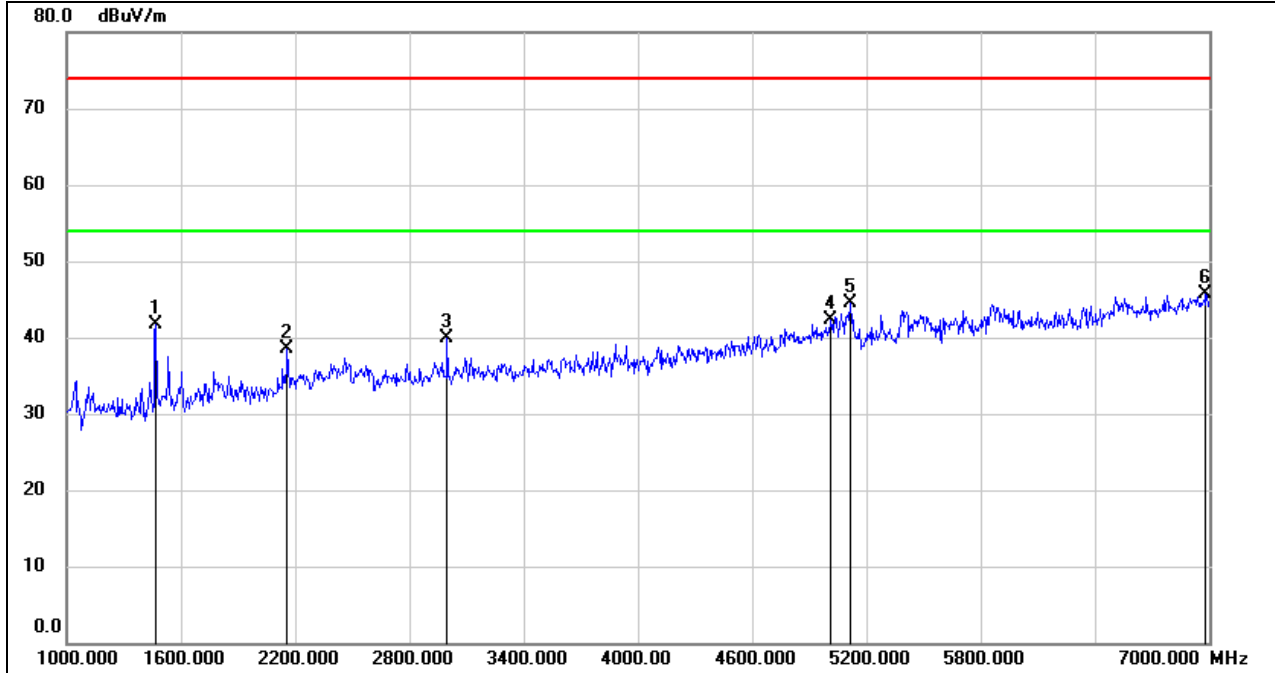

No.	Frequency (MHz)	Reading (dBuV)	Correct (dB/m)	Result (dBuV/m)	Limit (dBuV/m)	Margin (dB)	Remark
1	1468.000	54.70	-12.93	41.77	74.00	-32.23	peak
2	2158.000	48.31	-9.83	38.48	74.00	-35.52	peak
3	2998.000	46.16	-6.29	39.87	74.00	-34.13	peak
4	5014.000	41.55	0.72	42.27	74.00	-31.73	peak
5	5116.000	43.74	0.86	44.60	74.00	-29.40	peak
6	6982.000	40.47	5.26	45.73	74.00	-28.27	peak

Note: 1. Measurement = Reading Level + Correct Factor.  
 2. If Peak Result complies with AV limit, AV Result is deemed to comply with AV limit.  
 3. Peak: Peak detector.  
 4. Filter losses were only considered in the spurious frequency bands and the authorized band was not corrected for Band reject filter losses.  
 5. Proper operation of the transmitter prior to adding the filter to the measurement chain.  
 6. Owing to the highest peak level of unwanted emission out of the restricted bands complies with the lowest limit(54dBuV/m), so all the test point was deemed to comply with the limits list in the standard.



**7-18GHz**

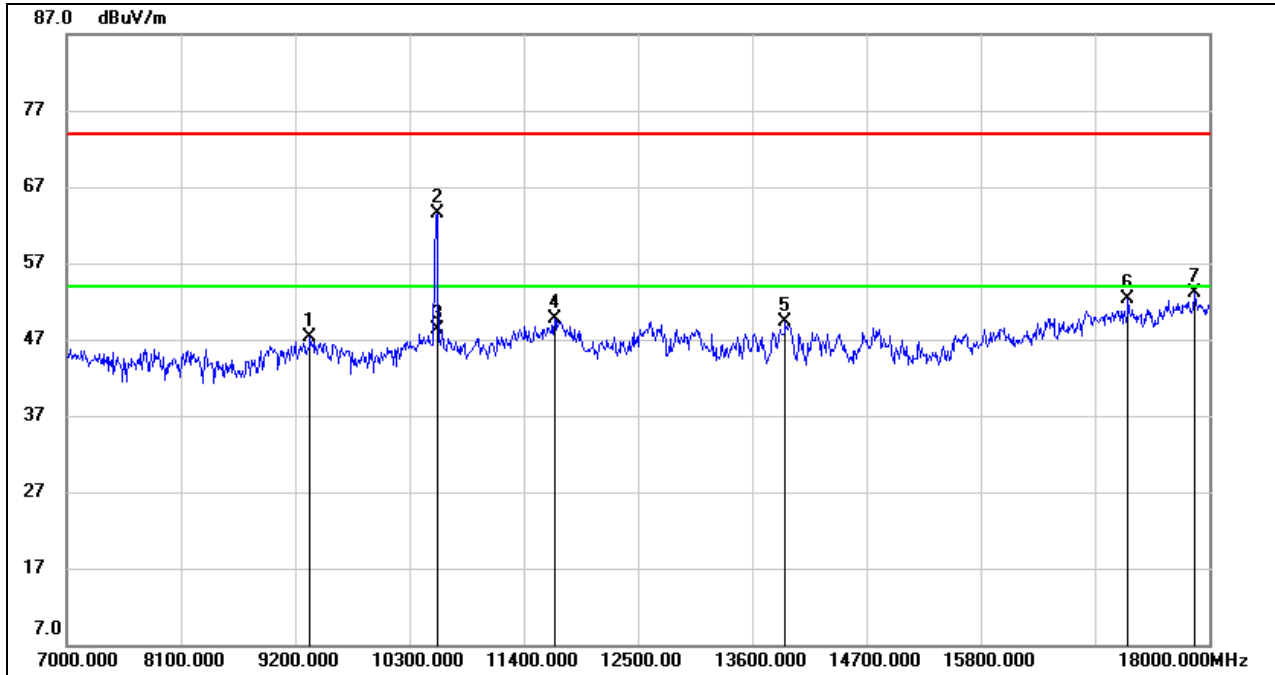

No.	Frequency (MHz)	Reading (dBuV)	Correct (dB/m)	Result (dBuV/m)	Limit (dBuV/m)	Margin (dB)	Remark
1	9343.000	37.56	9.73	47.29	74.00	-26.71	peak
2	10560.000	51.73	11.74	63.47	74.00	-10.53	peak
3	10560.000	36.61	11.74	48.35	54.00	-5.65	AVG
4	11697.000	35.50	14.11	49.61	74.00	-24.39	peak
5	13919.000	33.11	16.24	49.35	74.00	-24.65	peak
6	17219.000	30.63	21.64	52.27	74.00	-21.73	peak
7	17857.000	29.53	23.55	53.08	74.00	-20.92	peak

Note: 1. Measurement = Reading Level + Correct Factor.  
 2. If Peak Result complies with AV limit, AV Result is deemed to comply with AV limit.  
 3. Peak: Peak detector.  
 4. Filter losses were only considered in the spurious frequency bands and the authorized band was not corrected for HPF losses.  
 5. Proper operation of the transmitter prior to adding the filter to the measurement chain.  
 6. Owing to the highest peak level of unwanted emission out of the restricted bands complies with the lowest limit(54dBuV/m), so all the test point was deemed to comply with the limits list in the standard.



**HARMONICS AND SPURIOUS EMISSIONS HIGH CHANNEL**

**HORIZONTAL RESULTS**  
**1-7GHz**

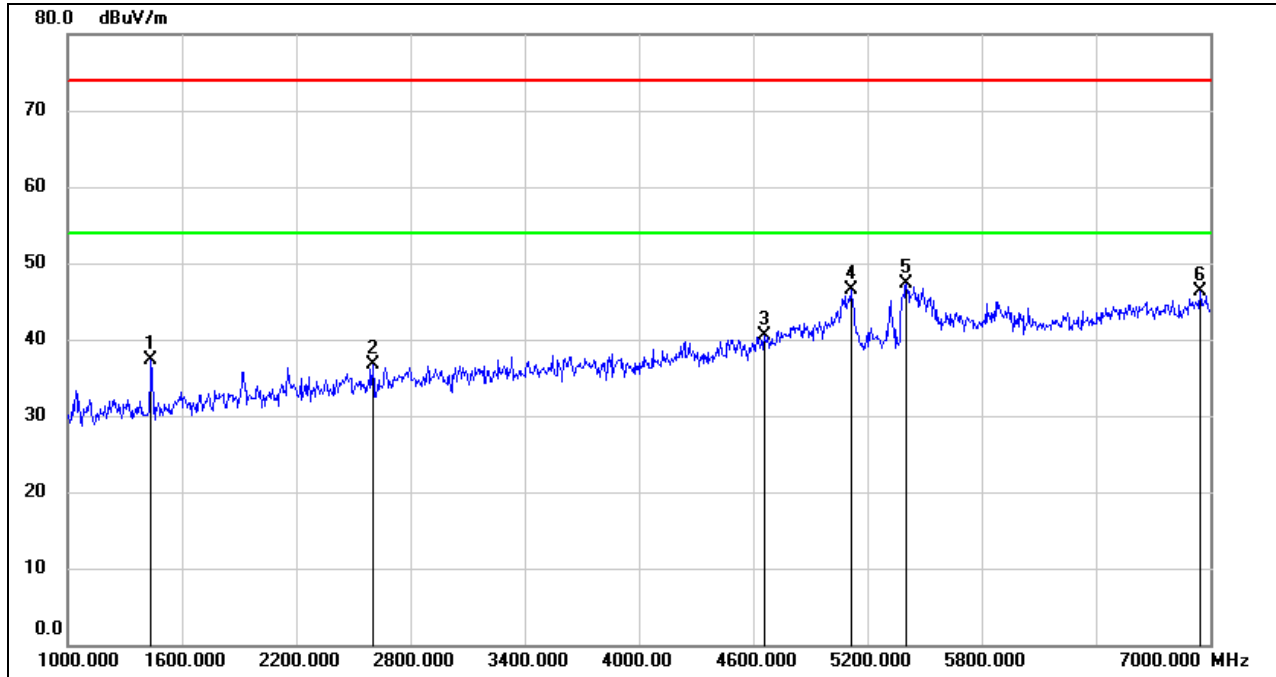

No.	Frequency (MHz)	Reading (dBuV)	Correct (dB/m)	Result (dBuV/m)	Limit (dBuV/m)	Margin (dB)	Remark
1	1438.000	50.29	-12.99	37.30	74.00	-36.70	peak
2	2602.000	45.30	-8.53	36.77	74.00	-37.23	peak
3	4660.000	41.67	-1.15	40.52	74.00	-33.48	peak
4	5116.000	45.60	0.86	46.46	74.00	-27.54	peak
5	5404.000	46.24	1.10	47.34	74.00	-26.66	peak
6	6946.000	41.16	5.22	46.38	74.00	-27.62	peak

Note: 1. Measurement = Reading Level + Correct Factor.  
 2. If Peak Result complies with AV limit, AV Result is deemed to comply with AV limit.  
 3. Peak: Peak detector.  
 4. Filter losses were only considered in the spurious frequency bands and the authorized band was not corrected for Band reject filter losses.  
 5. Proper operation of the transmitter prior to adding the filter to the measurement chain.  
 6. Owing to the highest peak level of unwanted emission out of the restricted bands complies with the lowest limit(54dBuV/m), so all the test point was deemed to comply with the limits list in the standard.



**HORIZONTAL RESULTS**  
**7-18GHz**

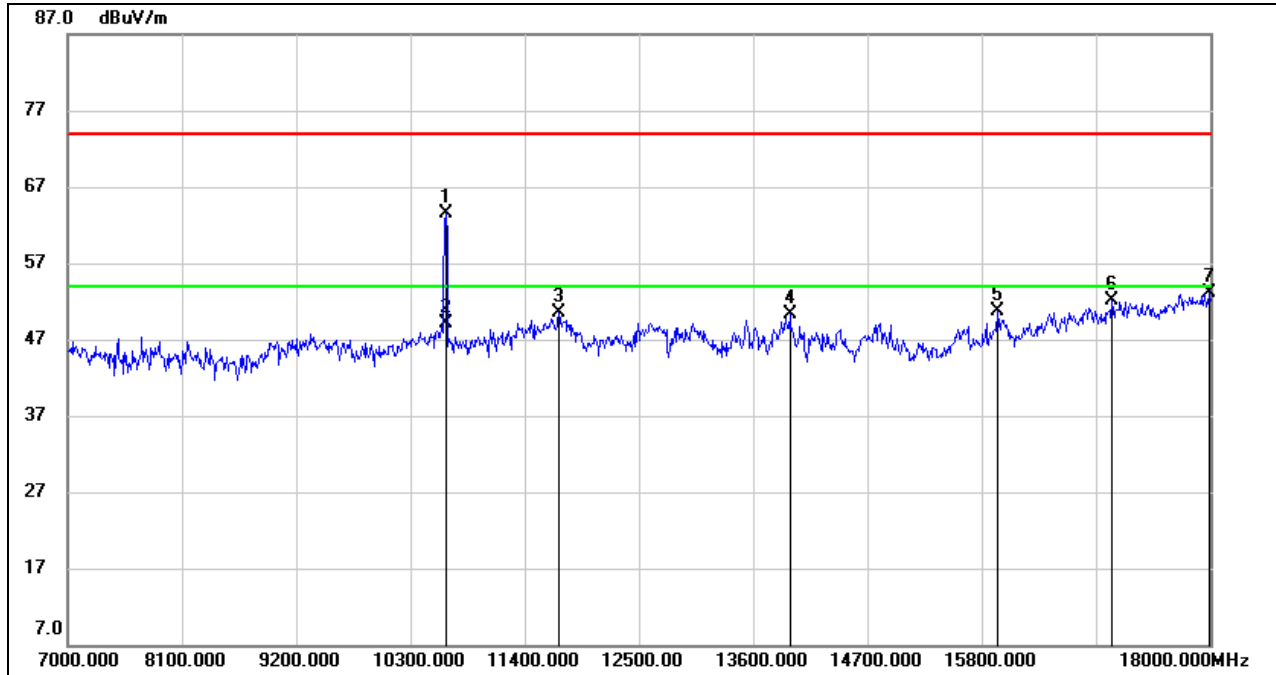

No.	Frequency (MHz)	Reading (dBuV)	Correct (dB/m)	Result (dBuV/m)	Limit (dBuV/m)	Margin (dB)	Remark
1	10640.000	51.64	11.91	63.55	74.00	-10.45	peak
2	10640.000	37.20	11.91	49.11	54.00	-4.89	AVG
3	11730.000	36.27	14.25	50.52	74.00	-23.48	peak
4	13952.000	34.04	16.19	50.23	74.00	-23.77	peak
5	15954.000	33.17	17.53	50.70	74.00	-23.30	peak
6	17054.000	31.36	20.79	52.15	74.00	-21.85	peak
7	17989.000	29.38	23.67	53.05	74.00	-20.95	peak

Note: 1. Measurement = Reading Level + Correct Factor.  
 2. If Peak Result complies with AV limit, AV Result is deemed to comply with AV limit.  
 3. Peak: Peak detector.  
 4. Filter losses were only considered in the spurious frequency bands and the authorized band was not corrected for HPF losses.  
 5. Proper operation of the transmitter prior to adding the filter to the measurement chain.  
 6. Owing to the highest peak level of unwanted emission out of the restricted bands complies with the lowest limit(54dBuV/m), so all the test point was deemed to comply with the limits list in the standard.



**VERTICAL RESULTS**  
**1-7GHz**

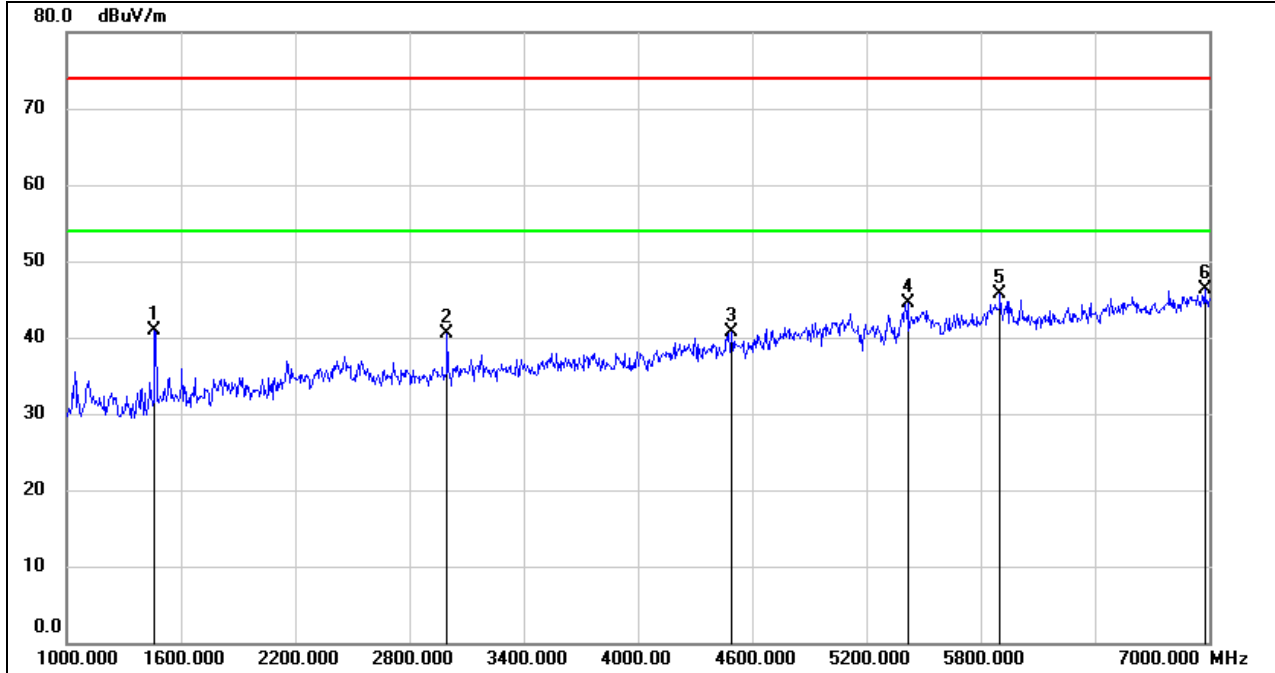

No.	Frequency (MHz)	Reading (dBuV)	Correct (dB/m)	Result (dBuV/m)	Limit (dBuV/m)	Margin (dB)	Remark
1	1462.000	53.76	-12.94	40.82	74.00	-33.18	peak
2	2998.000	46.84	-6.29	40.55	74.00	-33.45	peak
3	4492.000	42.55	-1.83	40.72	74.00	-33.28	peak
4	5416.000	43.34	1.26	44.60	74.00	-29.40	peak
5	5902.000	41.50	4.28	45.78	74.00	-28.22	peak
6	6976.000	41.12	5.25	46.37	74.00	-27.63	peak

Note: 1. Measurement = Reading Level + Correct Factor.  
 2. If Peak Result complies with AV limit, AV Result is deemed to comply with AV limit.  
 3. Peak: Peak detector.  
 4. Filter losses were only considered in the spurious frequency bands and the authorized band was not corrected for Band reject filter losses.  
 5. Proper operation of the transmitter prior to adding the filter to the measurement chain.  
 6. Owing to the highest peak level of unwanted emission out of the restricted bands complies with the lowest limit(54dBuV/m), so all the test point was deemed to comply with the limits list in the standard.



**7-18GHz**

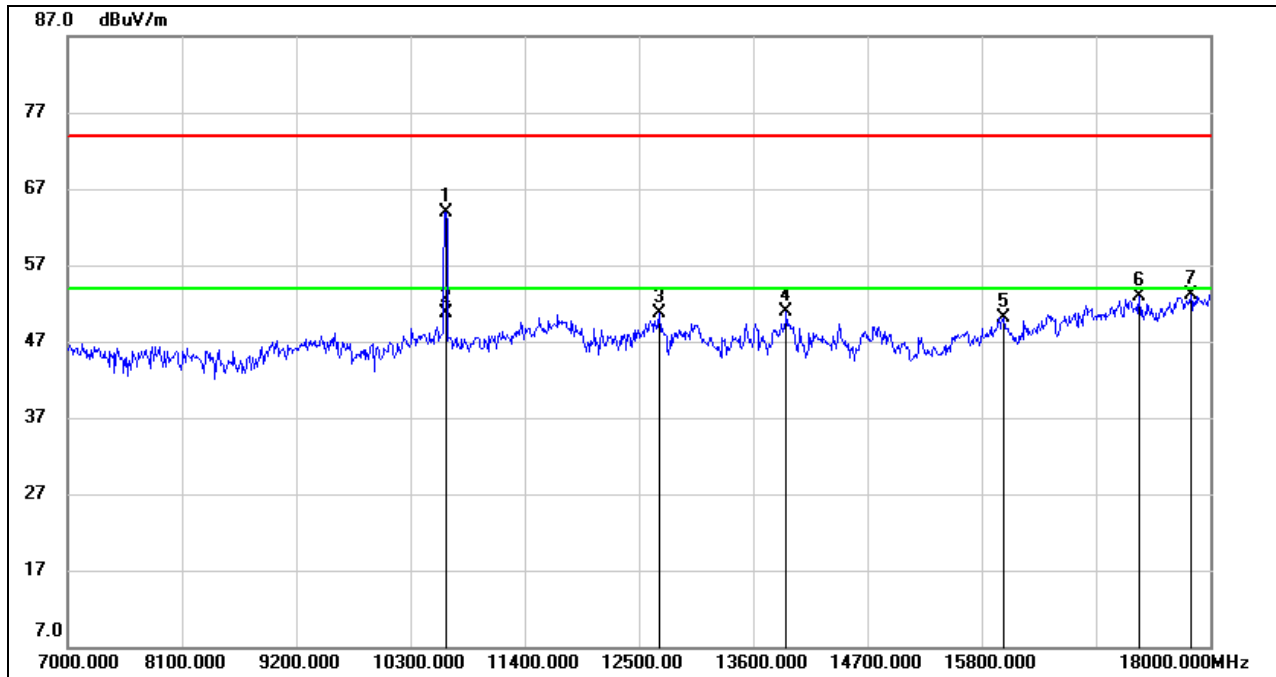

No.	Frequency (MHz)	Reading (dBuV)	Correct (dB/m)	Result (dBuV/m)	Limit (dBuV/m)	Margin (dB)	Remark
1	10640.980	52.07	11.91	63.98	74.00	-10.02	peak
2	10640.980	38.70	11.91	50.61	54.00	-3.39	AVG
3	12698.000	35.55	15.25	50.80	74.00	-23.20	peak
4	13919.000	34.65	16.24	50.89	74.00	-23.11	peak
5	16009.000	32.41	17.74	50.15	74.00	-23.85	peak
6	17318.000	31.47	21.38	52.85	74.00	-21.15	peak
7	17813.000	29.65	23.50	53.15	74.00	-20.85	peak

Note: 1. Measurement = Reading Level + Correct Factor.  
 2. If Peak Result complies with AV limit, AV Result is deemed to comply with AV limit.  
 3. Peak: Peak detector.  
 4. Filter losses were only considered in the spurious frequency bands and the authorized band was not corrected for HPF losses.  
 5. Proper operation of the transmitter prior to adding the filter to the measurement chain.  
 6. Owing to the highest peak level of unwanted emission out of the restricted bands complies with the lowest limit(54dBuV/m), so all the test point was deemed to comply with the limits list in the standard.





**8.2.3. UNII-2C BAND**  
**RESTRICTED BANDEDGE LOW CHANNEL**

**HORIZONTAL RESULTS**  
**PEAK**

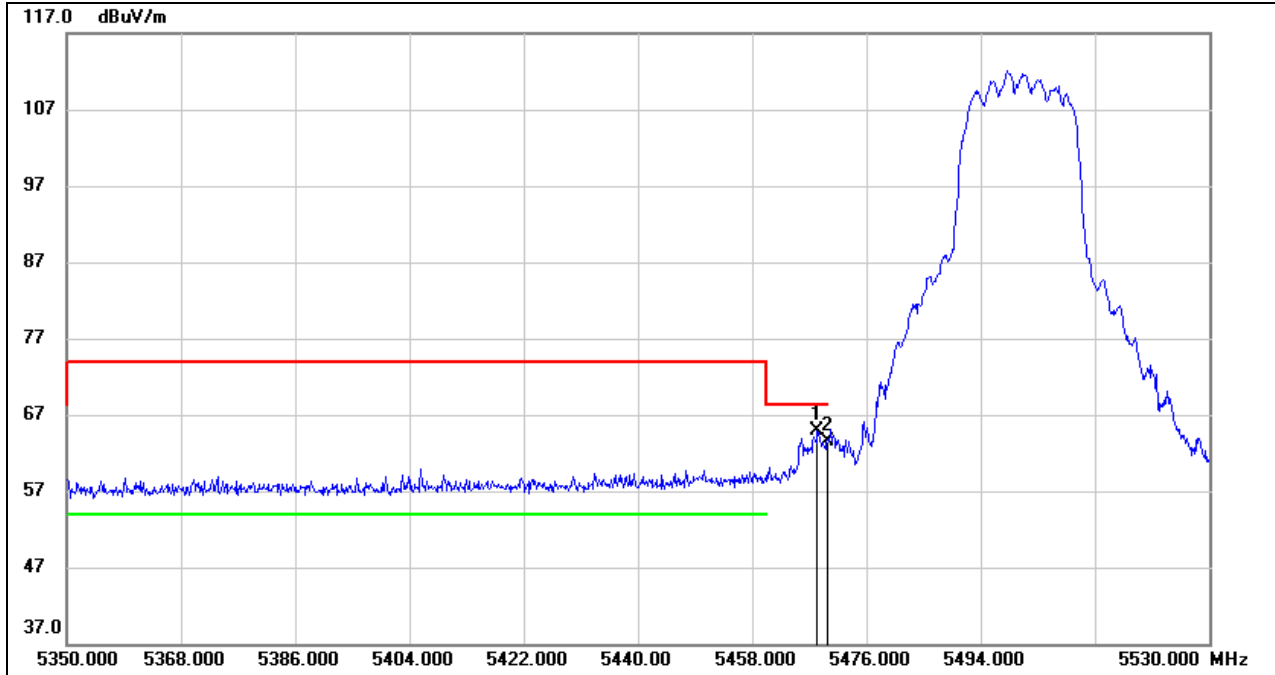

No.	Frequency (MHz)	Reading (dBuV)	Correct (dB/m)	Result (dBuV/m)	Limit (dBuV/m)	Margin (dB)	Remark
1	5468.260	23.58	41.39	64.97	68.20	-3.23	peak
2	5470.000	22.13	41.41	63.54	68.20	-4.66	peak

- Note: 1. Measurement = Reading Level + Correct Factor.  
 2. If Peak Result complies with AV limit, AV Result is deemed to comply with AV limit.  
 3. Peak: Peak detector.  
 4.\*indicates frequency out of the restricted bands  
 5. Only the worst case emission will be recorder, if it complies with the limit, the other emissions deemed to comply with the limit.



**AVG**

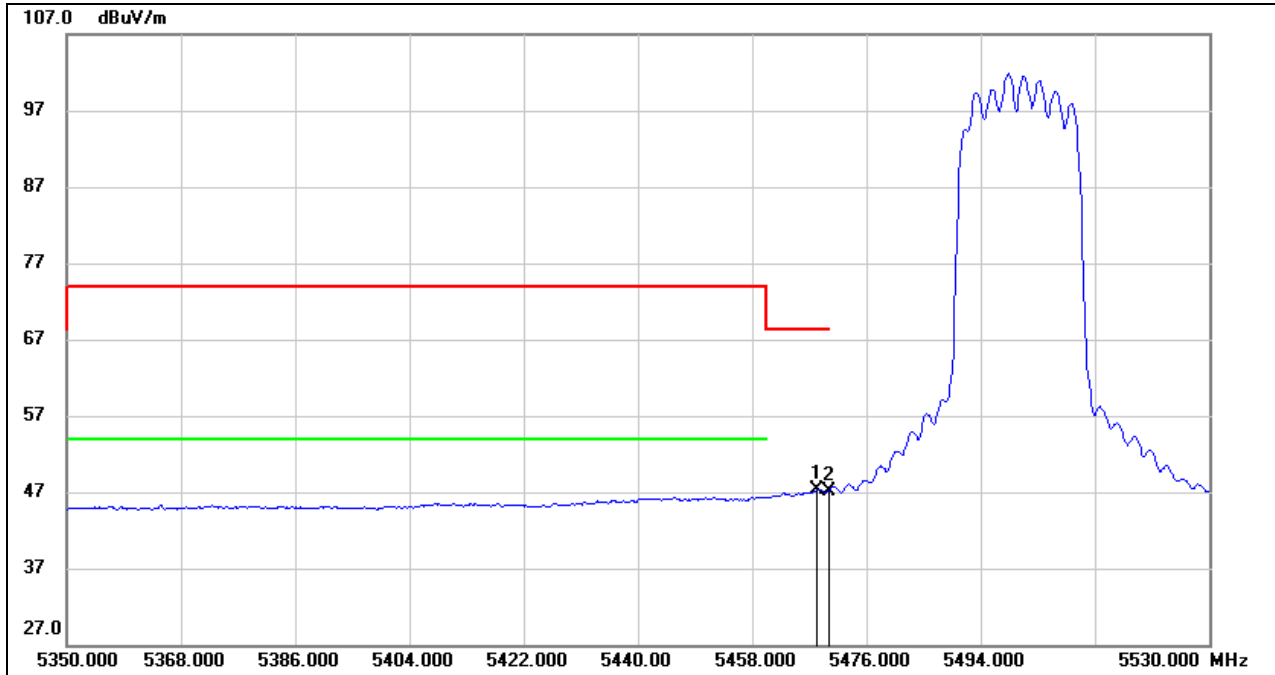

No.	Frequency (MHz)	Reading (dBuV)	Correct (dB/m)	Result (dBuV/m)	Limit (dBuV/m)	Margin (dB)	Remark
1	5468.260	5.98	41.39	47.37	68.20	-20.83	AVG
2	5470.000	5.75	41.41	47.16	68.20	-21.04	AVG

- Note: 1. Measurement = Reading Level + Correct Factor.  
 2. AVG: VBW=1/Ton where: ton is transmit duration.  
 3. For duty cycle, please refer to clause 7.1.  
 4. Only the worst case emission will be recorder, if it complies with the limit, the other emissions deemed to comply with the limit.



**VERTICAL RESULTS**  
**PEAK**

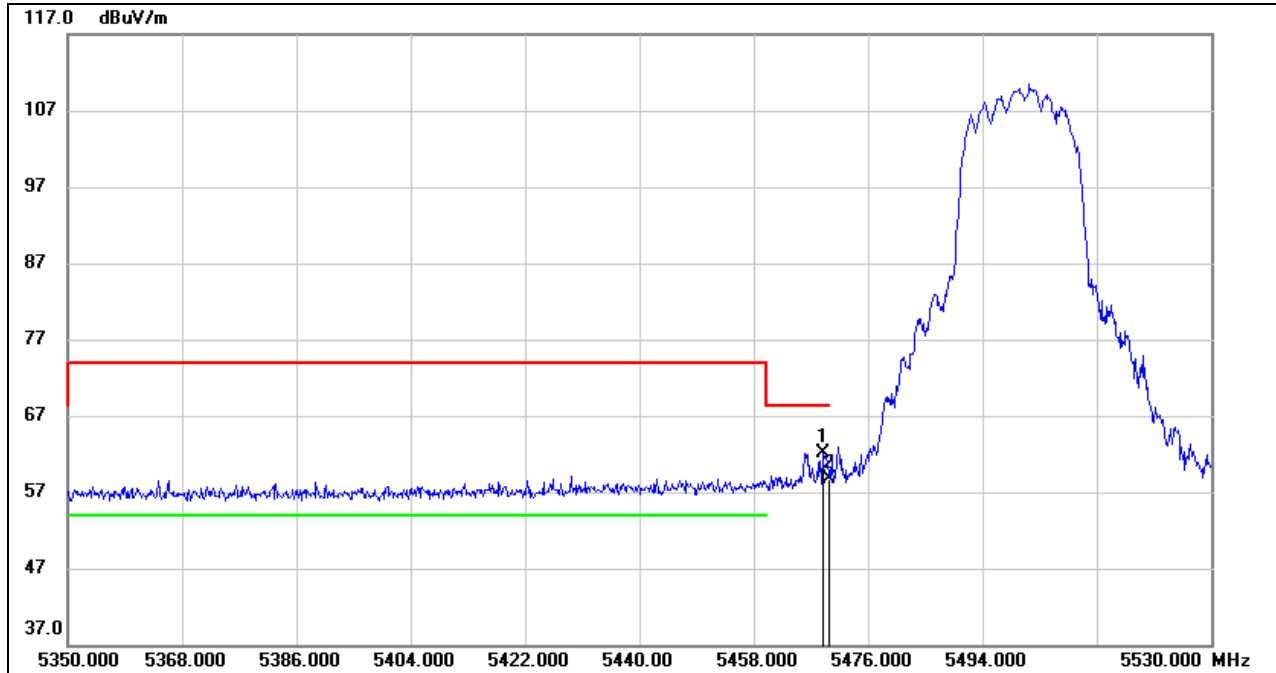

No.	Frequency (MHz)	Reading (dBuV)	Correct (dB/m)	Result (dBuV/m)	Limit (dBuV/m)	Margin (dB)	Remark
1	5468.800	20.69	41.39	62.08	68.20	-6.12	peak
2	5470.000	17.37	41.41	58.78	68.20	-9.42	peak

- Note: 1. Measurement = Reading Level + Correct Factor.  
 2. If Peak Result complies with AV limit, AV Result is deemed to comply with AV limit.  
 3. Peak: Peak detector.  
 4.\*indicates frequency out of the restricted bands  
 5. Only the worst case emission will be recorder, if it complies with the limit, the other emissions deemed to comply with the limit.



**AVG**

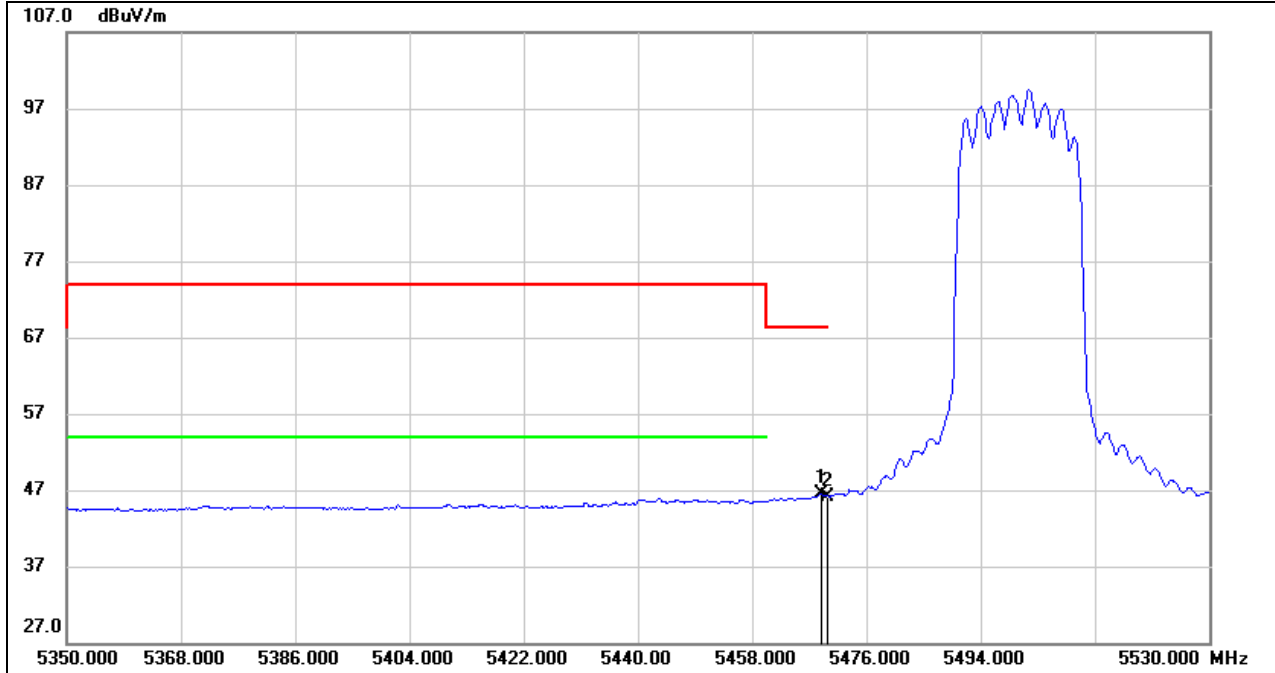

No.	Frequency (MHz)	Reading (dBuV)	Correct (dB/m)	Result (dBuV/m)	Limit (dBuV/m)	Margin (dB)	Remark
1	5468.800	5.08	41.39	46.47	68.20	-21.73	AVG
2	5470.000	4.76	41.41	46.17	68.20	-22.03	AVG

- Note: 1. Measurement = Reading Level + Correct Factor.  
 2. AVG: VBW=1/Ton where: ton is transmit duration.  
 3. For duty cycle, please refer to clause 7.1.  
 4. Only the worst case emission will be recorder, if it complies with the limit, the other emissions deemed to comply with the limit.



**RESTRICTED BANDEDGE HIGH CHANNEL**

**HORIZONTAL RESULTS**  
**PEAK**

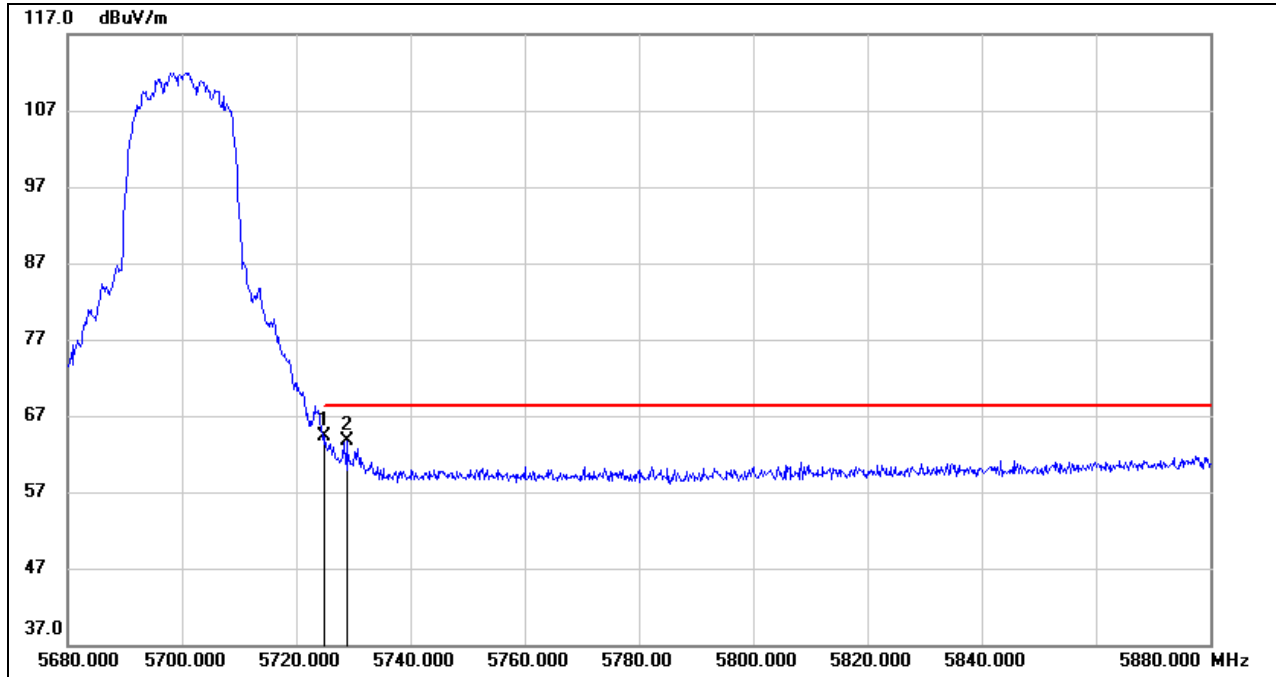

No.	Frequency (MHz)	Reading (dBuV)	Correct (dB/m)	Result (dBuV/m)	Limit (dBuV/m)	Margin (dB)	Remark
1	5725.000	22.60	41.61	64.21	68.20	-3.99	peak
2	5728.800	21.99	41.62	63.61	68.20	-4.59	peak

- Note: 1. Measurement = Reading Level + Correct Factor.  
 2. If Peak Result complies with AV limit, AV Result is deemed to comply with AV limit.  
 3. Peak: Peak detector.  
 4.\*indicates frequency out of the restricted bands  
 5. Only the worst case emission will be recorder, if it complies with the limit, the other emissions deemed to comply with the limit.



**VERTICAL RESULTS**  
**PEAK**

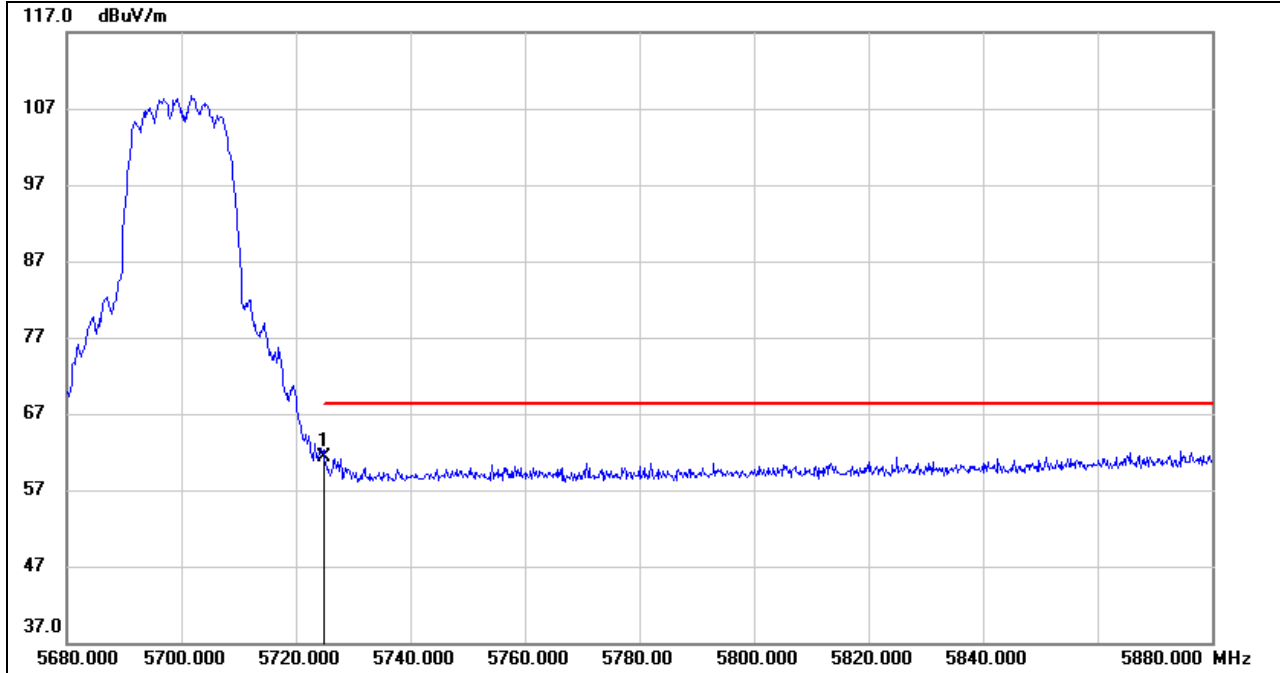

No.	Frequency (MHz)	Reading (dBuV)	Correct (dB/m)	Result (dBuV/m)	Limit (dBuV/m)	Margin (dB)	Remark
1	5725.000	19.59	41.61	61.20	68.20	-7.00	peak

- Note:
1. Measurement = Reading Level + Correct Factor.
  2. If Peak Result complies with AV limit, AV Result is deemed to comply with AV limit.
  3. Peak: Peak detector.
  - 4.\*indicates frequency out of the restricted bands
  5. Only the worst case emission will be recorder, if it complies with the limit, the other emissions deemed to comply with the limit.



**HARMONICS AND SPURIOUS EMISSIONS LOW CHANNEL**

**HORIZONTAL RESULTS**  
**1-7GHz**

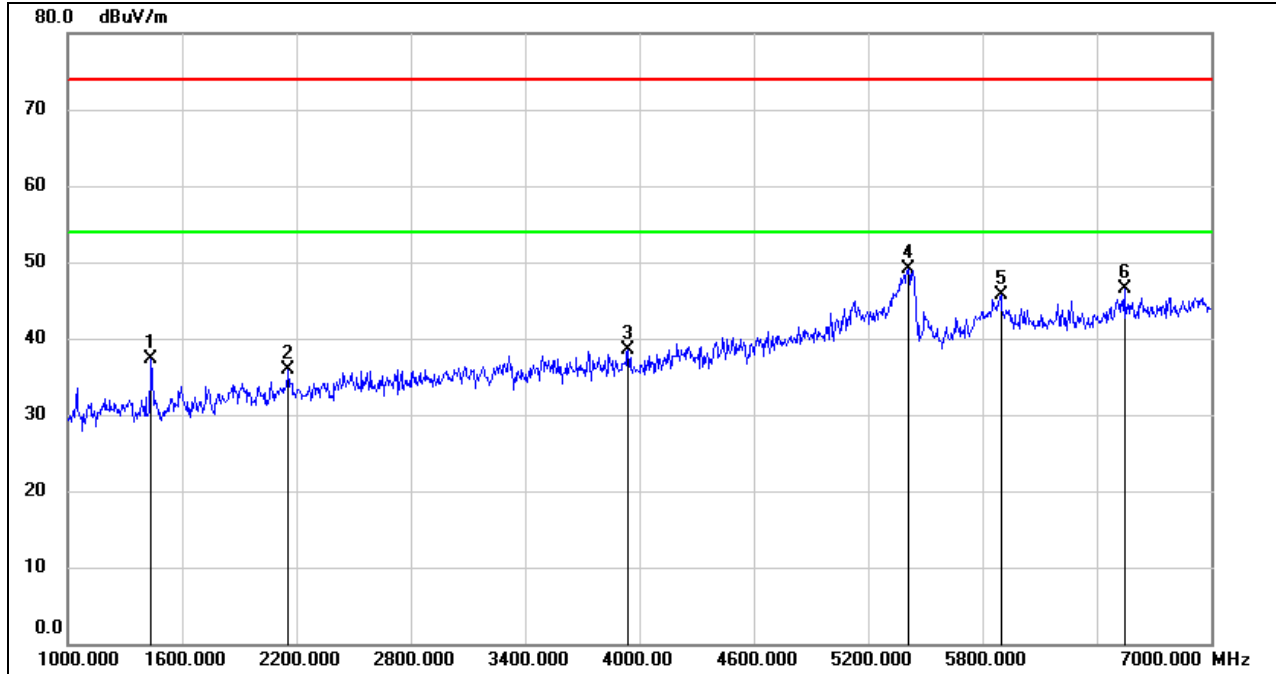

No.	Frequency (MHz)	Reading (dBuV)	Correct (dB/m)	Result (dBuV/m)	Limit (dBuV/m)	Margin (dB)	Remark
1	1438.000	50.33	-12.99	37.34	74.00	-36.66	peak
2	2158.000	45.64	-9.83	35.81	74.00	-38.19	peak
3	3940.000	42.73	-4.23	38.50	74.00	-35.50	peak
4	5410.000	48.03	1.17	49.20	74.00	-24.80	peak
5	5896.000	41.47	4.25	45.72	74.00	-28.28	peak
6	6544.000	41.63	4.79	46.42	74.00	-27.58	peak

- Note: 1. Measurement = Reading Level + Correct Factor.  
 2. If Peak Result complies with AV limit, AV Result is deemed to comply with AV limit.  
 3. Peak: Peak detector.  
 4. Filter losses were only considered in the spurious frequency bands and the authorized band was not corrected for Band reject filter losses.  
 5. Proper operation of the transmitter prior to adding the filter to the measurement chain.  
 6. Owing to the highest peak level of unwanted emission out of the restricted bands complies with the lowest limit(54dBuV/m), so all the test point was deemed to comply with the limits list in the standard.



**HORIZONTAL RESULTS**  
**7-18GHz**

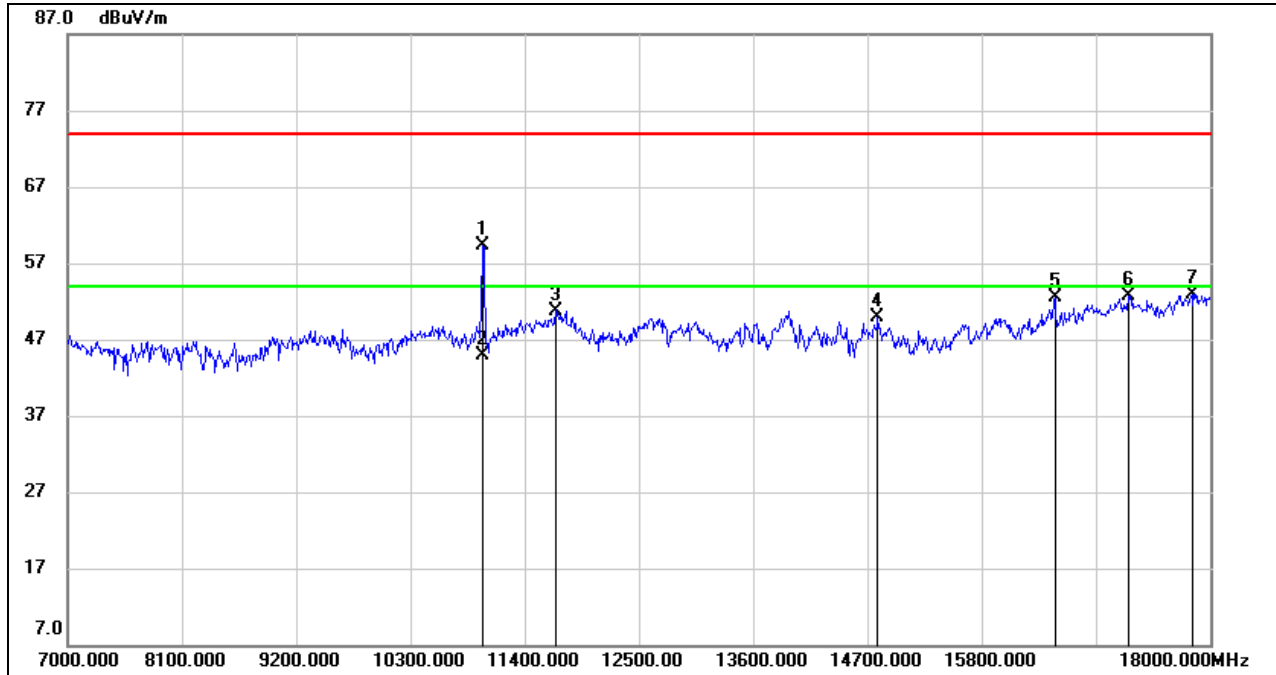

No.	Frequency (MHz)	Reading (dBuV)	Correct (dB/m)	Result (dBuV/m)	Limit (dBuV/m)	Margin (dB)	Remark
1	11000.000	46.65	12.63	59.28	74.00	-14.72	peak
2	11000.000	32.21	12.63	44.84	54.00	-9.16	AVG
3	11697.000	36.69	14.11	50.80	74.00	-23.20	peak
4	14799.000	33.78	16.03	49.81	74.00	-24.19	peak
5	16504.000	33.09	19.47	52.56	74.00	-21.44	peak
6	17208.000	31.04	21.67	52.71	74.00	-21.29	peak
7	17824.000	29.45	23.52	52.97	74.00	-21.03	peak

Note: 1. Measurement = Reading Level + Correct Factor.  
 2. If Peak Result complies with AV limit, AV Result is deemed to comply with AV limit.  
 3. Peak: Peak detector.  
 4. Filter losses were only considered in the spurious frequency bands and the authorized band was not corrected for HPF losses.  
 5. Proper operation of the transmitter prior to adding the filter to the measurement chain.  
 6. Owing to the highest peak level of unwanted emission out of the restricted bands complies with the lowest limit(54dBuV/m), so all the test point was deemed to comply with the limits list in the standard.





**VERTICAL RESULTS**  
**1-7GHz**

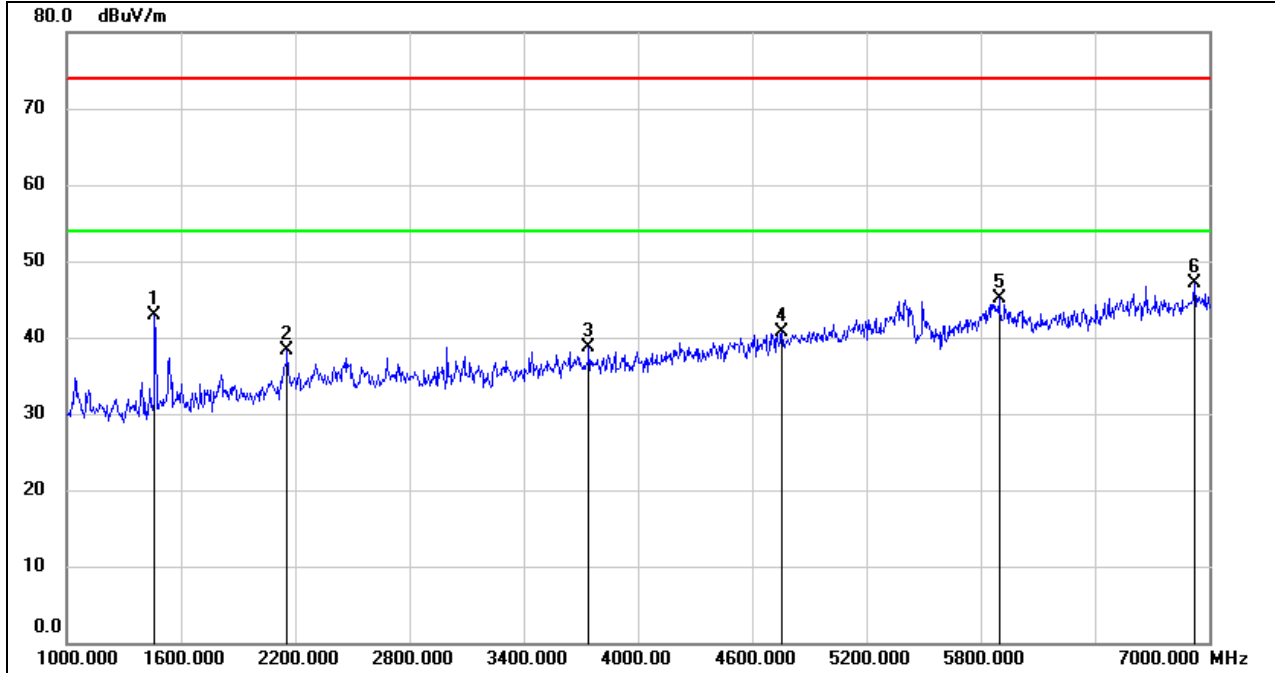

No.	Frequency (MHz)	Reading (dBuV)	Correct (dB/m)	Result (dBuV/m)	Limit (dBuV/m)	Margin (dB)	Remark
1	1462.000	55.79	-12.94	42.85	74.00	-31.15	peak
2	2158.000	48.08	-9.83	38.25	74.00	-35.75	peak
3	3742.000	42.97	-4.19	38.78	74.00	-35.22	peak
4	4756.000	41.24	-0.57	40.67	74.00	-33.33	peak
5	5896.000	40.81	4.25	45.06	74.00	-28.94	peak
6	6922.000	41.95	5.21	47.16	74.00	-26.84	peak

Note: 1. Measurement = Reading Level + Correct Factor.  
 2. If Peak Result complies with AV limit, AV Result is deemed to comply with AV limit.  
 3. Peak: Peak detector.  
 4. Filter losses were only considered in the spurious frequency bands and the authorized band was not corrected for Band reject filter losses.  
 5. Proper operation of the transmitter prior to adding the filter to the measurement chain.  
 6. Owing to the highest peak level of unwanted emission out of the restricted bands complies with the lowest limit(54dBuV/m), so all the test point was deemed to comply with the limits list in the standard.



**VERTICAL RESULTS**  
**7-18GHz**

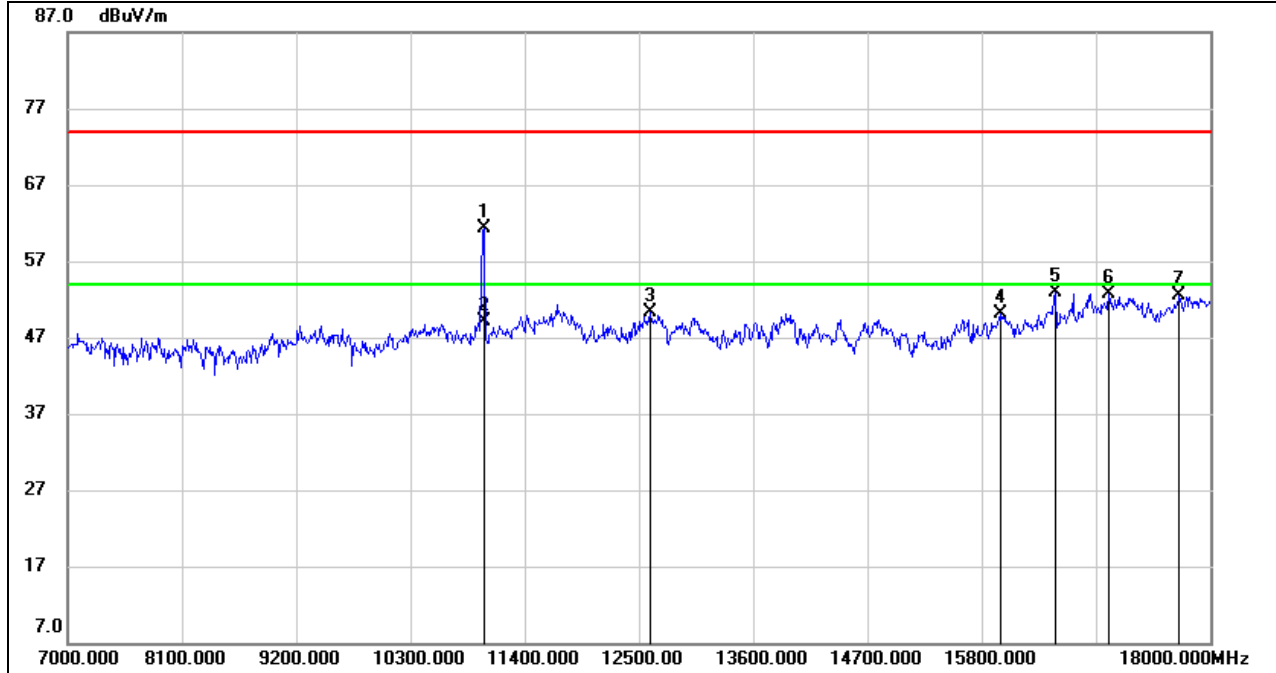

No.	Frequency (MHz)	Reading (dBuV)	Correct (dB/m)	Result (dBuV/m)	Limit (dBuV/m)	Margin (dB)	Remark
1	11000.000	48.66	12.63	61.29	74.00	-12.71	peak
2	11000.000	36.41	12.63	49.04	54.00	-4.96	AVG
3	12610.000	35.06	15.17	50.23	74.00	-23.77	peak
4	15987.000	32.47	17.68	50.15	74.00	-23.85	peak
5	16504.000	33.45	19.47	52.92	74.00	-21.08	peak
6	17021.000	32.09	20.60	52.69	74.00	-21.31	peak
7	17703.000	29.68	22.77	52.45	74.00	-21.55	peak

Note: 1. Measurement = Reading Level + Correct Factor.  
 2. If Peak Result complies with AV limit, AV Result is deemed to comply with AV limit.  
 3. Peak: Peak detector.  
 4. Filter losses were only considered in the spurious frequency bands and the authorized band was not corrected for HPF losses.  
 5. Proper operation of the transmitter prior to adding the filter to the measurement chain.  
 6. Owing to the highest peak level of unwanted emission out of the restricted bands complies with the lowest limit(54dBuV/m), so all the test point was deemed to comply with the limits list in the standard.



**HARMONICS AND SPURIOUS EMISSIONS MID CHANNEL**

**HORIZONTAL RESULTS**  
**1-7GHz**

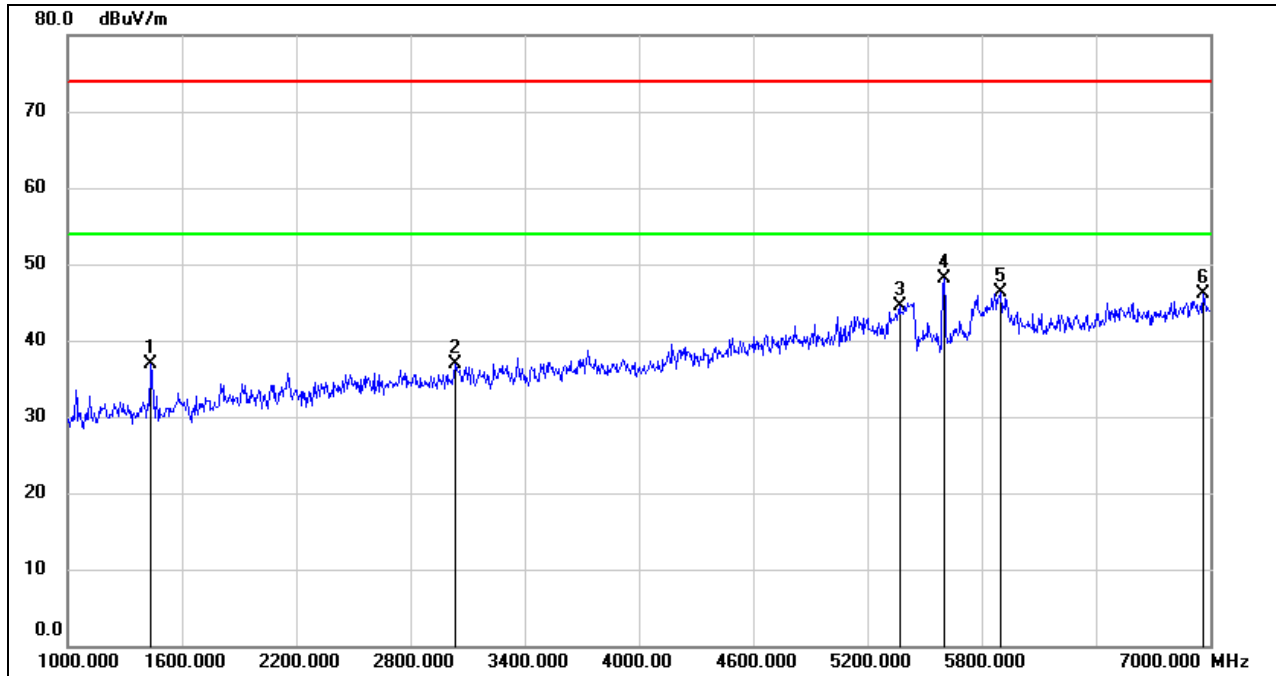

No.	Frequency (MHz)	Reading (dBuV)	Correct (dB/m)	Result (dBuV/m)	Limit (dBuV/m)	Margin (dB)	Remark
1	1438.000	49.98	-12.99	36.99	74.00	-37.01	peak
2	3034.000	42.96	-6.07	36.89	74.00	-37.11	peak
3	5368.000	43.34	1.14	44.48	74.00	-29.52	peak
4	5602.000	46.15	2.01	48.16	74.00	-25.84	peak
5	5896.000	42.00	4.25	46.25	74.00	-27.75	peak
6	6964.000	40.79	5.25	46.04	74.00	-27.96	peak

- Note: 1. Measurement = Reading Level + Correct Factor.  
 2. If Peak Result complies with AV limit, AV Result is deemed to comply with AV limit.  
 3. Peak: Peak detector.  
 4. Filter losses were only considered in the spurious frequency bands and the authorized band was not corrected for Band reject filter losses.  
 5. Proper operation of the transmitter prior to adding the filter to the measurement chain.  
 6. Owing to the highest peak level of unwanted emission out of the restricted bands complies with the lowest limit(54dBuV/m), so all the test point was deemed to comply with the limits list in the standard.



**HORIZONTAL RESULTS**  
**7-18GHz**

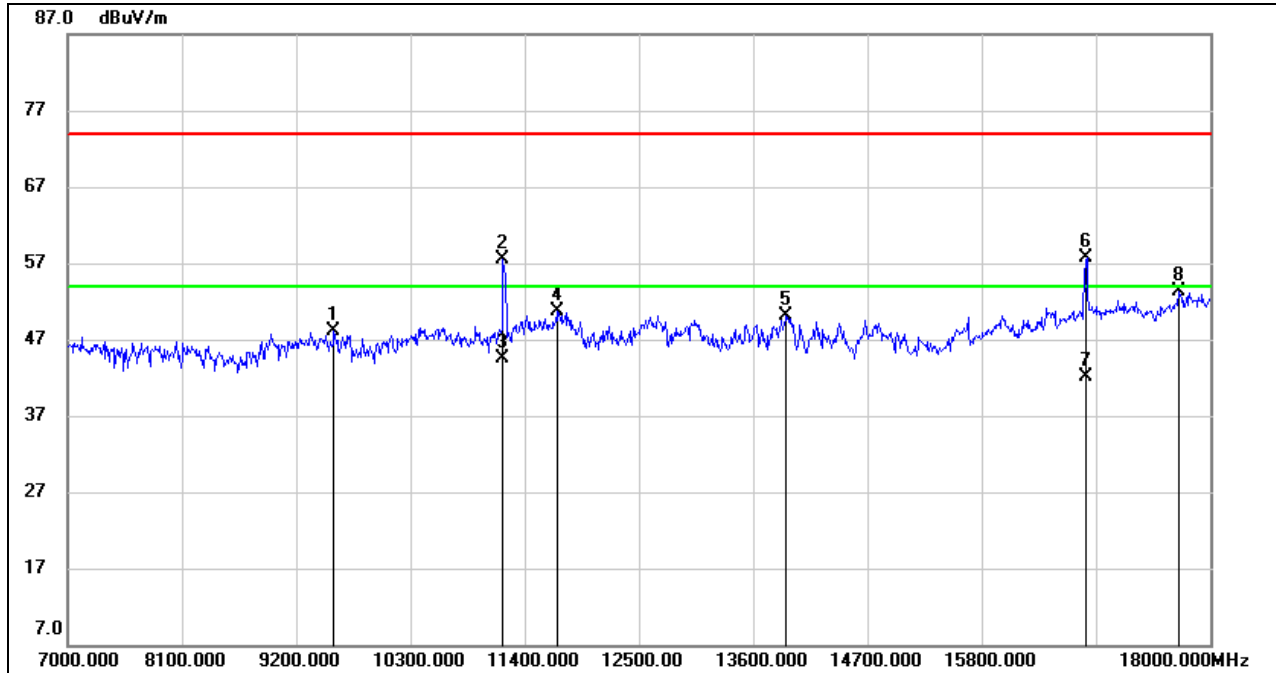

No.	Frequency (MHz)	Reading (dBuV)	Correct (dB/m)	Result (dBuV/m)	Limit (dBuV/m)	Margin (dB)	Remark
1	9563.000	37.69	10.46	48.15	74.00	-25.85	peak
2	11200.091	44.50	13.04	57.54	74.00	-16.46	peak
3	11200.091	31.56	13.04	44.60	54.00	-9.40	AVG
4	11708.000	36.59	14.16	50.75	74.00	-23.25	peak
5	13919.000	33.78	16.24	50.02	74.00	-23.98	peak
6	16800.000	37.50	20.12	57.62	74.00	-16.38	peak
7	16800.000	22.08	20.12	42.20	54.00	-11.80	AVG
8	17692.000	30.52	22.69	53.21	74.00	-20.79	peak

Note: 1. Measurement = Reading Level + Correct Factor.  
 2. If Peak Result complies with AV limit, AV Result is deemed to comply with AV limit.  
 3. Peak: Peak detector.  
 4. Filter losses were only considered in the spurious frequency bands and the authorized band was not corrected for HPF losses.  
 5. Proper operation of the transmitter prior to adding the filter to the measurement chain.  
 6. Owing to the highest peak level of unwanted emission out of the restricted bands complies with the lowest limit(54dBuV/m), so all the test point was deemed to comply with the limits list in the standard.



**VERTICAL RESULTS**  
**1-7GHz**

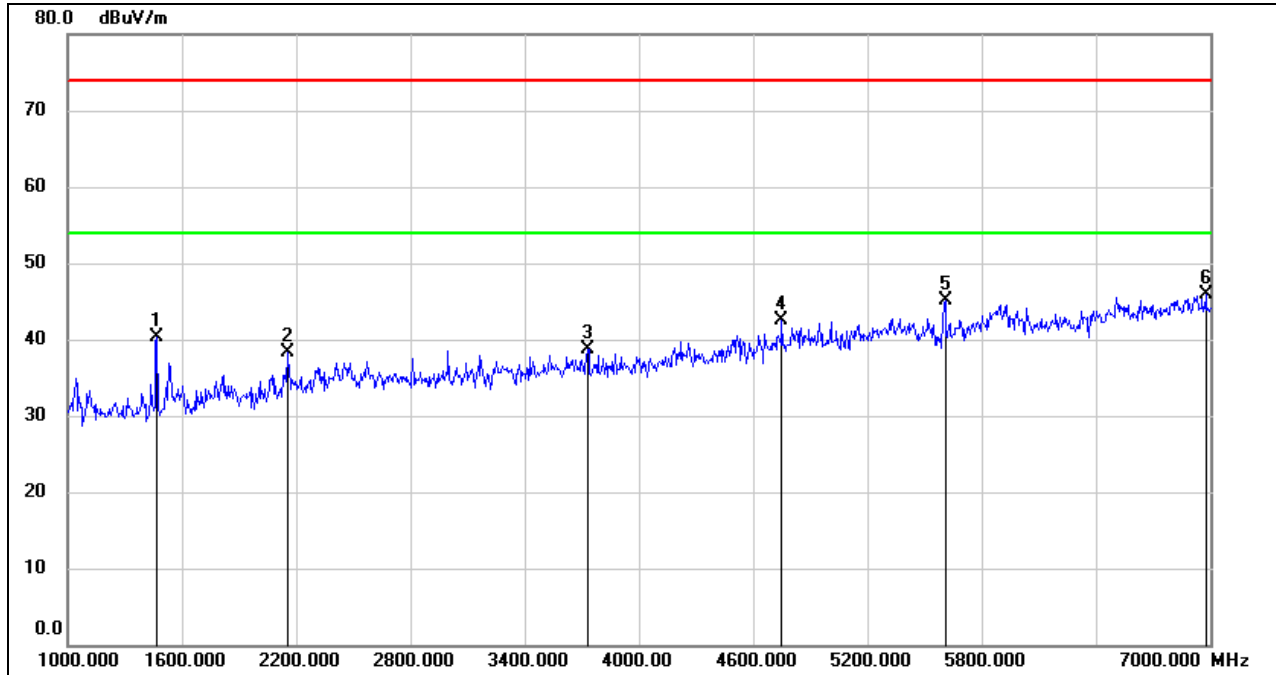

No.	Frequency (MHz)	Reading (dBuV)	Correct (dB/m)	Result (dBuV/m)	Limit (dBuV/m)	Margin (dB)	Remark
1	1468.000	53.24	-12.93	40.31	74.00	-33.69	peak
2	2152.000	48.15	-9.85	38.30	74.00	-35.70	peak
3	3730.000	42.95	-4.17	38.78	74.00	-35.22	peak
4	4750.000	43.09	-0.60	42.49	74.00	-31.51	peak
5	5608.000	43.13	2.01	45.14	74.00	-28.86	peak
6	6976.000	40.74	5.25	45.99	74.00	-28.01	peak

Note: 1. Measurement = Reading Level + Correct Factor.  
 2. If Peak Result complies with AV limit, AV Result is deemed to comply with AV limit.  
 3. Peak: Peak detector.  
 4. Filter losses were only considered in the spurious frequency bands and the authorized band was not corrected for Band reject filter losses.  
 5. Proper operation of the transmitter prior to adding the filter to the measurement chain.  
 6. Owing to the highest peak level of unwanted emission out of the restricted bands complies with the lowest limit(54dBuV/m), so all the test point was deemed to comply with the limits list in the standard.



**7-18GHz**

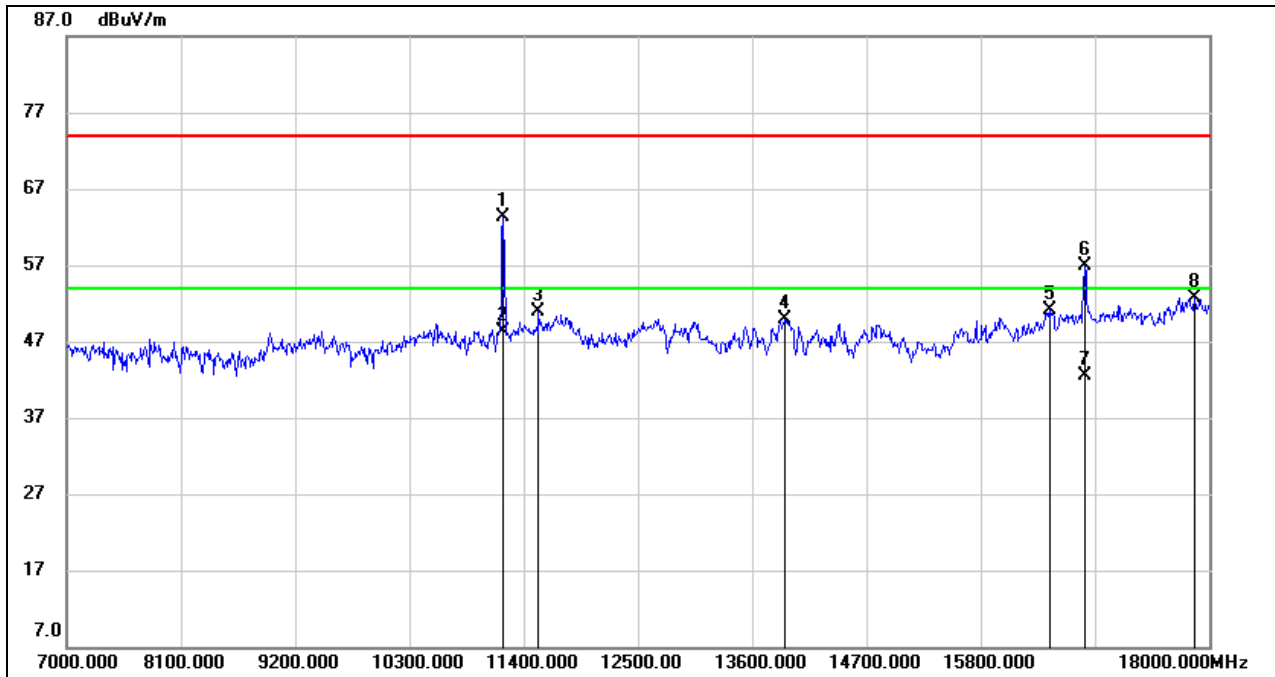

No.	Frequency (MHz)	Reading (dBuV)	Correct (dB/m)	Result (dBuV/m)	Limit (dBuV/m)	Margin (dB)	Remark
1	11200.000	50.31	13.04	63.35	74.00	-10.65	peak
2	11200.000	35.32	13.04	48.36	54.00	-5.64	AVG
3	11543.000	37.32	13.63	50.95	74.00	-23.05	peak
4	13919.000	33.74	16.24	49.98	74.00	-24.02	peak
5	16460.000	31.94	19.26	51.20	74.00	-22.80	peak
6	16800.000	36.72	20.12	56.84	74.00	-17.16	peak
7	16800.000	22.31	20.12	42.43	54.00	-11.57	AVG
8	17857.000	29.23	23.55	52.78	74.00	-21.22	peak

Note: 1. Measurement = Reading Level + Correct Factor.  
 2. If Peak Result complies with AV limit, AV Result is deemed to comply with AV limit.  
 3. Peak: Peak detector.  
 4. Filter losses were only considered in the spurious frequency bands and the authorized band was not corrected for HPF losses.  
 5. Proper operation of the transmitter prior to adding the filter to the measurement chain.  
 6. Owing to the highest peak level of unwanted emission out of the restricted bands complies with the lowest limit(54dBuV/m), so all the test point was deemed to comply with the limits list in the standard.



**HARMONICS AND SPURIOUS EMISSIONS HIGH CHANNEL**

**HORIZONTAL RESULTS**  
**1-7GHz**

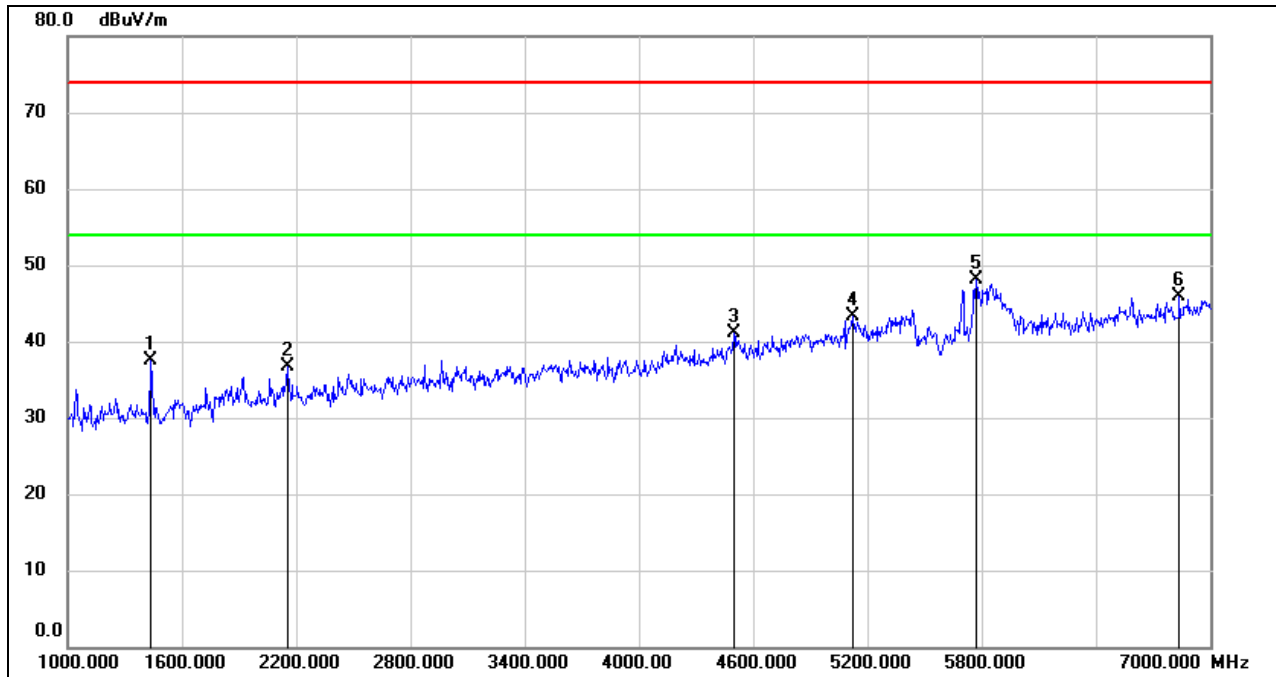

No.	Frequency (MHz)	Reading (dBuV)	Correct (dB/m)	Result (dBuV/m)	Limit (dBuV/m)	Margin (dB)	Remark
1	1438.000	50.59	-12.99	37.60	74.00	-36.40	peak
2	2152.000	46.47	-9.85	36.62	74.00	-37.38	peak
3	4498.000	42.84	-1.77	41.07	74.00	-32.93	peak
4	5122.000	42.38	0.90	43.28	74.00	-30.72	peak
5	5770.000	45.75	2.35	48.10	74.00	-25.90	peak
6	6838.000	41.19	4.79	45.98	74.00	-28.02	peak

Note: 1. Measurement = Reading Level + Correct Factor.  
 2. If Peak Result complies with AV limit, AV Result is deemed to comply with AV limit.  
 3. Peak: Peak detector.  
 4. Filter losses were only considered in the spurious frequency bands and the authorized band was not corrected for Band reject filter losses.  
 5. Proper operation of the transmitter prior to adding the filter to the measurement chain.  
 6. Owing to the highest peak level of unwanted emission out of the restricted bands complies with the lowest limit(54dBuV/m), so all the test point was deemed to comply with the limits list in the standard.



**HORIZONTAL RESULTS**  
**7-18GHz**

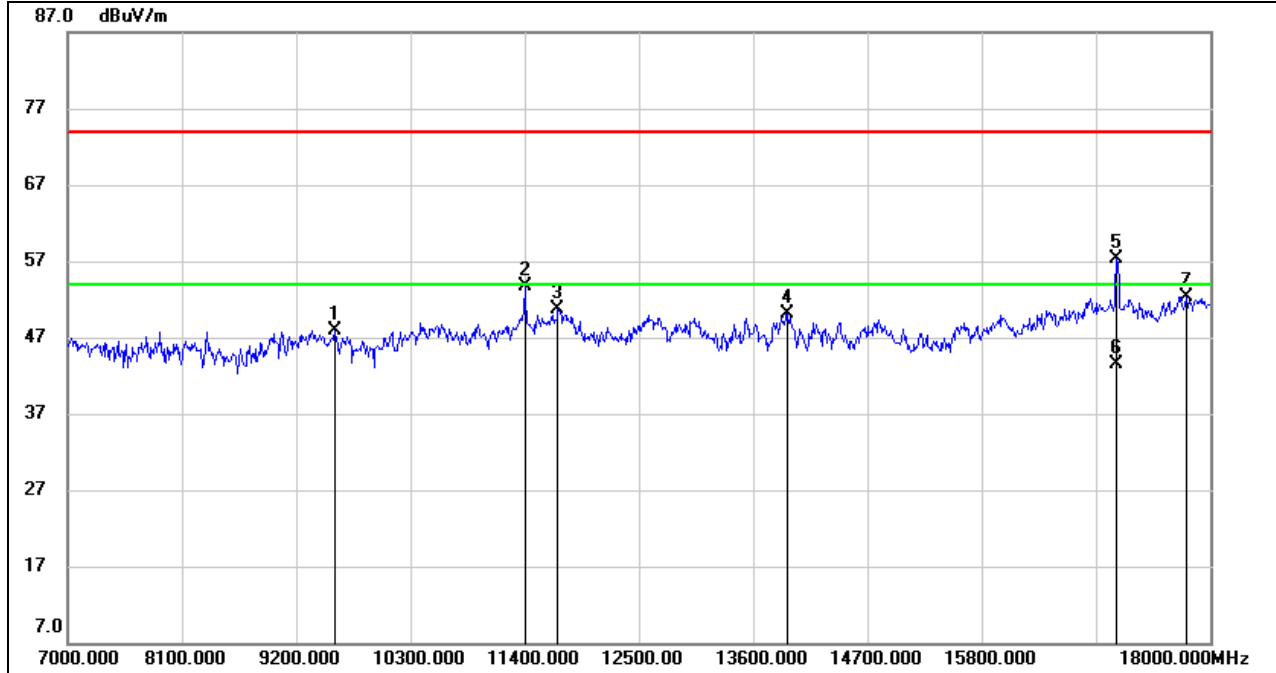

No.	Frequency (MHz)	Reading (dBuV)	Correct (dB/m)	Result (dBuV/m)	Limit (dBuV/m)	Margin (dB)	Remark
1	9574.000	37.43	10.49	47.92	74.00	-26.08	peak
2	11400.000	40.21	13.45	53.66	74.00	-20.34	peak
3	11719.000	36.42	14.21	50.63	74.00	-23.37	peak
4	13930.000	33.83	16.24	50.07	74.00	-23.93	peak
5	17100.448	36.16	21.08	57.24	74.00	-16.76	peak
6	17100.448	22.52	21.08	43.60	54.00	-10.40	AVG
7	17769.000	29.12	23.26	52.38	74.00	-21.62	peak

Note: 1. Measurement = Reading Level + Correct Factor.  
 2. If Peak Result complies with AV limit, AV Result is deemed to comply with AV limit.  
 3. Peak: Peak detector.  
 4. Filter losses were only considered in the spurious frequency bands and the authorized band was not corrected for HPF losses.  
 5. Proper operation of the transmitter prior to adding the filter to the measurement chain.  
 6. Owing to the highest peak level of unwanted emission out of the restricted bands complies with the lowest limit(54dBuV/m), so all the test point was deemed to comply with the limits list in the standard.





**VERTICAL RESULTS**  
**1-7GHz**

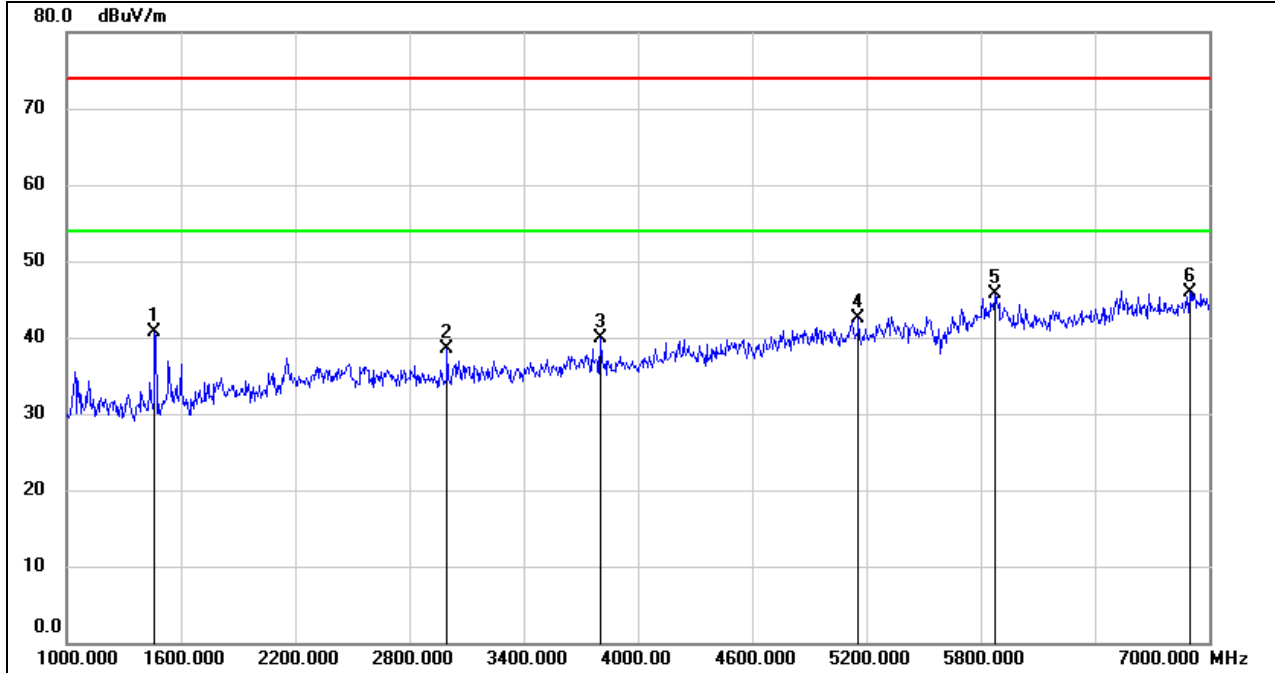

No.	Frequency (MHz)	Reading (dBuV)	Correct (dB/m)	Result (dBuV/m)	Limit (dBuV/m)	Margin (dB)	Remark
1	1462.000	53.71	-12.94	40.77	74.00	-33.23	peak
2	2998.000	44.78	-6.29	38.49	74.00	-35.51	peak
3	3802.000	44.25	-4.30	39.95	74.00	-34.05	peak
4	5158.000	41.32	1.12	42.44	74.00	-31.56	peak
5	5878.000	41.76	3.92	45.68	74.00	-28.32	peak
6	6898.000	40.75	5.18	45.93	74.00	-28.07	peak

Note: 1. Measurement = Reading Level + Correct Factor.  
 2. If Peak Result complies with AV limit, AV Result is deemed to comply with AV limit.  
 3. Peak: Peak detector.  
 4. Filter losses were only considered in the spurious frequency bands and the authorized band was not corrected for Band reject filter losses.  
 5. Proper operation of the transmitter prior to adding the filter to the measurement chain.  
 6. Owing to the highest peak level of unwanted emission out of the restricted bands complies with the lowest limit(54dBuV/m), so all the test point was deemed to comply with the limits list in the standard.



**7-18GHz**

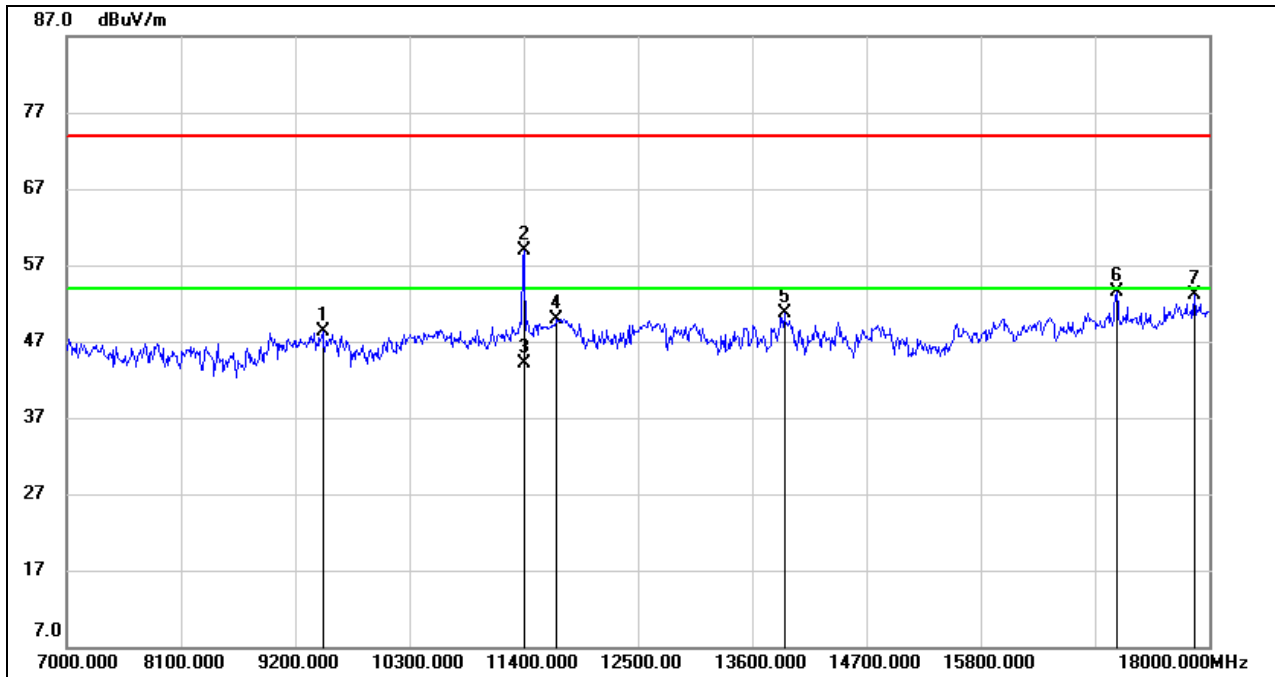

No.	Frequency (MHz)	Reading (dBuV)	Correct (dB/m)	Result (dBuV/m)	Limit (dBuV/m)	Margin (dB)	Remark
1	9464.000	38.05	10.21	48.26	74.00	-25.74	peak
2	11400.899	45.49	13.45	58.94	74.00	-15.06	peak
3	11400.899	30.68	13.45	44.13	54.00	-9.87	AVG
4	11719.000	35.74	14.21	49.95	74.00	-24.05	peak
5	13908.000	34.50	16.26	50.76	74.00	-23.24	peak
6	17109.000	32.34	21.13	53.47	74.00	-20.53	peak
7	17857.000	29.53	23.55	53.08	74.00	-20.92	peak

Note: 1. Measurement = Reading Level + Correct Factor.  
 2. If Peak Result complies with AV limit, AV Result is deemed to comply with AV limit.  
 3. Peak: Peak detector.  
 4. Filter losses were only considered in the spurious frequency bands and the authorized band was not corrected for HPF losses.  
 5. Proper operation of the transmitter prior to adding the filter to the measurement chain.  
 6. Owing to the highest peak level of unwanted emission out of the restricted bands complies with the lowest limit(54dBuV/m), so all the test point was deemed to comply with the limits list in the standard.



### 8.2.4. STRADDLE CHANNEL 144

#### HARMONICS AND SPURIOUS EMISSIONS HIGH CHANNEL

#### HORIZONTAL RESULTS 1-7GHz

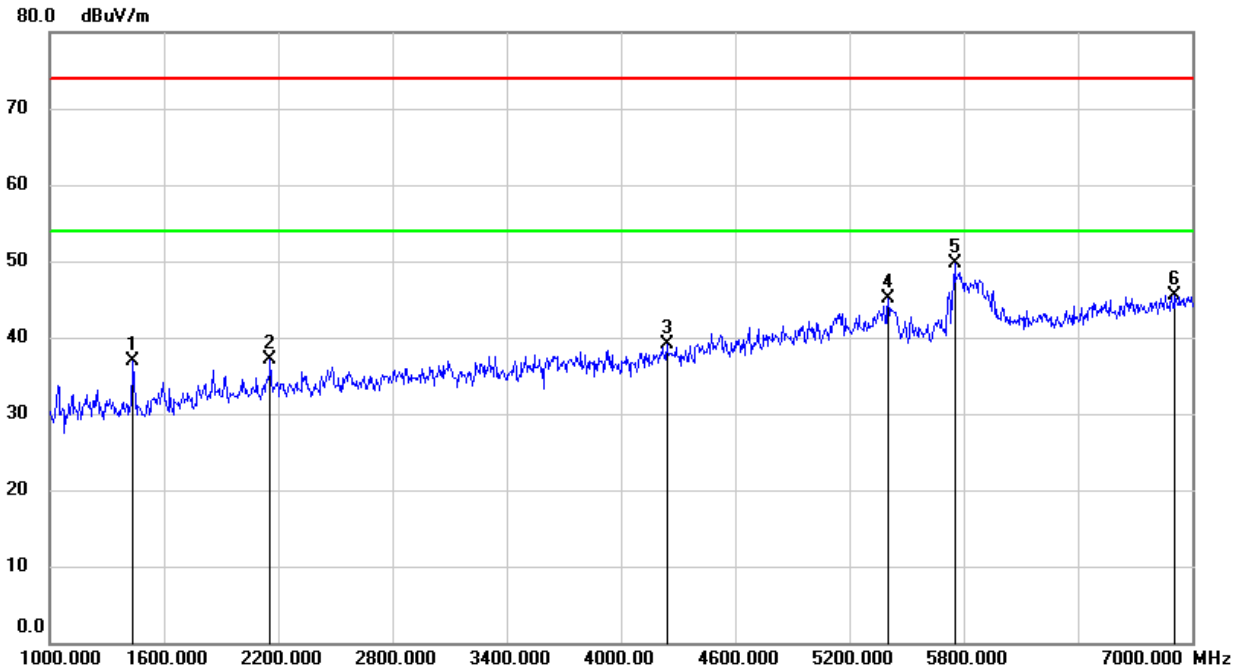

No.	Frequency (MHz)	Reading (dBuV)	Correct (dB/m)	Result (dBuV/m)	Limit (dBuV/m)	Margin (dB)	Remark
1	1438.000	49.84	-12.99	36.85	74.00	-37.15	peak
2	2158.000	46.88	-9.83	37.05	74.00	-36.95	peak
3	4240.000	42.02	-2.87	39.15	74.00	-34.85	peak
4	5404.000	43.97	1.10	45.07	74.00	-28.93	peak
5	5752.000	47.55	2.24	49.79	74.00	-24.21	peak
6	6910.000	40.24	5.20	45.44	74.00	-28.56	peak

Note: 1. Measurement = Reading Level + Correct Factor.  
 2. If Peak Result complies with AV limit, AV Result is deemed to comply with AV limit.  
 3. Peak: Peak detector.  
 4. Filter losses were only considered in the spurious frequency bands and the authorized band was not corrected for Band reject filter losses.  
 5. Proper operation of the transmitter prior to adding the filter to the measurement chain.  
 6. Owing to the highest peak level of unwanted emission out of the restricted bands complies with the lowest limit(54dBuV/m), so all the test point were deemed to comply with the limits list in the standard.



**HORIZONTAL RESULTS**  
**7-18GHz**

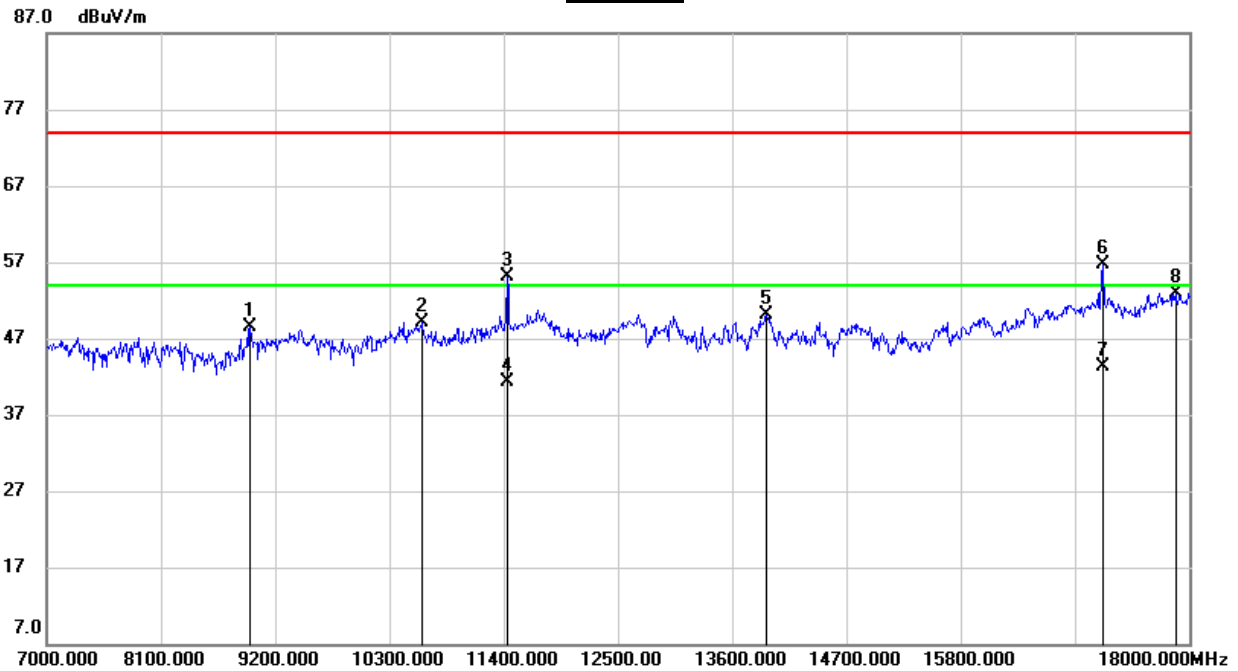

No.	Frequency (MHz)	Reading (dBuV)	Correct (dB/m)	Result (dBuV/m)	Limit (dBuV/m)	Margin (dB)	Remark
1	8958.000	38.76	9.76	48.52	74.00	-25.48	peak
2	10619.000	37.24	11.89	49.13	74.00	-24.87	peak
3	11440.000	41.56	13.50	55.06	74.00	-18.94	peak
4	11440.000	27.86	13.50	41.36	54.00	-12.64	AVG
5	13930.000	33.93	16.24	50.17	74.00	-23.83	peak
6	17160.000	35.17	21.44	56.61	74.00	-17.39	peak
7	17160.000	21.81	21.44	43.25	54.00	-10.75	AVG
8	17868.000	29.35	23.56	52.91	74.00	-21.09	peak

Note: 1. Measurement = Reading Level + Correct Factor.  
 2. If Peak Result complies with AV limit, AV Result is deemed to comply with AV limit.  
 3. Peak: Peak detector.  
 4. Filter losses were only considered in the spurious frequency bands and the authorized band was not corrected for HPF losses.  
 5. Proper operation of the transmitter prior to adding the filter to the measurement chain.  
 6. Owing to the highest peak level of unwanted emission out of the restricted bands complies with the lowest limit(54dBuV/m), so all the test point were deemed to comply with the limits list in the standard.



**VERTICAL RESULTS**  
**1-7GHz**

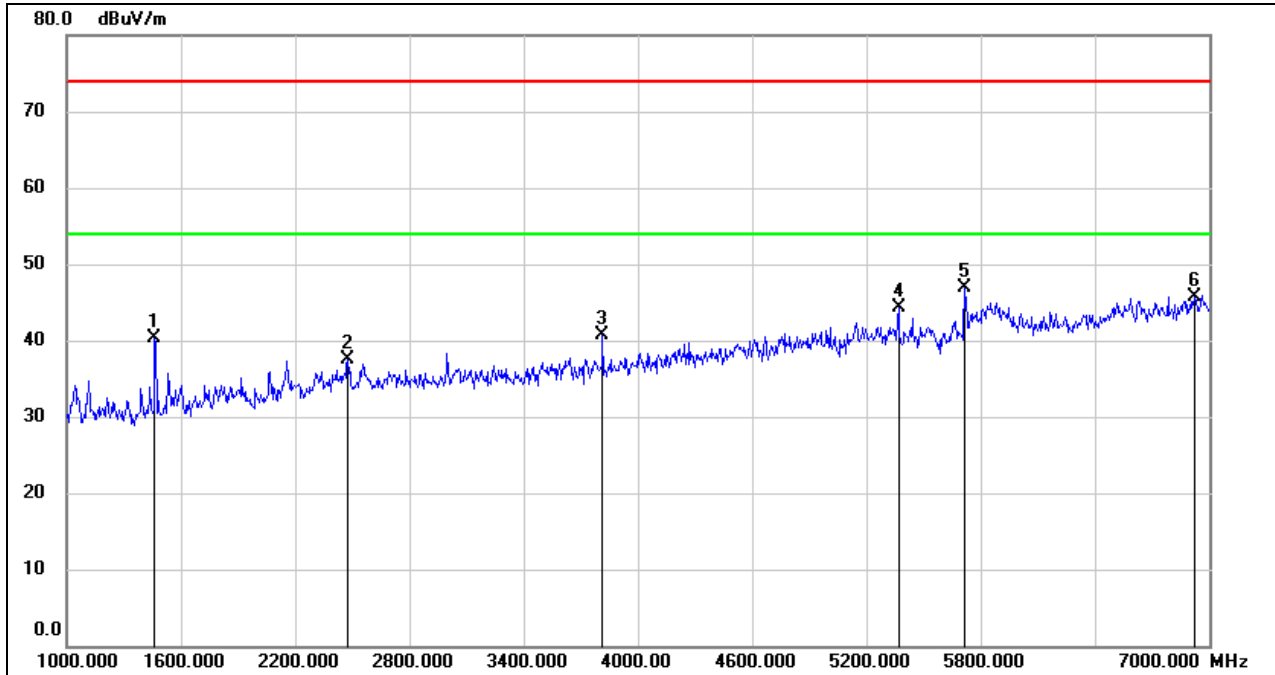

No.	Frequency (MHz)	Reading (dBuV)	Correct (dB/m)	Result (dBuV/m)	Limit (dBuV/m)	Margin (dB)	Remark
1	1462.000	53.16	-12.94	40.22	74.00	-33.78	peak
2	2476.000	45.73	-8.28	37.45	74.00	-36.55	peak
3	3814.000	45.08	-4.29	40.79	74.00	-33.21	peak
4	5368.000	43.25	1.14	44.39	74.00	-29.61	peak
5	5716.000	44.91	2.05	46.96	74.00	-27.04	peak
6	6922.000	40.52	5.21	45.73	74.00	-28.27	peak

Note: 1. Measurement = Reading Level + Correct Factor.  
 2. If Peak Result complies with AV limit, AV Result is deemed to comply with AV limit.  
 3. Peak: Peak detector.  
 4. Filter losses were only considered in the spurious frequency bands and the authorized band was not corrected for Band reject filter losses.  
 5. Proper operation of the transmitter prior to adding the filter to the measurement chain.  
 6. Owing to the highest peak level of unwanted emission out of the restricted bands complies with the lowest limit(54dBuV/m), so all the test point were deemed to comply with the limits list in the standard.



**7-18GHz**

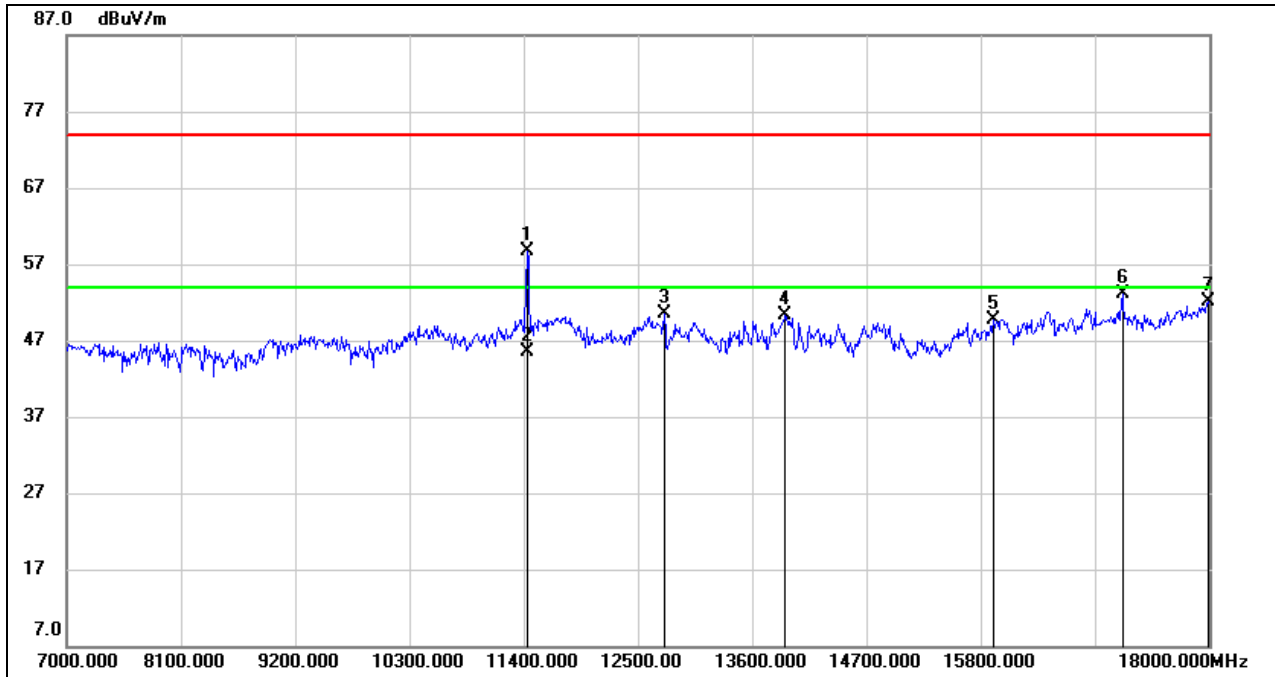

No.	Frequency (MHz)	Reading (dBuV)	Correct (dB/m)	Result (dBuV/m)	Limit (dBuV/m)	Margin (dB)	Remark
1	11440.073	45.13	13.50	58.63	74.00	-15.37	peak
2	11440.073	32.00	13.50	45.50	54.00	-8.50	AVG
3	12753.000	35.15	15.29	50.44	74.00	-23.56	peak
4	13919.000	34.14	16.24	50.38	74.00	-23.62	peak
5	15921.000	32.28	17.39	49.67	74.00	-24.33	peak
6	17164.000	31.71	21.47	53.18	74.00	-20.82	peak
7	17989.000	28.53	23.67	52.20	74.00	-21.80	peak

Note: 1. Measurement = Reading Level + Correct Factor.  
 2. If Peak Result complies with AV limit, AV Result is deemed to comply with AV limit.  
 3. Peak: Peak detector.  
 4. Filter losses were only considered in the spurious frequency bands and the authorized band was not corrected for HPF losses.  
 5. Proper operation of the transmitter prior to adding the filter to the measurement chain.  
 6. Owing to the highest peak level of unwanted emission out of the restricted bands complies with the lowest limit(54dBuV/m), so all the test point were deemed to comply with the limits list in the standard.