



**CFR 47 FCC PART 15 SUBPART E
ISED RSS-247 ISSUE 2**

CERTIFICATION TEST REPORT

For

**IEEE 802.11a/b/g/n/ac 2T2R USB Wi-Fi Module Integrated Bluetooth
2.1+EDR/4.2/5.1**

MODEL NUMBER: SKI.WB663U.2

FCC ID: 2AR82-SKIWB663U201

IC: 24728-SKIWB663U201

REPORT NUMBER: 4790010773.1-4

ISSUE DATE: July 28, 2021

Prepared for

**Guangzhou Shikun Electronics Co., Ltd
NO.6 Liankun Road, Huangpu District, Guangzhou 510530, China**

Prepared by

UL Verification Services (Guangzhou) Co., Ltd, Song Shan Lake Branch

Building 10, Innovation Technology Park, No. 1, Li Bin Road, Song Shan Lake Hi-Tech Development Zone Dongguan, 523808, People's Republic of China

Tel: +86 769 22038881

Fax: +86 769 33244054

Website: www.ul.com



Revision History

<u>Rev.</u>	<u>Issue Date</u>	<u>Revisions</u>	<u>Revised By</u>
V0	07/28/2021	Initial Issue	



Summary of Test Results			
Clause	Test Items	FCC/IC Rules	Test Results
1	6dB/26dB Bandwidth	FCC 15.407 (a)&(e) RSS-247 Clause 6.2	PASS
2	99% Occupied Bandwidth	RSS-Gen Clause 6.6	PASS
3	Conducted Output Power	FCC 15.407 (a) RSS-247 Clause 6.2	PASS
4	Power Spectral Density	FCC 15.407 (a) RSS-247 Clause 6.2	PASS
5	Radiated Bandedge and Spurious Emission	FCC 15.407 (b) FCC 15.209 FCC 15.205 RSS-247 Clause 6.2 RSS-GEN Clause 8.9	PASS
6	Conducted Emission Test for AC Power Port	FCC 15.207 RSS-GEN Clause 8.8	PASS
7	Frequency Stability	FCC 15.407 (g)	PASS
8	Dynamic Frequency Selection	FCC 15.407 (h) RSS-247 Clause 6.3	PASS
9	Antenna Requirement	FCC 15.203 RSS-GEN Clause 6.8	PASS
Note: 1. This test report is only published to and used by the applicant, and it is not for evidence purpose in China. 2. The measurement result for the sample received is <Pass> according to < CFR 47 FCC PART 15 SUBPART E >< ISED RSS-247 > when <Accuracy Method> decision rule is applied.			



TABLE OF CONTENTS

1. ATTESTATION OF TEST RESULTS	7
2. TEST METHODOLOGY	8
3. FACILITIES AND ACCREDITATION	8
4. CALIBRATION AND UNCERTAINTY	9
4.1. <i>MEASURING INSTRUMENT CALIBRATION</i>	<i>9</i>
4.2. <i>MEASUREMENT UNCERTAINTY.....</i>	<i>9</i>
5. EQUIPMENT UNDER TEST	10
5.1. <i>DESCRIPTION OF EUT</i>	<i>10</i>
5.2. <i>MAXIMUM OUTPUT POWER.....</i>	<i>11</i>
5.3. <i>CHANNEL LIST.....</i>	<i>12</i>
5.4. <i>DESCRIPTION OF AVAILABLE ANTENNAS</i>	<i>13</i>
5.5. <i>THE WORSE CASE POWER SETTING PARAMETER.....</i>	<i>14</i>
5.6. <i>DESCRIPTION OF TEST SETUP.....</i>	<i>17</i>
6. MEASURING INSTRUMENT AND SOFTWARE USED	18
7. ANTENNA PORT TEST RESULTS	20
7.1. <i>ON TIME AND DUTY CYCLE.....</i>	<i>20</i>
7.2. <i>6/26 dB EMISSION BANDWIDTH AND 99 % OCCUPIED BANDWIDTH</i>	<i>21</i>
7.3. <i>CONDUCTED OUTPUT POWER.....</i>	<i>23</i>
7.4. <i>POWER SPECTRAL DENSITY.....</i>	<i>26</i>
8. RADIATED TEST RESULTS.....	28
8.1. <i>RESTRICTED BANDEDGE.....</i>	<i>35</i>
8.1.1. <i>802.11a SISO MODE.....</i>	<i>35</i>
UNII-1 BAND	35
UNII-2A BAND	39
UNII-2C BAND.....	41
UNII-3 BAND	44
8.1.2. <i>802.11n HT20 MIMO MODE.....</i>	<i>46</i>
UNII-1 BAND	46
UNII-2A BAND	48
UNII-2C BAND.....	50
UNII-3 BAND	53
8.1.3. <i>802.11n HT40 MIMO MODE.....</i>	<i>55</i>
UNII-1 BAND	55
UNII-2A BAND	57
UNII-2C BAND.....	59
UNII-3 BAND	62
8.1.4. <i>802.11ac VHT80 MIMO MODE.....</i>	<i>64</i>



UNII-1 BAND	64
UNII-2A BAND	66
UNII-2C BAND	68
UNII-3 BAND	71
8.2. SPURIOUS EMISSIONS (1 GHz ~ 7 GHz).....	72
8.2.1. 802.11n HT20 MIMO MODE.....	72
UNII-1 BAND	72
UNII-2A BAND	78
UNII-2C BAND.....	84
STRADDLE CHANNEL 144.....	90
UNII-3 BAND	92
8.3. SPURIOUS EMISSIONS (7 GHz ~ 18 GHz).....	98
8.3.1. 802.11a SISO MODE.....	98
UNII-1 BAND	98
UNII-2A BAND	104
UNII-2C BAND.....	110
STRADDLE CHANNEL 144.....	116
UNII-3 BAND	118
8.3.2. 802.11n HT20 MIMO MODE.....	124
UNII-1 BAND	124
UNII-2A BAND	130
UNII-2C BAND.....	136
STRADDLE CHANNEL 144.....	142
UNII-3 BAND	144
8.3.3. 802.11n HT40 MIMO MODE.....	150
UNII-1 BAND	150
UNII-2A BAND	154
UNII-2C BAND.....	158
STRADDLE CHANNEL 142.....	164
UNII-3 BAND	166
8.3.4. 802.11ac VHT80 MIMO MODE.....	170
UNII-1 BAND	170
UNII-2A BAND	172
UNII-2C BAND.....	174
STRADDLE CHANNEL 138.....	178
UNII-3 BAND	180
8.4. SPURIOUS EMISSIONS (18 GHz ~ 26 GHz).....	182
8.4.1. 802.11ac VHT80 MODE	182
8.5. SPURIOUS EMISSIONS (26 GHz ~ 40 GHz).....	184
8.5.1. 802.11ac VHT80 MODE	184
8.6. SPURIOUS EMISSIONS (30 MHz ~ 1 GHz).....	186
8.6.1. 802.11ac VHT80 MODE	186
8.7. SPURIOUS EMISSIONS BELOW 30 MHz	188
8.7.1. 802.11ac VHT80 MODE	188
9. AC POWER LINE CONDUCTED EMISSIONS.....	191
9.1.1. 802.11ac VHT80 MODE	192
10. FREQUENCY STABILITY.....	194



11.	DYNAMIC FREQUENCY SELECTION	196
12.	ANTENNA REQUIREMENTS	200
12.1.	<i>Appendix A1: Emission Bandwidth</i>	<i>201</i>
12.1.1.	Test Result	201
12.1.2.	Test Graphs	204
12.2.	<i>Appendix A2: Occupied channel bandwidth.....</i>	<i>248</i>
12.2.1.	Test Result	248
12.2.2.	Test Graphs	251
12.3.	<i>Appendix A3: Min emission bandwidth</i>	<i>256</i>
12.3.1.	Test Result	256
12.3.2.	Test Graphs	257
12.4.	<i>Appendix B: Maximum conducted output power.....</i>	<i>271</i>
12.4.1.	Test Result	271
12.4.2.	Test Graphs	275
12.5.	<i>Appendix C: Maximum power spectral density</i>	<i>283</i>
12.5.1.	Test Result	283
12.5.2.	Test Graphs	287
12.6.	<i>Appendix D: Duty Cycle.....</i>	<i>335</i>
12.6.1.	Test Result	335
12.6.2.	Test Graphs	336
12.7.	<i>Appendix E: Frequency Stability.....</i>	<i>338</i>
	Test Result.....	338
12.8.	<i>Appendix F DYNAMIC FREQUENCY SELECTION.....</i>	<i>340</i>



1. ATTESTATION OF TEST RESULTS

Applicant Information

Company Name: Guangzhou Shikun Electronics Co., Ltd
Address: NO.6 Liankun Road, Huangpu District, Guangzhou
510530, China

Manufacturer Information

Company Name: Guangzhou Shikun Electronics Co., Ltd
Address: NO.6 Liankun Road, Huangpu District, Guangzhou
510530, China

EUT Information

EUT Name: IEEE 802.11a/b/g/n/ac 2T2R USB Wi-Fi Module
Integrated Bluetooth 2.1+EDR/4.2/5.1
Model: SKI.WB663U.2
Sample Received Date: July 4, 2021
Sample Status: Normal
Sample ID: 4043984
Date of Tested: July 5, 2021~ July 28, 2021

APPLICABLE STANDARDS	
STANDARD	TEST RESULTS
CFR 47 FCC PART 15 SUBPART E	PASS
ISED RSS-247 Issue 2	PASS
ISED RSS-GEN Issue 5	PASS

Prepared By:

Kebo Zhang
Project Engineer

Checked By:

Shawn Wen
Laboratory Leader

Approved By:

Stephen Guo
Laboratory Manager



2. TEST METHODOLOGY

The tests documented in this report were performed in accordance with ANSI C63.10-2013, CFR 47 FCC Part 2, CFR 47 FCC Part 15, KDB 789033 D02 v02r01, RSS-GEN Issue 5, RSS-247 Issue 2, KDB414788 D01 Radiated Test Site v01, KDB 662911 D01 Multiple Transmitter Output v02r01, KDB 905462 D02 UNII DFS Compliance Procedures New Rules v02, KDB 905462 D03 UNII clients without radar detection New Rules v01r02, KDB 905462 D04 Operational Modes for DFS Testing New Rules v01 and KDB 905462 D06 802 11 Channel Plans New Rules v02.

3. FACILITIES AND ACCREDITATION

Accreditation Certificate	<p>A2LA (Certificate No.: 4102.01) UL Verification Services (Guangzhou) Co., Ltd. Song Shan Lake Branch. has been assessed and proved to be in compliance with A2LA.</p> <p>FCC (FCC Designation No.: CN1187) UL Verification Services (Guangzhou) Co., Ltd. Song Shan Lake Branch. Has been recognized to perform compliance testing on equipment subject to the Commission's Declaration of Conformity (DoC) and Certification rules</p> <p>ISED (Company No.: 21320) UL Verification Services (Guangzhou) Co., Ltd. Song Shan Lake Branch. has been registered and fully described in a report filed with ISED. The Company Number is 21320 and the test lab Conformity Assessment Body Identifier (CABID) is CN0046.</p> <p>VCCI (Registration No.: G-20019, R-20004, C-20012 and T-20011) UL Verification Services (Guangzhou) Co., Ltd. Song Shan Lake Branch. has been assessed and proved to be in compliance with VCCI, the Membership No. is 3793. Facility Name: Chamber D, the VCCI registration No. is G-20019 and R-20004 Shielding Room B , the VCCI registration No. is C-20012 and T-20011</p>
---------------------------	---

Note 1: All tests measurement facilities use to collect the measurement data are located at Building 10, Innovation Technology Park, Song Shan Lake Hi tech Development Zone, Dongguan, 523808, China

Note 2: The test anechoic chamber in UL Verification Services (Guangzhou) Co., Ltd. Song Shan Lake Branch had been calibrated and compared to the open field sites and the test anechoic chamber is shown to be equivalent to or worst case from the open field site.

Note 3: For below 30 MHz, lab had performed measurements at test anechoic chamber and comparing to measurements obtained on an open field site. And these measurements below 30 MHz had been correlated to measurements performed on an OFS.



4. CALIBRATION AND UNCERTAINTY

4.1. MEASURING INSTRUMENT CALIBRATION

The measuring equipment utilized to perform the tests documented in this report has been calibrated in accordance with the manufacturer's recommendations and is traceable to recognize national standards.

4.2. MEASUREMENT UNCERTAINTY

Where relevant, the following measurement uncertainty levels have been estimated for tests performed on the apparatus:

Test Item	Uncertainty
Conduction emission	3.62 dB
Radiated Emission (Included Fundamental Emission) (9 kHz ~ 30 MHz)	2.2 dB
Radiated Emission (Included Fundamental Emission) (30 MHz ~ 1 GHz)	4.00 dB
Radiated Emission (Included Fundamental Emission) (1 GHz to 40 GHz)	5.78 dB (1 GHz-18 GHz)
	5.23dB (18 GHz-26 GHz)
	5.64 dB (26 GHz-40 GHz)
Note: This uncertainty represents an expanded uncertainty expressed at approximately the 95 % confidence level using a coverage factor of k=2.	



5. EQUIPMENT UNDER TEST

5.1. DESCRIPTION OF EUT

EUT Name	IEEE 802.11a/b/g/n/ac 2T2R USB Wi-Fi Module Integrated Bluetooth 2.1+EDR/4.2/5.1
Model	SKI.WB663U.2
Radio Technology	IEEE802.11a IEEE802.11n HT20/n HT40 IEEE802.11ac VHT20/VHT40/VHT80
Operation frequency	UNII-1/ UNII-2A/ UNII-2C/UNII-3
Modulation	OFDM(BPSK,QPSK,16QAM,64QAM,256QAM only in ac mode)
Power Supply	DC 3.3 V



5.2. MAXIMUM OUTPUT POWER

UNII-1 BAND(FCC&ISED)

IEEE Std. 802.11	Frequency (MHz)	Maximum Average Conducted Power (dBm)	Max Average EIRP (dBm)
a	5150 ~ 5250	10.85	12.30
n HT20		11.87	13.32
n HT40		13.06	14.51
ac VHT20		11.59	13.04
ac VHT40		13.03	14.48
ac VHT80		13.14	14.59

UNII-2A BAND(FCC&ISED)

IEEE Std. 802.11	Frequency (MHz)	Maximum Average Conducted Power (dBm)
a	5250 ~ 5350	10.61
n HT20		12.40
n HT40		12.85
ac VHT20		12.40
ac VHT40		12.76
ac VHT80		12.71

UNII-2C BAND(FCC&ISED)

IEEE Std. 802.11	Frequency (MHz)	Maximum Average Conducted Power (dBm)
a	5470 ~ 5725	11.45
n HT20		13.22
n HT40		13.12
ac VHT20		13.03
ac VHT40		13.17
ac VHT80		13.73

UNII-3 BAND(FCC&ISED)

IEEE Std. 802.11	Frequency (MHz)	Maximum Average Conducted Power (dBm)
a	5725 ~ 5850	10.32
n HT20		12.14
n HT40		12.54
ac VHT20		12.19
ac VHT40		12.42
ac VHT80		12.55

5.3. CHANNEL LIST

UNII-1 (For Bandwidth=20MHz)		UNII-1 (For Bandwidth=40MHz)		UNII-1 (For Bandwidth=80MHz)	
Channel	Frequency (MHz)	Channel	Frequency (MHz)	Channel	Frequency (MHz)
36	5180	38	5190	42	5210
40	5200	46	5230		
44	5220				
48	5240				

UNII-2A (For Bandwidth=20MHz)		UNII-2A (For Bandwidth=40MHz)		UNII-2A (For Bandwidth=80MHz)	
Channel	Frequency (MHz)	Channel	Frequency (MHz)	Channel	Frequency (MHz)
52	5260	54	5270	58	5290
56	5280	62	5310		
60	5300				
64	5320				

UNII-2C (For Bandwidth=20MHz)		UNII-2C (For Bandwidth=40MHz)		UNII-2C (For Bandwidth=80MHz)	
Channel	Frequency (MHz)	Channel	Frequency (MHz)	Channel	Frequency (MHz)
100	5500	102	5510	106	5530
104	5520	110	5550	122	5610
108	5540	118	5590	138	5690
112	5560	126	5630		
116	5580	134	5670		
120	5600	142	5710		
124	5620				
128	5640				
132	5660				
136	5680				
140	5700				
144	5720				

UNII-3		UNII-3		UNII-3	
Channel	Frequency (MHz)	Channel	Frequency (MHz)	Channel	Frequency (MHz)
149	5745	151	5755	155	5775
153	5765	159	5795		
157	5785				
161	5805				
165	5825				

5.4. DESCRIPTION OF AVAILABLE ANTENNAS

Antenna No.	Frequency Band	Antenna Type	Max Antenna Gain (dBi)
1	5150-5850	FPC	1.45
2	5150-5850	FPC	1.45

The EUT support Cyclic Shift Diversity(CDD) mode.

MIMO output power port and MIMO PSD port summing were performed in accordance with KDB 662911 D01. For the CDD results the Directional Gain was calculated in accordance with the following method.

For output power measurements:

Directional gain= $G_{ANT} + \text{Array Gain} = 1.45 \text{ dBi}$

G_{ANT} : equal to the gain of the antenna having the highest gain

Array Gain = 0 dB (i.e., no array gain) for $N_{ANT} \leq 4$

For power spectral density (PSD) measurements:

Directional gain= $G_{ANT} + \text{Array Gain} = 4.46 \text{ dBi}$

Array Gain = $10 \log(N_{ANT}/N_{SS}) \text{ dB}$.

N_{ANT} : number of transmit antennas

N_{SS} : number of spatial streams, The worst case directional gain will occur when $N_{SS} = 1$

IEE Std. 802.11	Transmit and Receive Mode	Description
802.11a	<input checked="" type="checkbox"/> 2TX, 2RX	ANT 1 and ANT 2 can be used as transmitting/receiving antenna.
802.11n HT20	<input checked="" type="checkbox"/> 2TX, 2RX	ANT 1 and ANT 2 can be used as transmitting/receiving antenna.
802.11n HT40	<input checked="" type="checkbox"/> 2TX, 2RX	ANT 1 and ANT 2 can be used as transmitting/receiving antenna.
802.11ac VHT20	<input checked="" type="checkbox"/> 2TX, 2RX	ANT 1 and ANT 2 can be used as transmitting/receiving antenna.
802.11ac VHT40	<input checked="" type="checkbox"/> 2TX, 2RX	ANT 1 and ANT 2 can be used as transmitting/receiving antenna.
802.11ac VHT80	<input checked="" type="checkbox"/> 2TX, 2RX	ANT 1 and ANT 2 can be used as transmitting/receiving antenna.
<p>Note: 1.BT&WLAN 2.4G, BT & WLAN 5G, WLAN 2.4G & WLAN 5G can't transmit simultaneously. (declared by client)</p>		

**5.5. THE WORSE CASE POWER SETTING PARAMETER**

The Worse Case Power Setting Parameter	
Test Software	QA tool

UNII-1

Mode	Rate	Channel	Soft set value	
			ANT 1	ANT 2
11a	6M	36	1A	1A
		40	1A	1A
		48	1A	1A
11n HT20	MCS0	36	18	18
		40	18	18
		48	18	18
11n HT40	MCS0	38	1A	1A
		46	1A	1A
11ac VHT20	MCS0	36	17	17
		40	17	17
		48	17	17
11ac VHT40	MCS0	38	1A	1A
		46	1A	1A
11ac VHT80	MCS0	42	1A	1A

UNII-2A

Mode	Rate	Channel	Soft set value	
			ANT 1	ANT 2
11a	6M	52	1A	1A
		56	1A	1A
		64	1A	1A
11n HT20	MCS0	52	1A	1A
		56	1A	1A
		64	1A	1A
11n HT40	MCS0	54	1A	1A
		62	1A	1A
11ac VHT20	MCS0	52	1A	1A
		56	1A	1A
		64	1A	1A
11ac VHT40	MCS0	54	1A	1A
		62	1A	1A
11ac VHT80	MCS0	58	1A	1A



UNII-2C

Mode	Rate	Channel	Soft set value	
			ANT 1	ANT 2
11a	6M	100	1A	1A
		116	1A	1A
		140	1A	1A
11n HT20	MCS0	100	1A	1A
		116	1A	1A
		140	1A	1A
11n HT40	MCS0	102	1A	1A
		118	1A	1A
		134	1A	1A
11ac VHT20	MCS0	100	1A	1A
		116	1A	1A
		140	1A	1A
11ac VHT40	MCS0	102	1A	1A
		118	1A	1A
11ac VHT80	MCS0	106	1A	1A
		122	1A	1A

UNII-3

Mode	Rate	Channel	Soft set value	
			ANT1	ANT 2
11a	6M	149	1A	1A
		157	1A	1A
		165	1A	1A
11n HT20	MCS0	149	1A	1A
		157	1A	1A
		165	1A	1A
11n HT40	MCS0	151	1A	1A
		159	1A	1A
11ac VHT20	MCS0	149	1A	1A
		157	1A	1A
		165	1A	1A
11ac VHT40	MCS0	151	1A	1A
		159	1A	1A
11ac VHT80	MCS0	155	1A	1A



THE WORSE CASE CONFIGURATIONS

The EUT was tested in the following configuration(s):

Controlled in test mode using a software application on the EUT supplied by customer. The application was used to enable a continuous transmission and to select the mode, test channels, bandwidth, data rates as required.

Test channels referring to section 5.4.

Maximum power setting referring to section 5.6.

Worst case Data Rates declared by the customer:

802.11a 20 mode: 6 Mbps
802.11n HT20 mode: MCS0
802.11n HT40 mode: MCS0
802.11ac VHT20 mode: MCS0
802.11ac VHT40 mode: MCS0
802.11ac VHT80 mode: MCS0

802.11ac VHT20 and VHT40 mode are different from 802.11nHT20 and HT40 only in control messages, so for these 4 modes, only 802.11n HT20 and 802.11n HT40 worst case power modes radiated emission test data are recorded in the report .

802.11ac&n SISO mode and MIMO mode have the same power setting, so only the worst case power mode(MIMO) will be record in the report.

The EUT has 2 separate antennas which correspond to 2 separate antenna ports. Core 1 and Core 2 correspond to antenna 1 and antenna 2 respectively.

Antenna 1 and Antenna 2 have the same power setting, and the power test data are the same. (Declared by customer.)

The measured additional path loss was included in any path loss calculations for all RF cable used during tested.

Conducted output power, power spectral density tests separately on each port with all supported SISO & MIMO port combinations.

Conducted bandedge and spurious emissions tests were performed with SISO mode, as this port was found to have the worst case in terms of power settings amongst all supported possible SISO & MIMO port combinations.

Radiated emissions tests were performed with the MIMO modes. These were found to be the worst modulation scheme with regards to emissions after preliminary investigations and, as this mode emits the highest conducted output power level, it was deemed to be the worst case.

The EUT support rotating antennas, we have done pre-tests under different angle combinations. so only the worst measurement position (X axis) was recorded in the report only the worst as shown in the setup photo

5.6. DESCRIPTION OF TEST SETUP

SUPPORT EQUIPMENT

Item	Equipment	Brand Name	Model Name	Remarks
1	Laptop	Dell	Vostro 3902	/
2	Laptop	ThinkPad	E480	/
3	Test fixture	/	/	/
4	Switching Adapter	FLYPOWER	PS65IBCAY5000H	Input: AC 100-240 V, 50/60 Hz, 1.5A Output: DC 12.0 V, 5000 mA

I/O CABLES

Cable No	Port	Connector Type	Cable Type	Cable Length(m)	Remarks
1	USB	USB	Unshielded	1.0	/

ACCESSORIES

Item	Accessory	Brand Name	Model Name	Description
1	/	/	/	/

TEST SETUP

The EUT can work in engineering mode with a software through a PC.

SETUP DIAGRAM FOR TESTS

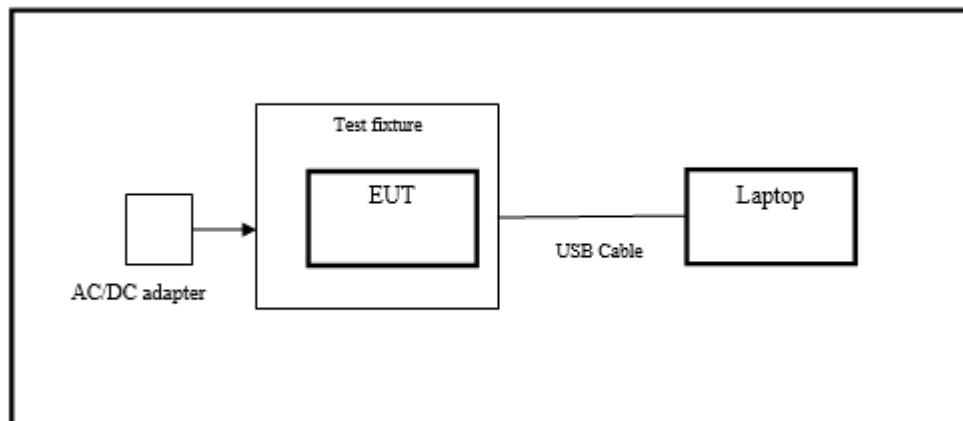

**6. MEASURING INSTRUMENT AND SOFTWARE USED**

Conducted Emissions					
Equipment	Manufacturer	Model No.	Serial No.	Last Cal.	Due Date
EMI Test Receiver	R&S	ESR3	101961	Nov. 12, 2020	Nov. 11, 2021
Two-Line V-Network	R&S	ENV216	101983	Nov. 12, 2020	Nov. 11, 2021
Software					
Description			Manufacturer	Name	Version
Test Software for Conducted Emissions			Farad	EZ-EMC	Ver. UL-3A1

Radiated Emissions					
Equipment	Manufacturer	Model No.	Serial No.	Last Cal.	Due Date
MXE EMI Receiver	KESIGHT	N9038A	MY56400036	Nov. 12, 2020	Nov. 11, 2021
Hybrid Log Periodic Antenna	TDK	HLP-3003C	130959	April 24, 2020	April 23, 2023
Preamplifier	HP	8447D	2944A09099	Nov. 12, 2020	Nov. 11, 2021
EMI Measurement Receiver	R&S	ESR26	101377	Nov. 12, 2020	Nov. 11, 2021
Horn Antenna	TDK	HRN-0118	130939	Sept. 17, 2018	Sept. 17, 2021
Preamplifier	TDK	PA-02-0118	TRS-305-00067	Nov. 20, 2020	Nov. 19, 2021
Horn Antenna	Schwarzbeck	BBHA9170	#697	July 20, 2021	July 19, 2024
Preamplifier	TDK	PA-02-2	TRS-307-00003	Nov. 12, 2020	Nov. 11, 2021
Preamplifier	TDK	PA-02-3	TRS-308-00002	Nov. 12, 2020	Nov. 11, 2021
Loop antenna	Schwarzbeck	1519B	00008	Jan.17, 2019	Jan.17,2022
Preamplifier	TDK	PA-02-001-3000	TRS-302-00050	Nov. 12, 2020	Nov. 11, 2021
Preamplifier	Mini-Circuits	ZX60-83LN-S+	SUP01201941	Nov. 20, 2020	Nov. 19, 2021
Highpass Filter	Wainwright	WHKX10-5850-6500-1800-40SS	4	Nov. 12, 2020	Nov. 11, 2021
Band Reject Filter	Wainwright	WRCJV12-5695-5725-5850-5880-40SS	4	Nov. 12, 2020	Nov. 11, 2021
Band Reject Filter	Wainwright	WRCJV20-5120-5150-5350-5380-60SS	2	Nov. 12, 2020	Nov. 11, 2021



Band Reject Filter	Wainwright	WRCJV20-5440-5470-5725-5755-60SS	1	Nov. 12, 2020	Nov. 11, 2021
Software					
Description		Manufacturer		Name	Version
Test Software for Radiated Emissions		Farad		EZ-EMC	Ver. UL-3A1

Tonsend RF Test System					
Equipment	Manufacturer	Model No.	Serial No.	Last Cal.	Due. Date
Wideband Radio Communication Tester	R&S	CMW500	155523	Nov.20,2020	Nov.19,2021
PXA Signal Analyzer	Keysight	N9030A	MY55410512	Nov.20,2020	Nov.19,2021
MXG Vector Signal Generator	Keysight	N5182B	MY56200284	Nov.20,2020	Nov.19,2021
MXG Vector Signal Generator	Keysight	N5172B	MY56200301	Nov.20,2020	Nov.19,2021
DC power supply	Keysight	E3642A	MY55159130	Nov.24,2020	Nov.23,2021
Temperature & Humidity Chamber	SANMOOD	SG-80-CC-2	2088	Nov.20,2020	Nov.19,2021
Software					
Description		Manufacturer		Name	Version
Tonsend SRD Test System		Tonsend		JS1120-3 RF Test System	2.6.77.0518

Other Instruments					
Equipment	Manufacturer	Model No.	Serial No.	Last Cal.	Next Cal.
Power sensor, Power Meter	R&S	OSP120	100921	Mar.13,2020	Mar.13,2021

7. ANTENNA PORT TEST RESULTS

7.1. ON TIME AND DUTY CYCLE

LIMITS

None; for reporting purposes only.

PROCEDURE

Refer to KDB 789033 D02 General U-NII Test Procedures New Rules v02r01 section II.B.

The zero-span mode on a spectrum analyzer or EMI receiver, if the response time and spacing between bins on the sweep are sufficient to permit accurate measurements of the on and off times of the transmitted signal. Set the center frequency of the instrument to the center frequency of the transmission. Set $RBW \geq EBW$ if possible; otherwise, set RBW to the largest available value. Set $VBW \geq RBW$. Set detector = peak or average. The zero-span measurement method shall not be used unless both RBW and VBW are $> 50/T$, where T is defined in II.B.1.a), and the number of sweep points across duration T exceeds 100. (For example, if VBW and/or RBW are limited to 3 MHz, then the zero-span method of measuring duty cycle shall not be used if $T \leq 16.7$ microseconds.)

TEST SETUP

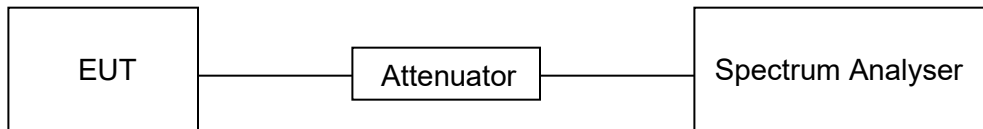

TEST ENVIRONMENT

Temperature	24.8 °C	Relative Humidity	61.3 %
Atmosphere Pressure	101 kPa	Test Voltage	DC 3.3 V

RESULTS

Please refer to appendix D.



7.2. 6/26 dB EMISSION BANDWIDTH AND 99 % OCCUPIED BANDWIDTH

LIMITS

CFR 47 FCC Part15, Subpart E ISED RSS-247 ISSUE 2		
Test Item	Limit	Frequency Range (MHz)
26 dB Emission Bandwidth	For reporting purposes only.	5150 ~ 5250
26 dB Emission Bandwidth	For reporting purposes only.	5250 ~ 5350
26 dB Emission Bandwidth	For reporting purposes only.	5470 ~ 5725 (For FCC) 5470 ~ 5600 (For ISED) 5650 ~ 5725 (For ISED)
6 dB Emission Bandwidth	The minimum 6 dB emission bandwidth shall be 500 kHz.	5725 ~ 5850
99 % Occupied Bandwidth	For reporting purposes only.	5150 ~ 5825 (For ISED)

TEST PROCEDURE

Refer to KDB 789033 D02 General U-NII Test Procedures New Rules v02r01 section II.C1. for 26 dB Emission Bandwidth; section II.C2. for 6 dB Emission Bandwidth; section II.D. for 99 % Occupied Bandwidth.

Connect the EUT to the spectrum analyser and use the following settings:

Center Frequency	The center frequency of the channel under test
Detector	Peak
RBW	For 6 dB Emission Bandwidth: RBW=100 kHz For 26 dB Emission bandwidth: approximately 1 % of the EBW. For 99 % Occupied Bandwidth: approximately 1 % ~ 5 % of the OBW.
VBW	For 6 dB Bandwidth: $\geq 3 \times \text{RBW}$ For 26 dB Bandwidth: $> 3 \times \text{RBW}$ For 99 % Bandwidth: $> 3 \times \text{RBW}$
Trace	Max hold
Sweep	Auto couple

- Use the 99 % power bandwidth function of the instrument, allow the trace to stabilize and report the measured bandwidth.
- Allow the trace to stabilize and measure the maximum width of the emission that is constrained by the frequencies associated with the two outermost amplitude points (upper and lower frequencies) that are attenuated by 6/26 dB relative to the maximum level measured in the fundamental emission.

Calculation for 99 % Bandwidth of UNII-2C and UNII-3 Straddle Channel:

For Example: Fundamental Frequency: 5720 MHz

99 % OBW: 21.00 MHz

Turning Frequency: 5725 MHz

99 % Bandwidth of UNII-2C Band Portion = $(5725-(5720-(21.00/2))) = 15.50$ MHz

99 % Bandwidth of UNII-3 Band Portion = $(5720+(21.00/2)-5725) = 5.50$ MHz

Calculation for 26 dB Bandwidth of UNII-2C Straddle Channel:

For Example: Fundamental frequency: 5720 MHz

26 dB BW: 20.00 MHz

FL: 5710.16 MHz

FH: 5730.16 MHz

Turning Frequency: 5725 MHz

26 dB Bandwidth of UNII-2C Band Portion = $5725-5710.16=14.84$ MHz

Calculation for 6dB Bandwidth of UNII-3 Straddle Channel:

For Example: Fundamental frequency: 5720 MHz

6 dB BW: 16.44 MHz

FL: 5711.76 MHz

FH: 5728.2 MHz

Turning Frequency: 5725 MHz

6 dB Bandwidth of UNII-3 band Portion = $5728.2-5725=3.2$ MHz

TEST SETUP

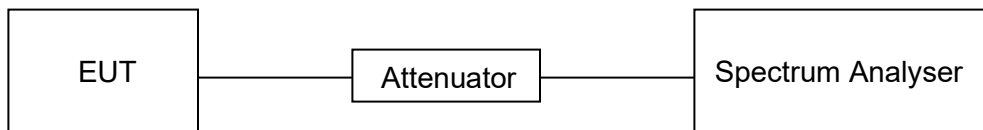

TEST ENVIRONMENT

Temperature	24.8 °C	Relative Humidity	61.3 %
Atmosphere Pressure	101 kPa	Test Voltage	DC 3.3 V

RESULTS

Please refer to Appendix A1&A2&A3.



7.3. CONDUCTED OUTPUT POWER

LIMITS

CFR 47 FCC Part15, Subpart E		
Test Item	Limit	Frequency Range (MHz)
Conducted Output Power	<input type="checkbox"/> Outdoor Access Point: 1 W (30 dBm) <input type="checkbox"/> Indoor Access Point: 1 W (30 dBm) <input type="checkbox"/> Fixed Point-To-Point Access Points: 1 W (30 dBm) <input checked="" type="checkbox"/> Client Devices: 250 mW (24 dBm)	5150 ~ 5250
	Shall not exceed the lesser of 250 mW (24dBm) or 11 dBm + 10 log B, where B is the 26 dB emission bandwidth in megahertz.	5250 ~ 5350 5470 ~ 5725
	Shall not exceed 1 Watt (30 dBm).	5725 ~ 5850

ISED RSS-247 ISSUE 2		
Test Item	Limit	Frequency Range (MHz)
Conducted Output Power or e.i.r.p.	The maximum e.i.r.p. shall not exceed 200 mW (23 dBm) or 10 + 10 log ₁₀ B, dBm, whichever power is less. B is the 99 % emission bandwidth in megahertz.	5150 ~ 5250
	a. The maximum conducted output power shall not exceed 250 mW (24 dBm) or 11 + 10 log ₁₀ B dBm, whichever is less. b. The maximum e.i.r.p. shall not exceed 1.0 W (30 dBm) or 17 + 10 log ₁₀ B dBm, whichever is less. B is the 99 % emission bandwidth in megahertz. Note that devices with a maximum e.i.r.p. greater than 500 mW shall implement TPC in order to have the capability to operate at least 6 dB below the maximum permitted e.i.r.p. of 1 W.	5250 ~ 5350 5470 ~ 5600 5650 ~ 5725
	Shall not exceed 1 Watt (30 dBm). The e.i.r.p. shall not exceed 4 W	5725 ~ 5850

Note:

The above limits are based upon the maximum antenna gain does not exceed 6 dBi. If transmitting antennas of directional gain greater than 6 dBi are used, the maximum conducted output power shall be reduced by the amount in dB that the directional gain of the antenna exceeds 6 dBi.

TEST PROCEDURE

Refer to KDB 789033 D02 General U-NII Test Procedures New Rules v02r01 section II.E.

Method SA-1 (trace averaging with the EUT transmitting at full power throughout each sweep):

- (i) Set span to encompass the entire emission bandwidth (EBW) (or, alternatively, the entire 99% occupied bandwidth) of the signal.
- (ii) Set RBW = 1 MHz.
- (iii) Set VBW \geq 3 MHz.
- (iv) Number of points in sweep $\geq 2 \times$ span / RBW. (This ensures that bin-to-bin spacing is \leq RBW/2, so that narrowband signals are not lost between frequency bins.)
- (v) Sweep time = auto.
- (vi) Detector = power averaging (rms), if available. Otherwise, use sample detector mode.
- (vii) If transmit duty cycle $<$ 98 %, use a video trigger with the trigger level set to enable triggering only on full power pulses. Transmitter must operate at maximum power control level for the entire duration of every sweep. If the EUT transmits continuously (i.e., with no off intervals) or at duty cycle \geq 98 %, and if each transmission is entirely at the maximum power control level, then the trigger shall be set to "free run."
- (viii) Trace average at least 100 traces in power averaging (rms) mode.
- (ix) Compute power by integrating the spectrum across the EBW (or, alternatively, the entire 99% occupied bandwidth) of the signal using the instrument's band power measurement function with band limits set equal to the EBW (or occupied bandwidth) band edges. If the instrument does not have a band power function, sum the spectrum levels (in power units) at 1 MHz intervals extending across the EBW (or, alternatively, the entire 99% occupied bandwidth) of the spectrum.

Method PM (Measurement using an RF average power meter):

- (i) Measurements may be performed using a wideband RF power meter with a thermocouple detector or equivalent if all of the following conditions are satisfied:
 - a. The EUT is configured to transmit continuously or to transmit with a constant duty cycle.
 - b. At all times when the EUT is transmitting, it must be transmitting at its maximum power control level.
 - c. The integration period of the power meter exceeds the repetition period of the transmitted signal by at least a factor of five.
- (ii) If the transmitter does not transmit continuously, measure the duty cycle, x , of the transmitter output signal as described in II.B.
- (iii) Measure the average power of the transmitter. This measurement is an average over both the on and off periods of the transmitter.
- (iv) Adjust the measurement in dBm by adding $10 \log (1/x)$ where x is the duty cycle (e.g., $10 \log (1/0.25)$ if the duty cycle is 25 %).

Method PM-G (Measurement using a gated RF average power meter):

Measurements may be performed using a wideband gated RF power meter provided that the gate parameters are adjusted such that the power is measured only when the EUT is transmitting at its maximum power control level. Since the measurement is made only during the ON time of the transmitter, no duty cycle correction factor is required.

Straddle channel power was measured using spectrum analyzer.



TEST SETUP

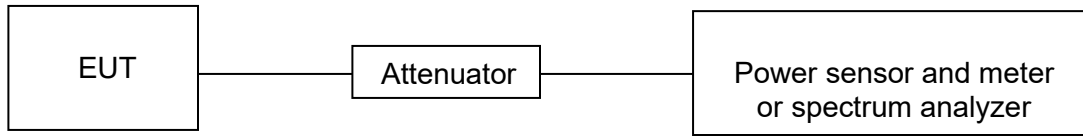

TEST ENVIRONMENT

Temperature	24.8 °C	Relative Humidity	61.3 %
Atmosphere Pressure	101 kPa	Test Voltage	DC 3.3 V

RESULTS

Please refer to Appendix B.



7.4. POWER SPECTRAL DENSITY

LIMITS

CFR 47 FCC Part15, Subpart E		
Test Item	Limit	Frequency Range (MHz)
Power Spectral Density	<input type="checkbox"/> Outdoor Access Point: 17 dBm/MHz <input type="checkbox"/> Indoor Access Point: 17 dBm/MHz <input type="checkbox"/> Fixed Point-To-Point Access Points: 17 dBm/MHz <input checked="" type="checkbox"/> Client Devices: 11 dBm/MHz	5150 ~ 5250
	11 dBm/MHz	5250 ~ 5350 5470 ~ 5725
	30 dBm/500kHz	5725 ~ 5850

ISED RSS-247 ISSUE 2		
Test Item	Limit	Frequency Range (MHz)
Power Spectral Density	The e.i.r.p. spectral density shall not exceed 10 dBm in any 1.0 MHz band.	5150 ~ 5250
	The power spectral density shall not exceed 11 dBm in any 1.0 MHz band.	5250 ~ 5350 5470 ~ 5600 5650 ~ 5725
	30 dBm / 500 kHz	5725 ~ 5850

Note:

The above limits are based upon the maximum antenna gain does not exceed 6 dBi. If transmitting antennas of directional gain greater than 6 dBi are used, maximum power spectral density shall be reduced by the amount in dB that the directional gain of the antenna exceeds 6 dBi.

TEST PROCEDURE

Refer to KDB 789033 D02 General U-NII Test Procedures New Rules v02r01 section II.F.

Connect the EUT to the spectrum analyser and use the following settings:

For U-NII-1, U-NII-2A and U-NII-2C band:

Center Frequency	The center frequency of the channel under test
Detector	RMS
RBW	1 MHz
VBW	$\geq 3 \times \text{RBW}$
Span	Encompass the entire emissions bandwidth (EBW) of the signal
Trace	Max hold
Sweep time	Auto

For U-NII-3:

Center Frequency	The center frequency of the channel under test
Detector	RMS
RBW	500 kHz
VBW	$\geq 3 \times \text{RBW}$
Span	Encompass the entire emissions bandwidth (EBW) of the signal
Trace	Max hold
Sweep time	Auto

Allow trace to fully stabilize and Use the peak search function on the instrument to find the peak of the spectrum and record its value.

Add $10 \log(1/x)$, where x is the duty cycle, to the peak of the spectrum, the result is the Maximum PSD over 1 MHz / 500 kHz reference bandwidth.

TEST SETUP

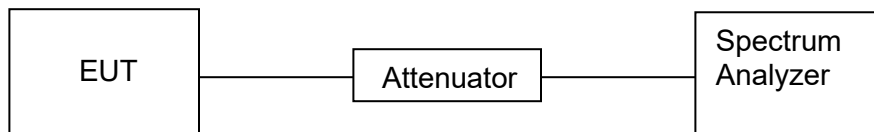

TEST ENVIRONMENT

Temperature	24.8 °C	Relative Humidity	61.3 %
Atmosphere Pressure	101 kPa	Test Voltage	DC 3.3 V

RESULTS

Please refer to Appendix C.

8. RADIATED TEST RESULTS

LIMITS

Refer to CFR 47 FCC §15.205, §15.209 and §15.407 (b).

Refer to ISED RSS-GEN Clause 8.9, Clause 8.10 and ISED RSS-247 6.2.

Radiation Disturbance Test Limit for FCC (Class B) (9 kHz ~ 1 GHz)

Emissions radiated outside of the specified frequency bands above 30 MHz			
Frequency Range (MHz)	Field Strength Limit (uV/m) at 3 m	Field Strength Limit (dBuV/m) at 3 m	
		Quasi-Peak	
30 - 88	100	40	
88 - 216	150	43.5	
216 - 960	200	46	
Above 960	500	54	
Above 1000	500	Peak	Average
		74	54

FCC Emissions radiated outside of the specified frequency bands below 30 MHz		
Frequency (MHz)	Field strength (microvolts/meter)	Measurement distance (meters)
0.009-0.490	2400/F(kHz)	300
0.490-1.705	24000/F(kHz)	30
1.705-30.0	30	30

ISED General field strength limits at frequencies below 30 MHz

Table 6 – General field strength limits at frequencies below 30 MHz		
Frequency	Magnetic field strength (H-Field) (µA/m)	Measurement distance (m)
9 - 490 kHz ^{Note 1}	6.37/F (F in kHz)	300
490 - 1705 kHz	63.7/F (F in kHz)	30
1.705 - 30 MHz	0.08	30

Note 1: The emission limits for the ranges 9-90 kHz and 110-490 kHz are based on measurements employing a linear average detector.



ISED Restricted bands refer to ISED RSS-GEN Clause 8.10

Table 7 – Restricted frequency bands ^{Note 1}		
MHz	MHz	GHz
0.090 - 0.110	149.9 - 150.05	9.0 - 9.2
0.495 - 0.505	156.52475 - 156.52525	9.3 - 9.5
2.1735 - 2.1905	156.7 - 156.9	10.6 - 12.7
3.020 - 3.026	162.0125 - 167.17	13.25 - 13.4
4.125 - 4.128	167.72 - 173.2	14.47 - 14.5
4.17725 - 4.17775	240 - 285	15.35 - 16.2
4.20725 - 4.20775	322 - 335.4	17.7 - 21.4
5.677 - 5.683	399.9 - 410	22.01 - 23.12
6.215 - 6.218	608 - 614	23.6 - 24.0
6.26775 - 6.26825	900 - 1427	31.2 - 31.8
6.31175 - 6.31225	1435 - 1626.5	36.43 - 36.5
8.291 - 8.294	1645.5 - 1646.5	Above 38.6
8.362 - 8.366	1660 - 1710	
8.37625 - 8.38675	1718.8 - 1722.2	
8.41425 - 8.41475	2200 - 2300	
12.29 - 12.293	2310 - 2390	
12.51975 - 12.52025	2483.5 - 2500	
12.57675 - 12.57725	2655 - 2900	
13.36 - 13.41	3260 - 3267	
16.42 - 16.423	3332 - 3339	
16.69475 - 16.69525	3345.8 - 3358	
16.80425 - 16.80475	3500 - 4400	
25.5 - 25.67	4500 - 5150	
37.5 - 38.25	5350 - 5460	
73 - 74.6	7250 - 7750	
74.8 - 75.2	8025 - 8500	
108 - 138		

Note 1: Certain frequency bands listed in table 7 and in bands above 38.6 GHz are designated for licence-exempt applications. These frequency bands and the requirements that apply to related devices are set out in the 200 and 300 series of RSSs.

FCC Restricted bands of operation refer to FCC §15.205 (a):

MHz	MHz	MHz	GHz
0.090-0.110	16.42-16.423	399.9-410	4.5-5.15
¹ 0.495-0.505	16.69475-16.69525	608-614	5.35-5.46
2.1735-2.1905	16.80425-16.80475	960-1240	7.25-7.75
4.125-4.128	25.5-25.67	1300-1427	8.025-8.5
4.17725-4.17775	37.5-38.25	1435-1626.5	9.0-9.2
4.20725-4.20775	73-74.6	1645.5-1646.5	9.3-9.5
6.215-6.218	74.8-75.2	1660-1710	10.6-12.7
6.26775-6.26825	108-121.94	1718.8-1722.2	13.25-13.4
6.31175-6.31225	123-138	2200-2300	14.47-14.5
8.291-8.294	149.9-150.05	2310-2390	15.35-16.2
8.362-8.366	156.52475-156.52525	2483.5-2500	17.7-21.4
8.37625-8.38675	156.7-156.9	2690-2900	22.01-23.12
8.41425-8.41475	162.0125-167.17	3260-3267	23.6-24.0
12.29-12.293	167.72-173.2	3332-3339	31.2-31.8
12.51975-12.52025	240-285	3345.8-3358	36.43-36.5
12.57675-12.57725	322-335.4	3600-4400	(²)
13.36-13.41			

Note: ¹Until February 1, 1999, this restricted band shall be 0.490-0.510 MHz.

²Above 38.6c



Limits of unwanted/undesirable emission out of the restricted bands refer to CFR 47 FCC §15.407 (b) and ISED RSS-247 6.2.

LIMITS OF RADIATED EMISSION MEASUREMENT (Above 1GHz)		
Frequency Range (MHz)	EIRP Limit	Field Strength Limit (dBuV/m) at 3 m
5150~5250 MHz	PK: -27 (dBm/MHz)	PK:68.2(dBμV/m)
5250~5350 MHz		
5470~5725 MHz		
5725~5850 MHz	PK: -27 (dBm/MHz) *1 PK: 10 (dBm/MHz) *2 PK: 15.6 (dBm/MHz) *3 PK: 27 (dBm/MHz) *4	PK: 68.2(dBμV/m) *1 PK: 105.2 (dBμV/m) *2 PK: 110.8(dBμV/m) *3 PK: 122.2 (dBμV/m) *4
<p>Note:</p> <p>*1 beyond 75 MHz or more above of the band edge.</p> <p>*2 below the band edge increasing linearly to 10 dBm/MHz at 25 MHz above.</p> <p>*3 below the band edge increasing linearly to a level of 15.6 dBm/MHz at 5 MHz above.</p> <p>*4 from 5 MHz above or below the band edge increasing linearly to a level of 27 dBm/MHz at the band edge.</p>		

TEST SETUP AND PROCEDURE

Below 30 MHz

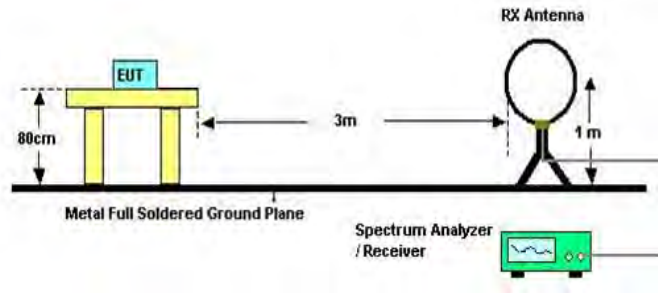

The setting of the spectrum analyser

RBW	200 Hz (From 9 kHz to 0.15 MHz)/ 9 kHz (From 0.15 MHz to 30 MHz)
VBW	200 Hz (From 9 kHz to 0.15 MHz)/ 9 kHz (From 0.15 MHz to 30 MHz)
Sweep	Auto

1. The testing follows the guidelines in ANSI C63.10-2013 clause 6.4.
2. The EUT was arranged to its worst case and then turntable (from 0 degree to 360 degrees) to find the maximum reading. A pre-amp and a high pass filter are used for the test in order to get better signal level. Both Horizontal, Face-on and Face-off polarizations of the antenna are set to make the measurement.
3. The EUT was placed on a turntable with 80 cm above ground.
4. The EUT was set 3 meters from the interference receiving antenna, which was mounted on the top of a 1 m height antenna tower.
5. The radiated emission limits are based on measurements employing a CISPR quasi-peak detector except for the frequency bands 9-90 kHz, 110-490 kHz and above 1000 MHz Radiated emission limits in these three bands are based on measurements employing an average detector.
6. For measurement below 1 GHz, the initial step in collecting conducted emission data is a spectrum analyzer peak detector mode pre-scanning the measurement frequency range. Significant peaks are then marked and then Quasi Peak and average detector mode re-measured. If the emission level of the EUT measured by the peak detector is 3 dB lower than the applicable limit, the peak emission level will be reported. Otherwise, the emission measurement will be repeated using the quasi-peak and average detector and reported.
7. Although these tests were performed other than open field site, adequate comparison measurements were confirmed against 30m open field site. Therefore sufficient tests were made to demonstrate that the alternative site produces results that correlate with the ones of tests made in an open field site based on KDB 414788.
8. The limits in CFR 47, Part 15, Subpart C, paragraph 15.209 (a), are identical to those in RSS-GEN Section 8.9, Table 6, since the measurements are performed in terms of magnetic field strength and converted to electric field strength levels (as reported in the table) using the free space impedance of 377Ω. For example, the measurement frequency X KHz resulted in a level of Y dBuV/m, which is equivalent to $Y-51.5 = Z$ dBuA/m, which has the same margin, W dB, to the corresponding RSS-GEN Table 6 limit as it has to be 15.209(a) limit.

Below 1 GHz and above 30 MHz

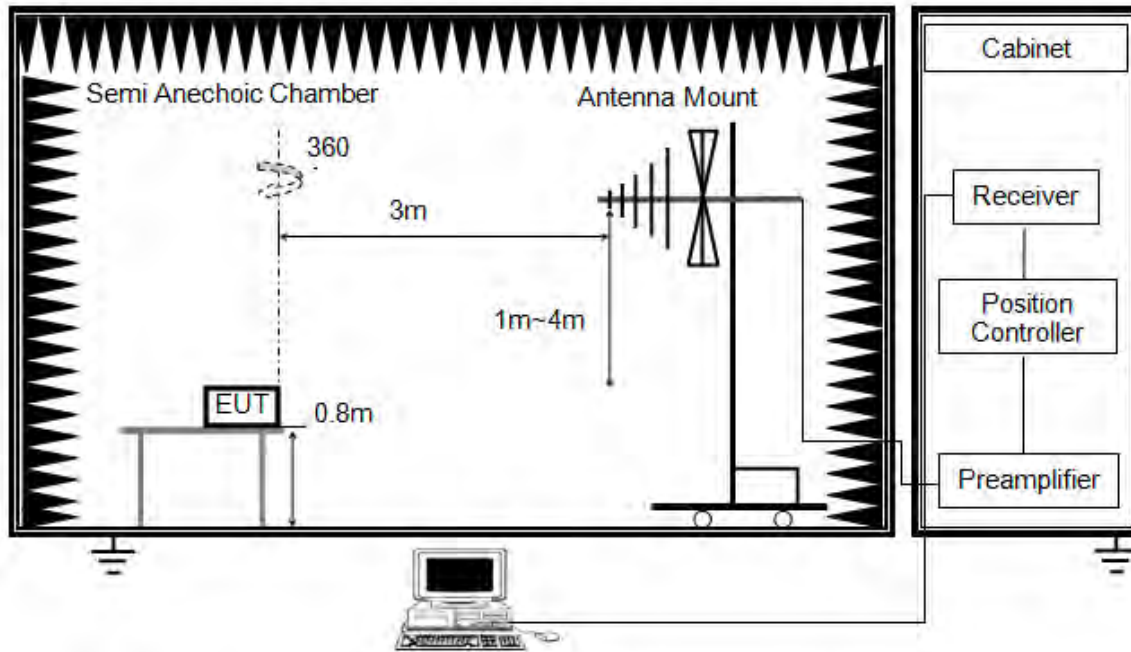

The setting of the spectrum analyser

RBW	120 kHz
VBW	300 kHz
Sweep	Auto
Detector	Peak/QP
Trace	Max hold

1. The testing follows the guidelines in ANSI C63.10-2013 clause 6.5.
2. The EUT was arranged to its worst case and then tune the antenna tower (from 1 m to 4 m) and turntable (from 0 degree to 360 degrees) to find the maximum reading. A pre-amp and a high pass filter are used for the test in order to get better signal level. Both horizontal and vertical polarizations of the antenna are set to make the measurement.
3. The EUT was placed on a turntable with 80 cm above ground.
4. The EUT was set 3 meters from the interference receiving antenna, which was mounted on the top of a variable height antenna tower.
5. For measurement below 1 GHz, the initial step in collecting conducted emission data is a spectrum analyzer peak detector mode pre-scanning the measurement frequency range. Significant peaks are then marked and then Quasi Peak detector mode re-measured. If the emission level of the EUT measured by the peak detector is 3 dB lower than the applicable limit, the peak emission level will be reported. Otherwise, the emission measurement will be repeated using the quasi-peak detector and reported.

Above 1 GHz

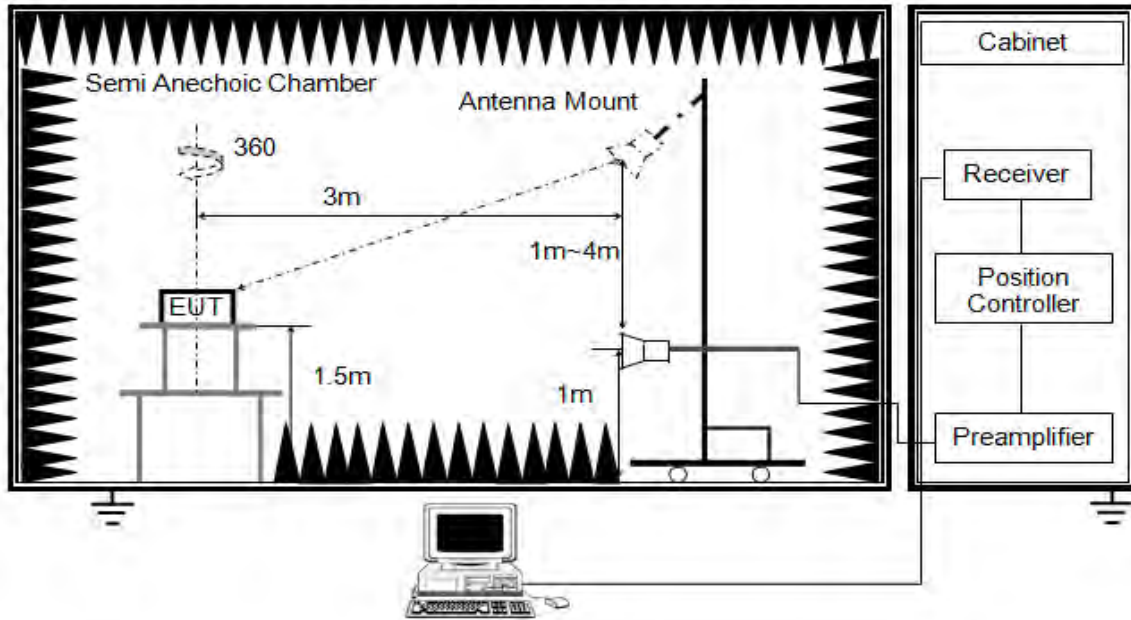

The setting of the spectrum analyser

RBW	1 MHz
VBW	PEAK: 3 MHz AVG: see note 6
Sweep	Auto
Detector	Peak
Trace	Max hold

1. The testing follows the guidelines in KDB 789033 D02 General U-NII Test Procedures New Rules v02r01 section II.G.3 ~ II.G.6.
2. The EUT was arranged to its worst case and then tune the antenna tower (from 1 m to 4 m) and turntable (from 0 degree to 360 degrees) to find the maximum reading. A pre-amp and a high pass filter are used for the test in order to get better signal level. Both horizontal and vertical polarizations of the antenna are set to make the measurement.
3. The EUT was placed on a turntable with 1.5 m above ground.
4. The EUT was set 3 meters from the interference receiving antenna, which was mounted on the top of a variable height antenna tower.
5. For measurement above 1 GHz, the emission measurement will be measured by the peak detector. This peak level, once corrected, must comply with the limit specified in Section 15.209.
6. For measurements above 1 GHz the resolution bandwidth is set to 1 MHz, then the video bandwidth is set to 3 MHz for peak measurements and 1 MHz resolution bandwidth with 1/T video bandwidth with peak detector for average measurements. For the Duty Cycle please refer to clause 7.1.ON TIME AND DUTY CYCLE.

X axis, Y axis, Z axis positions:

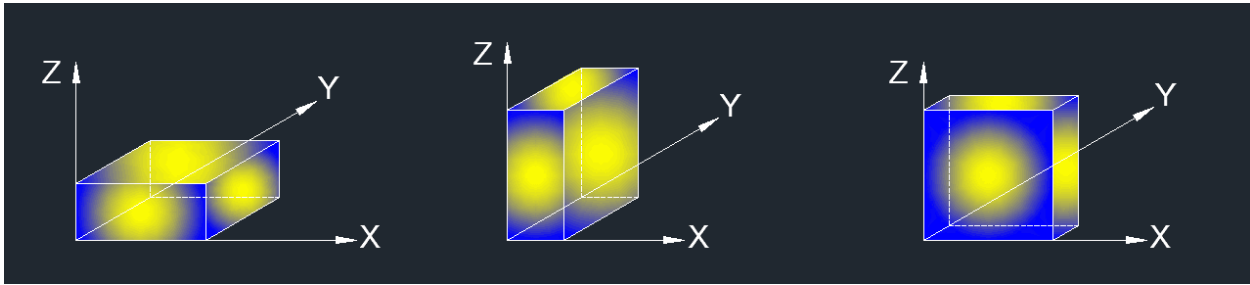

Note 1: For all radiated test, EUT in each of three orthogonal axis emissions had been tested, but only the worst case (X axis) data recorded in the report.

TEST ENVIRONMENT

Temperature	26.2 °C	Relative Humidity	61.3 %
Atmosphere Pressure	101 kPa	Test Voltage	DC 3.3 V

RESULTS

8.1. RESTRICTED BANDEGE

8.1.1. 802.11a SISO MODE

UNII-1 BAND

ANTENNA 1 TEST RESULTS (WORST CASE)

RESTRICTED BANDEGE (LOW CHANNEL, HORIZONTAL)

PEAK

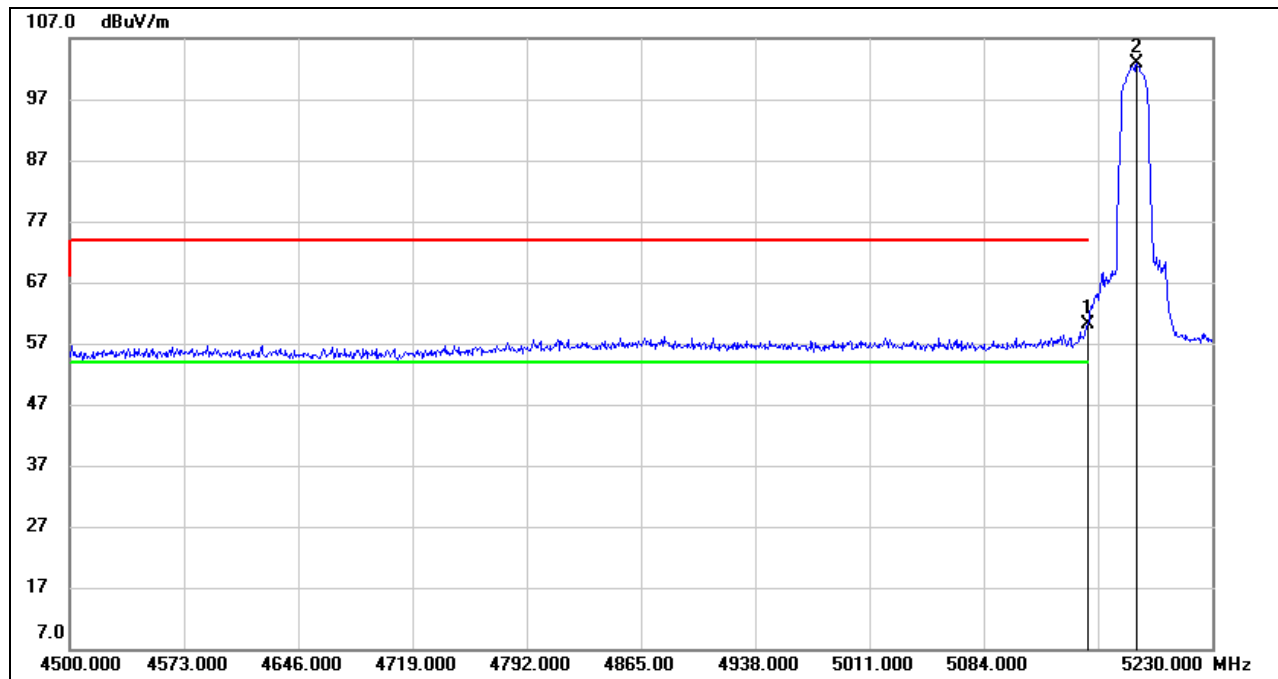

No.	Frequency (MHz)	Reading (dBuV)	Correct (dB/m)	Result (dBuV/m)	Limit (dBuV/m)	Margin (dB)	Remark
1	5150.000	18.92	41.19	60.11	74.00	-13.89	peak
2	5181.820	61.45	41.46	102.91	/	/	Fundamental

- Note:
1. Measurement = Reading Level + Correct Factor.
 2. If Peak Result complies with AV limit, AV Result is deemed to comply with AV limit.
 3. Peak: Peak detector.
 4. Only the worst data was recorded, if it complies with the limit, the other emissions deemed to comply with the limit.



AVG

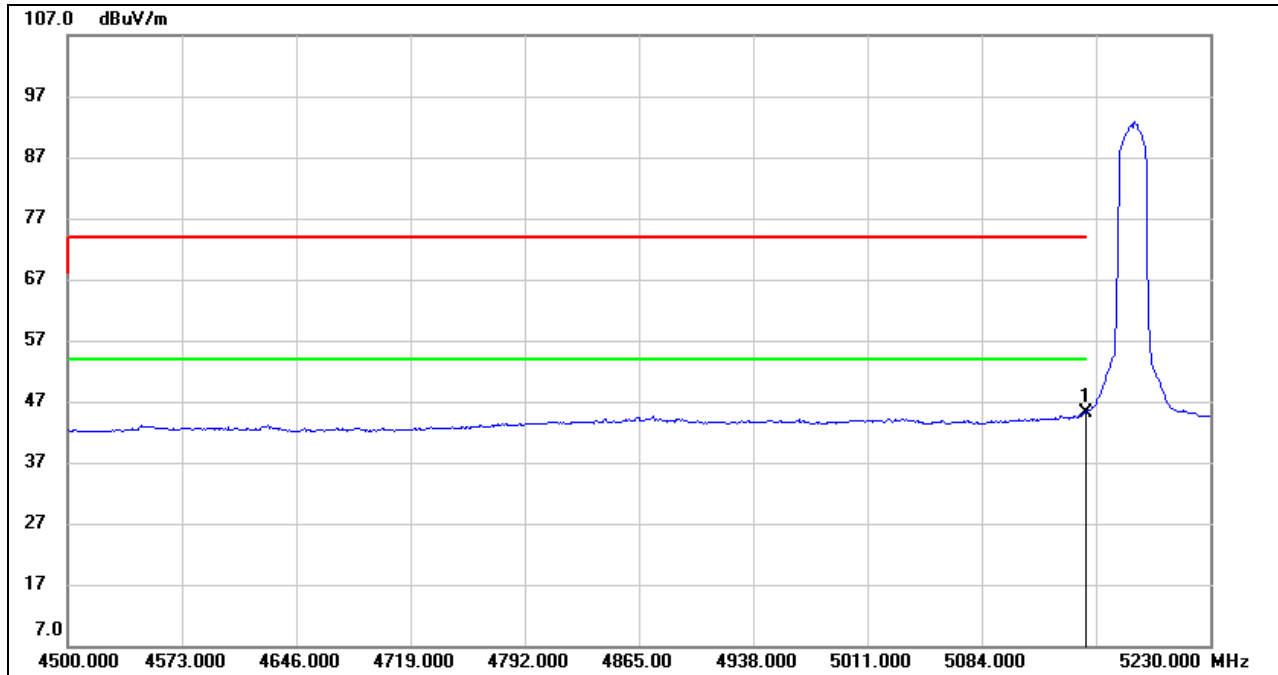

No.	Frequency (MHz)	Reading (dBuV)	Correct (dB/m)	Result (dBuV/m)	Limit (dBuV/m)	Margin (dB)	Remark
1	5150.000	3.92	41.19	45.11	54.00	-8.89	AVG

- Note:
1. Measurement = Reading Level + Correct Factor.
 2. If Peak Result complies with AV limit, AV Result is deemed to comply with AV limit.
 3. AVG: $VBW=1/Ton$, where: Ton is the transmitting duration.
 4. For the transmitting duration, please refer to clause 7.1.
 5. Only the worst data was recorded, if it complies with the limit, the other emissions deemed to comply with the limit.



RESTRICTED BANDEDGE (LOW CHANNEL, VERTICAL)

PEAK

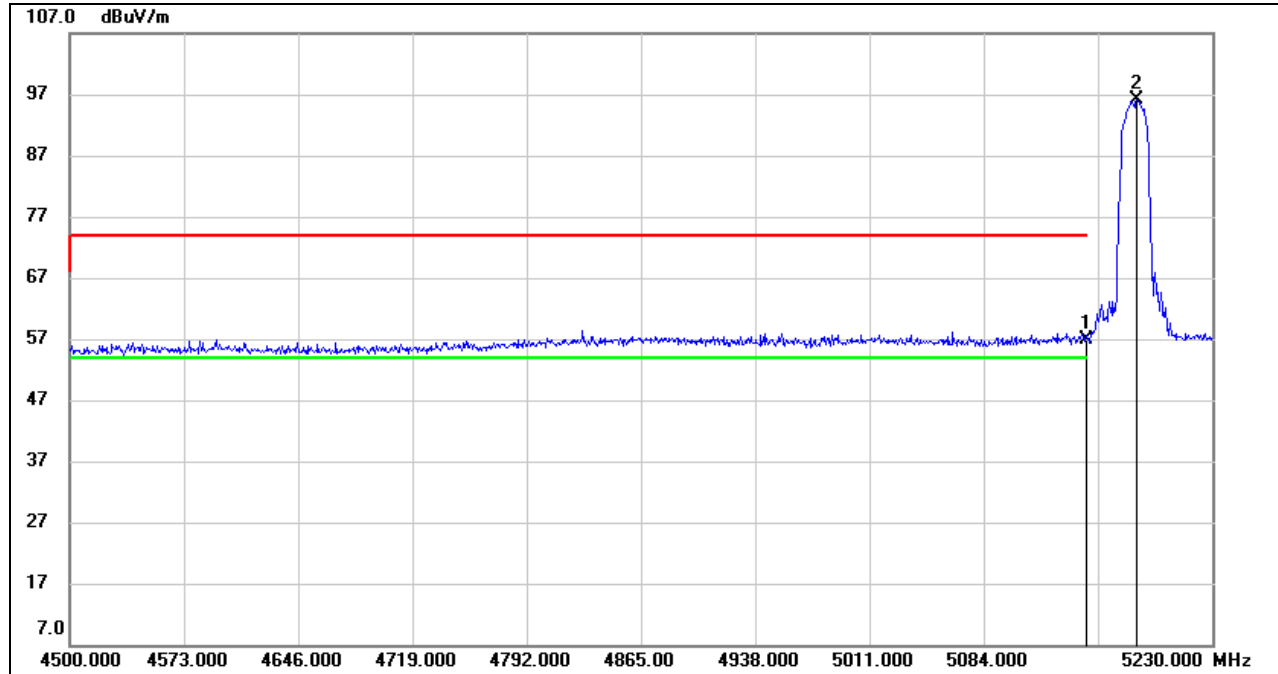

No.	Frequency (MHz)	Reading (dBuV)	Correct (dB/m)	Result (dBuV/m)	Limit (dBuV/m)	Margin (dB)	Remark
1	5150.000	15.81	41.19	57.00	74.00	-17.00	peak
2	5181.820	54.55	41.46	96.01	/	/	Fundamental

- Note: 1. Measurement = Reading Level + Correct Factor.
 2. If Peak Result complies with AV limit, AV Result is deemed to comply with AV limit.
 3. Peak: Peak detector.
 4. Only the worst data was recorded, if it complies with the limit, the other emissions deemed to comply with the limit.



AVG

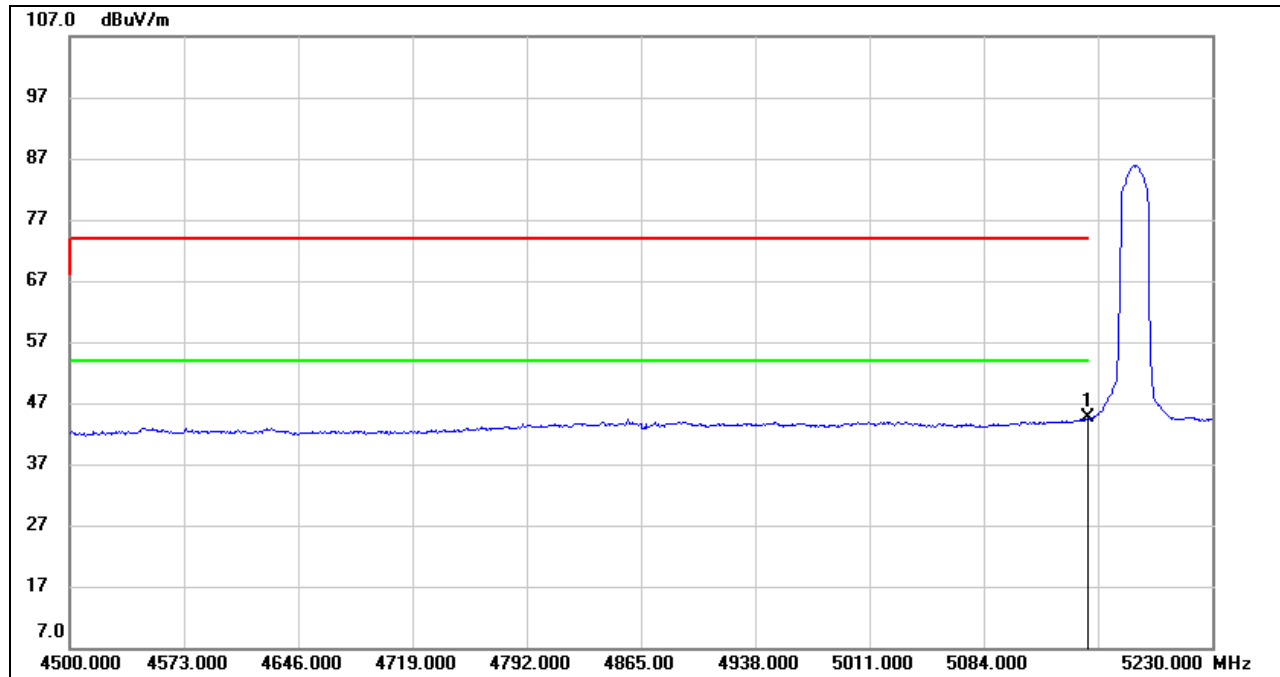

No.	Frequency (MHz)	Reading (dBuV)	Correct (dB/m)	Result (dBuV/m)	Limit (dBuV/m)	Margin (dB)	Remark
1	5150.000	3.36	41.19	44.55	74.00	-29.45	peak

- Note:
1. Measurement = Reading Level + Correct Factor.
 2. If Peak Result complies with AV limit, AV Result is deemed to comply with AV limit.
 3. AVG: $VBW=1/Ton$, where: Ton is the transmitting duration.
 4. For the transmitting duration, please refer to clause 7.1.
 5. Only the worst data was recorded, if it complies with the limit, the other emissions deemed to comply with the limit.

UNII-2A BAND

ANTENNA 1 TEST RESULTS (WORST CASE)

RESTRICTED BANDEDGE (HIGH CHANNEL, HORIZONTAL)

PEAK

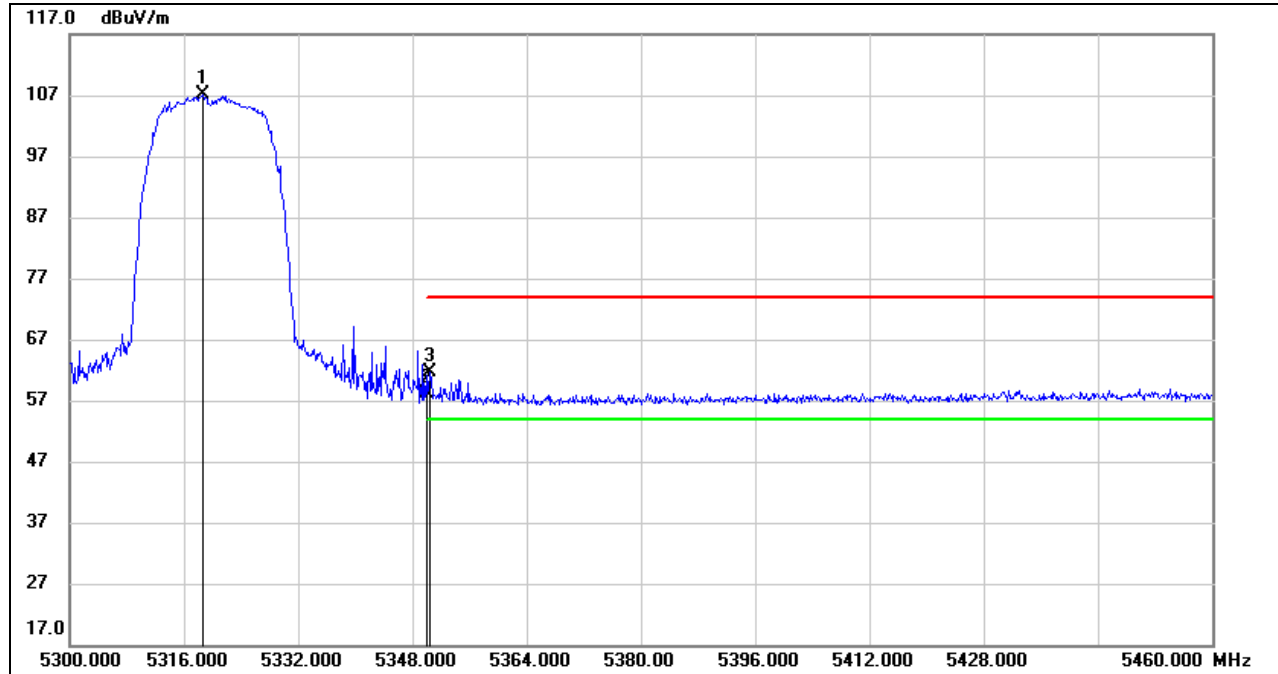

No.	Frequency (MHz)	Reading (dBuV)	Correct (dB/m)	Result (dBuV/m)	Limit (dBuV/m)	Margin (dB)	Remark
1	5318.560	66.06	41.03	107.09	/	/	Fundamental
2	5350.000	16.89	41.20	58.09	74.00	-15.91	peak
3	5350.400	20.54	41.21	61.75	74.00	-12.25	peak

- Note: 1. Measurement = Reading Level + Correct Factor.
 2. If Peak Result complies with AV limit, AV Result is deemed to comply with AV limit.
 3. Peak: Peak detector.
 4. Only the worst data was recorded, if it complies with the limit, the other emissions deemed to comply with the limit.



AVG

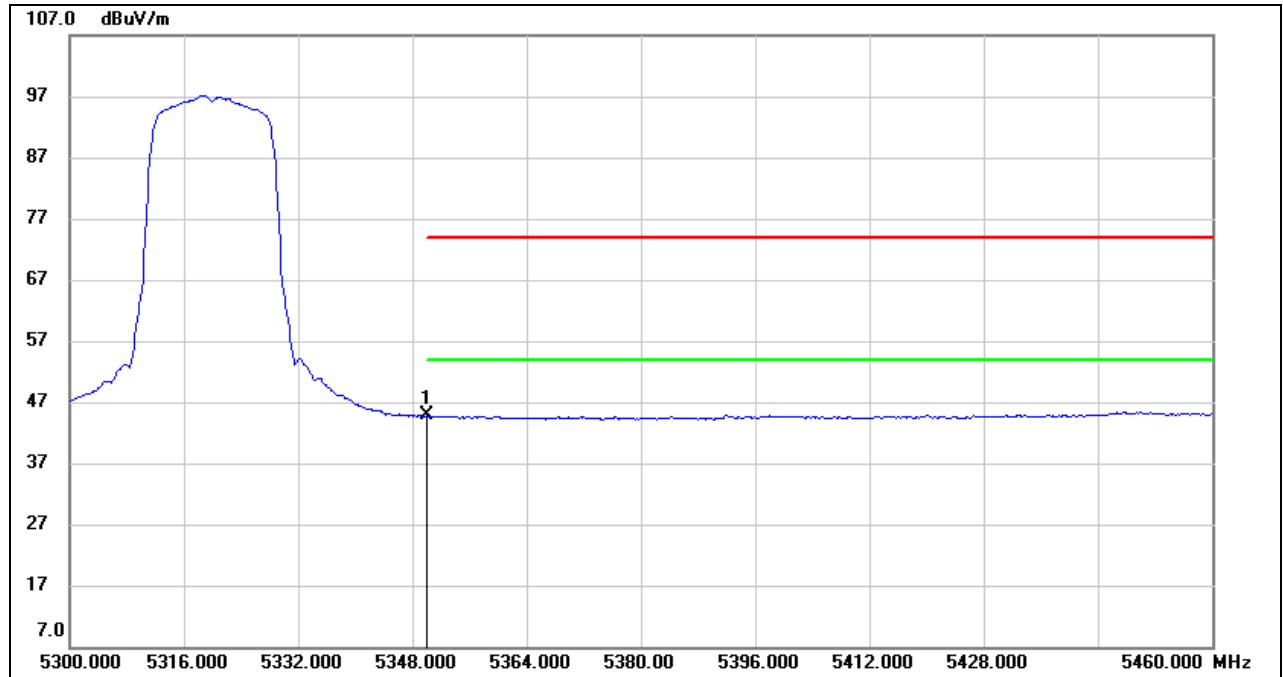

No.	Frequency (MHz)	Reading (dBuV)	Correct (dB/m)	Result (dBuV/m)	Limit (dBuV/m)	Margin (dB)	Remark
1	5350.000	3.57	41.20	44.77	54.00	-9.23	AVG

- Note:
1. Measurement = Reading Level + Correct Factor.
 2. If Peak Result complies with AV limit, AV Result is deemed to comply with AV limit.
 3. AVG: $VBW=1/Ton$, where: Ton is the transmitting duration.
 4. For the transmitting duration, please refer to clause 7.1.
 5. Only the worst data was recorded, if it complies with the limit, the other emissions deemed to comply with the limit.

UNII-2C BAND

ANTENNA 1 TEST RESULTS (WORST CASE)

RESTRICTED BANDEDGE (LOW CHANNEL, HORIZONTAL)

PEAK

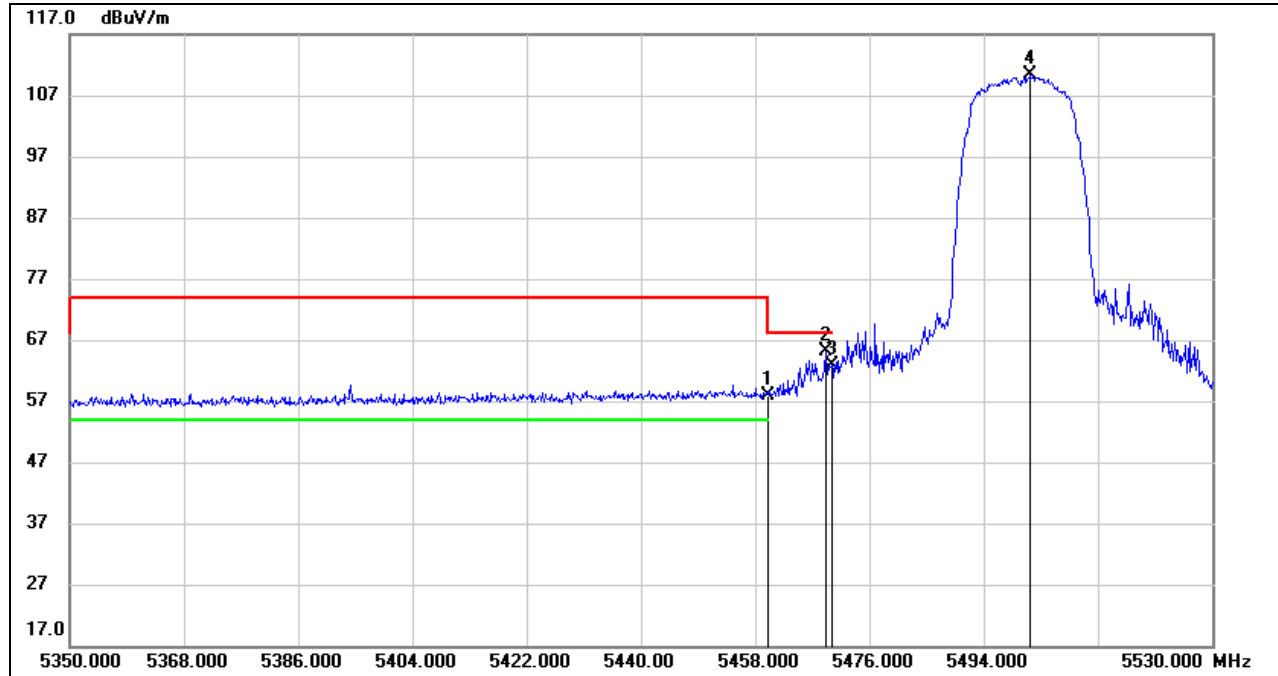

No.	Frequency (MHz)	Reading (dBuV)	Correct (dB/m)	Result (dBuV/m)	Limit (dBuV/m)	Margin (dB)	Remark
1	5460.000	16.12	41.82	57.94	68.20	-10.26	peak
2	5469.160	23.34	41.87	65.21	68.20	-2.99	peak
3	5470.000	20.99	41.87	62.86	68.20	-5.34	peak
4	5501.380	68.34	42.04	110.38	/	/	Fundamental

Note: 1. Measurement = Reading Level + Correct Factor.
 2. If Peak Result complies with AV limit, AV Result is deemed to comply with AV limit.
 3. Peak: Peak detector.
 4. Only the worst data was recorded, if it complies with the limit, the other emissions deemed to comply with the limit.



AVG

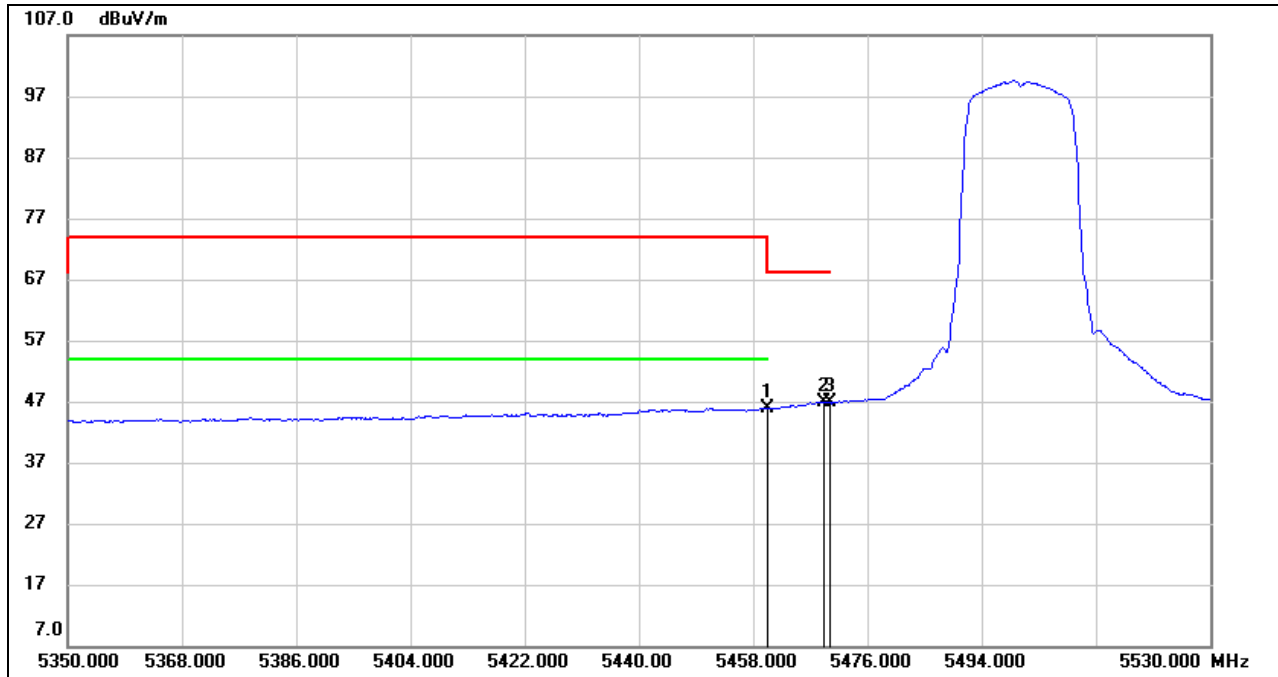

No.	Frequency (MHz)	Reading (dBuV)	Correct (dB/m)	Result (dBuV/m)	Limit (dBuV/m)	Margin (dB)	Remark
1	5460.000	4.18	41.82	46.00	/	/	AVG
2	5469.160	4.95	41.87	46.82	54.00	-7.18	AVG
3	5470.000	5.07	41.87	46.94	/	/	AVG

- Note:
1. Measurement = Reading Level + Correct Factor.
 2. If Peak Result complies with AV limit, AV Result is deemed to comply with AV limit.
 3. AVG: $VBW=1/Ton$, where: Ton is the transmitting duration.
 4. For the transmitting duration, please refer to clause 7.1.
 5. Only the worst data was recorded, if it complies with the limit, the other emissions deemed to comply with the limit.

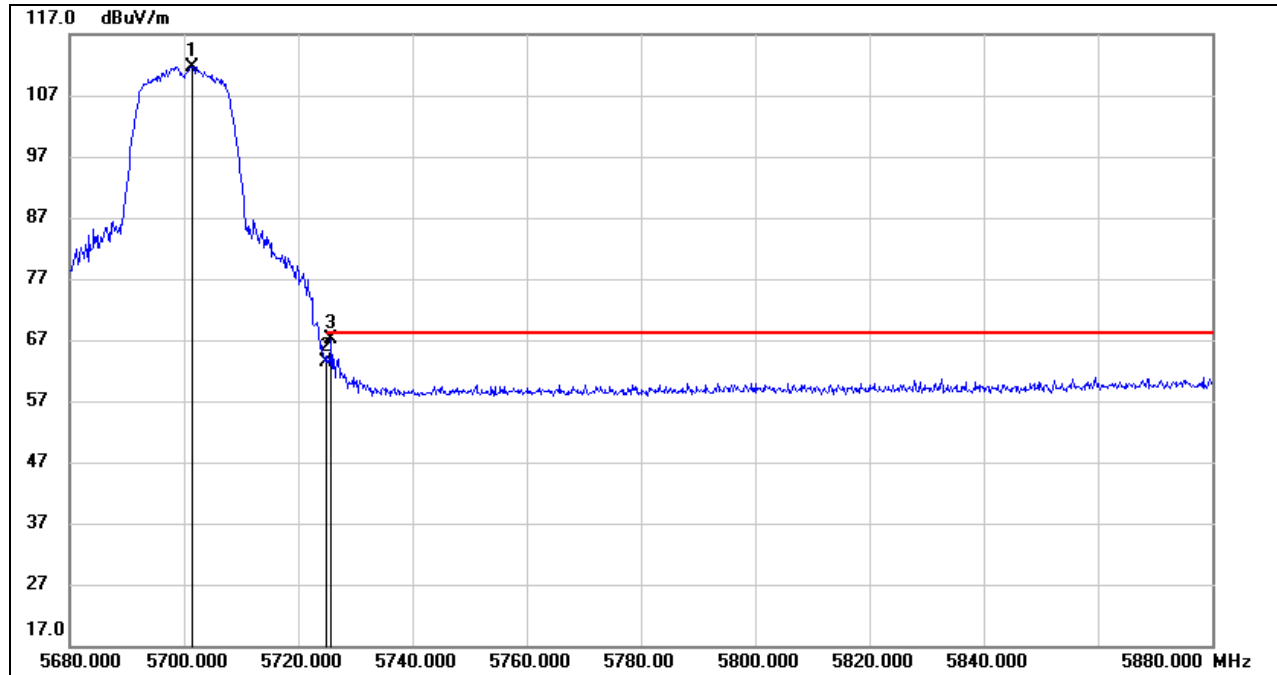
**RESTRICTED BANDEDGE (HIGH CHANNEL, HORIZONTAL)****PEAK**

No.	Frequency (MHz)	Reading (dBuV)	Correct (dB/m)	Result (dBuV/m)	Limit (dBuV/m)	Margin (dB)	Remark
1	5701.400	70.17	41.55	111.72	/	/	Fundamental
2	5725.000	21.69	41.67	63.36	68.20	-4.84	peak
3	5725.800	25.51	41.67	67.18	68.20	-1.02	peak

- Note: 1. Measurement = Reading Level + Correct Factor.
 2. If Peak Result complies with AV limit, AV Result is deemed to comply with AV limit.
 3. Peak: Peak detector.
 4. Only the worst data was recorded, if it complies with the limit, the other emissions deemed to comply with the limit.

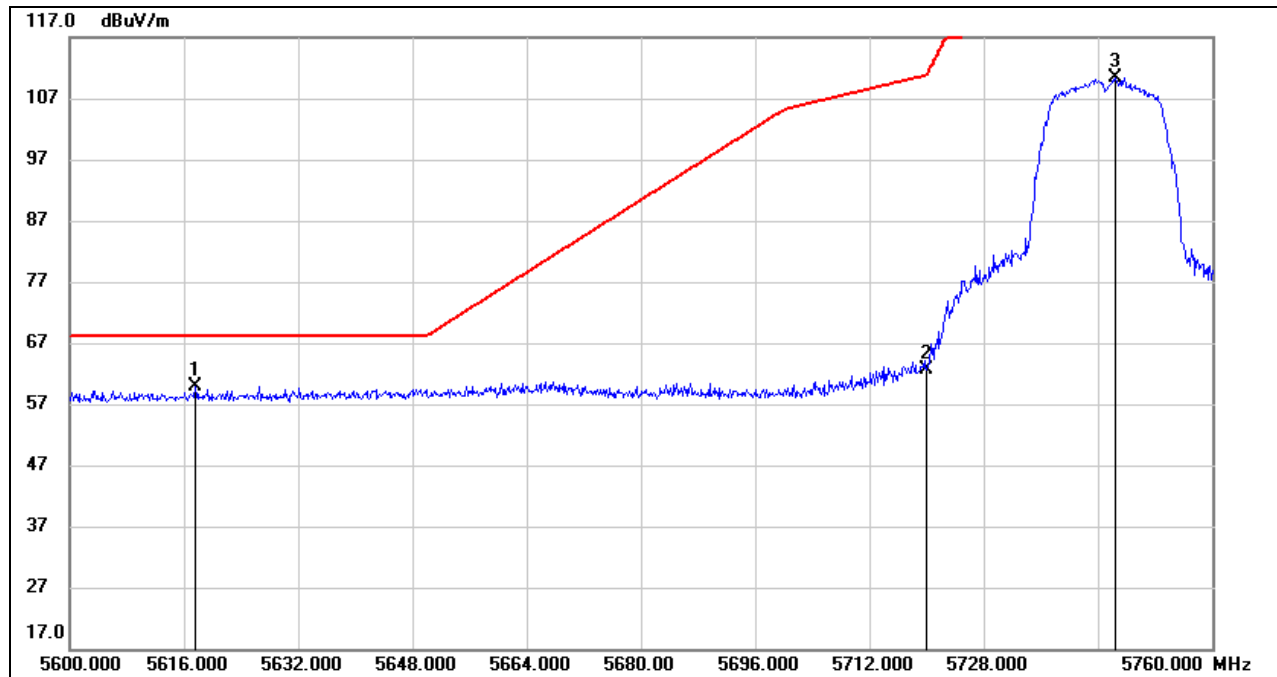
**UNII-3 BAND****ANTENNA 1 TEST RESULTS (WORST CASE)****RESTRICTED BANDEDGE (LOW CHANNEL, HORIZONTAL)****PEAK**

No.	Frequency (MHz)	Reading (dBuV)	Correct (dB/m)	Result (dBuV/m)	Limit (dBuV/m)	Margin (dB)	Remark
1	5617.600	18.10	41.70	59.80	68.20	-8.40	peak
2	5720.000	21.07	41.64	62.71	110.80	-48.09	peak
3	5746.400	68.52	41.77	110.29	/	/	Fundamental

Note: 1. Measurement = Reading Level + Correct Factor.

2. If Peak Result complies with AV limit, AV Result is deemed to comply with AV limit.

3. Peak: Peak detector.

4. Only the worst data was recorded, if it complies with the limit, the other emissions deemed to comply with the limit.

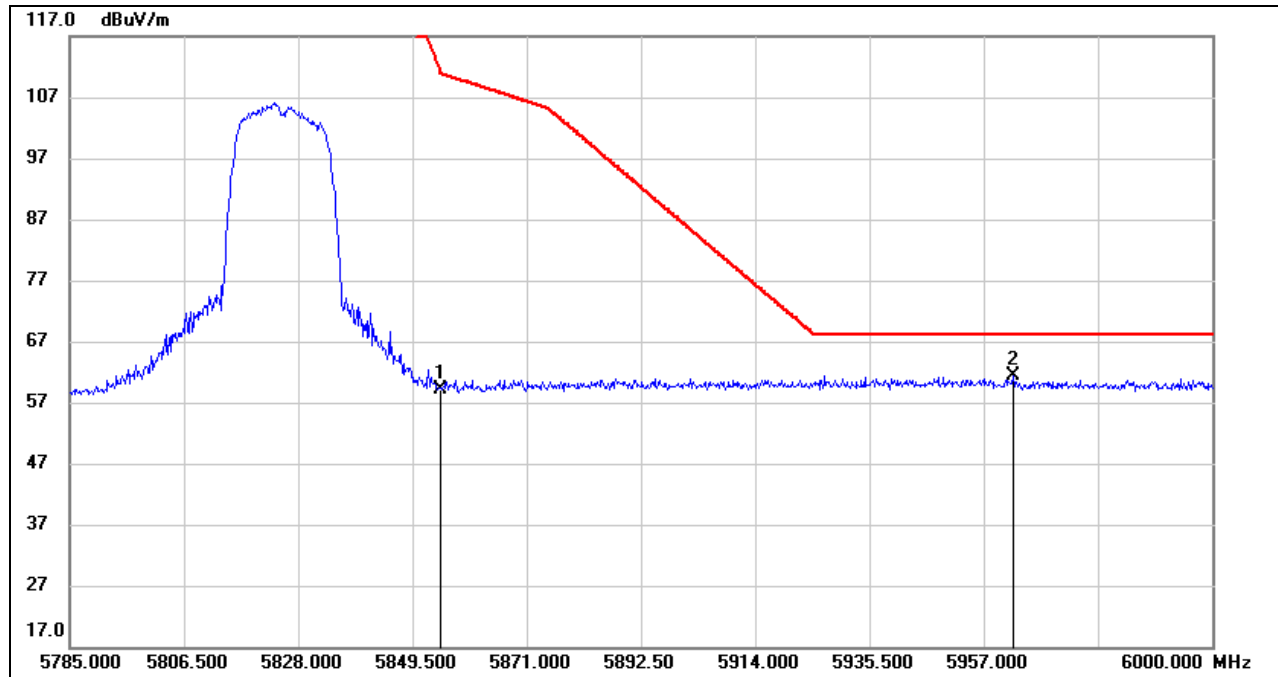
**RESTRICTED BANDEDGE (HIGH CHANNEL, HORIZONTAL)****PEAK**

No.	Frequency (MHz)	Reading (dBuV)	Correct (dB/m)	Result (dBuV/m)	Limit (dBuV/m)	Margin (dB)	Remark
1	5855.000	16.44	42.58	59.02	110.80	-51.78	peak
2	5962.590	18.57	42.74	61.31	68.20	-6.89	peak

- Note: 1. Measurement = Reading Level + Correct Factor.
 2. If Peak Result complies with AV limit, AV Result is deemed to comply with AV limit.
 3. Peak: Peak detector.
 4. Only the worst data was recorded, if it complies with the limit, the other emissions deemed to comply with the limit.

Note: All the polarities (Vertical & Horizontal) and Antennas had been tested, only the worst data was recorded in the report.

8.1.2. 802.11n HT20 MIMO MODE

UNII-1 BAND

RESTRICTED BANDEDGE (LOW CHANNEL, HORIZONTAL)

PEAK

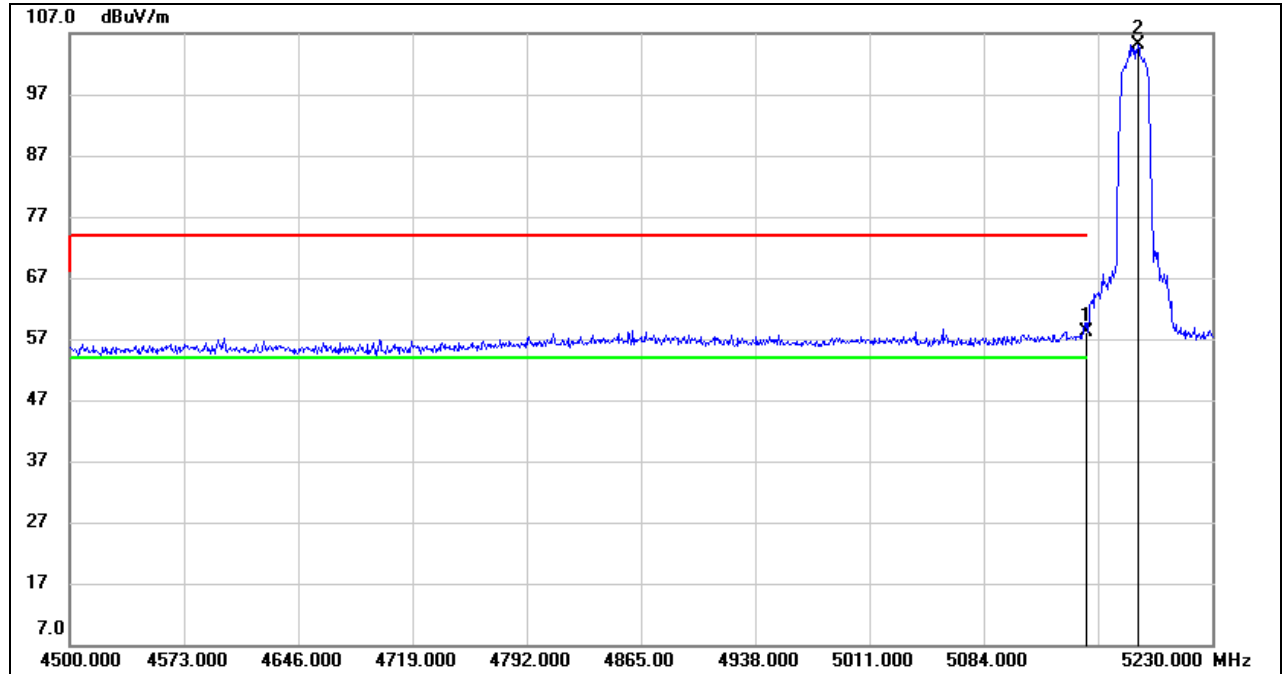

No.	Frequency (MHz)	Reading (dBuV)	Correct (dB/m)	Result (dBuV/m)	Limit (dBuV/m)	Margin (dB)	Remark
1	5150.000	17.01	41.19	58.20	74.00	-15.80	peak
2	5182.550	63.68	41.47	105.15	/	/	Fundamental

- Note: 1. Measurement = Reading Level + Correct Factor.
 2. If Peak Result complies with AV limit, AV Result is deemed to comply with AV limit.
 3. Peak: Peak detector.
 4. Only the worst data was recorded, if it complies with the limit, the other emissions deemed to comply with the limit.



AVG

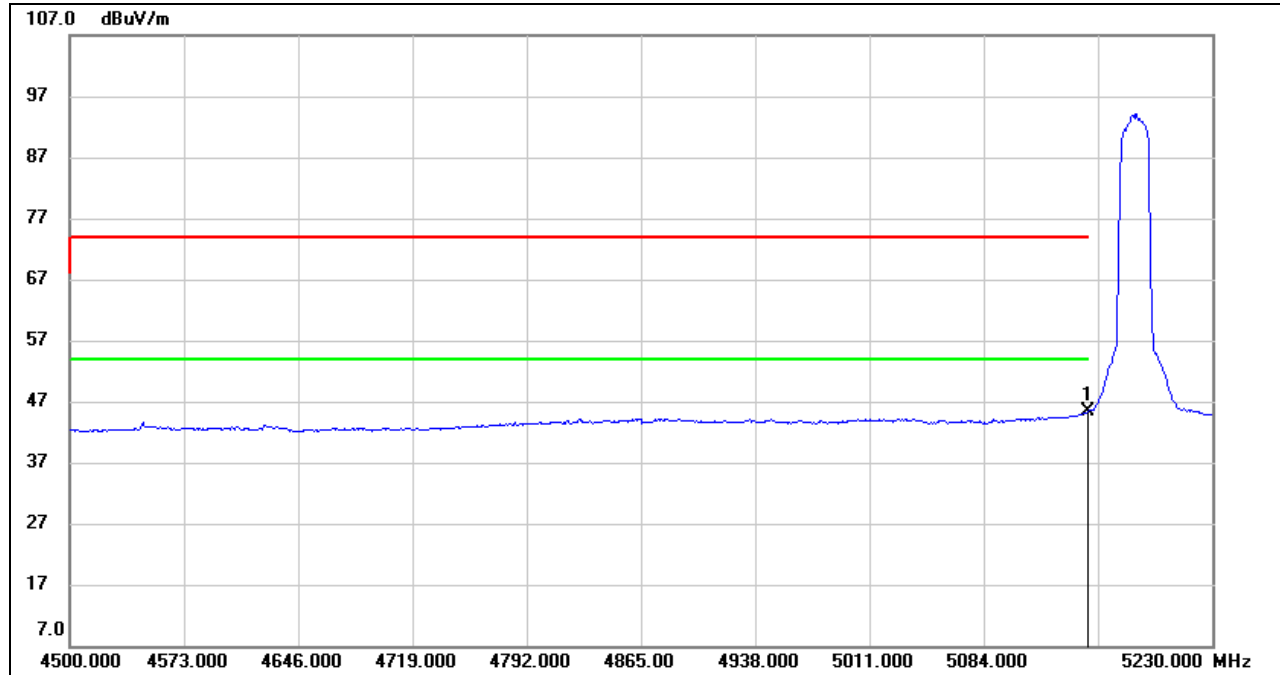

No.	Frequency (MHz)	Reading (dBuV)	Correct (dB/m)	Result (dBuV/m)	Limit (dBuV/m)	Margin (dB)	Remark
1	5150.000	4.11	41.19	45.30	54.00	-8.70	AVG

- Note:
1. Measurement = Reading Level + Correct Factor.
 2. If Peak Result complies with AV limit, AV Result is deemed to comply with AV limit.
 3. AVG: $VBW=1/Ton$, where: Ton is the transmitting duration.
 4. For the transmitting duration, please refer to clause 7.1.
 5. Only the worst data was recorded, if it complies with the limit, the other emissions deemed to comply with the limit.

UNII-2A BAND

RESTRICTED BANDEDGE (HIGH CHANNEL, HORIZONTAL)

PEAK

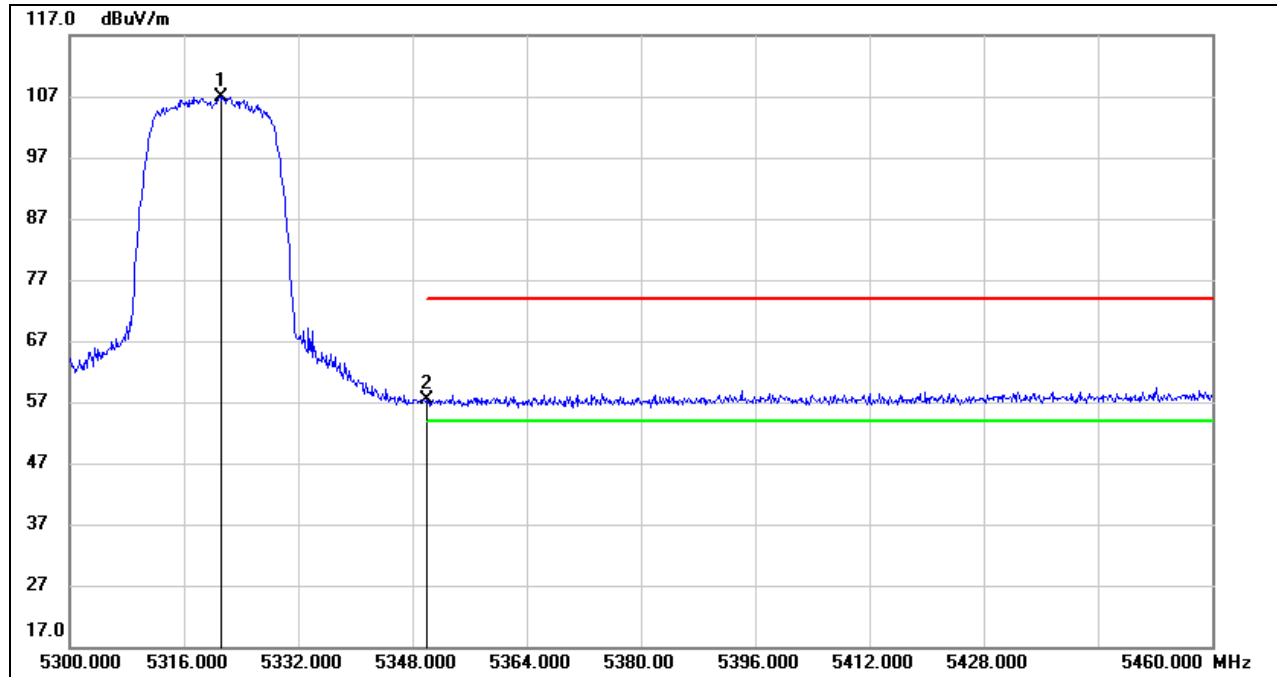

No.	Frequency (MHz)	Reading (dBuV)	Correct (dB/m)	Result (dBuV/m)	Limit (dBuV/m)	Margin (dB)	Remark
1	5321.120	65.83	41.05	106.88	/	/	Fundamental
2	5350.000	16.15	41.20	57.35	74.00	-16.65	peak

- Note: 1. Measurement = Reading Level + Correct Factor.
 2. If Peak Result complies with AV limit, AV Result is deemed to comply with AV limit.
 3. Peak: Peak detector.
 4. Only the worst data was recorded, if it complies with the limit, the other emissions deemed to comply with the limit.



AVG

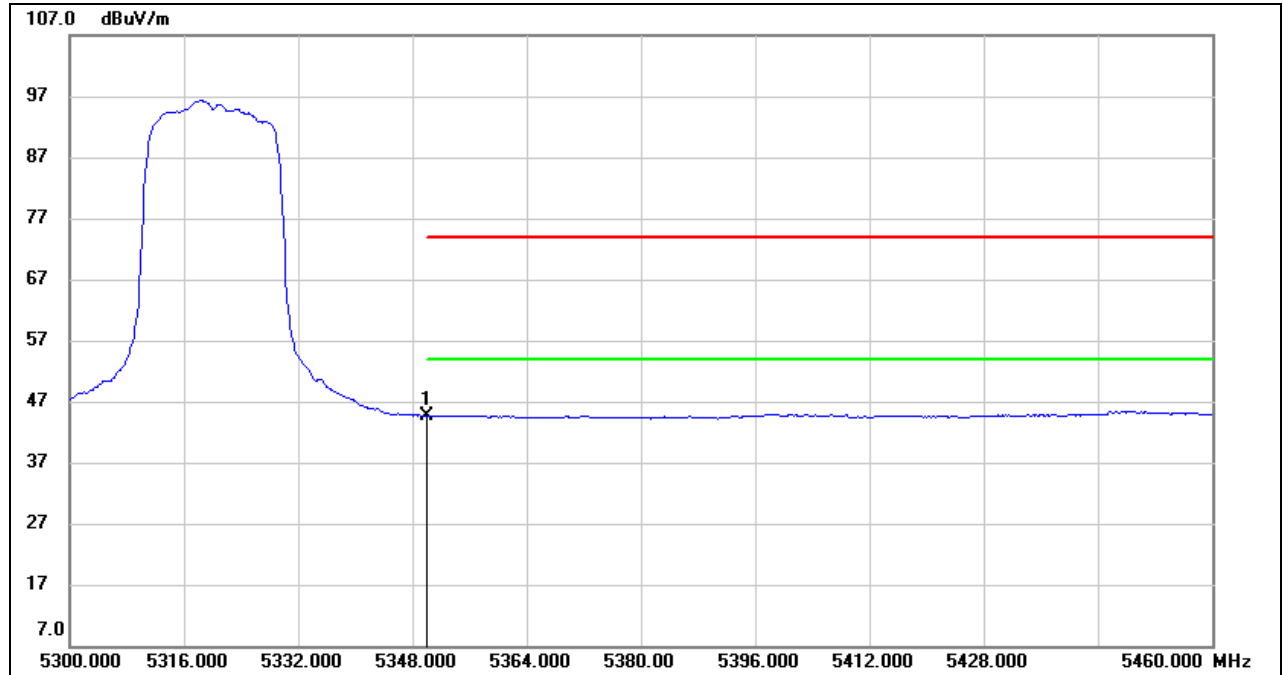

No.	Frequency (MHz)	Reading (dBuV)	Correct (dB/m)	Result (dBuV/m)	Limit (dBuV/m)	Margin (dB)	Remark
1	5350.000	3.44	41.20	44.64	54.00	-9.36	AVG

- Note:
1. Measurement = Reading Level + Correct Factor.
 2. If Peak Result complies with AV limit, AV Result is deemed to comply with AV limit.
 3. AVG: $VBW=1/Ton$, where: Ton is the transmitting duration.
 4. For the transmitting duration, please refer to clause 7.1.
 5. Only the worst data was recorded, if it complies with the limit, the other emissions deemed to comply with the limit.

UNII-2C BAND

RESTRICTED BANDEDGE (LOW CHANNEL, HORIZONTAL)

PEAK

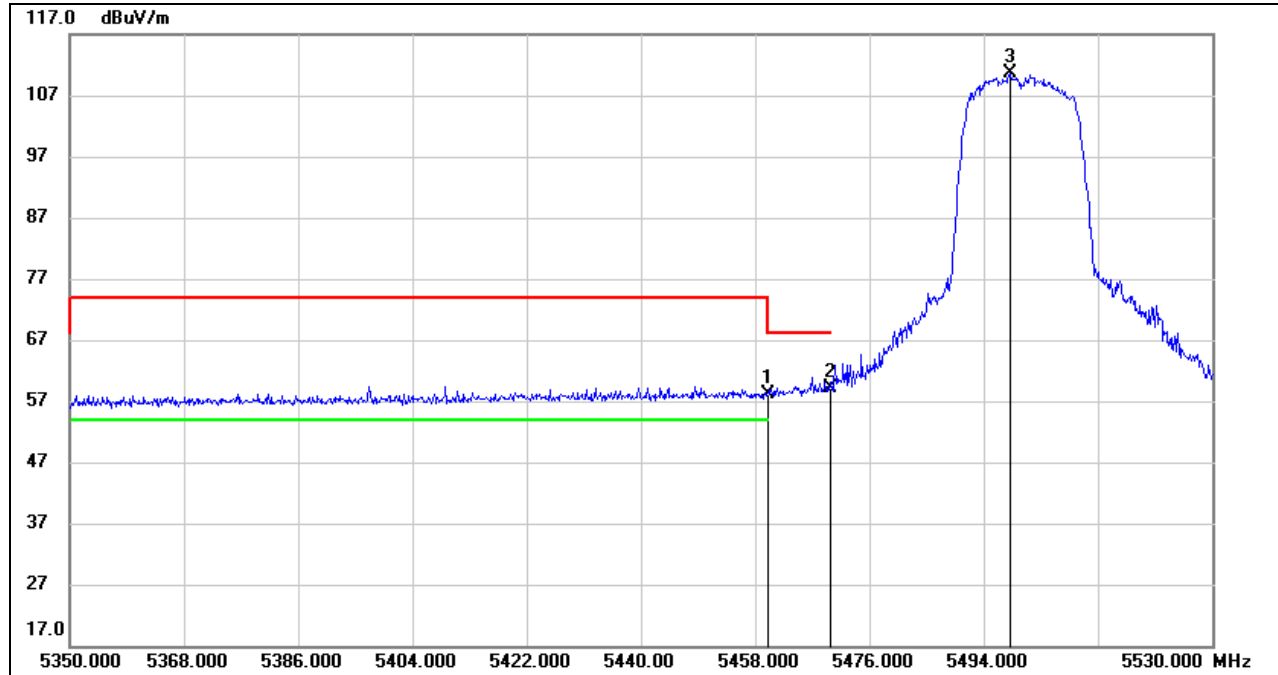

No.	Frequency (MHz)	Reading (dBuV)	Correct (dB/m)	Result (dBuV/m)	Limit (dBuV/m)	Margin (dB)	Remark
1	5460.000	16.27	41.82	58.09	68.20	-10.11	peak
2	5470.000	17.25	41.87	59.12	68.20	-9.08	peak
3	5498.140	68.52	42.04	110.56	/	/	Fundamental

Note: 1. Measurement = Reading Level + Correct Factor.
 2. If Peak Result complies with AV limit, AV Result is deemed to comply with AV limit.
 3. Peak: Peak detector.
 4. Only the worst data was recorded, if it complies with the limit, the other emissions deemed to comply with the limit.



AVG

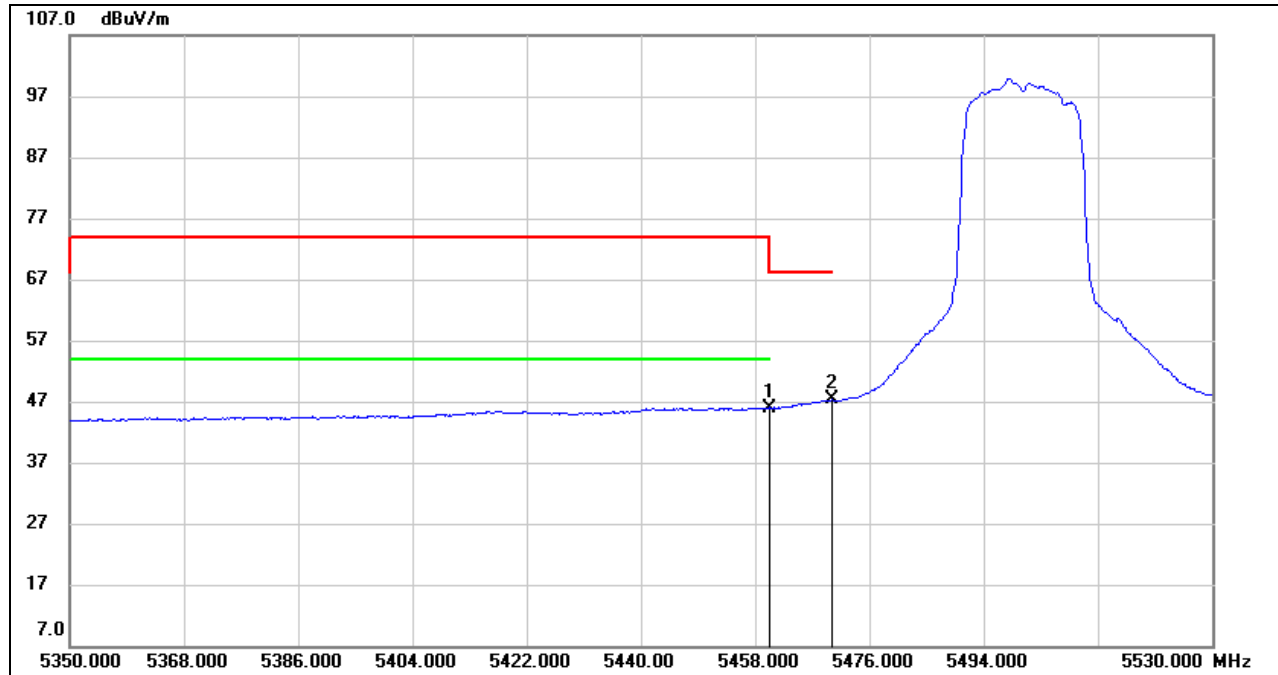

No.	Frequency (MHz)	Reading (dBuV)	Correct (dB/m)	Result (dBuV/m)	Limit (dBuV/m)	Margin (dB)	Remark
1	5460.000	4.16	41.82	45.98	/	/	AVG
2	5470.000	5.39	41.87	47.26	/	/	AVG

- Note:
1. Measurement = Reading Level + Correct Factor.
 2. If Peak Result complies with AV limit, AV Result is deemed to comply with AV limit.
 3. AVG: $VBW=1/Ton$, where: Ton is the transmitting duration.
 4. For the transmitting duration, please refer to clause 7.1.
 5. Only the worst data was recorded, if it complies with the limit, the other emissions deemed to comply with the limit.



RESTRICTED BANDEDGE (HIGH CHANNEL, HORIZONTAL)

PEAK

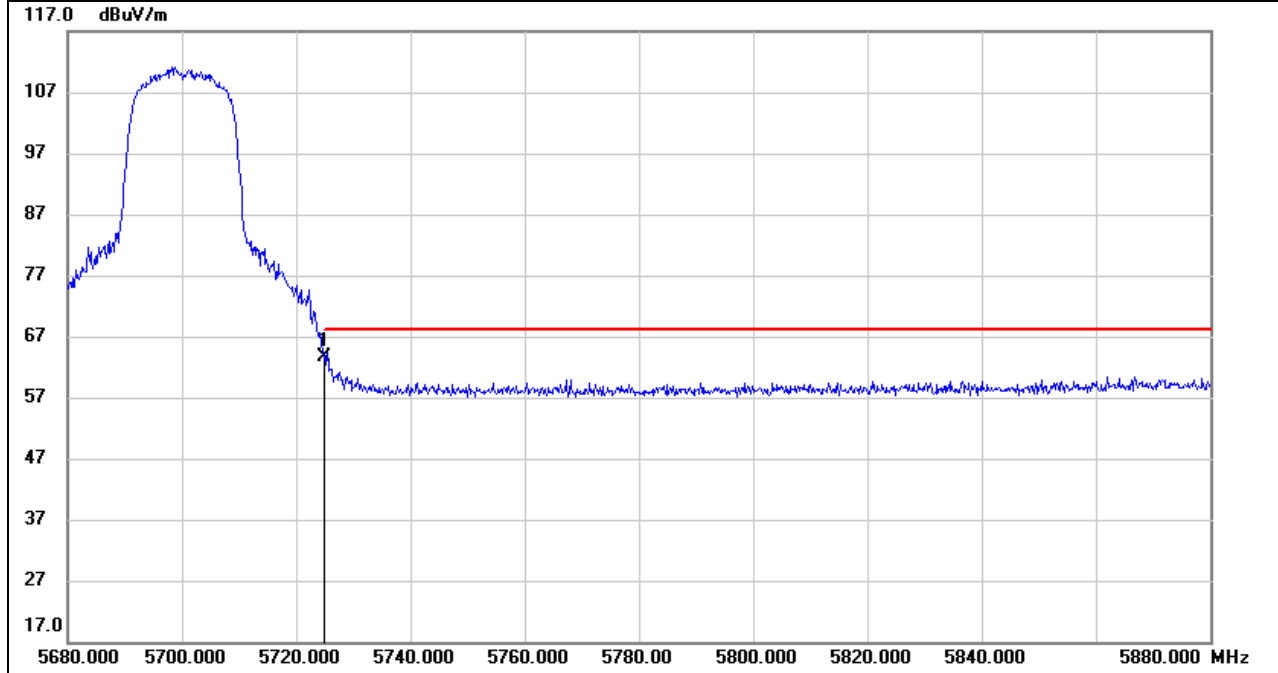

No.	Frequency (MHz)	Reading (dBuV)	Correct (dB/m)	Result (dBuV/m)	Limit (dBuV/m)	Margin (dB)	Remark
1	5725.000	22.05	41.67	63.72	68.20	-4.48	peak

- Note:
1. Measurement = Reading Level + Correct Factor.
 2. If Peak Result complies with AV limit, AV Result is deemed to comply with AV limit.
 3. Peak: Peak detector.
 4. Only the worst data was recorded, if it complies with the limit, the other emissions deemed to comply with the limit.



UNII-3 BAND

RESTRICTED BANDEDGE (LOW CHANNEL, HORIZONTAL)

PEAK

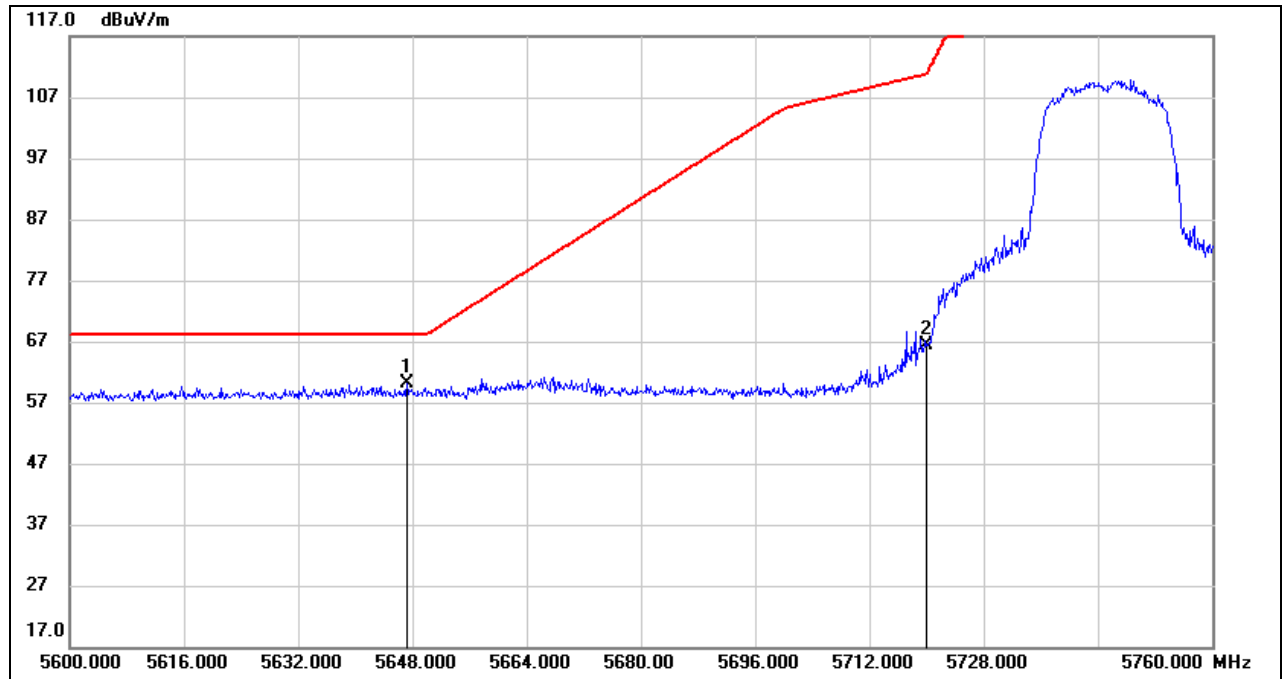

No.	Frequency (MHz)	Reading (dBuV)	Correct (dB/m)	Result (dBuV/m)	Limit (dBuV/m)	Margin (dB)	Remark
1	5647.200	18.54	41.65	60.19	68.20	-8.01	peak
2	5720.000	24.69	41.64	66.33	110.80	-44.47	peak

Note: 1. Measurement = Reading Level + Correct Factor.
 2. If Peak Result complies with AV limit, AV Result is deemed to comply with AV limit.
 3. Peak: Peak detector.
 4. Only the worst data was recorded, if it complies with the limit, the other emissions deemed to comply with the limit.



RESTRICTED BANDEDGE (HIGH CHANNEL, HORIZONTAL)

PEAK

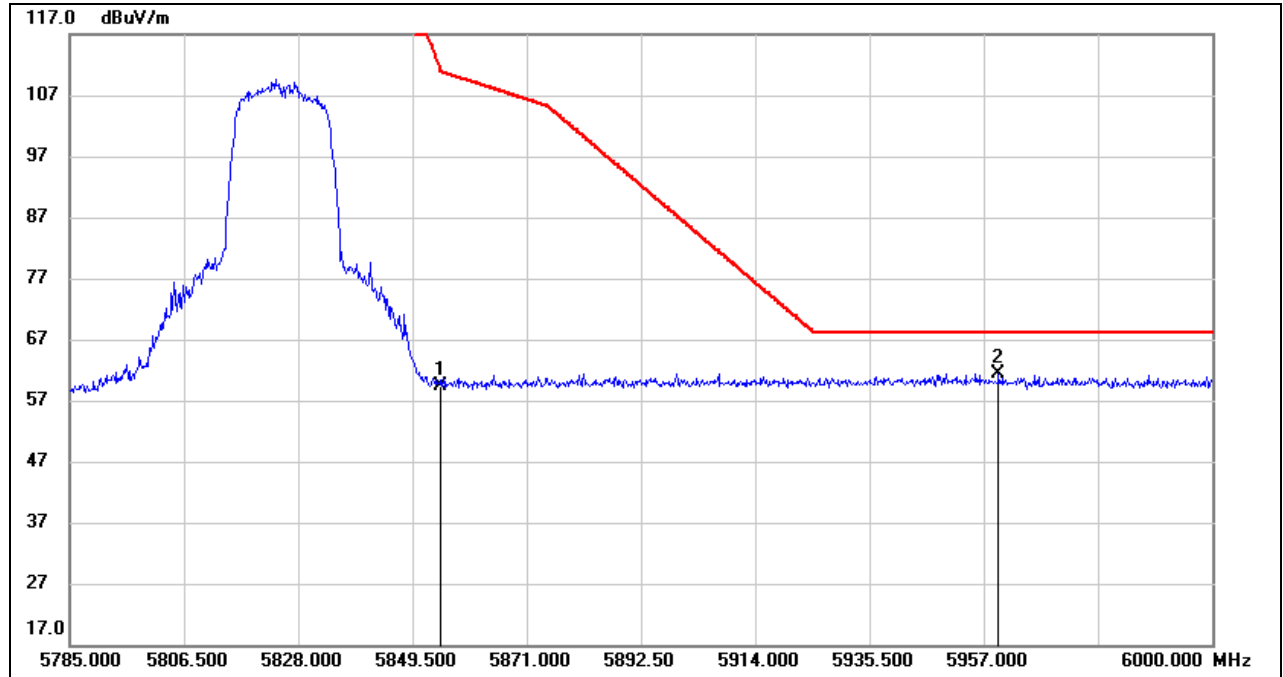

No.	Frequency (MHz)	Reading (dBuV)	Correct (dB/m)	Result (dBuV/m)	Limit (dBuV/m)	Margin (dB)	Remark
1	5855.000	16.82	42.58	59.40	110.80	-51.40	peak
2	5959.795	18.54	42.75	61.29	68.20	-6.91	peak

- Note:
1. Measurement = Reading Level + Correct Factor.
 2. If Peak Result complies with AV limit, AV Result is deemed to comply with AV limit.
 3. Peak: Peak detector.
 4. Only the worst data was recorded, if it complies with the limit, the other emissions deemed to comply with the limit.

Note: All the polarities (Vertical & Horizontal) had been tested, only the worst data was recorded in the report.

8.1.3. 802.11n HT40 MIMO MODE

UNII-1 BAND

RESTRICTED BANDEDGE (LOW CHANNEL, HORIZONTAL)

PEAK

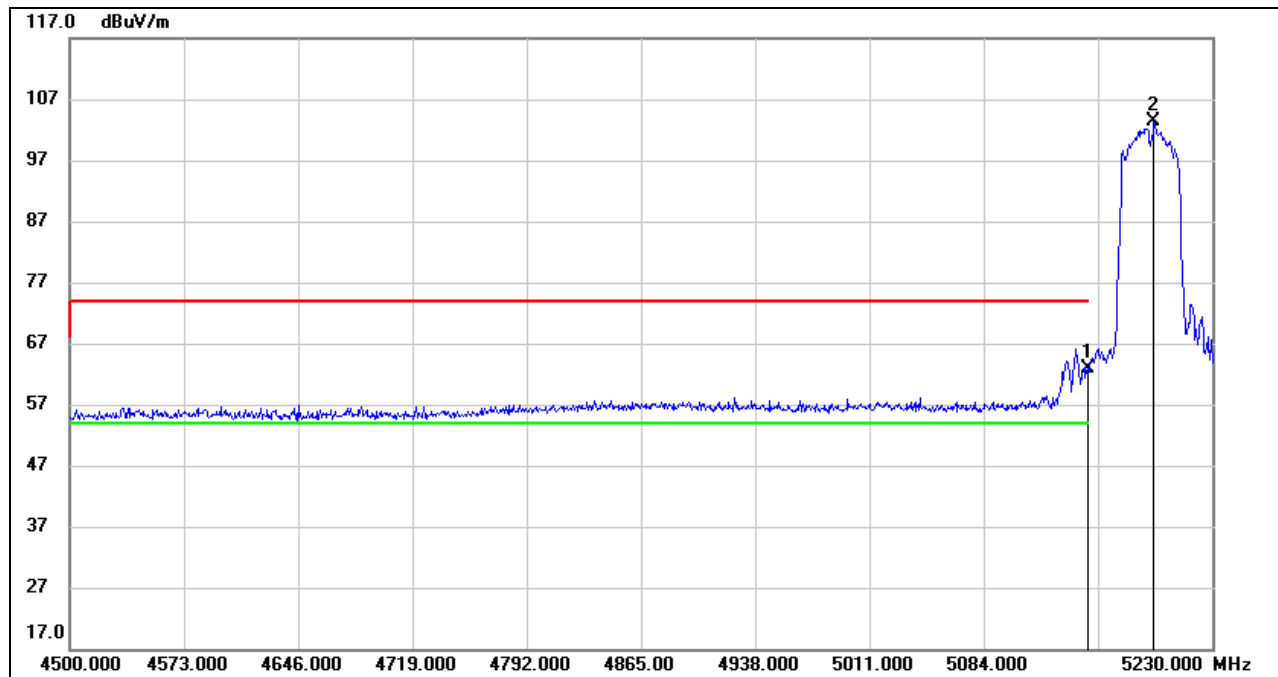

No.	Frequency (MHz)	Reading (dBuV)	Correct (dB/m)	Result (dBuV/m)	Limit (dBuV/m)	Margin (dB)	Remark
1	5150.000	21.67	41.19	62.86	74.00	-11.14	peak
2	5192.770	61.71	41.56	103.27	/	/	Fundamental

- Note: 1. Measurement = Reading Level + Correct Factor.
 2. If Peak Result complies with AV limit, AV Result is deemed to comply with AV limit.
 3. Peak: Peak detector.
 4. Only the worst data was recorded, if it complies with the limit, the other emissions deemed to comply with the limit.



AVG

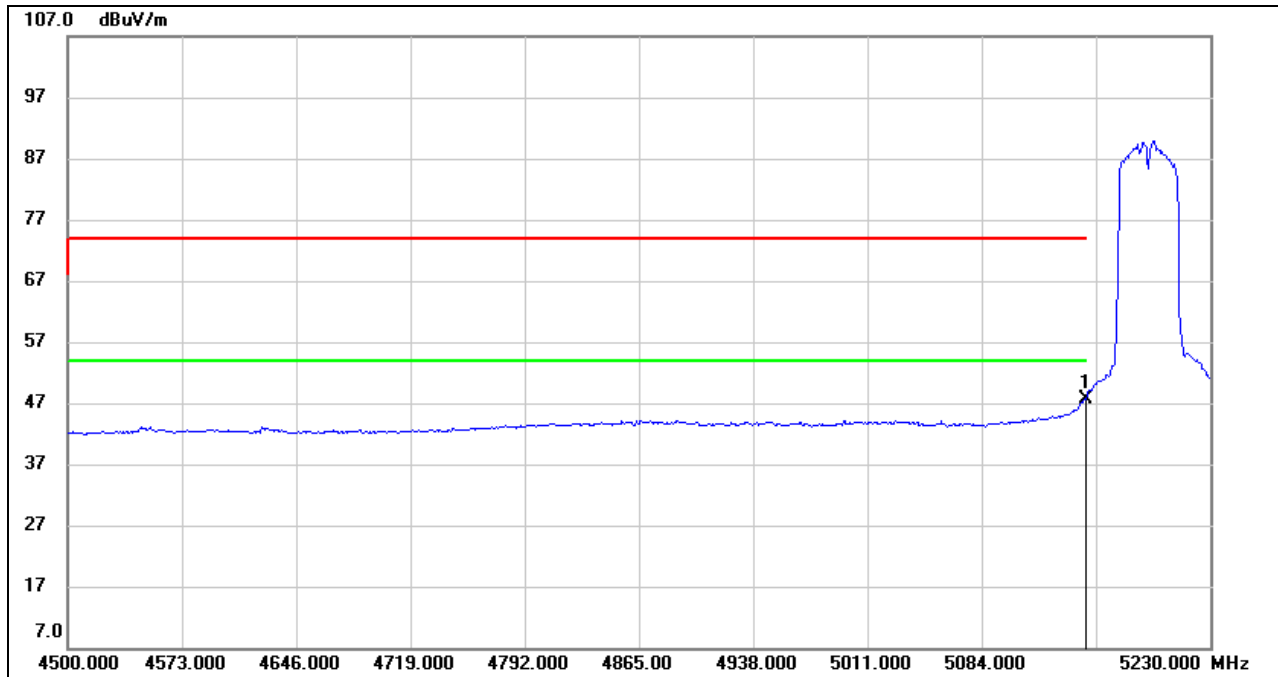

No.	Frequency (MHz)	Reading (dBuV)	Correct (dB/m)	Result (dBuV/m)	Limit (dBuV/m)	Margin (dB)	Remark
1	5150.000	6.51	41.19	47.70	54.00	-6.30	AVG

- Note:
1. Measurement = Reading Level + Correct Factor.
 2. If Peak Result complies with AV limit, AV Result is deemed to comply with AV limit.
 3. AVG: $VBW=1/Ton$, where: Ton is the transmitting duration.
 4. For the transmitting duration, please refer to clause 7.1.
 5. Only the worst data was recorded, if it complies with the limit, the other emissions deemed to comply with the limit.

UNII-2A BAND

RESTRICTED BANDEDGE (HIGH CHANNEL, HORIZONTAL)

PEAK

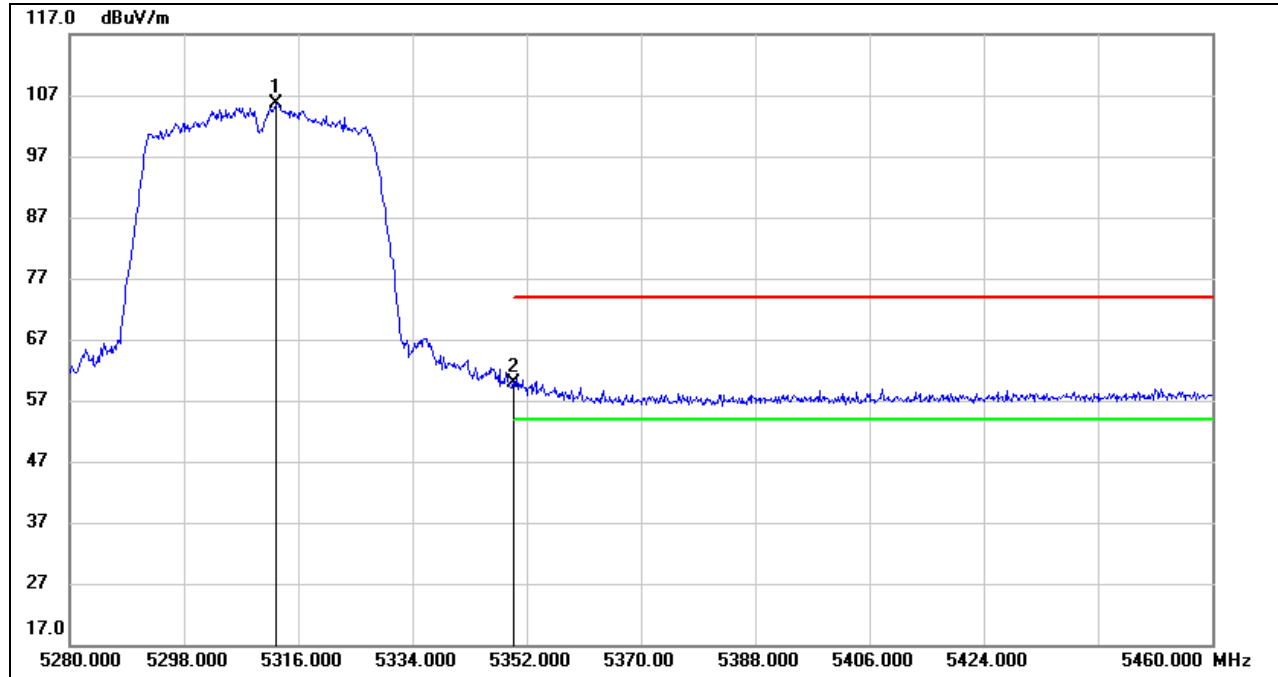

No.	Frequency (MHz)	Reading (dBuV)	Correct (dB/m)	Result (dBuV/m)	Limit (dBuV/m)	Margin (dB)	Remark
1	5312.580	64.53	41.00	105.53	/	/	Fundamental
2	5350.000	18.65	41.20	59.85	74.00	-14.15	peak

- Note:
1. Measurement = Reading Level + Correct Factor.
 2. If Peak Result complies with AV limit, AV Result is deemed to comply with AV limit.
 3. Peak: Peak detector.
 4. Only the worst data was recorded, if it complies with the limit, the other emissions deemed to comply with the limit.



AVG

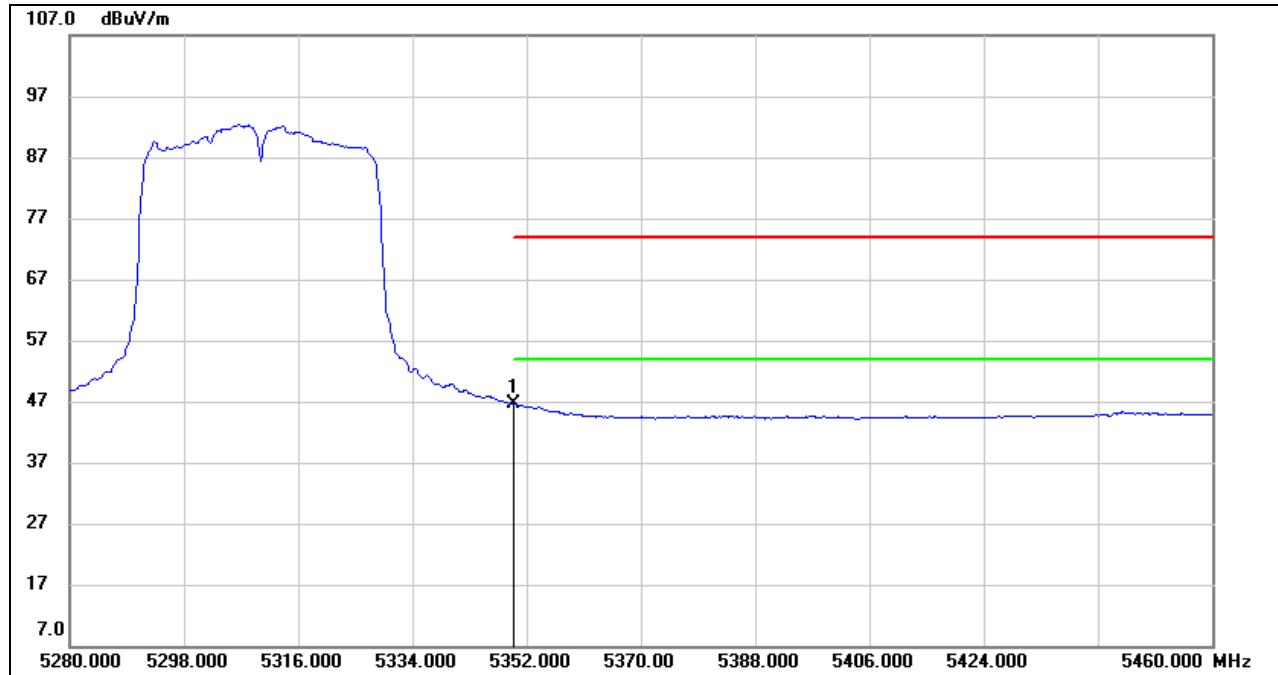

No.	Frequency (MHz)	Reading (dBuV)	Correct (dB/m)	Result (dBuV/m)	Limit (dBuV/m)	Margin (dB)	Remark
1	5350.000	5.33	41.20	46.53	54.00	-7.47	AVG

- Note:
1. Measurement = Reading Level + Correct Factor.
 2. If Peak Result complies with AV limit, AV Result is deemed to comply with AV limit.
 3. AVG: $VBW=1/Ton$, where: Ton is the transmitting duration.
 4. For the transmitting duration, please refer to clause 7.1.
 5. Only the worst data was recorded, if it complies with the limit, the other emissions deemed to comply with the limit.

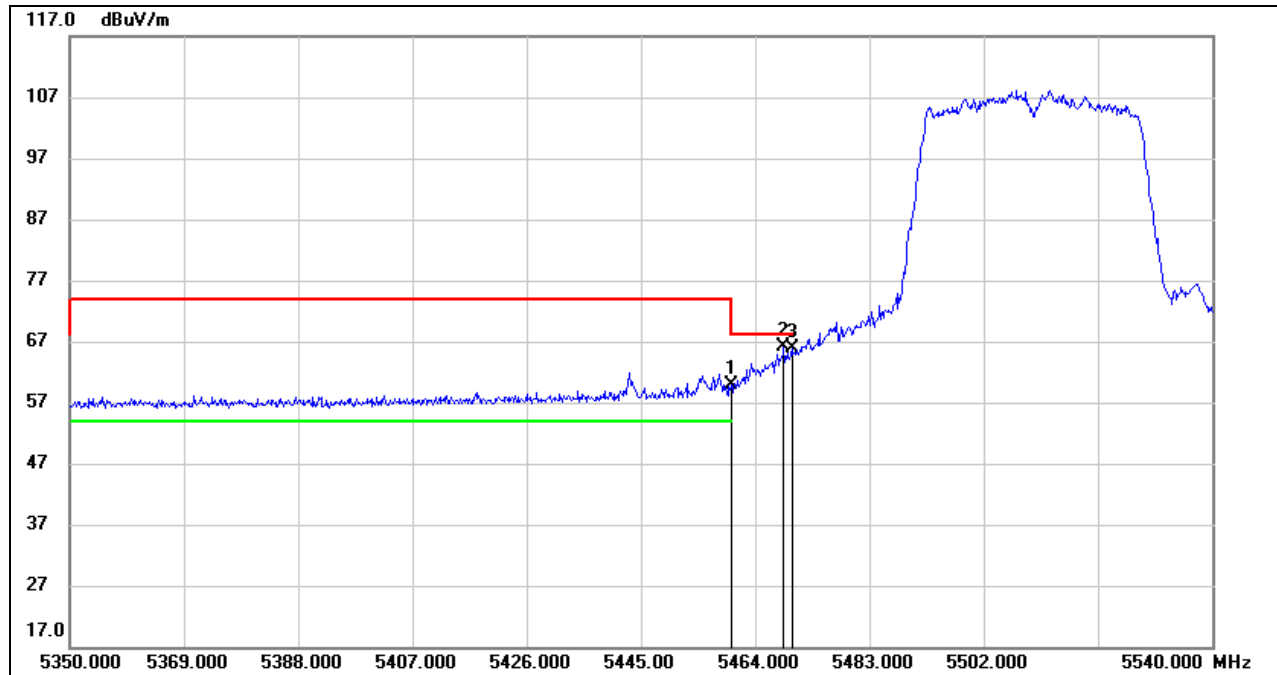
**UNII-2C BAND****RESTRICTED BANDEDGE (LOW CHANNEL, HORIZONTAL)****PEAK**

No.	Frequency (MHz)	Reading (dBuV)	Correct (dB/m)	Result (dBuV/m)	Limit (dBuV/m)	Margin (dB)	Remark
1	5460.000	18.12	41.82	59.94	68.20	-8.26	peak
2	5468.750	24.19	41.87	66.06	68.20	-2.14	peak
3	5470.000	24.13	41.87	66.00	68.20	-2.20	peak

Note: 1. Measurement = Reading Level + Correct Factor.

2. If Peak Result complies with AV limit, AV Result is deemed to comply with AV limit.

3. Peak: Peak detector.

4. Only the worst data was recorded, if it complies with the limit, the other emissions deemed to comply with the limit.



AVG

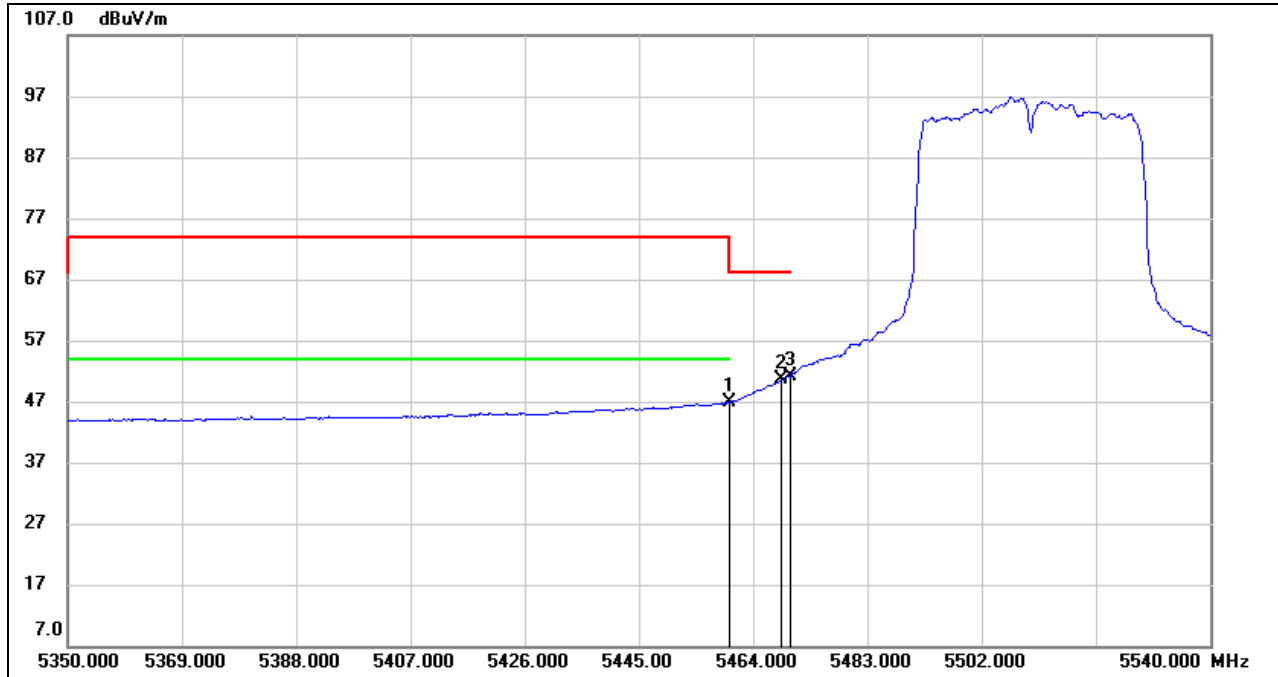

No.	Frequency (MHz)	Reading (dBuV)	Correct (dB/m)	Result (dBuV/m)	Limit (dBuV/m)	Margin (dB)	Remark
1	5460.000	5.06	41.82	46.88	/	/	AVG
2	5468.750	8.81	41.87	50.68	68.20	-17.52	AVG
3	5470.000	9.38	41.87	51.25	/	/	AVG

- Note:
1. Measurement = Reading Level + Correct Factor.
 2. If Peak Result complies with AV limit, AV Result is deemed to comply with AV limit.
 3. AVG: $VBW=1/T_{on}$, where: T_{on} is the transmitting duration.
 4. For the transmitting duration, please refer to clause 7.1.
 5. Only the worst data was recorded, if it complies with the limit, the other emissions deemed to comply with the limit.

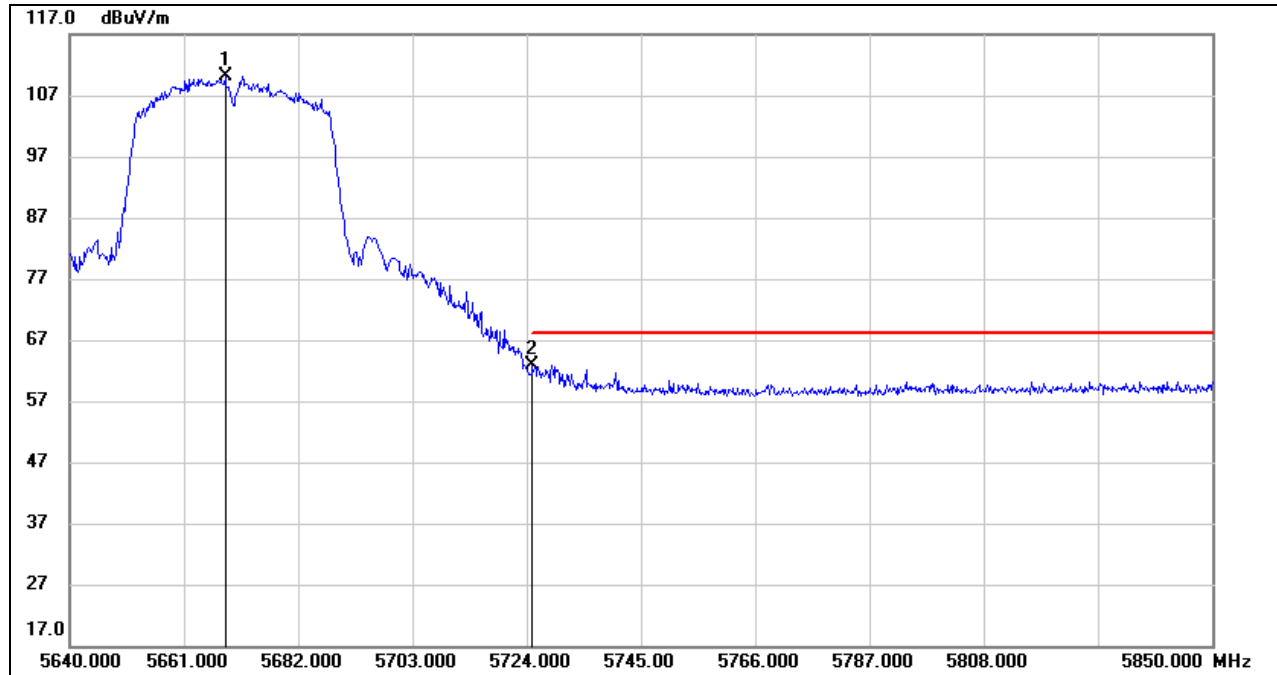
**RESTRICTED BANDEDGE (HIGH CHANNEL, HORIZONTAL)****PEAK**

No.	Frequency (MHz)	Reading (dBuV)	Correct (dB/m)	Result (dBuV/m)	Limit (dBuV/m)	Margin (dB)	Remark
1	5668.560	68.62	41.60	110.22	/	/	Fundamental
2	5725.000	21.11	41.67	62.78	68.20	-5.42	peak

- Note: 1. Measurement = Reading Level + Correct Factor.
 2. If Peak Result complies with AV limit, AV Result is deemed to comply with AV limit.
 3. Peak: Peak detector.
 4. Only the worst data was recorded, if it complies with the limit, the other emissions deemed to comply with the limit.

UNII-3 BAND

RESTRICTED BANDEDGE (LOW CHANNEL, HORIZONTAL)

PEAK

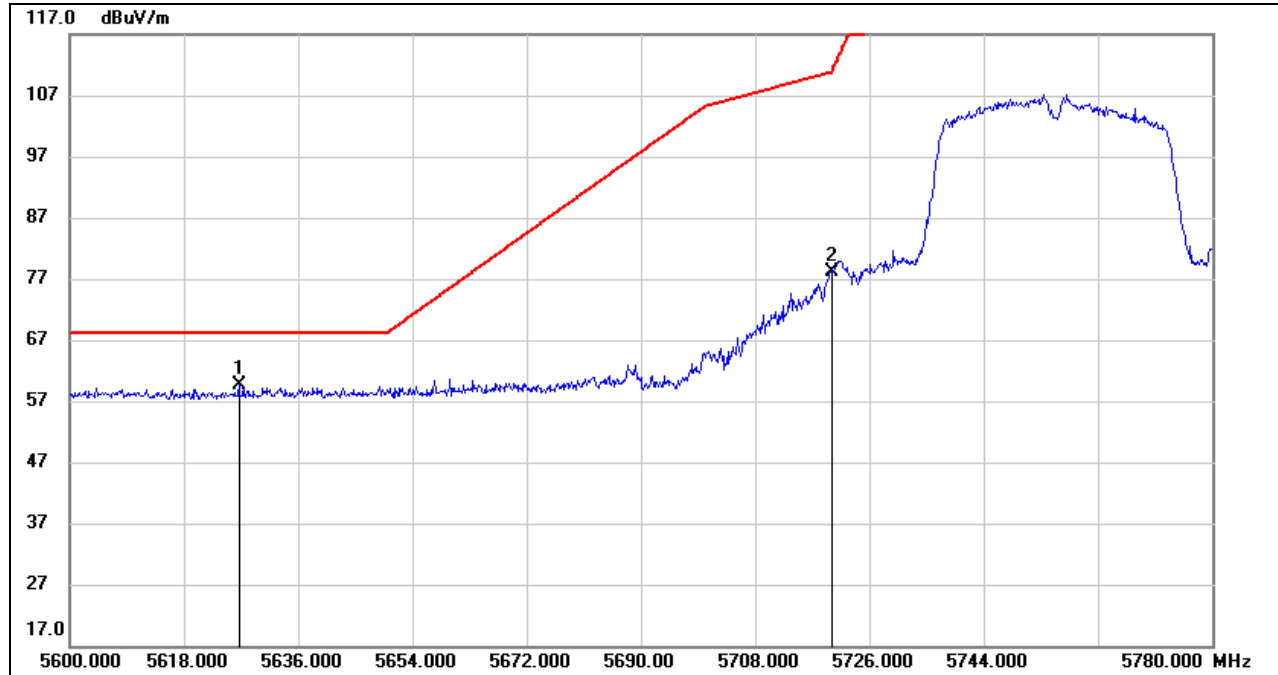

No.	Frequency (MHz)	Reading (dBuV)	Correct (dB/m)	Result (dBuV/m)	Limit (dBuV/m)	Margin (dB)	Remark
1	5626.640	18.07	41.68	59.75	68.20	-8.45	peak
2	5720.000	36.58	41.64	78.22	110.80	-32.58	peak

- Note:
1. Measurement = Reading Level + Correct Factor.
 2. If Peak Result complies with AV limit, AV Result is deemed to comply with AV limit.
 3. Peak: Peak detector.
 4. Only the worst data was recorded, if it complies with the limit, the other emissions deemed to comply with the limit.

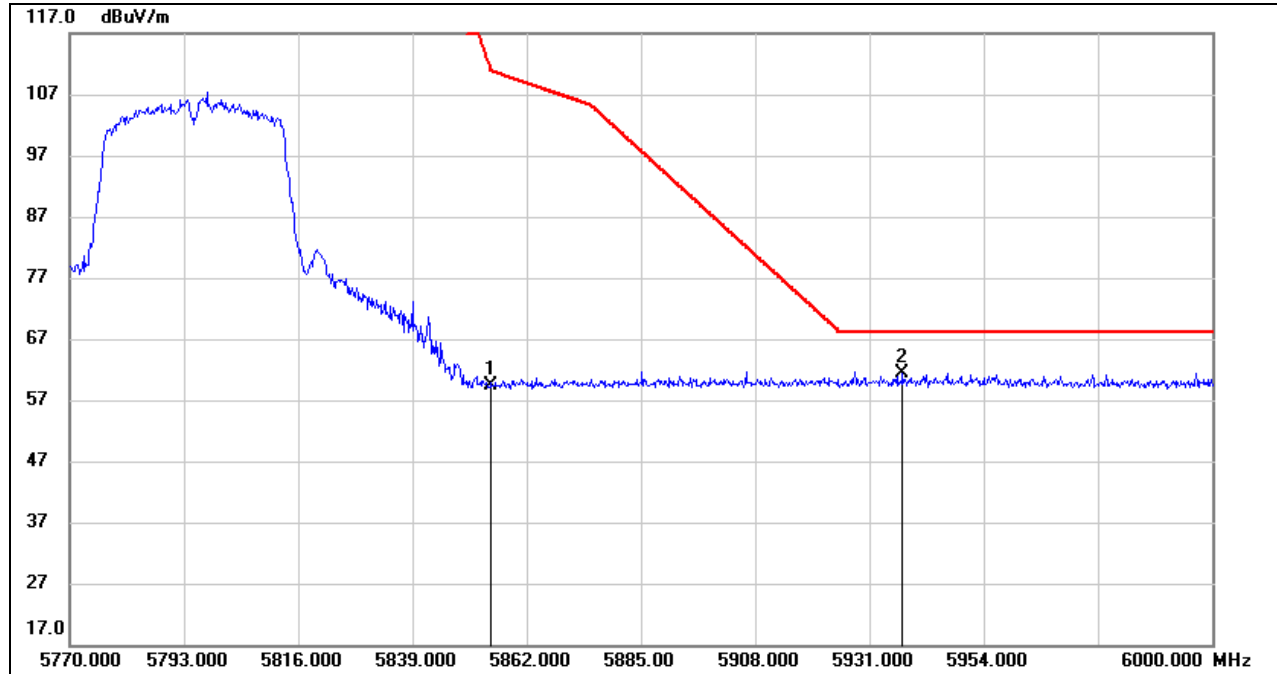
**RESTRICTED BANDEDGE (HIGH CHANNEL, HORIZONTAL)****PEAK**

No.	Frequency (MHz)	Reading (dBuV)	Correct (dB/m)	Result (dBuV/m)	Limit (dBuV/m)	Margin (dB)	Remark
1	5855.000	16.85	42.58	59.43	110.80	-51.37	peak
2	5937.670	18.45	42.86	61.31	68.20	-6.89	peak

Note: 1. Measurement = Reading Level + Correct Factor.

2. If Peak Result complies with AV limit, AV Result is deemed to comply with AV limit.

3. Peak: Peak detector.

4. Only the worst data was recorded, if it complies with the limit, the other emissions deemed to comply with the limit.

Note: All the polarities (Vertical & Horizontal) had been tested, only the worst data was recorded in the report.



8.1.4. 802.11ac VHT80 MIMO MODE

UNII-1 BAND

RESTRICTED BANDEDGE (LOW CHANNEL, HORIZONTAL)

PEAK

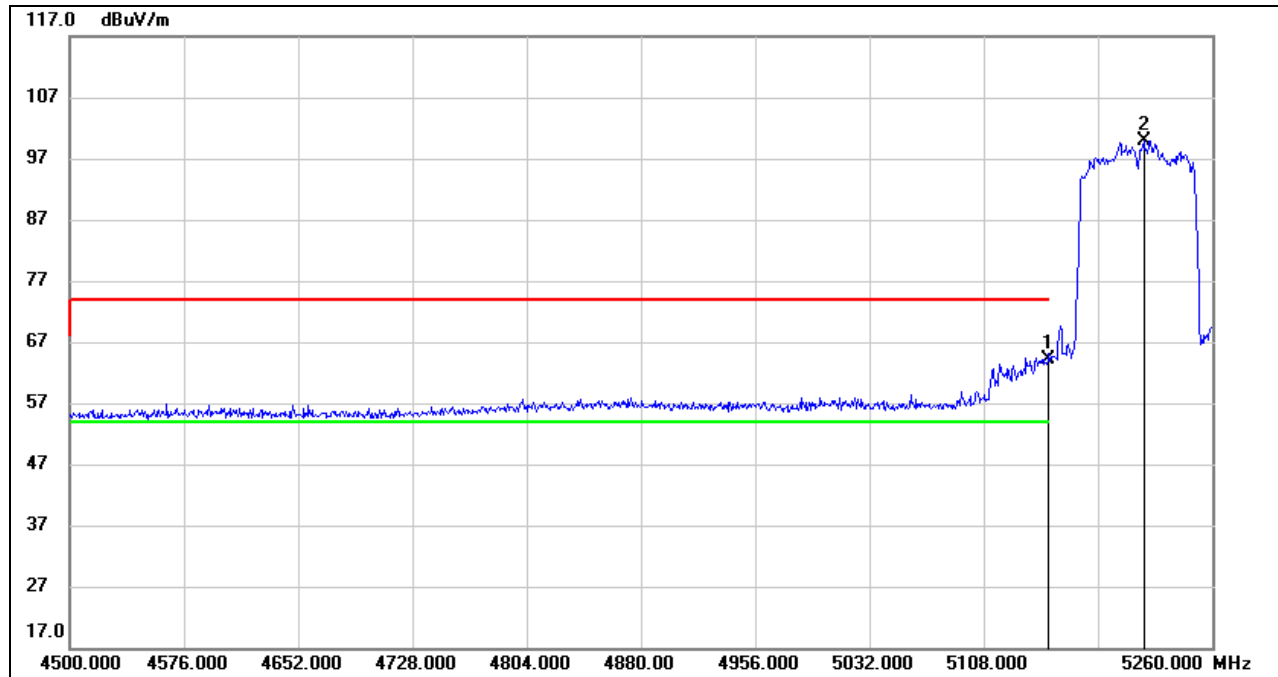

No.	Frequency (MHz)	Reading (dBuV)	Correct (dB/m)	Result (dBuV/m)	Limit (dBuV/m)	Margin (dB)	Remark
1	5150.000	22.83	41.19	64.02	74.00	-9.98	peak
2	5214.400	58.44	41.52	99.96	/	/	Fundamental

- Note:
1. Measurement = Reading Level + Correct Factor.
 2. If Peak Result complies with AV limit, AV Result is deemed to comply with AV limit.
 3. Peak: Peak detector.
 4. Only the worst data was recorded, if it complies with the limit, the other emissions deemed to comply with the limit.



AVG

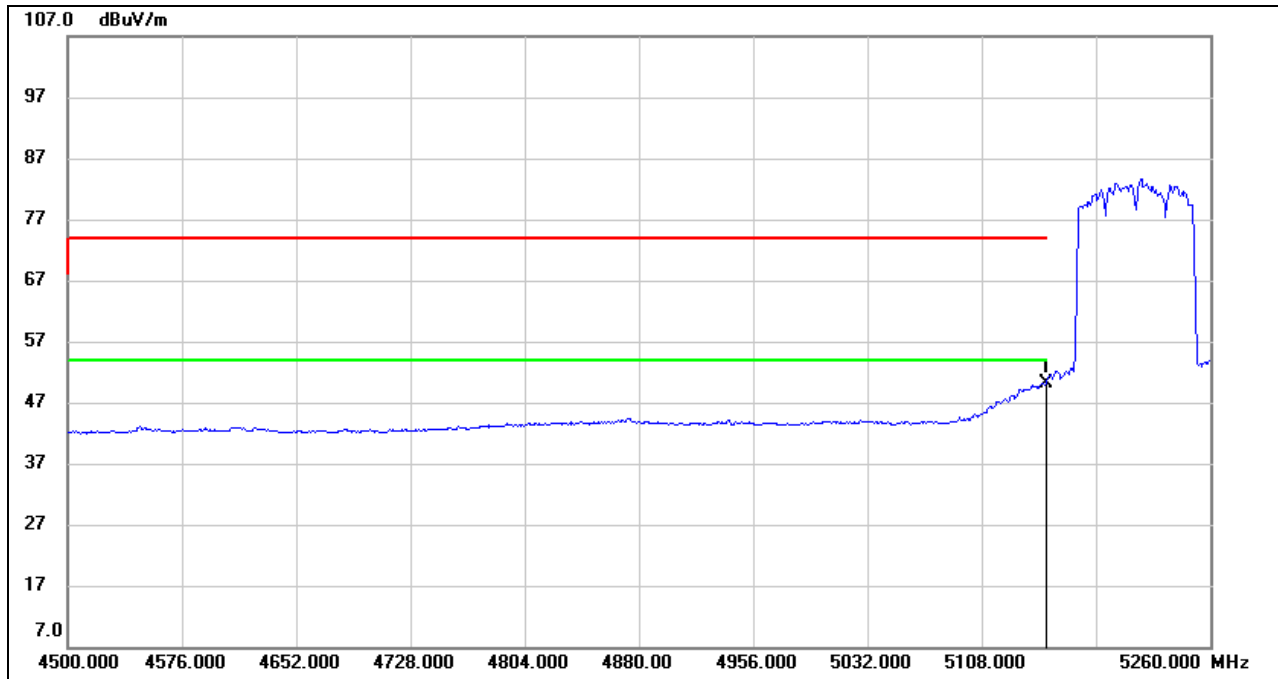

No.	Frequency (MHz)	Reading (dBuV)	Correct (dB/m)	Result (dBuV/m)	Limit (dBuV/m)	Margin (dB)	Remark
1	5150.000	9.02	41.19	50.21	54.00	-3.79	AVG

- Note:
1. Measurement = Reading Level + Correct Factor.
 2. If Peak Result complies with AV limit, AV Result is deemed to comply with AV limit.
 3. AVG: $VBW=1/Ton$, where: Ton is the transmitting duration.
 4. For the transmitting duration, please refer to clause 7.1.
 5. Only the worst data was recorded, if it complies with the limit, the other emissions deemed to comply with the limit.

UNII-2A BAND

RESTRICTED BANDEDGE (LOW CHANNEL, HORIZONTAL)

PEAK

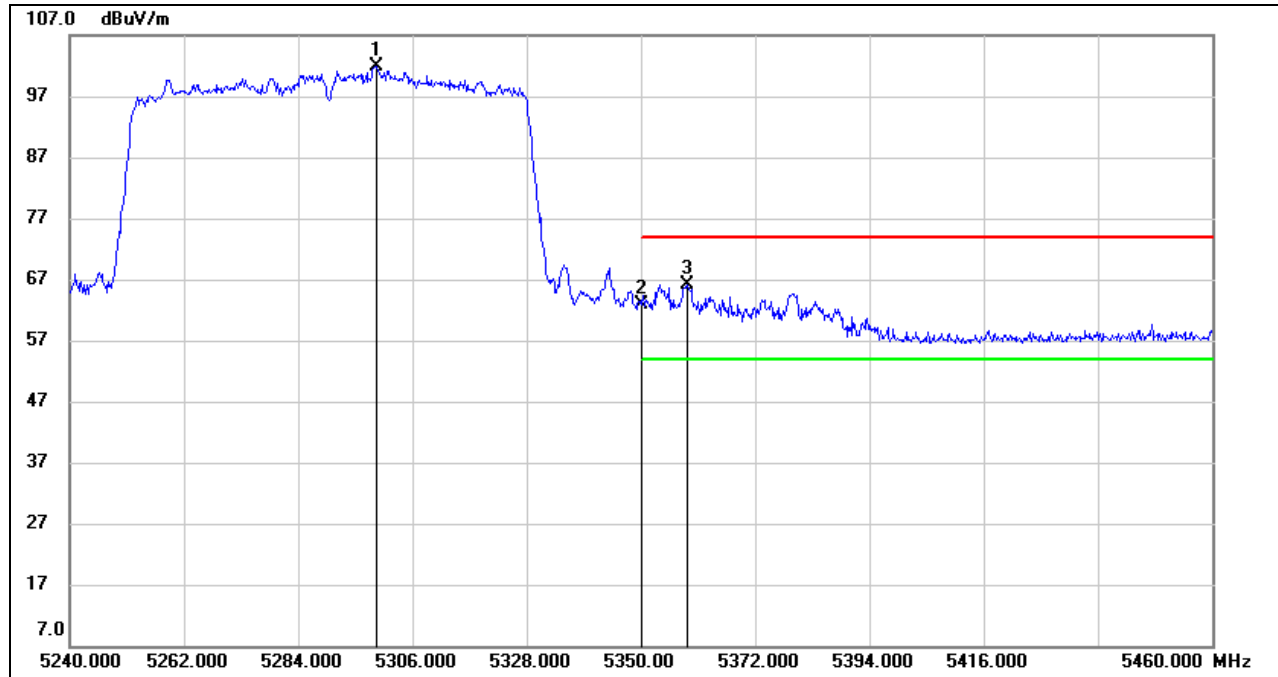

No.	Frequency (MHz)	Reading (dBuV)	Correct (dB/m)	Result (dBuV/m)	Limit (dBuV/m)	Margin (dB)	Remark
1	5298.960	60.96	40.94	101.90	/	/	Fundamental
2	5350.000	21.77	41.20	62.97	74.00	-11.03	peak
3	5358.800	24.98	41.25	66.23	74.00	-7.77	peak

Note: 1. Measurement = Reading Level + Correct Factor.
 2. If Peak Result complies with AV limit, AV Result is deemed to comply with AV limit.
 3. Peak: Peak detector.
 4. Only the worst data was recorded, if it complies with the limit, the other emissions deemed to comply with the limit.



AVG

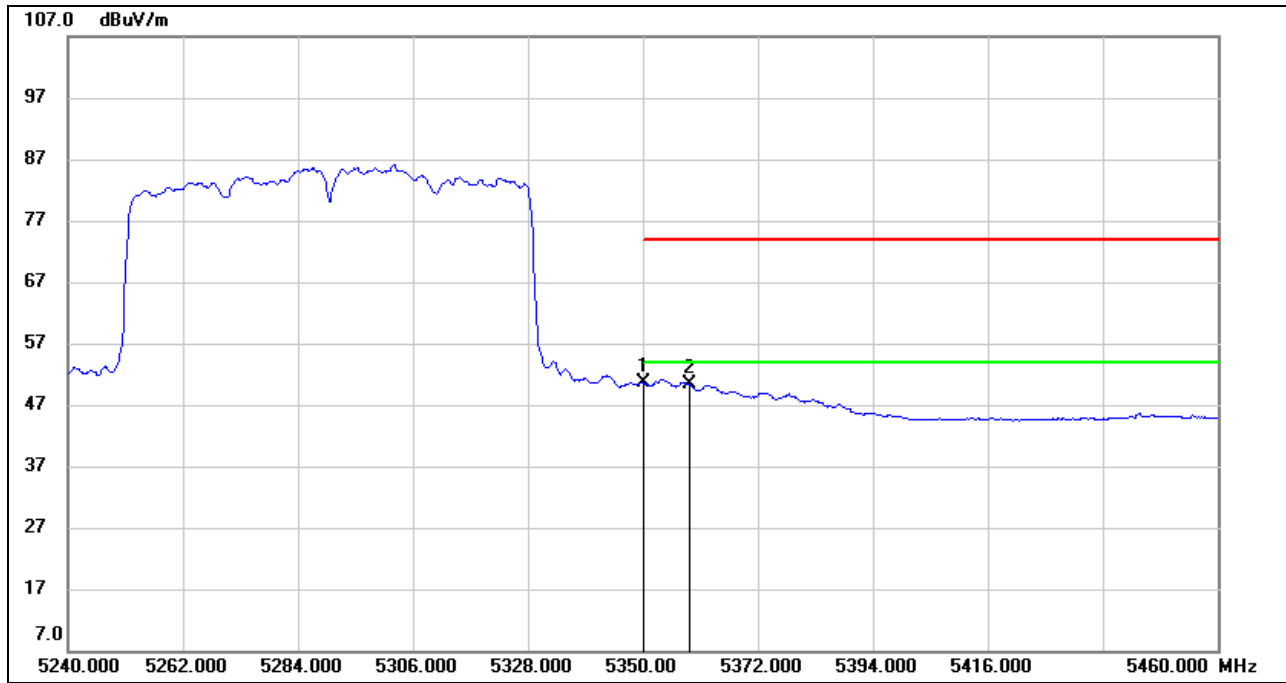

No.	Frequency (MHz)	Reading (dBuV)	Correct (dB/m)	Result (dBuV/m)	Limit (dBuV/m)	Margin (dB)	Remark
1	5350.000	9.38	41.20	50.58	54.00	-3.42	AVG
2	5358.800	9.23	41.25	50.48	54.00	-3.52	AVG

- Note: 1. Measurement = Reading Level + Correct Factor
 2. AVG: VBW=1/Ton where: ton is transmit duration.
 3. For duty cycle, please refer to clause 7.1.
 4. Only the worst case emission will be recorder, if it complies with the limit, the other emissions deemed to comply with the limit.



UNII-2C BAND

RESTRICTED BANDEDGE (LOW CHANNEL, HORIZONTAL)

PEAK

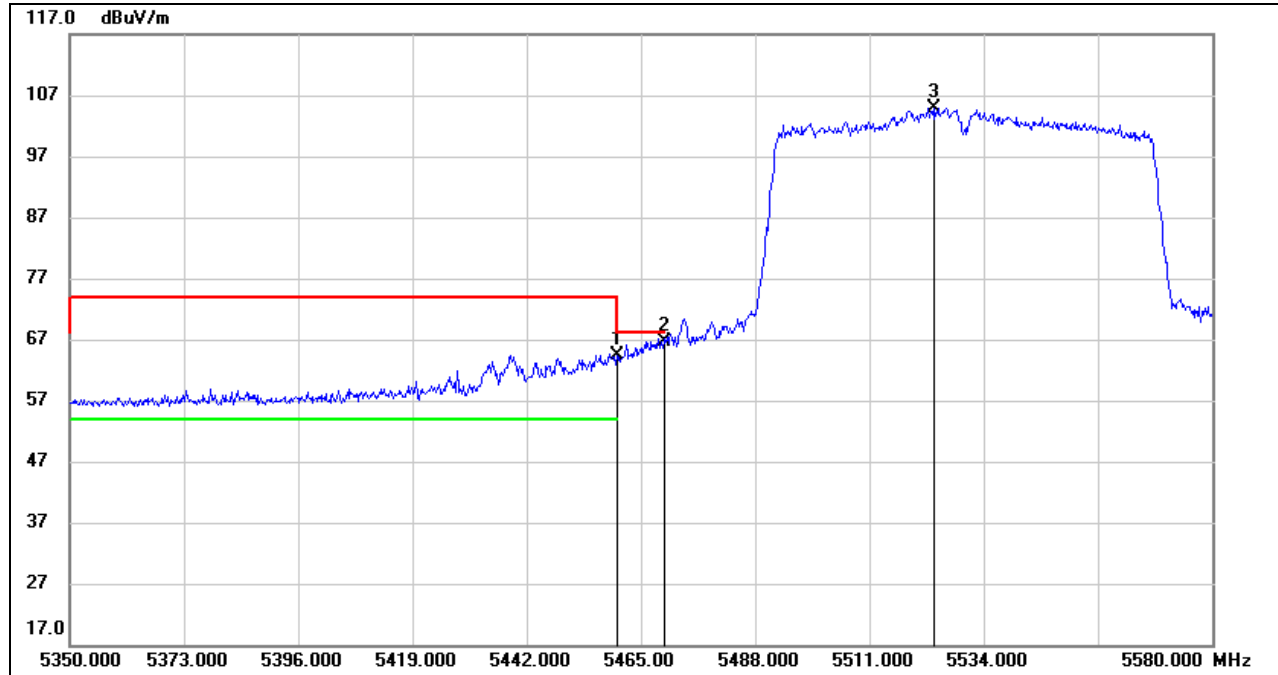

No.	Frequency (MHz)	Reading (dBuV)	Correct (dB/m)	Result (dBuV/m)	Limit (dBuV/m)	Margin (dB)	Remark
1	5460.000	22.57	41.82	64.39	68.20	-3.81	peak
2	5470.000	24.72	41.87	66.59	68.20	-1.61	peak
3	5524.110	62.93	41.97	104.90	/	/	Fundamental

- Note: 1. Measurement = Reading Level + Correct Factor.
 2. If Peak Result complies with AV limit, AV Result is deemed to comply with AV limit.
 3. Peak: Peak detector.
 4. Only the worst data was recorded, if it complies with the limit, the other emissions deemed to comply with the limit.



AVG

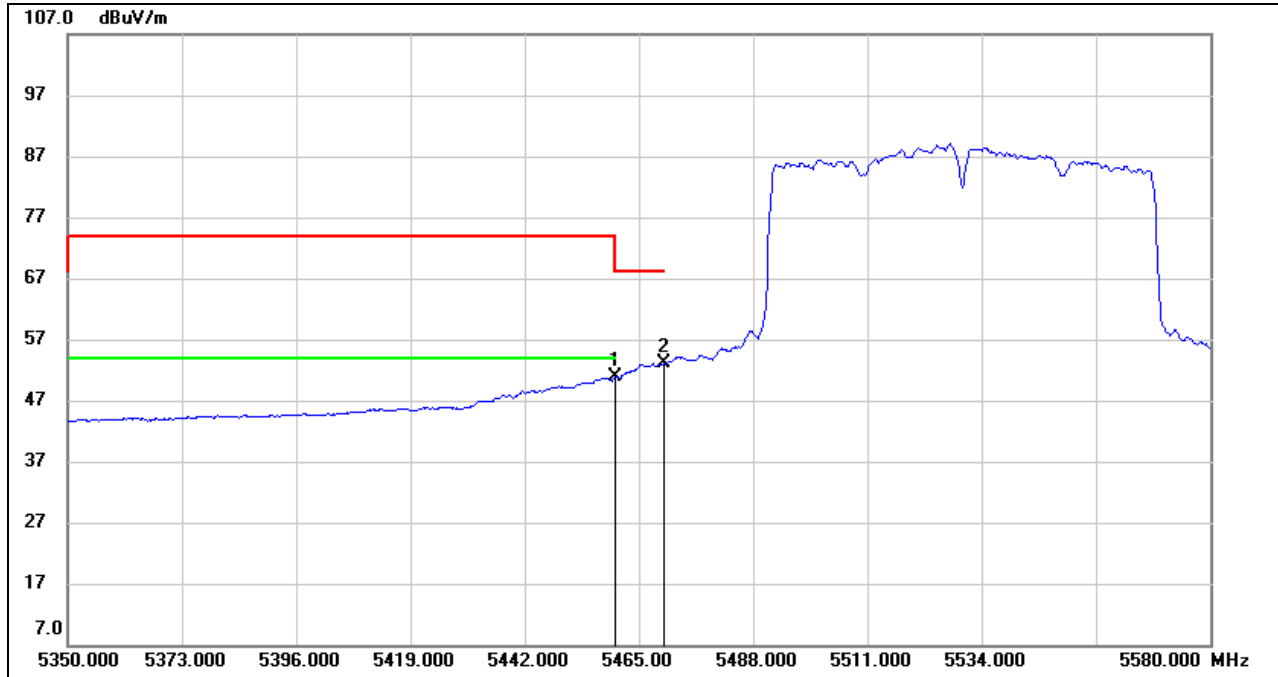

No.	Frequency (MHz)	Reading (dBuV)	Correct (dB/m)	Result (dBuV/m)	Limit (dBuV/m)	Margin (dB)	Remark
1	5460.000	8.97	41.82	50.79	/	/	AVG
2	5470.000	11.20	41.87	53.07	/	/	AVG

Note: 1. Measurement = Reading Level + Correct Factor.
 2. If Peak Result complies with AV limit, AV Result is deemed to comply with AV limit.
 3. AVG: $VBW=1/T_{on}$, where: T_{on} is the transmitting duration.
 4. For the transmitting duration, please refer to clause 7.1.
 5. Only the worst data was recorded, if it complies with the limit, the other emissions deemed to comply with the limit.

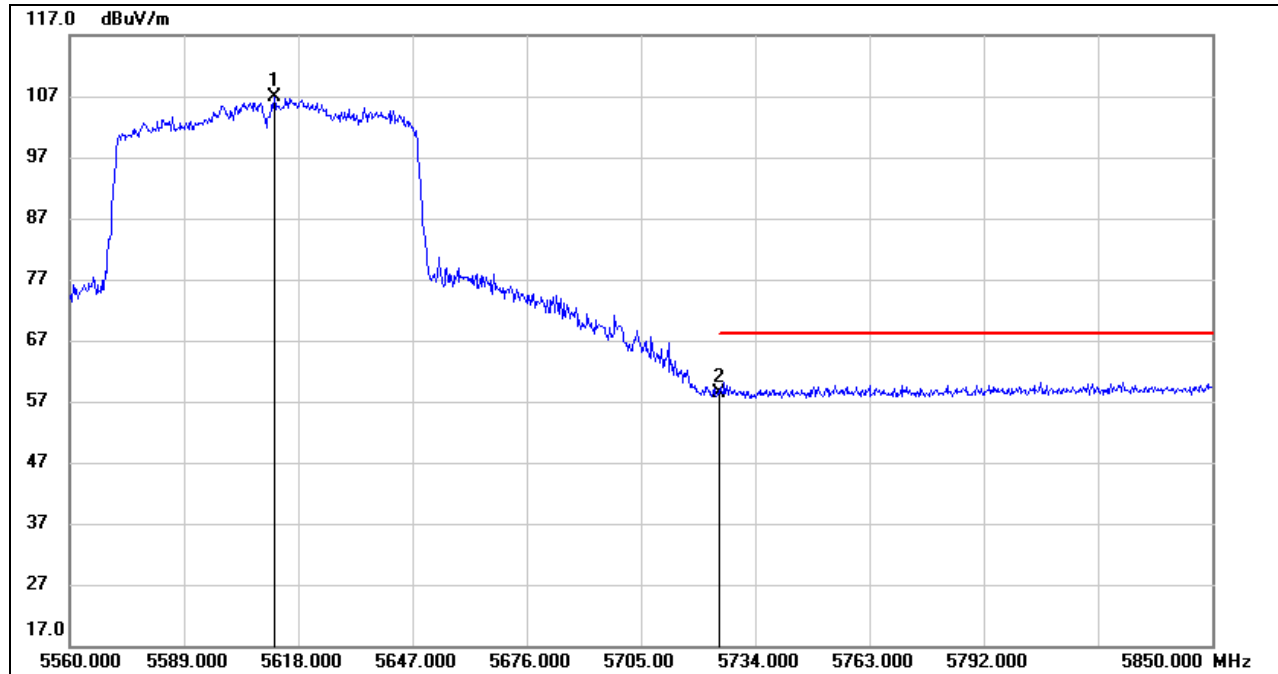
**RESTRICTED BANDEDGE (HIGH CHANNEL, HORIZONTAL)****PEAK**

No.	Frequency (MHz)	Reading (dBuV)	Correct (dB/m)	Result (dBuV/m)	Limit (dBuV/m)	Margin (dB)	Remark
1	5611.910	65.25	41.70	106.95	/	/	Fundamental
2	5725.000	16.67	41.67	58.34	68.20	-9.86	peak

Note: 1. Measurement = Reading Level + Correct Factor.

2. If Peak Result complies with AV limit, AV Result is deemed to comply with AV limit.

3. Peak: Peak detector.

4. Only the worst data was recorded, if it complies with the limit, the other emissions deemed to comply with the limit.

UNII-3 BAND

RESTRICTED BANDEDGE (LOW CHANNEL, HORIZONTAL)

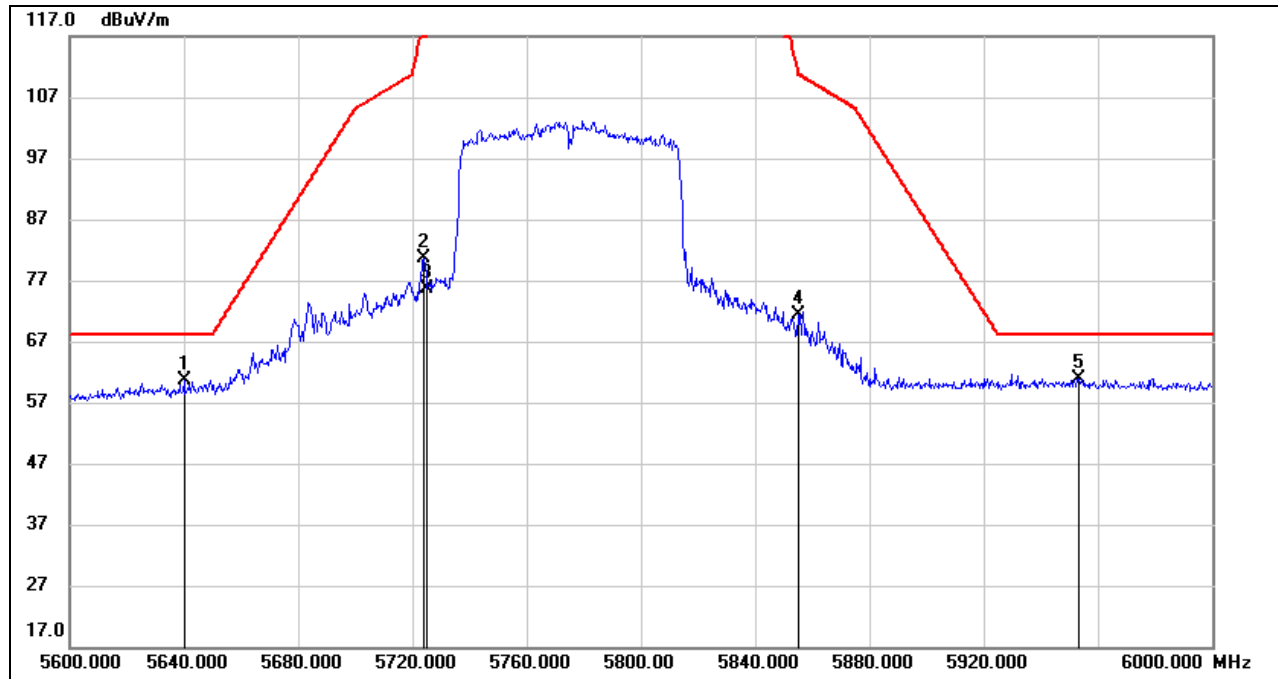

No.	Frequency (MHz)	Reading (dBuV)	Correct (dB/m)	Result (dBuV/m)	Limit (dBuV/m)	Margin (dB)	Remark
1	5640.000	18.99	41.66	60.65	68.20	-7.55	peak
2	5724.000	38.97	41.66	80.63	119.92	-39.29	peak
3	5725.000	34.00	41.67	75.67	122.20	-46.53	peak
4	5855.000	28.89	42.58	71.47	110.80	-39.33	peak
5	5953.200	18.15	42.78	60.93	68.20	-7.27	peak

Note: 1. Measurement = Reading Level + Correct Factor.
 2. If Peak Result complies with AV limit, AV Result is deemed to comply with AV limit.
 3. Peak: Peak detector.
 4. Only the worst data was recorded, if it complies with the limit, the other emissions deemed to comply with the limit.

8.2. SPURIOUS EMISSIONS (1 GHz ~ 7 GHz)

8.2.1. 802.11n HT20 MIMO MODE

UNII-1 BAND

MIMO MODE TEST RESULTS (WORST CASE)

HARMONICS AND SPURIOUS EMISSIONS (LOW CHANNEL, HORIZONTAL)

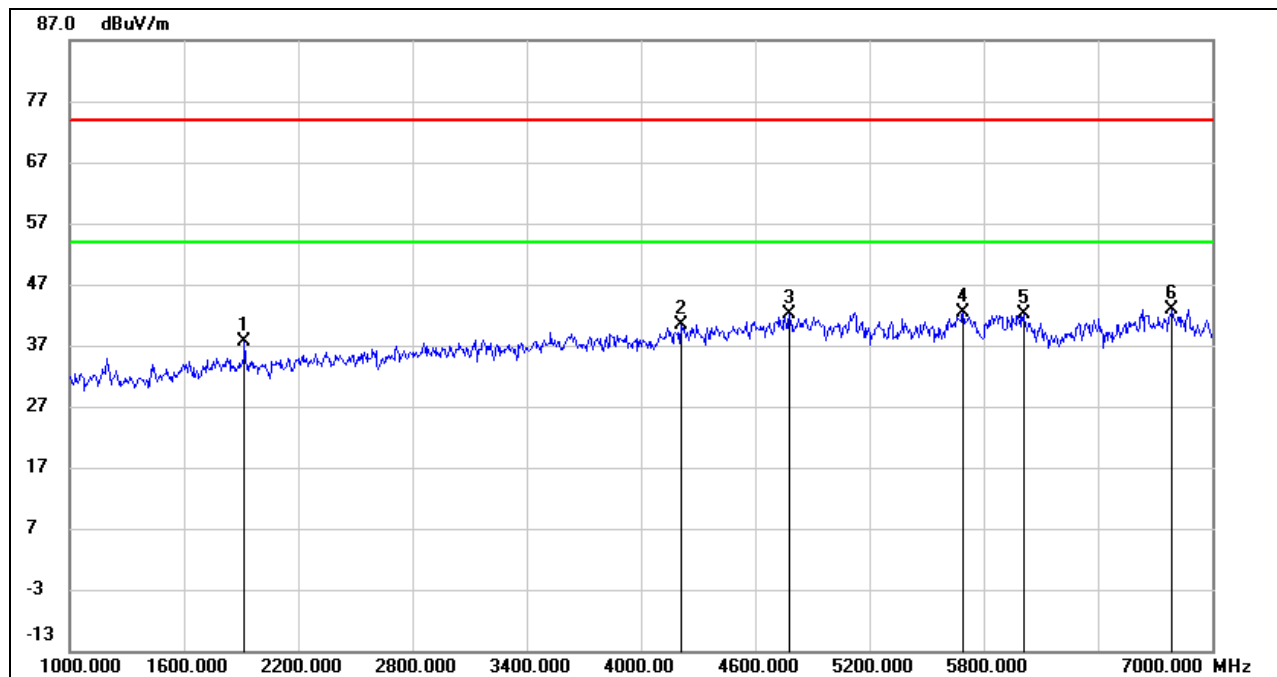

No.	Frequency (MHz)	Reading (dBuV)	Correct (dB/m)	Result (dBuV/m)	Limit (dBuV/m)	Margin (dB)	Remark
1	1918.000	47.83	-10.13	37.70	74.00	-36.30	peak
2	4210.000	42.16	-1.67	40.49	74.00	-33.51	peak
3	4780.000	41.77	0.48	42.25	74.00	-31.75	peak
4	5692.000	39.79	2.47	42.26	74.00	-31.74	peak
5	6010.000	38.75	3.31	42.06	74.00	-31.94	peak
6	6790.000	37.42	5.57	42.99	74.00	-31.01	peak

- Note: 1. Measurement = Reading Level + Correct Factor.
 2. If Peak Result complies with AV limit, AV Result is deemed to comply with AV limit.
 3. Peak: Peak detector.
 4. Filter losses were only considered in the spurious frequency bands and the authorized band was not corrected for Band reject filter losses.
 5. Proper operation of the transmitter prior to adding the filter to the measurement chain.
 6. Since non-restricted band peak emissions are less than the average limit, they also comply with the -27dBm/MHz (68.2dBuV/m) limit.

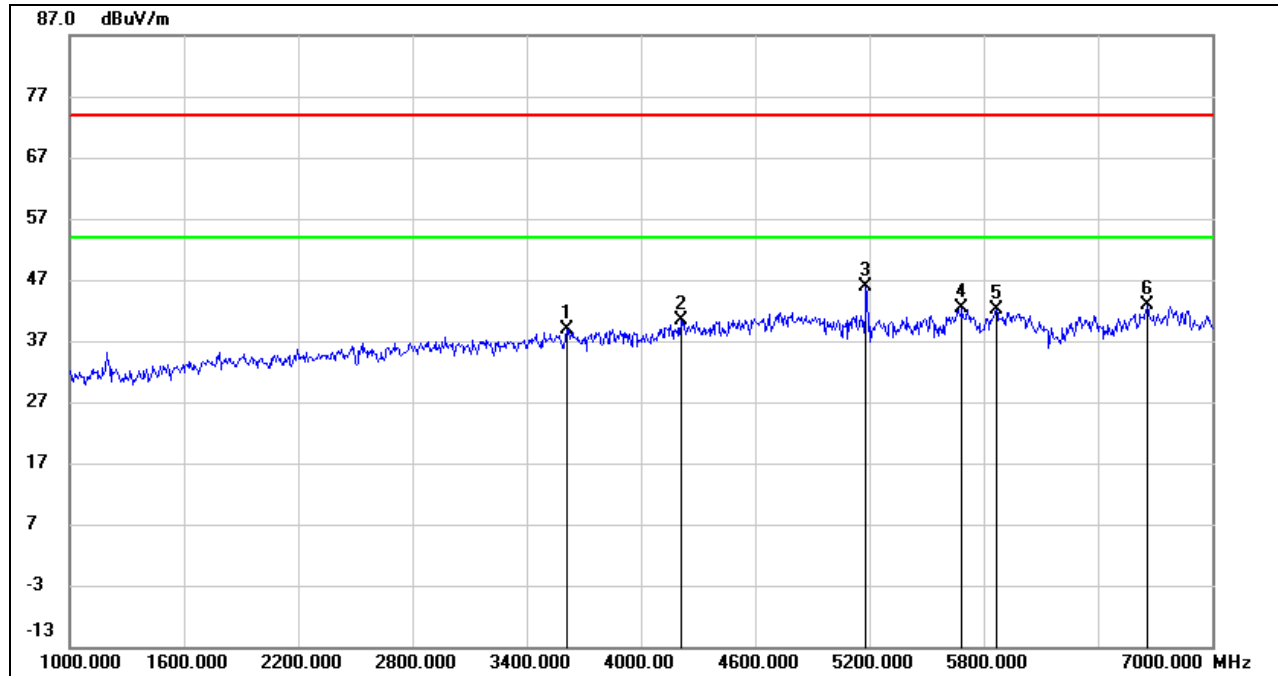
**HARMONICS AND SPURIOUS EMISSIONS (LOW CHANNEL, VERTICAL)**

No.	Frequency (MHz)	Reading (dBuV)	Correct (dB/m)	Result (dBuV/m)	Limit (dBuV/m)	Margin (dB)	Remark
1	3610.000	43.06	-4.14	38.92	74.00	-35.08	peak
2	4210.000	42.05	-1.67	40.38	74.00	-33.62	peak
3	5180.000	43.89	1.99	45.88	74.00	-28.12	peak
4	5686.000	39.82	2.47	42.29	74.00	-31.71	peak
5	5866.000	39.31	2.77	42.08	74.00	-31.92	peak
6	6658.000	37.45	5.51	42.96	74.00	-31.04	peak

Note: 1. Measurement = Reading Level + Correct Factor.

2. If Peak Result complies with AV limit, AV Result is deemed to comply with AV limit.

3. Peak: Peak detector.

4. Filter losses were only considered in the spurious frequency bands and the authorized band was not corrected for Band reject filter losses.

5. Proper operation of the transmitter prior to adding the filter to the measurement chain.

6. Since non-restricted band peak emissions are less than the average limit, they also comply with the -27dBm/MHz (68.2dBuV/m) limit.

HARMONICS AND SPURIOUS EMISSIONS (MID CHANNEL, HORIZONTAL)

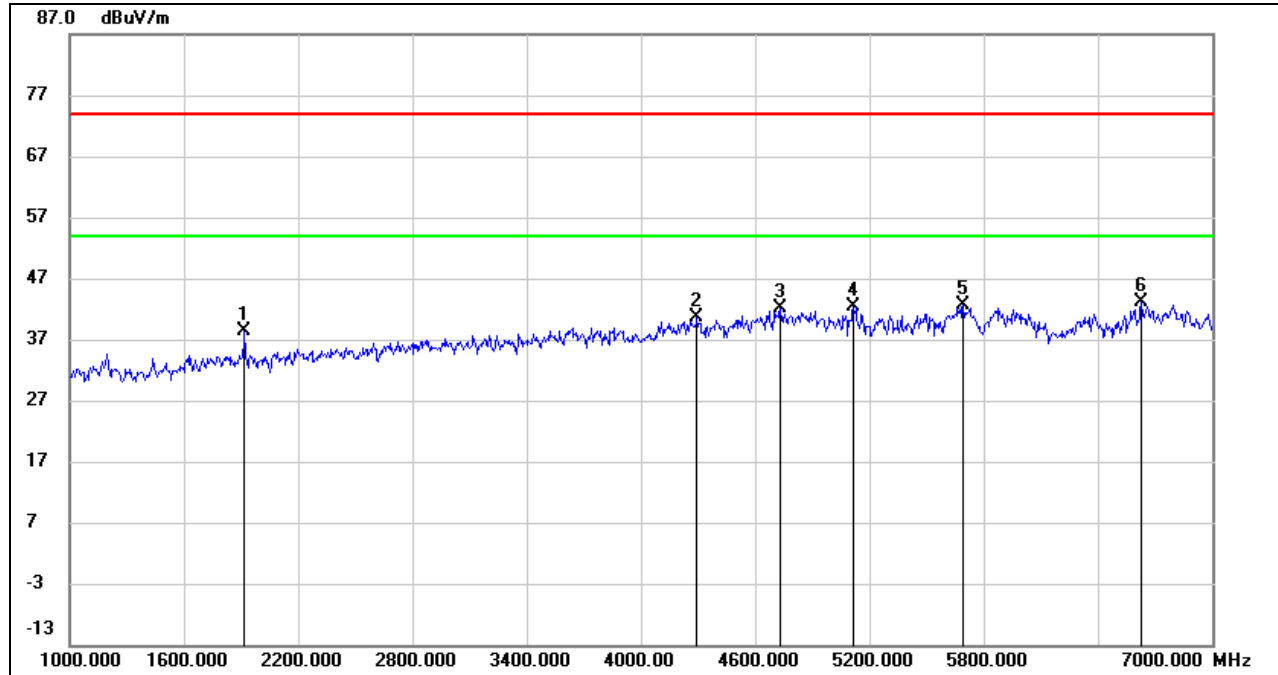

No.	Frequency (MHz)	Reading (dBuV)	Correct (dB/m)	Result (dBuV/m)	Limit (dBuV/m)	Margin (dB)	Remark
1	1918.000	48.39	-10.13	38.26	74.00	-35.74	peak
2	4294.000	42.44	-1.76	40.68	74.00	-33.32	peak
3	4732.000	41.82	0.20	42.02	74.00	-31.98	peak
4	5116.000	40.67	1.60	42.27	74.00	-31.73	peak
5	5692.000	40.11	2.47	42.58	74.00	-31.42	peak
6	6628.000	37.61	5.50	43.11	74.00	-30.89	peak

Note: 1. Measurement = Reading Level + Correct Factor.
 2. If Peak Result complies with AV limit, AV Result is deemed to comply with AV limit.
 3. Peak: Peak detector.
 4. Filter losses were only considered in the spurious frequency bands and the authorized band was not corrected for Band reject filter losses.
 5. Proper operation of the transmitter prior to adding the filter to the measurement chain.
 6. Since non-restricted band peak emissions are less than the average limit, they also comply with the -27dBm/MHz (68.2dBuV/m) limit.

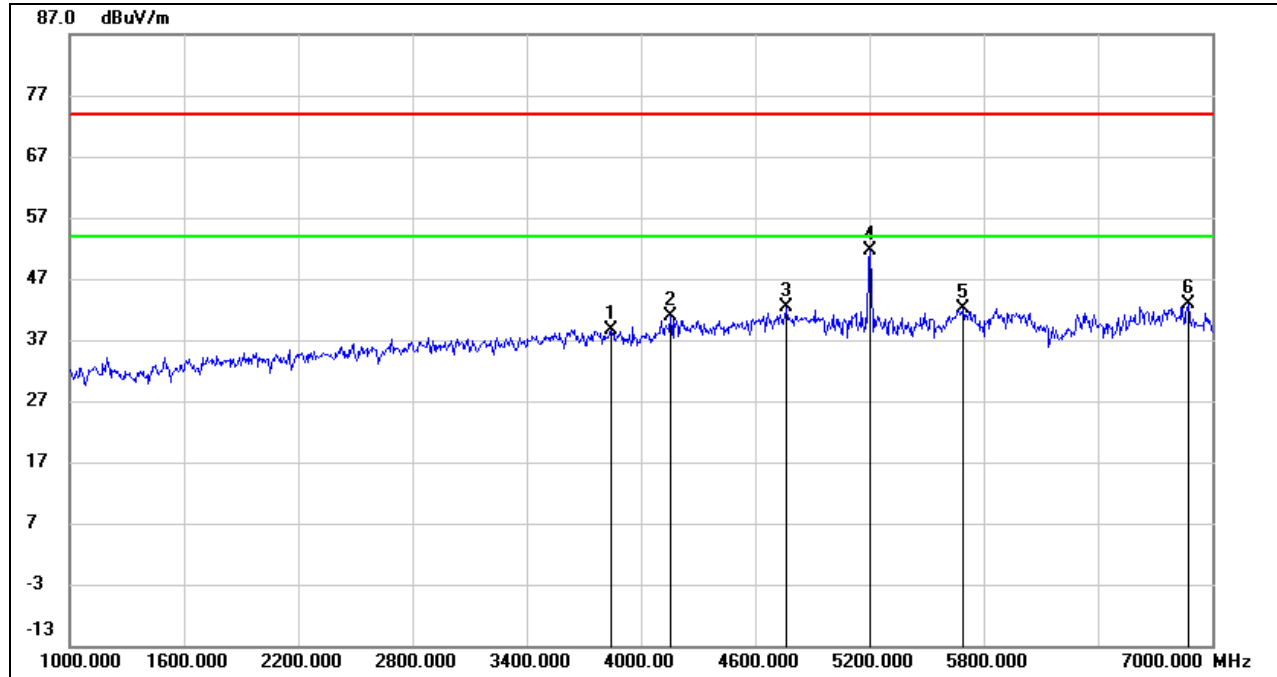
**HARMONICS AND SPURIOUS EMISSIONS (MID CHANNEL, VERTICAL)**

No.	Frequency (MHz)	Reading (dBuV)	Correct (dB/m)	Result (dBuV/m)	Limit (dBuV/m)	Margin (dB)	Remark
1	3844.000	41.99	-3.33	38.66	74.00	-35.34	peak
2	4156.000	42.99	-2.10	40.89	74.00	-33.11	peak
3	4762.000	41.89	0.38	42.27	74.00	-31.73	peak
4	5200.000	49.52	2.10	51.62	74.00	-22.38	peak
5	5692.000	39.74	2.47	42.21	74.00	-31.79	peak
6	6874.000	37.06	5.78	42.84	74.00	-31.16	peak

Note: 1. Measurement = Reading Level + Correct Factor.

2. If Peak Result complies with AV limit, AV Result is deemed to comply with AV limit.

3. Peak: Peak detector.

4. Filter losses were only considered in the spurious frequency bands and the authorized band was not corrected for Band reject filter losses.

5. Proper operation of the transmitter prior to adding the filter to the measurement chain.

6. Since non-restricted band peak emissions are less than the average limit, they also comply with the -27dBm/MHz (68.2dBuV/m) limit.



HARMONICS AND SPURIOUS EMISSIONS (HIGH CHANNEL, HORIZONTAL)

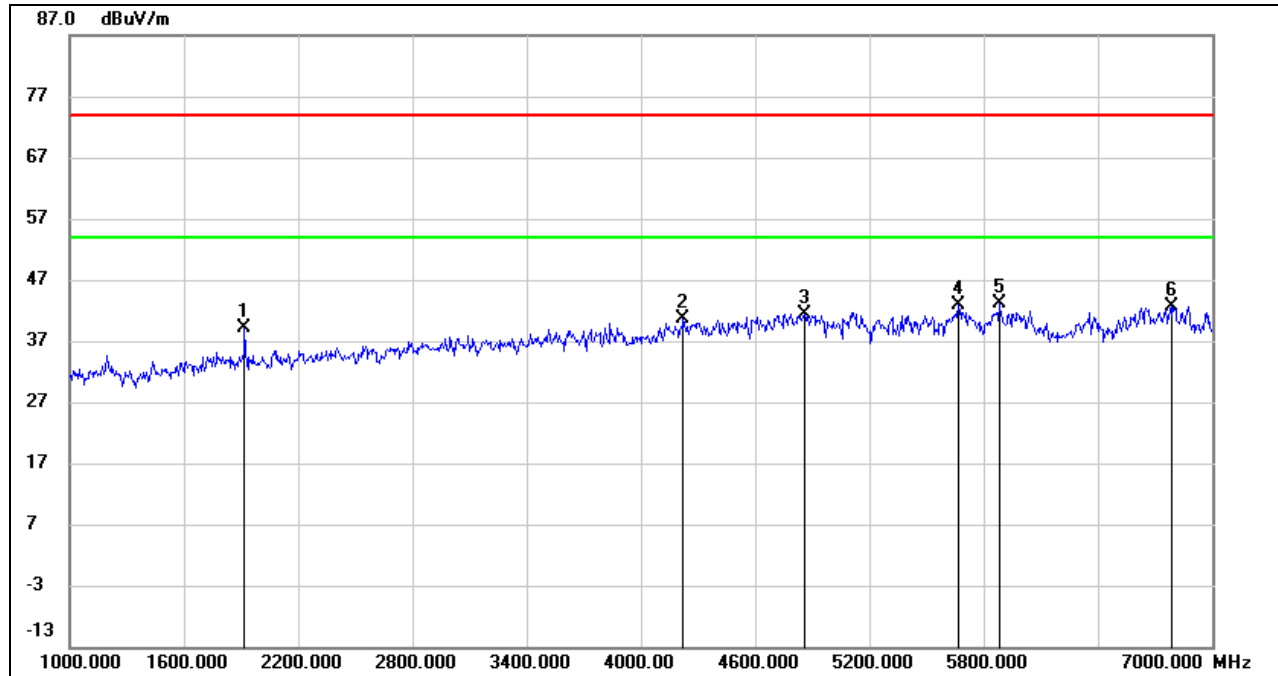

No.	Frequency (MHz)	Reading (dBuV)	Correct (dB/m)	Result (dBuV/m)	Limit (dBuV/m)	Margin (dB)	Remark
1	1918.000	49.20	-10.13	39.07	74.00	-34.93	peak
2	4222.000	42.21	-1.69	40.52	74.00	-33.48	peak
3	4858.000	40.77	0.68	41.45	74.00	-32.55	peak
4	5668.000	40.47	2.47	42.94	74.00	-31.06	peak
5	5884.000	40.18	2.84	43.02	74.00	-30.98	peak
6	6784.000	36.98	5.56	42.54	74.00	-31.46	peak

- Note: 1. Measurement = Reading Level + Correct Factor.
 2. If Peak Result complies with AV limit, AV Result is deemed to comply with AV limit.
 3. Peak: Peak detector.
 4. Filter losses were only considered in the spurious frequency bands and the authorized band was not corrected for Band reject filter losses.
 5. Proper operation of the transmitter prior to adding the filter to the measurement chain.
 6. Since non-restricted band peak emissions are less than the average limit, they also comply with the -27dBm/MHz (68.2dBuV/m) limit.



HARMONICS AND SPURIOUS EMISSIONS (HIGH CHANNEL, VERTICAL)

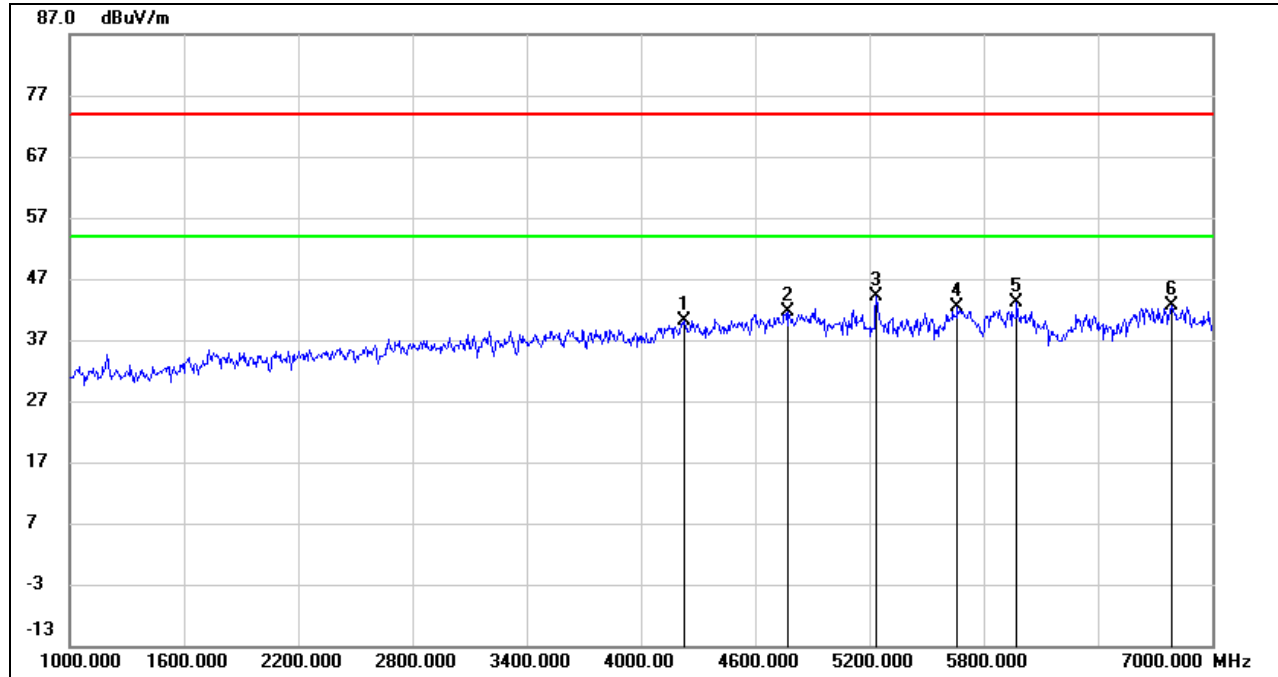

No.	Frequency (MHz)	Reading (dBuV)	Correct (dB/m)	Result (dBuV/m)	Limit (dBuV/m)	Margin (dB)	Remark
1	4228.000	41.81	-1.70	40.11	74.00	-33.89	peak
2	4774.000	41.15	0.43	41.58	74.00	-32.42	peak
3	5236.000	42.11	2.05	44.16	74.00	-29.84	peak
4	5662.000	39.81	2.47	42.28	74.00	-31.72	peak
5	5974.000	39.90	3.20	43.10	74.00	-30.90	peak
6	6784.000	37.01	5.56	42.57	74.00	-31.43	peak

Note: 1. Measurement = Reading Level + Correct Factor.
 2. If Peak Result complies with AV limit, AV Result is deemed to comply with AV limit.
 3. Peak: Peak detector.
 4. Filter losses were only considered in the spurious frequency bands and the authorized band was not corrected for Band reject filter losses.
 5. Proper operation of the transmitter prior to adding the filter to the measurement chain.
 6. Since non-restricted band peak emissions are less than the average limit, they also comply with the -27dBm/MHz (68.2dBuV/m) limit.



UNII-2A BAND

MIMO MODE TEST RESULTS (WORST CASE)

HARMONICS AND SPURIOUS EMISSIONS (LOW CHANNEL, HORIZONTAL)

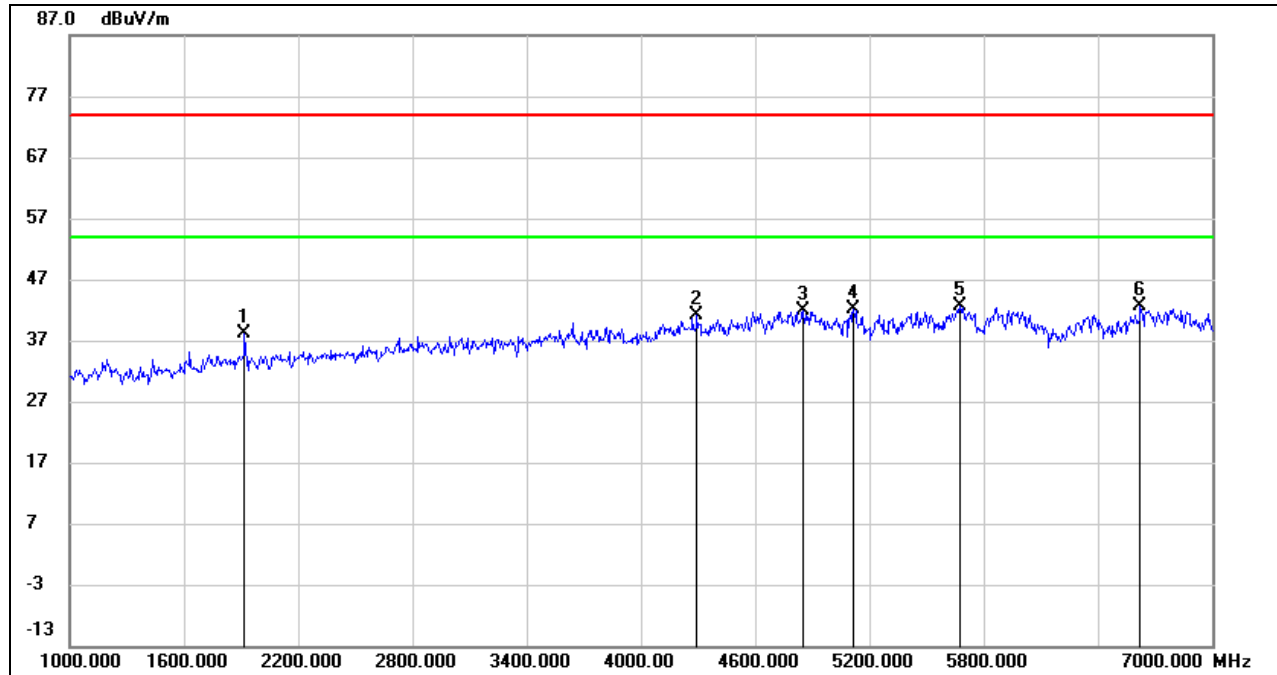

No.	Frequency (MHz)	Reading (dBuV)	Correct (dB/m)	Result (dBuV/m)	Limit (dBuV/m)	Margin (dB)	Remark
1	1918.000	48.26	-10.13	38.13	74.00	-35.87	peak
2	4294.000	42.78	-1.76	41.02	74.00	-32.98	peak
3	4852.000	41.15	0.67	41.82	74.00	-32.18	peak
4	5116.000	40.53	1.60	42.13	74.00	-31.87	peak
5	5674.000	40.07	2.48	42.55	74.00	-31.45	peak
6	6622.000	37.09	5.51	42.60	74.00	-31.40	peak

- Note:
1. Measurement = Reading Level + Correct Factor.
 2. If Peak Result complies with AV limit, AV Result is deemed to comply with AV limit.
 3. Peak: Peak detector.
 4. Filter losses were only considered in the spurious frequency bands and the authorized band was not corrected for Band reject filter losses.
 5. Proper operation of the transmitter prior to adding the filter to the measurement chain.
 6. Since non-restricted band peak emissions are less than the average limit, they also comply with the -27dBm/MHz (68.2dBuV/m) limit.

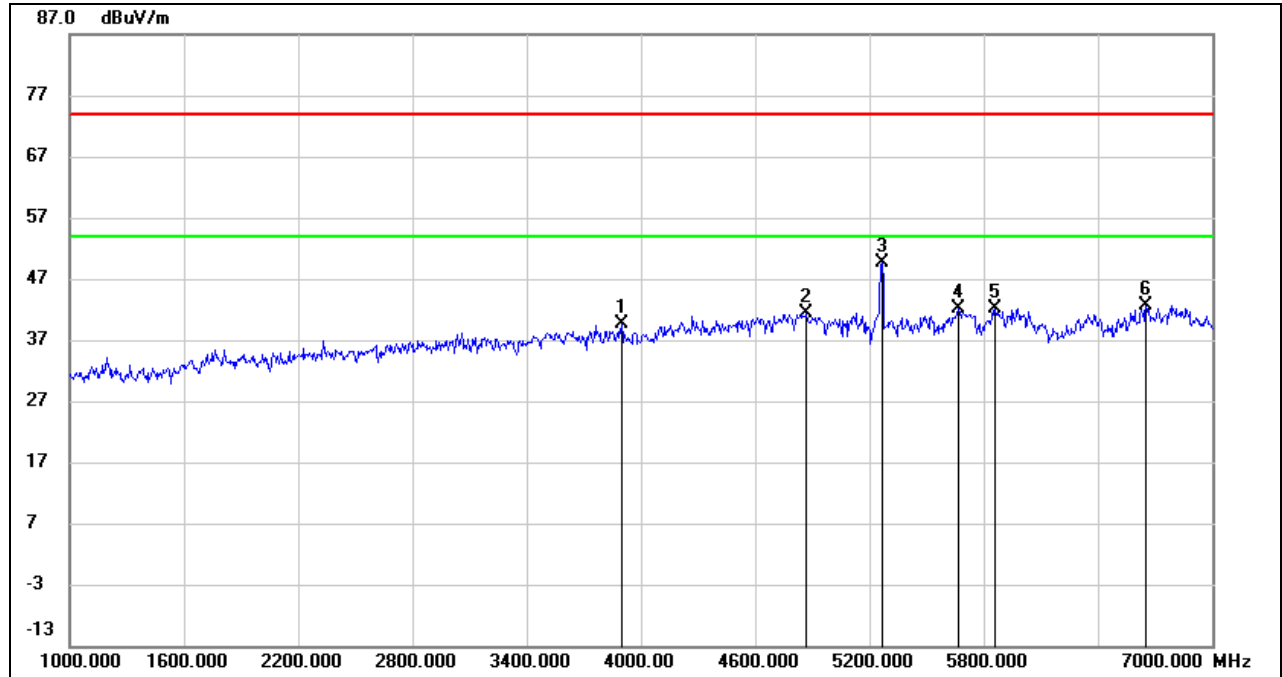
**HARMONICS AND SPURIOUS EMISSIONS (LOW CHANNEL, VERTICAL)**

No.	Frequency (MHz)	Reading (dBuV)	Correct (dB/m)	Result (dBuV/m)	Limit (dBuV/m)	Margin (dB)	Remark
1	3898.000	42.96	-3.42	39.54	74.00	-34.46	peak
2	4870.000	40.75	0.69	41.44	74.00	-32.56	peak
3	5266.000	47.72	2.03	49.75	74.00	-24.25	peak
4	5668.000	39.68	2.47	42.15	74.00	-31.85	peak
5	5860.000	39.41	2.75	42.16	74.00	-31.84	peak
6	6652.000	37.22	5.52	42.74	74.00	-31.26	peak

Note: 1. Measurement = Reading Level + Correct Factor.

2. If Peak Result complies with AV limit, AV Result is deemed to comply with AV limit.

3. Peak: Peak detector.

4. Filter losses were only considered in the spurious frequency bands and the authorized band was not corrected for Band reject filter losses.

5. Proper operation of the transmitter prior to adding the filter to the measurement chain.

6. Since non-restricted band peak emissions are less than the average limit, they also comply with the -27dBm/MHz (68.2dBuV/m) limit.

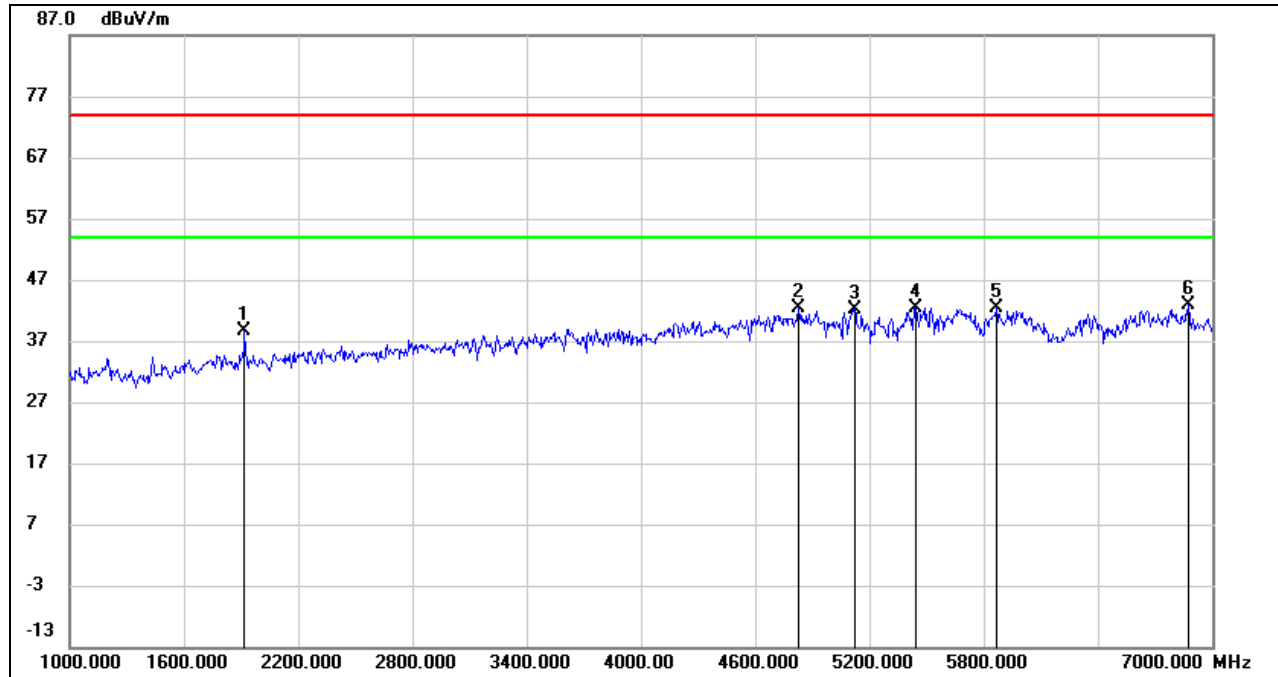
**HARMONICS AND SPURIOUS EMISSIONS (MID CHANNEL, HORIZONTAL)**

No.	Frequency (MHz)	Reading (dBuV)	Correct (dB/m)	Result (dBuV/m)	Limit (dBuV/m)	Margin (dB)	Remark
1	1918.000	48.69	-10.13	38.56	74.00	-35.44	peak
2	4828.000	41.71	0.63	42.34	74.00	-31.66	peak
3	5122.000	40.61	1.64	42.25	74.00	-31.75	peak
4	5446.000	40.39	2.01	42.40	74.00	-31.60	peak
5	5866.000	39.55	2.77	42.32	74.00	-31.68	peak
6	6874.000	37.19	5.78	42.97	74.00	-31.03	peak

Note: 1. Measurement = Reading Level + Correct Factor.

2. If Peak Result complies with AV limit, AV Result is deemed to comply with AV limit.

3. Peak: Peak detector.

4. Filter losses were only considered in the spurious frequency bands and the authorized band was not corrected for Band reject filter losses.

5. Proper operation of the transmitter prior to adding the filter to the measurement chain.

6. Since non-restricted band peak emissions are less than the average limit, they also comply with the -27dBm/MHz (68.2dBuV/m) limit.

HARMONICS AND SPURIOUS EMISSIONS (MID CHANNEL, VERTICAL)

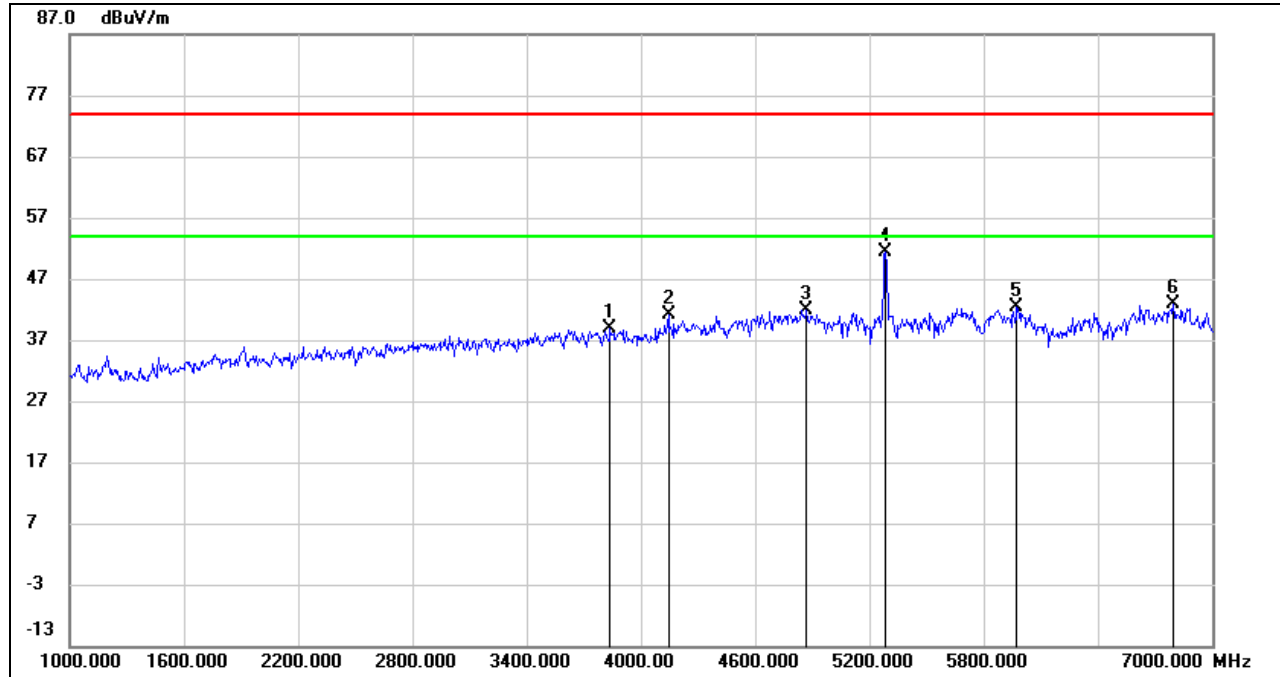

No.	Frequency (MHz)	Reading (dBuV)	Correct (dB/m)	Result (dBuV/m)	Limit (dBuV/m)	Margin (dB)	Remark
1	3838.000	42.16	-3.32	38.84	74.00	-35.16	peak
2	4144.000	43.24	-2.21	41.03	74.00	-32.97	peak
3	4870.000	41.18	0.69	41.87	74.00	-32.13	peak
4	5280.000	49.43	2.02	51.45	74.00	-22.55	peak
5	5974.000	39.13	3.20	42.33	74.00	-31.67	peak
6	6796.000	37.28	5.57	42.85	74.00	-31.15	peak

Note: 1. Measurement = Reading Level + Correct Factor.
 2. If Peak Result complies with AV limit, AV Result is deemed to comply with AV limit.
 3. Peak: Peak detector.
 4. Filter losses were only considered in the spurious frequency bands and the authorized band was not corrected for Band reject filter losses.
 5. Proper operation of the transmitter prior to adding the filter to the measurement chain.
 6. Since non-restricted band peak emissions are less than the average limit, they also comply with the -27dBm/MHz (68.2dBuV/m) limit.

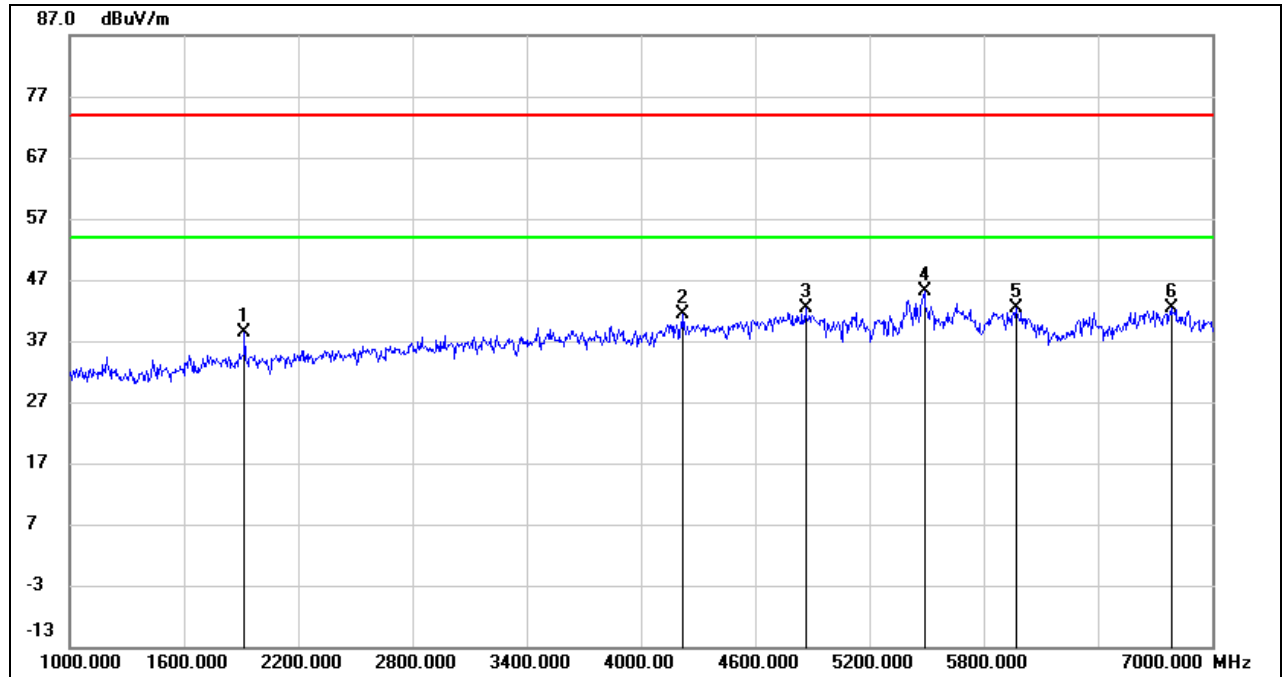
**HARMONICS AND SPURIOUS EMISSIONS (HIGH CHANNEL, HORIZONTAL)**

No.	Frequency (MHz)	Reading (dBuV)	Correct (dB/m)	Result (dBuV/m)	Limit (dBuV/m)	Margin (dB)	Remark
1	1918.000	48.55	-10.13	38.42	74.00	-35.58	peak
2	4222.000	43.17	-1.69	41.48	74.00	-32.52	peak
3	4864.000	41.80	0.69	42.49	74.00	-31.51	peak
4	5488.000	43.10	2.13	45.23	74.00	-28.77	peak
5	5968.000	39.12	3.17	42.29	74.00	-31.71	peak
6	6784.000	36.88	5.56	42.44	74.00	-31.56	peak

Note: 1. Measurement = Reading Level + Correct Factor.

2. If Peak Result complies with AV limit, AV Result is deemed to comply with AV limit.

3. Peak: Peak detector.

4. Filter losses were only considered in the spurious frequency bands and the authorized band was not corrected for Band reject filter losses.

5. Proper operation of the transmitter prior to adding the filter to the measurement chain.

6. Since non-restricted band peak emissions are less than the average limit, they also comply with the -27dBm/MHz (68.2dBuV/m) limit.

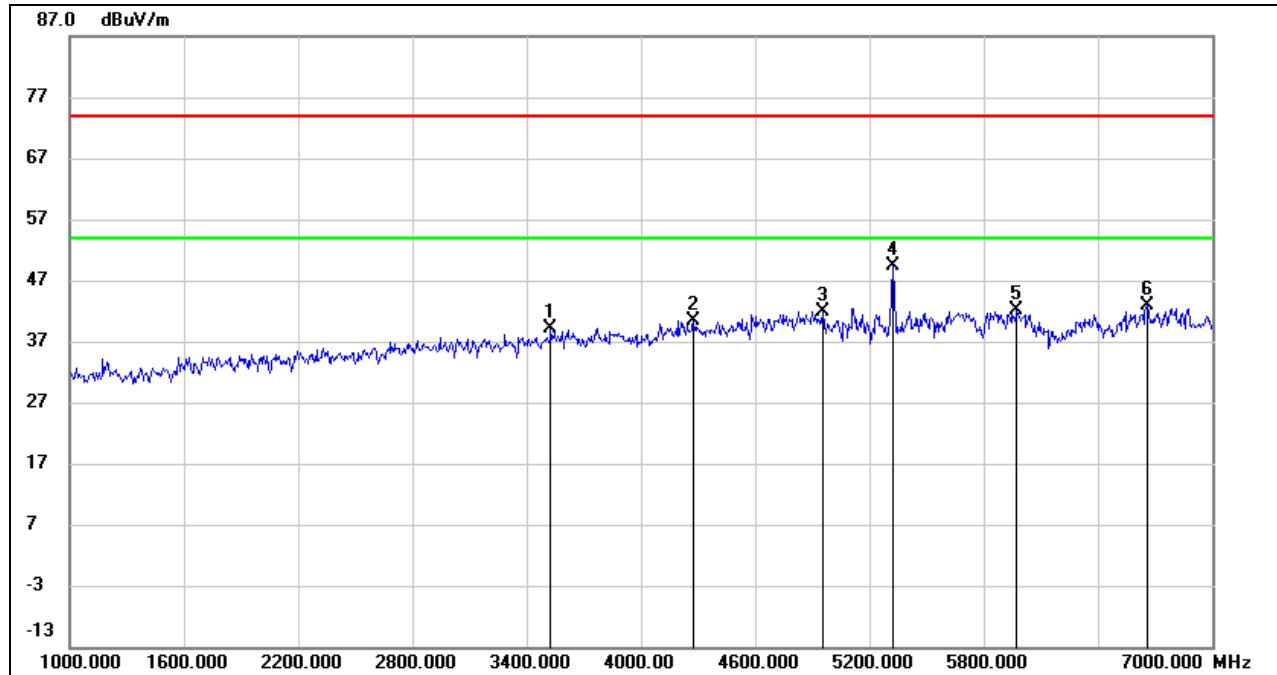
**HARMONICS AND SPURIOUS EMISSIONS (HIGH CHANNEL, VERTICAL)**

No.	Frequency (MHz)	Reading (dBuV)	Correct (dB/m)	Result (dBuV/m)	Limit (dBuV/m)	Margin (dB)	Remark
1	3526.000	43.70	-4.58	39.12	74.00	-34.88	peak
2	4276.000	42.16	-1.74	40.42	74.00	-33.58	peak
3	4954.000	41.06	0.83	41.89	74.00	-32.11	peak
4	5320.000	47.46	1.96	49.42	74.00	-24.58	peak
5	5974.000	38.85	3.20	42.05	74.00	-31.95	peak
6	6658.000	37.27	5.51	42.78	74.00	-31.22	peak

Note: 1. Measurement = Reading Level + Correct Factor.

2. If Peak Result complies with AV limit, AV Result is deemed to comply with AV limit.

3. Peak: Peak detector.

4. Filter losses were only considered in the spurious frequency bands and the authorized band was not corrected for Band reject filter losses.

5. Proper operation of the transmitter prior to adding the filter to the measurement chain.

6. Since non-restricted band peak emissions are less than the average limit, they also comply with the -27dBm/MHz (68.2dBuV/m) limit.



UNII-2C BAND

MIMO MODE TEST RESULTS (WORST CASE)

HARMONICS AND SPURIOUS EMISSIONS (LOW CHANNEL, HORIZONTAL)

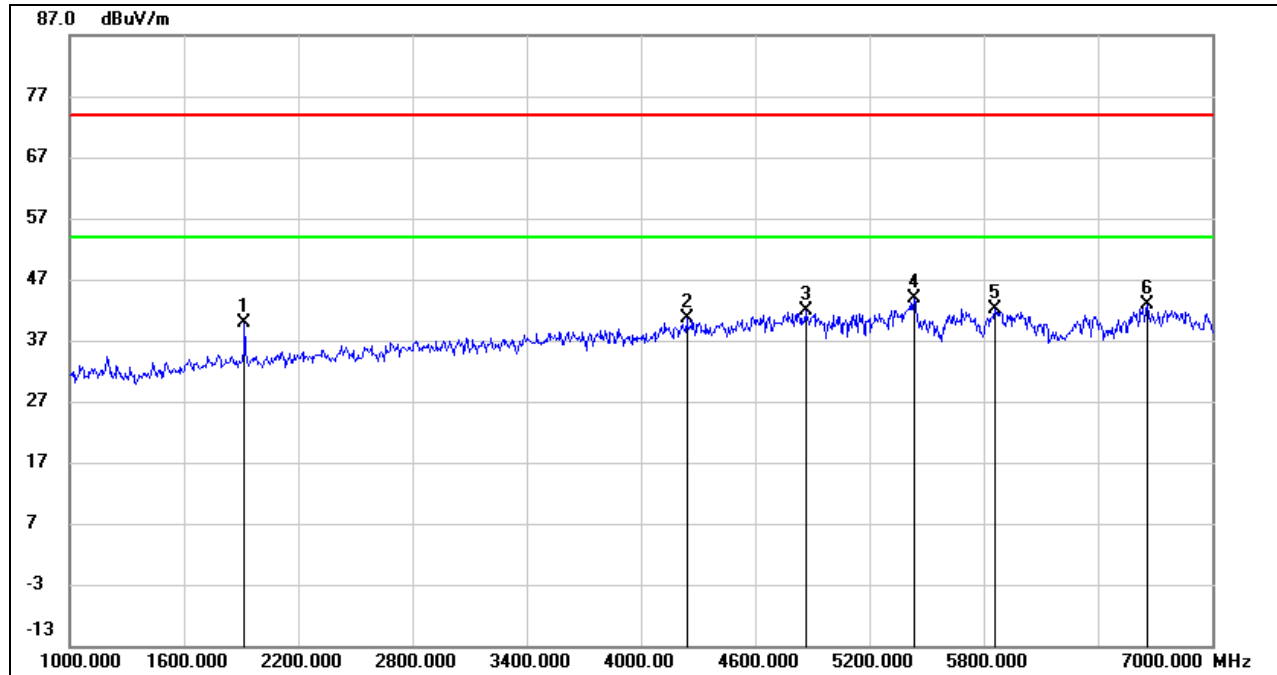

No.	Frequency (MHz)	Reading (dBuV)	Correct (dB/m)	Result (dBuV/m)	Limit (dBuV/m)	Margin (dB)	Remark
1	1918.000	50.08	-10.13	39.95	74.00	-34.05	peak
2	4240.000	42.39	-1.71	40.68	74.00	-33.32	peak
3	4864.000	41.30	0.69	41.99	74.00	-32.01	peak
4	5434.000	41.85	1.97	43.82	74.00	-30.18	peak
5	5860.000	39.35	2.75	42.10	74.00	-31.90	peak
6	6658.000	37.47	5.51	42.98	74.00	-31.02	peak

Note: 1. Measurement = Reading Level + Correct Factor.
 2. If Peak Result complies with AV limit, AV Result is deemed to comply with AV limit.
 3. Peak: Peak detector.
 4. Filter losses were only considered in the spurious frequency bands and the authorized band was not corrected for Band reject filter losses.
 5. Proper operation of the transmitter prior to adding the filter to the measurement chain.
 6. Since non-restricted band peak emissions are less than the average limit, they also comply with the -27dBm/MHz (68.2dBuV/m) limit.

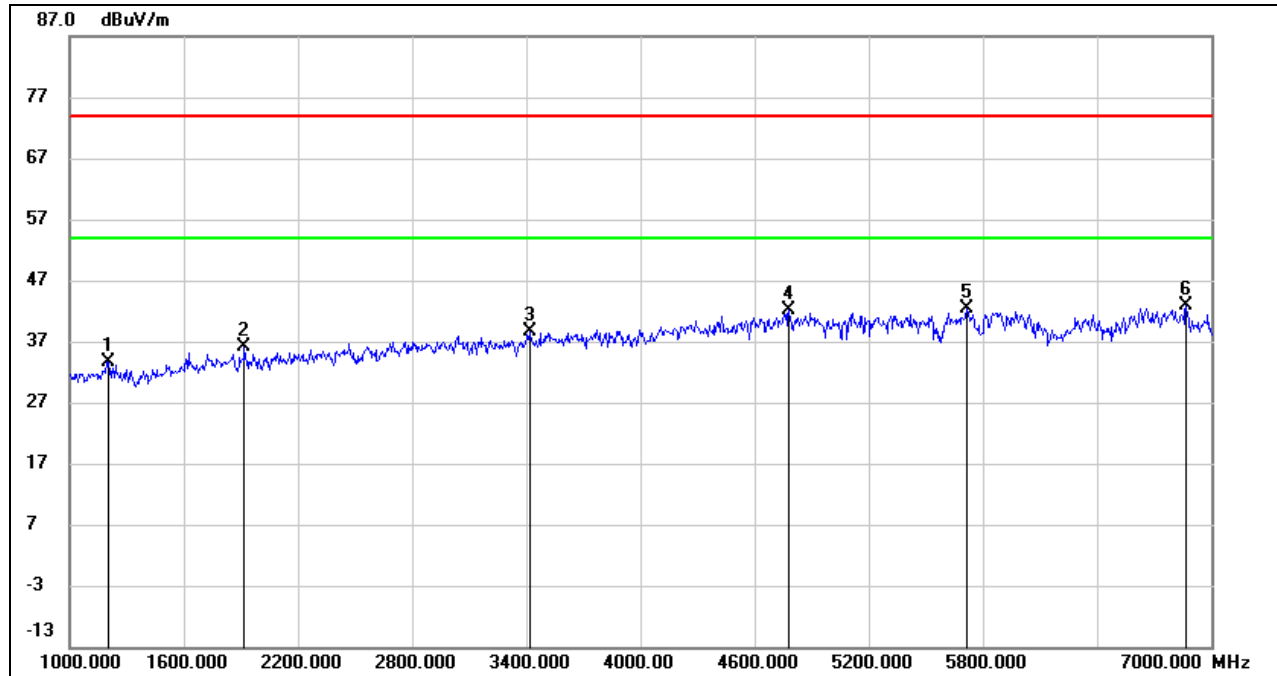
**HARMONICS AND SPURIOUS EMISSIONS (LOW CHANNEL, VERTICAL)**

No.	Frequency (MHz)	Reading (dBuV)	Correct (dB/m)	Result (dBuV/m)	Limit (dBuV/m)	Margin (dB)	Remark
1	1204.000	46.70	-12.98	33.72	74.00	-40.28	peak
2	1918.000	46.24	-10.13	36.11	74.00	-37.89	peak
3	3418.000	43.69	-5.04	38.65	74.00	-35.35	peak
4	4780.000	41.66	0.48	42.14	74.00	-31.86	peak
5	5716.000	39.83	2.48	42.31	74.00	-31.69	peak
6	6868.000	37.17	5.76	42.93	74.00	-31.07	peak

Note: 1. Measurement = Reading Level + Correct Factor.

2. If Peak Result complies with AV limit, AV Result is deemed to comply with AV limit.

3. Peak: Peak detector.

4. Filter losses were only considered in the spurious frequency bands and the authorized band was not corrected for Band reject filter losses.

5. Proper operation of the transmitter prior to adding the filter to the measurement chain.

6. Since non-restricted band peak emissions are less than the average limit, they also comply with the -27dBm/MHz (68.2dBuV/m) limit.

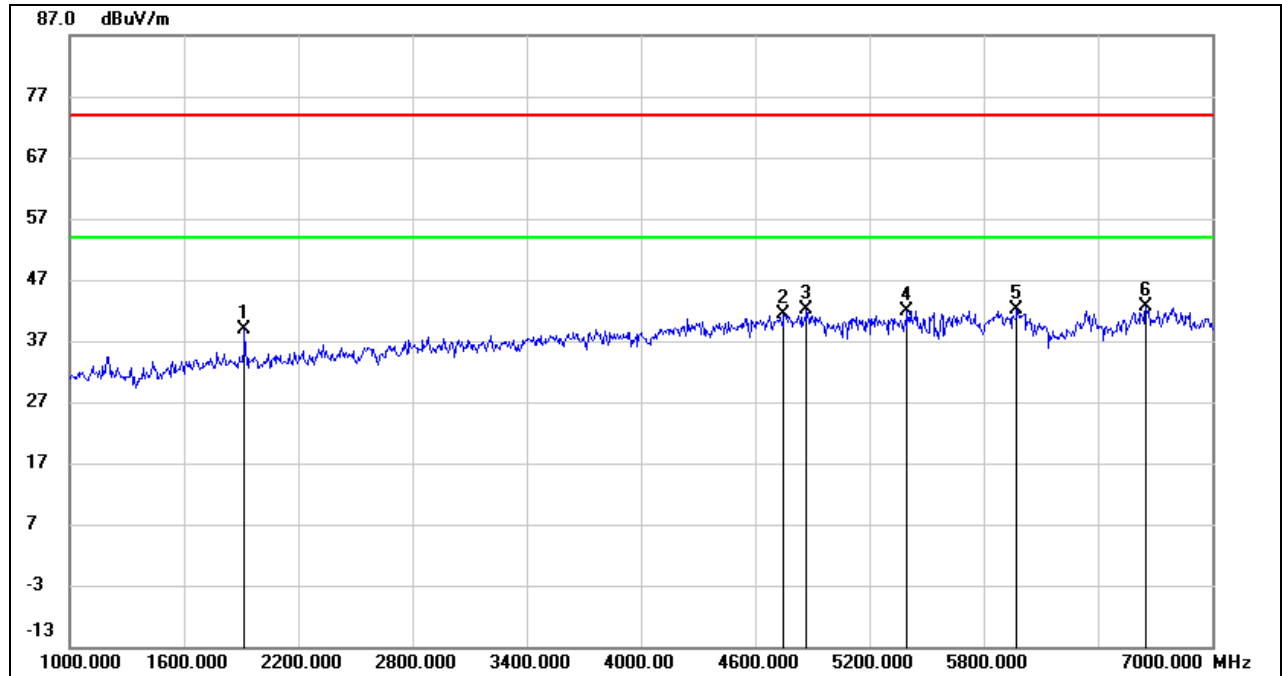
**HARMONICS AND SPURIOUS EMISSIONS (MID CHANNEL, HORIZONTAL)**

No.	Frequency (MHz)	Reading (dBuV)	Correct (dB/m)	Result (dBuV/m)	Limit (dBuV/m)	Margin (dB)	Remark
1	1918.000	49.06	-10.13	38.93	74.00	-35.07	peak
2	4750.000	40.98	0.30	41.28	74.00	-32.72	peak
3	4870.000	41.42	0.69	42.11	74.00	-31.89	peak
4	5398.000	40.00	1.88	41.88	74.00	-32.12	peak
5	5974.000	38.81	3.20	42.01	74.00	-31.99	peak
6	6652.000	37.03	5.52	42.55	74.00	-31.45	peak

Note: 1. Measurement = Reading Level + Correct Factor.

2. If Peak Result complies with AV limit, AV Result is deemed to comply with AV limit.

3. Peak: Peak detector.

4. Filter losses were only considered in the spurious frequency bands and the authorized band was not corrected for Band reject filter losses.

5. Proper operation of the transmitter prior to adding the filter to the measurement chain.

6. Since non-restricted band peak emissions are less than the average limit, they also comply with the -27dBm/MHz (68.2dBuV/m) limit.

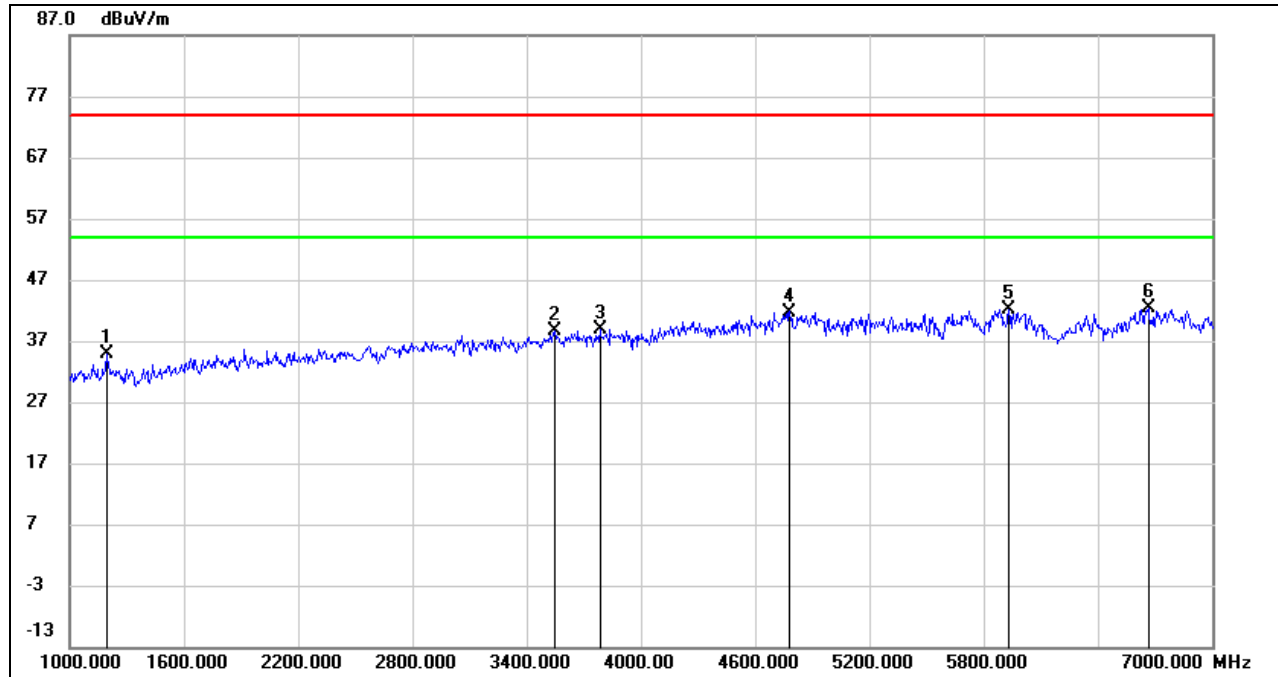
**HARMONICS AND SPURIOUS EMISSIONS (MID CHANNEL, VERTICAL)**

No.	Frequency (MHz)	Reading (dBuV)	Correct (dB/m)	Result (dBuV/m)	Limit (dBuV/m)	Margin (dB)	Remark
1	1192.000	47.95	-13.03	34.92	74.00	-39.08	peak
2	3550.000	43.06	-4.45	38.61	74.00	-35.39	peak
3	3784.000	42.13	-3.32	38.81	74.00	-35.19	peak
4	4780.000	41.27	0.48	41.75	74.00	-32.25	peak
5	5932.000	39.12	3.03	42.15	74.00	-31.85	peak
6	6664.000	36.80	5.53	42.33	74.00	-31.67	peak

Note: 1. Measurement = Reading Level + Correct Factor.

2. If Peak Result complies with AV limit, AV Result is deemed to comply with AV limit.

3. Peak: Peak detector.

4. Filter losses were only considered in the spurious frequency bands and the authorized band was not corrected for Band reject filter losses.

5. Proper operation of the transmitter prior to adding the filter to the measurement chain.

6. Since non-restricted band peak emissions are less than the average limit, they also comply with the -27dBm/MHz (68.2dBuV/m) limit.

HARMONICS AND SPURIOUS EMISSIONS (HIGH CHANNEL, HORIZONTAL)

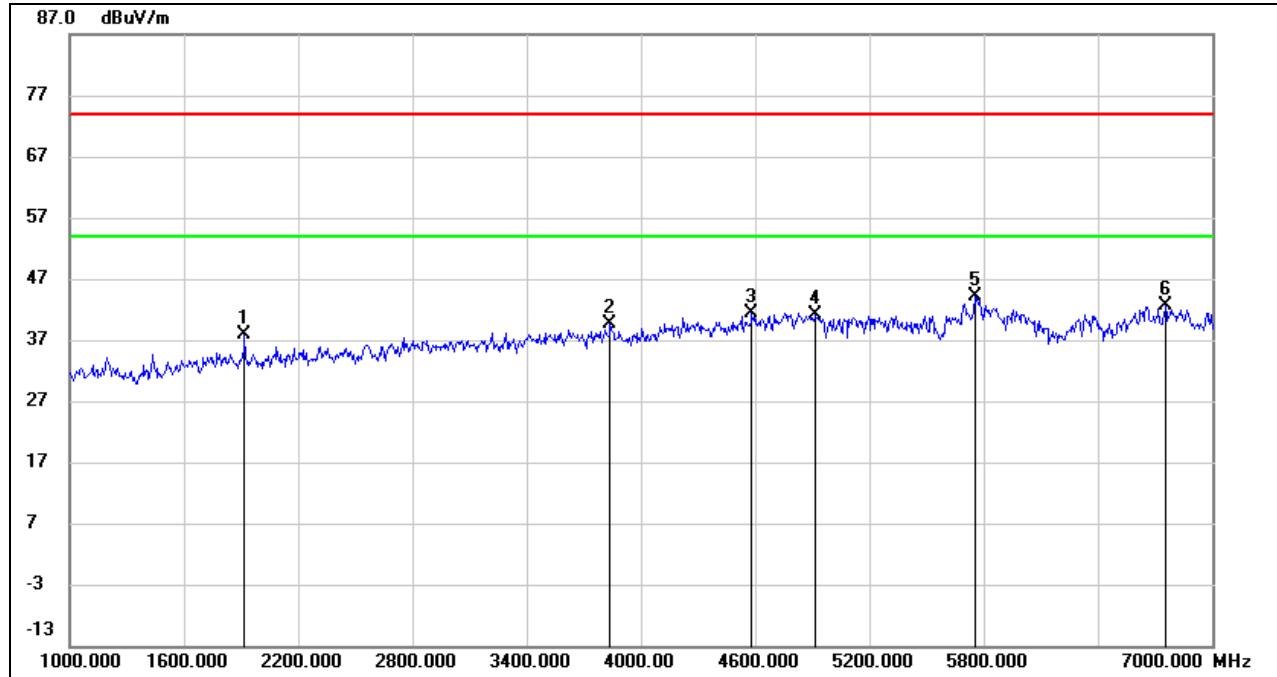

No.	Frequency (MHz)	Reading (dBuV)	Correct (dB/m)	Result (dBuV/m)	Limit (dBuV/m)	Margin (dB)	Remark
1	1918.000	48.12	-10.13	37.99	74.00	-36.01	peak
2	3838.000	42.99	-3.32	39.67	74.00	-34.33	peak
3	4582.000	42.11	-0.69	41.42	74.00	-32.58	peak
4	4918.000	40.39	0.77	41.16	74.00	-32.84	peak
5	5758.000	41.61	2.50	44.11	74.00	-29.89	peak
6	6754.000	37.10	5.56	42.66	74.00	-31.34	peak

Note: 1. Measurement = Reading Level + Correct Factor.

2. If Peak Result complies with AV limit, AV Result is deemed to comply with AV limit.

3. Peak: Peak detector.

4. Filter losses were only considered in the spurious frequency bands and the authorized band was not corrected for Band reject filter losses.

5. Proper operation of the transmitter prior to adding the filter to the measurement chain.

6. Since non-restricted band peak emissions are less than the average limit, they also comply with the -27dBm/MHz (68.2dBuV/m) limit.

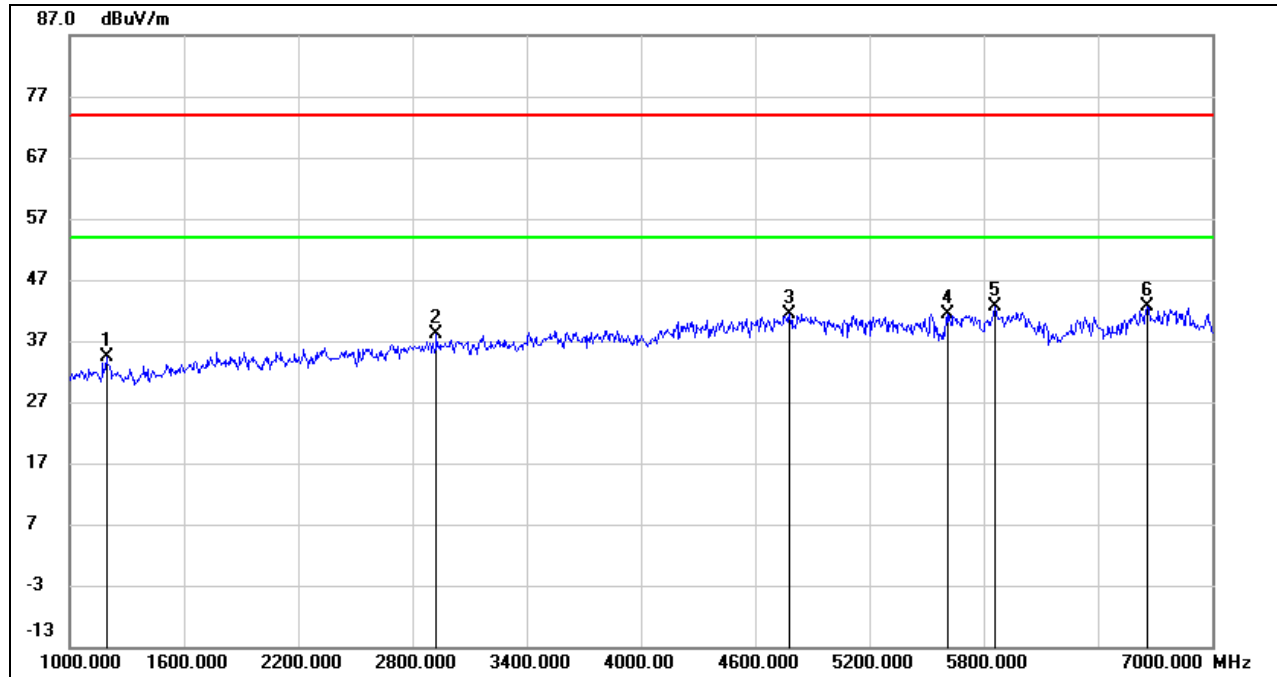
**HARMONICS AND SPURIOUS EMISSIONS (HIGH CHANNEL, VERTICAL)**

No.	Frequency (MHz)	Reading (dBuV)	Correct (dB/m)	Result (dBuV/m)	Limit (dBuV/m)	Margin (dB)	Remark
1	1192.000	47.43	-13.03	34.40	74.00	-39.60	peak
2	2926.000	44.00	-5.95	38.05	74.00	-35.95	peak
3	4780.000	40.96	0.48	41.44	74.00	-32.56	peak
4	5614.000	38.92	2.46	41.38	74.00	-32.62	peak
5	5860.000	39.90	2.75	42.65	74.00	-31.35	peak
6	6658.000	37.05	5.51	42.56	74.00	-31.44	peak

Note: 1. Measurement = Reading Level + Correct Factor.

2. If Peak Result complies with AV limit, AV Result is deemed to comply with AV limit.

3. Peak: Peak detector.

4. Filter losses were only considered in the spurious frequency bands and the authorized band was not corrected for Band reject filter losses.

5. Proper operation of the transmitter prior to adding the filter to the measurement chain.

6. Since non-restricted band peak emissions are less than the average limit, they also comply with the -27dBm/MHz (68.2dBuV/m) limit.

STRADDLE CHANNEL 144

MIMO MODE TEST RESULTS (WORST CASE)

HARMONICS AND SPURIOUS EMISSIONS (HORIZONTAL)

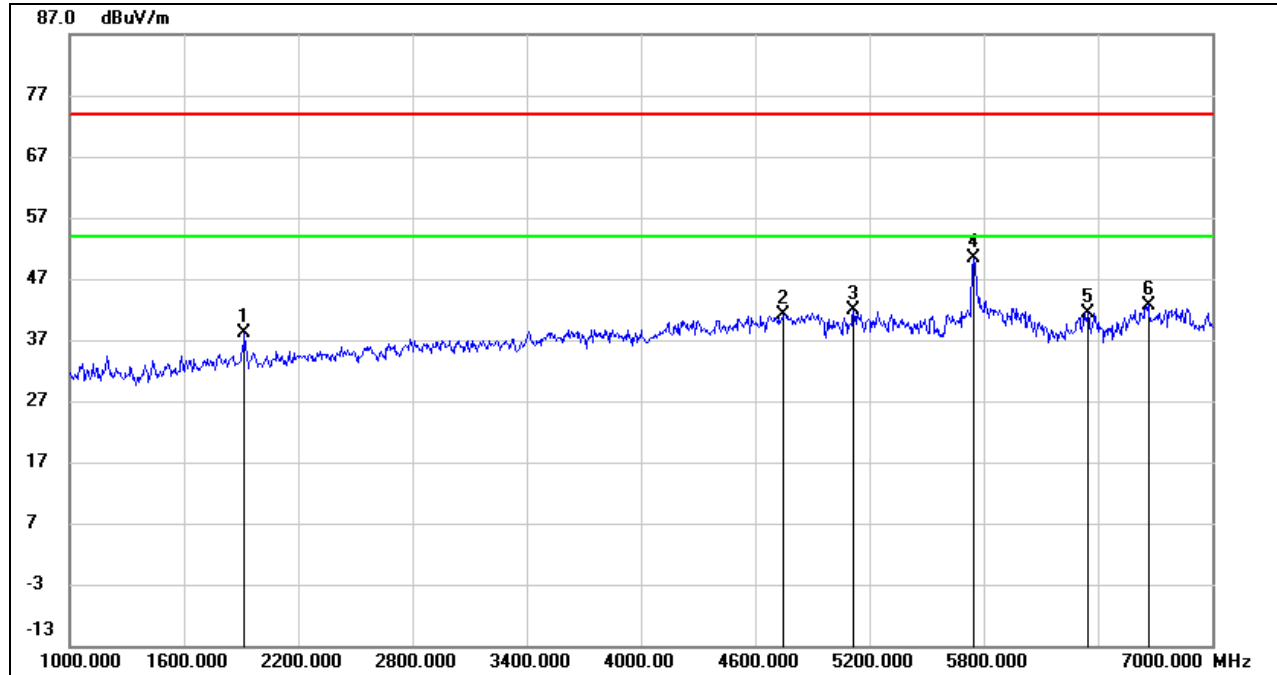

No.	Frequency (MHz)	Reading (dBuV)	Correct (dB/m)	Result (dBuV/m)	Limit (dBuV/m)	Margin (dB)	Remark
1	1918.000	48.34	-10.13	38.21	74.00	-35.79	peak
2	4744.000	40.90	0.27	41.17	74.00	-32.83	peak
3	5116.000	40.21	1.60	41.81	74.00	-32.19	peak
4	5746.000	47.94	2.50	50.44	74.00	-23.56	peak
5	6346.000	37.23	4.07	41.30	74.00	-32.70	peak
6	6664.000	37.22	5.53	42.75	74.00	-31.25	peak

Note: 1. Measurement = Reading Level + Correct Factor.
 2. If Peak Result complies with AV limit, AV Result is deemed to comply with AV limit.
 3. Peak: Peak detector.
 4. Filter losses were only considered in the spurious frequency bands and the authorized band was not corrected for Band reject filter losses.
 5. Proper operation of the transmitter prior to adding the filter to the measurement chain.
 6. Since non-restricted band peak emissions are less than the average limit, they also comply with the -27dBm/MHz (68.2dBuV/m) limit.

HARMONICS AND SPURIOUS EMISSIONS (VERTICAL)

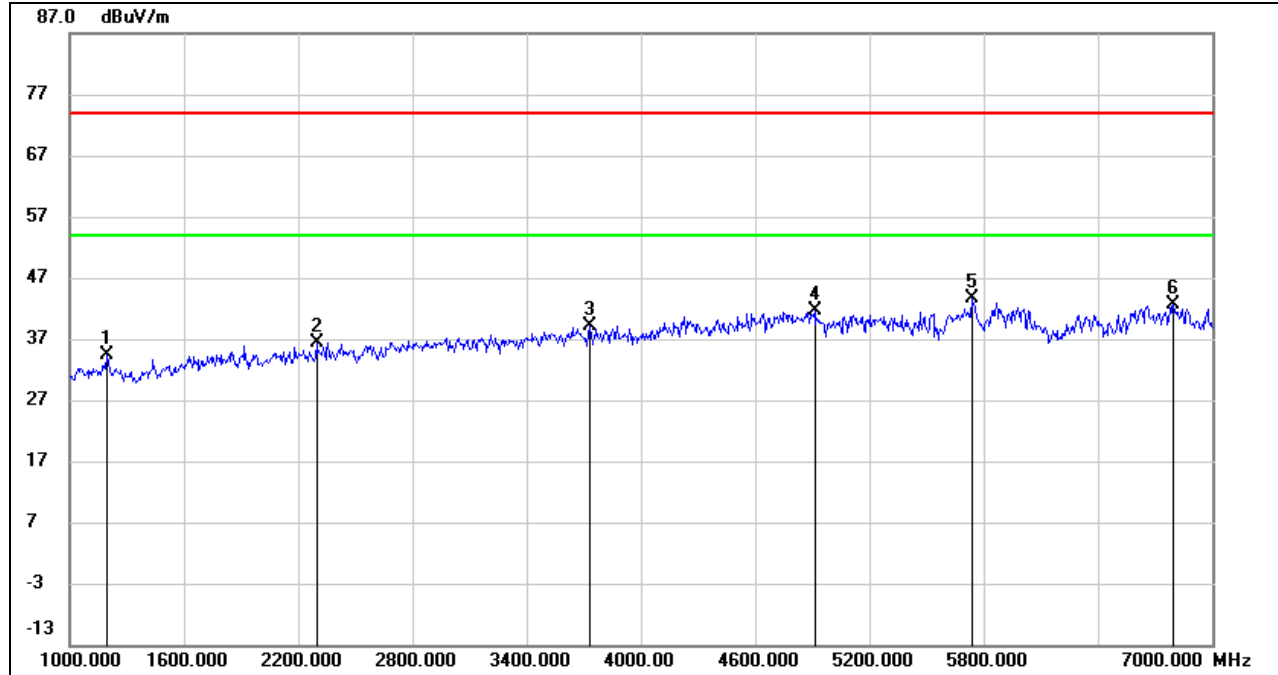

No.	Frequency (MHz)	Reading (dBuV)	Correct (dB/m)	Result (dBuV/m)	Limit (dBuV/m)	Margin (dB)	Remark
1	1192.000	47.43	-13.03	34.40	74.00	-39.60	peak
2	2296.000	45.23	-8.74	36.49	74.00	-37.51	peak
3	3730.000	42.71	-3.58	39.13	74.00	-34.87	peak
4	4912.000	40.86	0.77	41.63	74.00	-32.37	peak
5	5740.000	41.22	2.49	43.71	74.00	-30.29	peak
6	6796.000	37.00	5.57	42.57	74.00	-31.43	peak

- Note: 1. Measurement = Reading Level + Correct Factor.
 2. If Peak Result complies with AV limit, AV Result is deemed to comply with AV limit.
 3. Peak: Peak detector.
 4. Filter losses were only considered in the spurious frequency bands and the authorized band was not corrected for Band reject filter losses.
 5. Proper operation of the transmitter prior to adding the filter to the measurement chain.
 6. Since non-restricted band peak emissions are less than the average limit, they also comply with the -27dBm/MHz (68.2dBuV/m) limit.



UNII-3 BAND

MIMO MODE TEST RESULTS (WORST CASE)

HARMONICS AND SPURIOUS EMISSIONS (LOW CHANNEL, HORIZONTAL)

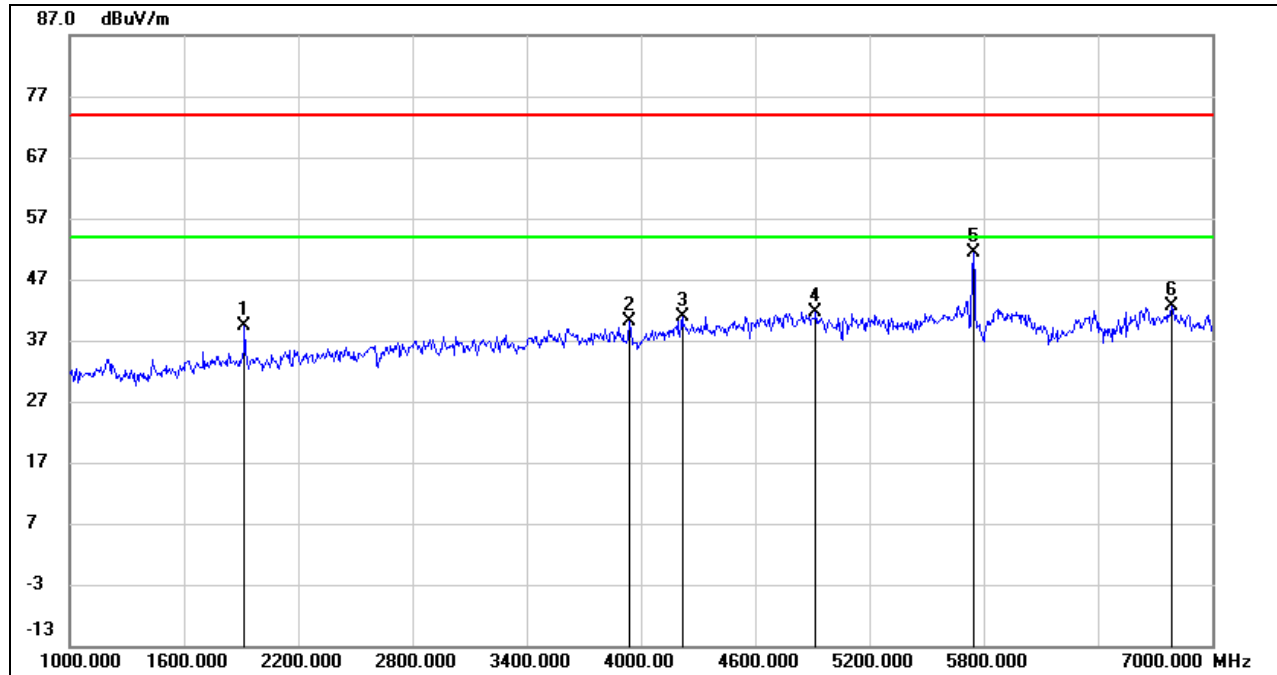

No.	Frequency (MHz)	Reading (dBuV)	Correct (dB/m)	Result (dBuV/m)	Limit (dBuV/m)	Margin (dB)	Remark
1	1918.000	49.56	-10.13	39.43	74.00	-34.57	peak
2	3940.000	43.61	-3.51	40.10	74.00	-33.90	peak
3	4216.000	42.57	-1.69	40.88	74.00	-33.12	peak
4	4918.000	40.93	0.77	41.70	74.00	-32.30	peak
5	5745.000	48.82	2.49	51.31	74.00	-22.69	peak
6	6784.000	37.13	5.56	42.69	74.00	-31.31	peak

Note: 1. Measurement = Reading Level + Correct Factor.
 2. If Peak Result complies with AV limit, AV Result is deemed to comply with AV limit.
 3. Peak: Peak detector.
 4. Filter losses were only considered in the spurious frequency bands and the authorized band was not corrected for Band reject filter losses.
 5. Proper operation of the transmitter prior to adding the filter to the measurement chain.
 6. Since non-restricted band peak emissions are less than the average limit, they also comply with the -27dBm/MHz (68.2dBuV/m) limit.

HARMONICS AND SPURIOUS EMISSIONS (LOW CHANNEL, VERTICAL)

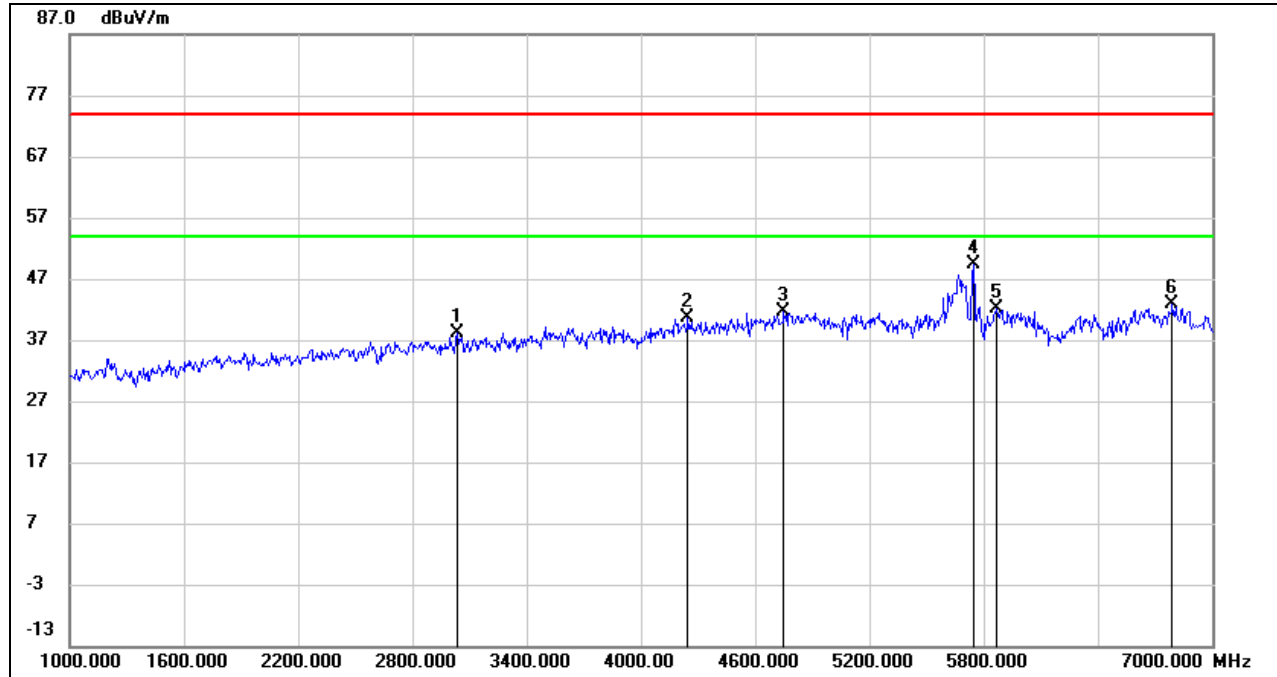

No.	Frequency (MHz)	Reading (dBuV)	Correct (dB/m)	Result (dBuV/m)	Limit (dBuV/m)	Margin (dB)	Remark
1	3034.000	43.64	-5.53	38.11	74.00	-35.89	peak
2	4246.000	42.34	-1.72	40.62	74.00	-33.38	peak
3	4750.000	41.38	0.30	41.68	74.00	-32.32	peak
4	5745.000	46.87	2.49	49.36	74.00	-24.64	peak
5	5866.000	39.27	2.77	42.04	74.00	-31.96	peak
6	6790.000	37.38	5.57	42.95	74.00	-31.05	peak

Note: 1. Measurement = Reading Level + Correct Factor.

2. If Peak Result complies with AV limit, AV Result is deemed to comply with AV limit.

3. Peak: Peak detector.

4. Filter losses were only considered in the spurious frequency bands and the authorized band was not corrected for Band reject filter losses.

5. Proper operation of the transmitter prior to adding the filter to the measurement chain.

6. Since non-restricted band peak emissions are less than the average limit, they also comply with the -27dBm/MHz (68.2dBuV/m) limit.



HARMONICS AND SPURIOUS EMISSIONS (MID CHANNEL, HORIZONTAL)

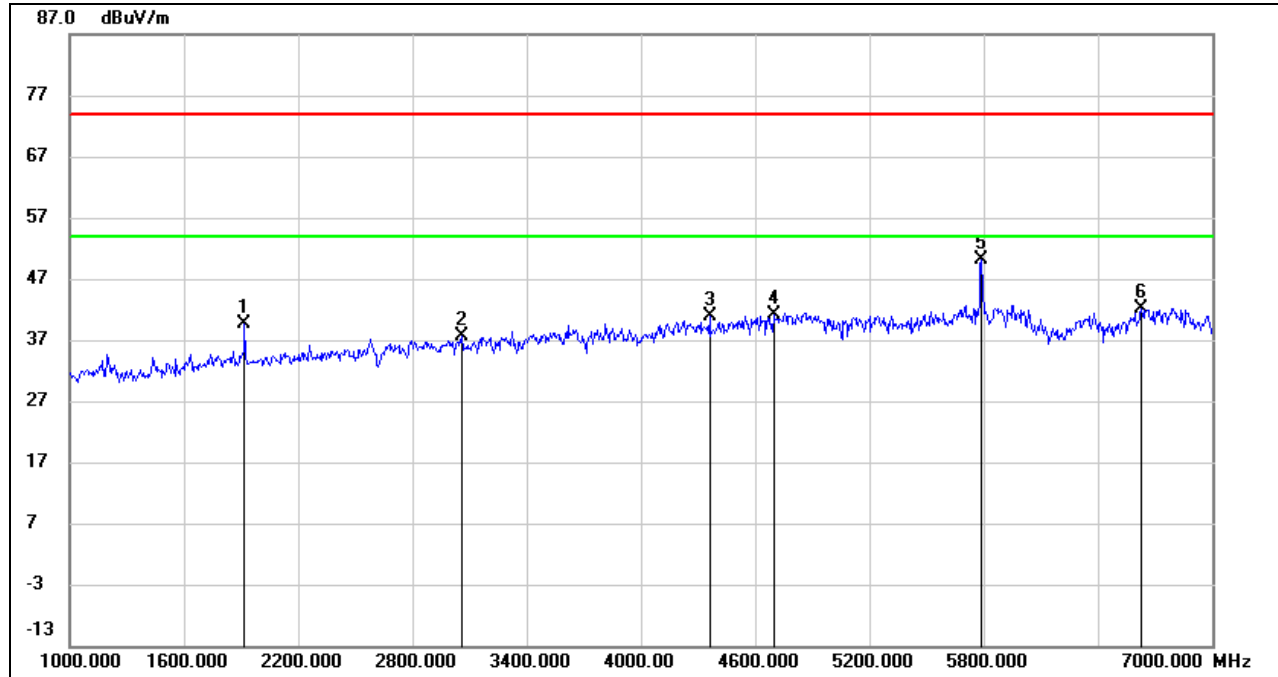

No.	Frequency (MHz)	Reading (dBuV)	Correct (dB/m)	Result (dBuV/m)	Limit (dBuV/m)	Margin (dB)	Remark
1	1918.000	49.71	-10.13	39.58	74.00	-34.42	peak
2	3058.000	43.03	-5.48	37.55	74.00	-36.45	peak
3	4360.000	42.68	-1.82	40.86	74.00	-33.14	peak
4	4696.000	41.18	-0.01	41.17	74.00	-32.83	peak
5	5785.000	47.62	2.50	50.12	74.00	-23.88	peak
6	6628.000	36.73	5.50	42.23	74.00	-31.77	peak

Note: 1. Measurement = Reading Level + Correct Factor.
 2. If Peak Result complies with AV limit, AV Result is deemed to comply with AV limit.
 3. Peak: Peak detector.
 4. Filter losses were only considered in the spurious frequency bands and the authorized band was not corrected for Band reject filter losses.
 5. Proper operation of the transmitter prior to adding the filter to the measurement chain.
 6. Since non-restricted band peak emissions are less than the average limit, they also comply with the -27dBm/MHz (68.2dBuV/m) limit.

HARMONICS AND SPURIOUS EMISSIONS (MID CHANNEL, VERTICAL)

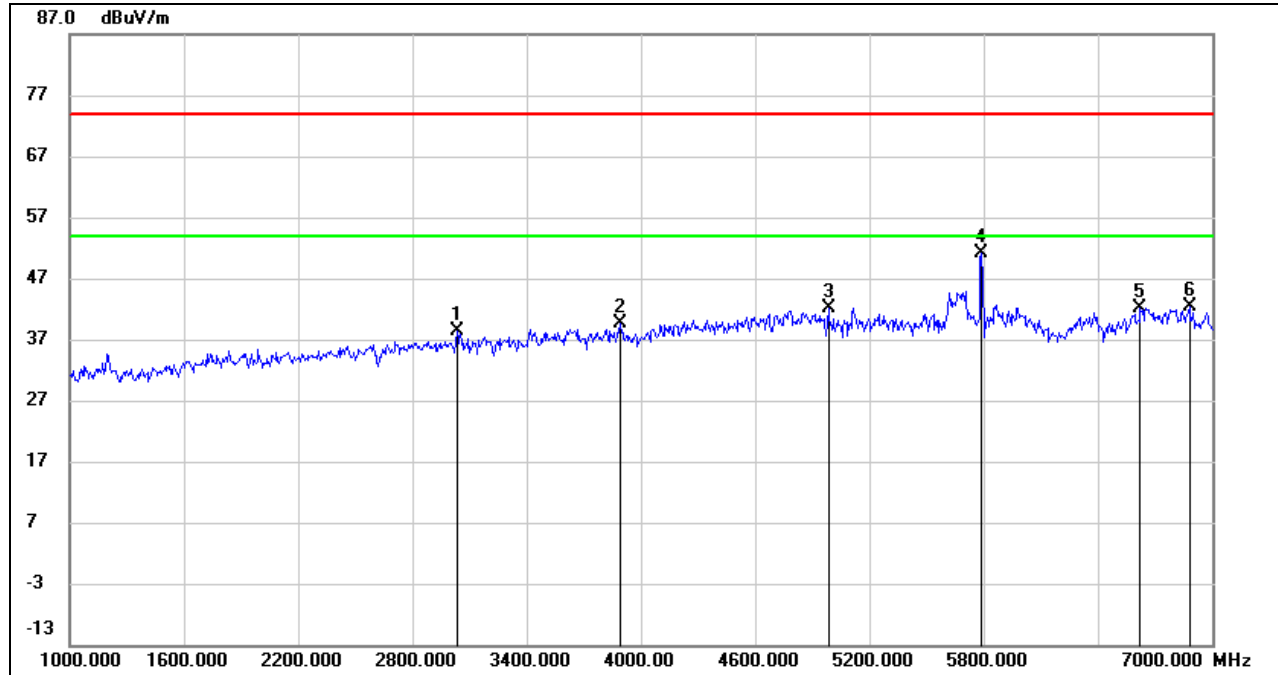

No.	Frequency (MHz)	Reading (dBuV)	Correct (dB/m)	Result (dBuV/m)	Limit (dBuV/m)	Margin (dB)	Remark
1	3034.000	43.91	-5.53	38.38	74.00	-35.62	peak
2	3892.000	43.02	-3.42	39.60	74.00	-34.40	peak
3	4984.000	41.14	0.87	42.01	74.00	-31.99	peak
4	5788.000	48.58	2.50	51.08	74.00	-22.92	peak
5	6622.000	36.60	5.51	42.11	74.00	-31.89	peak
6	6880.000	36.48	5.79	42.27	74.00	-31.73	peak

- Note: 1. Measurement = Reading Level + Correct Factor.
 2. If Peak Result complies with AV limit, AV Result is deemed to comply with AV limit.
 3. Peak: Peak detector.
 4. Filter losses were only considered in the spurious frequency bands and the authorized band was not corrected for Band reject filter losses.
 5. Proper operation of the transmitter prior to adding the filter to the measurement chain.
 6. Since non-restricted band peak emissions are less than the average limit, they also comply with the -27dBm/MHz (68.2dBuV/m) limit.

HARMONICS AND SPURIOUS EMISSIONS (HIGH CHANNEL, HORIZONTAL)

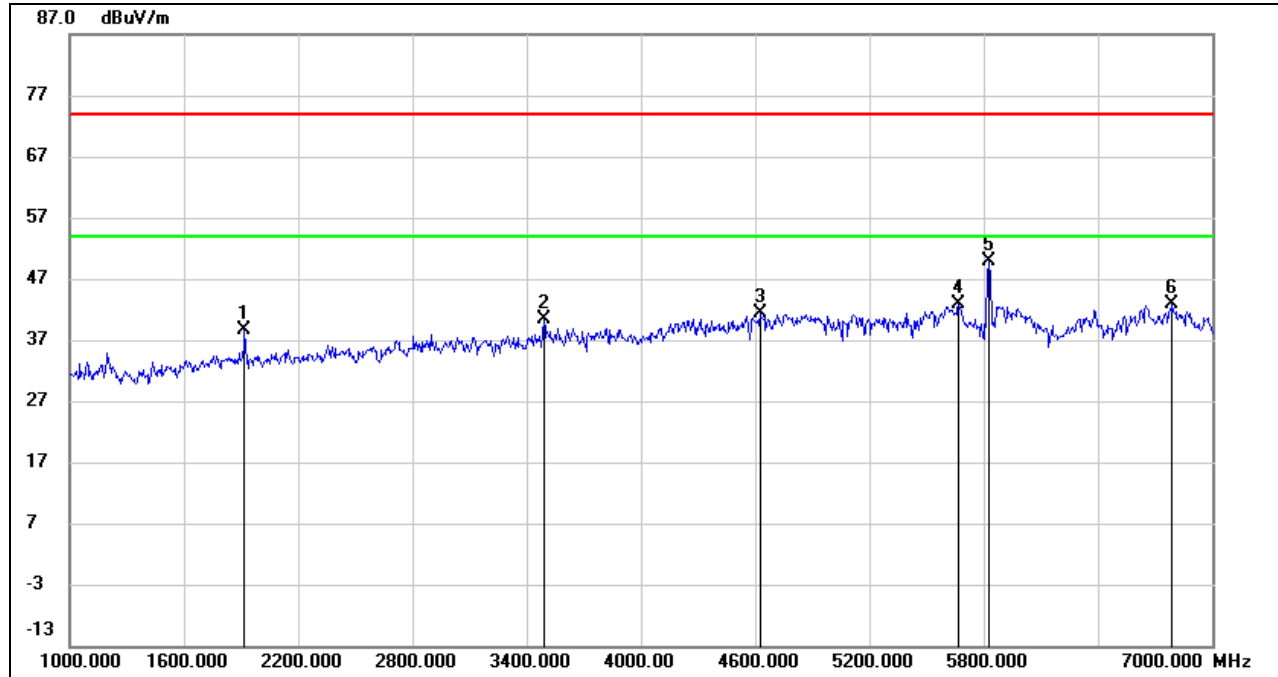

No.	Frequency (MHz)	Reading (dBuV)	Correct (dB/m)	Result (dBuV/m)	Limit (dBuV/m)	Margin (dB)	Remark
1	1918.000	48.80	-10.13	38.67	74.00	-35.33	peak
2	3490.000	45.20	-4.75	40.45	74.00	-33.55	peak
3	4624.000	41.73	-0.43	41.30	74.00	-32.70	peak
4	5668.000	40.37	2.47	42.84	74.00	-31.16	peak
5	5830.000	47.35	2.63	49.98	74.00	-24.02	peak
6	6790.000	37.35	5.57	42.92	74.00	-31.08	peak

Note: 1. Measurement = Reading Level + Correct Factor.
 2. If Peak Result complies with AV limit, AV Result is deemed to comply with AV limit.
 3. Peak: Peak detector.
 4. Filter losses were only considered in the spurious frequency bands and the authorized band was not corrected for Band reject filter losses.
 5. Proper operation of the transmitter prior to adding the filter to the measurement chain.
 6. Since non-restricted band peak emissions are less than the average limit, they also comply with the -27dBm/MHz (68.2dBuV/m) limit.

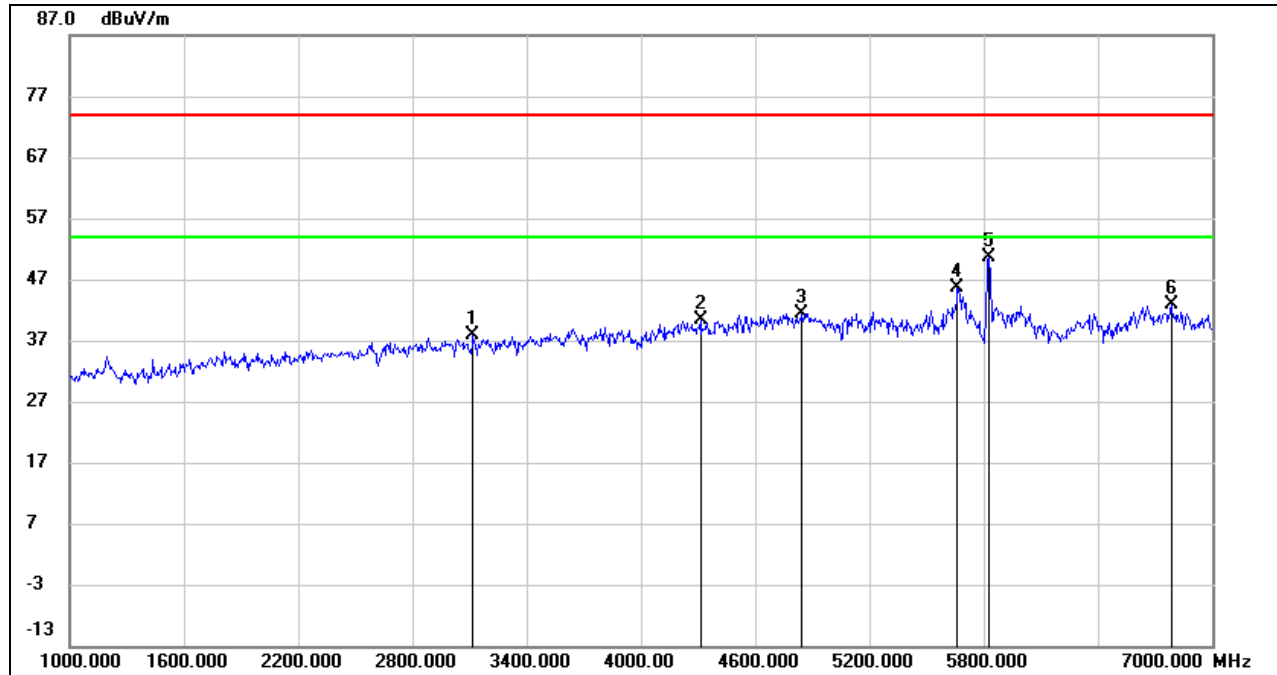
**HARMONICS AND SPURIOUS EMISSIONS (HIGH CHANNEL, VERTICAL)**

No.	Frequency (MHz)	Reading (dBuV)	Correct (dB/m)	Result (dBuV/m)	Limit (dBuV/m)	Margin (dB)	Remark
1	3118.000	43.18	-5.40	37.78	74.00	-36.22	peak
2	4312.000	42.22	-1.78	40.44	74.00	-33.56	peak
3	4846.000	40.82	0.66	41.48	74.00	-32.52	peak
4	5662.000	43.27	2.47	45.74	74.00	-28.26	peak
5	5830.000	48.03	2.63	50.66	74.00	-23.34	peak
6	6784.000	37.43	5.56	42.99	74.00	-31.01	peak

Note: 1. Measurement = Reading Level + Correct Factor.

2. If Peak Result complies with AV limit, AV Result is deemed to comply with AV limit.

3. Peak: Peak detector.

4. Filter losses were only considered in the spurious frequency bands and the authorized band was not corrected for Band reject filter losses.

5. Proper operation of the transmitter prior to adding the filter to the measurement chain.

6. Since non-restricted band peak emissions are less than the average limit, they also comply with the -27dBm/MHz (68.2dBuV/m) limit.

Note: All the modes, bands and antennas had been tested, but only the worst data was recorded in the report.



8.3. SPURIOUS EMISSIONS (7 GHz ~ 18 GHz)

8.3.1. 802.11a SISO MODE

UNII-1 BAND

ANTENNA 1 TEST RESULTS (WORST CASE)

HARMONICS AND SPURIOUS EMISSIONS (LOW CHANNEL, HORIZONTAL)

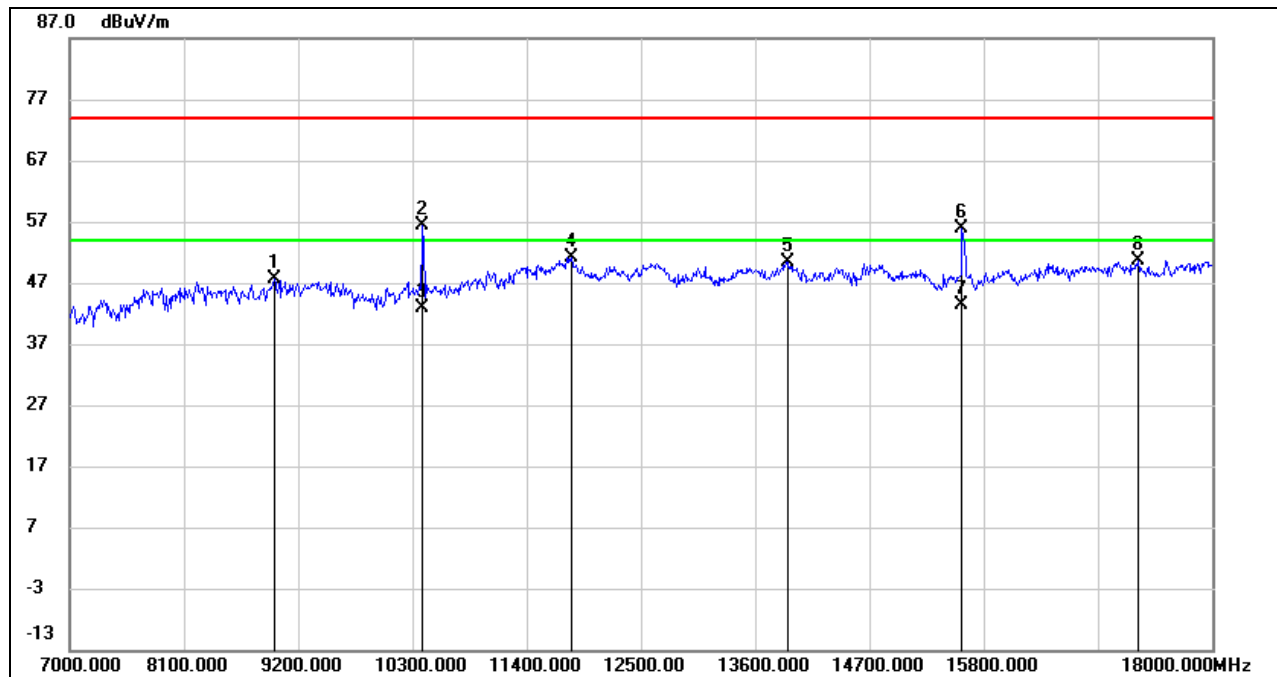

No.	Frequency (MHz)	Reading (dBuV)	Correct (dB/m)	Result (dBuV/m)	Limit (dBuV/m)	Margin (dB)	Remark
1	8969.000	37.32	10.31	47.63	74.00	-26.37	peak
2	10399.000	45.02	11.45	56.47	74.00	-17.53	peak
3	10399.000	31.48	11.45	42.93	54.00	-11.07	AVG
4	11829.000	35.56	15.57	51.13	74.00	-22.87	peak
5	13919.000	33.56	16.89	50.45	74.00	-23.55	peak
6	15591.000	39.16	16.68	55.84	74.00	-18.16	peak
7	15591.000	26.81	16.68	43.49	54.00	-10.51	AVG
8	17285.000	29.81	20.92	50.73	74.00	-23.27	peak

Note: 1. Measurement = Reading Level + Correct Factor.

2. If Peak Result complies with AV limit, AV Result is deemed to comply with AV limit.

3. Peak: Peak detector.

4. AVG: $VBW=1/Ton$, where: Ton is the transmitting duration.

5. For the transmitting duration, please refer to clause 7.1.

6. Filter losses were only considered in the spurious frequency bands and the authorized band was not corrected for High Pass Filter losses.

7. Proper operation of the transmitter prior to adding the filter to the measurement chain.

8. Since non-restricted band peak emissions are less than the average limit, they also comply with the -27dBm/MHz (68.2dBuV/m) limit.

HARMONICS AND SPURIOUS EMISSIONS (LOW CHANNEL, VERTICAL)

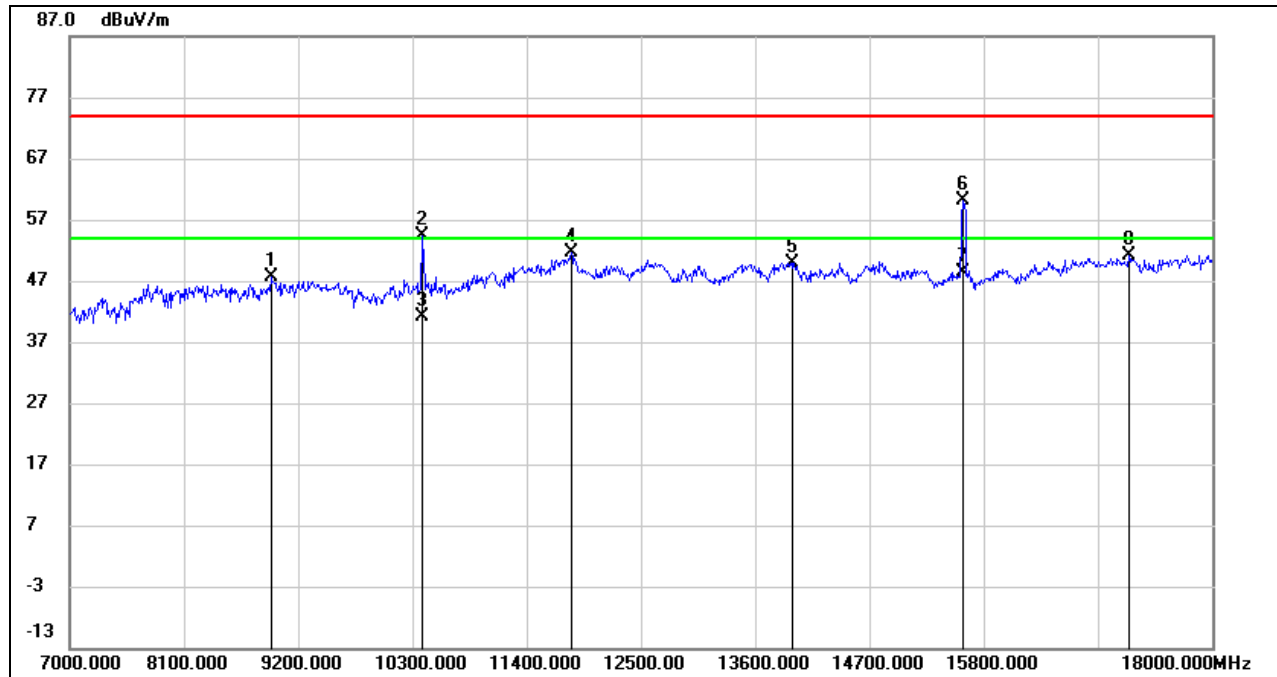

No.	Frequency (MHz)	Reading (dBuV)	Correct (dB/m)	Result (dBuV/m)	Limit (dBuV/m)	Margin (dB)	Remark
1	8936.000	37.64	9.96	47.60	74.00	-26.40	peak
2	10388.000	42.98	11.41	54.39	74.00	-19.61	peak
3	10388.000	29.72	11.41	41.13	54.00	-12.87	AVG
4	11829.000	35.98	15.57	51.55	74.00	-22.45	peak
5	13963.000	33.11	16.87	49.98	74.00	-24.02	peak
6	15602.000	43.53	16.70	60.23	74.00	-13.77	peak
7	15602.000	31.71	16.70	48.41	54.00	-5.59	AVG
8	17197.000	30.01	21.03	51.04	74.00	-22.96	peak

- Note:
1. Measurement = Reading Level + Correct Factor.
 2. If Peak Result complies with AV limit, AV Result is deemed to comply with AV limit.
 3. Peak: Peak detector.
 4. AVG: $VBW=1/Ton$, where: Ton is the transmitting duration.
 5. For the transmitting duration, please refer to clause 7.1.
 6. Filter losses were only considered in the spurious frequency bands and the authorized band was not corrected for High Pass Filter losses.
 7. Proper operation of the transmitter prior to adding the filter to the measurement chain.
 8. Since non-restricted band peak emissions are less than the average limit, they also comply with the -27dBm/MHz (68.2dBuV/m) limit.



HARMONICS AND SPURIOUS EMISSIONS (MID CHANNEL, HORIZONTAL)

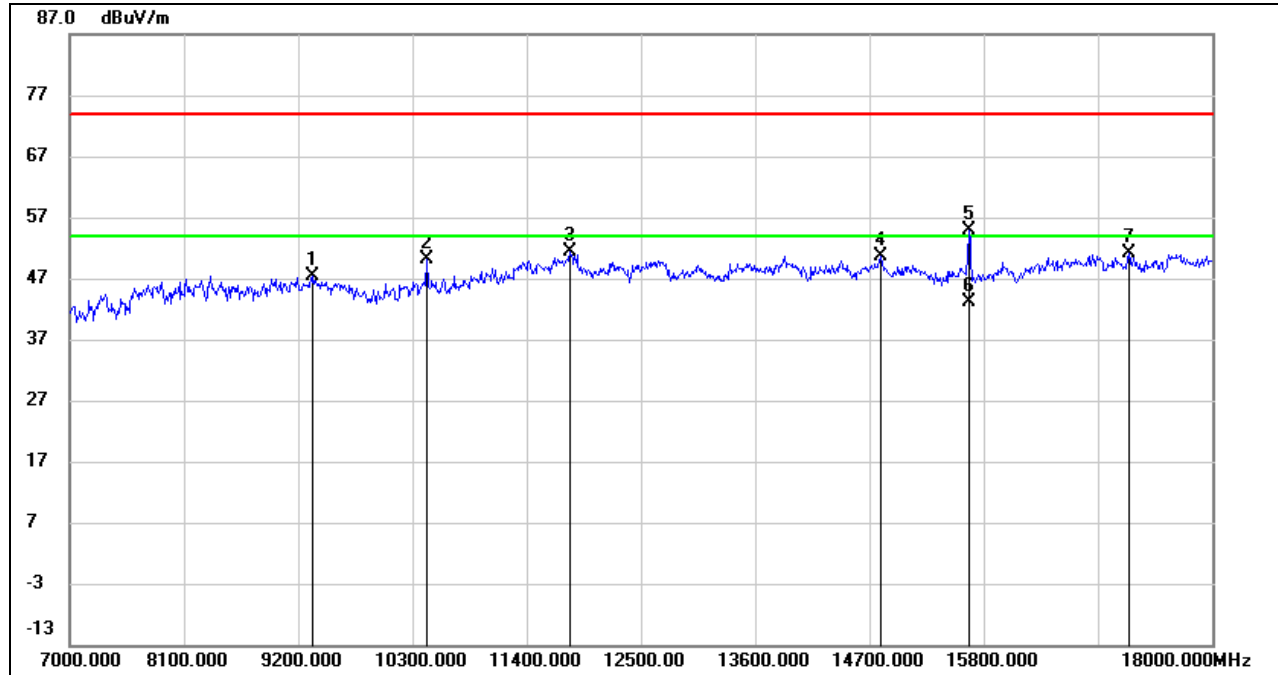

No.	Frequency (MHz)	Reading (dBuV)	Correct (dB/m)	Result (dBuV/m)	Limit (dBuV/m)	Margin (dB)	Remark
1	9343.000	37.32	10.02	47.34	74.00	-26.66	peak
2	10443.000	38.52	11.67	50.19	74.00	-23.81	peak
3	11818.000	35.82	15.58	51.40	74.00	-22.60	peak
4	14810.000	33.75	16.80	50.55	74.00	-23.45	peak
5	15657.000	38.07	16.73	54.80	74.00	-19.20	peak
6	15657.000	26.37	16.73	43.10	54.00	-10.90	AVG
7	17197.000	30.09	21.03	51.12	74.00	-22.88	peak

- Note:
1. Measurement = Reading Level + Correct Factor.
 2. If Peak Result complies with AV limit, AV Result is deemed to comply with AV limit.
 3. Peak: Peak detector.
 4. AVG: VBW=1/Ton, where: Ton is the transmitting duration.
 5. For the transmitting duration, please refer to clause 7.1.
 6. Filter losses were only considered in the spurious frequency bands and the authorized band was not corrected for High Pass Filter losses.
 7. Proper operation of the transmitter prior to adding the filter to the measurement chain.
 8. Since non-restricted band peak emissions are less than the average limit, they also comply with the -27dBm/MHz (68.2dBuV/m) limit.

HARMONICS AND SPURIOUS EMISSIONS (MID CHANNEL, VERTICAL)

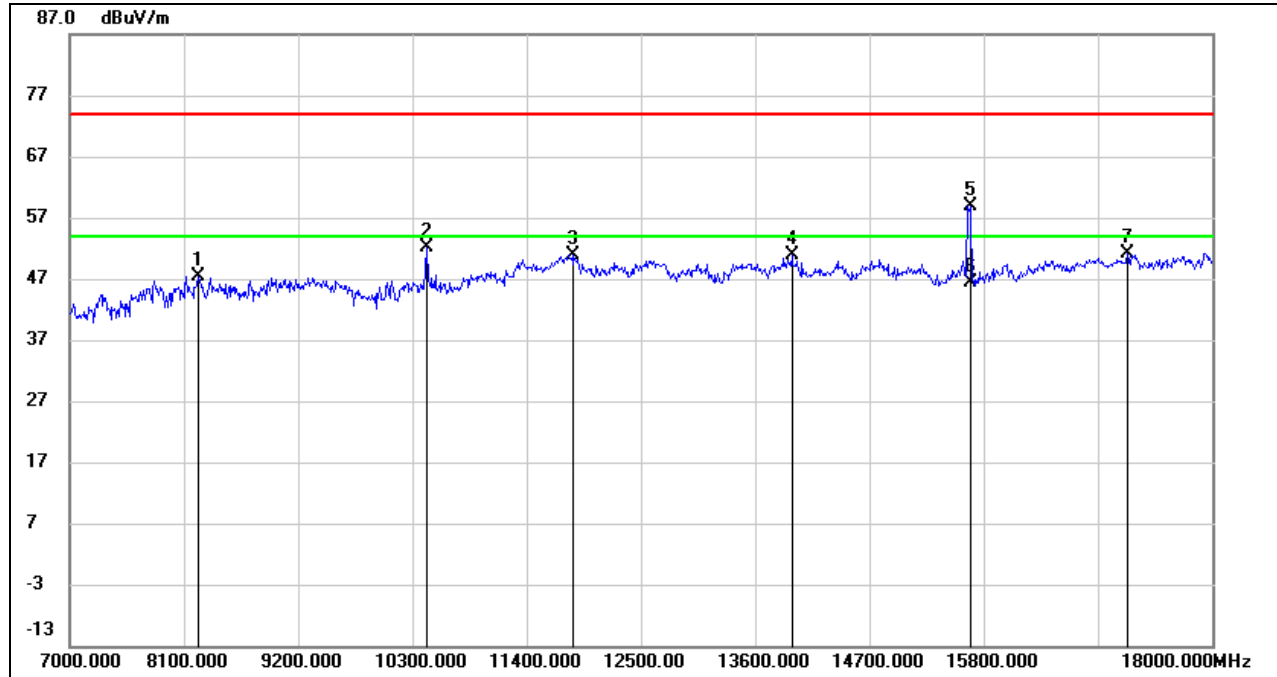

No.	Frequency (MHz)	Reading (dBuV)	Correct (dB/m)	Result (dBuV/m)	Limit (dBuV/m)	Margin (dB)	Remark
1	8232.000	38.16	9.23	47.39	74.00	-26.61	peak
2	10443.000	40.48	11.67	52.15	74.00	-21.85	peak
3	11840.000	35.22	15.56	50.78	74.00	-23.22	peak
4	13952.000	34.01	16.88	50.89	74.00	-23.11	peak
5	15668.000	42.19	16.75	58.94	74.00	-15.06	peak
6	15668.000	29.73	16.75	46.48	54.00	-7.52	AVG
7	17186.000	30.03	20.98	51.01	74.00	-22.99	peak

- Note: 1. Measurement = Reading Level + Correct Factor.
 2. If Peak Result complies with AV limit, AV Result is deemed to comply with AV limit.
 3. Peak: Peak detector.
 4. AVG: $VBW=1/Ton$, where: Ton is the transmitting duration.
 5. For the transmitting duration, please refer to clause 7.1.
 6. Filter losses were only considered in the spurious frequency bands and the authorized band was not corrected for High Pass Filter losses.
 7. Proper operation of the transmitter prior to adding the filter to the measurement chain.
 8. Since non-restricted band peak emissions are less than the average limit, they also comply with the -27dBm/MHz (68.2dBuV/m) limit.



HARMONICS AND SPURIOUS EMISSIONS (HIGH CHANNEL, HORIZONTAL)

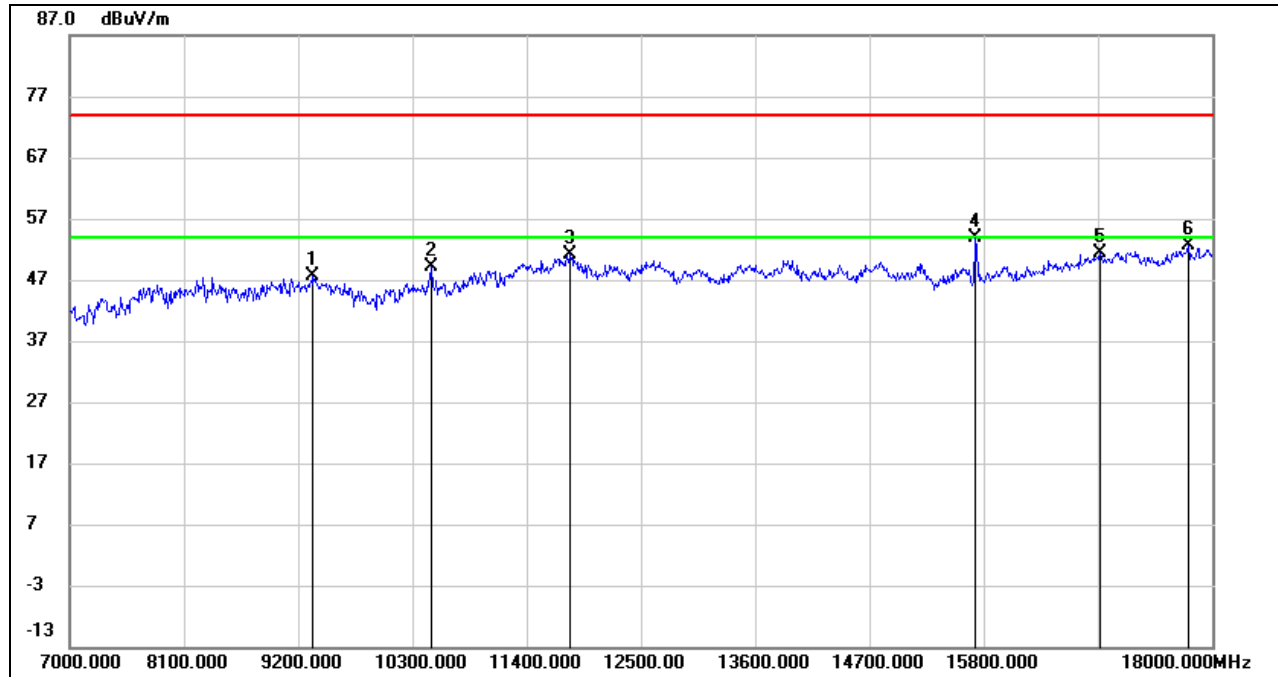

No.	Frequency (MHz)	Reading (dBuV)	Correct (dB/m)	Result (dBuV/m)	Limit (dBuV/m)	Margin (dB)	Remark
1	9343.000	37.53	10.02	47.55	74.00	-26.45	peak
2	10487.000	37.21	11.89	49.10	74.00	-24.90	peak
3	11818.000	35.43	15.58	51.01	74.00	-22.99	peak
4	15723.000	37.17	16.77	53.94	74.00	-20.06	peak
5	16922.000	31.36	20.04	51.40	74.00	-22.60	peak
6	17769.000	30.22	22.48	52.70	74.00	-21.30	peak

Note: 1. Measurement = Reading Level + Correct Factor.
 2. If Peak Result complies with AV limit, AV Result is deemed to comply with AV limit.
 3. Peak: Peak detector.
 4. Filter losses were only considered in the spurious frequency bands and the authorized band was not corrected for High Pass Filter losses.
 5. Proper operation of the transmitter prior to adding the filter to the measurement chain.
 6. Since non-restricted band peak emissions are less than the average limit, they also comply with the -27dBm/MHz (68.2dBuV/m) limit.



HARMONICS AND SPURIOUS EMISSIONS (HIGH CHANNEL, VERTICAL)

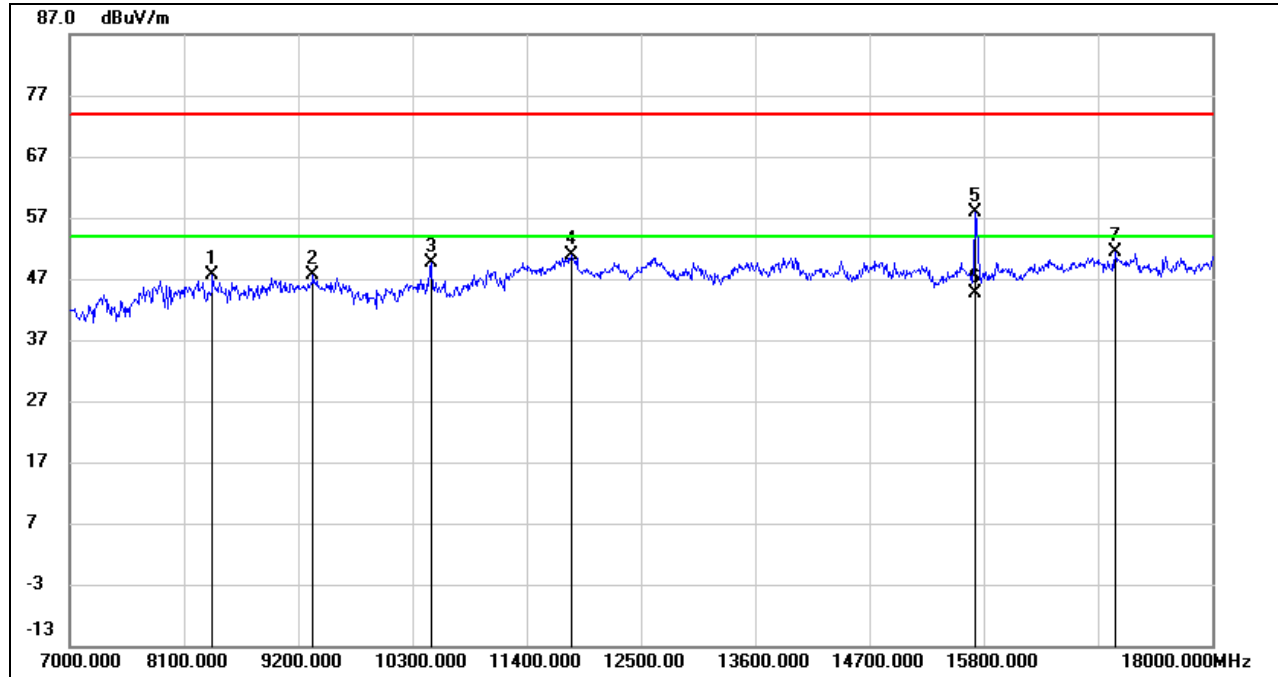

No.	Frequency (MHz)	Reading (dBuV)	Correct (dB/m)	Result (dBuV/m)	Limit (dBuV/m)	Margin (dB)	Remark
1	8375.000	38.86	8.68	47.54	74.00	-26.46	peak
2	9343.000	37.53	10.02	47.55	74.00	-26.45	peak
3	10476.000	37.84	11.83	49.67	74.00	-24.33	peak
4	11829.000	35.19	15.57	50.76	74.00	-23.24	peak
5	15712.000	41.13	16.77	57.90	74.00	-16.10	peak
6	15712.000	27.88	16.77	44.65	54.00	-9.35	AVG
7	17065.000	30.97	20.49	51.46	74.00	-22.54	peak

- Note:
1. Measurement = Reading Level + Correct Factor.
 2. If Peak Result complies with AV limit, AV Result is deemed to comply with AV limit.
 3. Peak: Peak detector.
 4. AVG: VBW=1/Ton, where: Ton is the transmitting duration.
 5. For the transmitting duration, please refer to clause 7.1.
 6. Filter losses were only considered in the spurious frequency bands and the authorized band was not corrected for High Pass Filter losses.
 7. Proper operation of the transmitter prior to adding the filter to the measurement chain.
 8. Since non-restricted band peak emissions are less than the average limit, they also comply with the -27dBm/MHz (68.2dBuV/m) limit.



UNII-2A BAND

ANTENNA 1 TEST RESULTS (WORST CASE)

HARMONICS AND SPURIOUS EMISSIONS (LOW CHANNEL, HORIZONTAL)

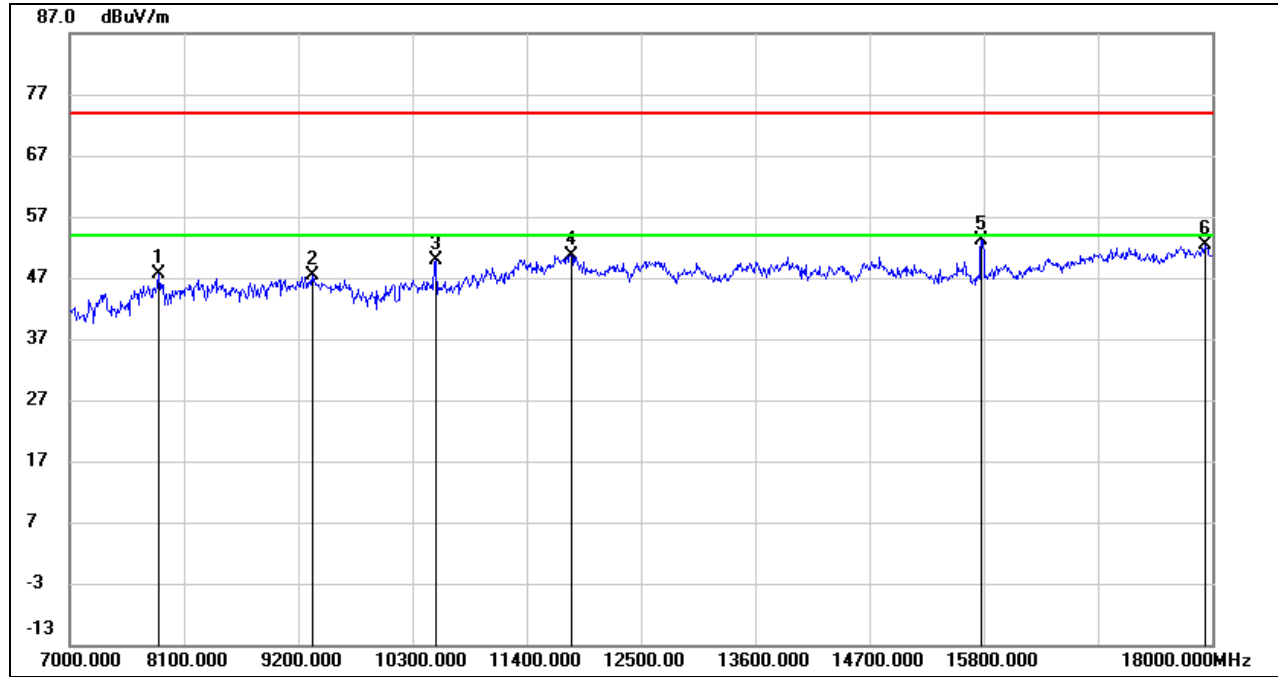

No.	Frequency (MHz)	Reading (dBuV)	Correct (dB/m)	Result (dBuV/m)	Limit (dBuV/m)	Margin (dB)	Remark
1	7858.000	39.46	8.08	47.54	74.00	-26.46	peak
2	9332.000	37.35	9.97	47.32	74.00	-26.68	peak
3	10520.000	37.95	12.04	49.99	74.00	-24.01	peak
4	11829.000	35.06	15.57	50.63	74.00	-23.37	peak
5	15778.000	36.25	16.82	53.07	74.00	-20.93	peak
6	17934.000	29.70	22.69	52.39	74.00	-21.61	peak

Note: 1. Measurement = Reading Level + Correct Factor.
 2. If Peak Result complies with AV limit, AV Result is deemed to comply with AV limit.
 3. Peak: Peak detector.
 4. Filter losses were only considered in the spurious frequency bands and the authorized band was not corrected for High Pass Filter losses.
 5. Proper operation of the transmitter prior to adding the filter to the measurement chain.
 6. Since non-restricted band peak emissions are less than the average limit, they also comply with the -27dBm/MHz (68.2dBuV/m) limit.

HARMONICS AND SPURIOUS EMISSIONS (LOW CHANNEL, VERTICAL)

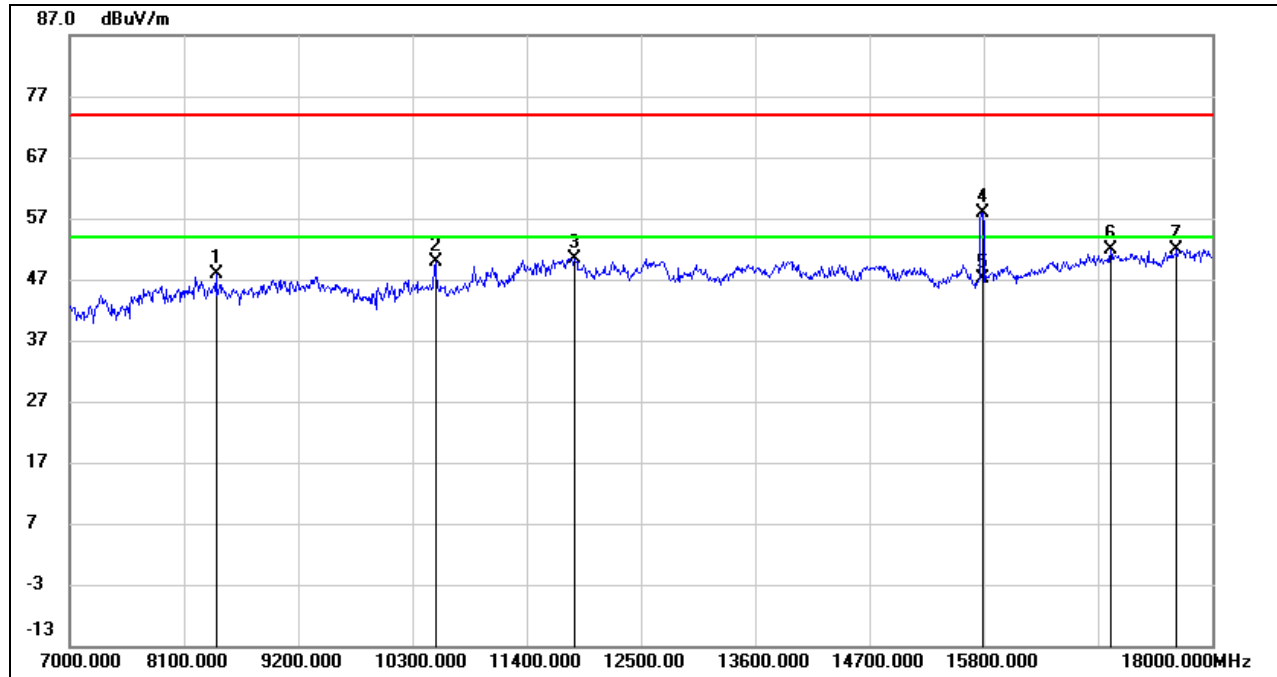

No.	Frequency (MHz)	Reading (dBuV)	Correct (dB/m)	Result (dBuV/m)	Limit (dBuV/m)	Margin (dB)	Remark
1	8408.000	39.17	8.59	47.76	74.00	-26.24	peak
2	10520.000	37.82	12.04	49.86	74.00	-24.14	peak
3	11862.000	34.96	15.52	50.48	74.00	-23.52	peak
4	15789.000	41.11	16.82	57.93	74.00	-16.07	peak
5	15789.000	30.32	16.82	47.14	54.00	-6.86	AVG
6	17021.000	31.46	20.32	51.78	74.00	-22.22	peak
7	17659.000	30.34	21.63	51.97	74.00	-22.03	peak

- Note:
1. Measurement = Reading Level + Correct Factor.
 2. If Peak Result complies with AV limit, AV Result is deemed to comply with AV limit.
 3. Peak: Peak detector.
 4. AVG: $VBW=1/Ton$, where: Ton is the transmitting duration.
 5. For the transmitting duration, please refer to clause 7.1.
 6. Filter losses were only considered in the spurious frequency bands and the authorized band was not corrected for High Pass Filter losses.
 7. Proper operation of the transmitter prior to adding the filter to the measurement chain.
 8. Since non-restricted band peak emissions are less than the average limit, they also comply with the -27dBm/MHz (68.2dBuV/m) limit.



HARMONICS AND SPURIOUS EMISSIONS (MID CHANNEL, HORIZONTAL)

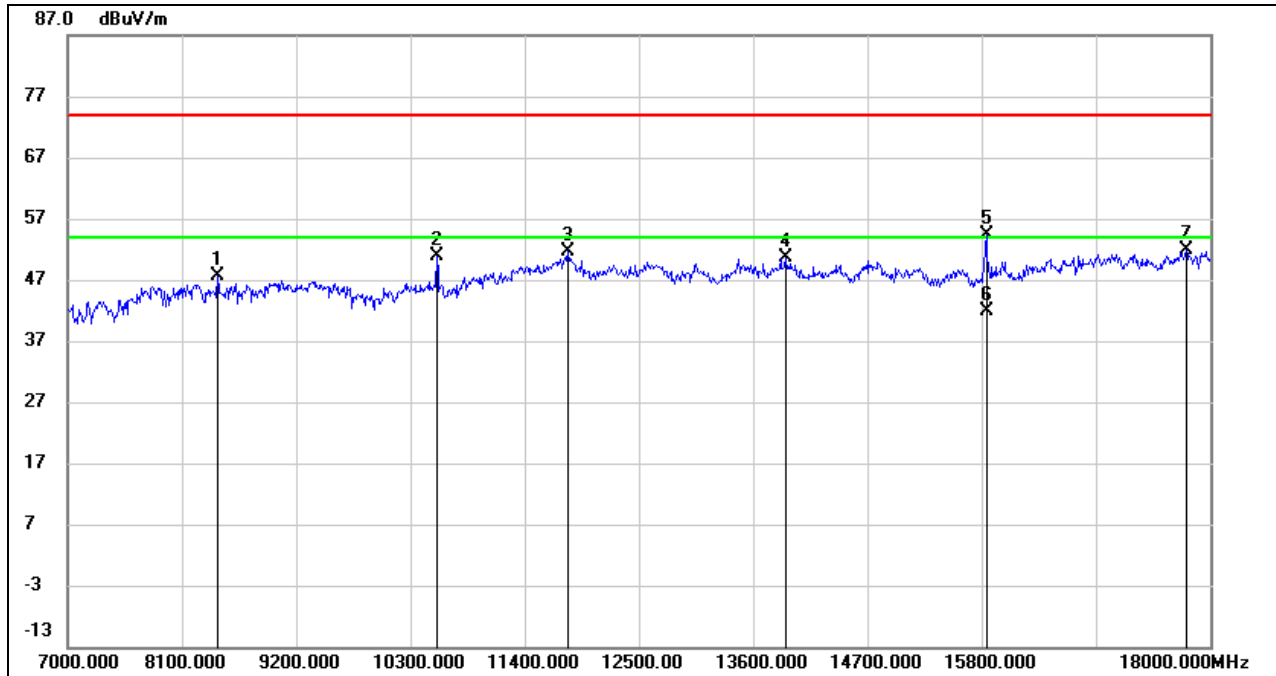

No.	Frequency (MHz)	Reading (dBuV)	Correct (dB/m)	Result (dBuV/m)	Limit (dBuV/m)	Margin (dB)	Remark
1	8441.000	39.16	8.56	47.72	74.00	-26.28	peak
2	10553.000	38.66	12.17	50.83	74.00	-23.17	peak
3	11818.000	36.06	15.58	51.64	74.00	-22.36	peak
4	13908.000	33.75	16.90	50.65	74.00	-23.35	peak
5	15844.000	37.42	16.92	54.34	74.00	-19.66	peak
6	15844.000	25.06	16.92	41.98	54.00	-12.02	AVG
7	17769.000	29.42	22.48	51.90	74.00	-22.10	peak

- Note:
1. Measurement = Reading Level + Correct Factor.
 2. If Peak Result complies with AV limit, AV Result is deemed to comply with AV limit.
 3. Peak: Peak detector.
 4. AVG: $VBW=1/Ton$, where: Ton is the transmitting duration.
 5. For the transmitting duration, please refer to clause 7.1.
 6. Filter losses were only considered in the spurious frequency bands and the authorized band was not corrected for High Pass Filter losses.
 7. Proper operation of the transmitter prior to adding the filter to the measurement chain.
 8. Since non-restricted band peak emissions are less than the average limit, they also comply with the -27dBm/MHz (68.2dBuV/m) limit.



HARMONICS AND SPURIOUS EMISSIONS (MID CHANNEL, VERTICAL)

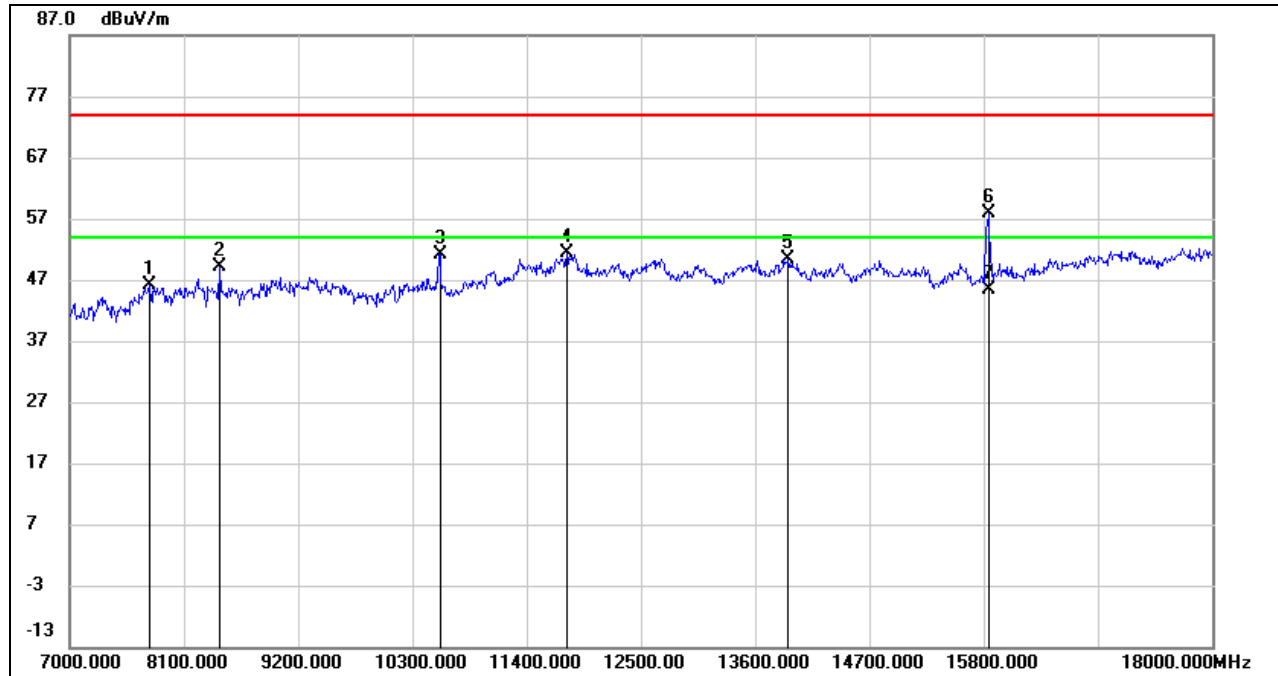

No.	Frequency (MHz)	Reading (dBuV)	Correct (dB/m)	Result (dBuV/m)	Limit (dBuV/m)	Margin (dB)	Remark
1	7770.000	37.98	8.14	46.12	74.00	-27.88	peak
2	8441.000	40.53	8.56	49.09	74.00	-24.91	peak
3	10564.000	39.01	12.21	51.22	74.00	-22.78	peak
4	11785.000	35.82	15.52	51.34	74.00	-22.66	peak
5	13919.000	33.52	16.89	50.41	74.00	-23.59	peak
6	15844.000	40.87	16.92	57.79	74.00	-16.21	peak
7	15844.000	28.44	16.92	45.36	54.00	-8.64	AVG

- Note: 1. Measurement = Reading Level + Correct Factor.
 2. If Peak Result complies with AV limit, AV Result is deemed to comply with AV limit.
 3. Peak: Peak detector.
 4. AVG: VBW=1/Ton, where: Ton is the transmitting duration.
 5. For the transmitting duration, please refer to clause 7.1.
 6. Filter losses were only considered in the spurious frequency bands and the authorized band was not corrected for High Pass Filter losses.
 7. Proper operation of the transmitter prior to adding the filter to the measurement chain.
 8. Since non-restricted band peak emissions are less than the average limit, they also comply with the -27dBm/MHz (68.2dBuV/m) limit.



HARMONICS AND SPURIOUS EMISSIONS (HIGH CHANNEL, HORIZONTAL)

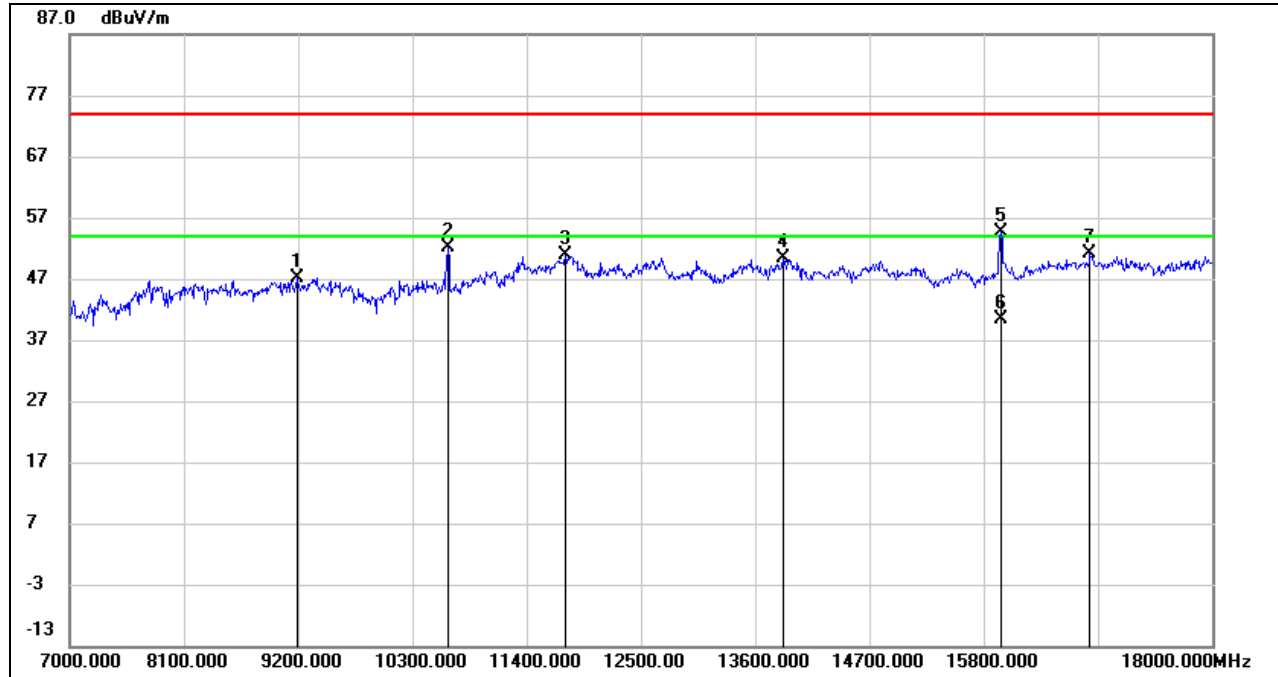

No.	Frequency (MHz)	Reading (dBuV)	Correct (dB/m)	Result (dBuV/m)	Limit (dBuV/m)	Margin (dB)	Remark
1	9189.000	37.70	9.36	47.06	74.00	-26.94	peak
2	10641.000	39.61	12.42	52.03	74.00	-21.97	peak
3	11774.000	35.44	15.47	50.91	74.00	-23.09	peak
4	13864.000	33.48	16.92	50.40	74.00	-23.60	peak
5	15965.000	37.37	17.16	54.53	74.00	-19.47	peak
6	15965.000	23.32	17.16	40.48	54.00	-13.52	AVG
7	16823.000	31.33	19.80	51.13	74.00	-22.87	peak

- Note: 1. Measurement = Reading Level + Correct Factor.
 2. If Peak Result complies with AV limit, AV Result is deemed to comply with AV limit.
 3. Peak: Peak detector.
 4. AVG: $VBW=1/Ton$, where: Ton is the transmitting duration.
 5. For the transmitting duration, please refer to clause 7.1.
 6. Filter losses were only considered in the spurious frequency bands and the authorized band was not corrected for High Pass Filter losses.
 7. Proper operation of the transmitter prior to adding the filter to the measurement chain.
 8. Since non-restricted band peak emissions are less than the average limit, they also comply with the -27dBm/MHz (68.2dBuV/m) limit.

HARMONICS AND SPURIOUS EMISSIONS (HIGH CHANNEL, VERTICAL)

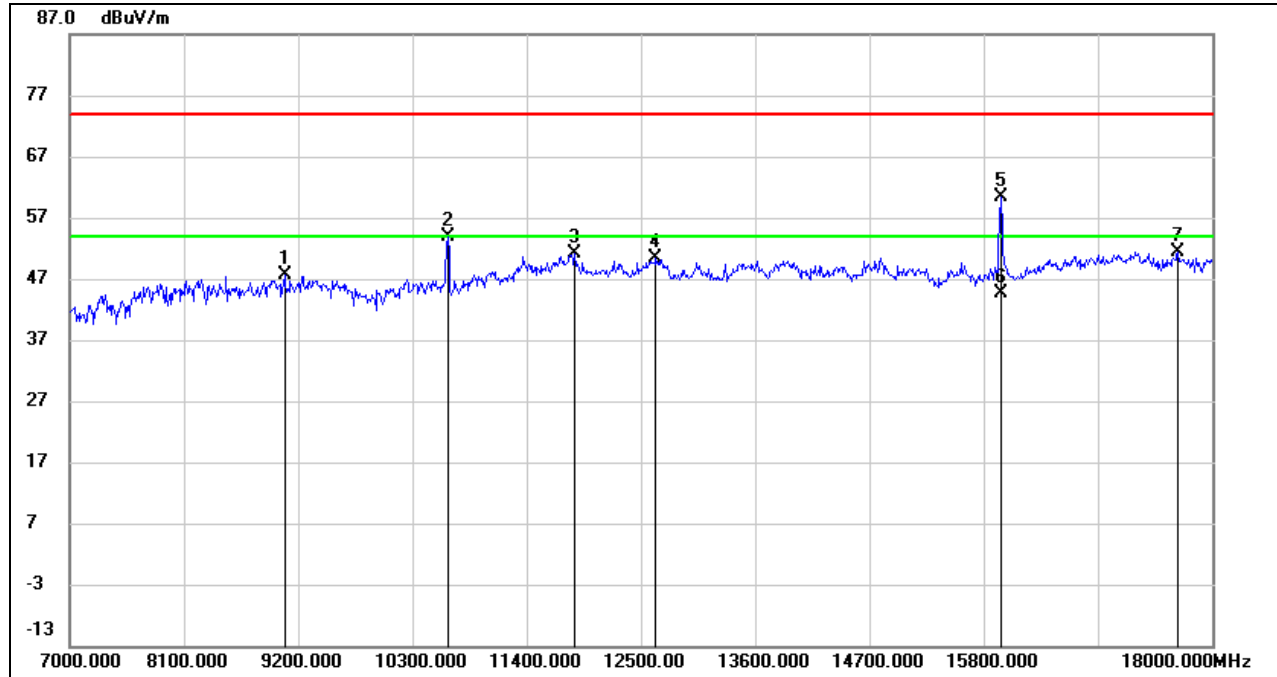

No.	Frequency (MHz)	Reading (dBuV)	Correct (dB/m)	Result (dBuV/m)	Limit (dBuV/m)	Margin (dB)	Remark
1	9068.000	37.35	10.17	47.52	74.00	-26.48	peak
2	10641.000	41.50	12.42	53.92	74.00	-20.08	peak
3	11862.000	35.49	15.52	51.01	74.00	-22.99	peak
4	12643.000	35.14	15.36	50.50	74.00	-23.50	peak
5	15965.000	43.34	17.16	60.50	74.00	-13.50	peak
6	15965.000	27.59	17.16	44.75	54.00	-9.25	AVG
7	17670.000	29.67	21.70	51.37	74.00	-22.63	peak

- Note: 1. Measurement = Reading Level + Correct Factor.
 2. If Peak Result complies with AV limit, AV Result is deemed to comply with AV limit.
 3. Peak: Peak detector.
 4. AVG: VBW=1/Ton, where: Ton is the transmitting duration.
 5. For the transmitting duration, please refer to clause 7.1.
 6. Filter losses were only considered in the spurious frequency bands and the authorized band was not corrected for High Pass Filter losses.
 7. Proper operation of the transmitter prior to adding the filter to the measurement chain.
 8. Since non-restricted band peak emissions are less than the average limit, they also comply with the -27dBm/MHz (68.2dBuV/m) limit.

UNII-2C BAND

ANTENNA 1 TEST RESULTS (WORST CASE)

HARMONICS AND SPURIOUS EMISSIONS (LOW CHANNEL, HORIZONTAL)

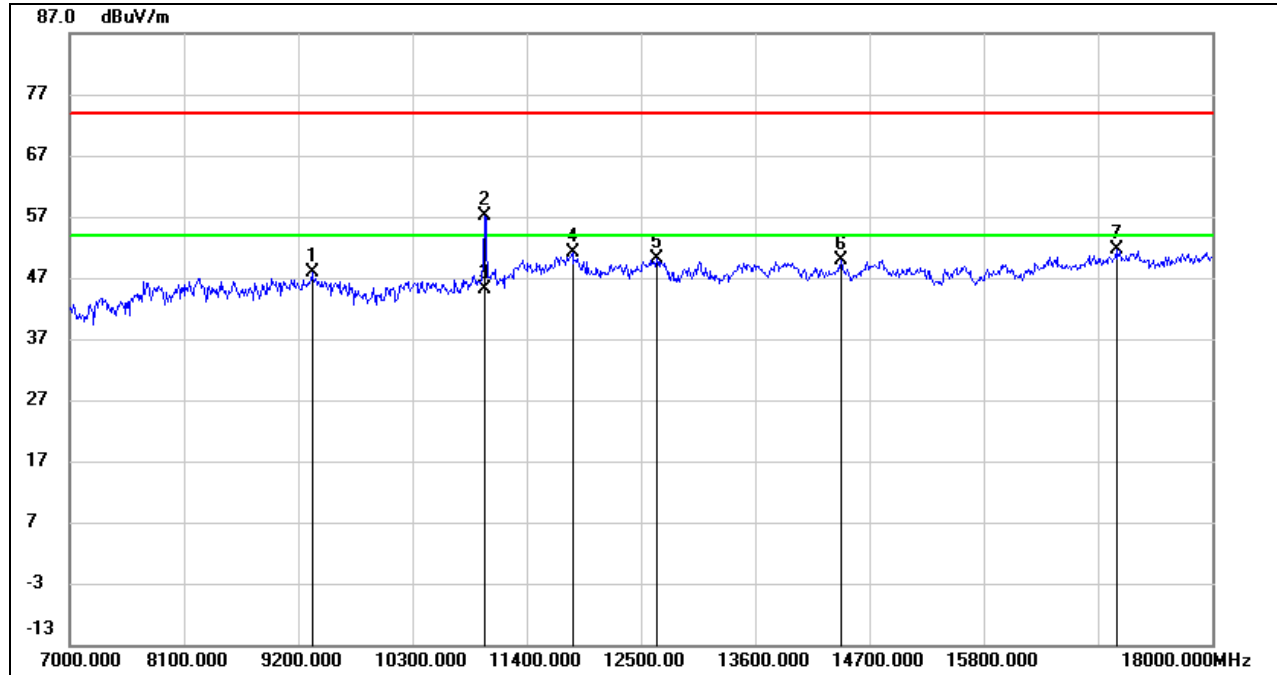

No.	Frequency (MHz)	Reading (dBuV)	Correct (dB/m)	Result (dBuV/m)	Limit (dBuV/m)	Margin (dB)	Remark
1	9332.000	37.85	9.97	47.82	74.00	-26.18	peak
2	10993.000	43.95	13.24	57.19	74.00	-16.81	peak
3	10993.000	31.92	13.24	45.16	54.00	-8.84	AVG
4	11840.000	35.56	15.56	51.12	74.00	-22.88	peak
5	12654.000	34.72	15.38	50.10	74.00	-23.90	peak
6	14425.000	33.05	16.80	49.85	74.00	-24.15	peak
7	17076.000	31.01	20.54	51.55	74.00	-22.45	peak

Note: 1. Measurement = Reading Level + Correct Factor.
 2. If Peak Result complies with AV limit, AV Result is deemed to comply with AV limit.
 3. Peak: Peak detector.
 4. AVG: VBW=1/Ton, where: Ton is the transmitting duration.
 5. For the transmitting duration, please refer to clause 7.1.
 6. Filter losses were only considered in the spurious frequency bands and the authorized band was not corrected for High Pass Filter losses.
 7. Proper operation of the transmitter prior to adding the filter to the measurement chain.
 8. Since non-restricted band peak emissions are less than the average limit, they also comply with the -27dBm/MHz (68.2dBuV/m) limit.



HARMONICS AND SPURIOUS EMISSIONS (LOW CHANNEL, VERTICAL)

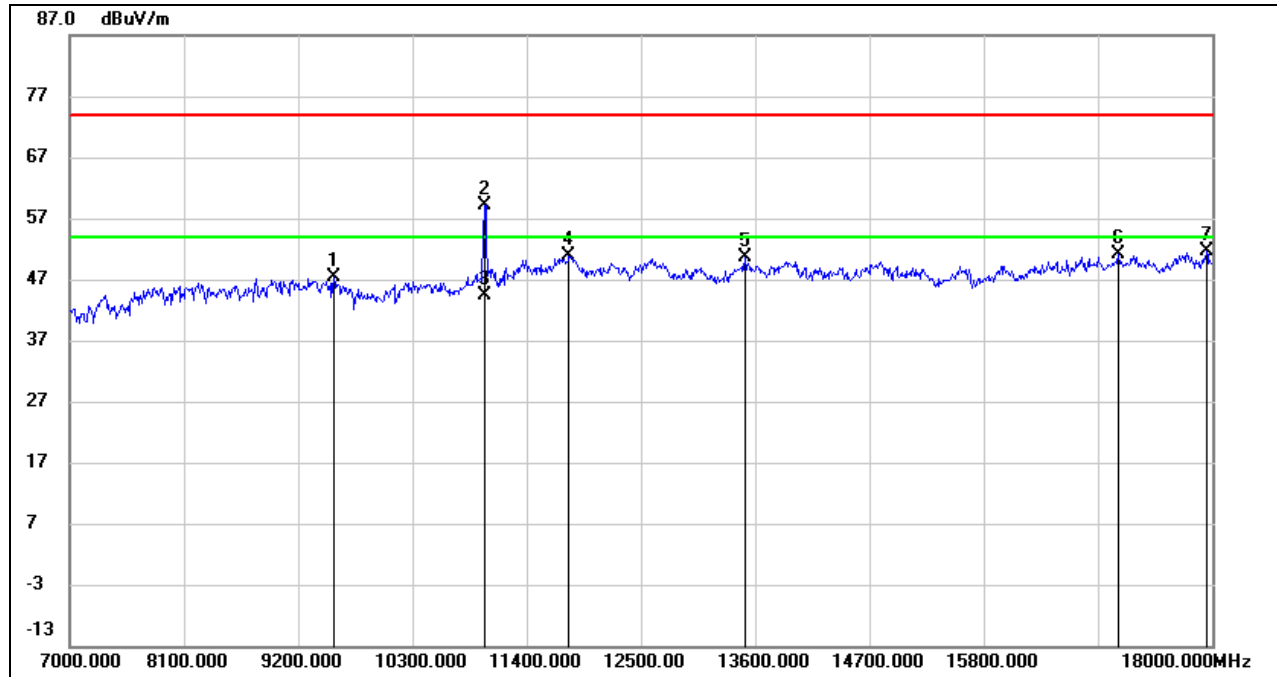

No.	Frequency (MHz)	Reading (dBuV)	Correct (dB/m)	Result (dBuV/m)	Limit (dBuV/m)	Margin (dB)	Remark
1	9541.000	36.83	10.45	47.28	74.00	-26.72	peak
2	10993.000	45.86	13.24	59.10	74.00	-14.90	peak
3	10993.000	31.03	13.24	44.27	54.00	-9.73	AVG
4	11807.000	35.19	15.61	50.80	74.00	-23.20	peak
5	13501.000	34.27	16.41	50.68	74.00	-23.32	peak
6	17098.000	30.53	20.63	51.16	74.00	-22.84	peak
7	17945.000	28.85	22.68	51.53	74.00	-22.47	peak

- Note: 1. Measurement = Reading Level + Correct Factor.
 2. If Peak Result complies with AV limit, AV Result is deemed to comply with AV limit.
 3. Peak: Peak detector.
 4. AVG: $VBW=1/Ton$, where: Ton is the transmitting duration.
 5. For the transmitting duration, please refer to clause 7.1.
 6. Filter losses were only considered in the spurious frequency bands and the authorized band was not corrected for High Pass Filter losses.
 7. Proper operation of the transmitter prior to adding the filter to the measurement chain.
 8. Since non-restricted band peak emissions are less than the average limit, they also comply with the -27dBm/MHz (68.2dBuV/m) limit.



HARMONICS AND SPURIOUS EMISSIONS (MID CHANNEL, HORIZONTAL)

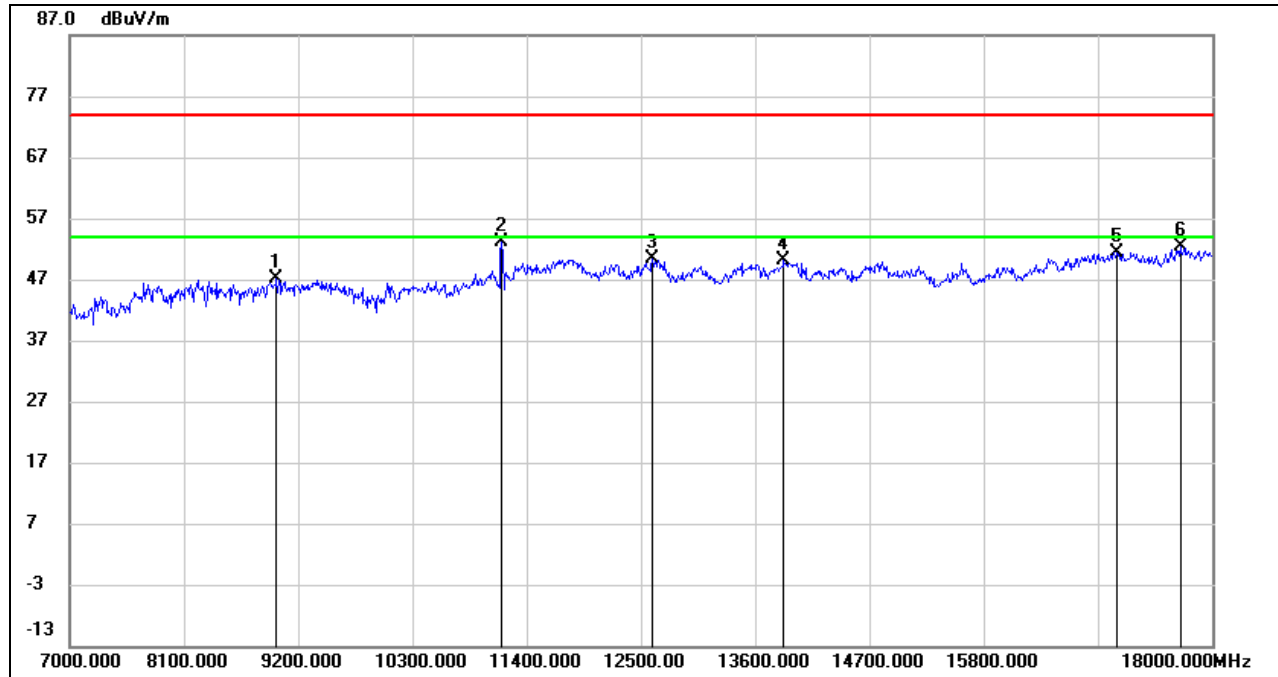

No.	Frequency (MHz)	Reading (dBuV)	Correct (dB/m)	Result (dBuV/m)	Limit (dBuV/m)	Margin (dB)	Remark
1	8991.000	36.54	10.53	47.07	74.00	-26.93	peak
2	11158.000	39.57	13.56	53.13	74.00	-20.87	peak
3	12610.000	35.11	15.30	50.41	74.00	-23.59	peak
4	13875.000	33.29	16.92	50.21	74.00	-23.79	peak
5	17087.000	30.84	20.58	51.42	74.00	-22.58	peak
6	17692.000	30.45	21.87	52.32	74.00	-21.68	peak

Note: 1. Measurement = Reading Level + Correct Factor.
 2. If Peak Result complies with AV limit, AV Result is deemed to comply with AV limit.
 3. Peak: Peak detector.
 4. Filter losses were only considered in the spurious frequency bands and the authorized band was not corrected for High Pass Filter losses.
 5. Proper operation of the transmitter prior to adding the filter to the measurement chain.
 6. Since non-restricted band peak emissions are less than the average limit, they also comply with the -27dBm/MHz (68.2dBuV/m) limit.



HARMONICS AND SPURIOUS EMISSIONS (MID CHANNEL, VERTICAL)

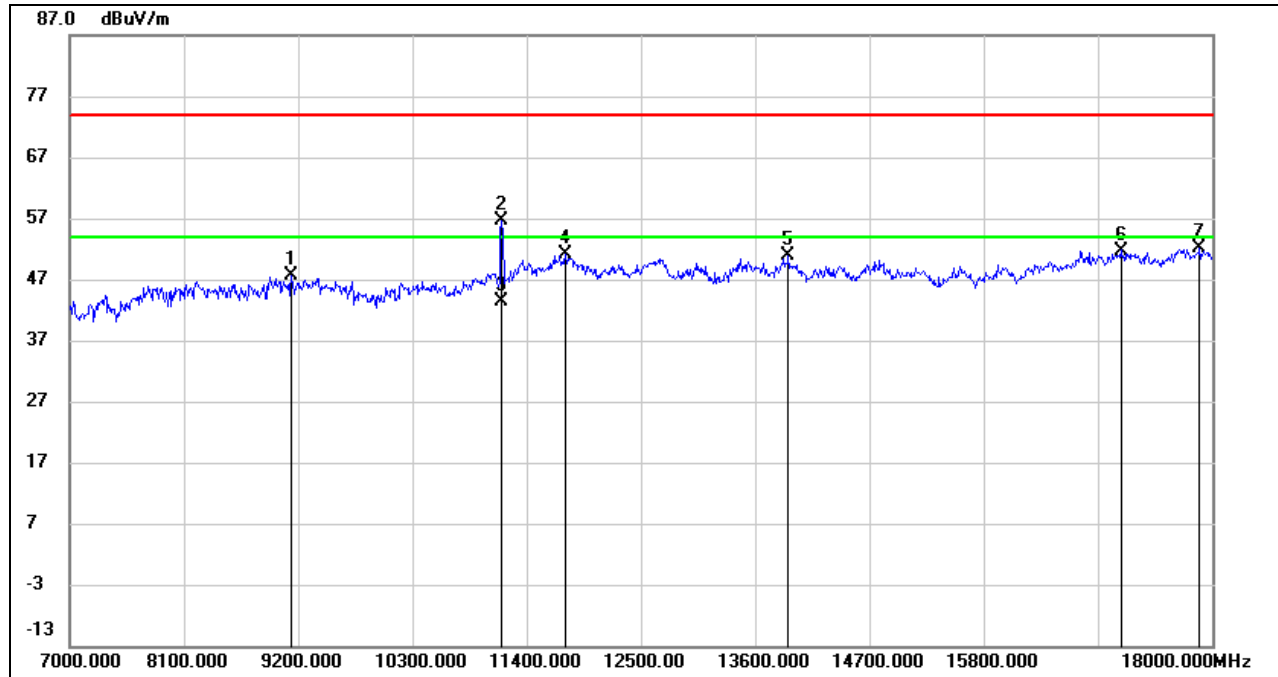

No.	Frequency (MHz)	Reading (dBuV)	Correct (dB/m)	Result (dBuV/m)	Limit (dBuV/m)	Margin (dB)	Remark
1	9134.000	37.85	9.73	47.58	74.00	-26.42	peak
2	11158.000	43.19	13.56	56.75	74.00	-17.25	peak
3	11158.000	29.91	13.56	43.47	54.00	-10.53	AVG
4	11774.000	35.56	15.47	51.03	74.00	-22.97	peak
5	13919.000	34.00	16.89	50.89	74.00	-23.11	peak
6	17120.000	31.03	20.72	51.75	74.00	-22.25	peak
7	17879.000	29.31	22.70	52.01	74.00	-21.99	peak

- Note: 1. Measurement = Reading Level + Correct Factor.
 2. If Peak Result complies with AV limit, AV Result is deemed to comply with AV limit.
 3. Peak: Peak detector.
 4. AVG: $VBW=1/Ton$, where: Ton is the transmitting duration.
 5. For the transmitting duration, please refer to clause 7.1.
 6. Filter losses were only considered in the spurious frequency bands and the authorized band was not corrected for High Pass Filter losses.
 7. Proper operation of the transmitter prior to adding the filter to the measurement chain.
 8. Since non-restricted band peak emissions are less than the average limit, they also comply with the -27dBm/MHz (68.2dBuV/m) limit.



HARMONICS AND SPURIOUS EMISSIONS (HIGH CHANNEL, HORIZONTAL)

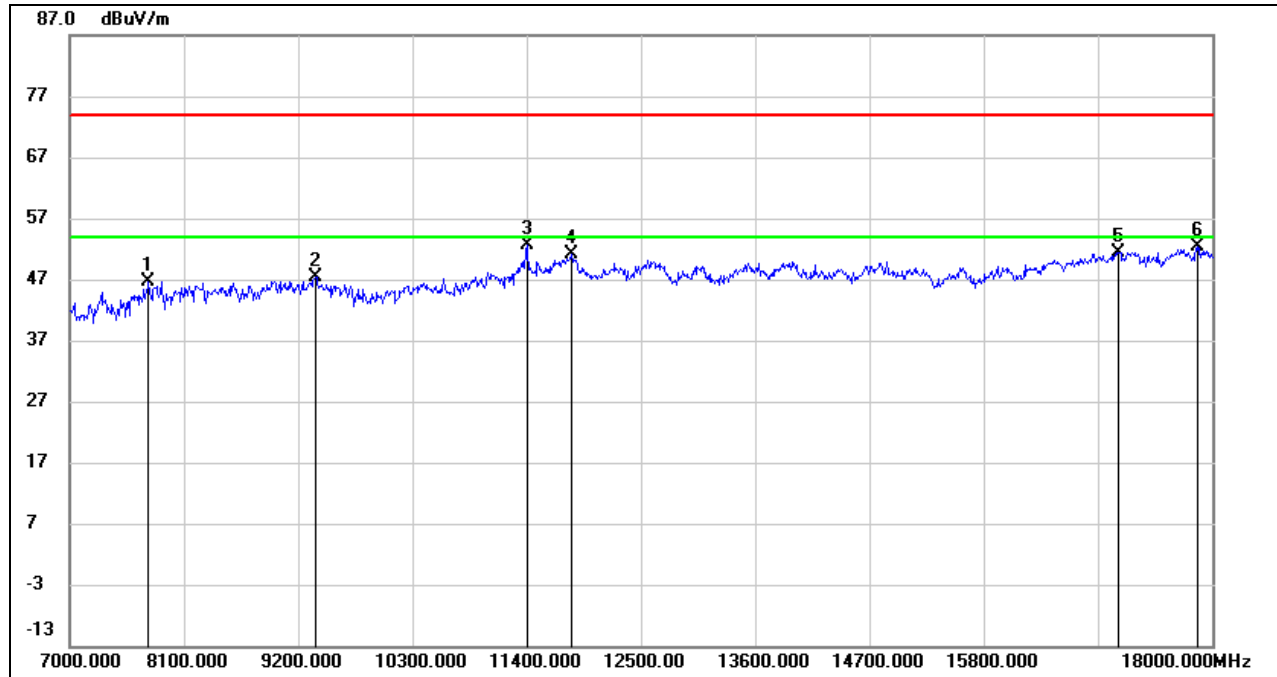

No.	Frequency (MHz)	Reading (dBuV)	Correct (dB/m)	Result (dBuV/m)	Limit (dBuV/m)	Margin (dB)	Remark
1	7759.000	38.61	8.09	46.70	74.00	-27.30	peak
2	9365.000	37.37	10.13	47.50	74.00	-26.50	peak
3	11400.000	38.48	14.22	52.70	74.00	-21.30	peak
4	11829.000	35.50	15.57	51.07	74.00	-22.93	peak
5	17098.000	30.85	20.63	51.48	74.00	-22.52	peak
6	17857.000	29.69	22.70	52.39	74.00	-21.61	peak

Note: 1. Measurement = Reading Level + Correct Factor.
 2. If Peak Result complies with AV limit, AV Result is deemed to comply with AV limit.
 3. Peak: Peak detector.
 4. Filter losses were only considered in the spurious frequency bands and the authorized band was not corrected for High Pass Filter losses.
 5. Proper operation of the transmitter prior to adding the filter to the measurement chain.
 6. Since non-restricted band peak emissions are less than the average limit, they also comply with the -27dBm/MHz (68.2dBuV/m) limit.



HARMONICS AND SPURIOUS EMISSIONS (HIGH CHANNEL, VERTICAL)

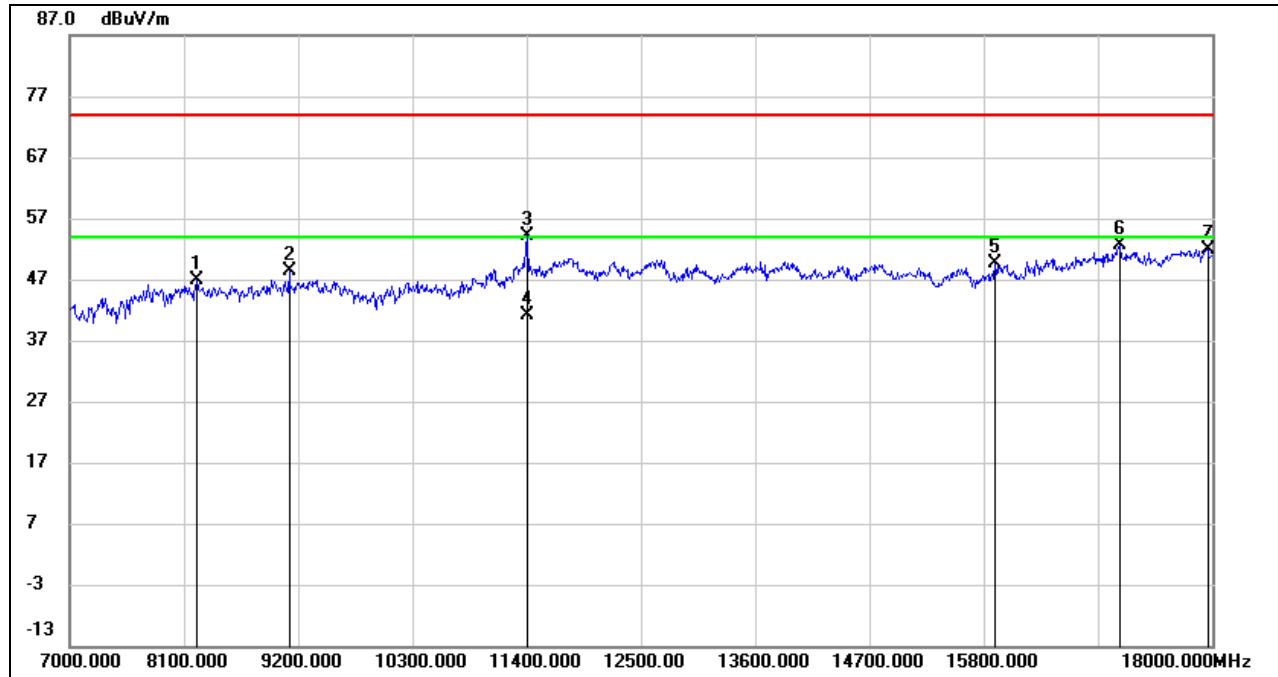

No.	Frequency (MHz)	Reading (dBuV)	Correct (dB/m)	Result (dBuV/m)	Limit (dBuV/m)	Margin (dB)	Remark
1	8221.000	37.67	9.28	46.95	74.00	-27.05	peak
2	9112.000	38.50	9.88	48.38	74.00	-25.62	peak
3	11400.000	39.87	14.22	54.09	74.00	-19.91	peak
4	11400.000	26.94	14.22	41.16	54.00	-12.84	AVG
5	15910.000	32.47	17.05	49.52	74.00	-24.48	peak
6	17109.000	31.84	20.67	52.51	74.00	-21.49	peak
7	17956.000	29.25	22.68	51.93	74.00	-22.07	peak

- Note:
1. Measurement = Reading Level + Correct Factor.
 2. If Peak Result complies with AV limit, AV Result is deemed to comply with AV limit.
 3. Peak: Peak detector.
 4. AVG: VBW=1/Ton, where: Ton is the transmitting duration.
 5. For the transmitting duration, please refer to clause 7.1.
 6. Filter losses were only considered in the spurious frequency bands and the authorized band was not corrected for High Pass Filter losses.
 7. Proper operation of the transmitter prior to adding the filter to the measurement chain.
 8. Since non-restricted band peak emissions are less than the average limit, they also comply with the -27dBm/MHz (68.2dBuV/m) limit.

STRADDLE CHANNEL 144

ANTENNA 1 TEST RESULTS (WORST CASE)

HARMONICS AND SPURIOUS EMISSIONS (HORIZONTAL)

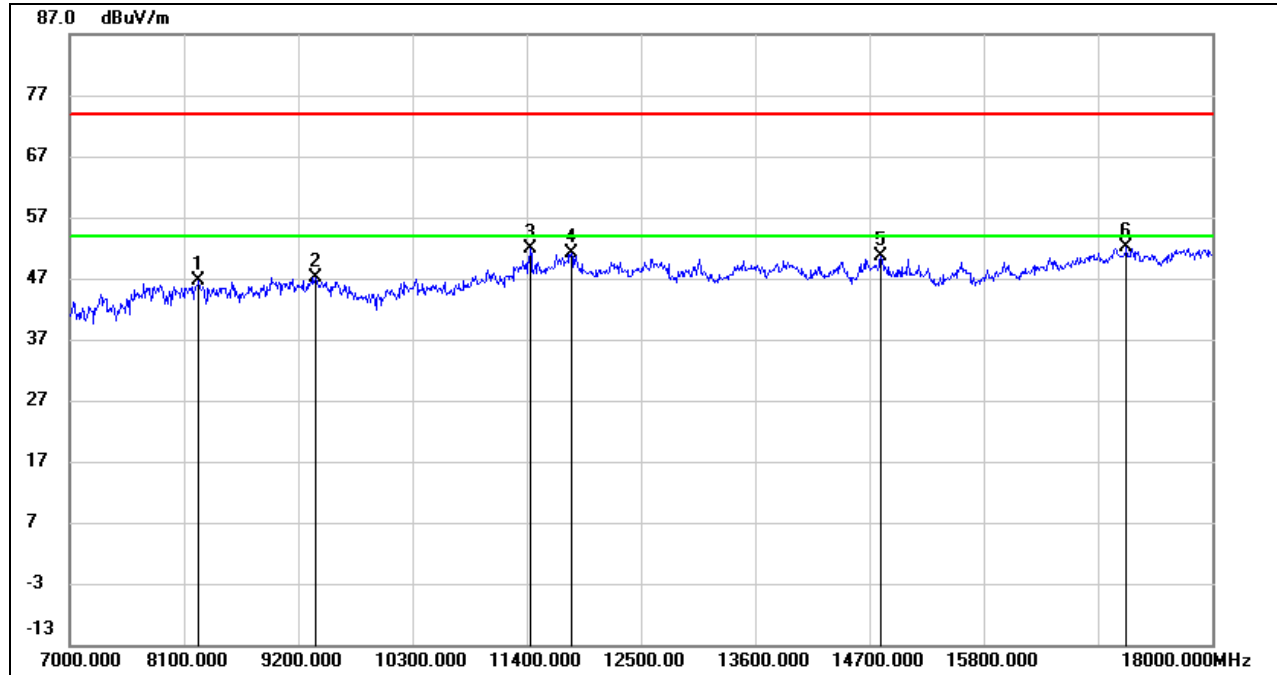

No.	Frequency (MHz)	Reading (dBuV)	Correct (dB/m)	Result (dBuV/m)	Limit (dBuV/m)	Margin (dB)	Remark
1	8243.000	37.37	9.19	46.56	74.00	-27.44	peak
2	9365.000	37.07	10.13	47.20	74.00	-26.80	peak
3	11433.000	37.56	14.27	51.83	74.00	-22.17	peak
4	11829.000	35.44	15.57	51.01	74.00	-22.99	peak
5	14810.000	33.75	16.80	50.55	74.00	-23.45	peak
6	17175.000	31.30	20.94	52.24	74.00	-21.76	peak

Note: 1. Measurement = Reading Level + Correct Factor.
 2. If Peak Result complies with AV limit, AV Result is deemed to comply with AV limit.
 3. Peak: Peak detector.
 4. Filter losses were only considered in the spurious frequency bands and the authorized band was not corrected for High Pass Filter losses.
 5. Proper operation of the transmitter prior to adding the filter to the measurement chain.
 6. Since non-restricted band peak emissions are less than the average limit, they also comply with the -27dBm/MHz (68.2dBuV/m) limit.

HARMONICS AND SPURIOUS EMISSIONS (VERTICAL)

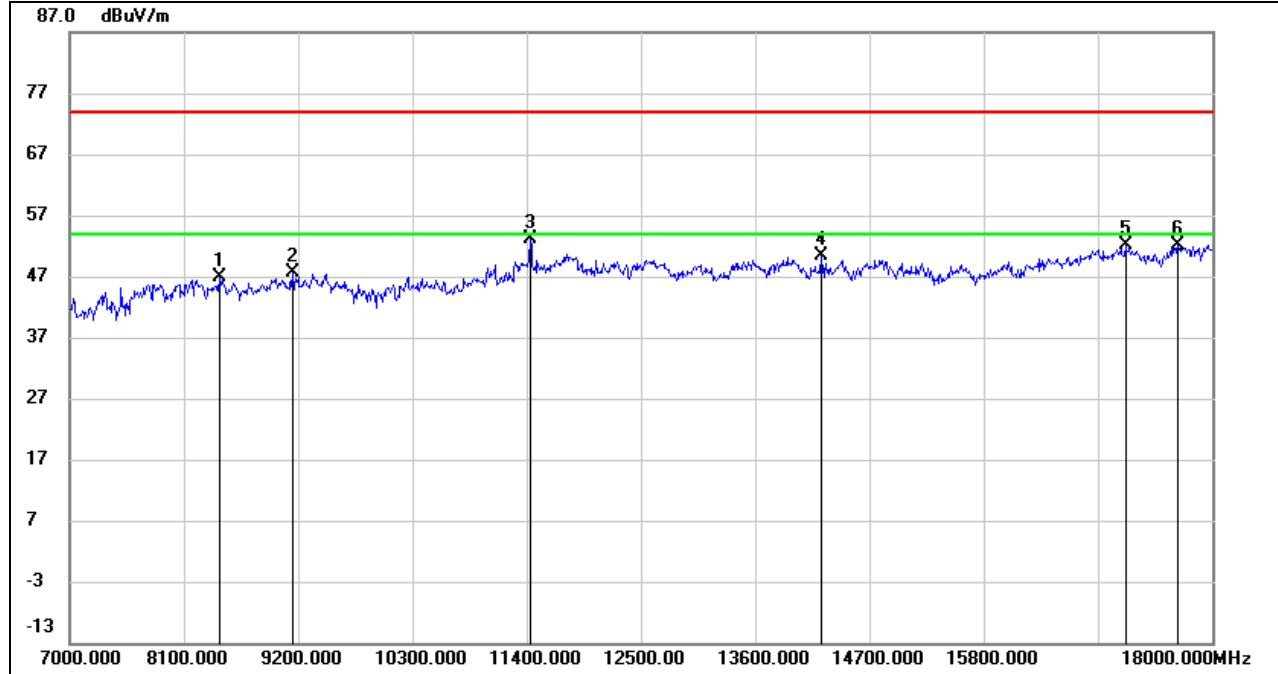

No.	Frequency (MHz)	Reading (dBuV)	Correct (dB/m)	Result (dBuV/m)	Limit (dBuV/m)	Margin (dB)	Remark
1	8441.000	38.24	8.56	46.80	74.00	-27.20	peak
2	9145.000	37.97	9.66	47.63	74.00	-26.37	peak
3	11433.000	38.84	14.27	53.11	74.00	-20.89	peak
4	14238.000	33.72	16.74	50.46	74.00	-23.54	peak
5	17164.000	31.29	20.89	52.18	74.00	-21.82	peak
6	17670.000	30.40	21.70	52.10	74.00	-21.90	peak

Note: 1. Measurement = Reading Level + Correct Factor.
 2. If Peak Result complies with AV limit, AV Result is deemed to comply with AV limit.
 3. Peak: Peak detector.
 4. Filter losses were only considered in the spurious frequency bands and the authorized band was not corrected for High Pass Filter losses.
 5. Proper operation of the transmitter prior to adding the filter to the measurement chain.
 6. Since non-restricted band peak emissions are less than the average limit, they also comply with the -27dBm/MHz (68.2dBuV/m) limit.



UNII-3 BAND

ANTENNA 1 TEST RESULTS (WORST CASE)

HARMONICS AND SPURIOUS EMISSIONS (LOW CHANNEL, HORIZONTAL)

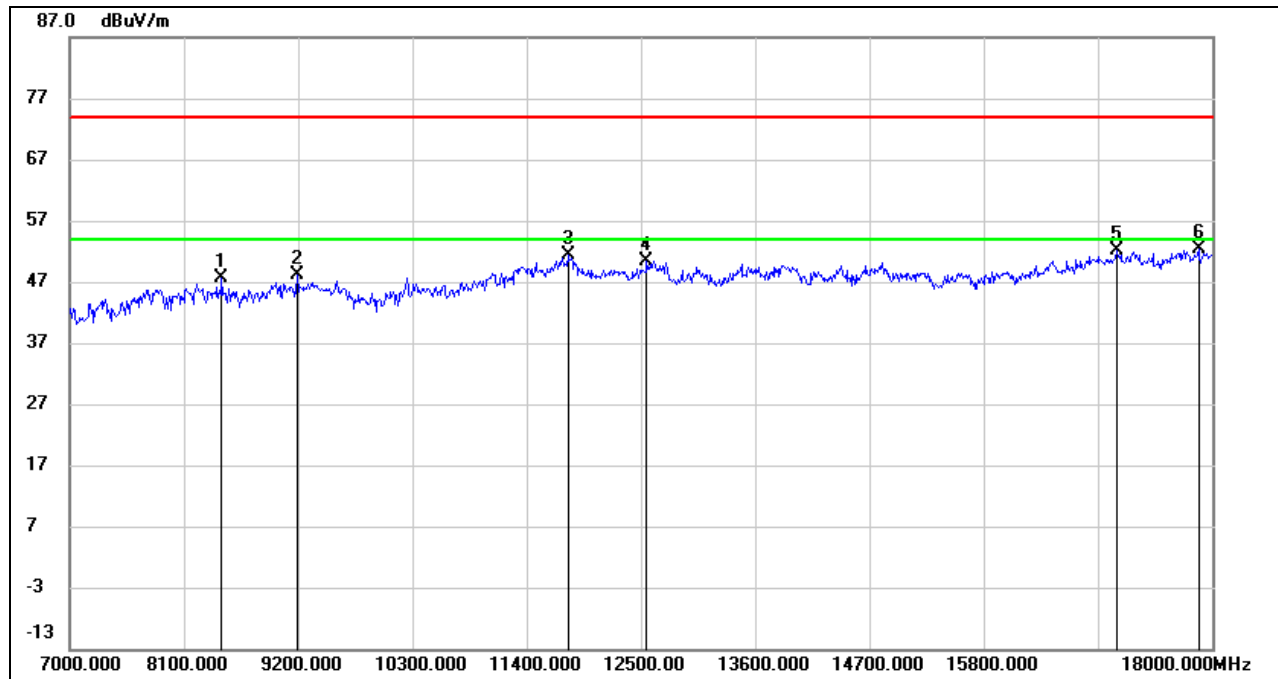

No.	Frequency (MHz)	Reading (dBuV)	Correct (dB/m)	Result (dBuV/m)	Limit (dBuV/m)	Margin (dB)	Remark
1	8463.000	39.11	8.55	47.66	74.00	-26.34	peak
2	9189.000	38.82	9.36	48.18	74.00	-25.82	peak
3	11796.000	35.68	15.59	51.27	74.00	-22.73	peak
4	12555.000	35.17	15.32	50.49	74.00	-23.51	peak
5	17076.000	31.58	20.54	52.12	74.00	-21.88	peak
6	17868.000	29.57	22.71	52.28	74.00	-21.72	peak

Note: 1. Measurement = Reading Level + Correct Factor.
 2. If Peak Result complies with AV limit, AV Result is deemed to comply with AV limit.
 3. Peak: Peak detector.
 4. Filter losses were only considered in the spurious frequency bands and the authorized band was not corrected for High Pass Filter losses.
 5. Proper operation of the transmitter prior to adding the filter to the measurement chain.
 6. Since non-restricted band peak emissions are less than the average limit, they also comply with the -27dBm/MHz (68.2dBuV/m) limit.

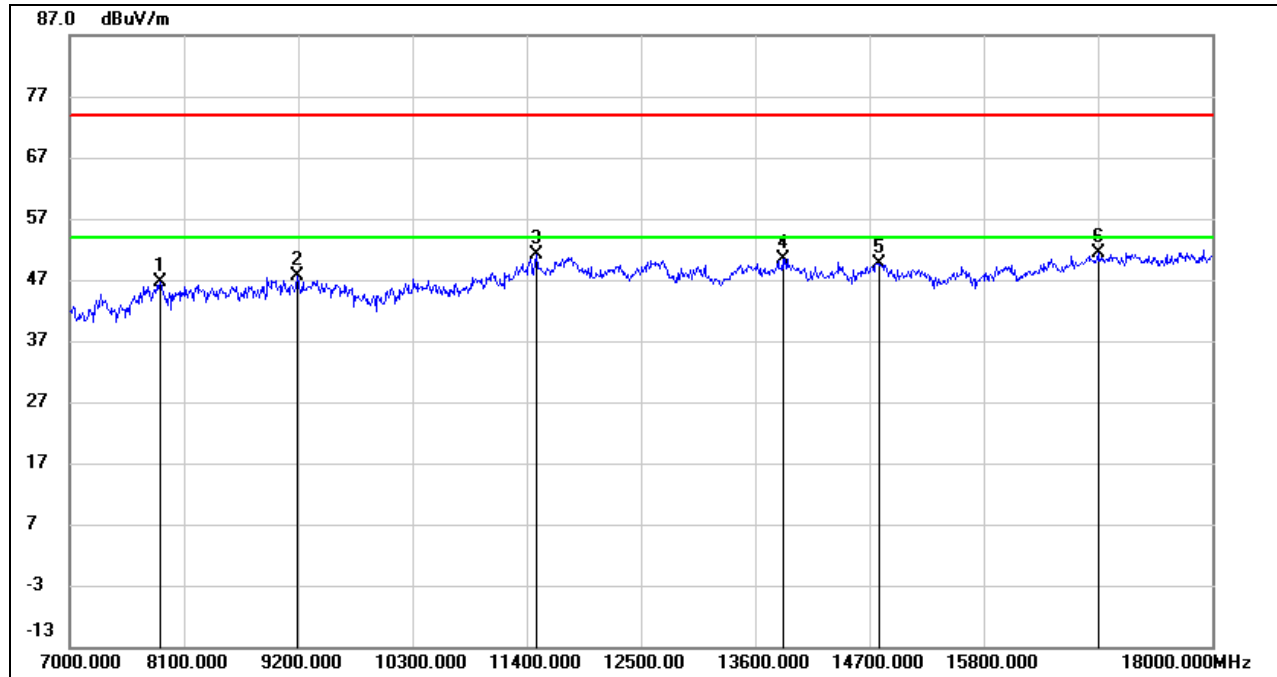
**HARMONICS AND SPURIOUS EMISSIONS (LOW CHANNEL, VERTICAL)**

No.	Frequency (MHz)	Reading (dBuV)	Correct (dB/m)	Result (dBuV/m)	Limit (dBuV/m)	Margin (dB)	Remark
1	7869.000	38.67	8.05	46.72	74.00	-27.28	peak
2	9189.000	38.16	9.36	47.52	74.00	-26.48	peak
3	11499.000	36.81	14.36	51.17	74.00	-22.83	peak
4	13864.000	33.44	16.92	50.36	74.00	-23.64	peak
5	14799.000	32.88	16.80	49.68	74.00	-24.32	peak
6	16900.000	31.41	19.98	51.39	74.00	-22.61	peak

Note: 1. Measurement = Reading Level + Correct Factor.

2. If Peak Result complies with AV limit, AV Result is deemed to comply with AV limit.

3. Peak: Peak detector.

4. Filter losses were only considered in the spurious frequency bands and the authorized band was not corrected for High Pass Filter losses.

5. Proper operation of the transmitter prior to adding the filter to the measurement chain.

6. Since non-restricted band peak emissions are less than the average limit, they also comply with the -27dBm/MHz (68.2dBuV/m) limit.



HARMONICS AND SPURIOUS EMISSIONS (MID CHANNEL, HORIZONTAL)

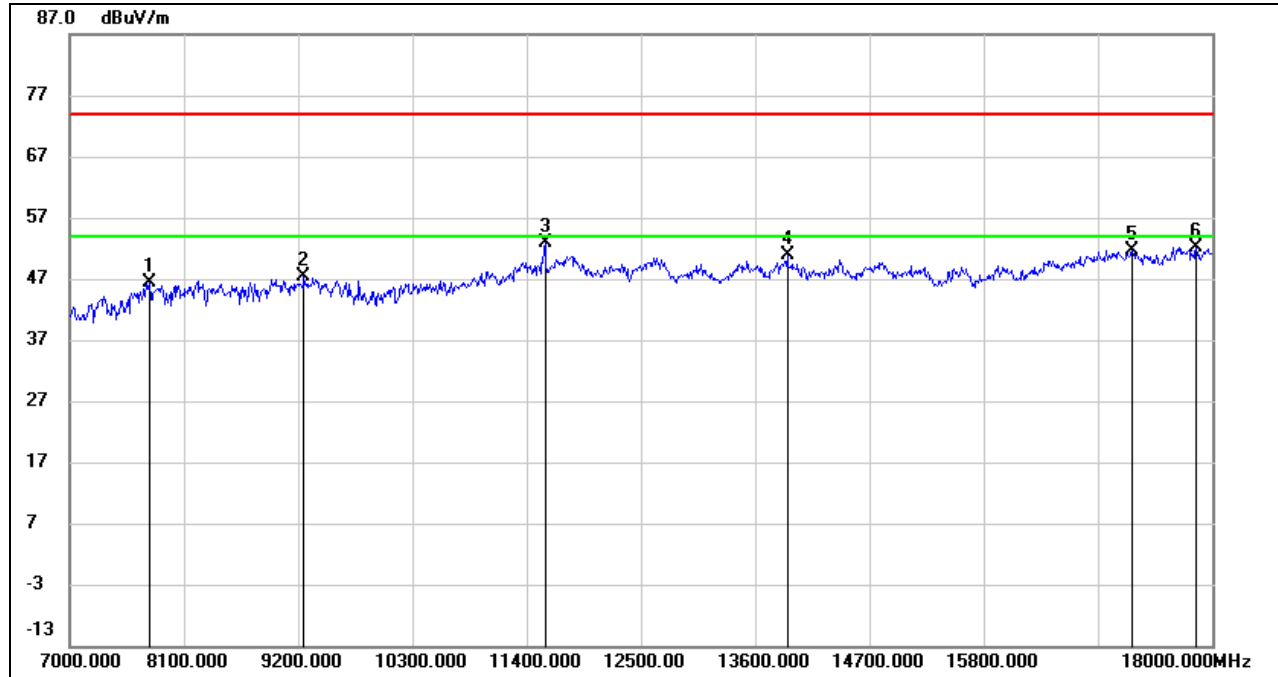

No.	Frequency (MHz)	Reading (dBuV)	Correct (dB/m)	Result (dBuV/m)	Limit (dBuV/m)	Margin (dB)	Remark
1	7770.000	38.31	8.14	46.45	74.00	-27.55	peak
2	9255.000	37.92	9.56	47.48	74.00	-26.52	peak
3	11576.000	38.35	14.48	52.83	74.00	-21.17	peak
4	13908.000	33.89	16.90	50.79	74.00	-23.21	peak
5	17230.000	30.59	20.99	51.58	74.00	-22.42	peak
6	17846.000	29.45	22.71	52.16	74.00	-21.84	peak

Note: 1. Measurement = Reading Level + Correct Factor.
 2. If Peak Result complies with AV limit, AV Result is deemed to comply with AV limit.
 3. Peak: Peak detector.
 4. Filter losses were only considered in the spurious frequency bands and the authorized band was not corrected for High Pass Filter losses.
 5. Proper operation of the transmitter prior to adding the filter to the measurement chain.
 6. Since non-restricted band peak emissions are less than the average limit, they also comply with the -27dBm/MHz (68.2dBuV/m) limit.



HARMONICS AND SPURIOUS EMISSIONS (MID CHANNEL, VERTICAL)

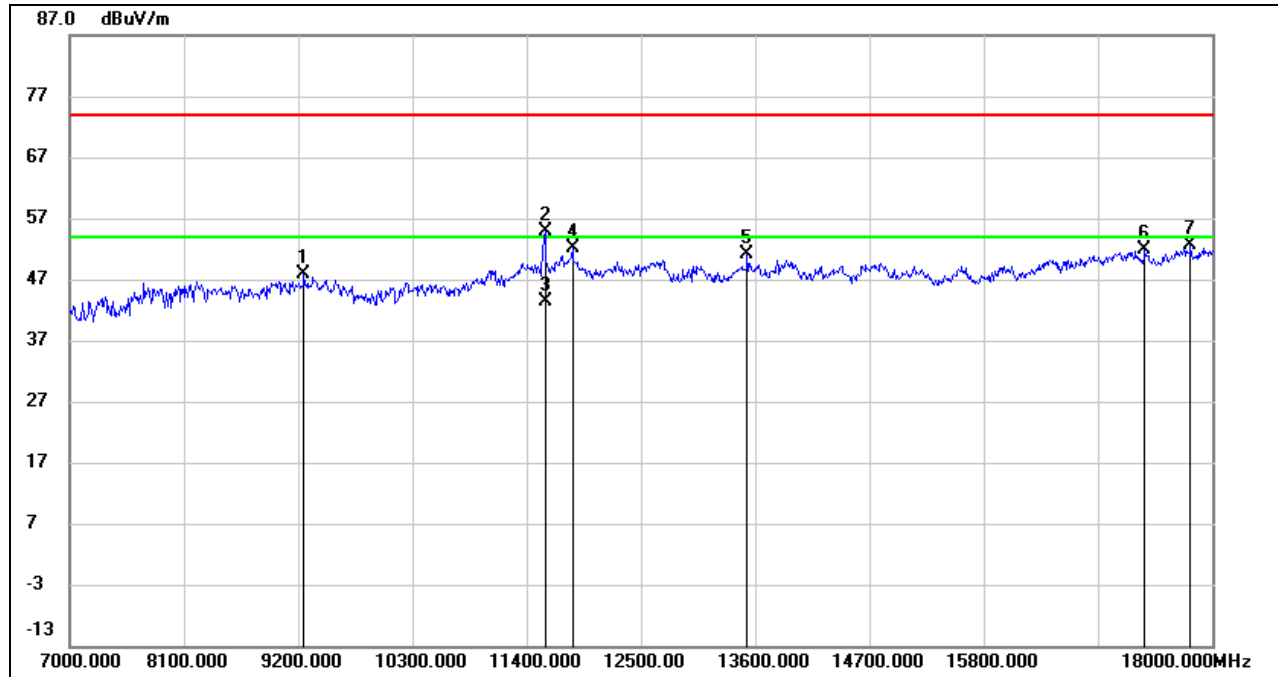

No.	Frequency (MHz)	Reading (dBuV)	Correct (dB/m)	Result (dBuV/m)	Limit (dBuV/m)	Margin (dB)	Remark
1	9255.000	38.20	9.56	47.76	74.00	-26.24	peak
2	11576.000	40.48	14.48	54.96	74.00	-19.04	peak
3	11576.000	29.00	14.48	43.48	54.00	-10.52	AVG
4	11840.000	36.56	15.56	52.12	74.00	-21.88	peak
5	13523.000	34.64	16.42	51.06	74.00	-22.94	peak
6	17351.000	31.12	20.81	51.93	74.00	-22.07	peak
7	17791.000	29.98	22.65	52.63	74.00	-21.37	peak

- Note:
1. Measurement = Reading Level + Correct Factor.
 2. If Peak Result complies with AV limit, AV Result is deemed to comply with AV limit.
 3. Peak: Peak detector.
 4. AVG: $VBW=1/Ton$, where: Ton is the transmitting duration.
 5. For the transmitting duration, please refer to clause 7.1.
 6. Filter losses were only considered in the spurious frequency bands and the authorized band was not corrected for High Pass Filter losses.
 7. Proper operation of the transmitter prior to adding the filter to the measurement chain.
 8. Since non-restricted band peak emissions are less than the average limit, they also comply with the -27dBm/MHz (68.2dBuV/m) limit.



HARMONICS AND SPURIOUS EMISSIONS (HIGH CHANNEL, HORIZONTAL)

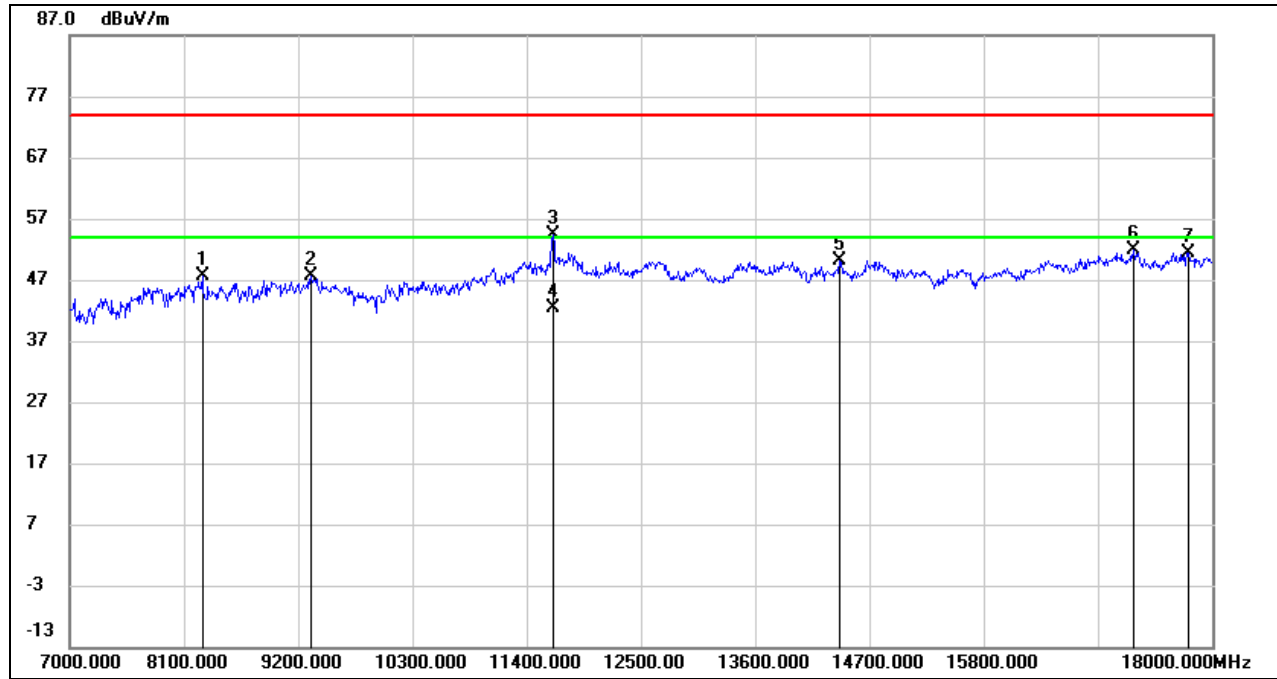

No.	Frequency (MHz)	Reading (dBuV)	Correct (dB/m)	Result (dBuV/m)	Limit (dBuV/m)	Margin (dB)	Remark
1	8276.000	38.65	9.06	47.71	74.00	-26.29	peak
2	9321.000	37.68	9.91	47.59	74.00	-26.41	peak
3	11653.000	39.58	14.80	54.38	74.00	-19.62	peak
4	11653.000	27.68	14.80	42.48	54.00	-11.52	AVG
5	14414.000	33.32	16.82	50.14	74.00	-23.86	peak
6	17241.000	30.91	20.97	51.88	74.00	-22.12	peak
7	17769.000	29.00	22.48	51.48	74.00	-22.52	peak

- Note: 1. Measurement = Reading Level + Correct Factor.
 2. If Peak Result complies with AV limit, AV Result is deemed to comply with AV limit.
 3. Peak: Peak detector.
 4. AVG: VBW=1/Ton, where: Ton is the transmitting duration.
 5. For the transmitting duration, please refer to clause 7.1.
 6. Filter losses were only considered in the spurious frequency bands and the authorized band was not corrected for High Pass Filter losses.
 7. Proper operation of the transmitter prior to adding the filter to the measurement chain.
 8. Since non-restricted band peak emissions are less than the average limit, they also comply with the -27dBm/MHz (68.2dBuV/m) limit.



HARMONICS AND SPURIOUS EMISSIONS (HIGH CHANNEL, VERTICAL)

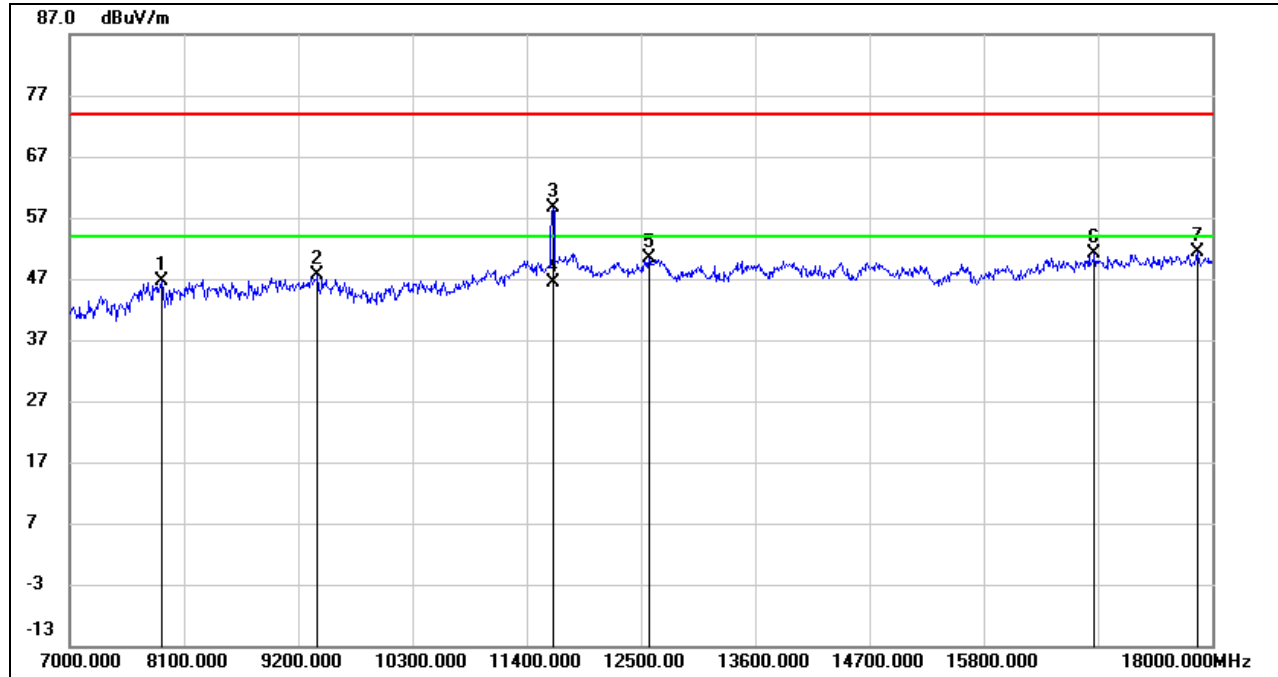

No.	Frequency (MHz)	Reading (dBuV)	Correct (dB/m)	Result (dBuV/m)	Limit (dBuV/m)	Margin (dB)	Remark
1	7891.000	38.74	7.98	46.72	74.00	-27.28	peak
2	9387.000	37.39	10.24	47.63	74.00	-26.37	peak
3	11653.000	43.74	14.80	58.54	74.00	-15.46	peak
4	11653.000	31.48	14.80	46.28	54.00	-7.72	AVG
5	12577.000	34.99	15.31	50.30	74.00	-23.70	peak
6	16867.000	31.23	19.90	51.13	74.00	-22.87	peak
7	17857.000	28.66	22.70	51.36	74.00	-22.64	peak

- Note: 1. Measurement = Reading Level + Correct Factor.
 2. If Peak Result complies with AV limit, AV Result is deemed to comply with AV limit.
 3. Peak: Peak detector.
 4. AVG: $VBW=1/Ton$, where: Ton is the transmitting duration.
 5. For the transmitting duration, please refer to clause 7.1.
 6. Filter losses were only considered in the spurious frequency bands and the authorized band was not corrected for High Pass Filter losses.
 7. Proper operation of the transmitter prior to adding the filter to the measurement chain.
 8. Since non-restricted band peak emissions are less than the average limit, they also comply with the -27dBm/MHz (68.2dBuV/m) limit.

8.3.2. 802.11n HT20 MIMO MODE

UNII-1 BAND

HARMONICS AND SPURIOUS EMISSIONS (LOW CHANNEL, HORIZONTAL)

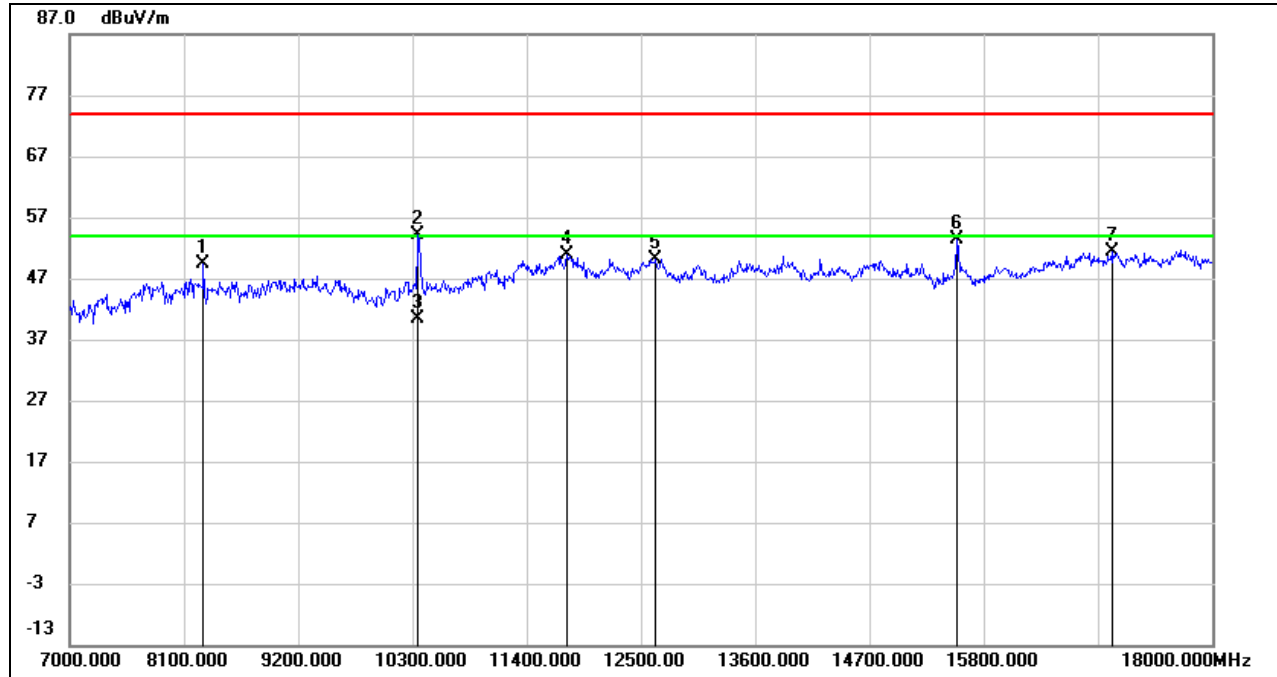

No.	Frequency (MHz)	Reading (dBuV)	Correct (dB/m)	Result (dBuV/m)	Limit (dBuV/m)	Margin (dB)	Remark
1	8287.000	40.48	9.02	49.50	74.00	-24.50	peak
2	10355.000	42.81	11.29	54.10	74.00	-19.90	peak
3	10355.000	29.17	11.29	40.46	54.00	-13.54	AVG
4	11785.000	35.40	15.52	50.92	74.00	-23.08	peak
5	12643.000	34.87	15.36	50.23	74.00	-23.77	peak
6	15547.000	36.75	16.58	53.33	74.00	-20.67	peak
7	17032.000	30.98	20.36	51.34	74.00	-22.66	peak

Note: 1. Measurement = Reading Level + Correct Factor.
 2. If Peak Result complies with AV limit, AV Result is deemed to comply with AV limit.
 3. Peak: Peak detector.
 4. AVG: $VBW=1/T_{on}$, where: T_{on} is the transmitting duration.
 5. For the transmitting duration, please refer to clause 7.1.
 6. Filter losses were only considered in the spurious frequency bands and the authorized band was not corrected for High Pass Filter losses.
 7. Proper operation of the transmitter prior to adding the filter to the measurement chain.
 8. Since non-restricted band peak emissions are less than the average limit, they also comply with the -27dBm/MHz (68.2dBuV/m) limit.

HARMONICS AND SPURIOUS EMISSIONS (LOW CHANNEL, VERTICAL)

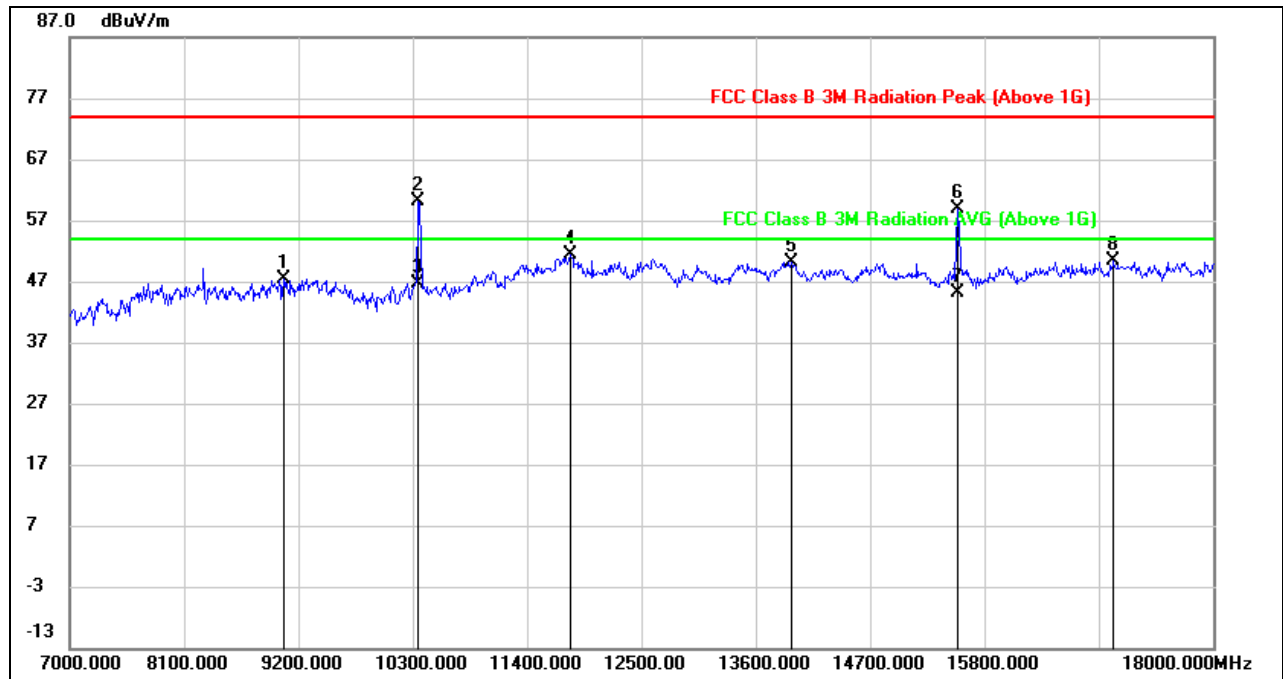

No.	Frequency (MHz)	Reading (dBuV)	Correct (dB/m)	Result (dBuV/m)	Limit (dBuV/m)	Margin (dB)	Remark
1	9057.000	37.02	10.26	47.28	74.00	-26.72	peak
2	10355.000	48.94	11.29	60.23	74.00	-13.77	peak
3	10355.000	35.24	11.29	46.53	54.00	-7.47	AVG
4	11818.000	35.79	15.58	51.37	74.00	-22.63	peak
5	13941.000	33.18	16.88	50.06	74.00	-23.94	peak
6	15536.000	42.36	16.55	58.91	74.00	-15.09	peak
7	15536.000	28.69	16.55	45.24	54.00	-8.76	AVG
8	17043.000	29.91	20.40	50.31	74.00	-23.69	peak

Note: 1. Measurement = Reading Level + Correct Factor.
 2. If Peak Result complies with AV limit, AV Result is deemed to comply with AV limit.
 3. Peak: Peak detector.
 4. AVG: $VBW=1/Ton$, where: Ton is the transmitting duration.
 5. For the transmitting duration, please refer to clause 7.1.
 6. Filter losses were only considered in the spurious frequency bands and the authorized band was not corrected for High Pass Filter losses.
 7. Proper operation of the transmitter prior to adding the filter to the measurement chain.
 8. Since non-restricted band peak emissions are less than the average limit, they also comply with the -27dBm/MHz (68.2dBuV/m) limit.



HARMONICS AND SPURIOUS EMISSIONS (MID CHANNEL, HORIZONTAL)

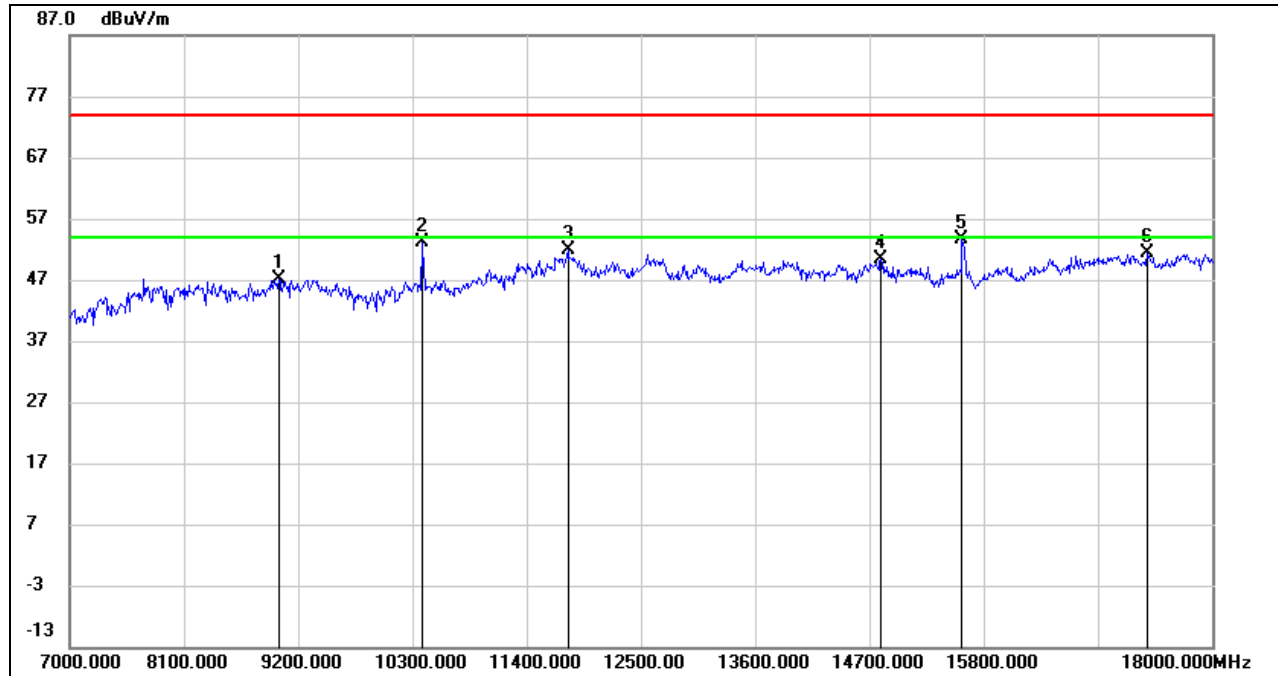

No.	Frequency (MHz)	Reading (dBuV)	Correct (dB/m)	Result (dBuV/m)	Limit (dBuV/m)	Margin (dB)	Remark
1	9013.000	36.52	10.54	47.06	74.00	-26.94	peak
2	10388.000	41.71	11.41	53.12	74.00	-20.88	peak
3	11796.000	36.37	15.59	51.96	74.00	-22.04	peak
4	14810.000	33.47	16.80	50.27	74.00	-23.73	peak
5	15591.000	36.89	16.68	53.57	74.00	-20.43	peak
6	17373.000	30.61	20.77	51.38	74.00	-22.62	peak

- Note: 1. Measurement = Reading Level + Correct Factor.
 2. If Peak Result complies with AV limit, AV Result is deemed to comply with AV limit.
 3. Peak: Peak detector.
 4. Filter losses were only considered in the spurious frequency bands and the authorized band was not corrected for High Pass Filter losses.
 5. Proper operation of the transmitter prior to adding the filter to the measurement chain.
 6. Since non-restricted band peak emissions are less than the average limit, they also comply with the -27dBm/MHz (68.2dBuV/m) limit.

HARMONICS AND SPURIOUS EMISSIONS (MID CHANNEL, VERTICAL)

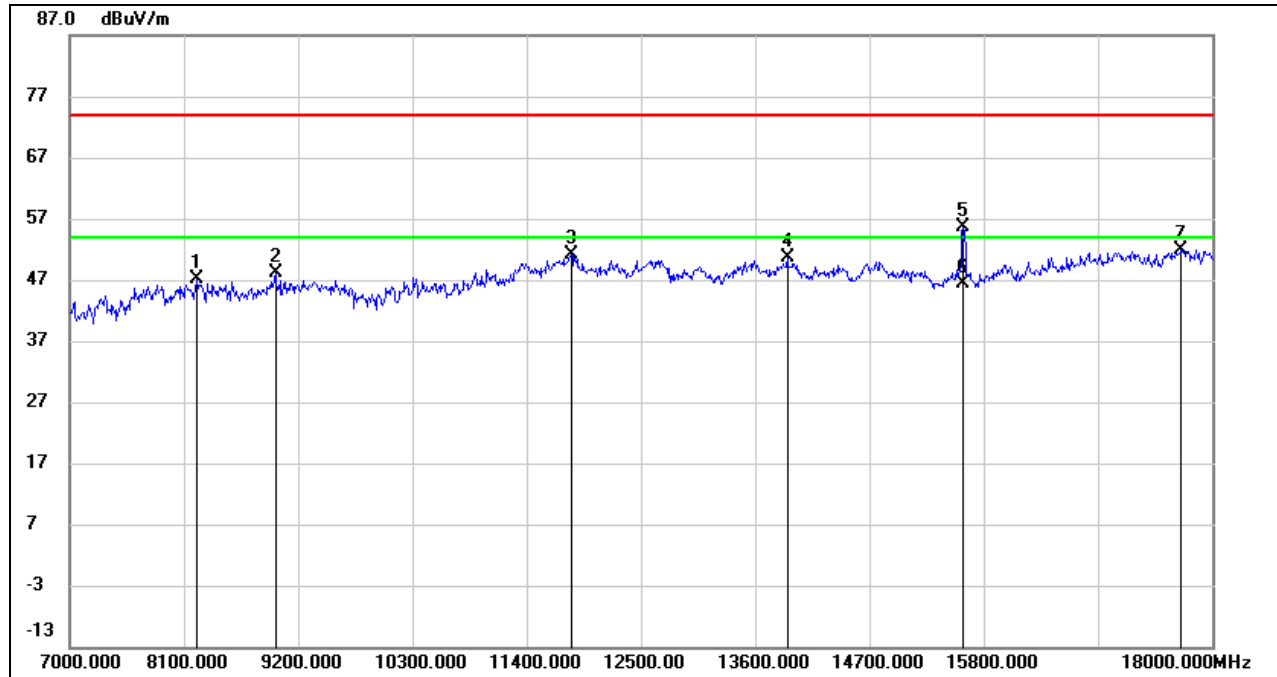

No.	Frequency (MHz)	Reading (dBuV)	Correct (dB/m)	Result (dBuV/m)	Limit (dBuV/m)	Margin (dB)	Remark
1	8221.000	37.86	9.28	47.14	74.00	-26.86	peak
2	8980.000	37.64	10.41	48.05	74.00	-25.95	peak
3	11829.000	35.55	15.57	51.12	74.00	-22.88	peak
4	13908.000	33.70	16.90	50.60	74.00	-23.40	peak
5	15602.000	38.90	16.70	55.60	74.00	-18.40	peak
6	15602.000	29.78	16.70	46.48	54.00	-7.52	AVG
7	17703.000	29.97	21.96	51.93	74.00	-22.07	peak

- Note:
1. Measurement = Reading Level + Correct Factor.
 2. If Peak Result complies with AV limit, AV Result is deemed to comply with AV limit.
 3. Peak: Peak detector.
 4. AVG: $VBW=1/Ton$, where: Ton is the transmitting duration.
 5. For the transmitting duration, please refer to clause 7.1.
 6. Filter losses were only considered in the spurious frequency bands and the authorized band was not corrected for High Pass Filter losses.
 7. Proper operation of the transmitter prior to adding the filter to the measurement chain.
 8. Since non-restricted band peak emissions are less than the average limit, they also comply with the -27dBm/MHz (68.2dBuV/m) limit.

HARMONICS AND SPURIOUS EMISSIONS (HIGH CHANNEL, HORIZONTAL)

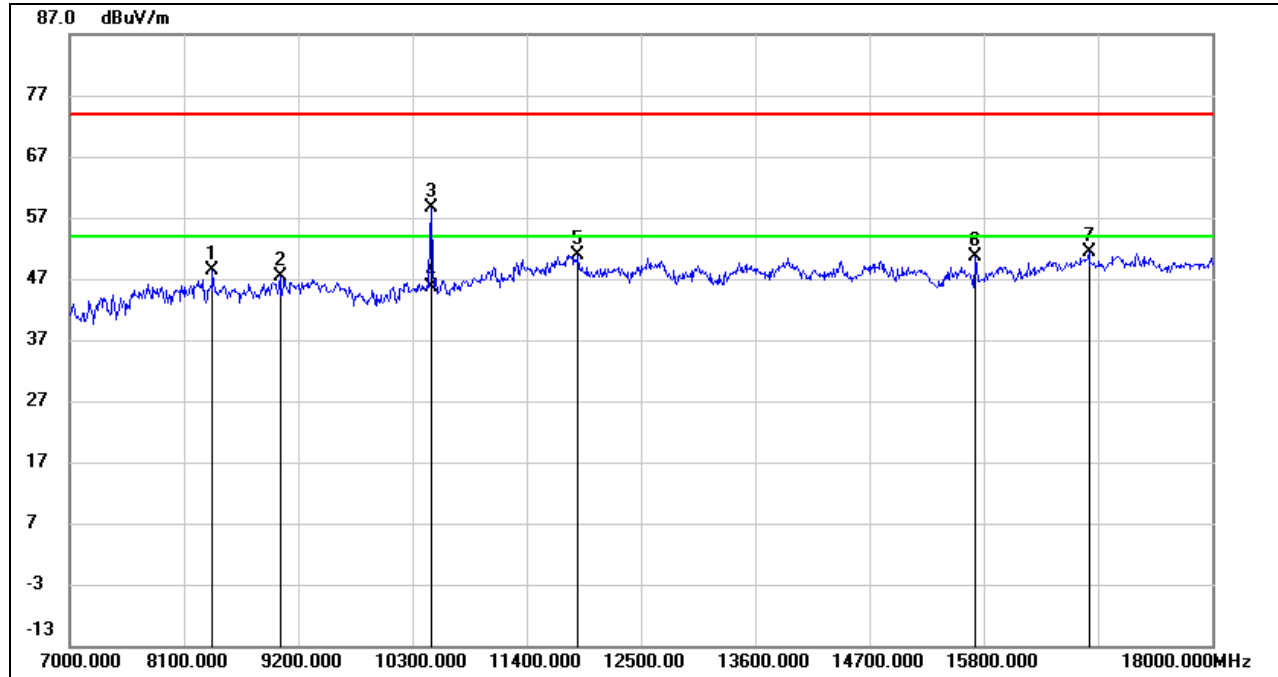

No.	Frequency (MHz)	Reading (dBuV)	Correct (dB/m)	Result (dBuV/m)	Limit (dBuV/m)	Margin (dB)	Remark
1	8375.000	39.78	8.68	48.46	74.00	-25.54	peak
2	9024.000	36.79	10.47	47.26	74.00	-26.74	peak
3	10487.000	46.82	11.89	58.71	74.00	-15.29	peak
4	10487.000	33.74	11.89	45.63	54.00	-8.37	AVG
5	11895.000	35.41	15.48	50.89	74.00	-23.11	peak
6	15723.000	33.91	16.77	50.68	74.00	-23.32	peak
7	16812.000	31.64	19.77	51.41	74.00	-22.59	peak

- Note: 1. Measurement = Reading Level + Correct Factor.
 2. If Peak Result complies with AV limit, AV Result is deemed to comply with AV limit.
 3. Peak: Peak detector.
 4. AVG: VBW=1/Ton, where: Ton is the transmitting duration.
 5. For the transmitting duration, please refer to clause 7.1.
 6. Filter losses were only considered in the spurious frequency bands and the authorized band was not corrected for High Pass Filter losses.
 7. Proper operation of the transmitter prior to adding the filter to the measurement chain.
 8. Since non-restricted band peak emissions are less than the average limit, they also comply with the -27dBm/MHz (68.2dBuV/m) limit.



HARMONICS AND SPURIOUS EMISSIONS (HIGH CHANNEL, VERTICAL)

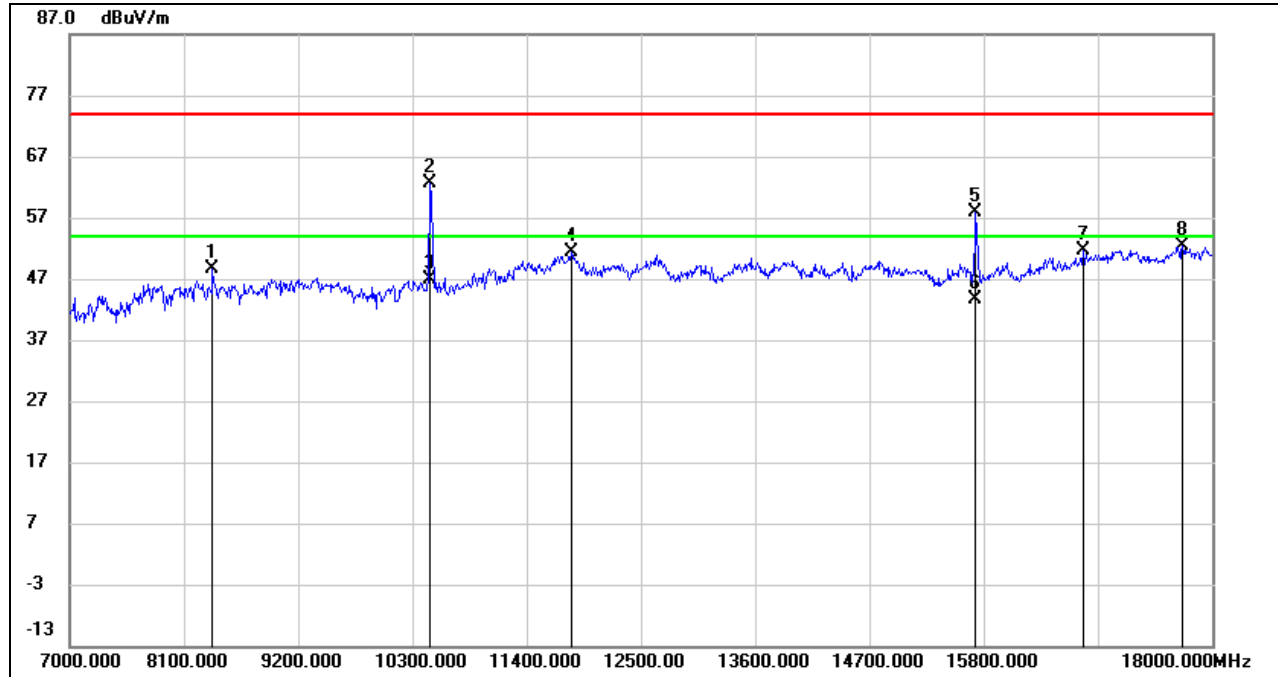

No.	Frequency (MHz)	Reading (dBuV)	Correct (dB/m)	Result (dBuV/m)	Limit (dBuV/m)	Margin (dB)	Remark
1	8375.000	39.99	8.68	48.67	74.00	-25.33	peak
2	10465.000	50.74	11.78	62.52	74.00	-11.48	peak
3	10465.000	35.19	11.78	46.97	54.00	-7.03	AVG
4	11829.000	35.75	15.57	51.32	74.00	-22.68	peak
5	15723.000	41.00	16.77	57.77	74.00	-16.23	peak
6	15723.000	26.91	16.77	43.68	54.00	-10.32	AVG
7	16757.000	31.98	19.70	51.68	74.00	-22.32	peak
8	17714.000	30.30	22.04	52.34	74.00	-21.66	peak

- Note: 1. Measurement = Reading Level + Correct Factor.
 2. If Peak Result complies with AV limit, AV Result is deemed to comply with AV limit.
 3. Peak: Peak detector.
 4. AVG: $VBW=1/Ton$, where: Ton is the transmitting duration.
 5. For the transmitting duration, please refer to clause 7.1.
 6. Filter losses were only considered in the spurious frequency bands and the authorized band was not corrected for High Pass Filter losses.
 7. Proper operation of the transmitter prior to adding the filter to the measurement chain.
 8. Since non-restricted band peak emissions are less than the average limit, they also comply with the -27dBm/MHz (68.2dBuV/m) limit.



UNII-2A BAND

HARMONICS AND SPURIOUS EMISSIONS (LOW CHANNEL, HORIZONTAL)

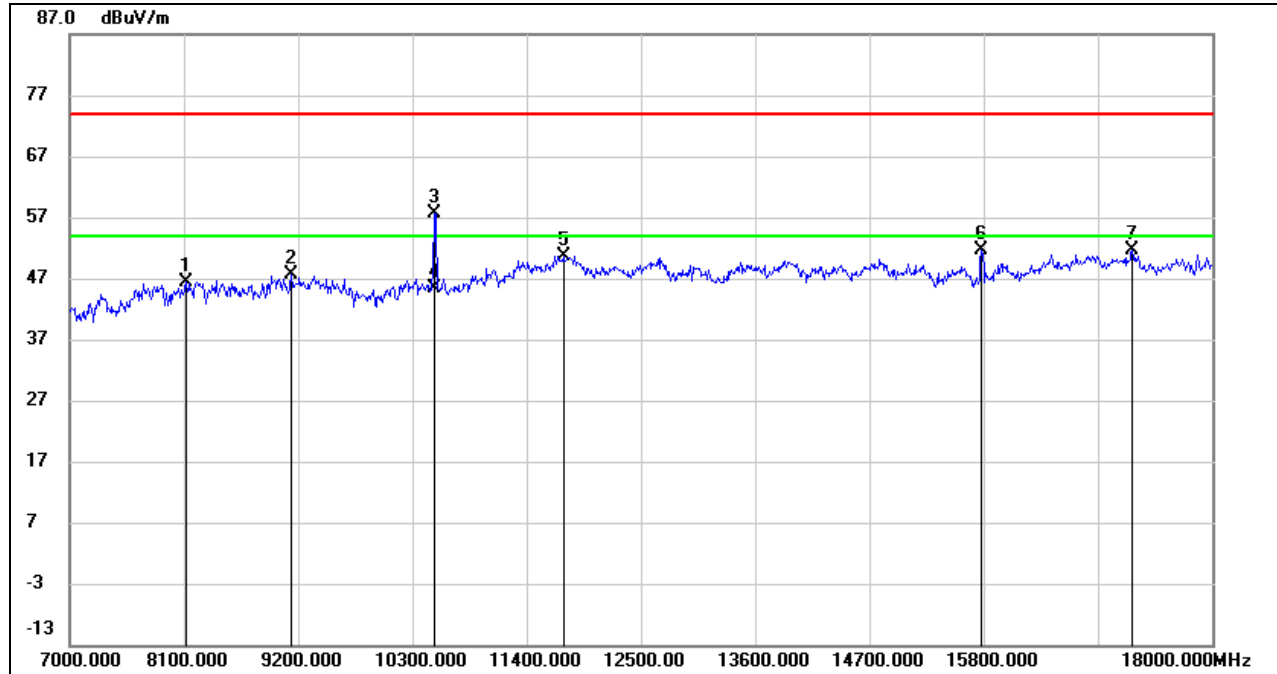

No.	Frequency (MHz)	Reading (dBuV)	Correct (dB/m)	Result (dBuV/m)	Limit (dBuV/m)	Margin (dB)	Remark
1	8122.000	37.68	8.70	46.38	74.00	-27.62	peak
2	9134.000	38.00	9.73	47.73	74.00	-26.27	peak
3	10509.000	45.64	11.99	57.63	74.00	-16.37	peak
4	10509.000	33.27	11.99	45.26	54.00	-8.74	AVG
5	11752.000	35.34	15.35	50.69	74.00	-23.31	peak
6	15778.000	34.86	16.82	51.68	74.00	-22.32	peak
7	17230.000	30.58	20.99	51.57	74.00	-22.43	peak

- Note: 1. Measurement = Reading Level + Correct Factor.
 2. If Peak Result complies with AV limit, AV Result is deemed to comply with AV limit.
 3. Peak: Peak detector.
 4. AVG: $VBW=1/Ton$, where: Ton is the transmitting duration.
 5. For the transmitting duration, please refer to clause 7.1.
 6. Filter losses were only considered in the spurious frequency bands and the authorized band was not corrected for High Pass Filter losses.
 7. Proper operation of the transmitter prior to adding the filter to the measurement chain.
 8. Since non-restricted band peak emissions are less than the average limit, they also comply with the -27dBm/MHz (68.2dBuV/m) limit.

HARMONICS AND SPURIOUS EMISSIONS (LOW CHANNEL, VERTICAL)

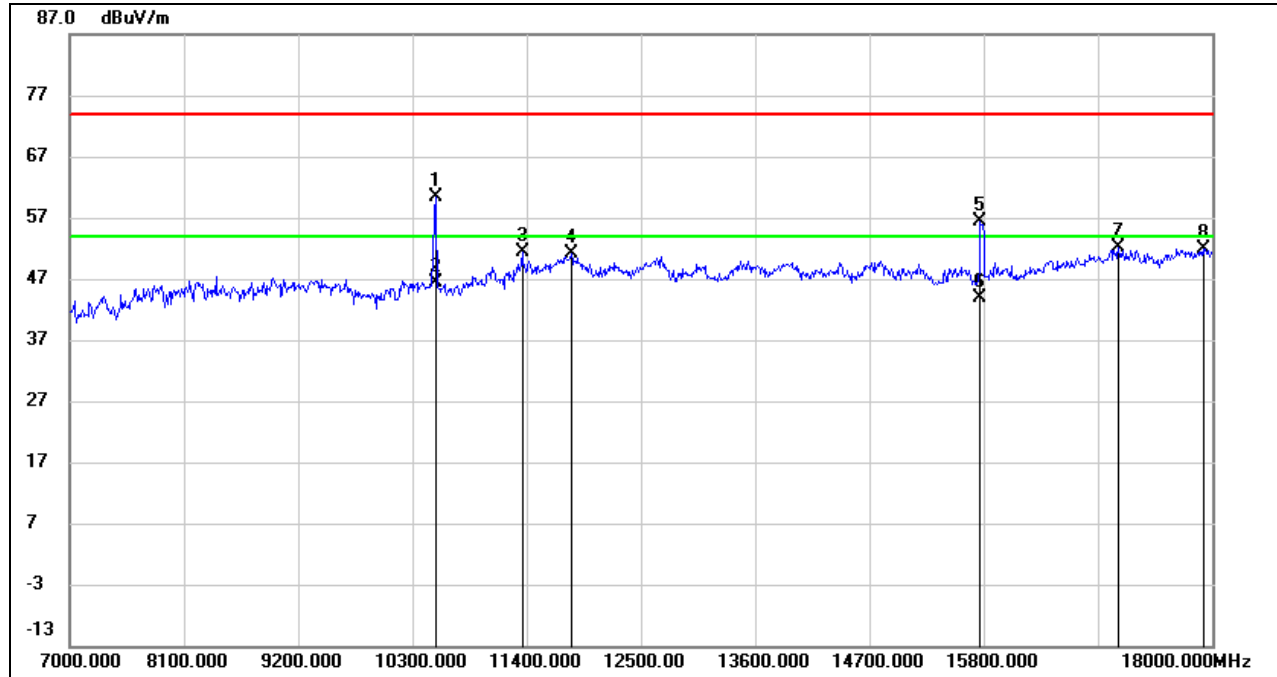

No.	Frequency (MHz)	Reading (dBuV)	Correct (dB/m)	Result (dBuV/m)	Limit (dBuV/m)	Margin (dB)	Remark
1	10520.000	48.34	12.04	60.38	74.00	-13.62	peak
2	10520.000	34.38	12.04	46.42	54.00	-7.58	AVG
3	11356.000	37.29	14.09	51.38	74.00	-22.62	peak
4	11829.000	35.51	15.57	51.08	74.00	-22.92	peak
5	15767.000	39.62	16.81	56.43	74.00	-17.57	peak
6	15767.000	27.14	16.81	43.95	54.00	-10.05	AVG
7	17098.000	31.39	20.63	52.02	74.00	-21.98	peak
8	17912.000	29.28	22.69	51.97	74.00	-22.03	peak

Note: 1. Measurement = Reading Level + Correct Factor.
 2. If Peak Result complies with AV limit, AV Result is deemed to comply with AV limit.
 3. Peak: Peak detector.
 4. AVG: VBW=1/Ton, where: Ton is the transmitting duration.
 5. For the transmitting duration, please refer to clause 7.1.
 6. Filter losses were only considered in the spurious frequency bands and the authorized band was not corrected for High Pass Filter losses.
 7. Proper operation of the transmitter prior to adding the filter to the measurement chain.
 8. Since non-restricted band peak emissions are less than the average limit, they also comply with the -27dBm/MHz (68.2dBuV/m) limit.



HARMONICS AND SPURIOUS EMISSIONS (MID CHANNEL, HORIZONTAL)

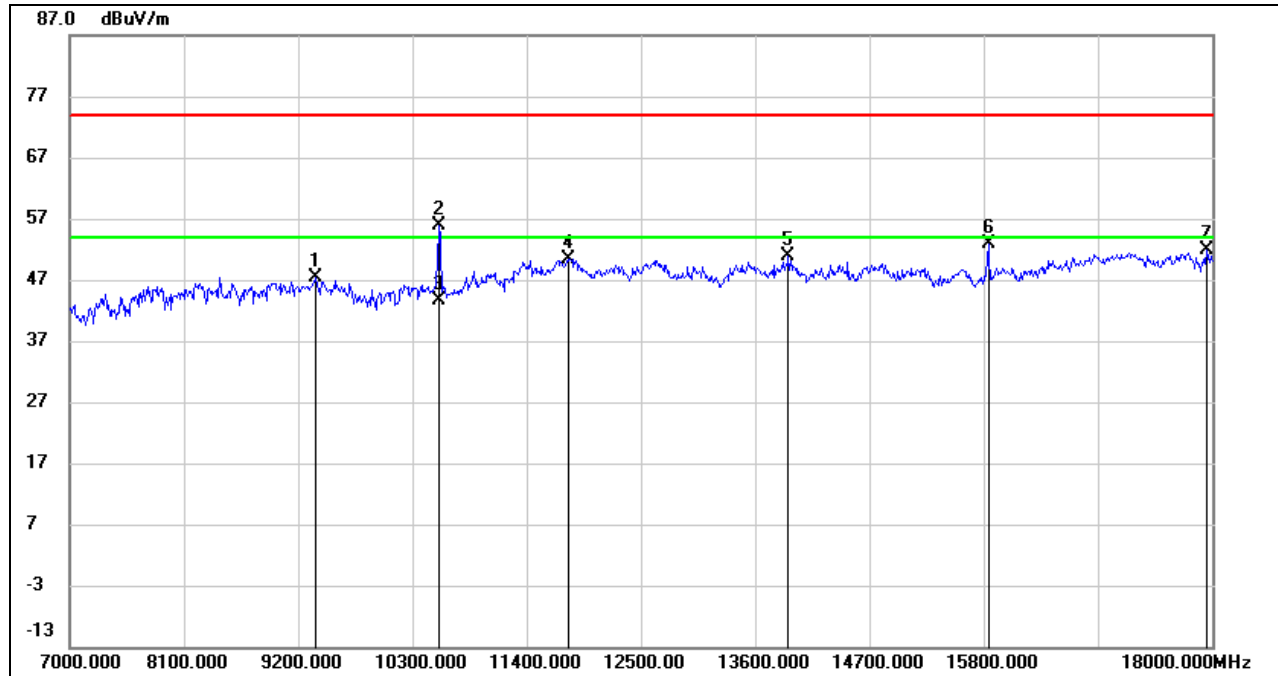

No.	Frequency (MHz)	Reading (dBuV)	Correct (dB/m)	Result (dBuV/m)	Limit (dBuV/m)	Margin (dB)	Remark
1	9365.000	37.24	10.13	47.37	74.00	-26.63	peak
2	10553.000	43.68	12.17	55.85	74.00	-18.15	peak
3	10553.000	31.48	12.17	43.65	54.00	-10.35	AVG
4	11796.000	34.81	15.59	50.40	74.00	-23.60	peak
5	13919.000	34.06	16.89	50.95	74.00	-23.05	peak
6	15844.000	36.02	16.92	52.94	74.00	-21.06	peak
7	17945.000	29.25	22.68	51.93	74.00	-22.07	peak

Note: 1. Measurement = Reading Level + Correct Factor.
 2. If Peak Result complies with AV limit, AV Result is deemed to comply with AV limit.
 3. Peak: Peak detector.
 4. AVG: VBW=1/Ton, where: Ton is the transmitting duration.
 5. For the transmitting duration, please refer to clause 7.1.
 6. Filter losses were only considered in the spurious frequency bands and the authorized band was not corrected for High Pass Filter losses.
 7. Proper operation of the transmitter prior to adding the filter to the measurement chain.
 8. Since non-restricted band peak emissions are less than the average limit, they also comply with the -27dBm/MHz (68.2dBuV/m) limit.



HARMONICS AND SPURIOUS EMISSIONS (MID CHANNEL, VERTICAL)

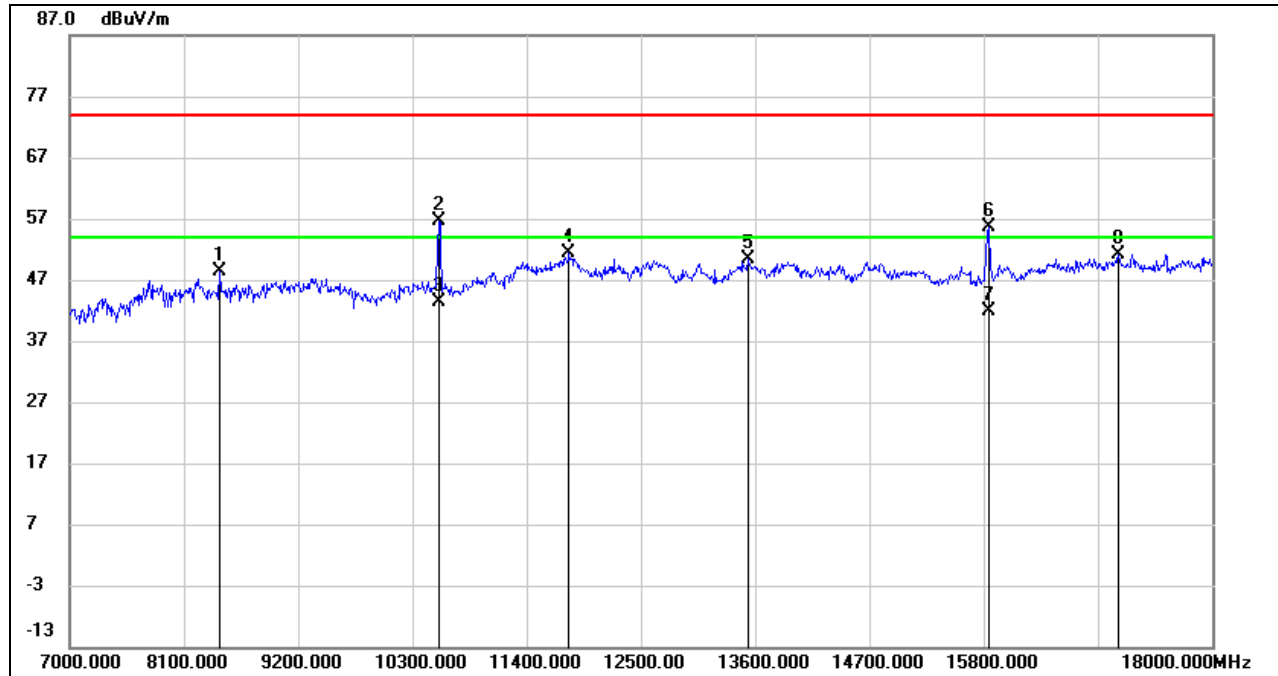

No.	Frequency (MHz)	Reading (dBuV)	Correct (dB/m)	Result (dBuV/m)	Limit (dBuV/m)	Margin (dB)	Remark
1	8441.000	39.88	8.56	48.44	74.00	-25.56	peak
2	10553.000	44.58	12.17	56.75	74.00	-17.25	peak
3	10553.000	31.18	12.17	43.35	54.00	-10.65	AVG
4	11807.000	35.71	15.61	51.32	74.00	-22.68	peak
5	13534.000	34.02	16.42	50.44	74.00	-23.56	peak
6	15844.000	38.79	16.92	55.71	74.00	-18.29	peak
7	15844.000	24.97	16.92	41.89	54.00	-12.11	AVG
8	17098.000	30.47	20.63	51.10	74.00	-22.90	peak

- Note: 1. Measurement = Reading Level + Correct Factor.
 2. If Peak Result complies with AV limit, AV Result is deemed to comply with AV limit.
 3. Peak: Peak detector.
 4. AVG: VBW=1/Ton, where: Ton is the transmitting duration.
 5. For the transmitting duration, please refer to clause 7.1.
 6. Filter losses were only considered in the spurious frequency bands and the authorized band was not corrected for High Pass Filter losses.
 7. Proper operation of the transmitter prior to adding the filter to the measurement chain.
 8. Since non-restricted band peak emissions are less than the average limit, they also comply with the -27dBm/MHz (68.2dBuV/m) limit.

HARMONICS AND SPURIOUS EMISSIONS (HIGH CHANNEL, HORIZONTAL)

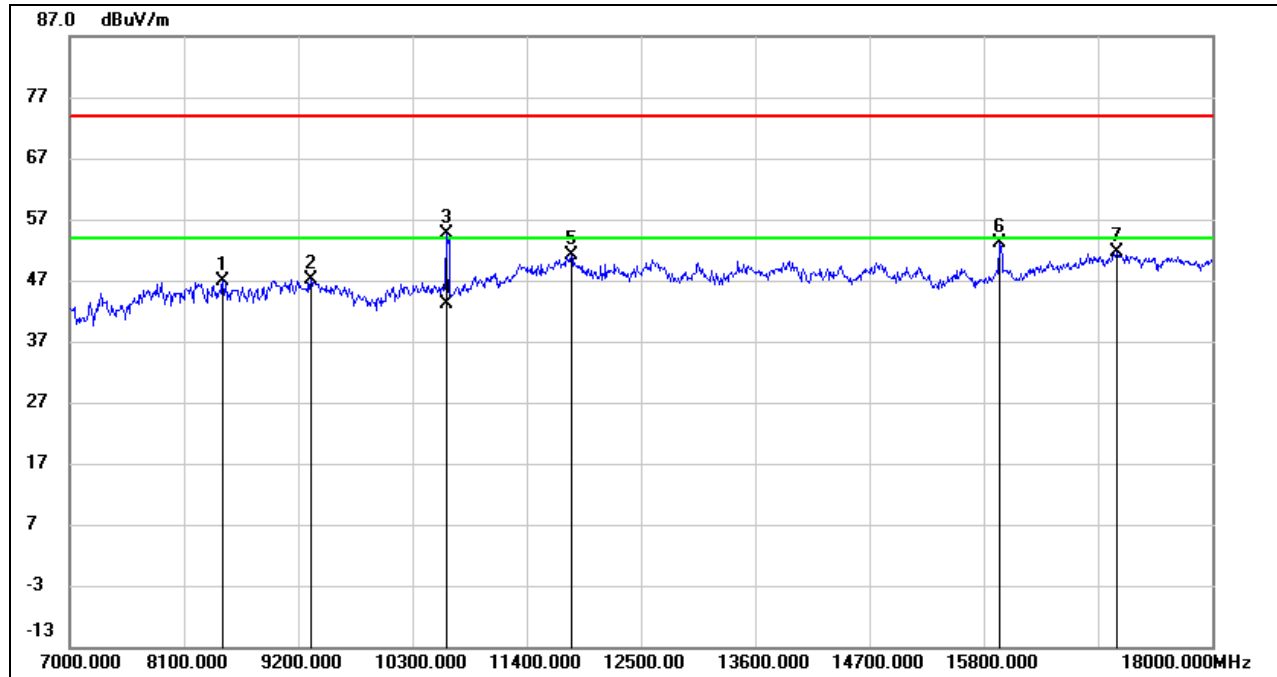

No.	Frequency (MHz)	Reading (dBuV)	Correct (dB/m)	Result (dBuV/m)	Limit (dBuV/m)	Margin (dB)	Remark
1	8474.000	38.25	8.55	46.80	74.00	-27.20	peak
2	9321.000	37.27	9.91	47.18	74.00	-26.82	peak
3	10630.000	42.34	12.41	54.75	74.00	-19.25	peak
4	10630.000	30.75	12.41	43.16	54.00	-10.84	AVG
5	11829.000	35.62	15.57	51.19	74.00	-22.81	peak
6	15954.000	35.94	17.14	53.08	74.00	-20.92	peak
7	17076.000	30.98	20.54	51.52	74.00	-22.48	peak

- Note:
1. Measurement = Reading Level + Correct Factor.
 2. If Peak Result complies with AV limit, AV Result is deemed to comply with AV limit.
 3. Peak: Peak detector.
 4. AVG: $VBW=1/Ton$, where: Ton is the transmitting duration.
 5. For the transmitting duration, please refer to clause 7.1.
 6. Filter losses were only considered in the spurious frequency bands and the authorized band was not corrected for High Pass Filter losses.
 7. Proper operation of the transmitter prior to adding the filter to the measurement chain.
 8. Since non-restricted band peak emissions are less than the average limit, they also comply with the -27dBm/MHz (68.2dBuV/m) limit.

HARMONICS AND SPURIOUS EMISSIONS (HIGH CHANNEL, VERTICAL)

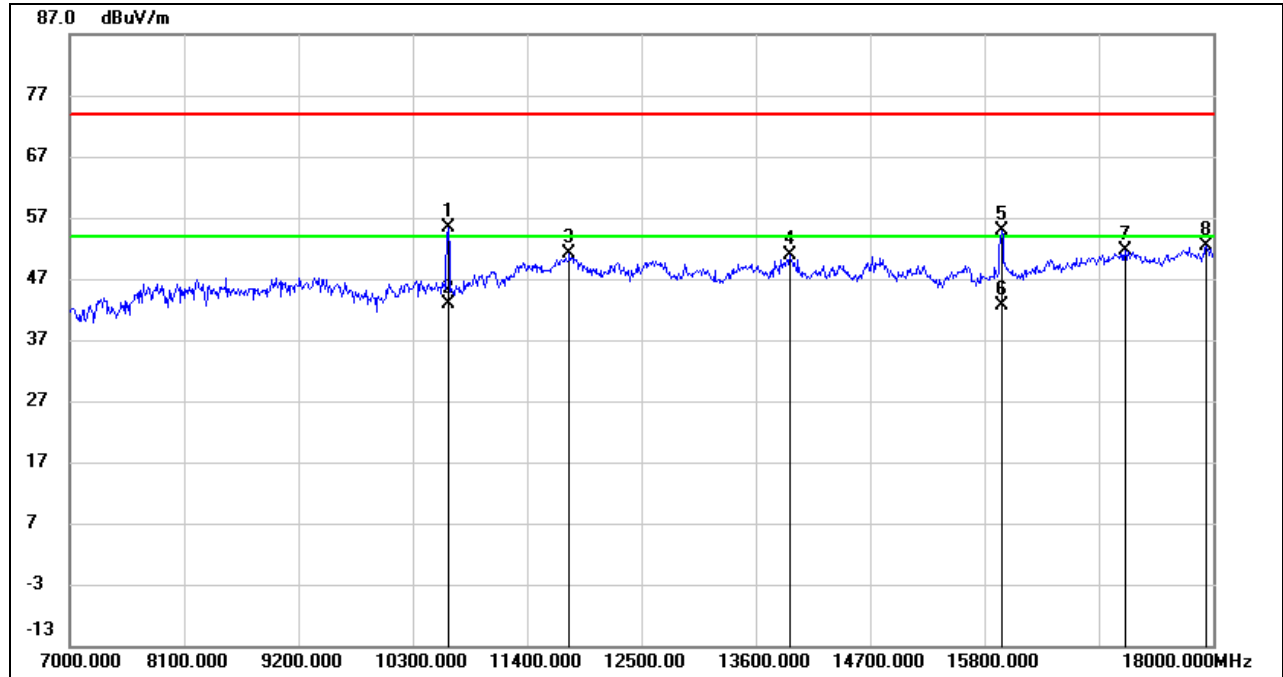

No.	Frequency (MHz)	Reading (dBuV)	Correct (dB/m)	Result (dBuV/m)	Limit (dBuV/m)	Margin (dB)	Remark
1	10641.000	42.89	12.42	55.31	74.00	-18.69	peak
2	10641.000	30.52	12.42	42.94	54.00	-11.06	AVG
3	11807.000	35.52	15.61	51.13	74.00	-22.87	peak
4	13930.000	33.92	16.89	50.81	74.00	-23.19	peak
5	15965.000	37.83	17.16	54.99	74.00	-19.01	peak
6	15965.000	25.59	17.16	42.75	54.00	-11.25	AVG
7	17153.000	30.67	20.85	51.52	74.00	-22.48	peak
8	17934.000	29.61	22.69	52.30	74.00	-21.70	peak

- Note: 1. Measurement = Reading Level + Correct Factor.
 2. If Peak Result complies with AV limit, AV Result is deemed to comply with AV limit.
 3. Peak: Peak detector.
 4. AVG: $VBW=1/Ton$, where: Ton is the transmitting duration.
 5. For the transmitting duration, please refer to clause 7.1.
 6. Filter losses were only considered in the spurious frequency bands and the authorized band was not corrected for High Pass Filter losses.
 7. Proper operation of the transmitter prior to adding the filter to the measurement chain.
 8. Since non-restricted band peak emissions are less than the average limit, they also comply with the -27dBm/MHz (68.2dBuV/m) limit.



UNII-2C BAND

HARMONICS AND SPURIOUS EMISSIONS (LOW CHANNEL, HORIZONTAL)

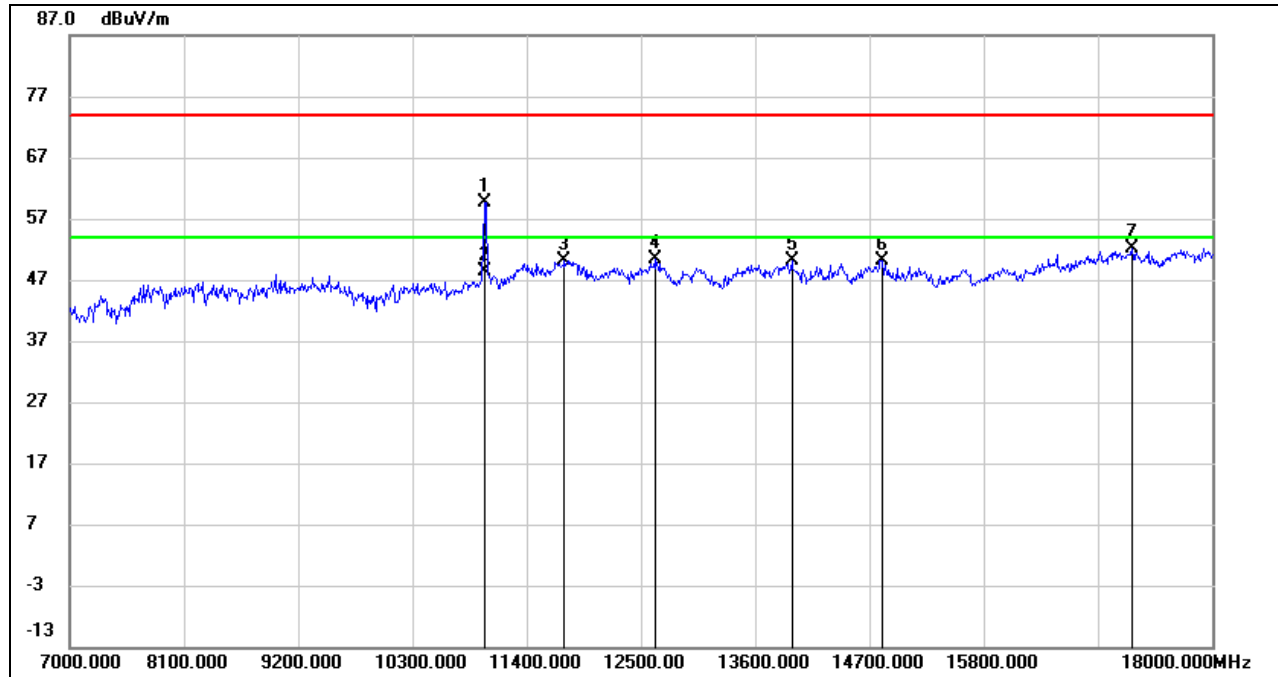

No.	Frequency (MHz)	Reading (dBuV)	Correct (dB/m)	Result (dBuV/m)	Limit (dBuV/m)	Margin (dB)	Remark
1	10993.000	46.38	13.24	59.62	74.00	-14.38	peak
2	10993.000	35.04	13.24	48.28	54.00	-5.72	AVG
3	11763.000	34.75	15.41	50.16	74.00	-23.84	peak
4	12632.000	34.93	15.35	50.28	74.00	-23.72	peak
5	13952.000	33.18	16.88	50.06	74.00	-23.94	peak
6	14821.000	33.39	16.81	50.20	74.00	-23.80	peak
7	17230.000	31.14	20.99	52.13	74.00	-21.87	peak

- Note: 1. Measurement = Reading Level + Correct Factor.
 2. If Peak Result complies with AV limit, AV Result is deemed to comply with AV limit.
 3. Peak: Peak detector.
 4. AVG: VBW=1/Ton, where: Ton is the transmitting duration.
 5. For the transmitting duration, please refer to clause 7.1.
 6. Filter losses were only considered in the spurious frequency bands and the authorized band was not corrected for High Pass Filter losses.
 7. Proper operation of the transmitter prior to adding the filter to the measurement chain.
 8. Since non-restricted band peak emissions are less than the average limit, they also comply with the -27dBm/MHz (68.2dBuV/m) limit.



HARMONICS AND SPURIOUS EMISSIONS (LOW CHANNEL, VERTICAL)

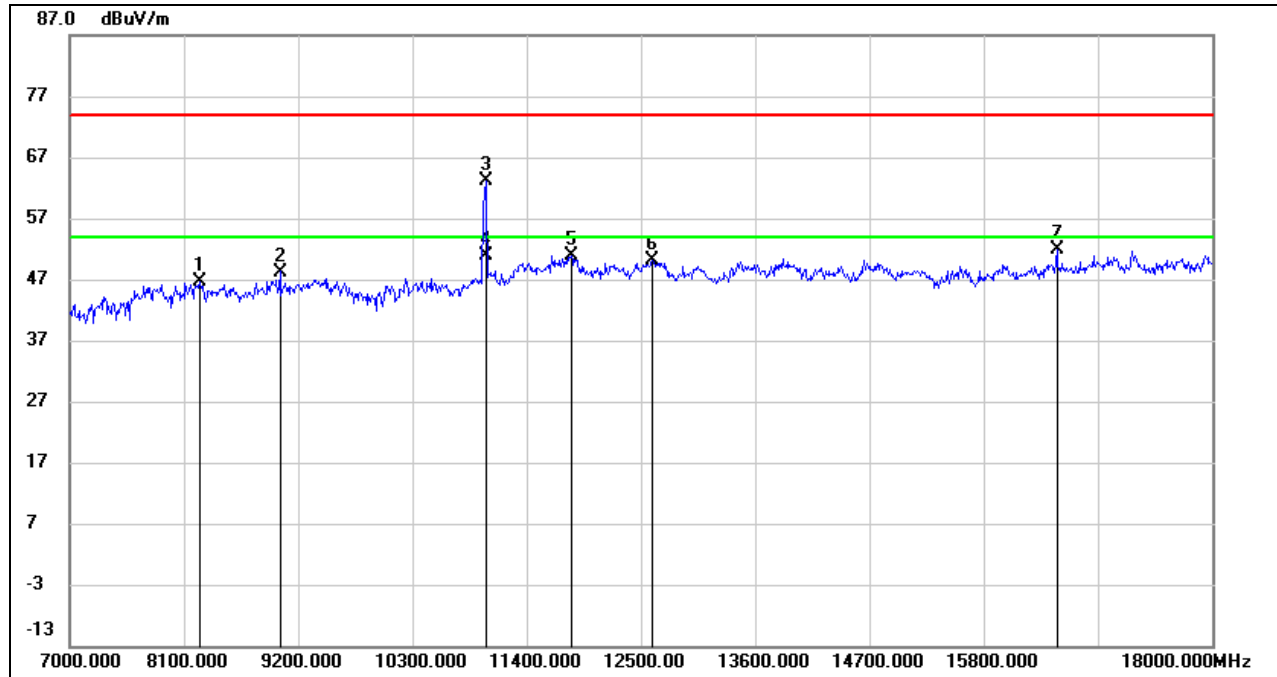

No.	Frequency (MHz)	Reading (dBuV)	Correct (dB/m)	Result (dBuV/m)	Limit (dBuV/m)	Margin (dB)	Remark
1	8254.000	37.55	9.15	46.70	74.00	-27.30	peak
2	9024.000	37.78	10.47	48.25	74.00	-25.75	peak
3	11004.000	49.77	13.26	63.03	74.00	-10.97	peak
4	11004.000	37.67	13.26	50.93	54.00	-3.07	AVG
5	11829.000	35.26	15.57	50.83	74.00	-23.17	peak
6	12610.000	34.78	15.30	50.08	74.00	-23.92	peak
7	16504.000	32.79	19.14	51.93	74.00	-22.07	peak

- Note: 1. Measurement = Reading Level + Correct Factor.
 2. If Peak Result complies with AV limit, AV Result is deemed to comply with AV limit.
 3. Peak: Peak detector.
 4. AVG: $VBW=1/Ton$, where: Ton is the transmitting duration.
 5. For the transmitting duration, please refer to clause 7.1.
 6. Filter losses were only considered in the spurious frequency bands and the authorized band was not corrected for High Pass Filter losses.
 7. Proper operation of the transmitter prior to adding the filter to the measurement chain.
 8. Since non-restricted band peak emissions are less than the average limit, they also comply with the -27dBm/MHz (68.2dBuV/m) limit.



HARMONICS AND SPURIOUS EMISSIONS (MID CHANNEL, HORIZONTAL)

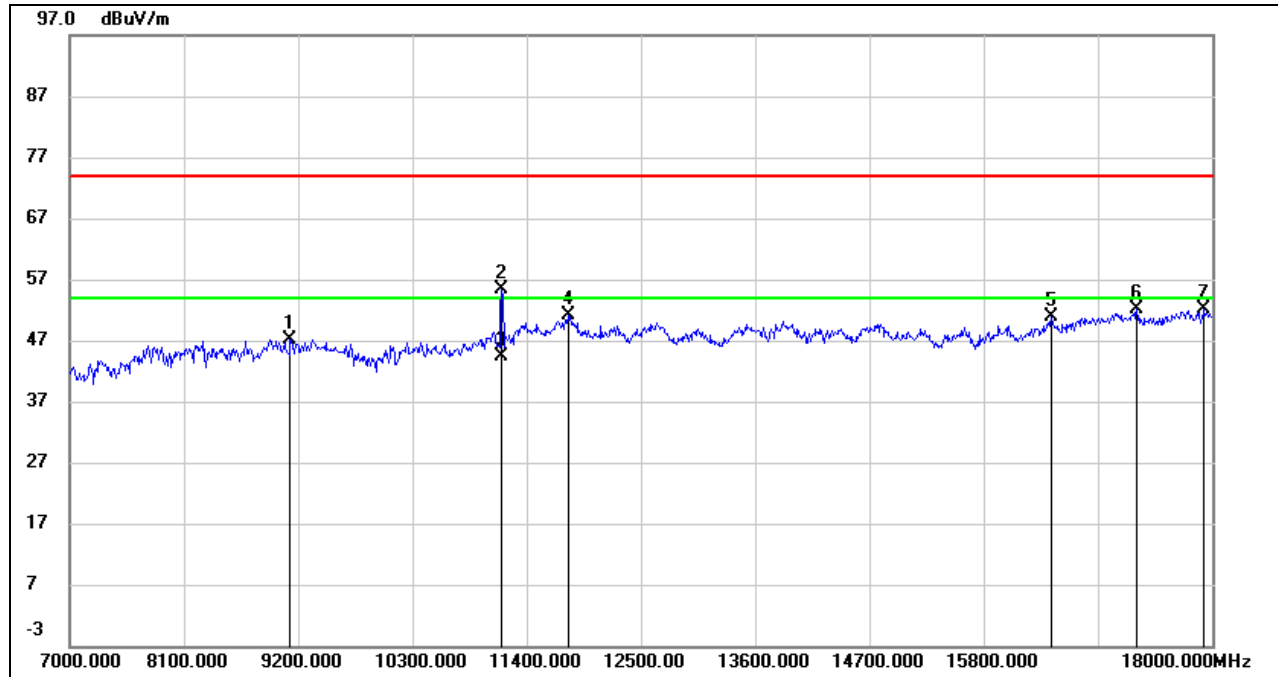

No.	Frequency (MHz)	Reading (dBuV)	Correct (dB/m)	Result (dBuV/m)	Limit (dBuV/m)	Margin (dB)	Remark
1	9123.000	37.40	9.81	47.21	74.00	-26.79	peak
2	11158.000	41.81	13.56	55.37	74.00	-18.63	peak
3	11158.000	30.87	13.56	44.43	54.00	-9.57	AVG
4	11796.000	35.57	15.59	51.16	74.00	-22.84	peak
5	16449.000	31.88	18.91	50.79	74.00	-23.21	peak
6	17274.000	31.14	20.93	52.07	74.00	-21.93	peak
7	17923.000	29.49	22.69	52.18	74.00	-21.82	peak

- Note: 1. Measurement = Reading Level + Correct Factor.
 2. If Peak Result complies with AV limit, AV Result is deemed to comply with AV limit.
 3. Peak: Peak detector.
 4. AVG: $VBW=1/Ton$, where: Ton is the transmitting duration.
 5. For the transmitting duration, please refer to clause 7.1.
 6. Filter losses were only considered in the spurious frequency bands and the authorized band was not corrected for High Pass Filter losses.
 7. Proper operation of the transmitter prior to adding the filter to the measurement chain.
 8. Since non-restricted band peak emissions are less than the average limit, they also comply with the -27dBm/MHz (68.2dBuV/m) limit.



HARMONICS AND SPURIOUS EMISSIONS (MID CHANNEL, VERTICAL)

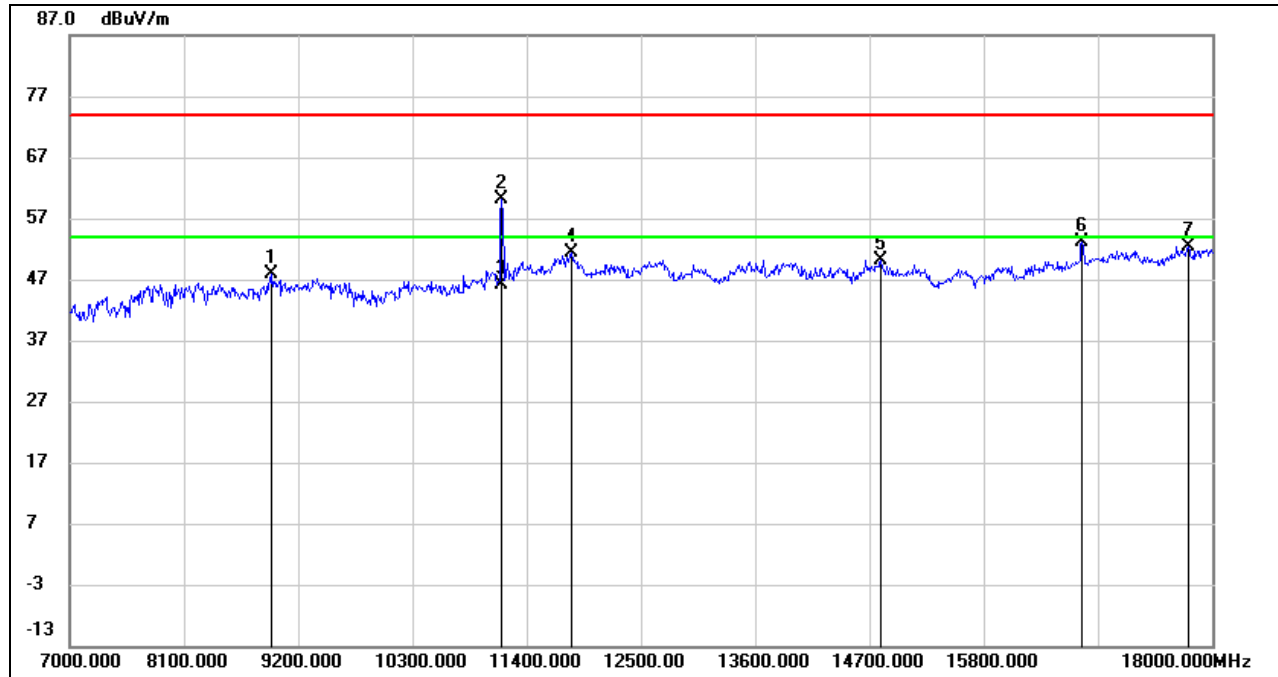

No.	Frequency (MHz)	Reading (dBuV)	Correct (dB/m)	Result (dBuV/m)	Limit (dBuV/m)	Margin (dB)	Remark
1	8947.000	37.70	10.07	47.77	74.00	-26.23	peak
2	11158.000	46.64	13.56	60.20	74.00	-13.80	peak
3	11158.000	32.59	13.56	46.15	54.00	-7.85	AVG
4	11829.000	35.84	15.57	51.41	74.00	-22.59	peak
5	14810.000	33.31	16.80	50.11	74.00	-23.89	peak
6	16746.000	33.47	19.68	53.15	74.00	-20.85	peak
7	17769.000	29.97	22.48	52.45	74.00	-21.55	peak

- Note: 1. Measurement = Reading Level + Correct Factor.
 2. If Peak Result complies with AV limit, AV Result is deemed to comply with AV limit.
 3. Peak: Peak detector.
 4. AVG: $VBW=1/Ton$, where: Ton is the transmitting duration.
 5. For the transmitting duration, please refer to clause 7.1.
 6. Filter losses were only considered in the spurious frequency bands and the authorized band was not corrected for High Pass Filter losses.
 7. Proper operation of the transmitter prior to adding the filter to the measurement chain.
 8. Since non-restricted band peak emissions are less than the average limit, they also comply with the -27dBm/MHz (68.2dBuV/m) limit.



HARMONICS AND SPURIOUS EMISSIONS (HIGH CHANNEL, HORIZONTAL)

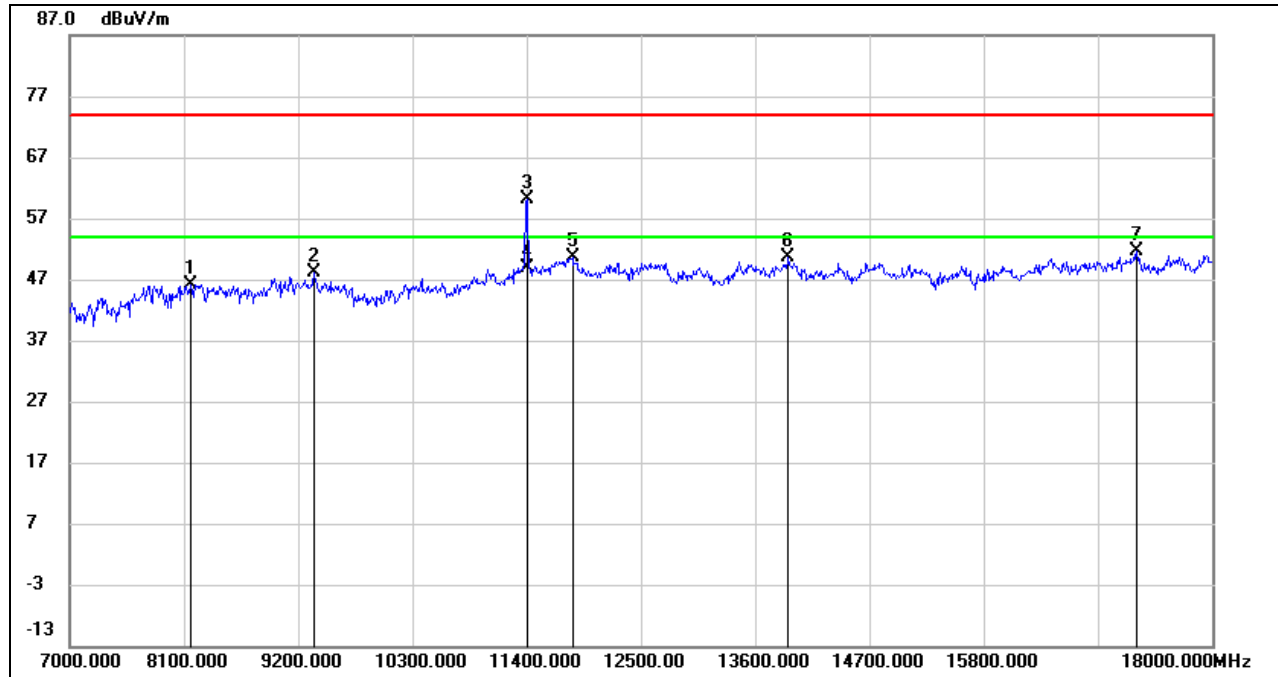

No.	Frequency (MHz)	Reading (dBuV)	Correct (dB/m)	Result (dBuV/m)	Limit (dBuV/m)	Margin (dB)	Remark
1	8166.000	37.02	9.07	46.09	74.00	-27.91	peak
2	9354.000	38.00	10.07	48.07	74.00	-25.93	peak
3	11400.000	45.89	14.22	60.11	74.00	-13.89	peak
4	11400.000	34.54	14.22	48.76	54.00	-5.24	AVG
5	11840.000	35.14	15.56	50.70	74.00	-23.30	peak
6	13919.000	33.71	16.89	50.60	74.00	-23.40	peak
7	17274.000	30.59	20.93	51.52	74.00	-22.48	peak

- Note: 1. Measurement = Reading Level + Correct Factor.
 2. If Peak Result complies with AV limit, AV Result is deemed to comply with AV limit.
 3. Peak: Peak detector.
 4. AVG: $VBW=1/Ton$, where: Ton is the transmitting duration.
 5. For the transmitting duration, please refer to clause 7.1.
 6. Filter losses were only considered in the spurious frequency bands and the authorized band was not corrected for High Pass Filter losses.
 7. Proper operation of the transmitter prior to adding the filter to the measurement chain.
 8. Since non-restricted band peak emissions are less than the average limit, they also comply with the -27dBm/MHz (68.2dBuV/m) limit.



HARMONICS AND SPURIOUS EMISSIONS (HIGH CHANNEL, VERTICAL)

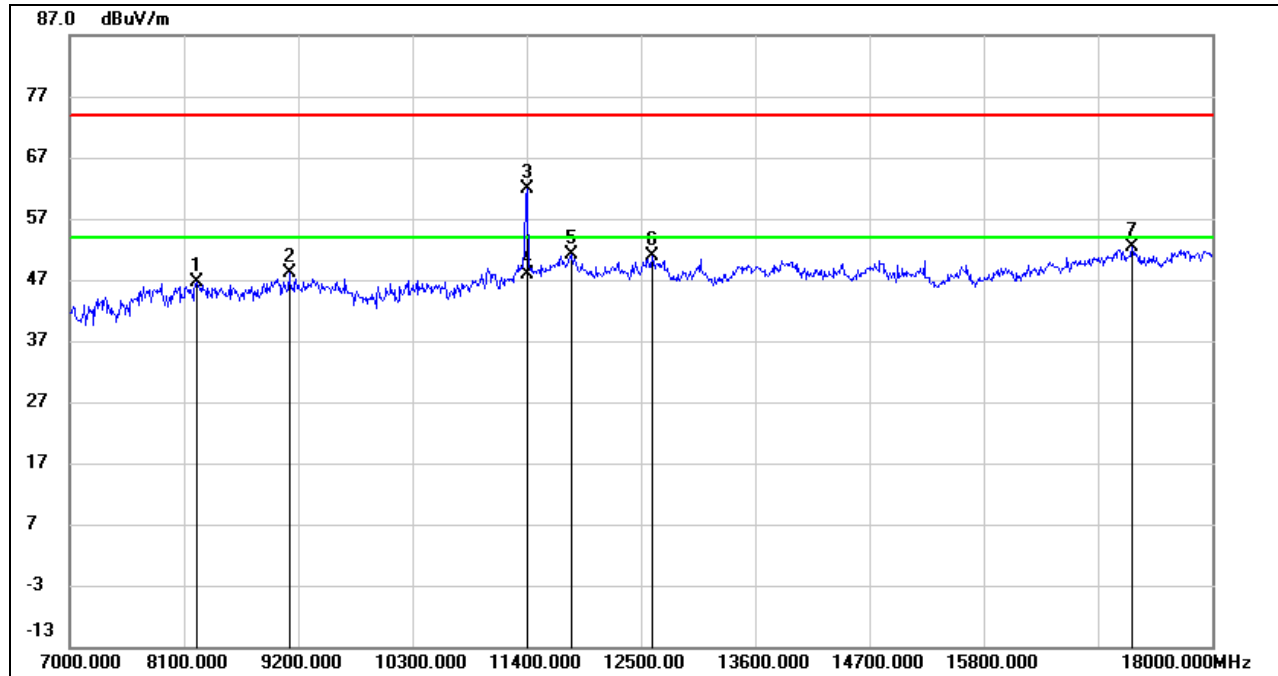

No.	Frequency (MHz)	Reading (dBuV)	Correct (dB/m)	Result (dBuV/m)	Limit (dBuV/m)	Margin (dB)	Remark
1	8221.000	37.41	9.28	46.69	74.00	-27.31	peak
2	9112.000	38.36	9.88	48.24	74.00	-25.76	peak
3	11400.000	47.62	14.22	61.84	74.00	-12.16	peak
4	11400.000	33.54	14.22	47.76	54.00	-6.24	AVG
5	11829.000	35.45	15.57	51.02	74.00	-22.98	peak
6	12610.000	35.59	15.30	50.89	74.00	-23.11	peak
7	17230.000	31.29	20.99	52.28	74.00	-21.72	peak

- Note: 1. Measurement = Reading Level + Correct Factor.
 2. If Peak Result complies with AV limit, AV Result is deemed to comply with AV limit.
 3. Peak: Peak detector.
 4. AVG: $VBW=1/Ton$, where: Ton is the transmitting duration.
 5. For the transmitting duration, please refer to clause 7.1.
 6. Filter losses were only considered in the spurious frequency bands and the authorized band was not corrected for High Pass Filter losses.
 7. Proper operation of the transmitter prior to adding the filter to the measurement chain.
 8. Since non-restricted band peak emissions are less than the average limit, they also comply with the -27dBm/MHz (68.2dBuV/m) limit.

STRADDLE CHANNEL 144

HARMONICS AND SPURIOUS EMISSIONS (HORIZONTAL)

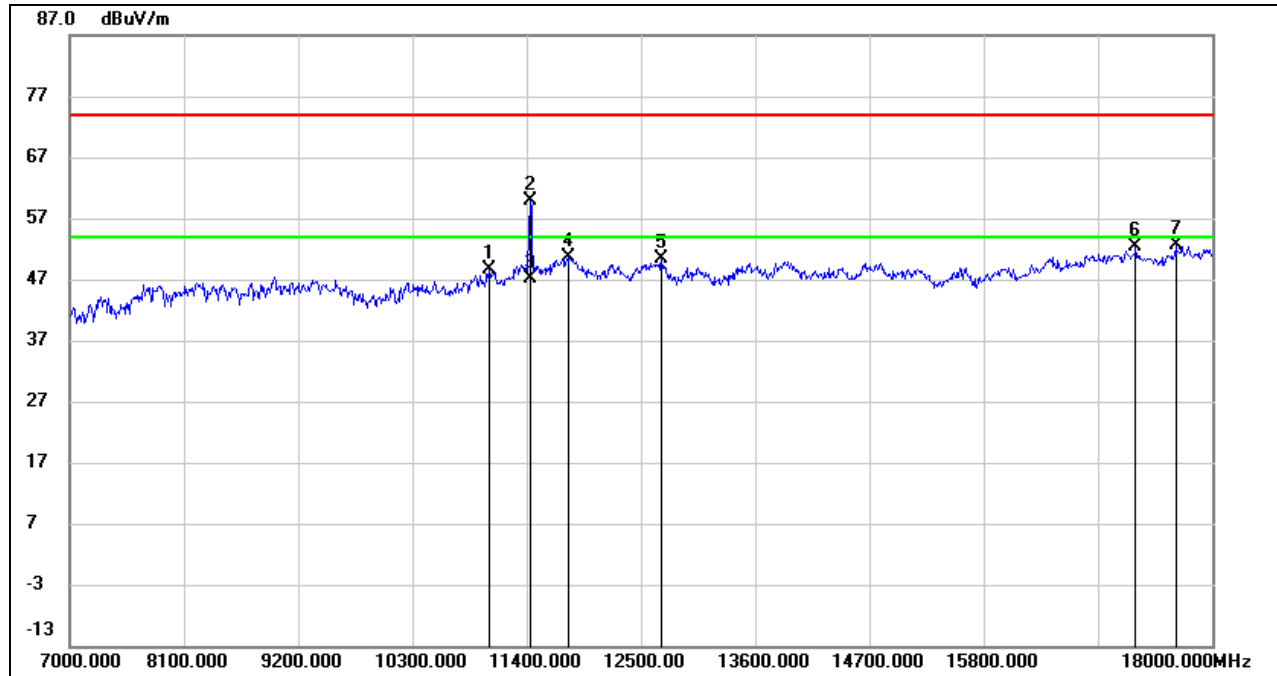

No.	Frequency (MHz)	Reading (dBuV)	Correct (dB/m)	Result (dBuV/m)	Limit (dBuV/m)	Margin (dB)	Remark
1	11037.000	35.19	13.33	48.52	74.00	-25.48	peak
2	11433.000	45.56	14.27	59.83	74.00	-14.17	peak
3	11433.000	32.94	14.27	47.21	54.00	-6.79	AVG
4	11807.000	35.01	15.61	50.62	74.00	-23.38	peak
5	12698.000	34.85	15.47	50.32	74.00	-23.68	peak
6	17263.000	31.41	20.95	52.36	74.00	-21.64	peak
7	17648.000	31.05	21.54	52.59	74.00	-21.41	peak

- Note:
1. Measurement = Reading Level + Correct Factor.
 2. If Peak Result complies with AV limit, AV Result is deemed to comply with AV limit.
 3. Peak: Peak detector.
 4. AVG: $VBW=1/Ton$, where: Ton is the transmitting duration.
 5. For the transmitting duration, please refer to clause 7.1.
 6. Filter losses were only considered in the spurious frequency bands and the authorized band was not corrected for High Pass Filter losses.
 7. Proper operation of the transmitter prior to adding the filter to the measurement chain.
 8. Since non-restricted band peak emissions are less than the average limit, they also comply with the -27dBm/MHz (68.2dBuV/m) limit.



HARMONICS AND SPURIOUS EMISSIONS (VERTICAL)

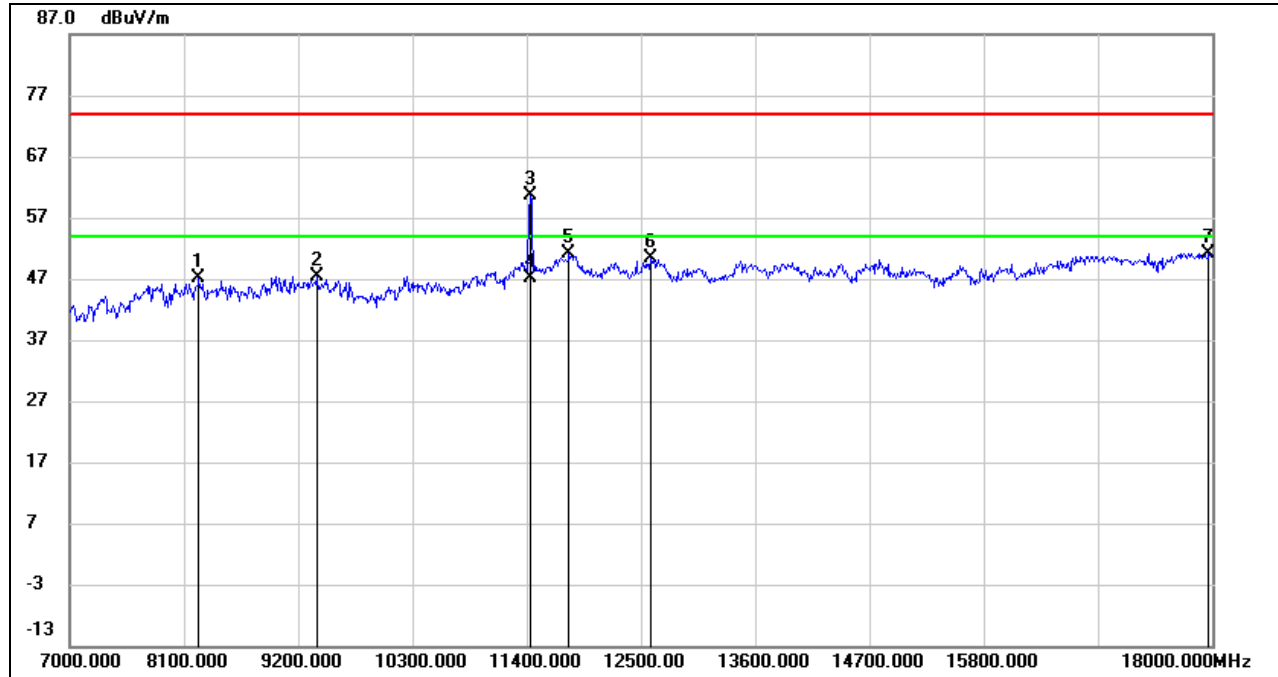

No.	Frequency (MHz)	Reading (dBuV)	Correct (dB/m)	Result (dBuV/m)	Limit (dBuV/m)	Margin (dB)	Remark
1	8243.000	37.97	9.19	47.16	74.00	-26.84	peak
2	9376.000	37.23	10.19	47.42	74.00	-26.58	peak
3	11433.000	46.42	14.27	60.69	74.00	-13.31	peak
4	11433.000	32.98	14.27	47.25	54.00	-6.75	AVG
5	11807.000	35.40	15.61	51.01	74.00	-22.99	peak
6	12588.000	35.14	15.29	50.43	74.00	-23.57	peak
7	17967.000	28.56	22.67	51.23	74.00	-22.77	peak

- Note: 1. Measurement = Reading Level + Correct Factor.
 2. If Peak Result complies with AV limit, AV Result is deemed to comply with AV limit.
 3. Peak: Peak detector.
 4. AVG: VBW=1/Ton, where: Ton is the transmitting duration.
 5. For the transmitting duration, please refer to clause 7.1.
 6. Filter losses were only considered in the spurious frequency bands and the authorized band was not corrected for High Pass Filter losses.
 7. Proper operation of the transmitter prior to adding the filter to the measurement chain.
 8. Since non-restricted band peak emissions are less than the average limit, they also comply with the -27dBm/MHz (68.2dBuV/m) limit.



UNII-3 BAND

HARMONICS AND SPURIOUS EMISSIONS (LOW CHANNEL, HORIZONTAL)

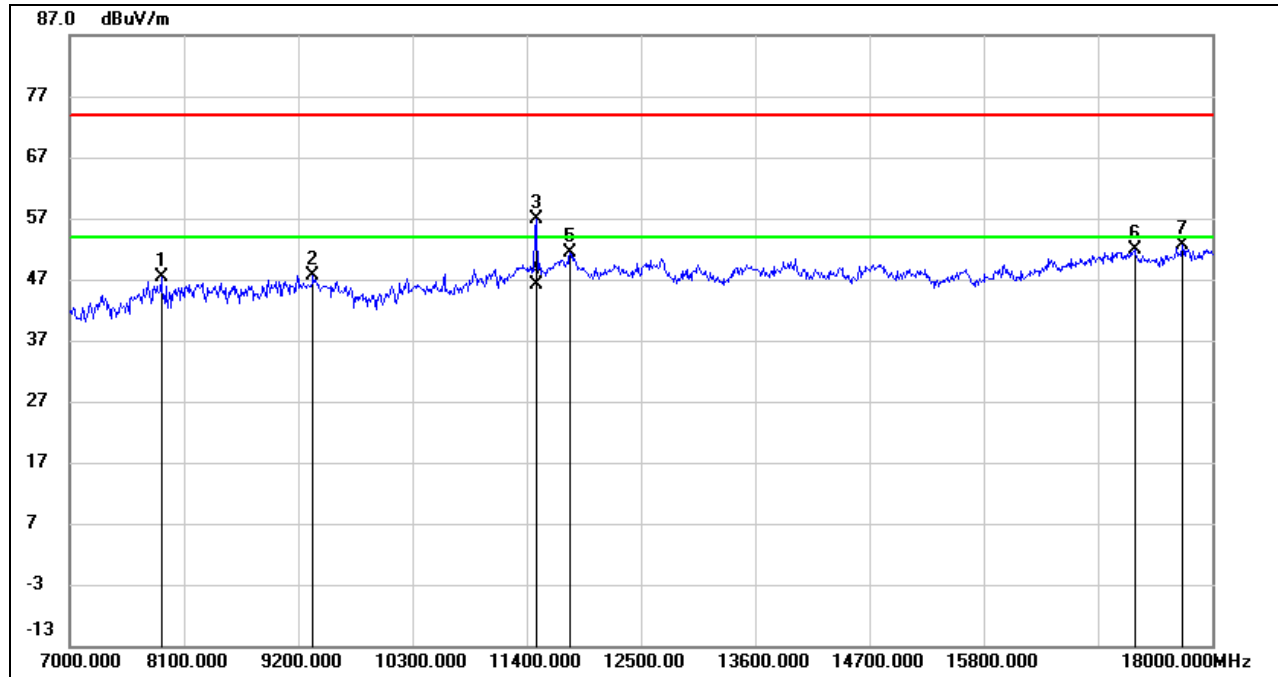

No.	Frequency (MHz)	Reading (dBuV)	Correct (dB/m)	Result (dBuV/m)	Limit (dBuV/m)	Margin (dB)	Remark
1	7880.000	39.28	8.01	47.29	74.00	-26.71	peak
2	9343.000	37.72	10.02	47.74	74.00	-26.26	peak
3	11488.000	42.55	14.34	56.89	74.00	-17.11	peak
4	11488.000	31.70	14.34	46.04	54.00	-7.96	AVG
5	11818.000	35.78	15.58	51.36	74.00	-22.64	peak
6	17252.000	30.88	20.97	51.85	74.00	-22.15	peak
7	17714.000	30.49	22.04	52.53	74.00	-21.47	peak

Note: 1. Measurement = Reading Level + Correct Factor.
 2. If Peak Result complies with AV limit, AV Result is deemed to comply with AV limit.
 3. Peak: Peak detector.
 4. AVG: VBW=1/Ton, where: Ton is the transmitting duration.
 5. For the transmitting duration, please refer to clause 7.1.
 6. Filter losses were only considered in the spurious frequency bands and the authorized band was not corrected for High Pass Filter losses.
 7. Proper operation of the transmitter prior to adding the filter to the measurement chain.
 8. Since non-restricted band peak emissions are less than the average limit, they also comply with the -27dBm/MHz (68.2dBuV/m) limit.



HARMONICS AND SPURIOUS EMISSIONS (LOW CHANNEL, VERTICAL)

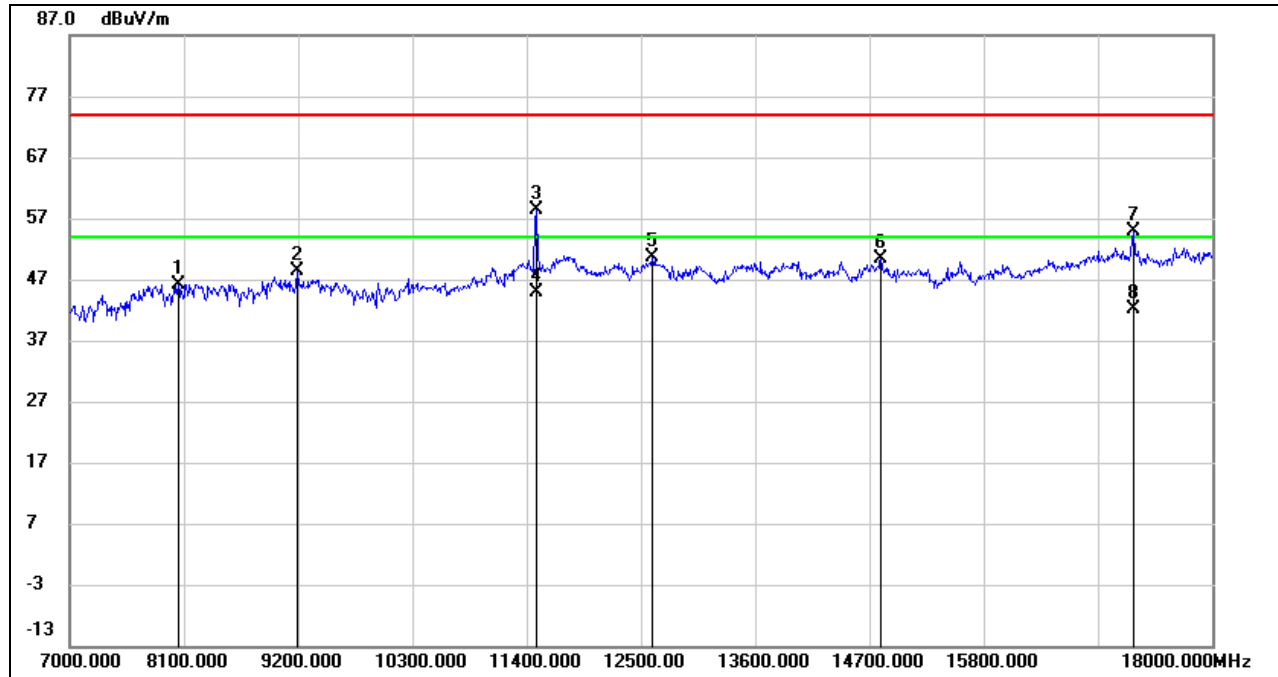

No.	Frequency (MHz)	Reading (dBuV)	Correct (dB/m)	Result (dBuV/m)	Limit (dBuV/m)	Margin (dB)	Remark
1	8045.000	38.13	8.04	46.17	74.00	-27.83	peak
2	9189.000	38.99	9.36	48.35	74.00	-25.65	peak
3	11488.000	44.05	14.34	58.39	74.00	-15.61	peak
4	11488.000	30.55	14.34	44.89	54.00	-9.11	AVG
5	12610.000	35.38	15.30	50.68	74.00	-23.32	peak
6	14810.000	33.50	16.80	50.30	74.00	-23.70	peak
7	17241.000	33.86	20.97	54.83	74.00	-19.17	peak
8	17241.000	21.26	20.97	42.23	54.00	-11.77	AVG

- Note: 1. Measurement = Reading Level + Correct Factor.
 2. If Peak Result complies with AV limit, AV Result is deemed to comply with AV limit.
 3. Peak: Peak detector.
 4. AVG: $VBW=1/Ton$, where: Ton is the transmitting duration.
 5. For the transmitting duration, please refer to clause 7.1.
 6. Filter losses were only considered in the spurious frequency bands and the authorized band was not corrected for High Pass Filter losses.
 7. Proper operation of the transmitter prior to adding the filter to the measurement chain.
 8. Since non-restricted band peak emissions are less than the average limit, they also comply with the -27dBm/MHz (68.2dBuV/m) limit.

HARMONICS AND SPURIOUS EMISSIONS (MID CHANNEL, HORIZONTAL)

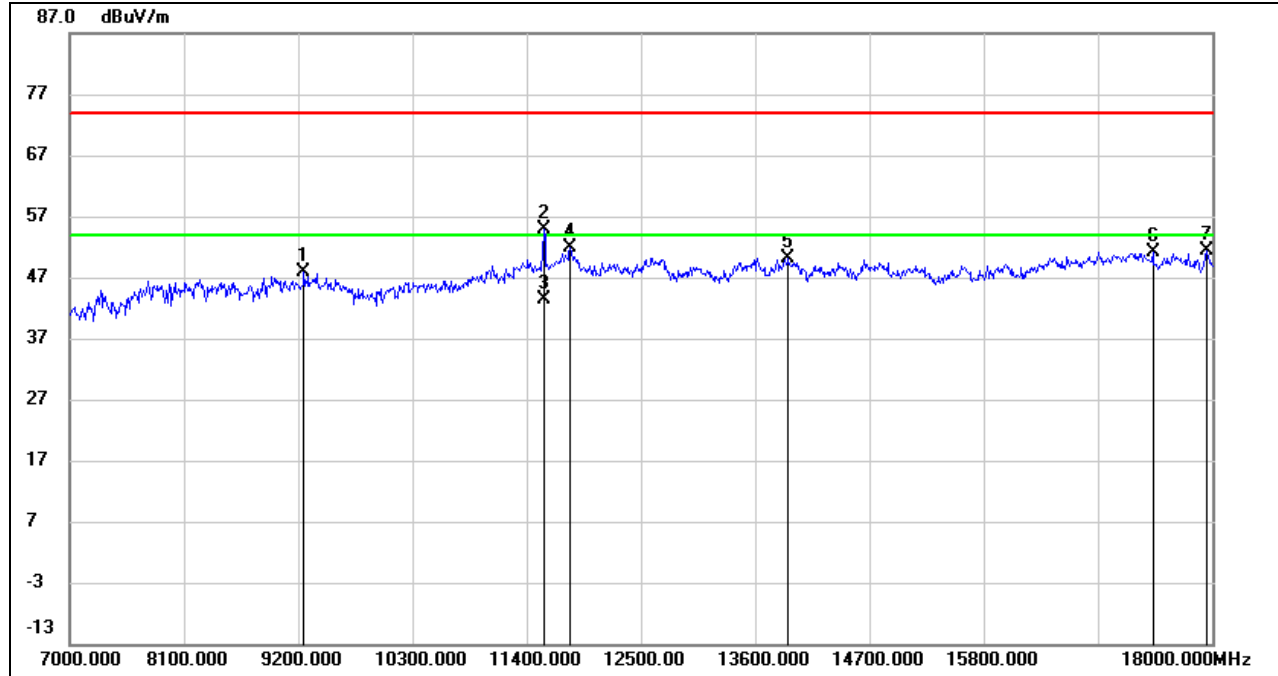

No.	Frequency (MHz)	Reading (dBuV)	Correct (dB/m)	Result (dBuV/m)	Limit (dBuV/m)	Margin (dB)	Remark
1	9255.000	38.27	9.56	47.83	74.00	-26.17	peak
2	11565.000	40.38	14.45	54.83	74.00	-19.17	peak
3	11565.000	28.90	14.45	43.35	54.00	-10.65	AVG
4	11818.000	36.36	15.58	51.94	74.00	-22.06	peak
5	13919.000	33.18	16.89	50.07	74.00	-23.93	peak
6	17428.000	30.33	20.76	51.09	74.00	-22.91	peak
7	17945.000	28.60	22.68	51.28	74.00	-22.72	peak

- Note:
1. Measurement = Reading Level + Correct Factor.
 2. If Peak Result complies with AV limit, AV Result is deemed to comply with AV limit.
 3. Peak: Peak detector.
 4. AVG: $VBW=1/Ton$, where: Ton is the transmitting duration.
 5. For the transmitting duration, please refer to clause 7.1.
 6. Filter losses were only considered in the spurious frequency bands and the authorized band was not corrected for High Pass Filter losses.
 7. Proper operation of the transmitter prior to adding the filter to the measurement chain.
 8. Since non-restricted band peak emissions are less than the average limit, they also comply with the -27dBm/MHz (68.2dBuV/m) limit.

HARMONICS AND SPURIOUS EMISSIONS (MID CHANNEL, VERTICAL)

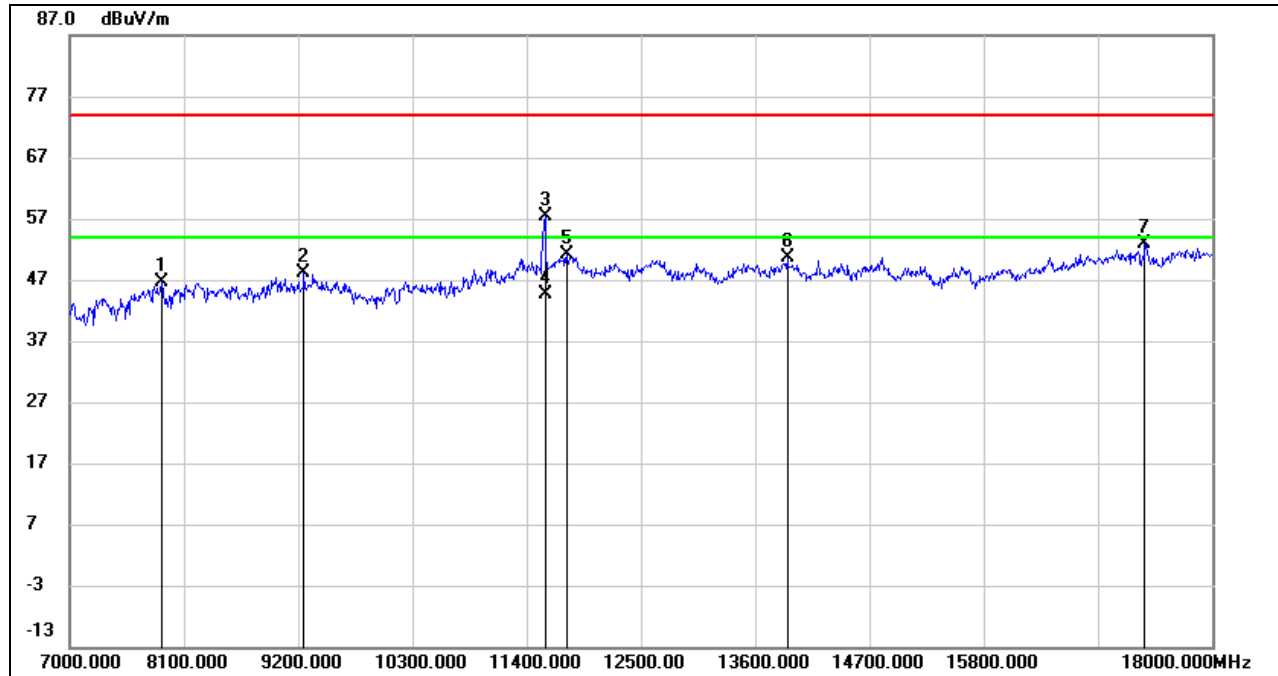

No.	Frequency (MHz)	Reading (dBuV)	Correct (dB/m)	Result (dBuV/m)	Limit (dBuV/m)	Margin (dB)	Remark
1	7891.000	38.66	7.98	46.64	74.00	-27.36	peak
2	9255.000	38.56	9.56	48.12	74.00	-25.88	peak
3	11576.000	42.95	14.48	57.43	74.00	-16.57	peak
4	11576.000	30.20	14.48	44.68	54.00	-9.32	AVG
5	11785.000	35.62	15.52	51.14	74.00	-22.86	peak
6	13908.000	33.62	16.90	50.52	74.00	-23.48	peak
7	17351.000	32.18	20.81	52.99	74.00	-21.01	peak

- Note: 1. Measurement = Reading Level + Correct Factor.
 2. If Peak Result complies with AV limit, AV Result is deemed to comply with AV limit.
 3. Peak: Peak detector.
 4. AVG: VBW=1/Ton, where: Ton is the transmitting duration.
 5. For the transmitting duration, please refer to clause 7.1.
 6. Filter losses were only considered in the spurious frequency bands and the authorized band was not corrected for High Pass Filter losses.
 7. Proper operation of the transmitter prior to adding the filter to the measurement chain.
 8. Since non-restricted band peak emissions are less than the average limit, they also comply with the -27dBm/MHz (68.2dBuV/m) limit.



HARMONICS AND SPURIOUS EMISSIONS (HIGH CHANNEL, HORIZONTAL)

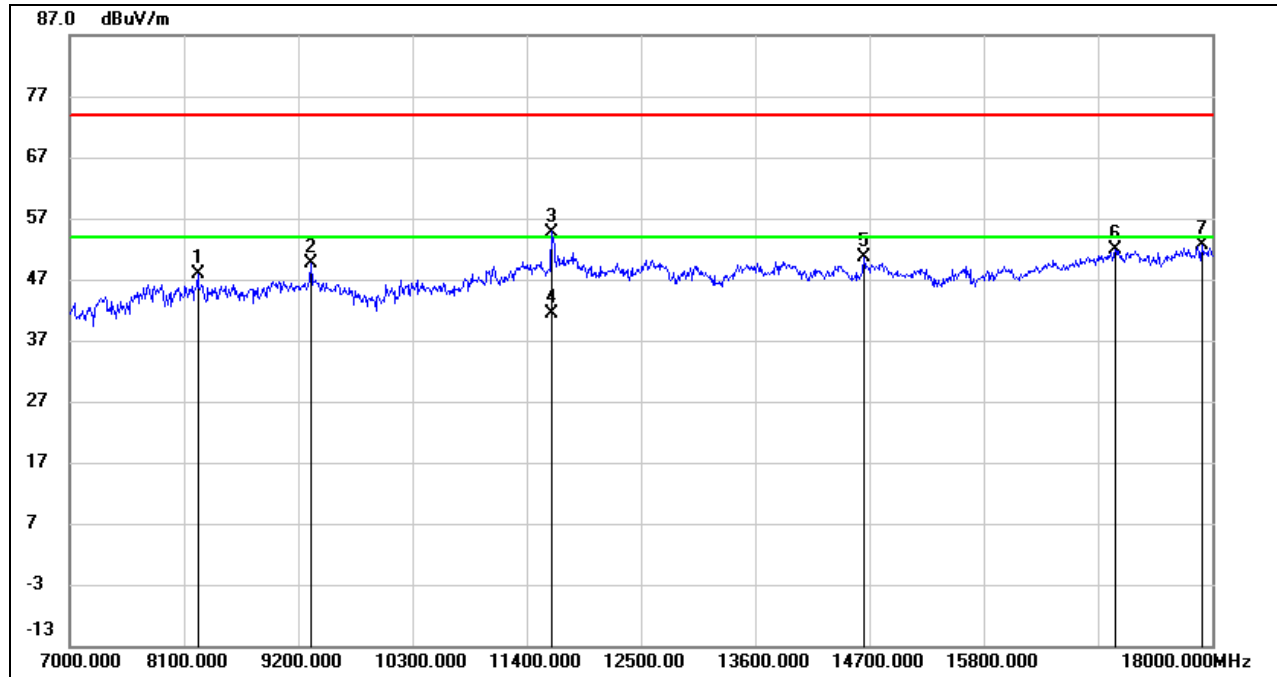

No.	Frequency (MHz)	Reading (dBuV)	Correct (dB/m)	Result (dBuV/m)	Limit (dBuV/m)	Margin (dB)	Remark
1	8232.000	38.57	9.23	47.80	74.00	-26.20	peak
2	9321.000	39.63	9.91	49.54	74.00	-24.46	peak
3	11642.000	40.01	14.74	54.75	74.00	-19.25	peak
4	11642.000	26.75	14.74	41.49	54.00	-12.51	AVG
5	14645.000	34.10	16.54	50.64	74.00	-23.36	peak
6	17065.000	31.30	20.49	51.79	74.00	-22.21	peak
7	17901.000	29.85	22.69	52.54	74.00	-21.46	peak

- Note: 1. Measurement = Reading Level + Correct Factor.
 2. If Peak Result complies with AV limit, AV Result is deemed to comply with AV limit.
 3. Peak: Peak detector.
 4. AVG: $VBW=1/Ton$, where: Ton is the transmitting duration.
 5. For the transmitting duration, please refer to clause 7.1.
 6. Filter losses were only considered in the spurious frequency bands and the authorized band was not corrected for High Pass Filter losses.
 7. Proper operation of the transmitter prior to adding the filter to the measurement chain.
 8. Since non-restricted band peak emissions are less than the average limit, they also comply with the -27dBm/MHz (68.2dBuV/m) limit.



HARMONICS AND SPURIOUS EMISSIONS (HIGH CHANNEL, VERTICAL)

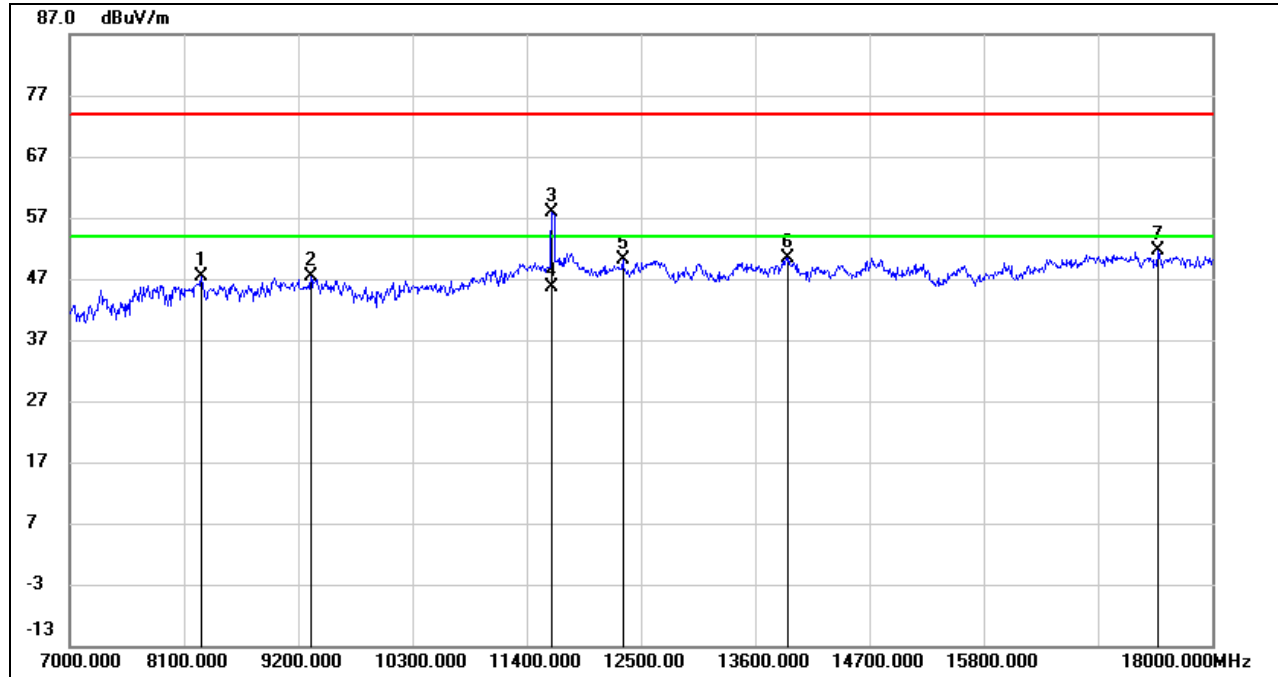

No.	Frequency (MHz)	Reading (dBuV)	Correct (dB/m)	Result (dBuV/m)	Limit (dBuV/m)	Margin (dB)	Remark
1	8265.000	38.16	9.11	47.27	74.00	-26.73	peak
2	9321.000	37.42	9.91	47.33	74.00	-26.67	peak
3	11642.000	43.25	14.74	57.99	74.00	-16.01	peak
4	11642.000	30.97	14.74	45.71	54.00	-8.29	AVG
5	12324.000	34.69	15.36	50.05	74.00	-23.95	peak
6	13919.000	33.55	16.89	50.44	74.00	-23.56	peak
7	17483.000	30.74	20.82	51.56	74.00	-22.44	peak

- Note: 1. Measurement = Reading Level + Correct Factor.
 2. If Peak Result complies with AV limit, AV Result is deemed to comply with AV limit.
 3. Peak: Peak detector.
 4. AVG: VBW=1/Ton, where: Ton is the transmitting duration.
 5. For the transmitting duration, please refer to clause 7.1.
 6. Filter losses were only considered in the spurious frequency bands and the authorized band was not corrected for High Pass Filter losses.
 7. Proper operation of the transmitter prior to adding the filter to the measurement chain.
 8. Since non-restricted band peak emissions are less than the average limit, they also comply with the -27dBm/MHz (68.2dBuV/m) limit.

8.3.3. 802.11n HT40 MIMO MODE

UNII-1 BAND

HARMONICS AND SPURIOUS EMISSIONS (LOW CHANNEL, HORIZONTAL)

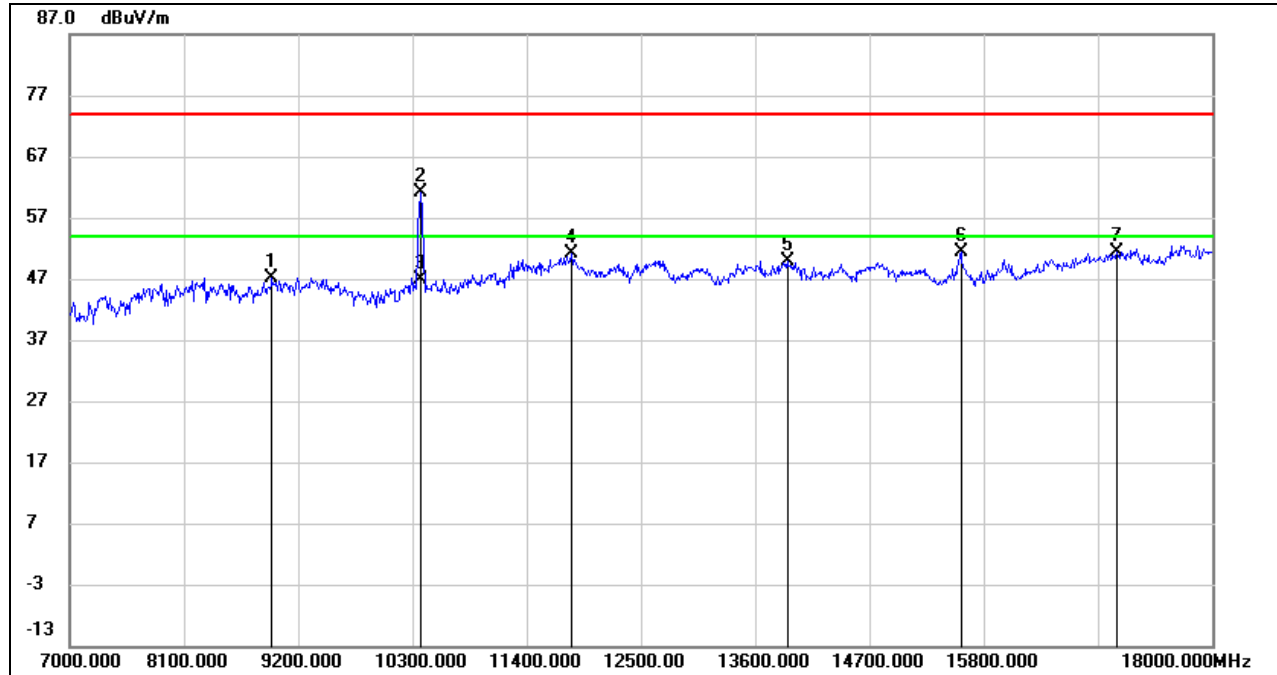

No.	Frequency (MHz)	Reading (dBuV)	Correct (dB/m)	Result (dBuV/m)	Limit (dBuV/m)	Margin (dB)	Remark
1	8947.000	36.98	10.07	47.05	74.00	-26.95	peak
2	10377.000	49.83	11.37	61.20	74.00	-12.80	peak
3	10377.000	35.44	11.37	46.81	54.00	-7.19	AVG
4	11829.000	35.63	15.57	51.20	74.00	-22.80	peak
5	13908.000	32.95	16.90	49.85	74.00	-24.15	peak
6	15580.000	34.77	16.65	51.42	74.00	-22.58	peak
7	17076.000	30.86	20.54	51.40	74.00	-22.60	peak

- Note: 1. Measurement = Reading Level + Correct Factor.
 2. If Peak Result complies with AV limit, AV Result is deemed to comply with AV limit.
 3. Peak: Peak detector.
 4. AVG: $VBW=1/Ton$, where: Ton is the transmitting duration.
 5. For the transmitting duration, please refer to clause 7.1.
 6. Filter losses were only considered in the spurious frequency bands and the authorized band was not corrected for High Pass Filter losses.
 7. Proper operation of the transmitter prior to adding the filter to the measurement chain.
 8. Since non-restricted band peak emissions are less than the average limit, they also comply with the -27dBm/MHz (68.2dBuV/m) limit.

HARMONICS AND SPURIOUS EMISSIONS (LOW CHANNEL, VERTICAL)

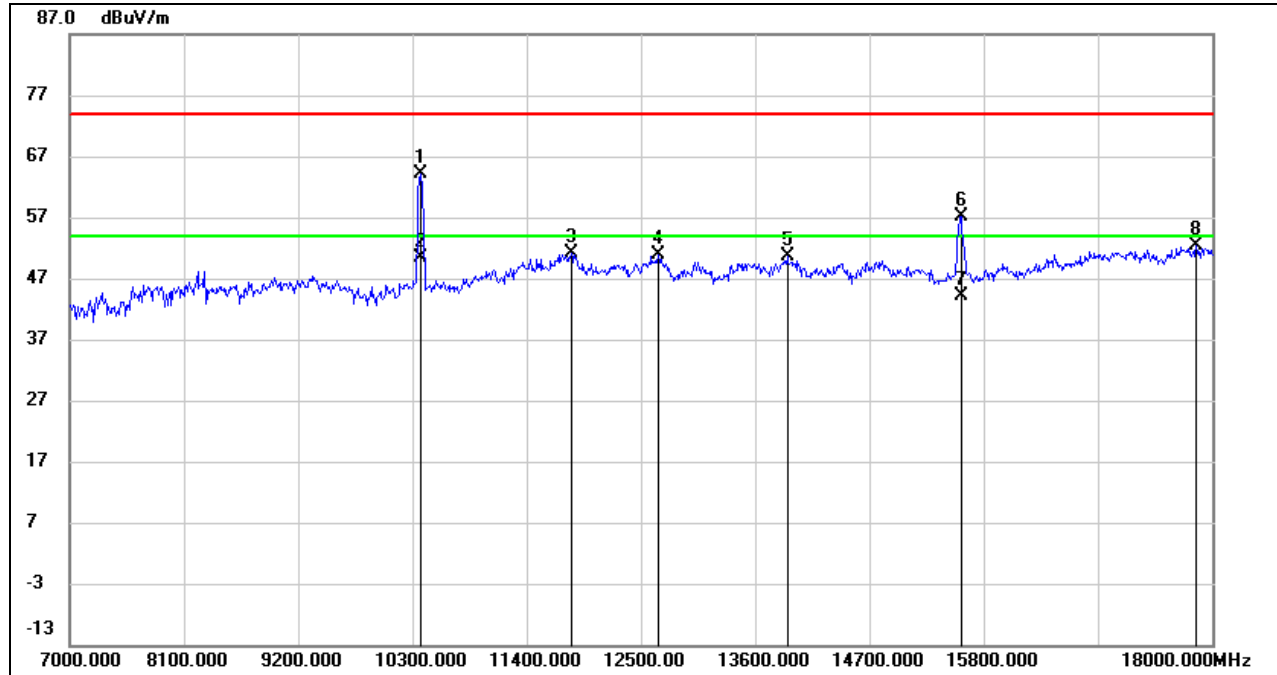

No.	Frequency (MHz)	Reading (dBuV)	Correct (dB/m)	Result (dBuV/m)	Limit (dBuV/m)	Margin (dB)	Remark
1	10377.000	52.65	11.37	64.02	74.00	-9.98	peak
2	10377.000	39.09	11.37	50.46	54.00	-3.54	AVG
3	11829.000	35.62	15.57	51.19	74.00	-22.81	peak
4	12665.000	35.41	15.41	50.82	74.00	-23.18	peak
5	13908.000	33.63	16.90	50.53	74.00	-23.47	peak
6	15580.000	40.46	16.65	57.11	74.00	-16.89	peak
7	15580.000	27.58	16.65	44.23	54.00	-9.77	AVG
8	17846.000	29.67	22.71	52.38	74.00	-21.62	peak

- Note:
1. Measurement = Reading Level + Correct Factor.
 2. If Peak Result complies with AV limit, AV Result is deemed to comply with AV limit.
 3. Peak: Peak detector.
 4. AVG: $VBW=1/Ton$, where: Ton is the transmitting duration.
 5. For the transmitting duration, please refer to clause 7.1.
 6. Filter losses were only considered in the spurious frequency bands and the authorized band was not corrected for High Pass Filter losses.
 7. Proper operation of the transmitter prior to adding the filter to the measurement chain.
 8. Since non-restricted band peak emissions are less than the average limit, they also comply with the -27dBm/MHz (68.2dBuV/m) limit.

HARMONICS AND SPURIOUS EMISSIONS (HIGH CHANNEL, HORIZONTAL)

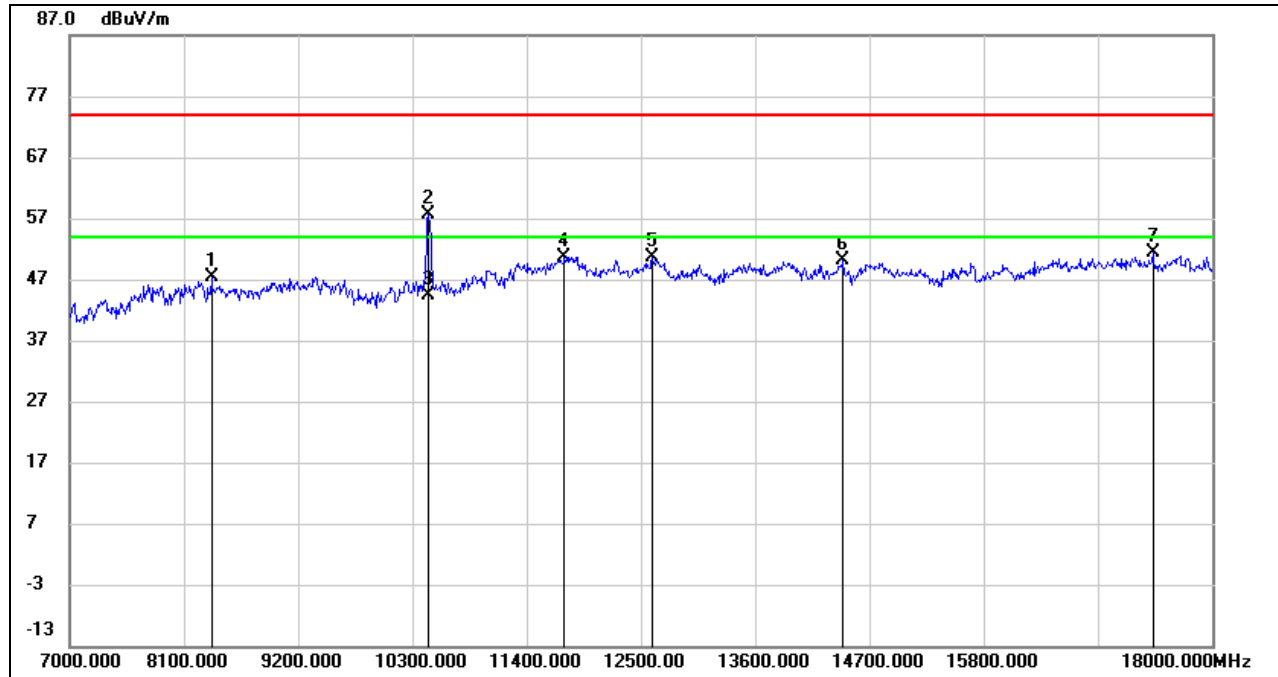

No.	Frequency (MHz)	Reading (dBuV)	Correct (dB/m)	Result (dBuV/m)	Limit (dBuV/m)	Margin (dB)	Remark
1	8364.000	38.72	8.73	47.45	74.00	-26.55	peak
2	10454.000	46.01	11.73	57.74	74.00	-16.26	peak
3	10454.000	32.56	11.73	44.29	54.00	-9.71	AVG
4	11763.000	35.30	15.41	50.71	74.00	-23.29	peak
5	12610.000	35.37	15.30	50.67	74.00	-23.33	peak
6	14447.000	33.39	16.77	50.16	74.00	-23.84	peak
7	17428.000	30.67	20.76	51.43	74.00	-22.57	peak

- Note: 1. Measurement = Reading Level + Correct Factor.
 2. If Peak Result complies with AV limit, AV Result is deemed to comply with AV limit.
 3. Peak: Peak detector.
 4. AVG: $VBW=1/Ton$, where: Ton is the transmitting duration.
 5. For the transmitting duration, please refer to clause 7.1.
 6. Filter losses were only considered in the spurious frequency bands and the authorized band was not corrected for High Pass Filter losses.
 7. Proper operation of the transmitter prior to adding the filter to the measurement chain.
 8. Since non-restricted band peak emissions are less than the average limit, they also comply with the -27dBm/MHz (68.2dBuV/m) limit.



HARMONICS AND SPURIOUS EMISSIONS (HIGH CHANNEL, VERTICAL)

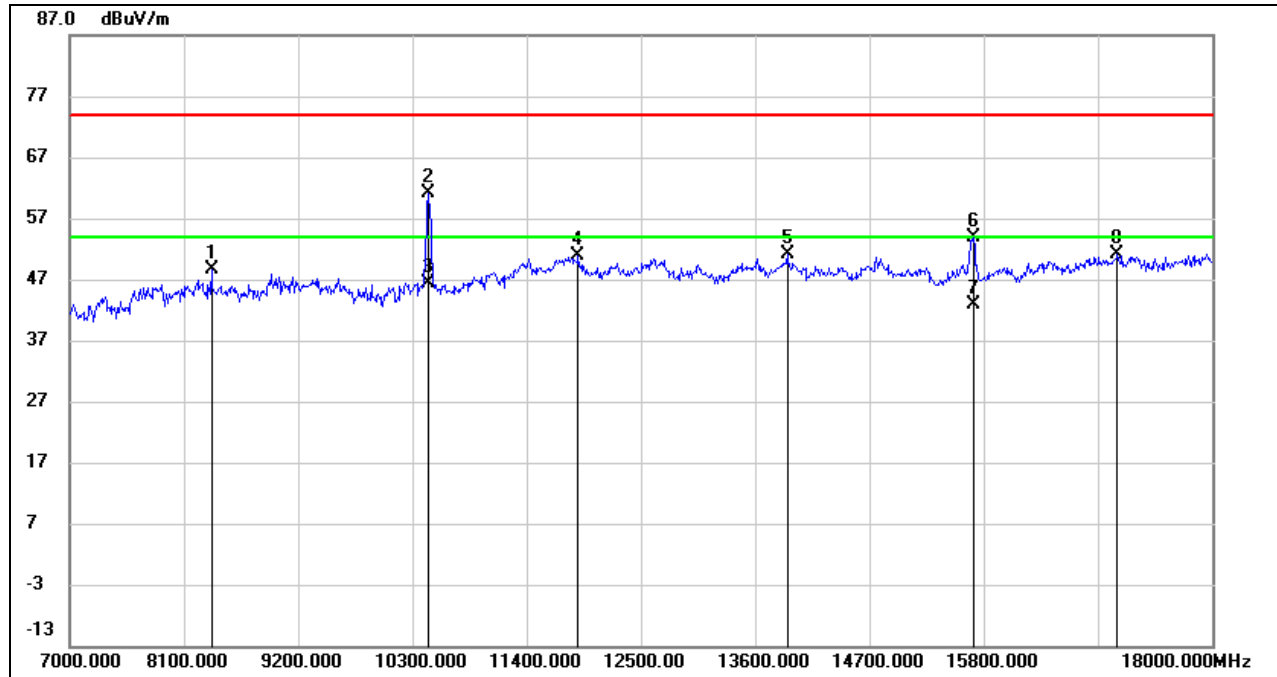

No.	Frequency (MHz)	Reading (dBuV)	Correct (dB/m)	Result (dBuV/m)	Limit (dBuV/m)	Margin (dB)	Remark
1	8364.000	39.81	8.73	48.54	74.00	-25.46	peak
2	10454.000	49.29	11.73	61.02	74.00	-12.98	peak
3	10454.000	34.64	11.73	46.37	54.00	-7.63	AVG
4	11895.000	35.29	15.48	50.77	74.00	-23.23	peak
5	13908.000	34.32	16.90	51.22	74.00	-22.78	peak
6	15701.000	37.23	16.76	53.99	74.00	-20.01	peak
7	15701.000	26.11	16.76	42.87	54.00	-11.13	AVG
8	17087.000	30.65	20.58	51.23	74.00	-22.77	peak

Note: 1. Measurement = Reading Level + Correct Factor.
 2. If Peak Result complies with AV limit, AV Result is deemed to comply with AV limit.
 3. Peak: Peak detector.
 4. AVG: $VBW=1/Ton$, where: Ton is the transmitting duration.
 5. For the transmitting duration, please refer to clause 7.1.
 6. Filter losses were only considered in the spurious frequency bands and the authorized band was not corrected for High Pass Filter losses.
 7. Proper operation of the transmitter prior to adding the filter to the measurement chain.
 8. Since non-restricted band peak emissions are less than the average limit, they also comply with the -27dBm/MHz (68.2dBuV/m) limit.



UNII-2A BAND

HARMONICS AND SPURIOUS EMISSIONS (LOW CHANNEL, HORIZONTAL)

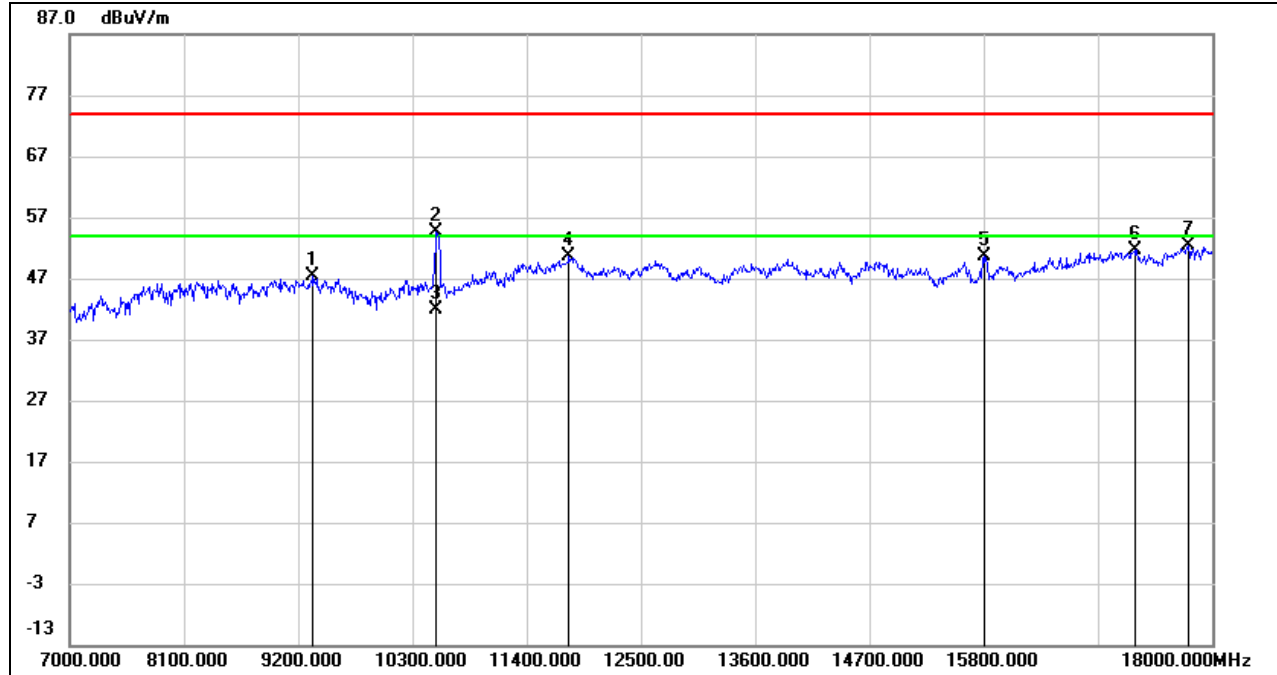

No.	Frequency (MHz)	Reading (dBuV)	Correct (dB/m)	Result (dBuV/m)	Limit (dBuV/m)	Margin (dB)	Remark
1	9343.000	37.41	10.02	47.43	74.00	-26.57	peak
2	10531.000	42.45	12.08	54.53	74.00	-19.47	peak
3	10531.000	29.84	12.08	41.92	54.00	-12.08	AVG
4	11807.000	35.00	15.61	50.61	74.00	-23.39	peak
5	15800.000	33.70	16.83	50.53	74.00	-23.47	peak
6	17252.000	30.66	20.97	51.63	74.00	-22.37	peak
7	17769.000	29.90	22.48	52.38	74.00	-21.62	peak

- Note: 1. Measurement = Reading Level + Correct Factor.
 2. If Peak Result complies with AV limit, AV Result is deemed to comply with AV limit.
 3. Peak: Peak detector.
 4. AVG: $VBW=1/Ton$, where: Ton is the transmitting duration.
 5. For the transmitting duration, please refer to clause 7.1.
 6. Filter losses were only considered in the spurious frequency bands and the authorized band was not corrected for High Pass Filter losses.
 7. Proper operation of the transmitter prior to adding the filter to the measurement chain.
 8. Since non-restricted band peak emissions are less than the average limit, they also comply with the -27dBm/MHz (68.2dBuV/m) limit.

HARMONICS AND SPURIOUS EMISSIONS (LOW CHANNEL, VERTICAL)

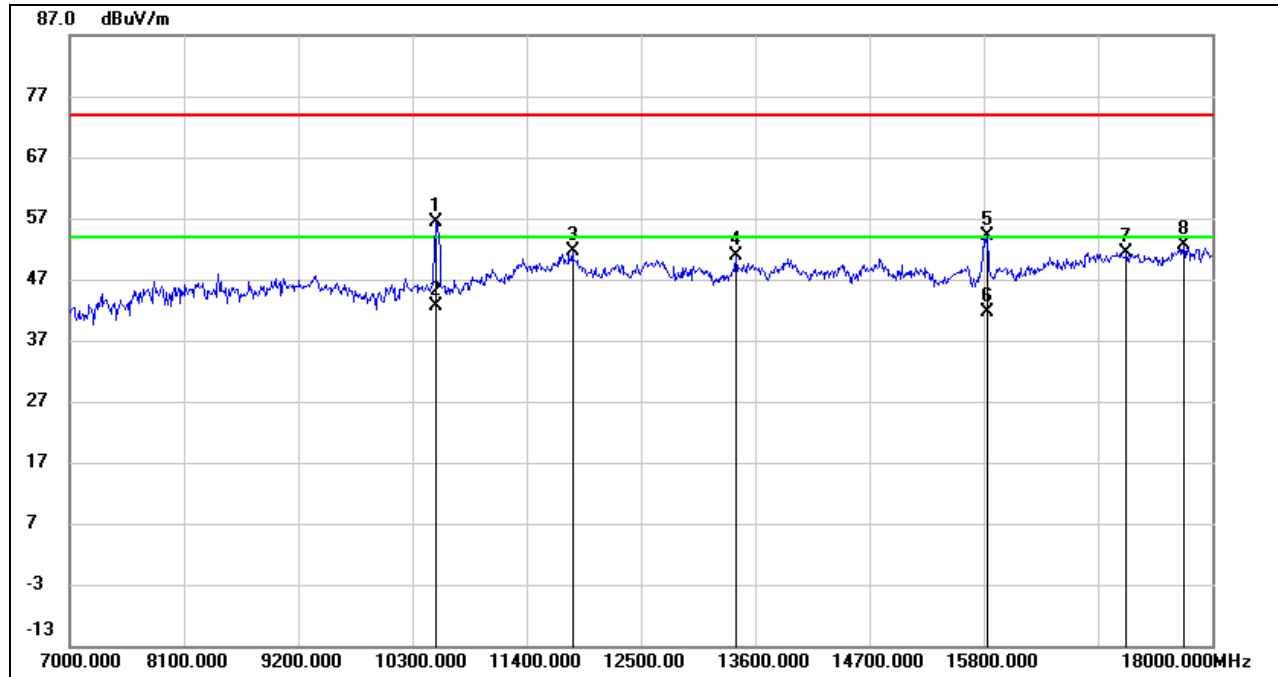

No.	Frequency (MHz)	Reading (dBuV)	Correct (dB/m)	Result (dBuV/m)	Limit (dBuV/m)	Margin (dB)	Remark
1	10531.000	44.19	12.08	56.27	74.00	-17.73	peak
2	10531.000	30.55	12.08	42.63	54.00	-11.37	AVG
3	11840.000	36.01	15.56	51.57	74.00	-22.43	peak
4	13413.000	34.65	16.33	50.98	74.00	-23.02	peak
5	15833.000	37.18	16.90	54.08	74.00	-19.92	peak
6	15833.000	24.75	16.90	41.65	54.00	-12.35	AVG
7	17175.000	30.54	20.94	51.48	74.00	-22.52	peak
8	17725.000	30.48	22.13	52.61	74.00	-21.39	peak

- Note: 1. Measurement = Reading Level + Correct Factor.
 2. If Peak Result complies with AV limit, AV Result is deemed to comply with AV limit.
 3. Peak: Peak detector.
 4. AVG: $VBW=1/Ton$, where: Ton is the transmitting duration.
 5. For the transmitting duration, please refer to clause 7.1.
 6. Filter losses were only considered in the spurious frequency bands and the authorized band was not corrected for High Pass Filter losses.
 7. Proper operation of the transmitter prior to adding the filter to the measurement chain.
 8. Since non-restricted band peak emissions are less than the average limit, they also comply with the -27dBm/MHz (68.2dBuV/m) limit.



HARMONICS AND SPURIOUS EMISSIONS (HIGH CHANNEL, HORIZONTAL)

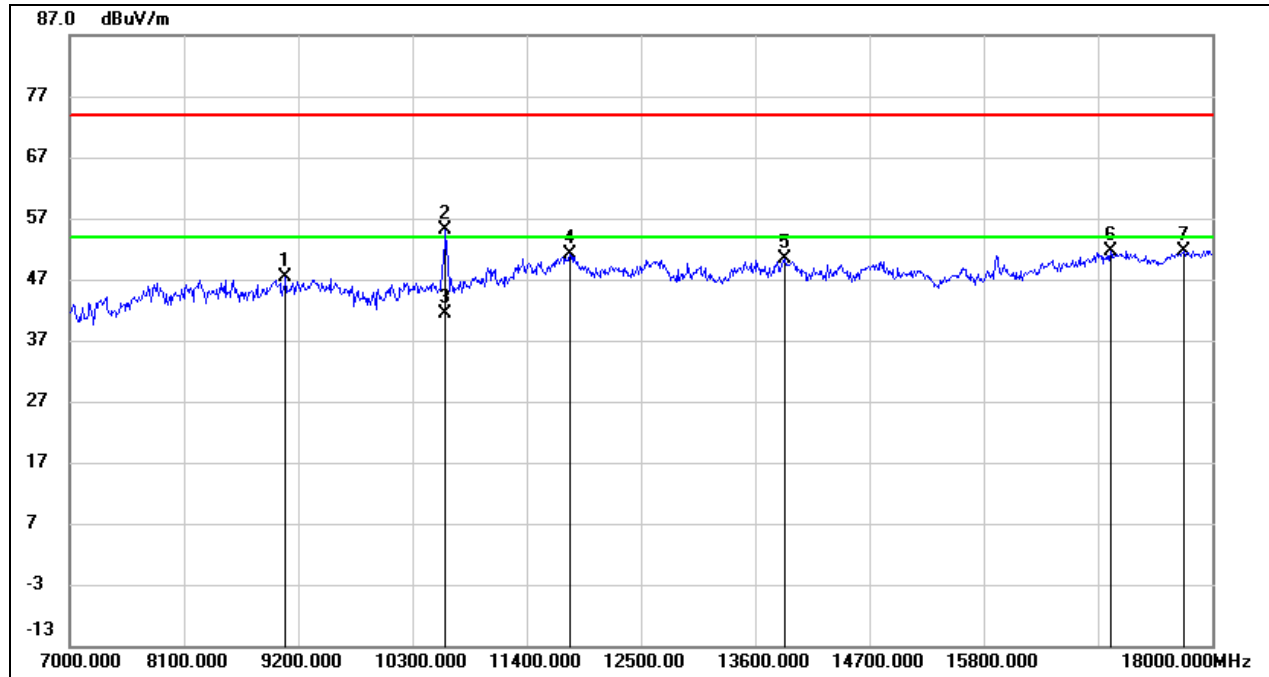

No.	Frequency (MHz)	Reading (dBuV)	Correct (dB/m)	Result (dBuV/m)	Limit (dBuV/m)	Margin (dB)	Remark
1	9079.000	37.22	10.10	47.32	74.00	-26.68	peak
2	10619.000	42.81	12.39	55.20	74.00	-18.80	peak
3	10619.000	28.90	12.39	41.29	54.00	-12.71	AVG
4	11818.000	35.47	15.58	51.05	74.00	-22.95	peak
5	13886.000	33.36	16.91	50.27	74.00	-23.73	peak
6	17021.000	31.25	20.32	51.57	74.00	-22.43	peak
7	17725.000	29.52	22.13	51.65	74.00	-22.35	peak

- Note: 1. Measurement = Reading Level + Correct Factor.
 2. If Peak Result complies with AV limit, AV Result is deemed to comply with AV limit.
 3. Peak: Peak detector.
 4. AVG: VBW=1/Ton, where: Ton is the transmitting duration.
 5. For the transmitting duration, please refer to clause 7.1.
 6. Filter losses were only considered in the spurious frequency bands and the authorized band was not corrected for High Pass Filter losses.
 7. Proper operation of the transmitter prior to adding the filter to the measurement chain.
 8. Since non-restricted band peak emissions are less than the average limit, they also comply with the -27dBm/MHz (68.2dBuV/m) limit.



HARMONICS AND SPURIOUS EMISSIONS (HIGH CHANNEL, VERTICAL)

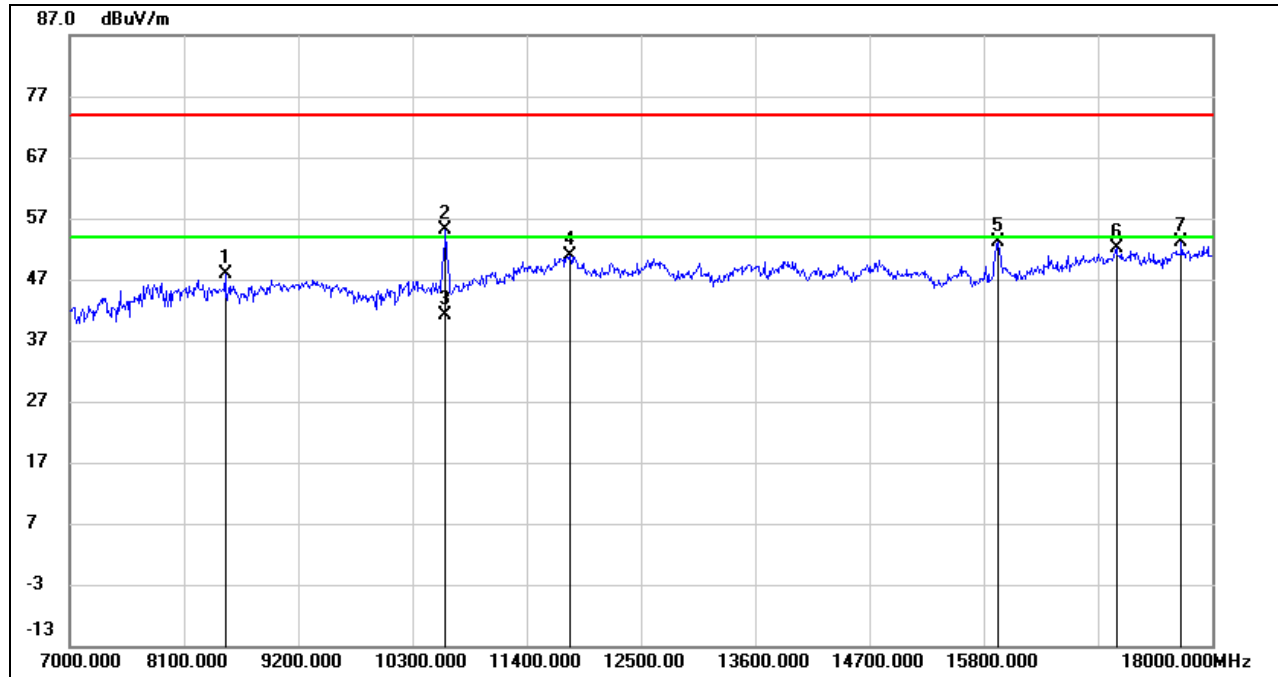

No.	Frequency (MHz)	Reading (dBuV)	Correct (dB/m)	Result (dBuV/m)	Limit (dBuV/m)	Margin (dB)	Remark
1	8496.000	39.38	8.53	47.91	74.00	-26.09	peak
2	10619.000	42.81	12.39	55.20	74.00	-18.80	peak
3	10619.000	28.77	12.39	41.16	54.00	-12.84	AVG
4	11818.000	35.24	15.58	50.82	74.00	-23.18	peak
5	15932.000	36.15	17.09	53.24	74.00	-20.76	peak
6	17076.000	31.47	20.54	52.01	74.00	-21.99	peak
7	17703.000	31.09	21.96	53.05	74.00	-20.95	peak

- Note: 1. Measurement = Reading Level + Correct Factor.
 2. If Peak Result complies with AV limit, AV Result is deemed to comply with AV limit.
 3. Peak: Peak detector.
 4. AVG: VBW=1/Ton, where: Ton is the transmitting duration.
 5. For the transmitting duration, please refer to clause 7.1.
 6. Filter losses were only considered in the spurious frequency bands and the authorized band was not corrected for High Pass Filter losses.
 7. Proper operation of the transmitter prior to adding the filter to the measurement chain.
 8. Since non-restricted band peak emissions are less than the average limit, they also comply with the -27dBm/MHz (68.2dBuV/m) limit.



UNII-2C BAND

HARMONICS AND SPURIOUS EMISSIONS (LOW CHANNEL, HORIZONTAL)

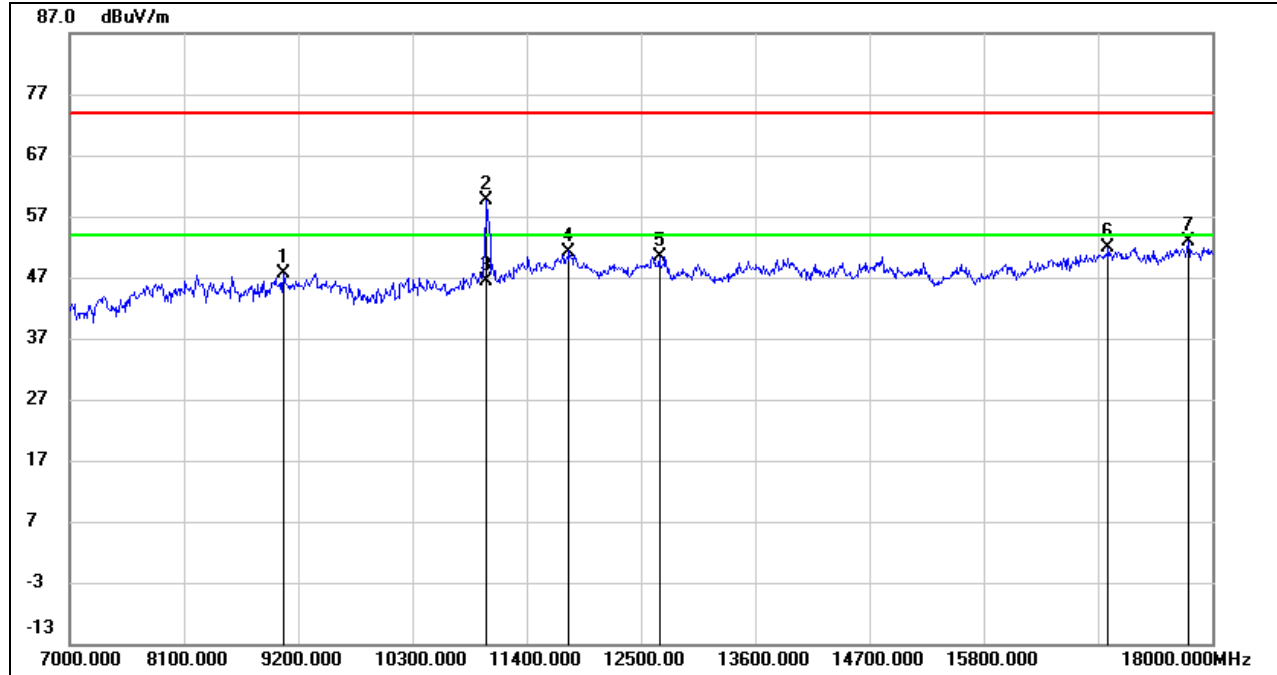

No.	Frequency (MHz)	Reading (dBuV)	Correct (dB/m)	Result (dBuV/m)	Limit (dBuV/m)	Margin (dB)	Remark
1	9057.000	37.39	10.26	47.65	74.00	-26.35	peak
2	11015.000	46.34	13.29	59.63	74.00	-14.37	peak
3	11015.000	33.05	13.29	46.34	54.00	-7.66	AVG
4	11807.000	35.64	15.61	51.25	74.00	-22.75	peak
5	12676.000	35.05	15.42	50.47	74.00	-23.53	peak
6	16999.000	31.57	20.23	51.80	74.00	-22.20	peak
7	17769.000	30.29	22.48	52.77	74.00	-21.23	peak

Note: 1. Measurement = Reading Level + Correct Factor.
 2. If Peak Result complies with AV limit, AV Result is deemed to comply with AV limit.
 3. Peak: Peak detector.
 4. AVG: VBW=1/Ton, where: Ton is the transmitting duration.
 5. For the transmitting duration, please refer to clause 7.1.
 6. Filter losses were only considered in the spurious frequency bands and the authorized band was not corrected for High Pass Filter losses.
 7. Proper operation of the transmitter prior to adding the filter to the measurement chain.
 8. Since non-restricted band peak emissions are less than the average limit, they also comply with the -27dBm/MHz (68.2dBuV/m) limit.



HARMONICS AND SPURIOUS EMISSIONS (LOW CHANNEL, VERTICAL)

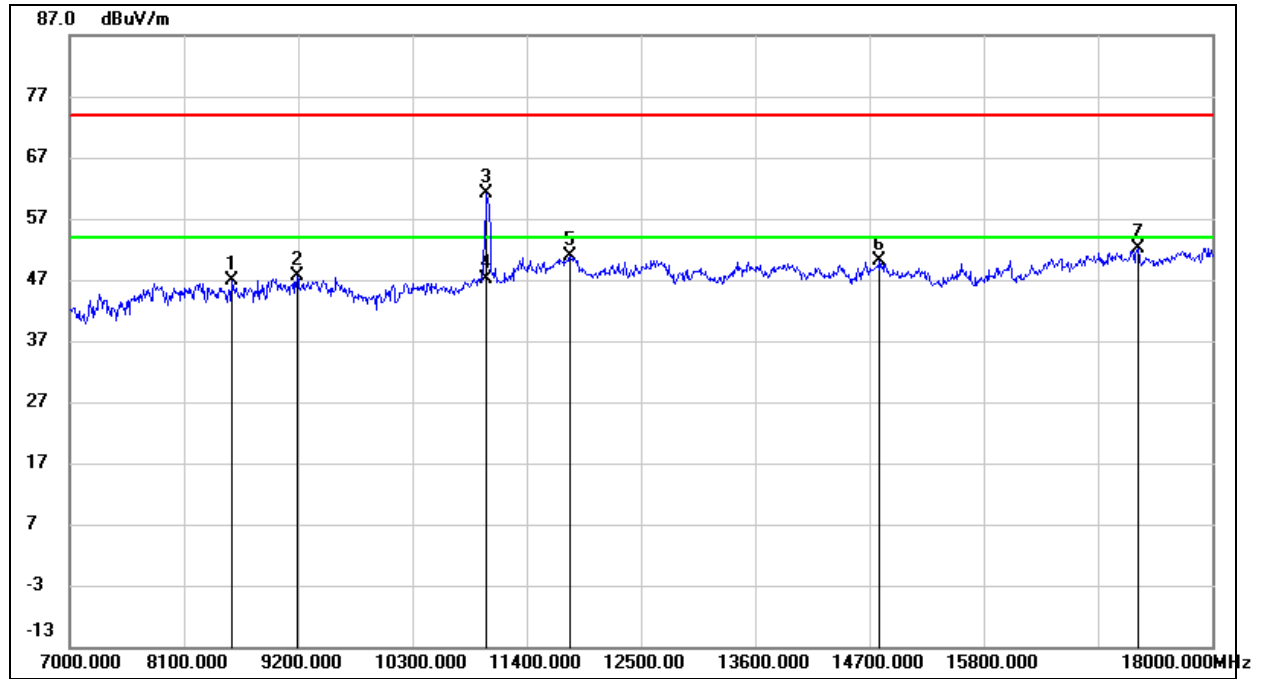

No.	Frequency (MHz)	Reading (dBuV)	Correct (dB/m)	Result (dBuV/m)	Limit (dBuV/m)	Margin (dB)	Remark
1	8562.000	38.35	8.55	46.90	74.00	-27.10	peak
2	9189.000	38.33	9.36	47.69	74.00	-26.31	peak
3	11015.000	47.92	13.29	61.21	74.00	-12.79	peak
4	11015.000	33.95	13.29	47.24	54.00	-6.76	AVG
5	11818.000	35.20	15.58	50.78	74.00	-23.22	peak
6	14799.000	33.39	16.80	50.19	74.00	-23.81	peak
7	17285.000	31.21	20.92	52.13	74.00	-21.87	peak

- Note:
1. Measurement = Reading Level + Correct Factor.
 2. If Peak Result complies with AV limit, AV Result is deemed to comply with AV limit.
 3. Peak: Peak detector.
 4. AVG: $VBW=1/Ton$, where: Ton is the transmitting duration.
 5. For the transmitting duration, please refer to clause 7.1.
 6. Filter losses were only considered in the spurious frequency bands and the authorized band was not corrected for High Pass Filter losses.
 7. Proper operation of the transmitter prior to adding the filter to the measurement chain.
 8. Since non-restricted band peak emissions are less than the average limit, they also comply with the -27dBm/MHz (68.2dBuV/m) limit.



HARMONICS AND SPURIOUS EMISSIONS (MID CHANNEL, HORIZONTAL)

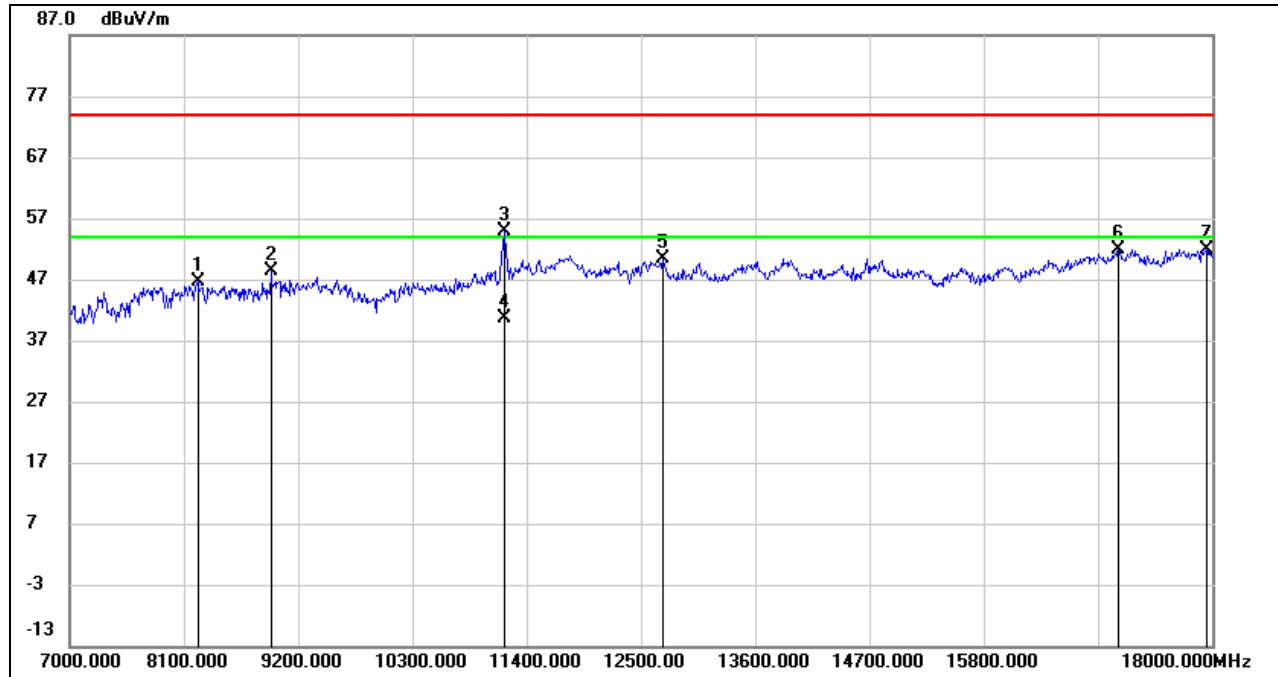

No.	Frequency (MHz)	Reading (dBuV)	Correct (dB/m)	Result (dBuV/m)	Limit (dBuV/m)	Margin (dB)	Remark
1	8232.000	37.47	9.23	46.70	74.00	-27.30	peak
2	8936.000	38.34	9.96	48.30	74.00	-25.70	peak
3	11180.000	41.24	13.60	54.84	74.00	-19.16	peak
4	11180.000	27.03	13.60	40.63	54.00	-13.37	AVG
5	12709.000	34.92	15.49	50.41	74.00	-23.59	peak
6	17098.000	31.31	20.63	51.94	74.00	-22.06	peak
7	17945.000	29.25	22.68	51.93	74.00	-22.07	peak

- Note:
1. Measurement = Reading Level + Correct Factor.
 2. If Peak Result complies with AV limit, AV Result is deemed to comply with AV limit.
 3. Peak: Peak detector.
 4. AVG: $VBW=1/Ton$, where: Ton is the transmitting duration.
 5. For the transmitting duration, please refer to clause 7.1.
 6. Filter losses were only considered in the spurious frequency bands and the authorized band was not corrected for High Pass Filter losses.
 7. Proper operation of the transmitter prior to adding the filter to the measurement chain.
 8. Since non-restricted band peak emissions are less than the average limit, they also comply with the -27dBm/MHz (68.2dBuV/m) limit.

HARMONICS AND SPURIOUS EMISSIONS (MID CHANNEL, VERTICAL)

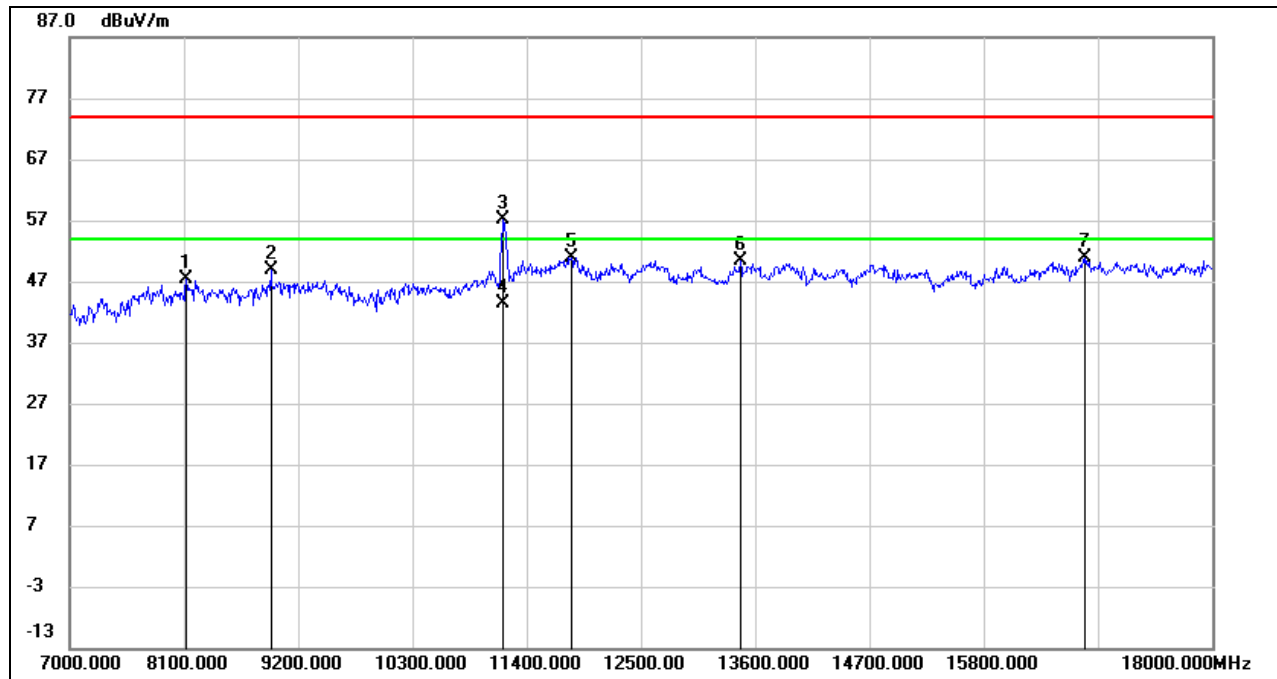

No.	Frequency (MHz)	Reading (dBuV)	Correct (dB/m)	Result (dBuV/m)	Limit (dBuV/m)	Margin (dB)	Remark
1	8122.000	38.70	8.70	47.40	74.00	-26.60	peak
2	8936.000	38.86	9.96	48.82	74.00	-25.18	peak
3	11169.000	43.65	13.59	57.24	74.00	-16.76	peak
4	11169.000	29.87	13.59	43.46	54.00	-10.54	AVG
5	11829.000	35.29	15.57	50.86	74.00	-23.14	peak
6	13457.000	33.95	16.37	50.32	74.00	-23.68	peak
7	16779.000	31.26	19.72	50.98	74.00	-23.02	peak

- Note:
1. Measurement = Reading Level + Correct Factor.
 2. If Peak Result complies with AV limit, AV Result is deemed to comply with AV limit.
 3. Peak: Peak detector.
 4. AVG: $VBW=1/Ton$, where: Ton is the transmitting duration.
 5. For the transmitting duration, please refer to clause 7.1.
 6. Filter losses were only considered in the spurious frequency bands and the authorized band was not corrected for High Pass Filter losses.
 7. Proper operation of the transmitter prior to adding the filter to the measurement chain.
 8. Since non-restricted band peak emissions are less than the average limit, they also comply with the -27dBm/MHz (68.2dBuV/m) limit.



HARMONICS AND SPURIOUS EMISSIONS (HIGH CHANNEL, HORIZONTAL)

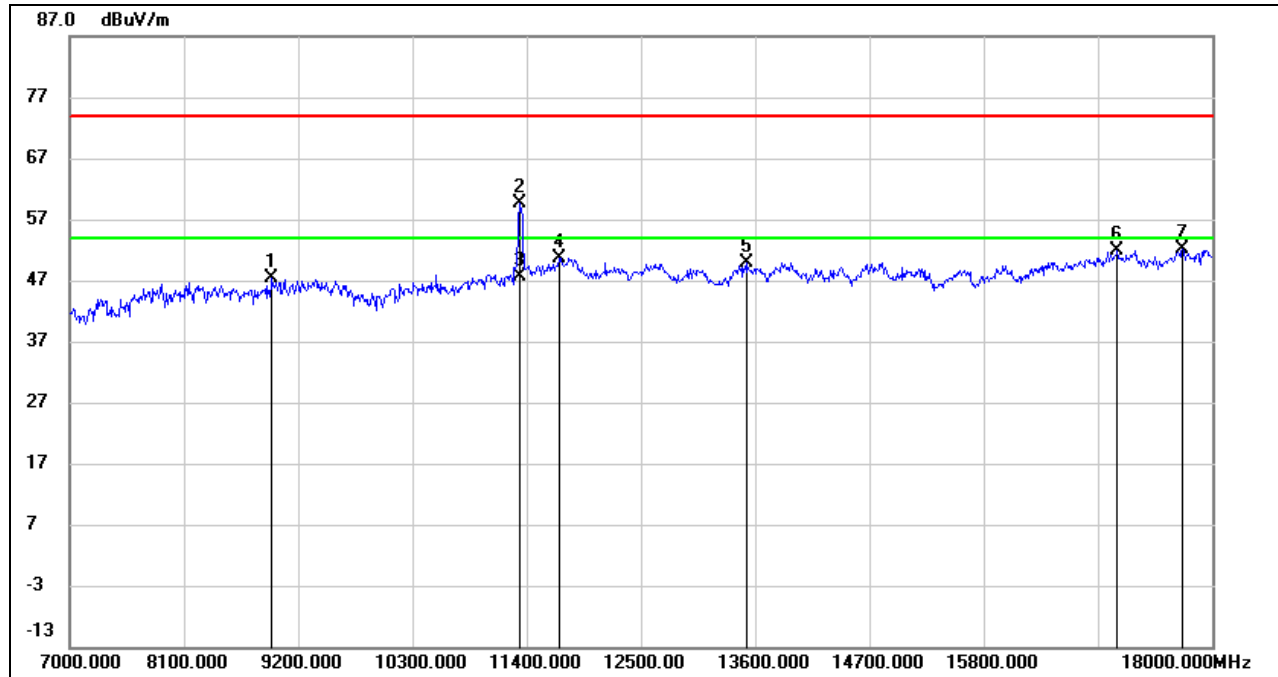

No.	Frequency (MHz)	Reading (dBuV)	Correct (dB/m)	Result (dBuV/m)	Limit (dBuV/m)	Margin (dB)	Remark
1	8947.000	37.33	10.07	47.40	74.00	-26.60	peak
2	11334.000	45.60	14.02	59.62	74.00	-14.38	peak
3	11334.000	33.51	14.02	47.53	54.00	-6.47	AVG
4	11708.000	35.60	15.11	50.71	74.00	-23.29	peak
5	13512.000	33.54	16.41	49.95	74.00	-24.05	peak
6	17087.000	31.31	20.58	51.89	74.00	-22.11	peak
7	17714.000	29.98	22.04	52.02	74.00	-21.98	peak

- Note: 1. Measurement = Reading Level + Correct Factor.
 2. If Peak Result complies with AV limit, AV Result is deemed to comply with AV limit.
 3. Peak: Peak detector.
 4. AVG: $VBW=1/Ton$, where: Ton is the transmitting duration.
 5. For the transmitting duration, please refer to clause 7.1.
 6. Filter losses were only considered in the spurious frequency bands and the authorized band was not corrected for High Pass Filter losses.
 7. Proper operation of the transmitter prior to adding the filter to the measurement chain.
 8. Since non-restricted band peak emissions are less than the average limit, they also comply with the -27dBm/MHz (68.2dBuV/m) limit.