



TEST REPORT

FCC PART 15 SUBPART C 15.247

**Test report
On Behalf of
XIAMENSHI C-CHIP TECHNOLOGY CO., LTD.
For
WIFI BLE Module
Model No.: C-8133U
FCC ID: 2AR7VC-8133U**

Prepared for : XIAMENSHI C-CHIP TECHNOLOGY CO., LTD.
1001C, 166 tapu east Road, Siming District, Xiamen, china

Prepared By : Shenzhen HUAKE Testing Technology Co., Ltd.
1-2/F, Building 19, Junfeng Industrial Park, Chongqing Road, Heping
Community, Fuhai Street, Bao'an District, Shenzhen, Guangdong, China

Date of Test: Jan. 10, 2018 to Jan. 16, 2018
Date of Report: Jan. 16, 2018
Report Number: HK1901170155E



TEST RESULT CERTIFICATION

Applicant's name XIAMENSHI C-CHIP TECHNOLOGY CO., LTD.
 Address 1001C, 166 tapu east Road, Siming District, Xiamen, china
Manufacturer's Name..... XIAMENSHI C-CHIP TECHNOLOGY CO., LTD.
 Address 1001C, 166 tapu east Road, Siming District, Xiamen, china
Factory's Name XIAMENSHI C-CHIP TECHNOLOGY CO., LTD.
 Address 1001C, 166 tapu east Road, Siming District, Xiamen, china

Product description

Trade Mark: C-CHIP
 Product name WIFI BLE Module
 Model and/or type reference .. C-8133U

Standards **47 CFR FCC Part 15 Subpart C 15.247**

This publication may be reproduced in whole or in part for non-commercial purposes as long as the Shenzhen HUAKE Testing Technology Co., Ltd. is acknowledged as copyright owner and source of the material. Shenzhen HUAKE Testing Technology Co., Ltd. takes no responsibility for and will not assume liability for damages resulting from the reader's interpretation of the reproduced material due to its placement and context.

Date of Test

Date (s) of performance of tests.....: Jan. 10, 2018 to Jan. 16, 2018
 Date of Issue.....: Jan. 16, 2018
 Test Result.....: **Pass**

Testing Engineer : Gary Qian
 (Gary Qian)

Technical Manager : Eden Hu
 (Eden Hu)

Authorized Signatory : Jason Zhou
 (Jason Zhou)



TABLE OF CONTENTS

1.SUMMARY4

1.1 TEST STANDARDS 4

1.2 TEST DESCRIPTION..... 4

1.3 TEST FACILITY 5

1.4 STATEMENT OF THE MEASUREMENT UNCERTAINTY 5

2.GENERAL INFORMATION6

2.1 ENVIRONMENTAL CONDITIONS..... 6

2.2 GENERAL DESCRIPTION OF EUT 6

2.3 DESCRIPTION OF TEST MODES AND TEST FREQUENCY 6

2.4 DESCRIPTION OF TEST SETUP 7

2.5 RELATED SUBMITTAL(S) / GRANT (S) 7

2.6 MODIFICATIONS 7

2.7 EQUIPMENT USED 8

3. PEAK OUTPUT POWER.....9

3.1. MEASUREMENT PROCEDURE 9

3.2. TEST SET-UP (BLOCK DIAGRAM OF CONFIGURATION) 9

3.3. LIMITS AND MEASUREMENT RESULT 10

4. 6 DB BANDWIDTH12

4.1. MEASUREMENT PROCEDURE 12

4.2. TEST SET-UP (BLOCK DIAGRAM OF CONFIGURATION) 12

4.3. LIMITS AND MEASUREMENT RESULTS 12

5. CONDUCTED SPURIOUS EMISSION.....14

5.1. MEASUREMENT PROCEDURE 14

5.2. TEST SET-UP (BLOCK DIAGRAM OF CONFIGURATION) 14

5.3. MEASUREMENT EQUIPMENT USED 14

5.4. LIMITS AND MEASUREMENT RESULT 14

6. MAXIMUM CONDUCTED OUTPUT POWER SPECTRAL DENSITY.....19

6.1 MEASUREMENT PROCEDURE 19

6.2 TEST SET-UP (BLOCK DIAGRAM OF CONFIGURATION) 19

6.3 MEASUREMENT EQUIPMENT USED 19

6.4 LIMITS AND MEASUREMENT RESULT 19

7. RADIATED EMISSION21

7.1. MEASUREMENT PROCEDURE 21

7.2. TEST SETUP 22

7.3. LIMITS AND MEASUREMENT RESULT 23

7.4. TEST RESULT 23

8. LINE CONDUCTED EMISSION TEST33

8.1. LIMITS OF LINE CONDUCTED EMISSION TEST 33

8.2. BLOCK DIAGRAM OF LINE CONDUCTED EMISSION TEST 33

8.3. PRELIMINARY PROCEDURE OF LINE CONDUCTED EMISSION TEST 34

8.4. FINAL PROCEDURE OF LINE CONDUCTED EMISSION TEST 34

8.5. TEST RESULT OF LINE CONDUCTED EMISSION TEST 35

APPENDIX A: PHOTOGRAPHS OF TEST SETUP37

APPENDIX B: PHOTOGRAPHS OF EUT.....39



1.SUMMARY

1.1 TEST STANDARDS

The tests were performed according to following standards:

[FCC Rules Part 15.247](#): Frequency Hopping, Direct Spread Spectrum and Hybrid Systems that are in operation within the bands of 902-928 MHz, 2400-2483.5 MHz, and 5725-5850 MHz

[ANSI C63.10:2013](#) : American National Standard for Testing Unlicensed Wireless Devices

1.2 TEST DESCRIPTION

	DESCRIPTION OF TEST	RESULT
FCC PART 15.247	Peak Output Power	Compliant
	6 dB Bandwidth	Compliant
	Conducted Spurious Emission and Band Edges	Compliant
	Maximum Conducted Output Power Density	Compliant
	Radiated Emission	Compliant
	Line Conduction Emission	Compliant



1.3 TEST FACILITY

1.3.1 ADDRESS OF THE TEST LABORATORY

Shenzhen HUAK Testing Technology Co., Ltd.

Addr.:1F, B2 Building, Junfeng Zhongcheng Zhizao Innovation Park, Heping Community, Fuhai Street, Bao'an District, Shenzhen, China

There is one 3m semi-anechoic chamber and two line conducted labs for final test. The Test Sites meet the requirements in documents ANSI C63.4 and CISPR 32/EN 55032 requirements.

1.3.2 LABORATORY ACCREDITATION

The test facility is recognized, certified, or accredited by the following organizations:

IC Registration No.: 21210

The 3m alternate test site of Shenzhen HUAK Testing Technology Co., Ltd. EMC Laboratory has been registered by Certification and Engineer Bureau of Industry Canada for the performance of with Registration No.: 21210 on May 24, 2016.

FCC Registration No.: CN1229

Test Firm Registration Number : 616276

1.4 STATEMENT OF THE MEASUREMENT UNCERTAINTY

The data and results referenced in this document are true and accurate. The reader is cautioned that there may be errors within the calibration limits of the equipment and facilities. The measurement uncertainty was calculated for all measurements listed in this test report acc. to CISPR 16 - 4 "Specification for radio disturbance and immunity measuring apparatus and methods – Part 4: Uncertainty in EMC Measurements" and is documented in the Shenzhen HUAK Testing Technology Co., Ltd. quality system acc. to DIN EN ISO/IEC 17025. Furthermore, component and process variability of devices similar to that tested may result in additional deviation. The manufacturer has the sole responsibility of continued compliance of the device.

Hereafter the best measurement capability for HUAK laboratory is reported:

Test	Measurement Uncertainty	Notes
Transmitter power conducted	±0.57 dB	(1)
Transmitter power Radiated	±2.20 dB	(1)
Conducted spurious emission 9KHz-40 GHz	±2.20 dB	(1)
Occupied Bandwidth	±0.01ppm	(1)
Radiated Emission 30~1000MHz	±4.10dB	(1)
Radiated Emission Above 1GHz	±4.32dB	(1)
Conducted Disturbance0.15~30MHz	±3.20dB	(1)

- (1) This uncertainty represents an expanded uncertainty expressed at approximately the 95% confidence level using a coverage factor of k=2.



2. GENERAL INFORMATION

2.1 ENVIRONMENTAL CONDITIONS

During the measurement the environmental conditions were within the listed ranges:

Normal Temperature:	25°C
Relative Humidity:	55 %
Air Pressure:	101 kPa

2.2 GENERAL DESCRIPTION OF EUT

Product Name:	WIFI BLE Module
Model/Type reference:	C-8133U
Power supply:	DC 3.3V
Version:	V4.2
Modulation:	GFSK(BLE)
Operation frequency:	2402MHz~2480MHz
Channel number:	40
Channel separation:	2MHz
Antenna type:	PCB Antenna
Antenna gain:	0dBi
Hardware Version:	V1.1
Software Version:	V1.1

Note: For more details, refer to the user's manual of the EUT.

2.3 DESCRIPTION OF TEST MODES AND TEST FREQUENCY

Frequency Band	Channel Number	Frequency
2400~2483.5MHZ	0	2402MHZ
	1	2404MHZ
	:	:
	38	2478MHZ
	39	2480MHZ

NO.	TEST MODE DESCRIPTION
1	Low channel TX
2	Middle channel TX
3	High channel TX

Note:

1. The EUT has been set to operate continuously on the lowest, middle and highest operation frequency Individually, and the eut is operating at its maximum duty cycle>or equal 98%
2. For Radiated Emission, 3axis were chosen for testing for each applicable mode.



2.4 DESCRIPTION OF TEST SETUP

Configure :

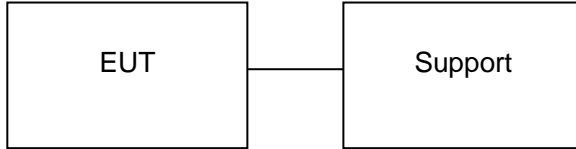

Item	Equipment	Model No.	Specification	Remark
1	Dell PC	Ins 14-7460-D1525S	N/A	Provided by test lab
2	PC adapter	YH-195-462	DC19.5V/4.62A	Provided by test lab
3	Control board	BK_Download_UART_V1.0	N/A	Provided by test lab

2.5 RELATED SUBMITTAL(S) / GRANT (S)

This submittal(s) (test report) is intended to comply with Section 15.247 of the FCC Part 15, Subpart C Rules.

2.6 MODIFICATIONS

No modifications were implemented to meet testing criteria.

**2.7 EQUIPMENT USED**

Item	Equipment	Manufacturer	Model No.	Serial No.	Last Cal.	Cal. Interval
1.	L.I.S.N. Artificial Mains Network	R&S	ENV216	HKE-002	Dec. 27, 2018	1 Year
2.	Receiver	R&S	ESCI 7	HKE-010	Dec. 27, 2018	1 Year
3.	RF automatic control unit	Tonscend	JS0806-2	HKE-060	Dec. 27, 2018	1 Year
4.	Horn Antenna	Schwarzbeck	BBHA 9170	HKE-090	Dec. 27, 2018	1 Year
5.	Spectrum analyzer	Agilent	N9020A	HKE-048	Dec. 27, 2018	1 Year
6.	Preamplifier	Schwarzbeck	BBV 9743	HKE-006	Dec. 27, 2018	1 Year
7.	EMI Test Receiver	Rohde & Schwarz	ESCI 7	HKE-010	Dec. 27, 2018	1 Year
8.	Bilog Broadband Antenna	Schwarzbeck	VULB9163	HKE-012	Dec. 27, 2018	1 Year
9.	Loop Antenna	Schwarzbeck	FMZB 1519 B	HKE-014	Dec. 27, 2018	1 Year
10.	Horn Antenna	Schwarzbeck	9120D	HKE-013	Dec. 27, 2018	1 Year
11.	Pre-amplifier	EMCI	EMC051845 SE	HKE-015	Dec. 27, 2018	1 Year
12.	Pre-amplifier	Agilent	83051A	HKE-016	Dec. 27, 2018	1 Year
13.	EMI Test Software EZ-EMC	Tonscend	JS1120-B Version	HKE-083	Dec. 27, 2018	N/A
14.	Shielded room	Shiel Hong	4*3*3	HKE-039	Dec. 27, 2018	3 Year

The calibration interval was one year



3. PEAK OUTPUT POWER

3.1. MEASUREMENT PROCEDURE

For peak power test:

1. Connect EUT RF output port to the Spectrum Analyzer through an RF attenuator
2. $RBW \geq DTS$ bandwidth
3. $VBW \geq 3 * RBW$.
4. $SPAN \geq VBW$.
5. Sweep: Auto.
6. Detector function: Peak.
7. Trace: Max hold.

Allow trace to stabilize. Use the marker-to-peak function to set the marker to the peak of the emission. The indicated level is the peak output power, after any corrections for external attenuators and cables.

3.2. TEST SET-UP (BLOCK DIAGRAM OF CONFIGURATION) PEAK POWER TEST SETUP

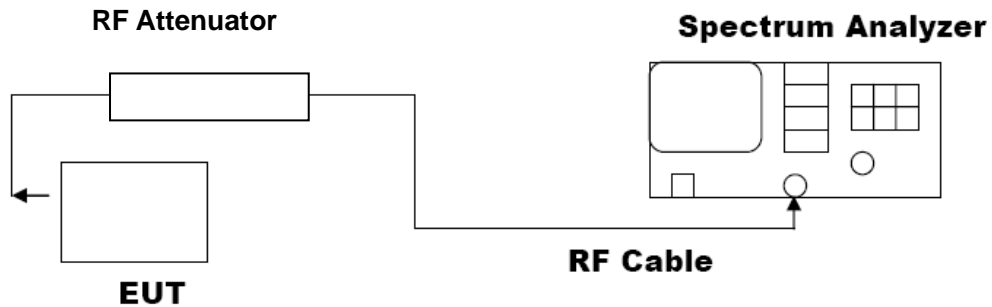



3.3. LIMITS AND MEASUREMENT RESULT

PEAK OUTPUT POWER MEASUREMENT RESULT FOR GFSK MODULATION			
Frequency (GHz)	Peak Power (dBm)	Applicable Limits (dBm)	Pass or Fail
2.402	5.326	30	Pass
2.440	5.753	30	Pass
2.480	5.928	30	Pass

CH0

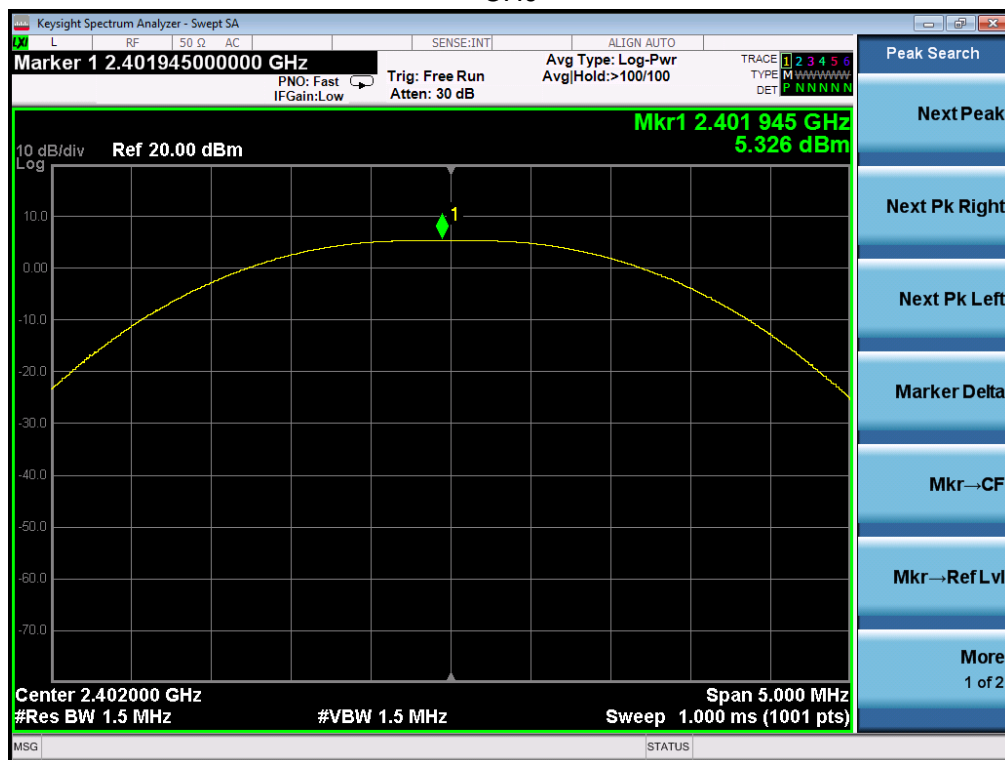



CH19

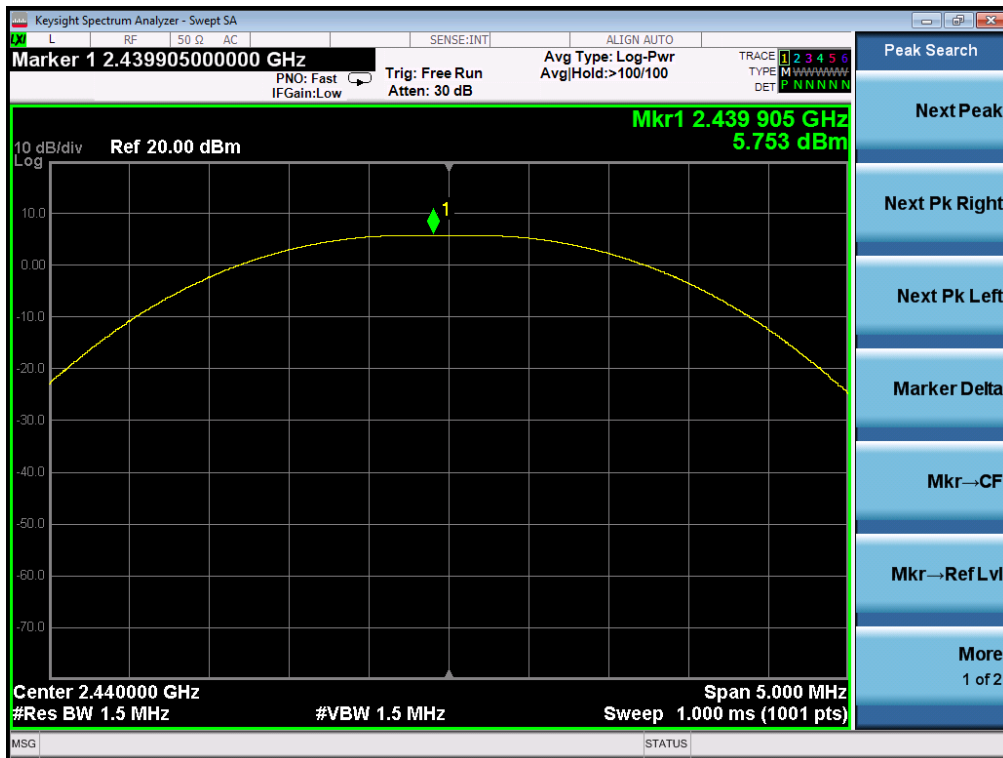

CH39

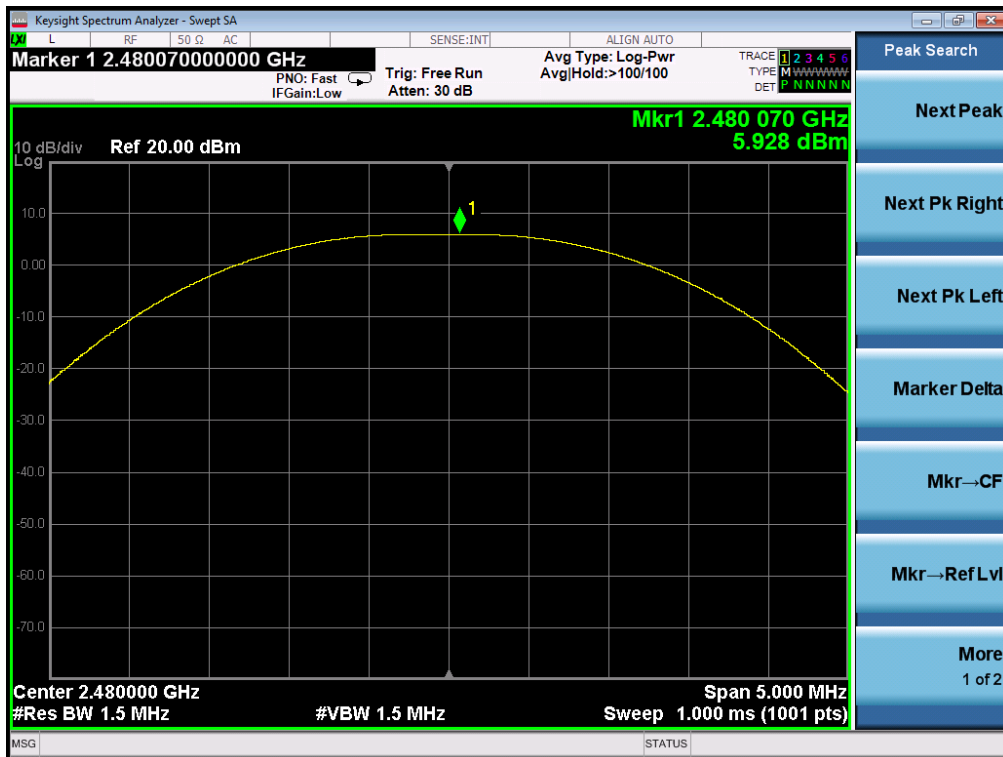



4. 6 DB BANDWIDTH

4.1. MEASUREMENT PROCEDURE

1. Connect EUT RF output port to the Spectrum Analyzer through an RF attenuator
2. Set the EUT Work on the top, the middle and the bottom operation frequency individually.
3. Set SPA Centre Frequency = Operation Frequency, RBW= 100 KHz, VBW \geq 3 \times RBW.
4. Set SPA Trace 1 Max hold, then View.

Note: The EUT was tested according to ANSI C63.10 for compliance to FCC PART 15.247 requirements.

4.2. TEST SET-UP (BLOCK DIAGRAM OF CONFIGURATION)

The same as described in section 7.2.

4.3. LIMITS AND MEASUREMENT RESULTS

LIMITS AND MEASUREMENT RESULT			
Applicable Limits	Applicable Limits		
	Test Data (kHz)		Criteria
>500KHZ	Low Channel	682.5	PASS
	Middle Channel	677.9	PASS
	High Channel	680.1	PASS

TEST PLOT OF BANDWIDTH FOR LOW CHANNEL

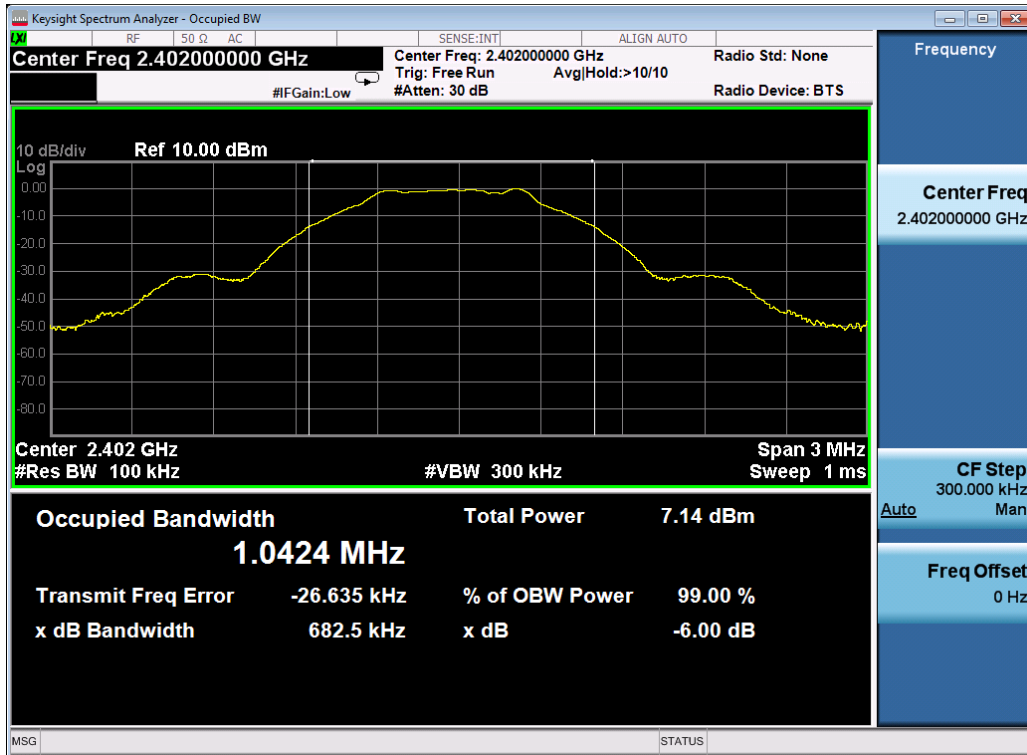



TEST PLOT OF BANDWIDTH FOR MIDDLE CHANNEL

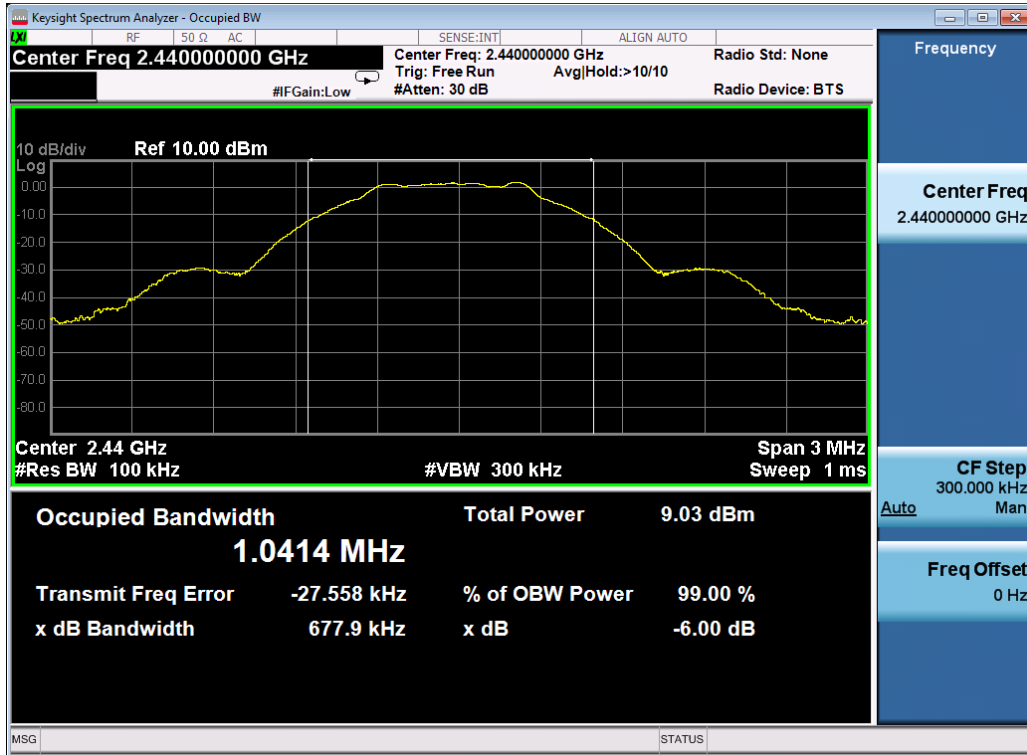

TEST PLOT OF BANDWIDTH FOR HIGH CHANNEL

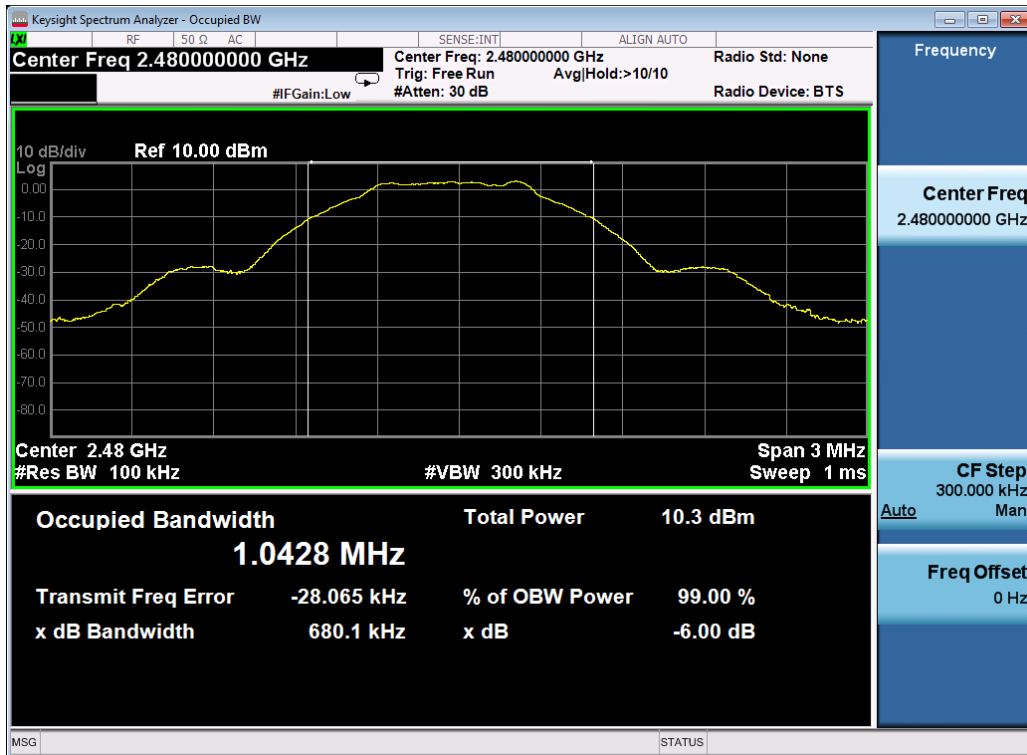



5. CONDUCTED SPURIOUS EMISSION

5.1. MEASUREMENT PROCEDURE

1. Connect EUT RF output port to the Spectrum Analyzer through an RF attenuator
2. Set the EUT Work on the top, the middle and the bottom operation frequency individually.
3. Set SPA Trace 1 Max hold, then View.

Note: The EUT was tested according to ANSI C63.10 for compliance to FCC PART 15.247 requirements.

5.2. TEST SET-UP (BLOCK DIAGRAM OF CONFIGURATION)

The same as described in section 7.2.

5.3. MEASUREMENT EQUIPMENT USED

The same as described in section 6.

5.4. LIMITS AND MEASUREMENT RESULT

LIMITS AND MEASUREMENT RESULT		
Applicable Limits	Measurement Result	
	Test Data	Criteria
In any 100 KHz Bandwidth Outside the frequency band in which the spread spectrum intentional radiator is operating, the radio frequency power that is produce by the intentional radiator shall be at least 20 dB below that in 100KHz bandwidth within the band that contains the highest level of the desired power.	At least -20dBc than the reference level	PASS PASS



TEST RESULT FOR ENTIRE FREQUENCY RANGE GFSK MODULATION IN LOW CHANNEL

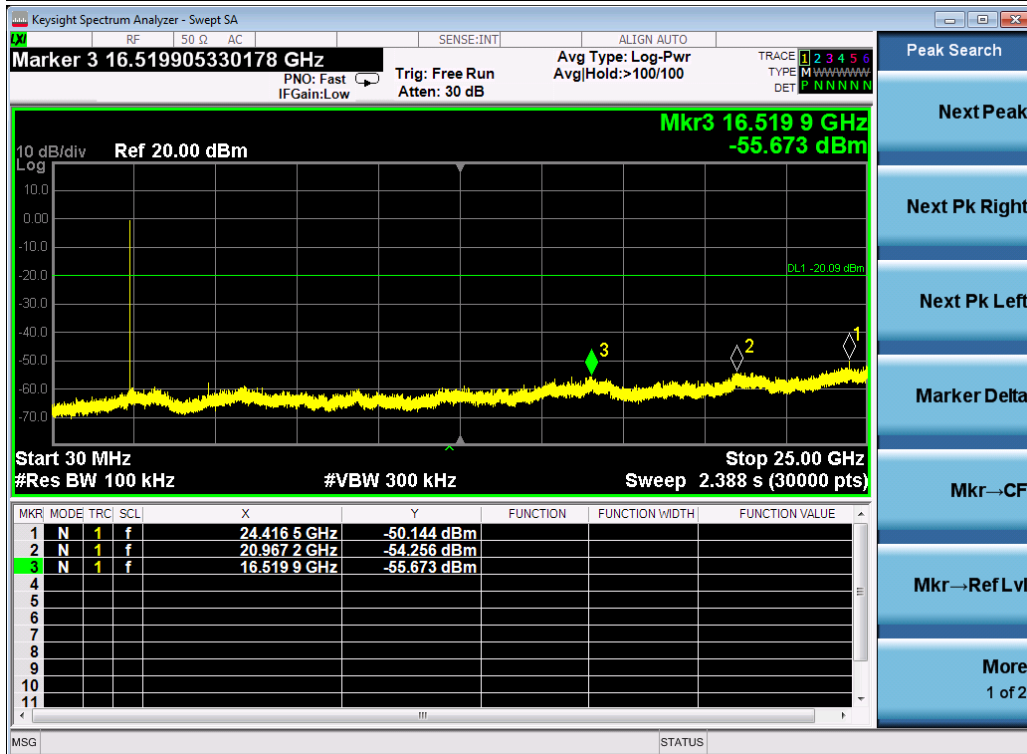
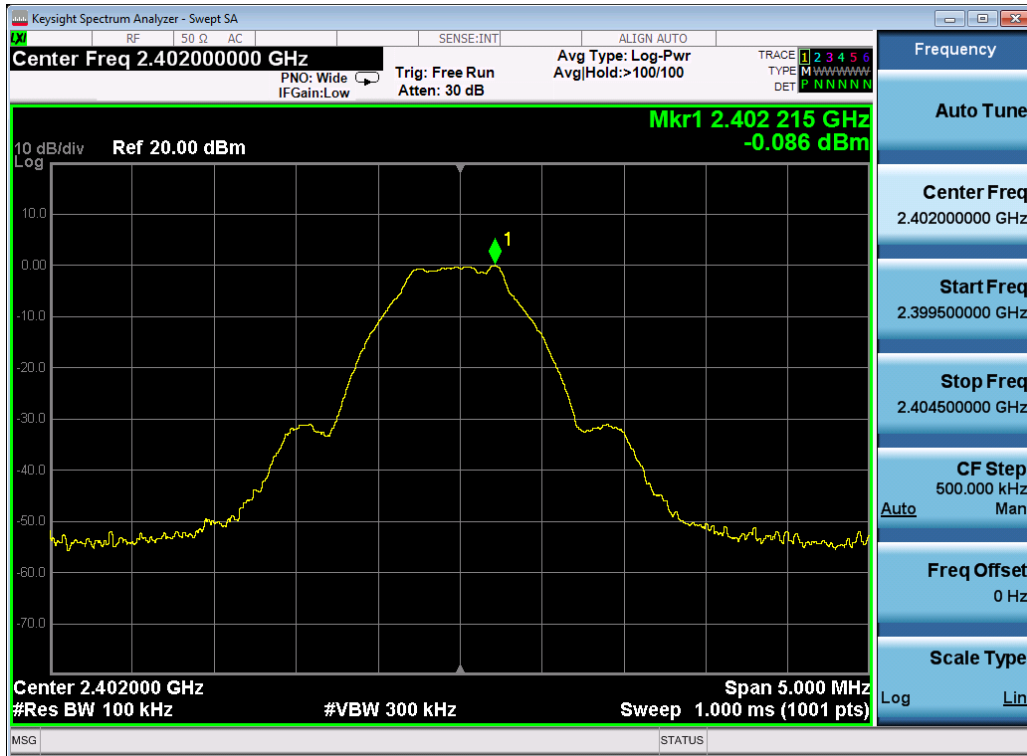



GFSK MODULATION IN HIGH CHANNEL

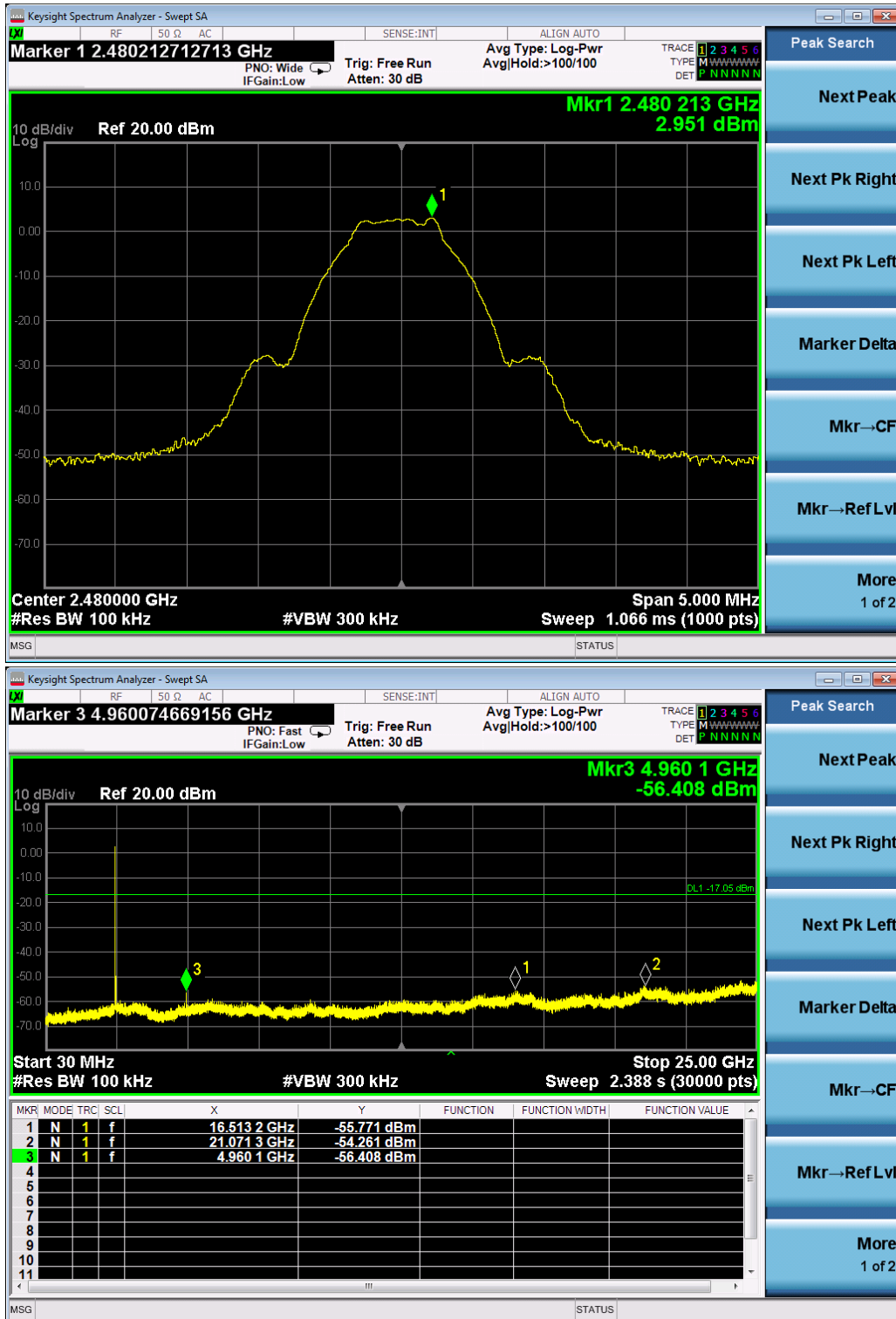

Note: The peak emissions without marker on the above plots are fundamental wave and need not to compare with the limit.



6. MAXIMUM CONDUCTED OUTPUT POWER SPECTRAL DENSITY

6.1 MEASUREMENT PROCEDURE

- (1). Connect EUT RF output port to the Spectrum Analyzer through an RF attenuator
- (2). Set the EUT Work on the top, the middle and the bottom operation frequency individually.
- (3). Set SPA Trace 1 Max hold, then View.

Note: The method of PKPSD in the KDB 558074 item 10.2 was used in this testing.

6.2 TEST SET-UP (BLOCK DIAGRAM OF CONFIGURATION)

Refer To Section 7.2.

6.3 MEASUREMENT EQUIPMENT USED

Refer To Section 6.

6.4 LIMITS AND MEASUREMENT RESULT

Channel No.	PSD (dBm/3kHz)	Limit (dBm/3kHz)	Result
Low Channel	-20.064	8	Pass
Middle Channel	-18.296	8	Pass
High Channel	-17.003	8	Pass

TEST PLOT OF SPECTRAL DENSITY FOR LOW CHANNEL

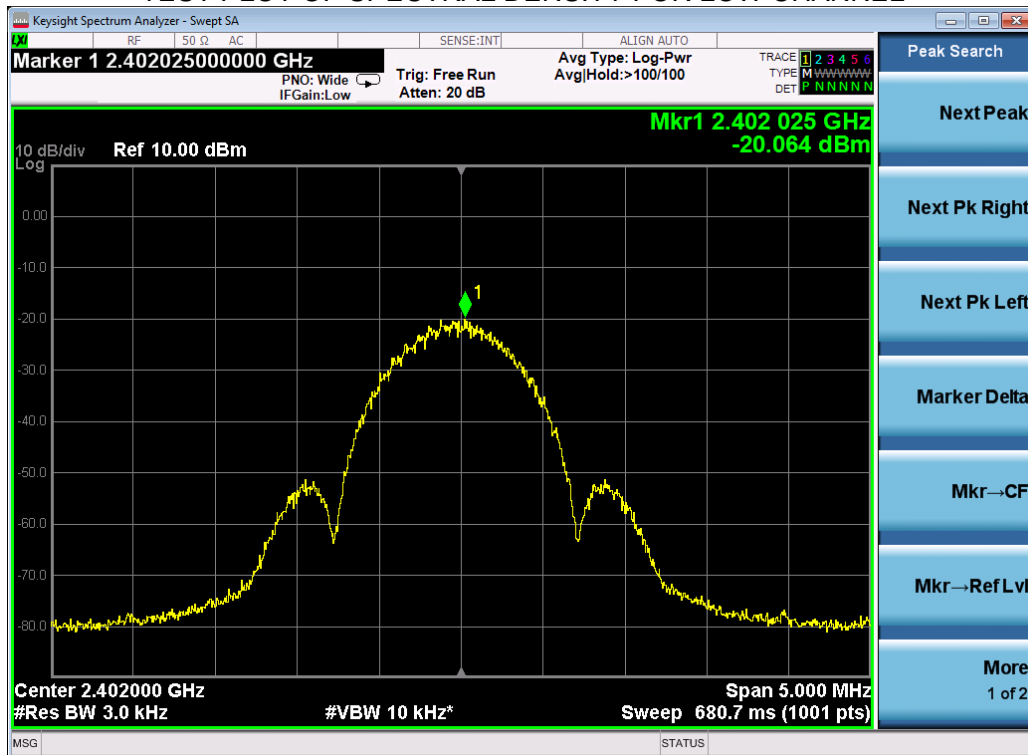



7. RADIATED EMISSION

7.1. MEASUREMENT PROCEDURE

1. The EUT was placed on the top of the turntable 0.8 or 1.5 meter above ground. The phase center of the receiving antenna mounted on the top of a height-variable antenna tower was placed 3 meters far away from the turntable.
2. Power on the EUT and all the supporting units. The turntable was rotated by 360 degrees to determine the position of the highest radiation.
3. The height of the broadband receiving antenna was varied between one meter and four meters above ground to find the maximum emissions field strength of both horizontal and vertical polarization.
4. For each suspected emissions, the antenna tower was scan (from 1 M to 4 M) and then the turntable was rotated (from 0 degree to 360 degrees) to find the maximum reading.
5. Set the test-receiver system to Peak or CISPR quasi-peak Detect Function with specified bandwidth under Maximum Hold Mode.
6. For emissions above 1GHz, use 1MHz RBW and 3MHz VBW for peak reading. Place the measurement antenna away from each area of the EUT determined to be a source of emissions at the specified measurement distance, while keeping the measurement antenna aimed at the source of emissions at each frequency of significant emissions, with polarization oriented for maximum response. The measurement antenna may have to be higher or lower than the EUT, depending on the radiation pattern of the emission and staying aimed at the emission source for receiving the maximum signal. The final measurement antenna elevation shall be that which maximizes the emissions. The measurement antenna elevation for maximum emissions shall be restricted to a range of heights of from 1 m to 4 m above the ground or reference ground plane.
7. When the radiated emissions limits are expressed in terms of the average value of the emissions, and pulsed operation is employed, the measurement field strength shall be determined by averaging over one complete pulse train, including blanking intervals, as long as the pulse train does not exceed 0.1 seconds. As an alternative (provided the transmitter operates for longer than 0.1 seconds) or in cases where the pulse train exceeds 0.1 seconds, the measured field strength shall be determined from the average absolute voltage during a 0.1 second interval during which the field strength is at its maximum values.
8. If the emissions level of the EUT in peak mode was 3 dB lower than the average limit specified, then testing will be stopped and peak values of EUT will be reported, otherwise, the emissions which do not have 3 dB margin will be repeated one by one using the quasi-peak method for below 1GHz.
9. For testing above 1GHz, the emissions level of the EUT in peak mode was lower than average limit (that means the emissions level in peak mode also complies with the limit in average mode), then testing will be stopped and peak values of EUT will be reported, otherwise, the emissions will be measured in average mode again and reported.
10. In case the emission is lower than 30MHz, loop antenna has to be used for measurement and the recorded data should be QP measured by receiver. High - Low scan is not required in this case.

7.2. TEST SETUP

Radiated Emission Test-Setup Frequency Below 30MHz

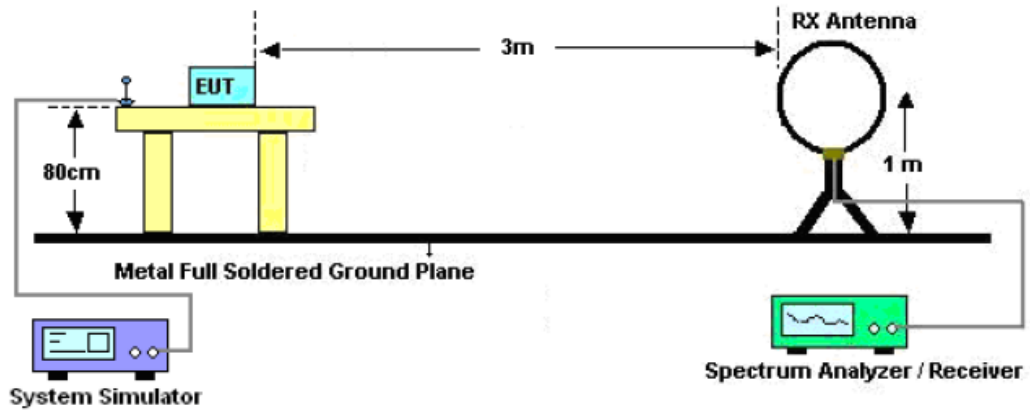

RADIATED EMISSION TEST SETUP 30MHz-1000MHz

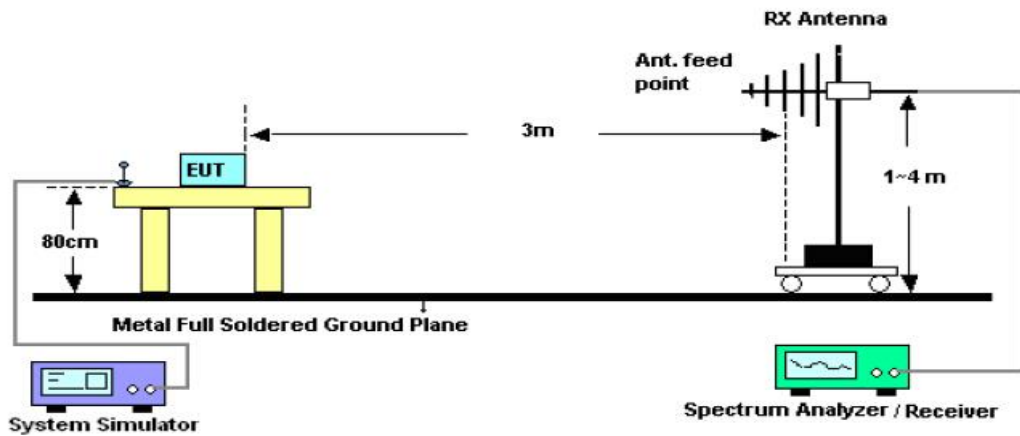

RADIATED EMISSION TEST SETUP ABOVE 1000MHz

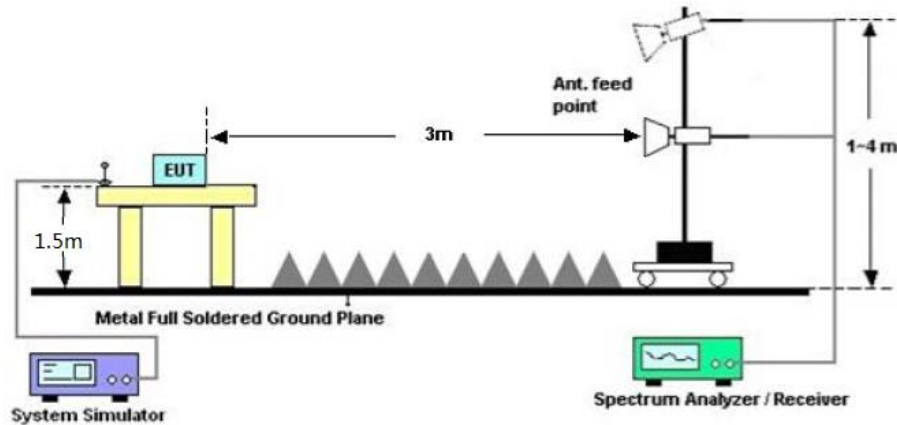



7.3. LIMITS AND MEASUREMENT RESULT

15.209 Limit in the below table has to be followed

Frequencies (MHz)	Field Strength (micorvolts/meter)	Measurement Distance (meters)
0.009~0.490	2400/F(KHz)	300
0.490~1.705	24000/F(KHz)	30
1.705~30.0	30	30
30~88	100	3
88~216	150	3
216~960	200	3
Above 960	500	3

Note: All modes were tested For restricted band radiated emission, the test records reported below are the worst result compared to other modes.

7.4. TEST RESULT

RADIATED EMISSION BELOW 30MHZ

No emission found between lowest internal used/generated frequencies to 30MHz.



RADIATED EMISSION BELOW 1GHZ

EUT	WIFI BLE Module	Model Name	C-8133U
Temperature	25° C	Relative Humidity	55.4%
Pressure	960hPa	Test Voltage	Normal Voltage
Test Mode	Mode 1	Antenna	Horizontal

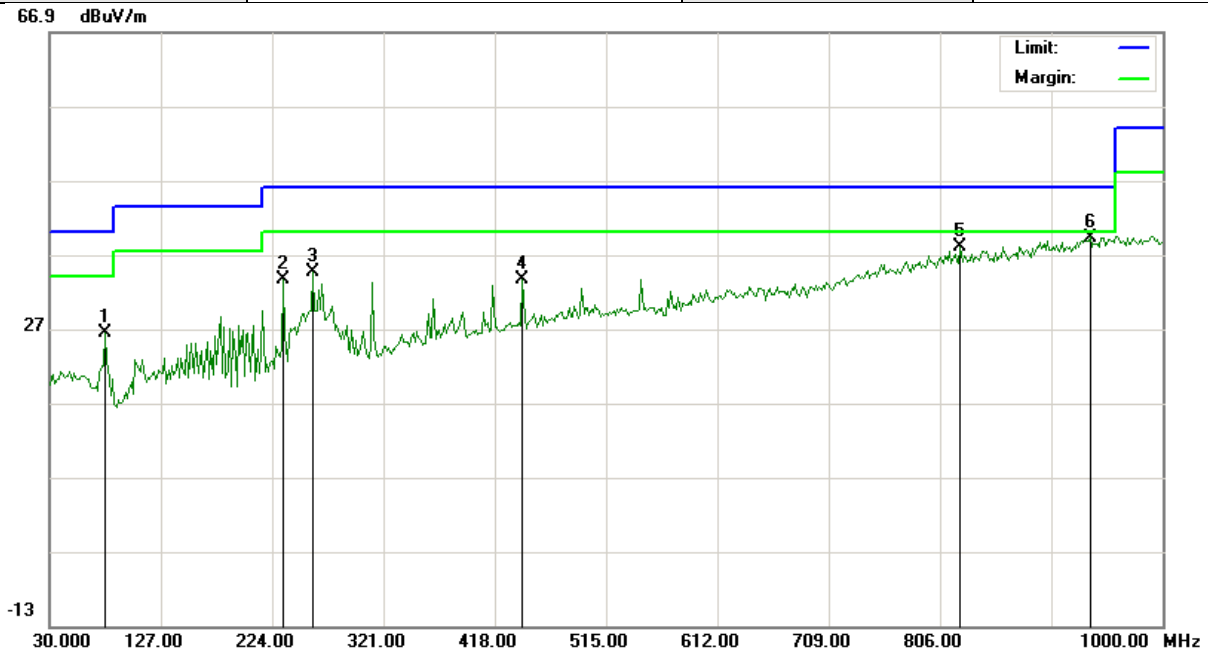

No.	Mk	Freq.	Reading	Factor	Measurement	Limit	Over	Detector	Antenna Height	Table Degree	Comment
		MHz	dBuV	dB/m	dBuV/m	dBuV/m	dB		cm	degree	
1		78.5000	10.27	16.14	26.41	40.00	-13.59	peak			
2		233.7000	13.79	19.83	33.62	46.00	-12.38	peak			
3		259.5667	14.48	20.19	34.67	46.00	-11.33	peak			
4		442.2500	7.27	26.29	33.56	46.00	-12.44	peak			
5		823.7833	3.53	34.56	38.09	46.00	-7.91	peak			
6	*	936.9500	2.93	36.37	39.30	46.00	-6.70	peak			

RESULT: PASS



EUT	WIFI BLE Module	Model Name	C-8133U
Temperature	25° C	Relative Humidity	55.4%
Pressure	960hPa	Test Voltage	Normal Voltage
Test Mode	Mode 1	Antenna	Vertical

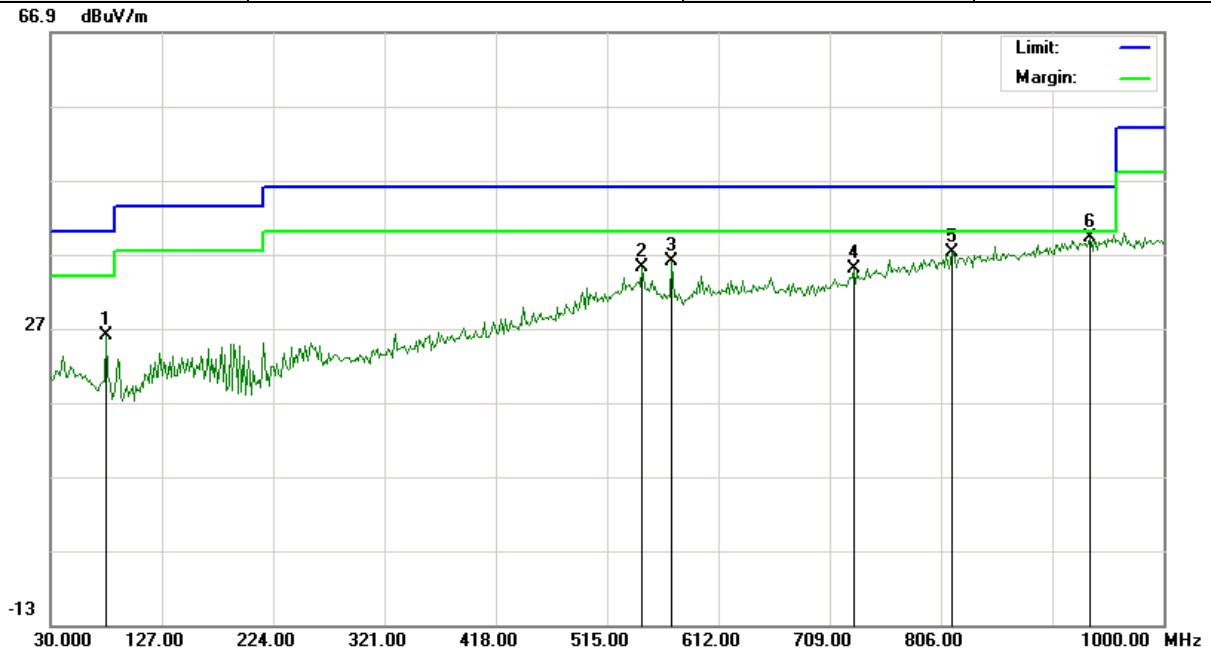

No.	Mk	Freq.	Reading	Factor	Measurement	Limit	Over	Detector	Antenna Height	Table Degree	Comment
		MHz	dBuV	dB/m	dBuV/m	dBuV/m	dB		cm	degree	
1		78.5000	9.92	16.14	26.06	40.00	-13.94	peak			
2		545.7167	6.73	28.56	35.29	46.00	-10.71	peak			
3		571.5833	6.89	29.16	36.05	46.00	-9.95	peak			
4		730.0167	2.77	32.21	34.98	46.00	-11.02	peak			
5		815.7000	2.88	34.41	37.29	46.00	-8.71	peak			
6	*	935.3333	2.79	36.35	39.14	46.00	-6.86	peak			

RESULT: PASS

Note:

1. Factor=Antenna Factor + Cable loss, Margin=Measurement-Limit.
2. All test modes had been tested. The mode 1 is the worst case and recorded in the report.

**RADIATED EMISSION ABOVE 1GHZ**

EUT	WIFI BLE Module	Model Name	C-8133U
Temperature	25° C	Relative Humidity	55.4%
Pressure	960hPa	Test Voltage	Normal Voltage
Test Mode	Mode 1	Antenna	Horizontal

Frequency (MHz)	Meter Reading (dB μ V)	Factor (dB)	Emission Level (dB μ V/m)	Limits (dB μ V/m)	Margin (dB)	Value Type
4804.011	45.63	7.12	52.75	74	-21.25	peak
4804.011	40.24	7.12	47.36	54	-6.64	AVG
7206.022	43.16	9.84	53	74	-21	peak
7206.022	37.38	9.84	47.22	54	-6.78	AVG

Remark:

Factor = Antenna Factor + Cable Loss – Pre-amplifier.

EUT	WIFI BLE Module	Model Name	C-8133U
Temperature	25° C	Relative Humidity	55.4%
Pressure	960hPa	Test Voltage	Normal Voltage
Test Mode	Mode 1	Antenna	Vertical

Frequency (MHz)	Meter Reading (dB μ V)	Factor (dB)	Emission Level (dB μ V/m)	Limits (dB μ V/m)	Margin (dB)	Value Type
4804.011	44.52	7.12	51.64	74	-22.36	peak
4804.011	40.69	7.12	47.81	54	-6.19	AVG
7206.022	42.41	9.84	52.25	74	-21.75	peak
7206.022	38.12	9.84	47.96	54	-6.04	AVG

Remark:

Factor = Antenna Factor + Cable Loss – Pre-amplifier.



EUT	WIFI BLE Module	Model Name	C-8133U
Temperature	25° C	Relative Humidity	55.4%
Pressure	960hPa	Test Voltage	Normal Voltage
Test Mode	Mode 2	Antenna	Horizontal

Frequency (MHz)	Meter Reading (dB μ V)	Factor (dB)	Emission Level (dB μ V/m)	Limits (dB μ V/m)	Margin (dB)	Value Type
4880.005	45.13	7.12	52.25	74	-21.75	peak
4880.005	41.56	7.12	48.68	54	-5.32	AVG
7320.140	41.49	9.84	51.33	74	-22.67	peak
7320.140	47.08	9.84	56.92	54	2.92	AVG

Remark:

Factor = Antenna Factor + Cable Loss – Pre-amplifier.

EUT	WIFI BLE Module	Model Name	C-8133U
Temperature	25° C	Relative Humidity	55.4%
Pressure	960hPa	Test Voltage	Normal Voltage
Test Mode	Mode 2	Antenna	Vertical

Frequency (MHz)	Meter Reading (dB μ V)	Factor (dB)	Emission Level (dB μ V/m)	Limits (dB μ V/m)	Margin (dB)	Value Type
4880.050	45.96	7.12	53.08	74	-20.92	peak
4880.050	43.15	7.12	50.27	54	-3.73	AVG
7320.080	44.57	9.84	54.41	74	-19.59	peak
7320.080	39.84	9.84	49.68	54	-4.32	AVG

Remark:

Factor = Antenna Factor + Cable Loss – Pre-amplifier.



EUT	WIFI BLE Module	Model Name	C-8133U
Temperature	25° C	Relative Humidity	55.4%
Pressure	960hPa	Test Voltage	Normal Voltage
Test Mode	Mode 3	Antenna	Horizontal

Frequency (MHz)	Meter Reading (dB μ V)	Factor (dB)	Emission Level (dB μ V/m)	Limits (dB μ V/m)	Margin (dB)	Value Type
4960.012	45.26	7.12	52.38	74	-21.62	peak
4960.012	41.35	7.12	48.47	54	-5.53	AVG
7440.027	42.96	9.84	52.8	74	-21.2	peak
7440.027	38.01	9.84	47.85	54	-6.15	AVG
Remark:						
Factor = Antenna Factor + Cable Loss – Pre-amplifier.						

EUT	WIFI BLE Module	Model Name	C-8133U
Temperature	25° C	Relative Humidity	55.4%
Pressure	960hPa	Test Voltage	Normal Voltage
Test Mode	Mode 3	Antenna	Vertical

Frequency (MHz)	Meter Reading (dB μ V)	Factor (dB)	Emission Level (dB μ V/m)	Limits (dB μ V/m)	Margin (dB)	Value Type
4960.013	44.49	7.12	51.61	74	-22.39	peak
4960.013	40.31	7.12	47.43	54	-6.57	AVG
7440.027	42.66	9.84	52.5	74	-21.5	peak
7440.027	38.89	9.84	48.73	54	-5.27	AVG
Remark:						
Factor = Antenna Factor + Cable Loss – Pre-amplifier.						

RESULT: PASS**Note:**

Other emissions from 1G to 25 GHz are considered as ambient noise. No recording in the test report.

Factor = Antenna Factor + Cable loss - Amplifier gain, Over=Measure-Limit.

The "Factor" value can be calculated automatically by software of measurement system.



TEST RESULT FOR RESTRICTED BANDS REQUIREMENTS

EUT	WIFI BLE Module	Model Name	C-8133U
Temperature	25° C	Relative Humidity	55.4%
Pressure	960hPa	Test Voltage	Normal Voltage
Test Mode	Mode 1	Antenna	Horizontal

PK

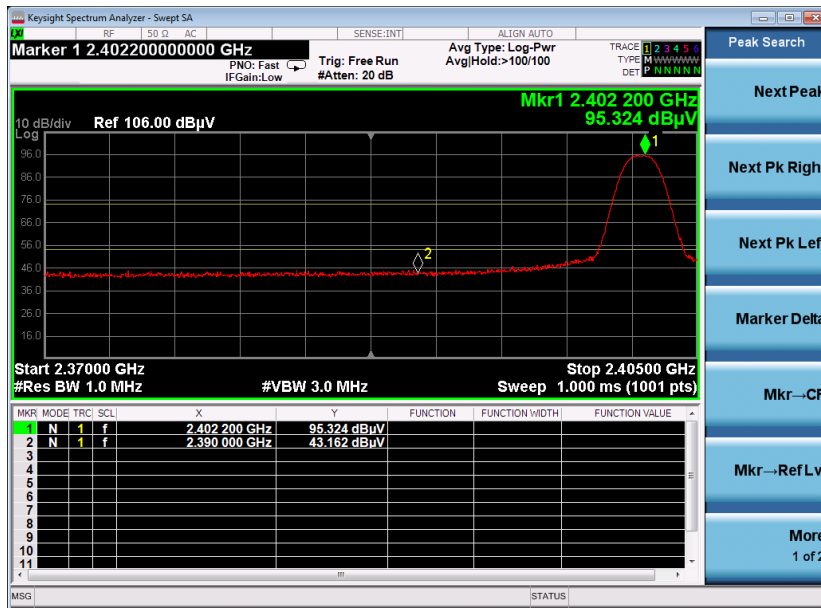

AV



RESULT: PASS



EUT	WIFI BLE Module	Model Name	C-8133U
Temperature	25° C	Relative Humidity	55.4%
Pressure	960hPa	Test Voltage	Normal Voltage
Test Mode	Mode 1	Antenna	Vertical

PK

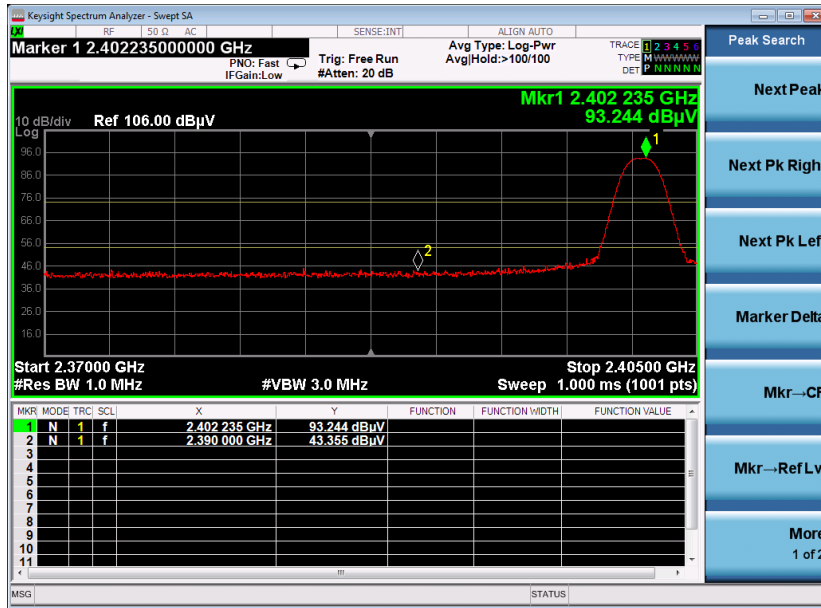

AV

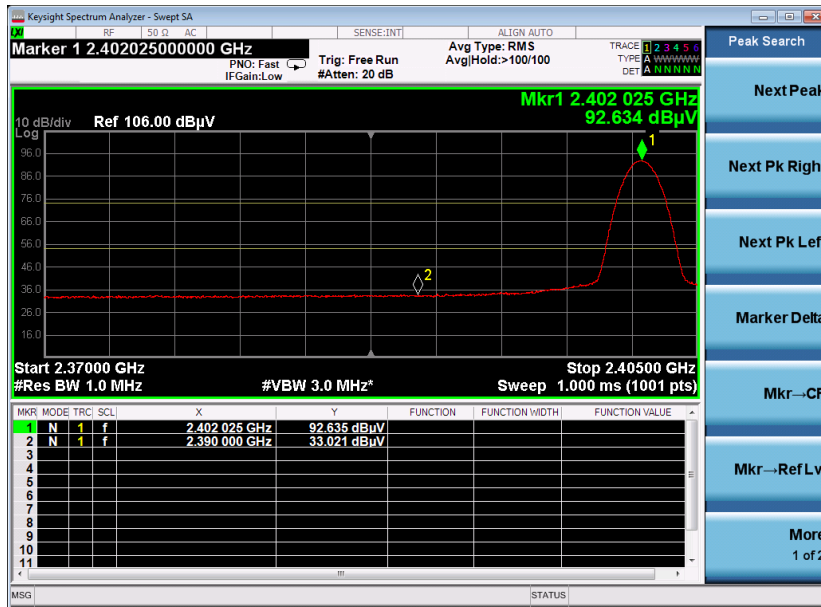

RESULT: PASS



EUT	WIFI BLE Module	Model Name	C-8133U
Temperature	25° C	Relative Humidity	55.4%
Pressure	960hPa	Test Voltage	Normal Voltage
Test Mode	Mode 3	Antenna	Horizontal

PK



AV

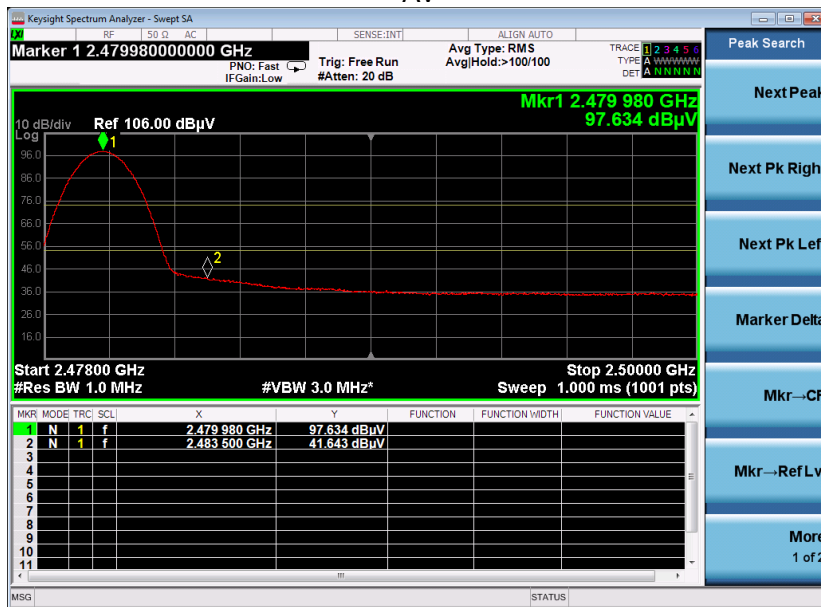

RESULT: PASS



EUT	WIFI BLE Module	Model Name	C-8133U
Temperature	25° C	Relative Humidity	55.4%
Pressure	960hPa	Test Voltage	Normal Voltage
Test Mode	Mode 3	Antenna	Vertical

PK

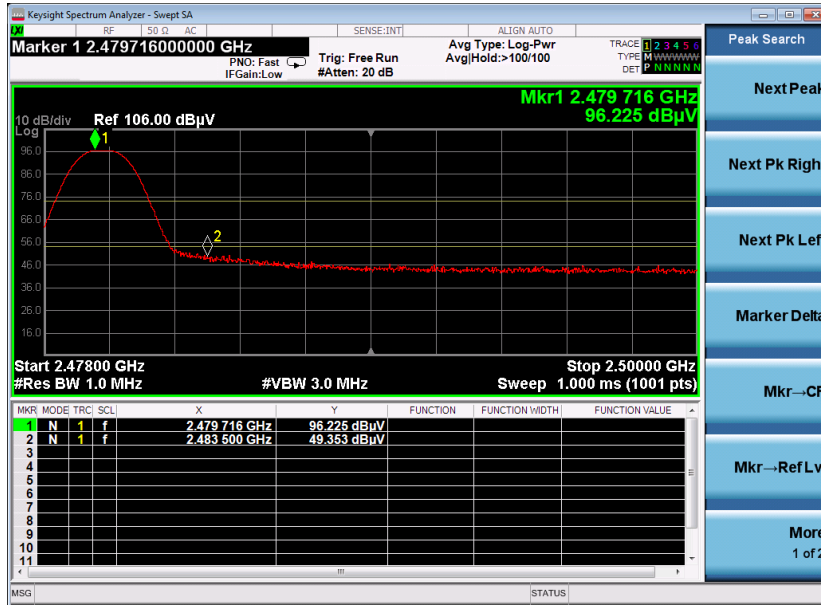

AV



RESULT: PASS

Note: The factor had been edited in the “Input Correction” of the Spectrum Analyzer. So the Amplitude of test plots is equal to Reading level plus the Factor in dB. Use the A dB(μV) to represent the Amplitude. Use the F dB(μV/m) to represent the Field Strength. So A=F.

8. LINE CONDUCTED EMISSION TEST

8.1. LIMITS OF LINE CONDUCTED EMISSION TEST

Frequency	Maximum RF Line Voltage	
	Q.P.(dBuV)	Average(dBuV)
150kHz~500kHz	66-56	56-46
500kHz~5MHz	56	46
5MHz~30MHz	60	50

Note:

1. The lower limit shall apply at the transition frequency.
2. The limit decreases linearly with the logarithm of the frequency in the range 0.15 MHz to 0.50MHz.

8.2. BLOCK DIAGRAM OF LINE CONDUCTED EMISSION TEST

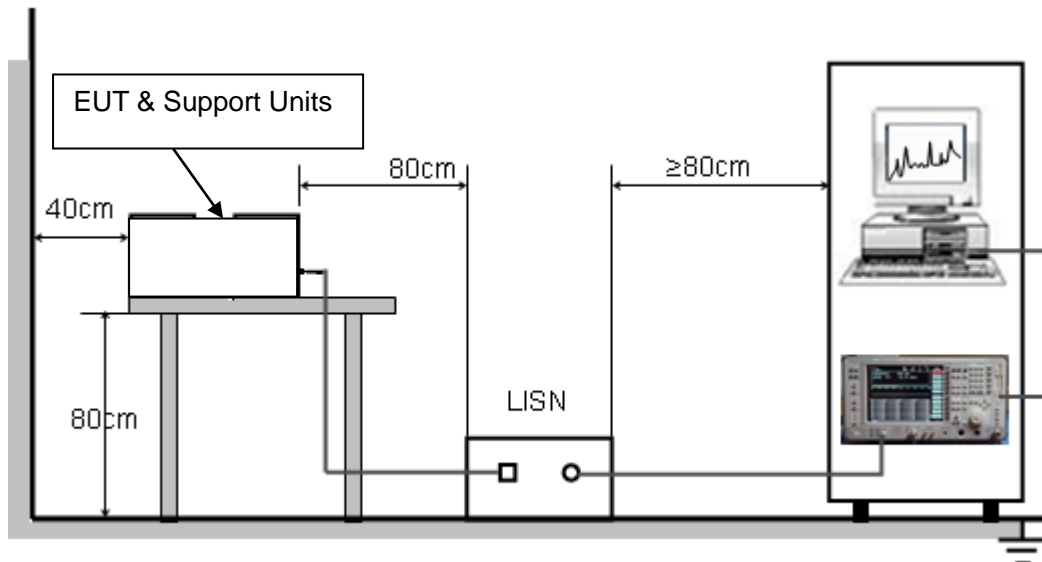



8.3. PRELIMINARY PROCEDURE OF LINE CONDUCTED EMISSION TEST

1. The equipment was set up as per the test configuration to simulate typical actual usage per the user's manual. When the EUT is a tabletop system, a wooden table with a height of 0.8 meters is used and is placed on the ground plane as per ANSI C63.10 (see Test Facility for the dimensions of the ground plane used). When the EUT is a floor-standing equipment, it is placed on the ground plane which has a 3-12 mm non-conductive covering to insulate the EUT from the ground plane.
2. Support equipment, if needed, was placed as per ANSI C63.10.
3. All I/O cables were positioned to simulate typical actual usage as per ANSI C63.10.
4. All support equipments received AC120V/60Hz power from a LISN, if any.
5. The EUT received charging voltage by adapter which received 120V/60Hz power by a LISN..
6. The test program was started. Emissions were measured on each current carrying line of the EUT using a spectrum Analyzer / Receiver connected to the LISN powering the EUT. The LISN has two monitoring points: Line 1 (Hot Side) and Line 2 (Neutral Side). Two scans were taken: one with Line 1 connected to Analyzer / Receiver and Line 2 connected to a 50 ohm load; the second scan had Line 1 connected to a 50 ohm load and Line 2 connected to the Analyzer / Receiver.
7. Analyzer / Receiver scanned from 150 kHz to 30MHz for emissions in each of the test modes.
8. During the above scans, the emissions were maximized by cable manipulation.
9. The test mode(s) were scanned during the preliminary test.

Then, the EUT configuration and cable configuration of the above highest emission level were recorded for reference of final testing.

8.4. FINAL PROCEDURE OF LINE CONDUCTED EMISSION TEST

1. EUT and support equipment was set up on the test bench as per step 2 of the preliminary test.
2. A scan was taken on both power lines, Line 1 and Line 2, recording at least the six highest emissions. Emission frequency and amplitude were recorded into a computer in which correction factors were used to calculate the emission level and compare reading to the applicable limit. If EUT emission level was less -2dB to the A.V. limit in Peak mode, then the emission signal was re-checked using Q.P and Average detector.
3. The test data of the worst case condition(s) was reported on the Summary Data page.



8.5. TEST RESULT OF LINE CONDUCTED EMISSION TEST

LINE CONDUCTED EMISSION TEST-L

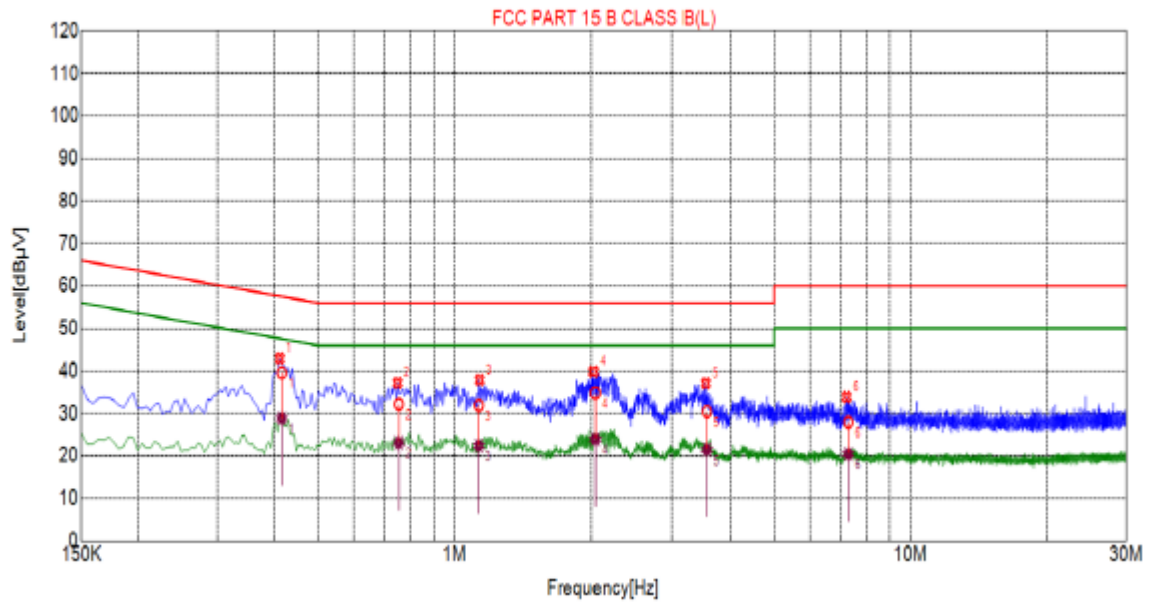

Suspected List						
NO.	Freq. [MHz]	Level [dBµV]	Factor [dB]	Limit [dBµV]	Margin [dB]	Detector
1	0.4110	42.91	10.03	57.63	14.72	PK
2	0.7485	37.19	10.06	56.00	18.81	PK
3	1.1355	37.90	10.09	56.00	18.10	PK
4	2.0220	39.84	10.15	56.00	16.16	PK
5	3.5340	37.11	10.25	56.00	18.89	PK
6	7.2285	33.88	10.19	60.00	26.12	PK

Final Data List								
NO.	Freq. [MHz]	Factor [dB]	QP Value [dBµV]	QP Limit [dBµV]	QP Margin [dB]	AV Value [dBµV]	AV Limit [dBµV]	AV Margin [dB]
1	0.4151	10.03	39.56	57.55	17.99	28.86	47.55	18.69
2	0.7529	10.06	32.20	56.00	23.80	23.15	46.00	22.85
3	1.1312	10.08	31.93	56.00	24.07	22.42	46.00	23.58
4	2.0394	10.15	34.83	56.00	21.17	23.96	46.00	22.04
5	3.5530	10.25	30.47	56.00	25.53	21.49	46.00	24.51
6	7.2900	10.18	27.96	60.00	32.04	20.48	50.00	29.52

RESULT: PASS



LINE CONDUCTED EMISSION TEST-N

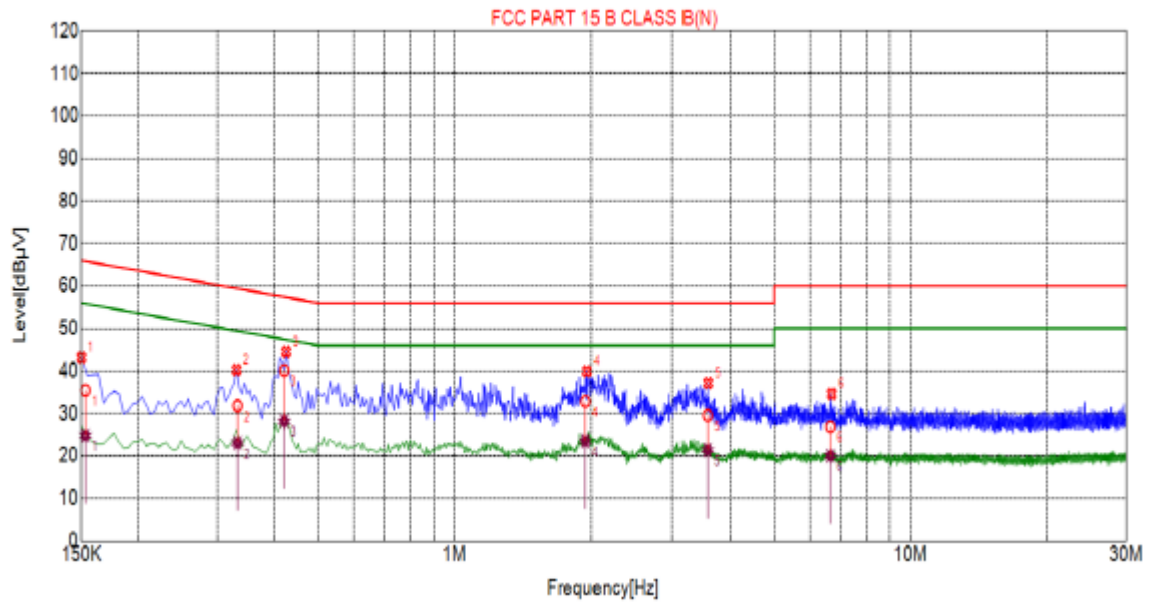

Suspected List						
NO.	Freq. [MHz]	Level [dBµV]	Factor [dB]	Limit [dBµV]	Margin [dB]	Detector
1	0.1500	43.15	10.03	66.00	22.85	PK
2	0.3300	40.26	10.04	59.45	19.19	PK
3	0.4245	44.54	10.04	57.36	12.82	PK
4	1.9590	39.93	10.14	56.00	16.07	PK
5	3.5790	37.15	10.25	56.00	18.85	PK
6	6.6975	34.61	10.21	60.00	25.39	PK

Final Data List								
NO.	Freq. [MHz]	Factor [dB]	QP Value [dBµV]	QP Limit [dBµV]	QP Margin [dB]	AV Value [dBµV]	AV Limit [dBµV]	AV Margin [dB]
1	0.1530	10.03	35.48	65.84	30.36	24.83	55.84	31.01
2	0.3315	10.04	31.85	59.41	27.56	23.12	49.41	26.29
3	0.4203	10.04	40.14	57.44	17.30	28.23	47.44	19.21
4	1.9440	10.14	32.85	56.00	23.15	23.55	46.00	22.45
5	3.5683	10.25	29.61	56.00	26.39	21.39	46.00	24.61
6	6.6535	10.21	26.90	60.00	33.10	20.05	50.00	29.95

RESULT: PASS

Note: All the test modes had been tested, the mode 1 was the worst case. Only the data of the worst case would be record in this test report.

APPENDIX A: PHOTOGRAPHS OF TEST SETUP

RADIATED EMISSION TEST SETUP BELOW 1GHZ

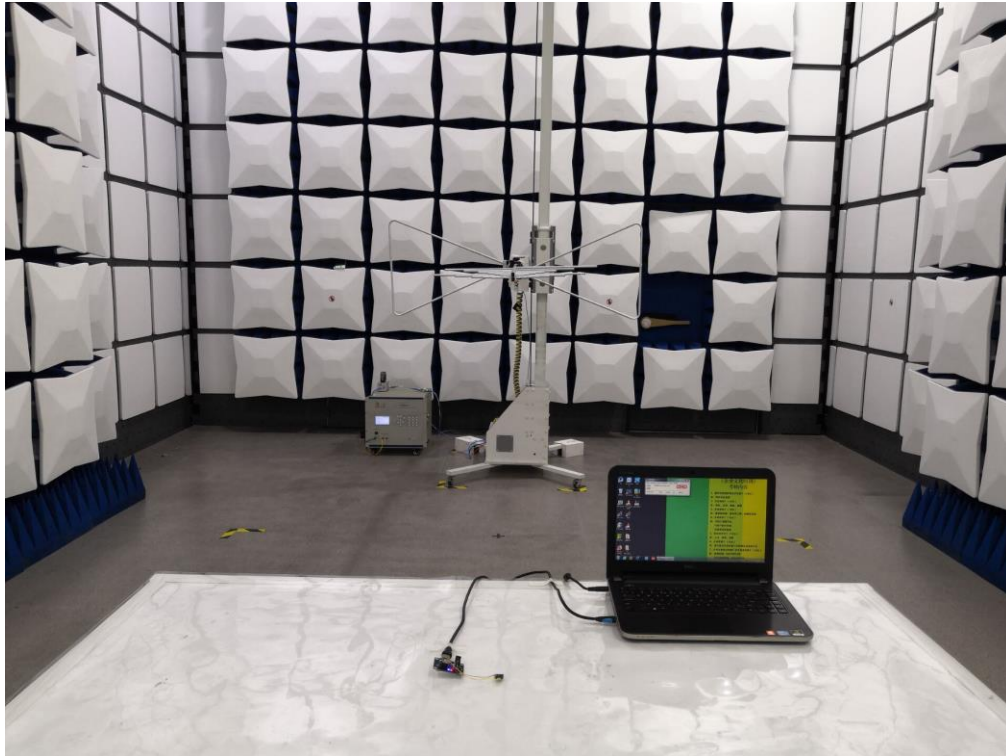

RADIATED EMISSION TEST SETUP ABOVE 1GHZ

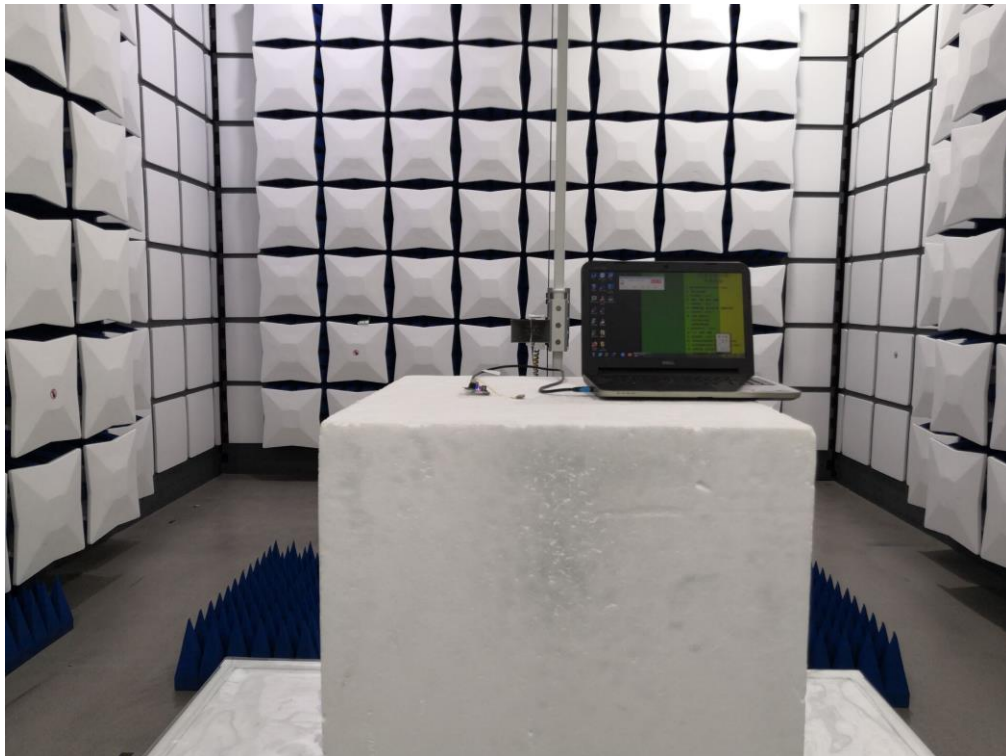

Conducted Emission

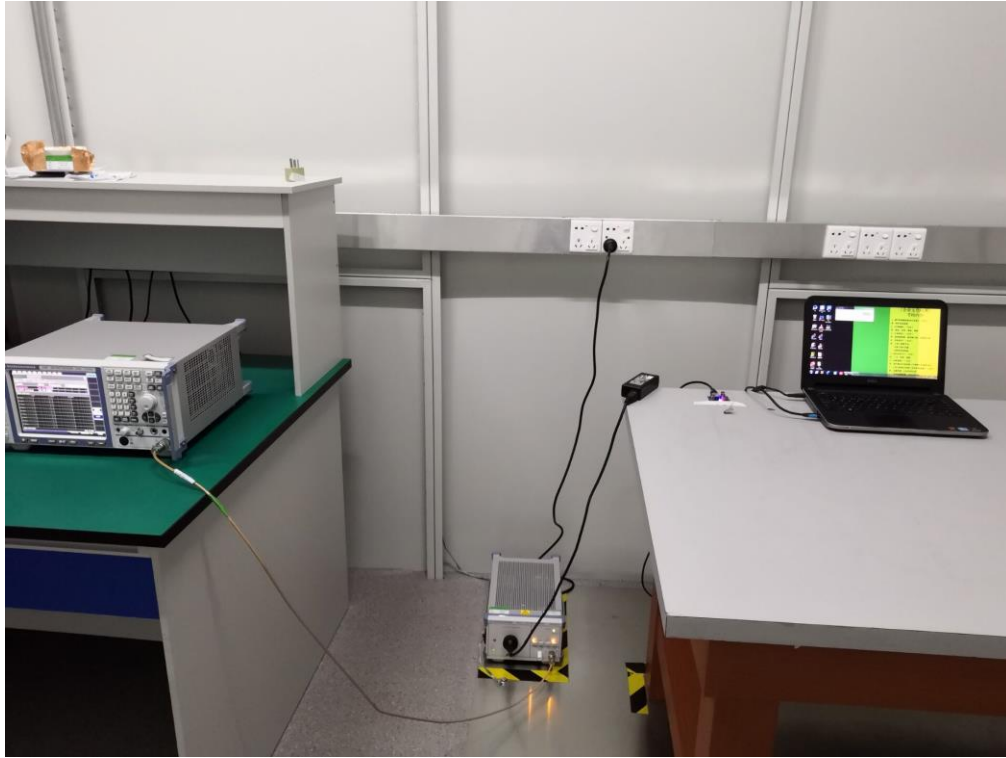

APPENDIX B: PHOTOGRAPHS OF EUT

TOP VIEW OF EUT

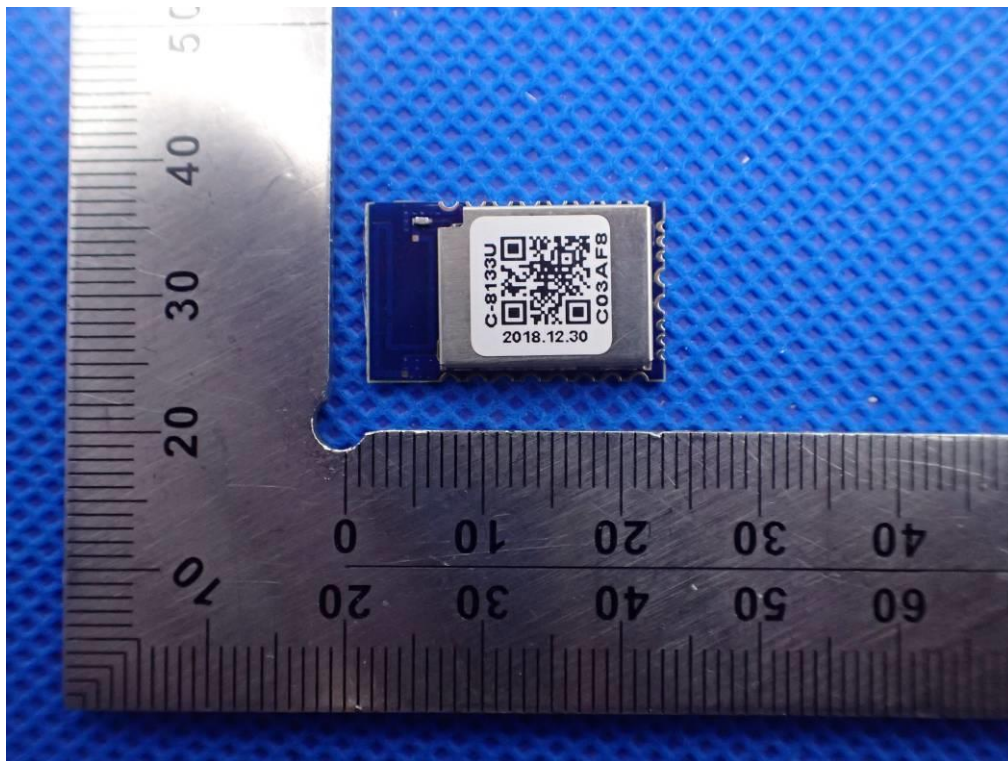

BOTTOM VIEW OF EUT

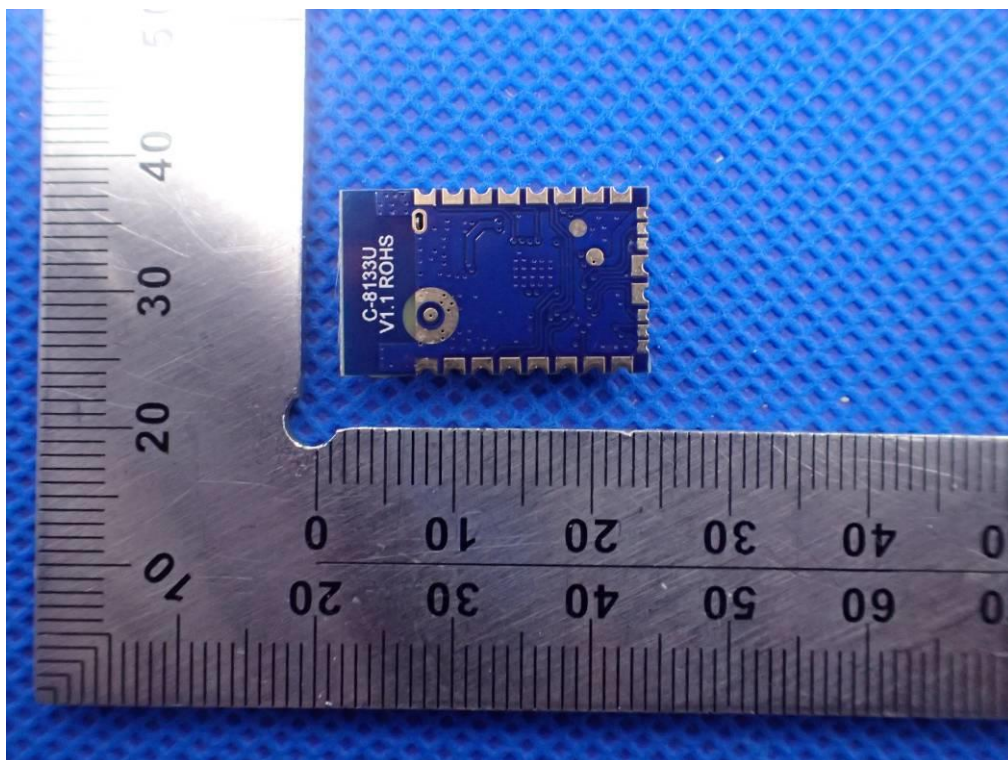



FRONT VIEW OF EUT

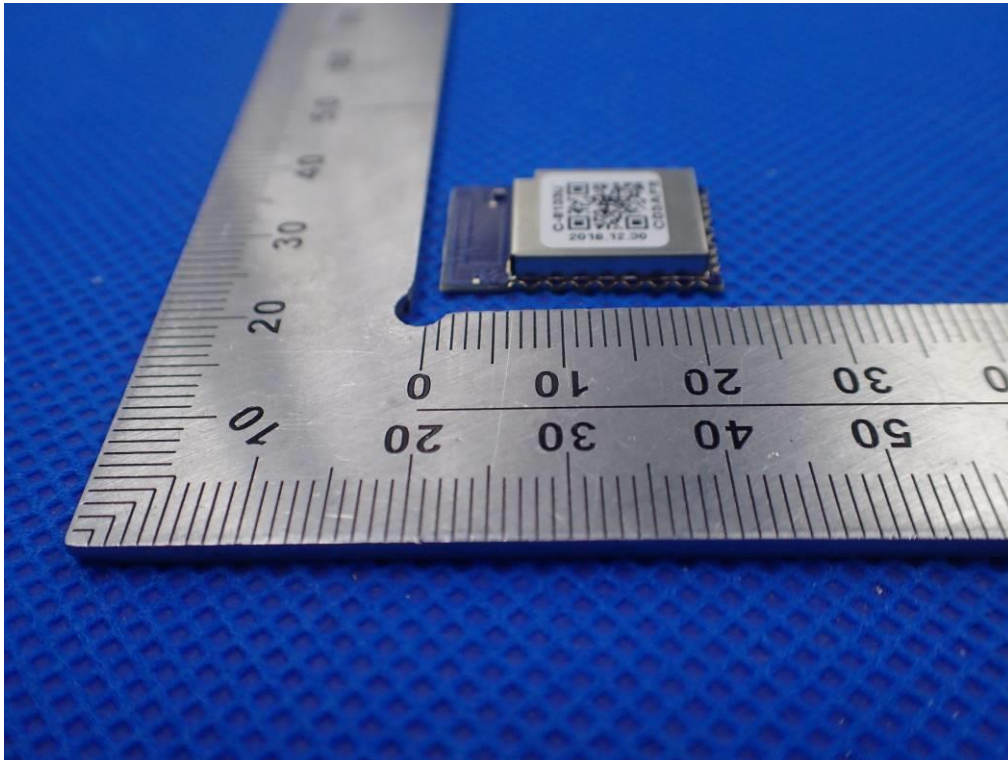

BACK VIEW OF EUT

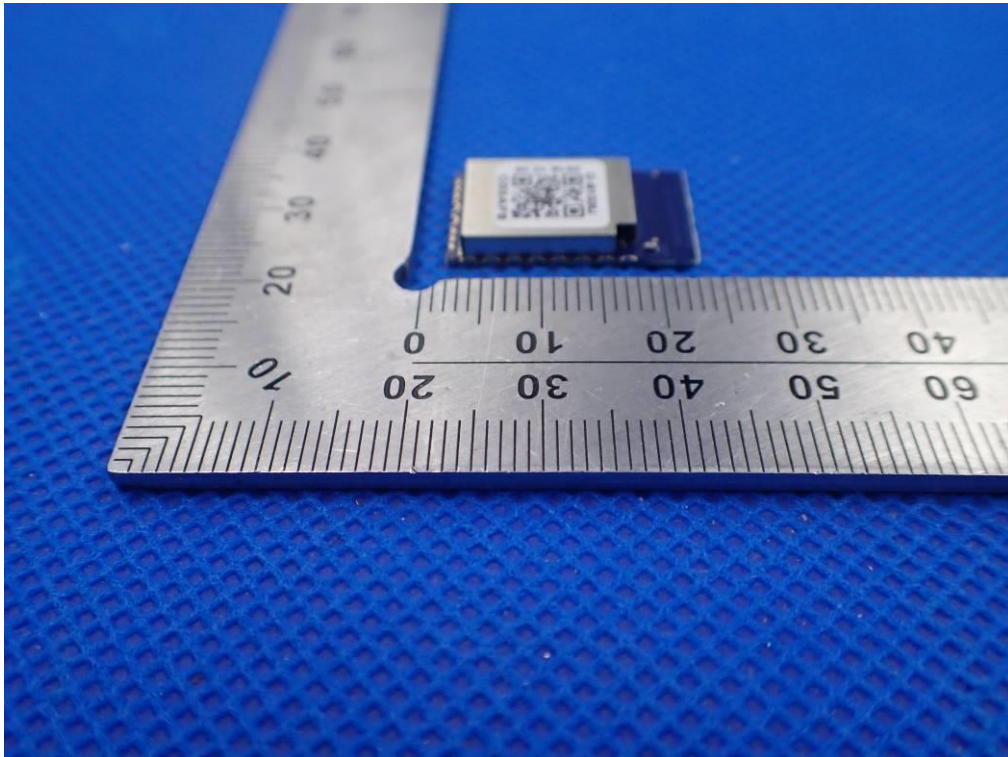

LEFT VIEW OF EUT

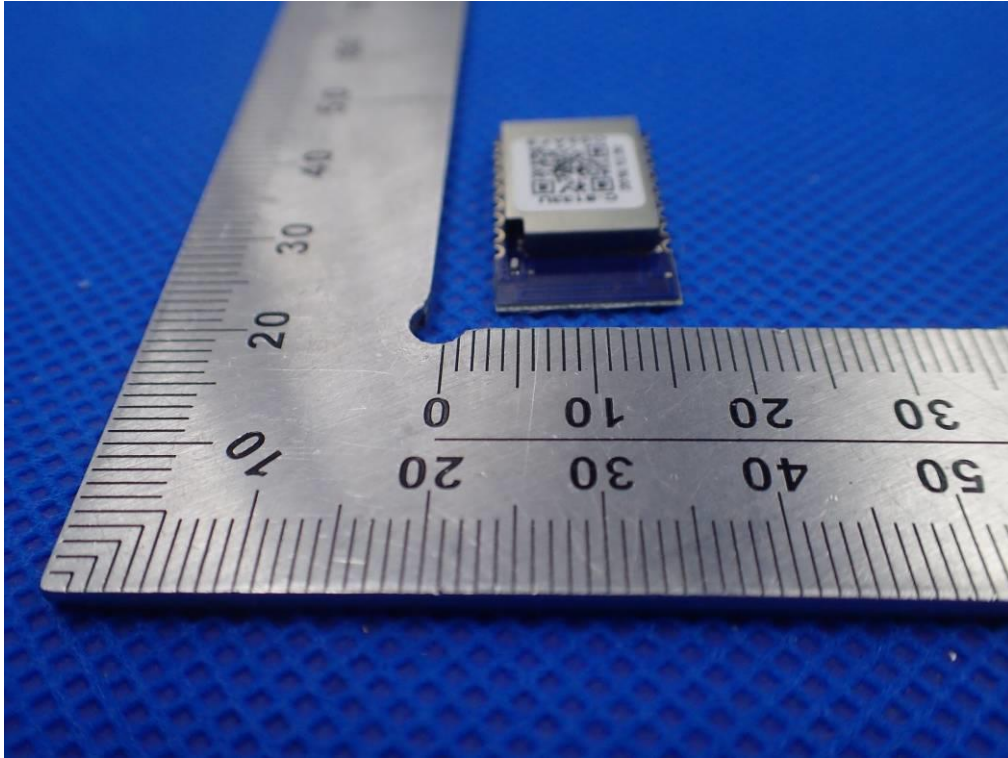

RIGHT VIEW OF EUT

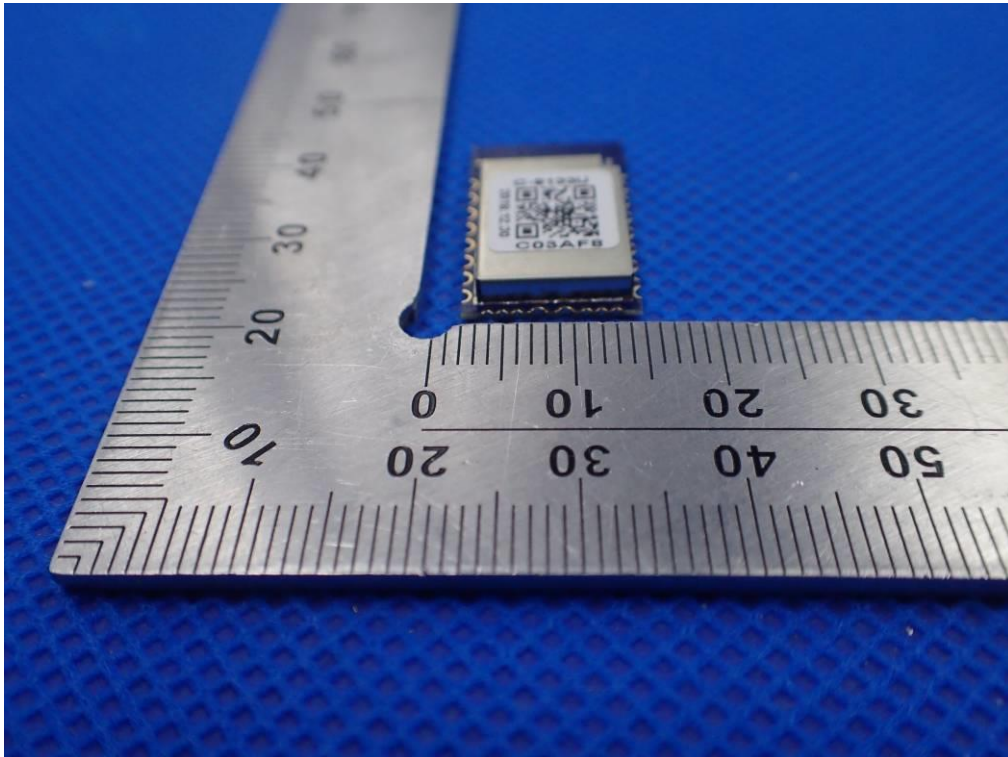

OPEN VIEW OF EUT

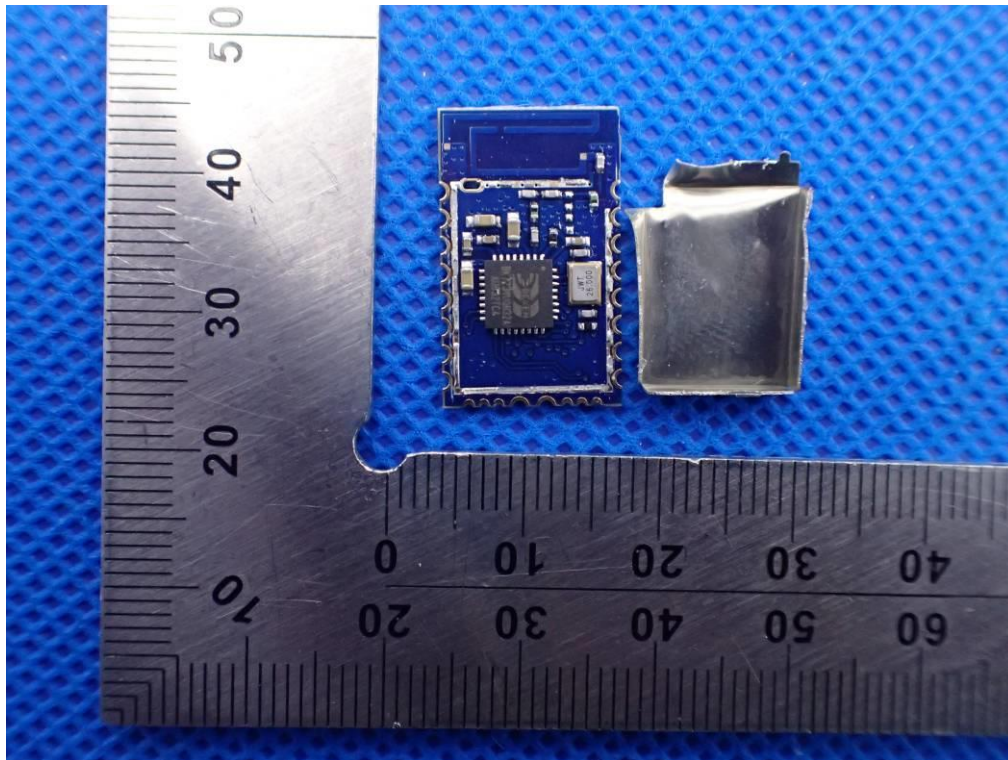

INTERNAL VIEW OF EUT-1

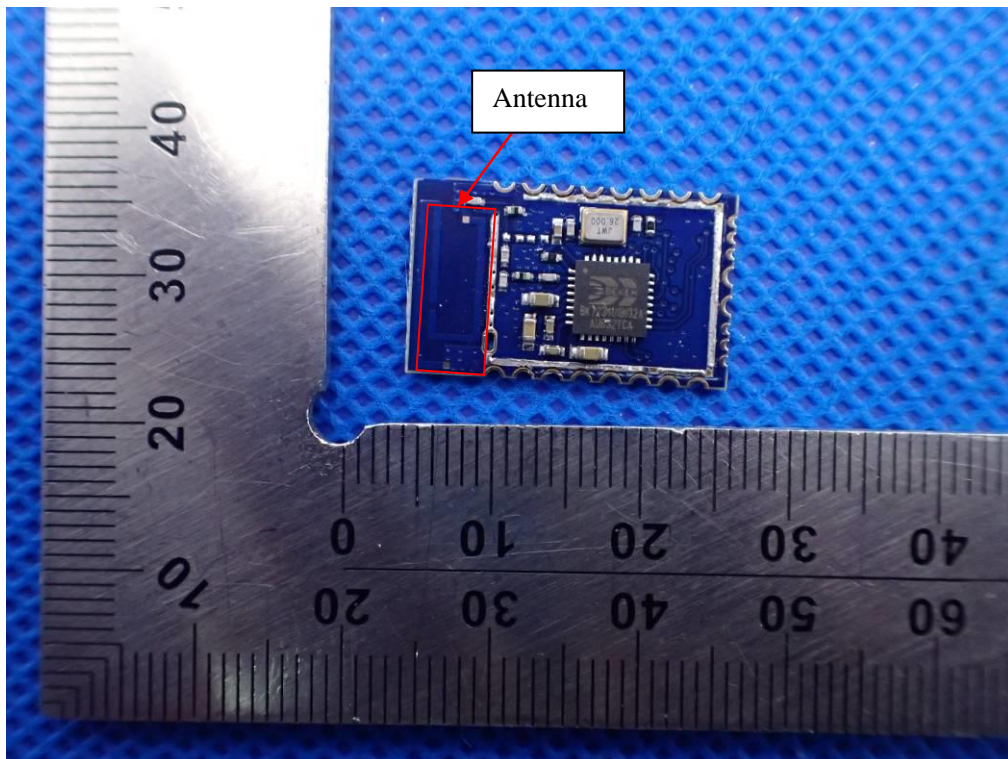



INTERNAL VIEW OF EUT-2

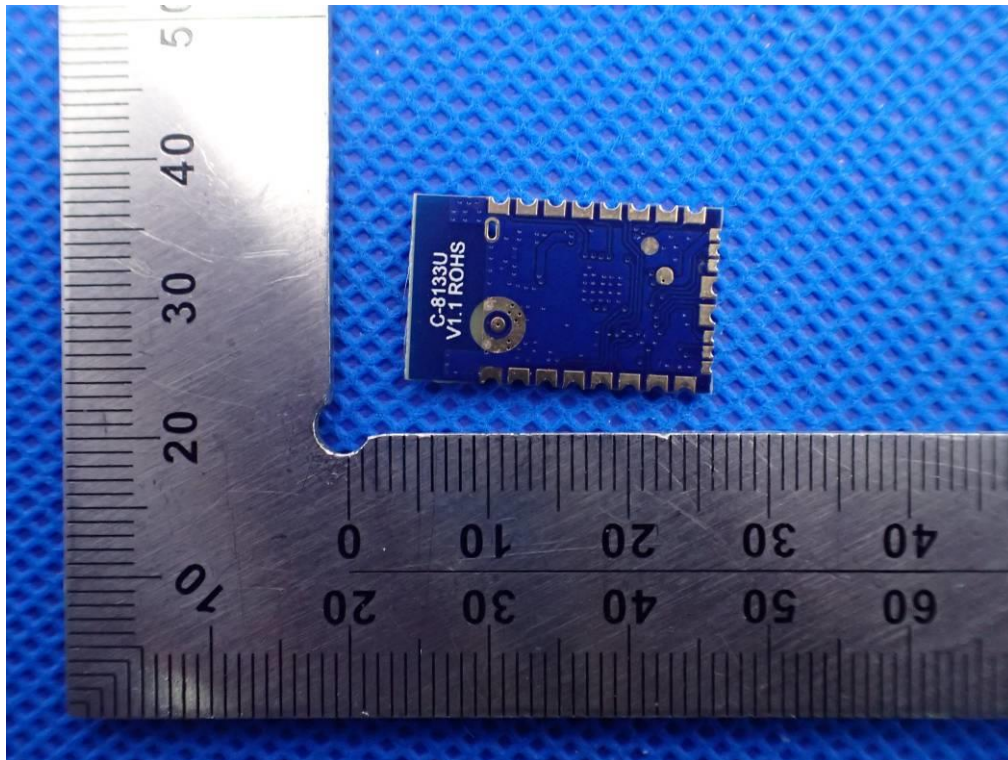

INTERNAL VIEW OF EUT-3

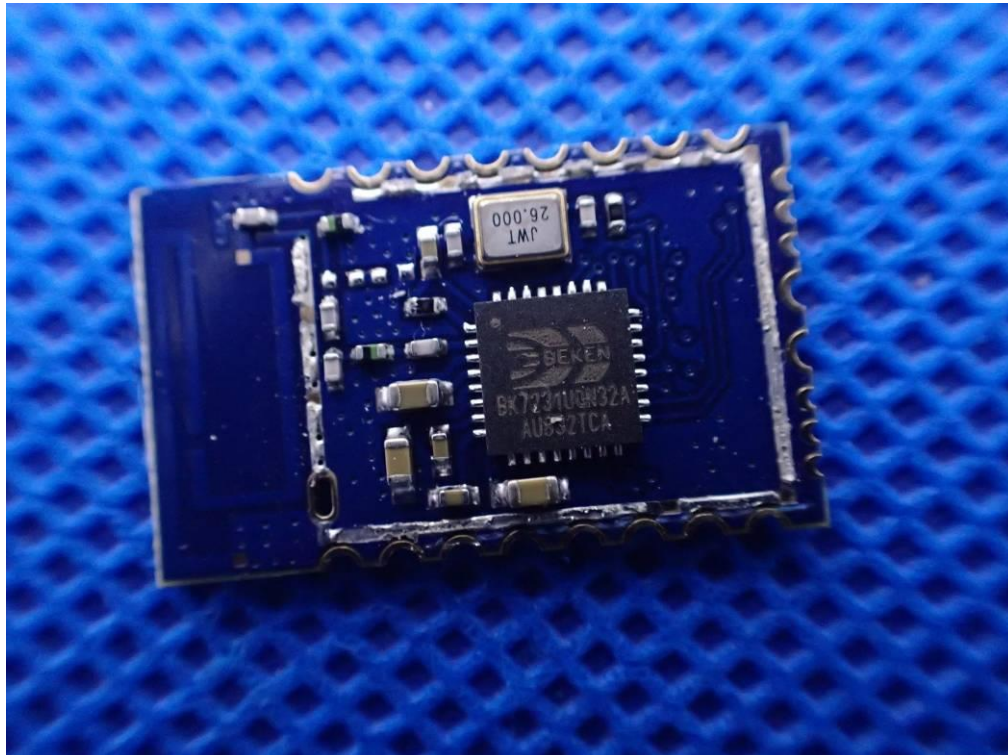

----END OF REPORT---