

5) Gimbal adjustment

As shown in the figure below, dial the pulley in the upper left corner of the remote control to control the camera pitch angle.

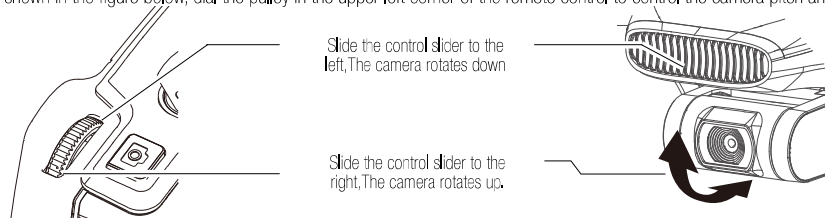

6) Photo / video

Press '📷', with 'Beep' sound on RC, which means photo is taken successfully.

Press '📹' with 'B-B-' sound on RC, which means video start to record successfully, press '📷', again, with 'B-B-' sound on RC, which means video stop to record successfully.

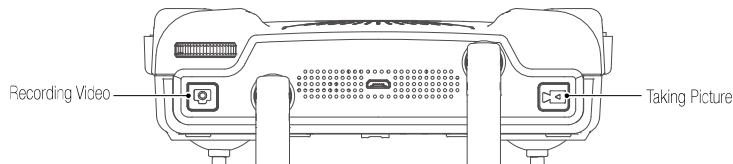

Note :

- When the aircraft is not inserted with micro SD card or the micro SD card malfunction, the photos and videos will be stored on the mobile device, the quality of video files is relatively poor.
- Please stop recording before turn off, otherwise it will cause file damage.
- Pictures can not be taken when it's recording.

7) One-key takeoff / landing

Long press the '⬆️' button for 2 to 3 seconds. When the remote controller beeps steadily, the aircraft will automatically takeoff and ascend to the altitude of 1.2 meters and hover.

Long press the '⬆️' button for 2 to 3 seconds. When the remote controller beeps steadily, the aircraft will land vertically.

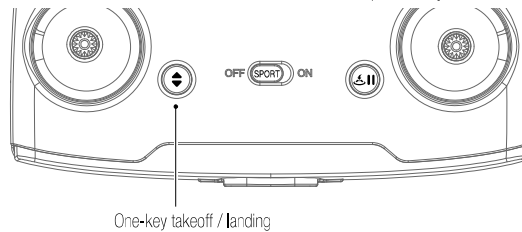

8) RTH

Long press '🏠' button, with 'B-B-' sound on RC, to start the RTH, The aircraft will fly back to the latest recorded return point. The joysticks can not be used during the process of ascent and return. During its landing, user can toggle the joystick to control the aircraft and decide the landing site. During its return, press the '🏠' button again to exit RTH mode, then the user will regain control of the Aircraft.

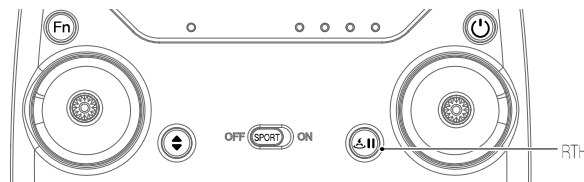

Attention :

- To ensure the return to home point as precise as possible, please fly the aircraft in open area (no tall buildings in 50 meters of radius, flat in 10 meters of radius) with the GPS working well, then the return to home function will be able to activate.
- With the GPS positioning mode turned on, it will automatically enter auto return to home mode if the remote controller loses control.
- Once the RTH mode is enabled, if the aircraft flies below 30 meters of altitude, the aircraft will automatically ascend to 30 meters before returning to home point. If the aircraft flies over 30 meters of altitude, the aircraft will return to home point at the current altitude. Please do not use other functions during the process of return. Please ensure there are no obstacles in way of return in case of any potential accidents.

3. Throttle control stick mode

1) There are two kinds of control modes

Right hand throttle mode (mode 1, i.e. japanese hand) and left hand throttle mode (mode 2, i.e. american hand). The control methods are as follows:

The default setting mode is left hand throttle mode (mode 2, i.e. american hand).

Mode 1

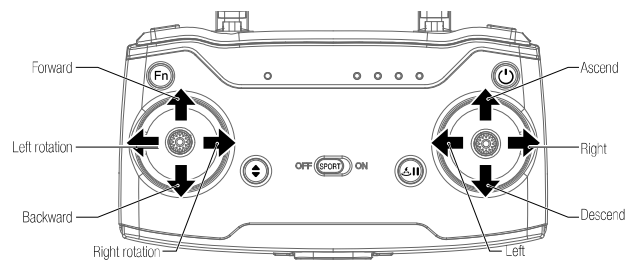

Mode 2

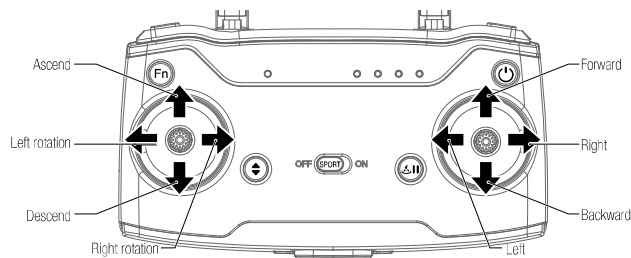

After taking off, control the aircraft as shown in the figure below.

Mode1

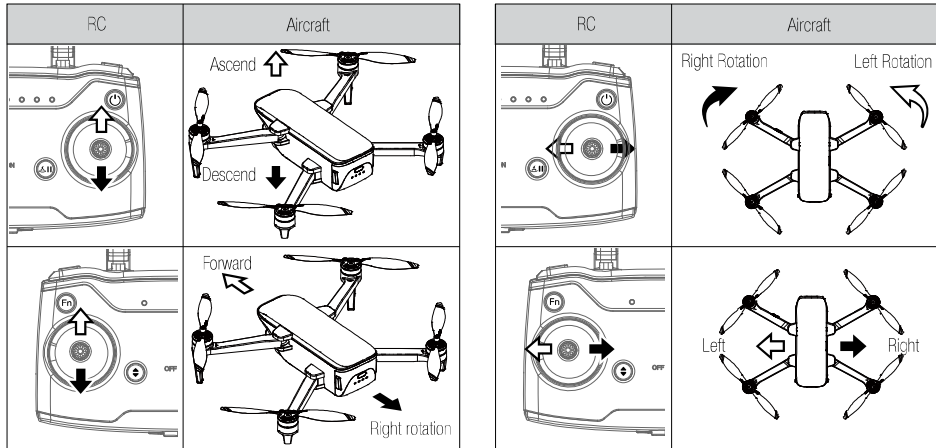

Mode2

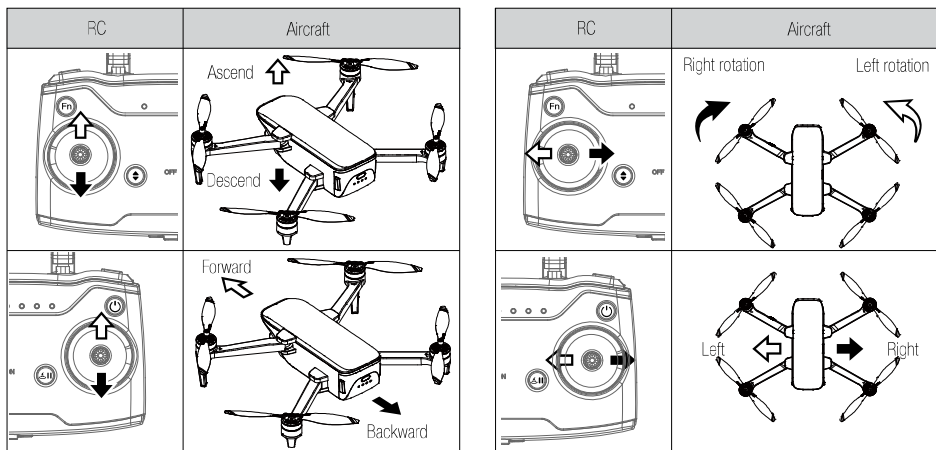

2) Throttle control stick mode

- Switch to mode 2 (default setting)

Before turning on, pull the left joystick to the lowest position, press the buttons 'Fn' and 'Power' at the same time, and keep still, wait for the remote control to make a beep and the two green lights are on to complete successfully. Switch to 'mode 2', user can use it after restarting the remote controller.



- Switch to mode 1

Before turning on, pull the right joystick to the lowest position, press the buttons '⊖' and '⊙' at the same time, and keep still, wait for the remote control to make a beep and the two green lights are on to complete successfully. Switch to 'mode 1', user can use it after restarting the remote controller.

4. Optimal transmission zone

Please fully extend the antennas before the flight. The signal is weak directly above the antenna. The signal between the aircraft and the remote controller is most reliable when the antennas are positioned in relation to the aircraft as depicted below.

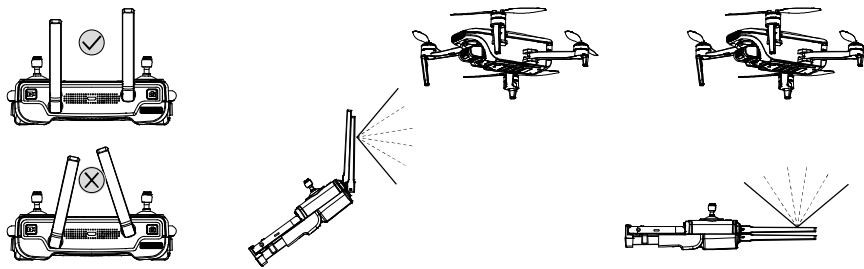

Ensure that the aircraft is flying within the optimal transmission zone. To maintain optimal transmission performance, adjust the remote controller and antennas and keep the space between controller and aircraft clear during the flight.

5. Pair the aircraft

The aircraft is pre-paired with the remote controller in the package, users can use it once turn it on.

If the remote controller is replaced or for other reasons that causes a failure in matching the aircraft and the remote controller, please complete the binding as the following steps :

- (1) Turn on the aircraft and the remote control.
- (2) Use data wire to connect the RC and phone.
- (3) Open Cfy 2 app, choose 'mine—rc paired', click 'rc paired'.
- (4) The Wi-Fi name scanned will be displayed in the dialog.
- (5) Please select the Wi-Fi of the aircraft, such as 'drone-xxxxx' and then click 'OK'.
- (6) When the light of the aircraft turns green and flashes slowly or is always on, it indicates that the RC and aircraft is paired

Cfly 2 APP

This section describes function of Cfly 2 APP



Download APP

1. APP introduction

Through the Cfly 2 app, user can check the FPV, as well as the status and data of the current aircraft. It can also control the flight of the aircraft, control the camera of the aircraft, control the photographing, camera shooting and set the flight parameters. In order to get a better experience, please be sure to connect the Cfly 2 APP before flight.

2. Download Cfly 2 APP

Scan the QR code to download the app.



- 1) Please make sure that the mobile software environment is android 6.0 or above and IOS 10.0 or above.
- 2) Make sure the mobile phone has enough power when connecting the app.
- 3) When use the Cfly 2 APP on mobile phone, please focus on controlling the aircraft.
- 4) Make sure the map on Cfly 2 APP is loaded before flight.
- 5) Please register the aircraft according to local laws and regulations.

3. Register / log in

Install Cfly 2 app, and register an account as shown:

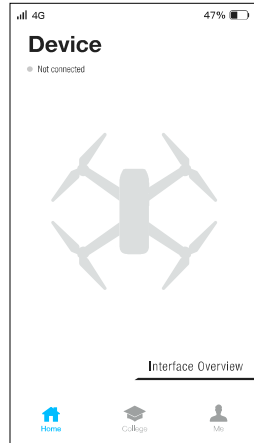
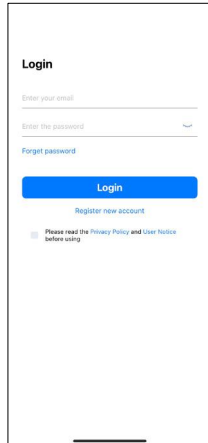
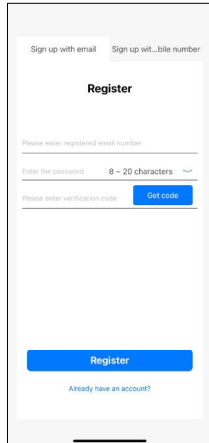

4. Connect the aircraft

Turn on RC, connect RC and phone via data wire.

Open Cfly 2 APP to check whether the aircraft status in the upper left corner is connected. If 'connected' is displayed, click 'start flying' to enter operation interface.



5. Camera setting



- ① **Homepage**
- ② **Remote controller signal**
- ③ **Mobile GPS accuracy**
- ④ **GPS signal**
- ⑤ **Battery life**
- ⑥ **Flight mode and status prompt:**
- ⑦ **Aircraft flight status data:**
 H: the altitude of the aircraft's current position and take-off point ;
 D: the distance between the current position of the aircraft and the take-off point ;
 VS: the current vertical flight speed of the aircraft;
 HS: the current horizontal flight speed of the aircraft.
- ⑧ **General settings**
- ⑨ **One key takeoff:**
 Before the aircraft takes off, the take-off icon '  ' is

- displayed. After clicking , the aircraft will automatically takeoff and hover at a height of 1.2 meters.
- After the aircraft takes off, the landing icon '  ', is displayed, and the aircraft automatically descends to the ground after clicking. will automatically takeoff and hover at a height of 1.2 meters.
- ⑩ **RTH**
- ⑪ **One key shots:**
 Switch flight modes, or start one key short.
- ⑫ **Map**
- ⑬ **Photo/video switch**
- ⑭ **Photo/video start**
- ⑮ **Camera setting**
- ⑯ **Album**
- ⑰ **Current camera setting**

6. General settings

1) Aircraft setting

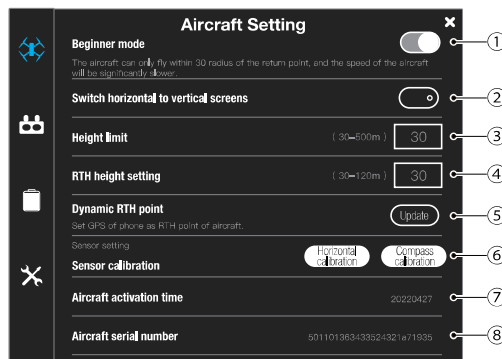

- ① **Beginner mode:**
 Activate 'Beginner mode' before take-off, flight distance and altitude will be limited, the default flight distance is 50 meters and the flight altitude is 30 meters.
- ② **Switch horizontal to vertical screens**
- ③ **Height limit:**
 Set the maximum flight altitude.
- ④ **RTH height setting:**
 Set the flight altitude of RTH.

⑤ **Dynamic RTH point:**

Update return point.

⑥ **Sensor calibration:**

Refer to relevant chapters for its functions.

⑦ **Aircraft activation time**

⑧ **Aircraft serial number**

2) RC setting

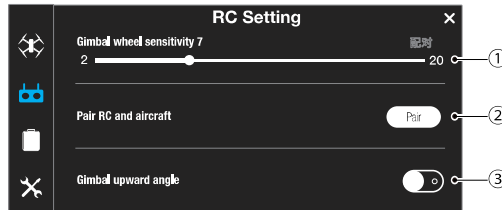

① **Gimbal wheel sensitivity:**

② **Pair RC and aircraft:**

Pair the remote control. Refer to the relevant instructions for its functions.

③ **Gimbal upward angle:**

When on, the camera can be operated up to 20 degrees horizontally.

3) Battery settings

Click '🔋', enter battery setting interface, set rest battery capacity to alarm, the value is from 10%~80%, when battery of aircraft is lower than the value, the indicator of aircraft turn to flashing red, meanwhile, aircraft will return to home and land.

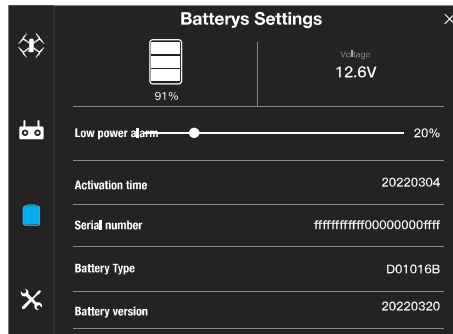

4) Other settings

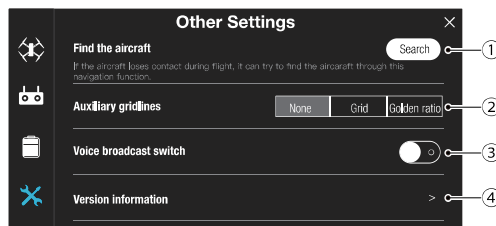

① **Find the aircraft**

Find the lost aircraft through the navigation function.

② **Auxiliary gridlines**

It is used for the composition calibration of picture viewfinder.

③ **Voice broadcast switch**

④ **Version information**

Display version information.

Flight

This section describes flight precautions, flight restricted area and aircraft precautions.

After completing the preparation, please conduct flight training or training first.

Please choose the right flight environment when flying. The default flight height of the aircraft is 120m. Do not exceed the safe flight height. Strictly abide by local laws and regulations during flight.

Be sure to read the 'safety and disclaimer' before flying to understand the safety precautions.

1. Flight environment requirements

- 1) Do not fly the aircraft in bad weather such as high winds, snow, rain, foggy weather, etc.
- 2) Choose a wide, open place with no tall buildings surrounded as a flight site. Buildings that use a lot of steel bars may affect the compass work and block GPS signals resulting in poor positioning or even inability to locate the aircraft.
- 3) When flying, please keep aircraft in sight, away from obstacles, crowds, water, etc.
- 4) Do not flying in areas that have high-voltage lines, communication base stations or transmission towers, etc. to avoid signal interference of the remote controller.
- 5) When flying above 6000m altitude, the performance of the aircraft battery and power system will be degraded due to environmental factors, thus the flight performance will be affected. Please fly with caution.
- 6) GPS is not available for flight in Arctic circle and Antarctic circle.

2. Flight restrictions and flight limits of special area

Flight restrictions and flight limits of special area according to the air traffic control regulations and the aircraft management regulations of ICAO and different nations' air traffic control, aircraft must fly in the prescribed airspace.

3. Beginner mode

For beginners, please turn on the beginner's mode. Once the mode is activated, the aircraft will locate its own position by GPS before ready to takeoff. If the aircraft can not be controlled after takeoff, the RTH can be used to allow the aircraft to return automatically.

It is highly recommended to use the beginner mode, in which the flying height of the aircraft will be limited to 30 meters and the distance will be limited to 50 meters (the height / distance limitation can be manually adjusted), and the aircraft can only takeoff if there is a good GPS signal. If user are already familiar with the operation of the aircraft, user can turn off the beginner mode in the 'aircraft settings' menu of the app.

4. Pre-flight inspection

- 1) Make sure the remote controller, aircraft battery, and mobile device are fully charged.
- 2) Make sure the propellers intact and installed correctly.
- 3) Make sure that front and rear arms and the blades are fully unfolded.
- 4) Make sure that the camera lens is clean.
- 5) Make sure the micro SD card installed correctly.
- 6) Ensure that the battery is firmly installed.
- 7) Always use original components or accessories certified by the manufacturer. The use of non-original accessories may pose a hazard to the use of the aircraft.

5. Compass calibration

The aircraft has a built-in compass that ensures that the aircraft maintains an accurate heading during intelligent flight. The compass status must be checked before each flight. If encounter the following situations, please calibrate the compass:

- (1). Before the flight to a new flight site.

- (2). When the aircraft status indicator shows that the compass has errors.
- (3). When the APP and the aircraft remind to calibrate the compass.
- (4). When the aircraft experiences severe shifting during hovering or flying.

Compass calibration via APP

(1). Enter calibration mode :

When aircraft and APP connected, Choose 'aircraft—operation interface---setting---aircraft setting' click '☰' sensor calibration--compass calibration.

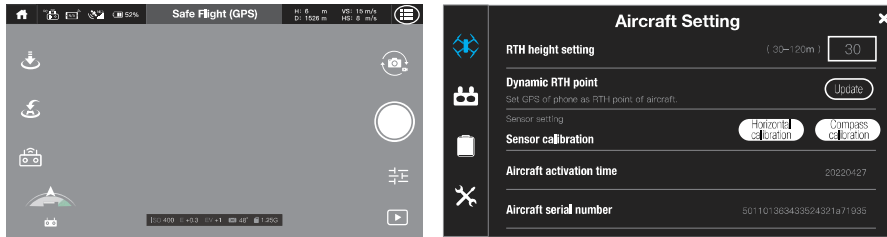

(2). Compass calibration:

When the APP pops up a prompt, check the current environment and keep away from metal objects as prompted. Then tap the 'calibration' button. In this case, when the status indicator on the rear arm of the aircraft flashes blue and red alternately, the compass calibration mode starts.

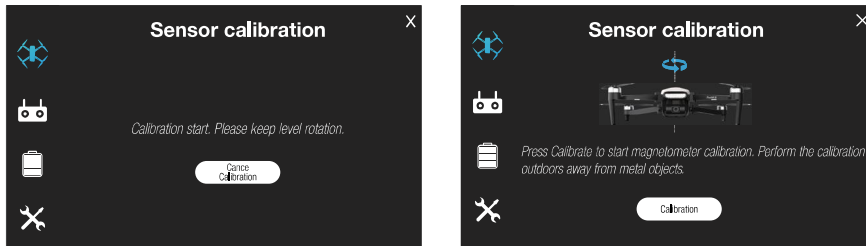

Horizontal calibration :

When the APP prompts to rotate the aircraft horizontally, place the aircraft horizontally in the hand, then turn the aircraft horizontally until the status indicator on the rear arm of the aircraft changes to an alternately flashing red and green light, which means that the horizontal calibration is successful.

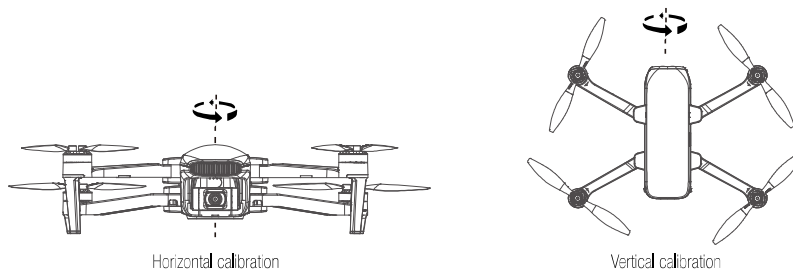

Vertical calibration :

When the APP prompts to place the aircraft's head to be up and rotates, place the aircraft in the hand and ensure that the aircraft body is perpendicular to the ground; then rotates the aircraft horizontally. When the status indicator on the rear arm of the aircraft turns green (solid or flashing), the compass is successfully calibrated, at this time, the APP will prompt 'calibration successful', then

tap 'finish' to end the calibration process, if the status indicator turns to solid red light for about 6 seconds, the compass calibration fails. Please go to another location and re-calibrate.

Note :

- **After changing the flight site, make sure to calibrate the compass before the first flight.**
- **If the aircraft indicator flashes blue and green alternately during flight, which means that the compass is abnormal and need to calibrate.**
- **Stay away from the environment with magnetic interference when calibrating, otherwise the calibration may fail.**
- **Do not calibrate in areas with strong magnetic fields, such as magnetic mines, parking lots, and building areas with underground reinforcement.**
- **Do not calibrate with carrying ferromagnetic materials such as keys, mobile phones, etc.**
- **Do not calibrate when large pieces of metal are nearby.**

6. Basic flight operation steps

- (1) Place the aircraft in a wide open area that its front is user's front.
- (2) Turn on the aircraft and remote controller.
- (3) Connect the remote controller with the aircraft and then proceed aircraft self-diagnostic tests.
- (4) Connect the APP with mobile device and enter into the FPV interface.
- (5) Unlock the aircraft after the APP indicate: ready go.
- (6) Pull up the throttle stick then the aircraft takes off, and control the aircraft flight by left/right stick.
- (7) Pull down the throttle stick to land the aircraft.
- (8) Down the throttle stick to the bottom position and keep for 3 seconds to lock the aircraft.
- (9) Pull out the battery from the aircraft and then turn off the remote controller.

7. Flight control instructions

1) Power on

Put the aircraft on the flat surface, turn on the remote controller and aircraft successively, wait for aircraft on flat ground for about 30 seconds for self-diagnostic tests.

When the aircraft's indicator light turns from flashing or solid blue to flashing or solid green, which means the Remote controller and aircraft are connected.

In the process of self-diagnostic tests, ground vibration may cause abnormal operation of the aircraft and gimbal, please shut down and restart the aircraft on the static horizontal ground to enter the normal working state.

2) Connect APP

Turn on the 'Cfly 2 APP', reference page 24 Connect the aircraft.

3) GPS signal status

When the status indicator of the aircraft is solid green, it indicates that the GPS positioning is normal, and the aircraft can takeoff safely.

When the green light flashes on the aircraft status indicator, it indicates that the GPS signal is weak or no signal, and altitude mode can be selected for operation (this mode is difficult to operate, it is not recommended for beginners).

Note :

- **Set the aircraft up and get ready to takeoff after the aircraft indicator light turns solid green (indicating good GPS signal).**
- **Please choose an open and spacious field. Tall steel structures and metal materials will interfere the compass and GPS.**

4) Operate the aircraft takeoff

(1) One-key takeoff on remote controller :

Long press the '⏻' button for 2 to 3 seconds. When the remote controller beeps steadily, the aircraft will automatically takeoff and ascend to altitude of 1.2 meters and hover.

(2) One-key takeoff on Cfly 2 app :

Click the '⏻' on app, then click confirm, the aircraft will automatically takeoff and ascend to altitude of 1.2 meters and hover. Please make sure the safe distance for operate.

(3) Takeoff manually :

Toggle the left and right joysticks outward as to get the propellers started to rotate. Slowly push the throttle, the aircraft will takeoff.

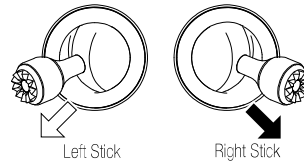

5) Operate the aircraft flying

Reference page 19 'throttle control stick mode'.

6) Operate the aircraft land

(1) One-key landing on remote controller :

Long press the '⏻' button for 2 to 3 seconds. When the remote controller beeps steadily, the aircraft will automatically land and propeller stop to rotate.

(2) One-key landing on Cfly 2 app :

Click the '⏻' on app, then click confirm, the aircraft will automatically land and propeller stop to rotate. Please make sure the safe distance for operate.

(3) Landing manually :

Slowly pull the throttle, the aircraft will descend to land, keep pulling the throttle, propeller stop to rotate.

7) Power off

After completing the flight, please turn off the power of the aircraft and the remote controller in turn.

Note: Please do not touch the motor after the aircraft just landed!

8. Suggestion and tips for recording video

- (1) Make sure components of the aircraft are normal before flight.
- (2) Choose sunny, windy weather for recording.
- (3) Perform test flights to establish flight routes and to preview scenes.
- (4) Push the control stick gently to keep the aircraft movement smooth and stable.
- (5) Choose appropriate gimbal shooting angle.
- (6) Try to record the videos under positioning mode.

Appendix

1. Specification

1) Aircraft

| | |
|-------------------------------|---|
| Size (fold): | 170x108x74 mm (L*W*H) |
| Size (unfold): | 182x255x74mm (L*W*H) |
| Wheelbase | 280 mm |
| Weight | 530g |
| Max ascent speed | Normal mode: 3m/s Sport mode: 5m/s |
| Max descent speed | Normal mode: 3m/s Sport mode: 3,5m/s |
| Max speed | Normal mode: 10m/s Sport mode: 17m/s RTH mode: 12m/s |
| Max service ceiling above sea | 5000m |
| Max flight time | 35 mins |
| Satellite positioning systems | GPS/GLONASS |
| Hover accuracy range | Vertical: +/- 0,5 m± 0,2 m (ultrasonic system,optical flow system works) Horizontal: +/- 1,5m± 0,3 m (ultrasonic system,optical flow system works) |
| Maximum flight height | 120m (maximum 500m (need to change setting on app) |
| Operating temperature range | 0 C ~40 C |

2) Optical flow system

| | |
|-----------------------|---|
| Operating environment | Surface with clear pattern and adequate lighting (lux > 15) |
| Velocity range | ≤1,5 m/s at 6,6 ft (2 m) above ground |
| Altitude range | 0,5~5m |

3) Ultrasonic altitude system

| | |
|-----------------------|---|
| Operating environment | Except for surface of water or ground of absorbing material(such as thick carpet) |
| Velocity range | ≤3m/s |
| Altitude range | 0,2~4,5m |

4) 3-axis gimbal

| | |
|---------------|--|
| Controllable | Pitch: -90°~20° |
| Stabilization | Pitch: +30/-120°, Roll: ± 35°, Yaw: ±30° |

5) Camera

| | |
|-----------------------------|---|
| Sensor | Ambarella A12, sony CMOS |
| Image size | 5120×3840(20MP) |
| Shooting mode | Single shot |
| Video recording resolution | 3840×2160 |
| Maximum video bit | 50 Mbps |
| Supported file systems | FAT32(≤32GB) /exFAT(>32GB) |
| Photo | JPEG |
| Video | MP4 |
| Supported SD cards | Micro SD™ Max capacity:128GB, UHS-I speed grade 3 rating required |
| Operating temperature range | 0 C ~40 C |

6) Battery

| | |
|----------------------------|-------------------------|
| Capacity | 3100mAh |
| Voltage | 11,4V |
| Battery type | LiPo 3S |
| Energy | 35,34Wh |
| Net weight | 196 g |
| Max charging power | 35W |
| Charge time | <5h(with 5V 2A adapter) |
| Charging temperature range | 0 °C ~40 °C |

7) APP

| | |
|----------------------------|----------------------------------|
| Mobile app | City 2 |
| Live view quality | 1080P |
| Aerial photography mode | Dronie,rocket,cirde,helix |
| Required operating systems | Andrio 6.0 above, IOS 10.0 above |
| FPV transmission distance | 5000m |

8) Charger

| | |
|-------------|--------------------|
| Input | 5 V 2A (recommend) |
| Output | 4,35V 0,7A×3 |
| Rated power | 10W |

9) Remote controller

| | |
|------------------------------|---|
| Operating frequency | 2,4 GHz |
| Max transmission distance | 5000m |
| Transmitter power (EIRP) | FCC: ≤23dBm CE: ≤14dBm SRRC: ≤20dBm |
| Operating current / voltage | 500mA @ 3,7V |
| Capacity | 2600mAh |
| Battery capacity (built-in) | 3,7V |
| Battery type | LiPo 18650 1S |
| Battery power | 9,62Wh |
| Operating temperature range | 0 °C ~40 °C |
| Supported mobile device size | Thickness supported:6,5-8,5mm |
| Charge | USB |
| Maximum charge power | 5W |
| Charge time | < 3h(with 5V 2A adapter) |

2. Packing detail

Before using this product, please check whether the product package contains all the following items. If something is missing, please contact our company or authorized dealers.

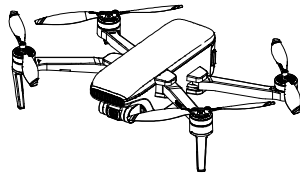

Aircraft x1

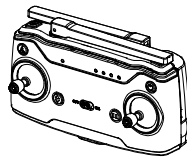

Remote controller x1

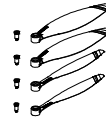

Propellers x2

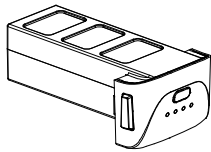

Aircraft battery x1

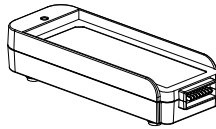

Balance charger x1

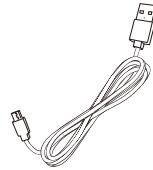

USB wire x1

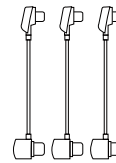

Data wire x1



Screwdriver x2

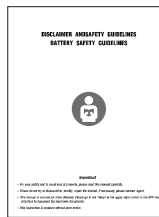

Operation manual x1



User manual x1

3. Important statement

- This product is not a toy, but a precision device that integrates professional knowledge such as mechanics, electronics, aerodynamics, and high-frequency emission. Accidents can be avoided by correct assembly and debugging. The owner of the product must use a safe way to operate and control; improper operation may cause serious personal injury or property damage.
- This product is suitable for people who have experience in operating model aircraft and are at least 14 years old.
- If user encounter problems with use, operation, maintenance, etc., please contact local dealer or relevant personnel of our company. Our company and the seller are No responsibility for any loss and damage caused by improper work and personal injury.
- This product contains small parts, please keep it out of the reach of children to avoid the risk of ingestion or suffocation.

4. Warranty information

Please browse the official website for the latest after-sales warranty information.

5. Safety precautions

The remote control model aircraft is the most dangerous commodity, so user must stay away from the crowd when flying. Improper assembly or damage to the body, poor electronic control, and unfamiliar operations may cause unpredictable accidents such as damage to the aircraft or personal injury. Please be careful when flying to be safe, user must understand the responsibility for accidents caused by your own negligence.

Stay away from obstacles and crowd

The remote control aircraft has an uncertain flight speed and state during flight, and it is potentially dangerous. Stay away from crowds and high-rise buildings when flying at the same time, avoid flying in bad weather such as wind, rain, thunder and lightning. Debugging and installing the aircraft must strictly follow the operating instructions when flying upwards, pay attention to keeping the aircraft at a distance of 1-2 meters from the user or other people. Avoid the aircraft from crashing into the head, face, and body of people when flying or landing, which may cause injury.

Keep away from humid environment

The inside of the aircraft is composed of many sophisticated electronic components and mechanical parts. Therefore, it is necessary to prevent the aircraft from getting wet or water vapor into the aircraft body. Avoid accidents caused by mechanical and electronic component failure. Please wipe the surface stains with a clean cloth during maintenance.

Avoid controlling alone

The control skills of remote control aircraft are difficult to learn in the early stage. It is necessary to avoid flying alone as much as possible, and the guidance of experienced persons is required.

Use this product properly

Please use original parts for modification or repair to ensure flight safety. Please operate and use within the scope allowed by the product function, and must not be used for illegal purposes other than security laws.

Safe operation

- (1) Please operate the remote control aircraft according to your own status and flying skills. Fatigue, poor spirits or improper operation will increase the risk of accidents Probability.
- (2) Do not use it near ears! Misuse may cause hearing damage.

Keep away from high-speed rotating parts

When the aircraft rotor is rotating at high speed, please keep the pilot, surrounding people and objects away from the rotating parts to avoid danger and damage.

Keep away from heat

The remote control aircraft is composed of metal, fiber, plastic, electronic components and other materials. Therefore, it is necessary to keep away from heat sources, prevent sunlight, and avoid deformation or even damage due to high temperature.

Environmental requirements

Discard the product at will, which may affect the environment, please recycle it properly according to local laws and regulations.

FCC statement :

This device complies with part 15 of the FCC rules. Operation is subject to the following two conditions:

- (1) This device may not cause harmful interference, and;
- (2) This device must accept any interference received, including interference that may cause undesired operation.

Warning: Changes or modifications not expressly approved by the party responsible for compliance could void the user's authority to operate the equipment.

NOTE: This equipment has been tested and found to comply with the limits for a Class B digital device, pursuant to Part 15 of the FCC rules. These limits are designed to provide reasonable protection against harmful interference in a residential installation. This equipment generates uses and can radiate radio frequency energy and, if not installed and used in accordance with the instructions, may cause harmful interference to radio communications. However, there is no guarantee that interference will not occur in a particular installation. If this equipment does cause harmful interference to radio or television reception, which can be determined by turning the equipment off and on, the user is encouraged to try to correct the interference by one or more of the following measures:

- Reorient or relocate the receiving antenna.
- Increase the separation between the equipment and receiver.
- Connect the equipment into an outlet on a circuit different from that to which the receiver is connected.
- Consult the dealer or an experienced radio/TV technician for help.

FCC radiation exposure statement for the Aircraft :

This equipment complies with FCC radiation exposure limits set forth for an uncontrolled environment. This equipment should be installed and operated with minimum distance 20cm between the radiator & your body.