



TEST REPORT

FCC PART 15.247

Report Reference No.: **CTL1908301041-WF02**

Compiled by: Happy Guo
(position+printed name+signature) (File administrators)

Happy Guo

Tested by: Nice Nong
(position+printed name+signature) (Test Engineer)

Nice Nong

Approved by: Ivan Xie
(position+printed name+signature) (Manager)

Ivan Xie

Product Name.....: Bluetooth headphones

Model/Type reference: T22

List Model(s).....: N/A

Trade Mark.....: LETSCOM, Letsfit, ANBES

FCC ID.....: **2AR5E-T22**

Applicant's name: **SHENZHEN MIFANG NETWORK TECHNOLOGY CO., LTD.**

Address of applicant: 305, No.8 BLDG., SUOLING INDUSTRIAL ZONE XIKENG,
GUANLAN, LONGHUA, SHENZHEN, GUANGDONG, CHINA

Test Firm: **Shenzhen CTL Testing Technology Co., Ltd.**

Address of Test Firm: Floor 1-A, Baisha Technology Park, No.3011, Shahehexi Road,
Nanshan District, Shenzhen, China 518055

Test specification.....:

Standard.....: **FCC Part 15.247:** Operation within the bands 902-928 MHz,
2400-2483.5 MHz and 5725-5850 MHz.

TRF Originator.....: Shenzhen CTL Testing Technology Co., Ltd.

Master TRF.....: Dated 2011-01

Date of receipt of test item.....: Sept. 16, 2019

Date of sampling.....: Sept. 16, 2019

Date of Test Date.....: Sept. 16, 2019–Oct. 19, 2019

Data of Issue.....: Oct. 20, 2019

Result.....: **Pass**

Shenzhen CTL Testing Technology Co., Ltd. All rights reserved.

This publication may be reproduced in whole or in part for non-commercial purposes as long as the Shenzhen CTL Testing Technology Co., Ltd. is acknowledged as copyright owner and source of the material. Shenzhen CTL Testing Technology Co., Ltd. takes no responsibility for and will not assume liability for damages resulting from the reader's interpretation of the reproduced material due to its placement and context.

TEST REPORT

Test Report No. :	CTL1908301041-WF02	Oct. 20, 2019 Date of issue
--------------------------	---------------------------	--------------------------------

Equipment under Test : Bluetooth headphones

Model /Type : T22

Listed Models : N/A

Applicant : **SHENZHEN MIFANG NETWORK TECHNOLOGY CO., LTD.**

Address : 305, No.8 BLDG., SUOLING INDUSTRIAL ZONE
XIKENG, GUANLAN, LONGHUA, SHENZHEN,
GUANGDONG, CHINA

Manufacturer : **SHENZHEN MIFANG NETWORK TECHNOLOGY CO., LTD.**

Address : 305, No.8 BLDG., SUOLING INDUSTRIAL ZONE
XIKENG, GUANLAN, LONGHUA, SHENZHEN,
GUANGDONG, CHINA

Test result	Pass *
--------------------	---------------

* In the configuration tested, the EUT complied with the standards specified page 5.

The test results presented in this report relate only to the object tested.

This report shall not be reproduced, except in full, without the written approval of the issuing testing laboratory.

Table of Contents

Page

1. SUMMARY.....	5
1.1. TEST STANDARDS.....	5
1.2. TEST DESCRIPTION.....	5
1.3. TEST FACILITY.....	6
1.4. STATEMENT OF THE MEASUREMENT UNCERTAINTY.....	6
2. GENERAL INFORMATION.....	8
2.1. ENVIRONMENTAL CONDITIONS.....	8
2.2. GENERAL DESCRIPTION OF EUT.....	8
2.3. DESCRIPTION OF TEST MODES AND TEST FREQUENCY.....	8
2.4. EQUIPMENTS USED DURING THE TEST.....	9
2.5. RELATED SUBMITTAL(S) / GRANT (S).....	9
2.6. MODIFICATIONS.....	9
3. TEST CONDITIONS AND RESULTS.....	10
3.1. CONDUCTED EMISSIONS TEST.....	10
3.2. RADIATED EMISSIONS AND BAND EDGE.....	13
3.3. MAXIMUM CONDUCTED OUTPUT POWER.....	22
3.4. POWER SPECTRAL DENSITY.....	23
3.5. 6DB BANDWIDTH.....	26
3.6. OUT-OF-BAND EMISSIONS.....	29
3.7. ANTENNA REQUIREMENT.....	35
4. TEST SETUP PHOTOS OF THE EUT.....	36
5. EXTERNAL AND INTERNAL PHOTOS OF THE EUT.....	37

1. SUMMARY

1.1. TEST STANDARDS

The tests were performed according to following standards:

[FCC Rules Part 15.247](#): Frequency Hopping, Direct Spread Spectrum and Hybrid Systems that are in operation within the bands of 902-928 MHz, 2400-2483.5 MHz, and 5725-5850 MHz

[ANSI C63.10: 2013](#): American National Standard for Testing Unlicensed Wireless Devices

[KDB558074 D01 15.247 Meas Guidance v05r02](#): Guidance for Performing Compliance Measurements on Digital Transmission Systems (DTS) Operating Under §15.247

1.2. Test Description

FCC PART 15.247		
FCC Part 15.207	AC Power Conducted Emission	PASS
FCC Part 15.247(a)(2)	6dB Bandwidth	PASS
FCC Part 15.247(d)	Spurious RF Conducted Emission	PASS
FCC Part 15.247(b)	Maximum Conducted Output Power	PASS
FCC Part 15.247(e)	Power Spectral Density	PASS
FCC Part 15.109/ 15.205/ 15.209	Radiated Emissions	PASS
FCC Part 15.247(d)	Band Edge	PASS
FCC Part 15.203/15.247 (b)	Antenna Requirement	PASS

1.3. Test Facility

1.3.1 Address of the test laboratory

Shenzhen CTL Testing Technology Co., Ltd.

Floor 1-A, Baisha Technology Park, No. 3011, Shahexi Road, Nanshan, Shenzhen 518055 China

There is one 3m semi-anechoic chamber and two line conducted labs for final test. The Test Sites meet the requirements in documents ANSI C63.4 and CISPR 32/EN 55032 requirements.

1.3.2 Laboratory accreditation

The test facility is recognized, certified, or accredited by the following organizations:

CNAS-Lab Code: L7497

Shenzhen CTL Testing Technology Co., Ltd. has been assessed and proved to be in compliance with CNAS-CL01 Accreditation Criteria for Testing and Calibration Laboratories (identical to ISO/IEC 17025: 2005 General Requirements) for the Competence of Testing and Calibration Laboratories.

A2LA-Lab Cert. No. 4343.01

Shenzhen CTL Testing Technology Co., Ltd. EMC Laboratory has been accredited by A2LA for technical competence in the field of electrical testing, and proved to be in compliance with ISO/IEC 17025: 2005 General Requirements for the Competence of Testing and Calibration Laboratories and any additional program requirements in the identified field of testing.

IC Registration No.: 9518B

CAB identifier: CN0041

The 3m alternate test site of Shenzhen CTL Testing Technology Co., Ltd. EMC Laboratory has been registered by Innovation, Science and Economic Development Canada to test to Canadian radio equipment requirements with Registration No.: 9518B on Jan. 22, 2019.

FCC-Registration No.: 399832

Designation No.: CN1216

Shenzhen CTL Testing Technology Co., Ltd. EMC Laboratory has been registered and fully described in a report filed with the (FCC) Federal Communications Commission. The acceptance letter from the FCC is maintained in our files. Registration 399832, December 08, 2017.

1.4. Statement of the measurement uncertainty

The data and results referenced in this document are true and accurate. The reader is cautioned that there may be errors within the calibration limits of the equipment and facilities. The measurement uncertainty was calculated for all measurements listed in this test report acc. to CISPR 16 - 4 "Specification for radio disturbance and immunity measuring apparatus and methods – Part 4: Uncertainty in EMC Measurements" and is documented in the Shenzhen CTL Testing Technology Co., Ltd. quality system acc. to DIN EN ISO/IEC 17025. Furthermore, component and process variability of devices similar to that tested may result in additional deviation. The manufacturer has the sole responsibility of continued compliance of the device.

Hereafter the best measurement capability for CTL laboratory is reported:

Test	Measurement Uncertainty	Notes
Transmitter power conducted	±0.57 dB	(1)
Transmitter power Radiated	±2.20 dB	(1)
Conducted spurious emission 9KHz-40 GHz	±2.20 dB	(1)
Occupied Bandwidth	±0.01ppm	(1)
Radiated Emission 30~1000MHz	±4.10dB	(1)
Radiated Emission Above 1GHz	±4.32dB	(1)

Conducted Disturbance0.15~30MHz	$\pm 3.20\text{dB}$	(1)
---------------------------------	---------------------	-----

(1) This uncertainty represents an expanded uncertainty expressed at approximately the 95% confidence level using a coverage factor of $k=2$.

2. GENERAL INFORMATION

2.1. Environmental conditions

During the measurement the environmental conditions were within the listed ranges:

Normal Temperature:	25°C
Relative Humidity:	55 %
Air Pressure:	101 kPa

2.2. General Description of EUT

Product Name:	Bluetooth headphones
Model/Type reference:	T22
Power supply:	DC 3.7V from battery
Charger base information:	Model:T22 Input: 5V---1A Output: 5V---0.25A
Bluetooth LE	
Supported type:	Bluetooth low Energy
Modulation:	GFSK
Operation frequency:	2402MHz to 2480MHz
Channel number:	40
Channel separation:	2 MHz
Antenna type:	FPC Antenna
Antenna gain:	0dBi

Note: For more details, please refer to the user's manual of the EUT.

2.3. Description of Test Modes and Test Frequency

The Applicant provides communication tools software to control the EUT for staying in continuous transmitting (Duty Cycle more than 98%) and receiving mode for testing.

There are 39 channels provided to the EUT and Channel 00/19/39 were selected for BLE test.

Operation Frequency List(LE1M&LE2M) :

Channel	Frequency (MHz)
00	2402
02	2404
03	2406
⋮	⋮
19	2440
⋮	⋮
37	2476
38	2478
39	2480

Note: The line display in grey were the channel selected for testing

2.4. Equipments Used during the Test

Test Equipment	Manufacturer	Model No.	Serial No.	Calibration Date	Calibration Due Date
LISN	R&S	ENV216	3560.6550.1 2	2019/05/20	2020/05/19
LISN	R&S	ESH2-Z5	860014/010	2019/05/20	2020/05/19
Bilog Antenna	Sunol Sciences Corp.	JB1	A061713	2019/05/20	2020/05/19
EMI Test Receiver	R&S	ESCI	1166.5950.03	2019/05/20	2020/05/19
Spectrum Analyzer	Agilent	E4407B	MY41440676	2019/05/20	2020/05/19
Spectrum Analyzer	Agilent	N9020	US46220290	2019/05/20	2020/05/19
Spectrum Analyzer	Keysight	N9020A	MY53420874	2019/05/20	2020/05/19
Controller	EM Electronics	EM 1000	060859	2019/05/20	2020/05/19
Horn Antenna	Sunol Sciences Corp.	DRH-118	A062013	2019/05/20	2020/05/19
Active Loop Antenna	Da Ze	ZN30900A	/	2019/05/20	2020/05/19
Amplifier	Agilent	8449B	3008A02306	2019/05/20	2020/05/19
Amplifier	Agilent	8447D	2944A10176	2019/05/20	2020/05/19
Temperature/Humidity Meter	Gangxing	CTH-608	02	2019/05/20	2020/05/19
High-Pass Filter	micro-tranics	HPM50108	G174	2019/05/20	2020/05/19
High-Pass Filter	micro-tranics	HPM50111	G142	2019/05/20	2020/05/19
Coaxial Cables	HUBER+SUHNER	SUCOFLEX 104PEA-10M	10m	2019/05/20	2020/05/19
Coaxial Cables	HUBER+SUHNER	SUCOFLEX 104PEA-3M	3m	2019/05/20	2020/05/19
Coaxial Cables	HUBER+SUHNER	SUCOFLEX 104PEA-3M	3m	2019/05/20	2020/05/19
RF Cable	Megalon	RF-A303	N/A	2019/05/20	2020/05/19
Power Sensor	Agilent	U2021XA	MY5365004	2019/05/20	2020/05/19
Power Sensor	Agilent	U2531A	TW53323507	2019/05/20	2020/05/19

The calibration interval was one year

2.5. Related Submittal(s) / Grant (s)

This submittal(s) (test report) is intended to comply with Section 15.247 of the FCC Part 15, Subpart C Rules.

2.6. Modifications

No modifications were implemented to meet testing criteria.

3. TEST CONDITIONS AND RESULTS

3.1. Conducted Emissions Test

LIMIT

FCC CFR Title 47 Part 15 Subpart C Section 15.207

Frequency range (MHz)	Limit (dBuV)	
	Quasi-peak	Average
0.15-0.5	66 to 56*	56 to 46*
0.5-5	56	46
5-30	60	50

* Decreases with the logarithm of the frequency.

TEST CONFIGURATION

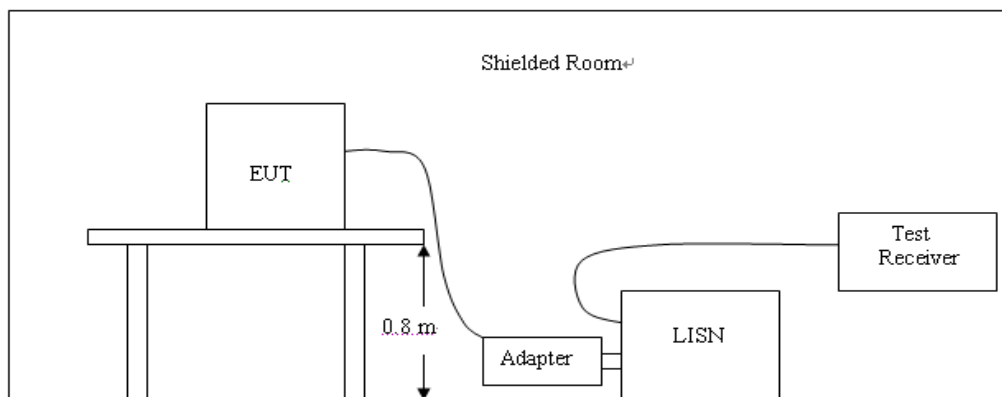

TEST PROCEDURE

1. The equipment was set up as per the test configuration to simulate typical actual usage per the user's manual. The EUT is a tabletop system; a wooden table with a height of 0.8 meters is used and is placed on the ground plane as per ANSI C63.10:2013.
2. Support equipment, if needed, was placed as per ANSI C63.10:2013.
3. All I/O cables were positioned to simulate typical actual usage as per ANSI C63.10:2013.
4. The adapter received AC120V/60Hz power through a Line Impedance Stabilization Network (LISN) which supplied power source and was grounded to the ground plane.
5. All support equipments received AC power from a second LISN, if any.
6. The EUT test program was started. Emissions were measured on each current carrying line of the EUT using a spectrum Analyzer / Receiver connected to the LISN powering the EUT. The LISN has two monitoring points: Line 1 (Hot Side) and Line 2 (Neutral Side). Two scans were taken: one with Line 1 connected to Analyzer / Receiver and Line 2 connected to a 50 ohm load; the second scan had Line 1 connected to a 50 ohm load and Line 2 connected to the Analyzer / Receiver.
7. Analyzer / Receiver scanned from 150 KHz to 30MHz for emissions in each of the test modes.
8. During the above scans, the emissions were maximized by cable manipulation.

TEST RESULTS

We have tested LE1M and LE2M low channel, middle channel, high channel, only recorded worst at LE1M low channel.

SCAN TABLE: "Voltage (9K-30M) FIN"

Short Description: 150K-30M Voltage

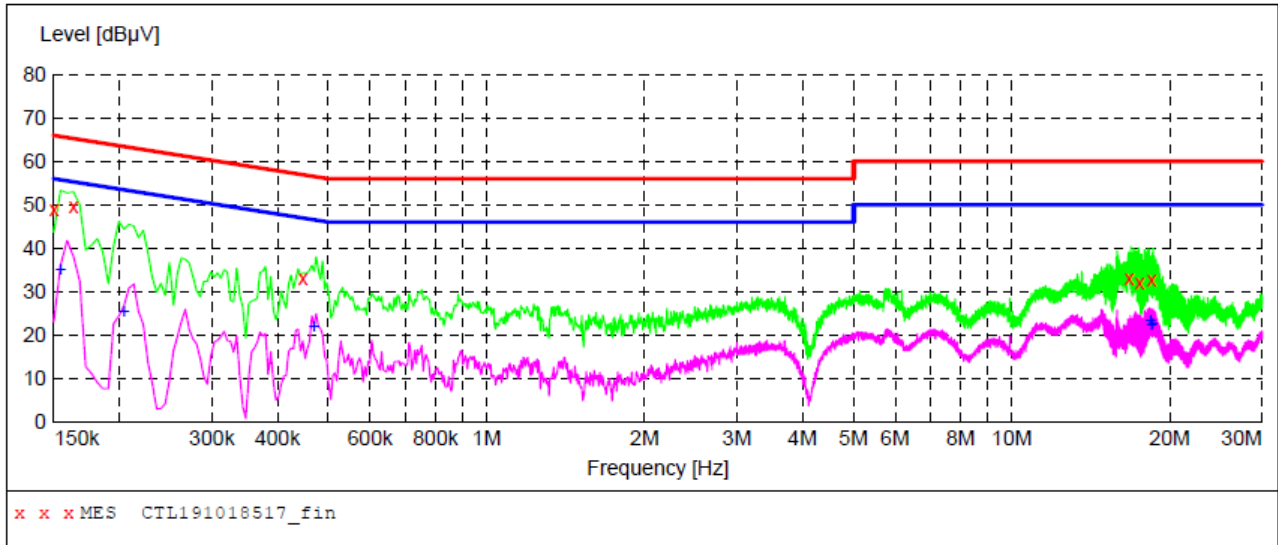

MEASUREMENT RESULT: "CTL191018517_fin"

10/18/2019 2:57PM

Frequency MHz	Level dBµV	Transd dB	Limit dBµV	Margin dB	Detector	Line	PE
0.150000	48.90	10.1	66	17.1	QP	L1	GND
0.163500	49.60	10.1	65	15.7	QP	L1	GND
0.447000	33.10	10.1	57	23.8	QP	L1	GND
16.755000	33.00	11.0	60	27.0	QP	L1	GND
17.529000	32.20	11.0	60	27.8	QP	L1	GND
18.460500	32.80	11.0	60	27.2	QP	L1	GND

MEASUREMENT RESULT: "CTL191018517_fin2"

10/18/2019 2:57PM

Frequency MHz	Level dBµV	Transd dB	Limit dBµV	Margin dB	Detector	Line	PE
0.154500	35.20	10.1	56	20.6	AV	L1	GND
0.204000	25.40	10.1	53	28.0	AV	L1	GND
0.469500	22.10	10.1	47	24.4	AV	L1	GND
18.352500	23.30	11.0	50	26.7	AV	L1	GND
18.429000	22.50	11.0	50	27.5	AV	L1	GND
18.510000	22.60	11.0	50	27.4	AV	L1	GND

SCAN TABLE: "Voltage (9K-30M)FIN"

Short Description: 150K-30M Voltage

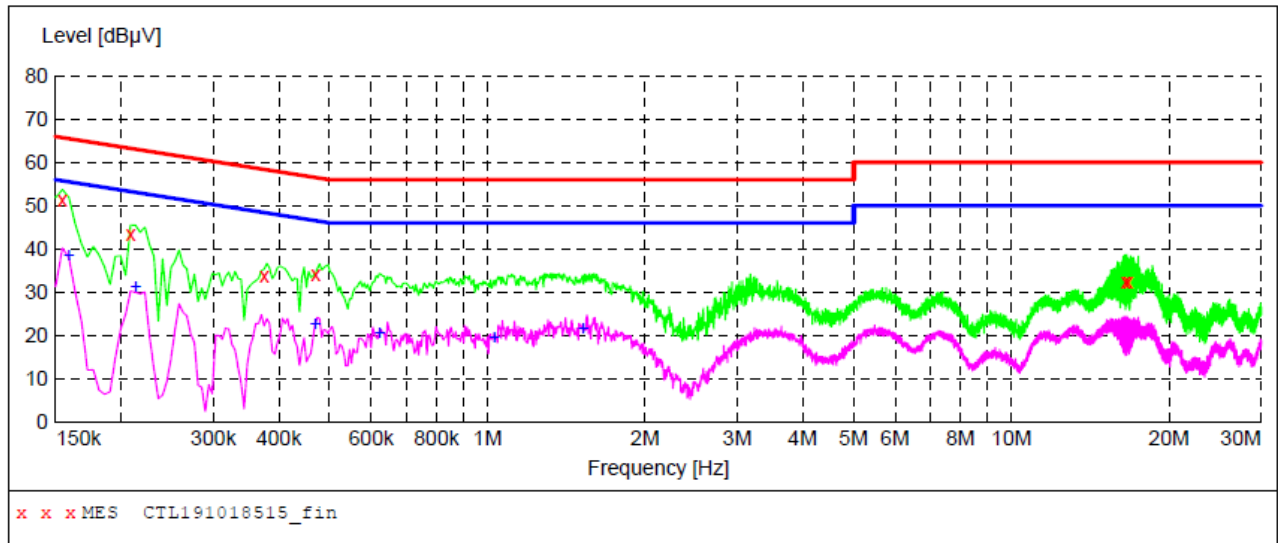

MEASUREMENT RESULT: "CTL191018515_fin"

10/18/2019 2:54PM

Frequency MHz	Level dBuV	Transd dB	Limit dBuV	Margin dB	Detector	Line	PE
0.154500	51.50	10.1	66	14.3	QP	N	GND
0.208500	43.50	10.1	63	19.8	QP	N	GND
0.375000	33.90	10.1	58	24.5	QP	N	GND
0.469500	34.10	10.1	57	22.4	QP	N	GND
16.494000	32.30	11.0	60	27.7	QP	N	GND
16.710000	32.30	11.0	60	27.7	QP	N	GND

MEASUREMENT RESULT: "CTL191018515_fin2"

10/18/2019 2:54PM

Frequency MHz	Level dBuV	Transd dB	Limit dBuV	Margin dB	Detector	Line	PE
0.159000	38.60	10.1	56	16.9	AV	N	GND
0.213000	31.30	10.1	53	21.8	AV	N	GND
0.469500	22.60	10.1	47	23.9	AV	N	GND
0.622500	20.50	10.1	46	25.5	AV	N	GND
1.032000	19.60	10.2	46	26.4	AV	N	GND
1.522500	21.60	10.2	46	24.4	AV	N	GND

3.2. Radiated Emissions and Band Edge

Limit

For intentional device, according to § 15.209(a), the general requirement of field strength of radiated emission out of authorized band shall not exceed the following table at a 3 meters measurement distance.

In addition, radiated emissions which fall in the restricted bands, as defined in §15.205(a), must also comply with the radiated emission limits specified in §15.209(a)

Radiated emission limits

Frequency (MHz)	Distance (Meters)	Radiated (dBµV/m)	Radiated (µV/m)
0.009-0.49	3	$20\log(2400/F(KHz))+40\log(300/3)$	$2400/F(KHz)$
0.49-1.705	3	$20\log(24000/F(KHz))+ 40\log(30/3)$	$24000/F(KHz)$
1.705-30	3	$20\log(30)+ 40\log(30/3)$	30
30-88	3	40.0	100
88-216	3	43.5	150
216-960	3	46.0	200
Above 960	3	54.0	500

TEST CONFIGURATION

(A) Radiated Emission Test Set-Up, Frequency Below 30MHz

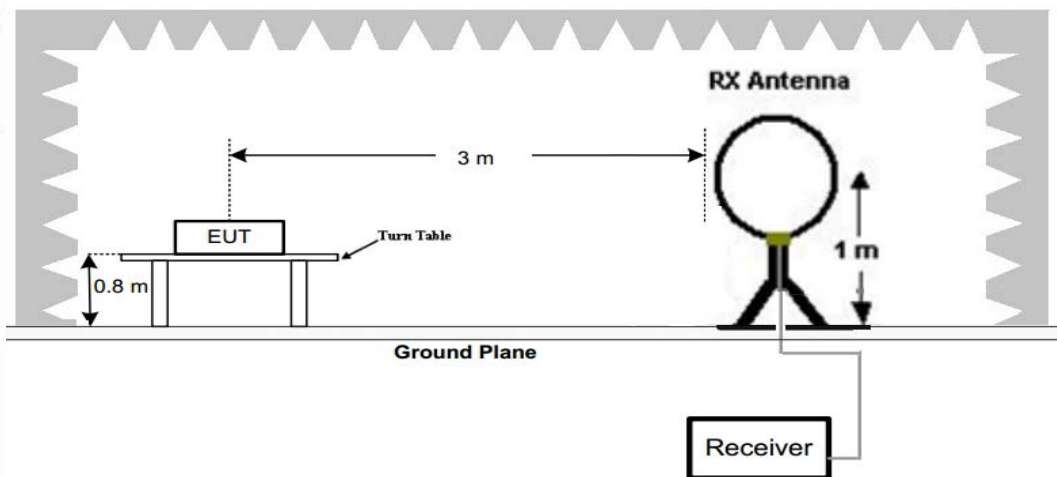

(B) Radiated Emission Test Set-Up, Frequency below 1000MHz

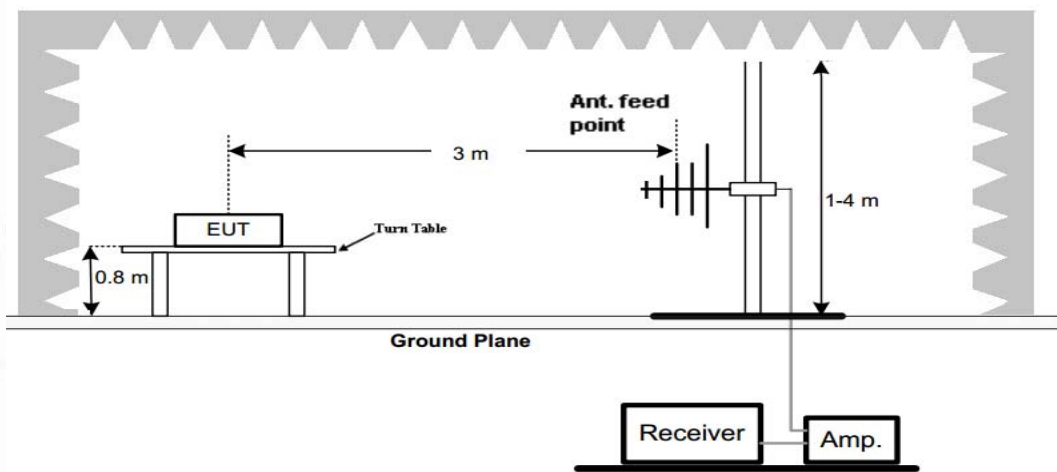

(C) Radiated Emission Test Set-Up, Frequency above 1000MHz

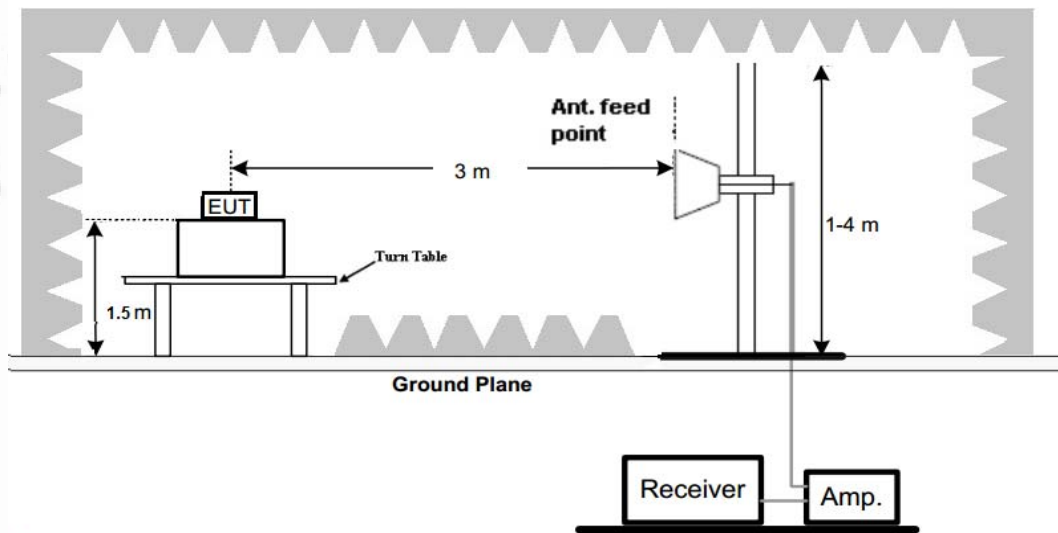

Test Procedure

1. Below 1GHz measurement the EUT is placed on a turntable which is 0.8m above ground plane, and above 1GHz measurement EUT was placed on a low permittivity and low loss tangent turn table which is 1.5m above ground plane.
2. Maximum procedure was performed by raising the receiving antenna from 1m to 4m and rotating the turn table from 0° to 360° to acquire the highest emissions from EUT
3. And also, each emission was to be maximized by changing the polarization of receiving antenna both horizontal and vertical.
4. Repeat above procedures until all frequency measurements have been completed.

TEST RESULTS

Remark:

1. We have tested LE1M and LE2M low channel, middle channel, high channel, only recorded worst at LE1M low channel.
2. Radiated emission test from 9 KHz to 10th harmonic of fundamental was verified, and no emission found except system noise floor in 9 KHz to 30MHz and not recorded in this report.

For 30MHz-1GHz

Horizontal

SWEEP TABLE: "test (30M-1G)"

Short Description:		Field Strength			
Start	Stop	Detector	Meas. Time	IF Bandw.	Transducer
30.0 MHz	1.0 GHz	MaxPeak	300.0 ms	120 kHz	VULB9168

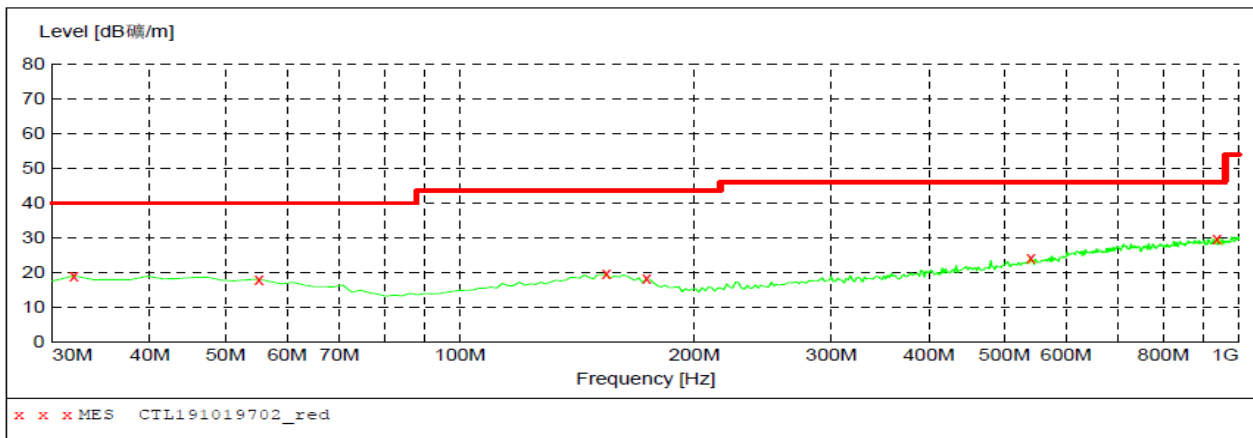

MEASUREMENT RESULT: "CTL191019702_red"

2019-10-19 8:58

Frequency MHz	Level dBμV/m	Transd dB	Limit dBμV/m	Margin dB	Det.	Height cm	Azimuth deg	Polarization
31.940000	19.00	13.9	40.0	21.0	---	0.0	0.00	HORIZONTAL
55.220000	18.00	13.8	40.0	22.0	---	0.0	0.00	HORIZONTAL
154.160000	19.50	15.2	43.5	24.0	---	0.0	0.00	HORIZONTAL
173.560000	18.10	13.7	43.5	25.4	---	0.0	0.00	HORIZONTAL
540.220000	24.20	18.9	46.0	21.8	---	0.0	0.00	HORIZONTAL
935.980000	29.80	24.1	46.0	16.2	---	0.0	0.00	HORIZONTAL

Vertical

SWEEP TABLE: "test (30M-1G)"

Short Description:		Field Strength			
Start	Stop	Detector	Meas. Time	IF Bandw.	Transducer
30.0 MHz	1.0 GHz	MaxPeak	300.0 ms	120 kHz	VULB9168

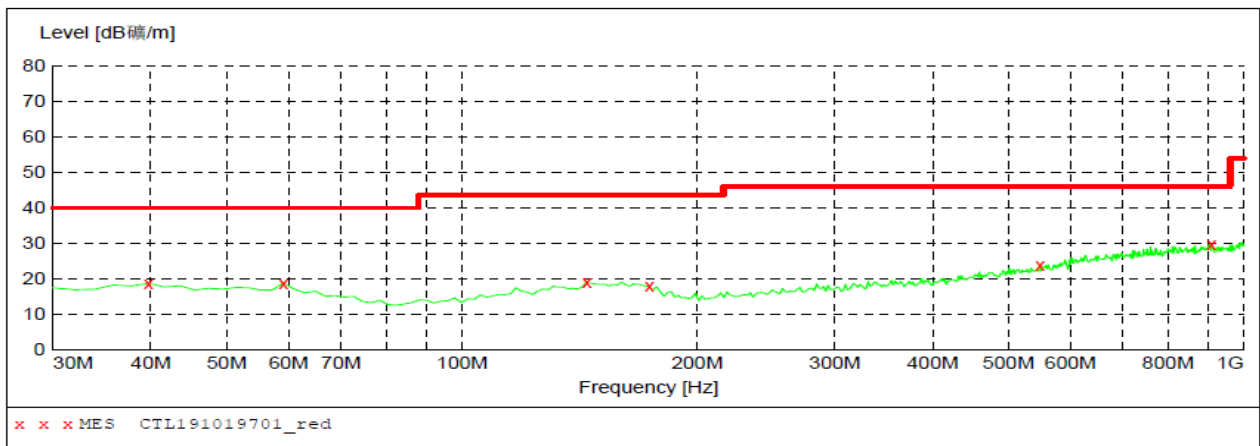

MEASUREMENT RESULT: "CTL191019701_red"

2019-10-19 8:56

Frequency MHz	Level dBμV/m	Transd dB	Limit dBμV/m	Margin dB	Det.	Height cm	Azimuth deg	Polarization
39.700000	18.70	14.8	40.0	21.3	---	0.0	0.00	VERTICAL
59.100000	18.70	13.5	40.0	21.3	---	0.0	0.00	VERTICAL
144.460000	19.00	14.8	43.5	24.5	---	0.0	0.00	VERTICAL
173.560000	17.80	13.7	43.5	25.7	---	0.0	0.00	VERTICAL
547.980000	23.60	19.1	46.0	22.4	---	0.0	0.00	VERTICAL
908.820000	29.70	23.9	46.0	16.3	---	0.0	0.00	VERTICAL

For 1GHz to 25GHz

LE1M Mode (above 1GHz)

Frequency(MHz):			2402		Polarity:			HORIZONTAL	
Frequency (MHz)	Emission Level (dBuV/m)		Limit (dBuV/m)	Margin (dB)	Raw Value (dBuV)	Antenna Factor (dB/m)	Cable Factor (dB)	Pre-amplifier (dB)	Correction Factor (dB/m)
4804.00	51.33	PK	74.00	22.67	46.82	33.49	6.91	35.89	4.51
4804.00	--	AV	54.00	--	--	--	--	--	--
5127.15	43.91	PK	74.00	30.09	36.70	34.38	7.10	34.27	7.21
5127.15	--	AV	54.00	--	--	--	--	--	--
7206.00	46.75	PK	74.00	27.25	35.65	36.95	9.18	35.03	11.10
7206.00	--	AV	54.00	--	--	--	--	--	--

Frequency(MHz):			2402		Polarity:			VERTICAL	
Frequency (MHz)	Emission Level (dBuV/m)		Limit (dBuV/m)	Margin (dB)	Raw Value (dBuV)	Antenna Factor (dB/m)	Cable Factor (dB)	Pre-amplifier (dB)	Correction Factor (dB/m)
4804.00	50.83	PK	74.00	23.17	46.32	33.49	6.91	35.89	4.51
4804.00	--	AV	54.00	--	--	--	--	--	--
5127.15	42.95	PK	74.00	31.05	35.39	34.69	7.23	34.36	7.56
5127.15	--	AV	54.00	--	--	--	--	--	--
7206.00	47.03	PK	74.00	26.97	35.93	36.95	9.18	35.03	11.10
7206.00	--	AV	54.00	--	--	--	--	--	--

Frequency(MHz):			2440		Polarity:			HORIZONTAL	
Frequency (MHz)	Emission Level (dBuV/m)		Limit (dBuV/m)	Margin (dB)	Raw Value (dBuV)	Antenna Factor (dB/m)	Cable Factor (dB)	Pre-amplifier (dB)	Correction Factor (dB/m)
4880.00	48.91	PK	74.00	25.09	42.66	33.60	6.95	34.30	6.25
4880.00	--	AV	54.00	--	--	--	--	--	--
5236.75	43.74	PK	74.00	30.26	36.11	34.57	7.16	34.10	7.63
5236.75	--	AV	54.00	--	--	--	--	--	--
7320.00	46.97	PK	74.00	27.03	35.28	37.46	9.23	35.00	11.69
7320.00	--	AV	54.00	--	--	--	--	--	--

Frequency(MHz):			2440		Polarity:			VERTICAL	
Frequency (MHz)	Emission Level (dBuV/m)		Limit (dBuV/m)	Margin (dB)	Raw Value (dBuV)	Antenna Factor (dB/m)	Cable Factor (dB)	Pre-amplifier (dB)	Correction Factor (dB/m)
4880.00	49.16	PK	74.00	24.84	42.91	33.60	6.95	34.30	6.25
4880.00	--	AV	54.00	--	--	--	--	--	--
5235.75	43.62	PK	74.00	30.38	35.98	34.58	7.16	34.10	7.64
5235.75	--	AV	54.00	--	--	--	--	--	--
7320.00	46.54	PK	74.00	27.46	34.85	37.46	9.23	35.00	11.69
7320.00	--	AV	54.00	--	--	--	--	--	--

Frequency(MHz):			2480		Polarity:			HORIZONTAL	
Frequency (MHz)	Emission Level (dBuV/m)		Limit (dBuV/m)	Margin (dB)	Raw Value (dBuV)	Antenna Factor (dB/m)	Cable Factor (dB)	Pre-amplifier (dB)	Correction Factor (dB/m)
4960.00	48.99	PK	74.00	25.01	44.07	33.84	7.00	35.92	4.92
4960.00	--	AV	54.00	--	--	--	--	--	--
5325.50	43.12	PK	74.00	30.88	35.58	34.67	7.22	34.35	7.54
5325.50	--	AV	54.00	--	--	--	--	--	--
7440.00	46.71	PK	74.00	27.29	34.76	37.64	9.28	34.97	11.95
7440.00	--	AV	54.00	--	--	--	--	--	--

Frequency(MHz):			2480		Polarity:			VERTICAL	
Frequency (MHz)	Emission Level (dBuV/m)		Limit (dBuV/m)	Margin (dB)	Raw Value (dBuV)	Antenna Factor (dB/m)	Cable Factor (dB)	Pre-amplifier (dB)	Correction Factor (dB/m)
4960.00	47.41	PK	74.00	26.59	42.49	33.84	7.00	35.92	4.92
4960.00	--	AV	54.00	--	--	--	--	--	--
5325.25	43.96	PK	74.00	30.04	36.77	34.36	7.10	34.27	7.19
5325.25	--	AV	54.00	--	--	--	--	--	--
7440.00	46.38	PK	74.00	27.62	34.43	37.64	9.28	34.97	11.95
7440.00	--	AV	54.00	--	--	--	--	--	--

LE2M Mode (above 1GHz)

Frequency(MHz):			2402		Polarity:			HORIZONTAL	
Frequency (MHz)	Emission Level (dBuV/m)		Limit (dBuV/m)	Margin (dB)	Raw Value (dBuV)	Antenna Factor (dB/m)	Cable Factor (dB)	Pre-amplifier (dB)	Correction Factor (dB/m)
4804.00	49.17	PK	74.00	24.83	44.66	33.49	6.91	35.89	4.51
4804.00	--	AV	54.00	--	--	--	--	--	--
5122.50	42.98	PK	74.00	31.02	35.77	34.38	7.10	34.27	7.21
5122.50	--	AV	54.00	--	--	--	--	--	--
7206.00	47.15	PK	74.00	26.85	36.05	36.95	9.18	35.03	11.10
7206.00	--	AV	54.00	--	--	--	--	--	--

Frequency(MHz):			2402		Polarity:			VERTICAL	
Frequency (MHz)	Emission Level (dBuV/m)		Limit (dBuV/m)	Margin (dB)	Raw Value (dBuV)	Antenna Factor (dB/m)	Cable Factor (dB)	Pre-amplifier (dB)	Correction Factor (dB/m)
4804.00	49.65	PK	74.00	24.35	45.14	33.49	6.91	35.89	4.51
4804.00	--	AV	54.00	--	--	--	--	--	--
5122.50	43.06	PK	74.00	30.94	35.50	34.69	7.23	34.36	7.56
5122.50	--	AV	54.00	--	--	--	--	--	--
7206.00	48.13	PK	74.00	25.87	37.03	36.95	9.18	35.03	11.10
7206.00	--	AV	54.00	--	--	--	--	--	--

Frequency(MHz):			2440		Polarity:			HORIZONTAL	
Frequency (MHz)	Emission Level (dBuV/m)		Limit (dBuV/m)	Margin (dB)	Raw Value (dBuV)	Antenna Factor (dB/m)	Cable Factor (dB)	Pre-amplifier (dB)	Correction Factor (dB/m)
4880.00	47.73	PK	74.00	26.27	41.48	33.60	6.95	34.30	6.25
4880.00	--	AV	54.00	--	--	--	--	--	--
5233.75	43.68	PK	74.00	30.32	36.05	34.57	7.16	34.10	7.63
5233.75	--	AV	54.00	--	--	--	--	--	--
7320.00	46.44	PK	74.00	27.56	34.75	37.46	9.23	35.00	11.69
7320.00	--	AV	54.00	--	--	--	--	--	--

Frequency(MHz):			2440		Polarity:			VERTICAL	
Frequency (MHz)	Emission Level (dBuV/m)		Limit (dBuV/m)	Margin (dB)	Raw Value (dBuV)	Antenna Factor (dB/m)	Cable Factor (dB)	Pre-amplifier (dB)	Correction Factor (dB/m)
4880.00	48.93	PK	74.00	25.07	42.68	33.60	6.95	34.30	6.25
4880.00	--	AV	54.00	--	--	--	--	--	--
5235.75	42.15	PK	74.00	31.85	34.51	34.58	7.16	34.10	7.64
5235.75	--	AV	54.00	--	--	--	--	--	--
7320.00	46.78	PK	74.00	27.22	35.09	37.46	9.23	35.00	11.69
7320.00	--	AV	54.00	--	--	--	--	--	--

Frequency(MHz):			2480		Polarity:			HORIZONTAL	
Frequency (MHz)	Emission Level (dBuV/m)		Limit (dBuV/m)	Margin (dB)	Raw Value (dBuV)	Antenna Factor (dB/m)	Cable Factor (dB)	Pre-amplifier (dB)	Correction Factor (dB/m)
4960.00	48.56	PK	74.00	25.44	43.64	33.84	7.00	35.92	4.92
4960.00	--	AV	54.00	--	--	--	--	--	--
5325.50	43.11	PK	74.00	30.89	35.57	34.67	7.22	34.35	7.54
5325.50	--	AV	54.00	--	--	--	--	--	--
7440.00	47.35	PK	74.00	26.65	35.40	37.64	9.28	34.97	11.95
7440.00	--	AV	54.00	--	--	--	--	--	--

Frequency(MHz):			2480		Polarity:			VERTICAL	
Frequency (MHz)	Emission Level (dBuV/m)		Limit (dBuV/m)	Margin (dB)	Raw Value (dBuV)	Antenna Factor (dB/m)	Cable Factor (dB)	Pre-amplifier (dB)	Correction Factor (dB/m)
4960.00	49.13	PK	74.00	24.87	44.21	33.84	7.00	35.92	4.92
4960.00	--	AV	54.00	--	--	--	--	--	--
5115.25	43.74	PK	74.00	30.26	36.55	34.36	7.10	34.27	7.19
5115.25	--	AV	54.00	--	--	--	--	--	--
7440.00	48.38	PK	74.00	25.62	36.43	37.64	9.28	34.97	11.95
7440.00	--	AV	54.00	--	--	--	--	--	--

REMARKS:

1. Emission level (dBuV/m) = Raw Value (dBuV) + Correction Factor (dB/m)
2. Correction Factor (dB/m) = Antenna Factor (dB/m) + Cable Factor (dB) - Pre-amplifier Factor
3. Margin value = Limit value - Emission level.
4. -- Mean the PK detector measured value is below average limit.
5. The other emission levels were very low against the limit.
6. RBW1MHz VBW3MHz Peak detector is for PK value; RBW 1MHz VBW10Hz Peak detector is for AV value.

Results of Band Edges Test (Radiated)**LE1M**

Frequency(MHz):			2402		Polarity:			HORIZONTAL	
Frequency (MHz)	Emission Level (dBuV/m)		Limit (dBuV/m)	Margin (dB)	Raw Value (dBuV)	Antenna Factor (dB/m)	Cable Factor (dB)	Pre-amplifier (dB)	Correction Factor (dB/m)
2402.00	96.35	PK	--	--	62.96	28.78	4.61	0.00	33.39
2402.00	91.48	AV	--	--	58.09	28.78	4.61	0.00	33.39
2360.75	43.51	PK	74.00	30.49	10.43	28.52	4.56	0.00	33.08
2360.75	--	AV	54.00	--	--	--	--	--	--
2390.00	46.72	PK	74.00	27.28	13.40	28.72	4.60	0.00	33.32
2390.00	--	AV	54.00	--	--	--	--	--	--
2400.00	47.34	PK	74.00	26.66	13.95	28.78	4.61	0.00	33.39
2400.00	--	AV	54.00	--	--	--	--	--	--

Frequency(MHz):			2402		Polarity:			VERTICAL	
Frequency (MHz)	Emission Level (dBuV/m)		Limit (dBuV/m)	Margin (dB)	Raw Value (dBuV)	Antenna Factor (dB/m)	Cable Factor (dB)	Pre-amplifier (dB)	Correction Factor (dB/m)
2402.00	97.58	PK	--	--	64.19	28.78	4.61	0.00	33.39
2402.00	91.26	AV	--	--	57.87	28.78	4.61	0.00	33.39
2360.75	43.41	PK	74.00	30.59	10.33	28.52	4.56	0.00	33.08
2360.75	--	AV	54.00	--	--	--	--	--	--
2390.00	46.66	PK	74.00	27.34	13.34	28.72	4.60	0.00	33.32
2390.00	--	AV	54.00	--	--	--	--	--	--
2400.00	48.52	PK	74.00	25.48	15.13	28.78	4.61	0.00	33.39
2400.00	--	AV	54.00	--	--	--	--	--	--

Frequency(MHz):			2480		Polarity:			HORIZONTAL	
Frequency (MHz)	Emission Level (dBuV/m)		Limit (dBuV/m)	Margin (dB)	Raw Value (dBuV)	Antenna Factor (dB/m)	Cable Factor (dB)	Pre-amplifier (dB)	Correction Factor (dB/m)
2480.00	96.68	PK	--	--	63.06	28.92	4.70	0.00	33.62
2480.00	90.44	AV	--	--	56.82	28.92	4.70	0.00	33.62
2483.50	43.59	PK	74.00	30.41	9.96	28.93	4.70	0.00	33.63
2483.50	--	AV	54.00	--	--	--	--	--	--
2491.95	43.12	PK	74.00	30.88	9.46	28.95	4.71	0.00	33.66
2491.95	--	AV	54.00	--	--	--	--	--	--
2500.00	44.01	PK	74.00	29.99	10.33	28.96	4.72	0.00	33.68
2500.00	--	AV	54.00	--	--	--	--	--	--

Frequency(MHz):			2480		Polarity:			VERTICAL	
Frequency (MHz)	Emission Level (dBuV/m)		Limit (dBuV/m)	Margin (dB)	Raw Value (dBuV)	Antenna Factor (dB/m)	Cable Factor (dB)	Pre-amplifier (dB)	Correction Factor (dB/m)
2480.00	97.04	PK	--	--	63.42	28.92	4.70	0.00	33.62
2480.00	91.36	AV	--	--	57.74	28.92	4.70	0.00	33.62
2483.50	43.17	PK	74.00	30.83	9.54	28.93	4.70	0.00	33.63
2483.50	--	AV	54.00	--	--	--	--	--	--
2489.05	42.75	PK	74.00	31.25	9.09	28.95	4.71	0.00	33.66
2489.05	--	AV	54.00	--	--	--	--	--	--
2500.00	43.25	PK	74.00	30.75	9.57	28.96	4.72	0.00	33.68
2500.00	--	AV	54.00	--	--	--	--	--	--

LE2M

Frequency(MHz):			2402		Polarity:			HORIZONTAL	
Frequency (MHz)	Emission Level (dBuV/m)		Limit (dBuV/m)	Margin (dB)	Raw Value (dBuV)	Antenna Factor (dB/m)	Cable Factor (dB)	Pre-amplifier (dB)	Correction Factor (dB/m)
2402.00	96.98	PK	--	--	63.59	28.78	4.61	0.00	33.39
2402.00	90.33	AV	--	--	56.94	28.78	4.61	0.00	33.39
2349.75	43.61	PK	74.00	30.39	10.53	28.52	4.56	0.00	33.08
2349.75	--	AV	54.00	--	--	--	--	--	--
2390.00	42.72	PK	74.00	31.28	9.40	28.72	4.60	0.00	33.32
2390.00	--	AV	54.00	--	--	--	--	--	--
2400.00	43.85	PK	74.00	30.15	10.46	28.78	4.61	0.00	33.39
2400.00	--	AV	54.00	--	--	--	--	--	--

Frequency(MHz):			2402		Polarity:			VERTICAL	
Frequency (MHz)	Emission Level (dBuV/m)		Limit (dBuV/m)	Margin (dB)	Raw Value (dBuV)	Antenna Factor (dB/m)	Cable Factor (dB)	Pre-amplifier (dB)	Correction Factor (dB/m)
2402.00	96.34	PK	--	--	62.95	28.78	4.61	0.00	33.39
2402.00	90.12	AV	--	--	56.73	28.78	4.61	0.00	33.39
2349.75	45.48	PK	74.00	28.52	12.40	28.52	4.56	0.00	33.08
2349.75	--	AV	54.00	--	--	--	--	--	--
2390.00	43.73	PK	74.00	30.27	10.41	28.72	4.60	0.00	33.32
2390.00	--	AV	54.00	--	--	--	--	--	--
2400.00	42.96	PK	74.00	31.04	9.57	28.78	4.61	0.00	33.39
2400.00	--	AV	54.00	--	--	--	--	--	--

Frequency(MHz):			2480		Polarity:			HORIZONTAL	
Frequency (MHz)	Emission Level (dBuV/m)		Limit (dBuV/m)	Margin (dB)	Raw Value (dBuV)	Antenna Factor (dB/m)	Cable Factor (dB)	Pre-amplifier (dB)	Correction Factor (dB/m)
2480.00	97.51	PK	--	--	63.89	28.92	4.70	0.00	33.62
2480.00	91.65	AV	--	--	58.03	28.92	4.70	0.00	33.62
2483.50	43.43	PK	74.00	30.57	9.80	28.93	4.70	0.00	33.63
2483.50	--	AV	54.00	--	--	--	--	--	--
2491.95	43.92	PK	74.00	30.08	10.26	28.95	4.71	0.00	33.66
2491.95	--	AV	54.00	--	--	--	--	--	--
2500.00	43.06	PK	74.00	30.94	9.38	28.96	4.72	0.00	33.68
2500.00	--	AV	54.00	--	--	--	--	--	--

Frequency(MHz):			2480		Polarity:			VERTICAL	
Frequency (MHz)	Emission Level (dBuV/m)		Limit (dBuV/m)	Margin (dB)	Raw Value (dBuV)	Antenna Factor (dB/m)	Cable Factor (dB)	Pre-amplifier (dB)	Correction Factor (dB/m)
2480.00	96.92	PK	--	--	63.30	28.92	4.70	0.00	33.62
2480.00	90.84	AV	--	--	57.22	28.92	4.70	0.00	33.62
2483.50	43.43	PK	74.00	30.57	9.80	28.93	4.70	0.00	33.63
2483.50	--	AV	54.00	--	--	--	--	--	--
2489.05	42.88	PK	74.00	31.12	9.22	28.95	4.71	0.00	33.66
2489.05	--	AV	54.00	--	--	--	--	--	--
2500.00	44.13	PK	74.00	29.87	10.45	28.96	4.72	0.00	33.68
2500.00	--	AV	54.00	--	--	--	--	--	--

REMARKS:

1. Emission level (dBuV/m) =Raw Value (dBuV)+Correction Factor (dB/m)
2. Correction Factor (dB/m) = Antenna Factor (dB/m)+Cable Factor (dB)-Pre-amplifier Factor
3. Margin value = Limit value- Emission level.
4. -- Mean the PK detector measured value is below average limit.
5. The other emission levels were very low against the limit.
6. RBW1MHz VBW3MHz Peak detector is for PK value; RBW 1MHz VBW10Hz Peak detector is for AV value.
7. For fundamental frequency, RBW 3MHz VBW 3MHz Peak detector is for PK Value; RMS detector is for AV value.

3.3. Maximum Conducted Output Power

Limit

The Maximum Peak Output Power Measurement is 30dBm.

Test Procedure

Remove the antenna from the EUT and then connect a low loss RF cable from the antenna port to the power sensor.

Test Configuration

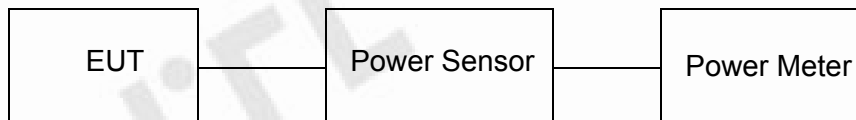

Test Results

LE1M

Type	Channel	Output power (dBm)	Limit (dBm)	Result
GFSK	00	7.336	30.00	Pass
	19	7.268		
	39	6.564		

LE2M

Type	Channel	Output power (dBm)	Limit (dBm)	Result
GFSK	00	7.548	30.00	Pass
	19	7.556		
	39	6.925		

Note: 1.The test results including the cable lose.

3.4. Power Spectral Density

Limit

For digitally modulated systems, the power spectral density conducted from the intentional radiator to the antenna shall not be greater than 8 dBm in any 3 kHz band during any time interval of continuous transmission.

Test Procedure

1. Use this procedure when the maximum peak conducted output power in the fundamental emission is used to demonstrate compliance.
2. Set the RBW \geq 3 kHz.
3. Set the VBW \geq 3 \times RBW.
4. Set the span to 1.5 times the DTS channel bandwidth.
5. Detector = peak.
6. Sweep time = auto couple.
7. Trace mode = max hold.
8. Allow trace to fully stabilize.
9. Use the peak marker function to determine the maximum power level.
10. If measured value exceeds limit, reduce RBW (no less than 3 kHz) and repeat.
11. The resulting peak PSD level must be 8dBm.

Test Configuration

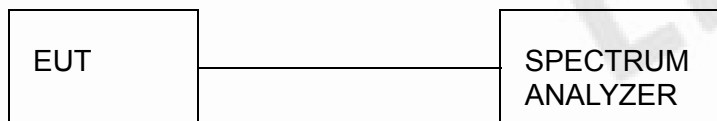

Test Results

LE1M

Type	Channel	Power Spectral Density (dBm/3KHz)	Limit (dBm/3KHz)	Result
GFSK	00	-6.154	8.00	Pass
	19	-6.224		
	39	-6.929		

LE2M

Type	Channel	Power Spectral Density (dBm/3KHz)	Limit (dBm/3KHz)	Result
GFSK	00	-6.616	8.00	Pass
	19	-6.563		
	39	-7.328		

Test plot as follows:

LE1M GFSK

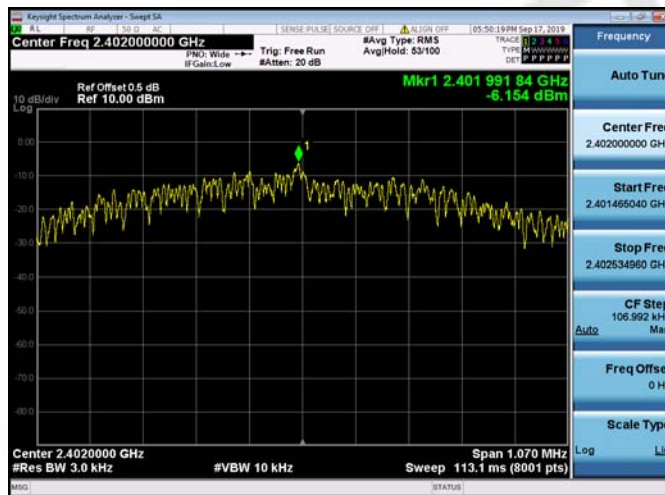

CH00

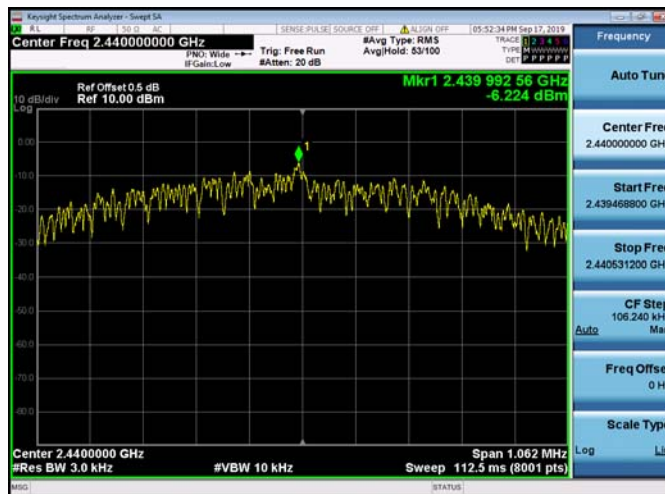

CH19

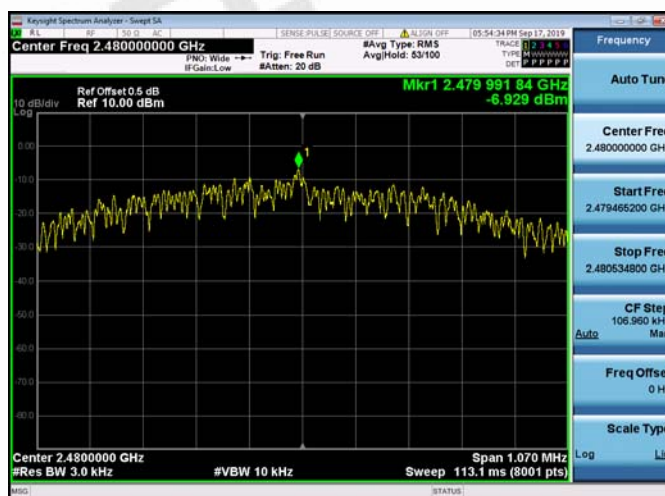

CH39

LE2M GFSK

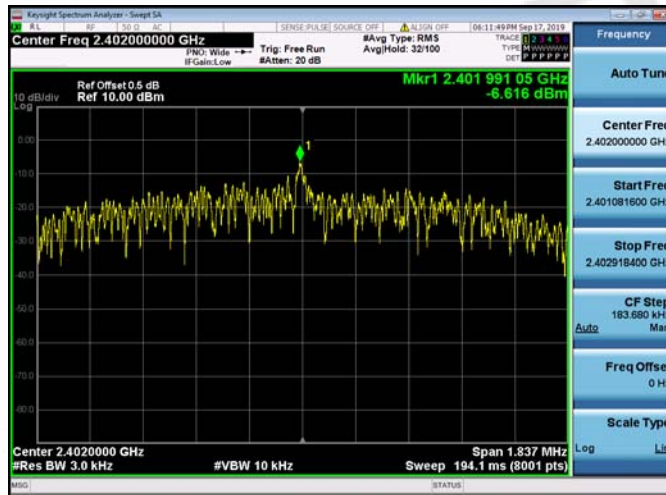

CH00

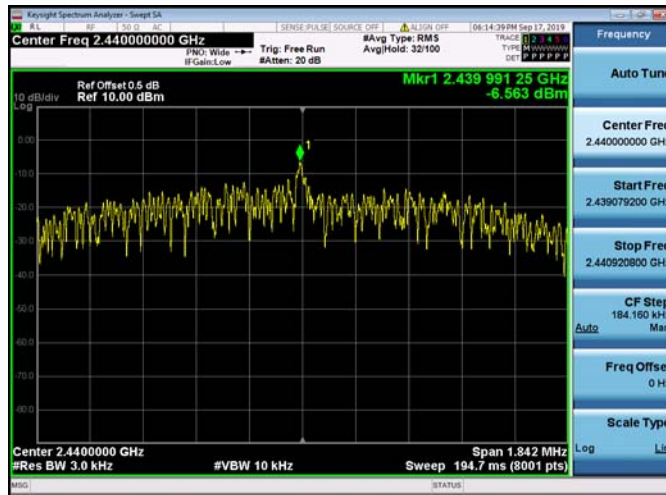

CH19

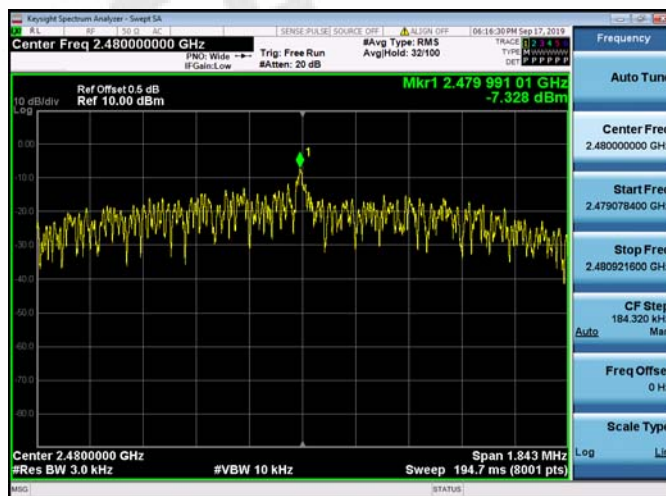

CH39

3.5. 6dB Bandwidth

Limit

For digital modulation systems, the minimum 6 dB bandwidth shall be at least 500 kHz

Test Procedure

The transmitter output was connected to the spectrum analyzer through an attenuator. The bandwidth of the fundamental frequency was measured by spectrum analyzer with 100 KHz RBW and 300 KHz VBW. The 6dB bandwidth is defined as the total spectrum the power of which is higher than peak power minus 6dB.

Test Configuration



Test Results

LE1M

Type	Channel	6dB Bandwidth (MHz)	99% OBW (MHz)	Limit (KHz)	Result
GFSK	00	0.6687	1.0747	≥500	Pass
	19	0.6640	1.0745		
	39	0.6685	1.0730		

LE2M

Type	Channel	6dB Bandwidth (MHz)	99% OBW (MHz)	Limit (KHz)	Result
GFSK	00	1.148	2.0937	≥500	Pass
	19	1.151	2.0922		
	39	1.152	2.0998		

Test plot as follows:

LE1M GFSK

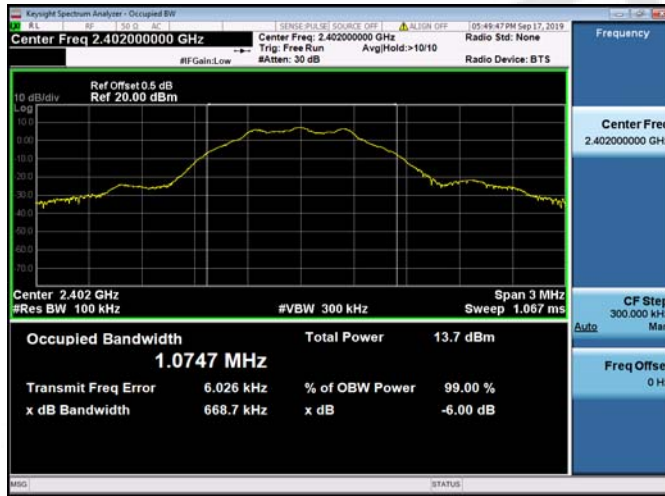

CH00



CH19



CH39

LE2M GFSK



CH00



CH19



CH39

3.6. Out-of-band Emissions

Limit

In any 100 kHz bandwidth outside the frequency band in which the spread spectrum or digitally modulated intentional radiator is operating, the radio frequency power that is produced by the intentional radiator shall be at least 20 dB below that in the 100 kHz bandwidth within the band that contains the highest level of the desired power, based on either an RF conducted or a radiated measurement, provided the transmitter demonstrates compliance with the peak conducted power limits. If the transmitter complies with the conducted power limits based on the use of RMS averaging over a time interval, as permitted under paragraph (b)(3) of this section, the attenuation required under this paragraph shall be 30 dB instead of 20 dB. Attenuation below the general limits specified in §15.209(a) is not required.

Test Procedure

Connect the transmitter output to spectrum analyzer using a low loss RF cable, and set the spectrum analyzer to RBW=100 kHz, VBW= 300 kHz, peak detector, and max hold. Measurements utilizing these settings are made of the in-band reference level, bandedge and out-of-band emissions.

Test Configuration

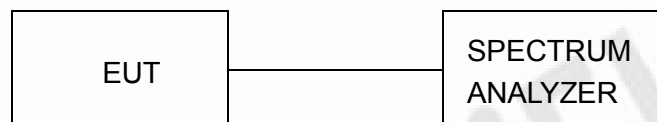

Test Results

Remark: The measurement frequency range is from 30MHz to the 10th harmonic of the fundamental frequency. The lowest, middle and highest channels are tested to verify the spurious emissions and bandedge measurement data.

Test plot as follows:

LE1M

CH00

CH19

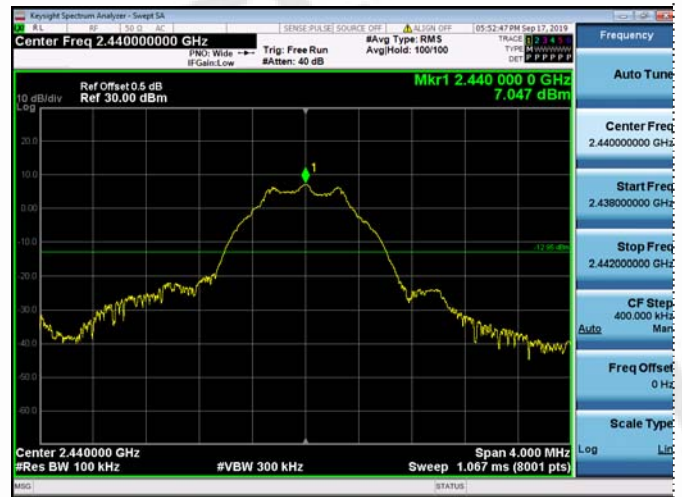

Reference

Reference

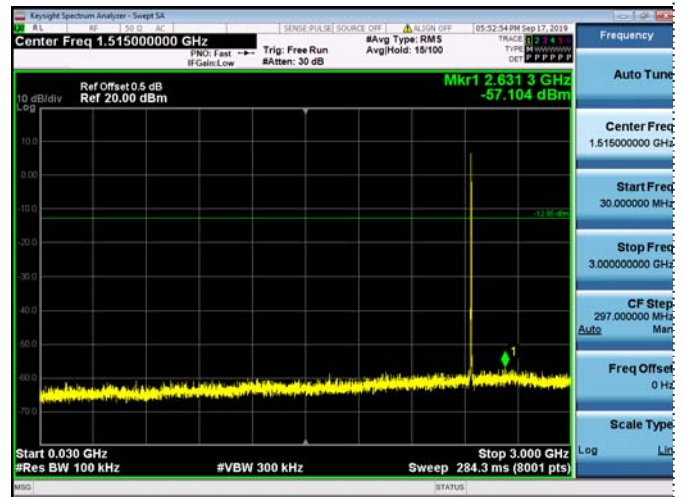
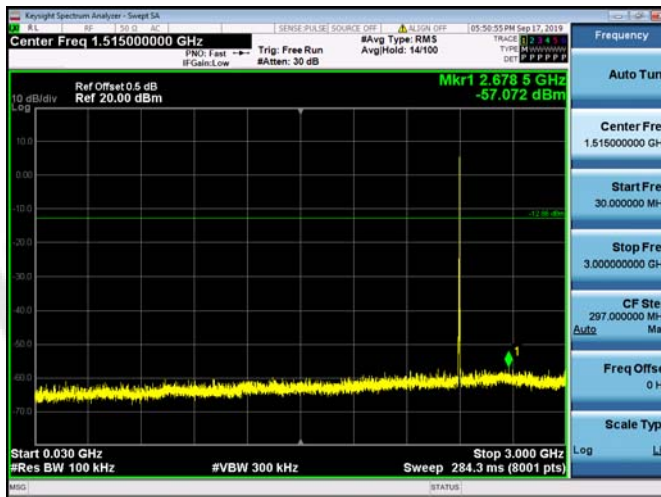

30MHz-3GHz

30MHz-3GHz

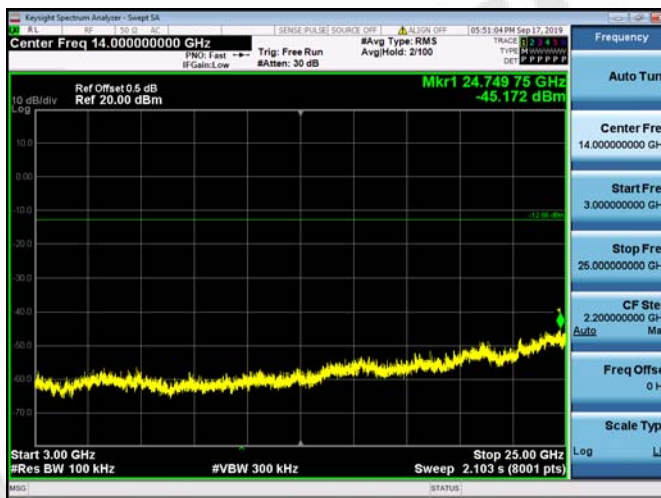

3GHz-25GHz

3GHz-25GHz

CH39



Reference

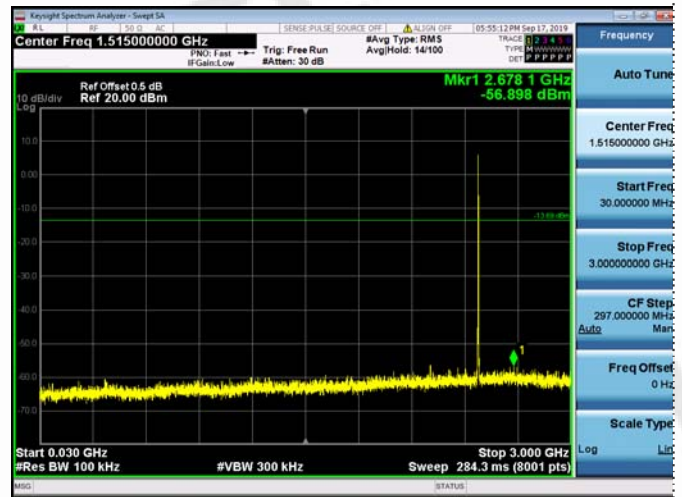

30MHz-3GHz

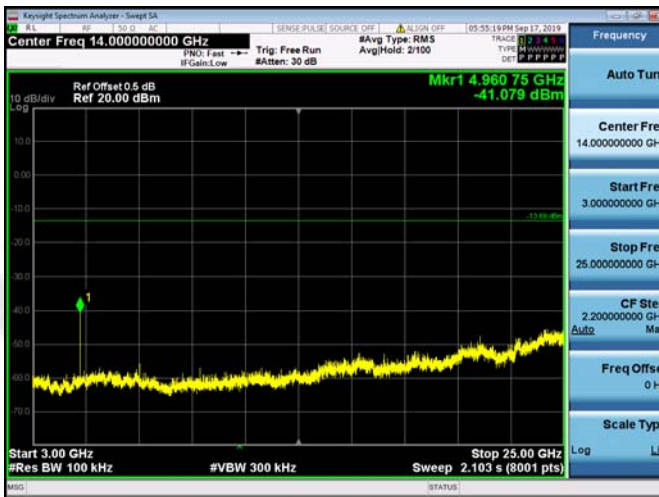

3GHz-25GHz

LE2M

CH00



Reference

CH19



Reference

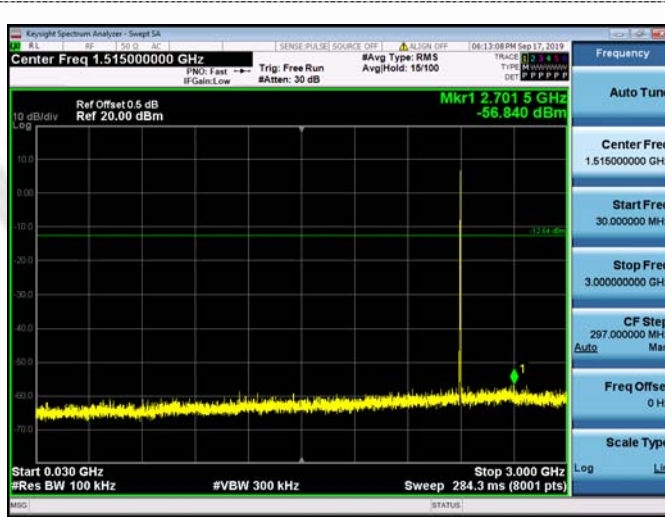

30MHz-3GHz

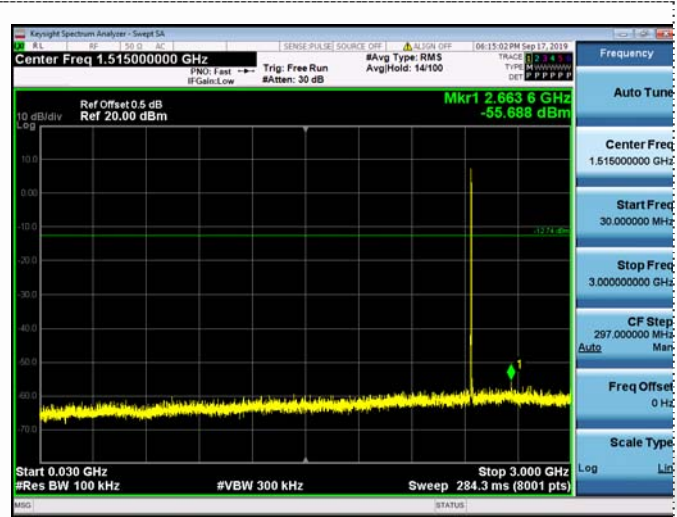

30MHz-3GHz



3GHz-25GHz



3GHz-25GHz

CH39



Reference

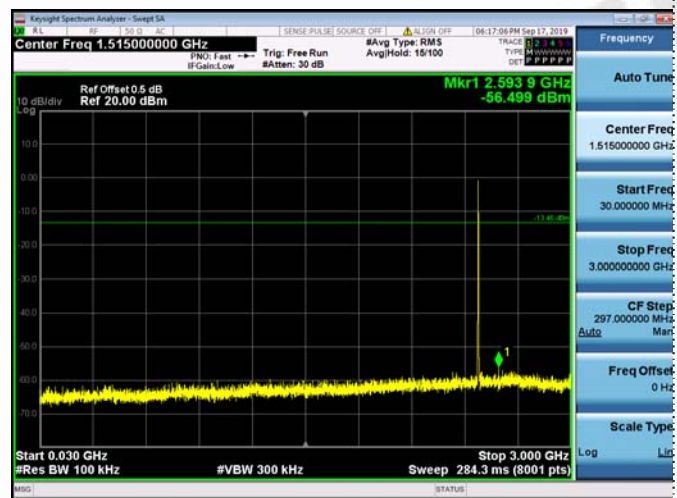

30MHz-3GHz

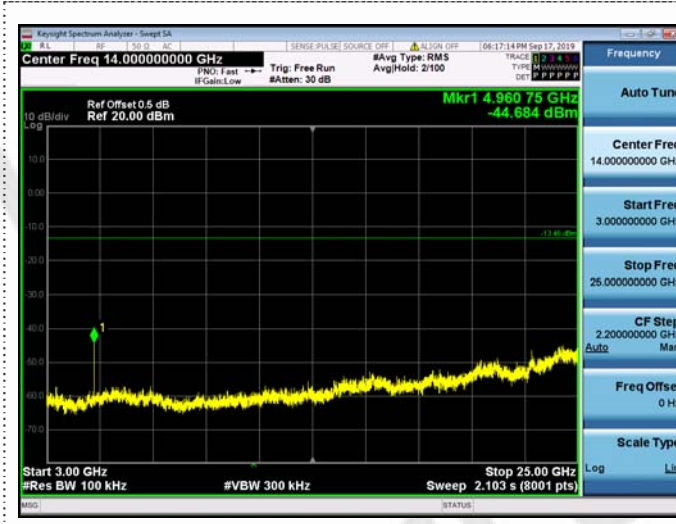

3GHz-25GHz

Band-edge Measurements for RF Conducted Emissions:

LE1M GFSK



Left bandedge

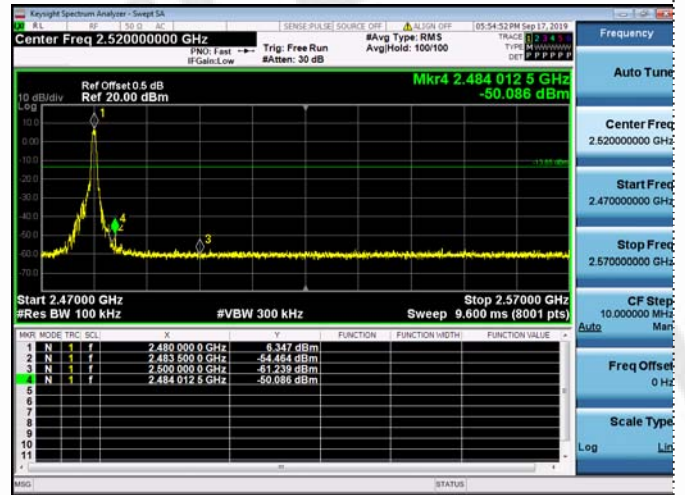

Right bandedge

LE2M GFSK



Left bandedge

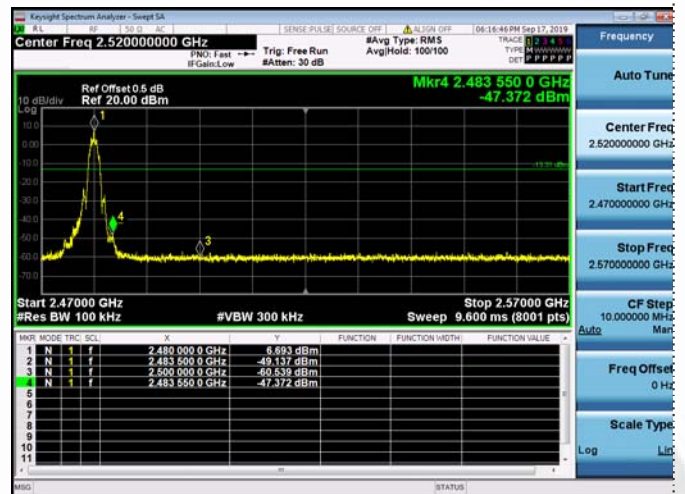

Right bandedge

3.7. Antenna Requirement

Standard Applicable

For intentional device, according to FCC 47 CFR Section 15.203:

An intentional radiator shall be designed to ensure that no antenna other than that furnished by the responsible party shall be used with the device. The use of a permanently attached antenna or of an antenna that uses a unique coupling to the intentional radiator, the manufacturer may design the unit so that a broken antenna can be replaced by the user, but the use of a standard antenna jack or electrical connector is prohibited

FCC CFR Title 47 Part 15 Subpart C Section 15.247(c) (1) (I):

(i) Systems operating in the 2400-2483.5 MHz band that is used exclusively for fixed. Point-to-point operations may employ transmitting antennas with directional gain greater than 6dBi provided the maximum conducted output power of the intentional radiator is reduced by 1 dB for every 3 dB that the directional gain of the antenna exceeds 6dBi.

Test Result:

The maximum gain of antenna was 0dBi.

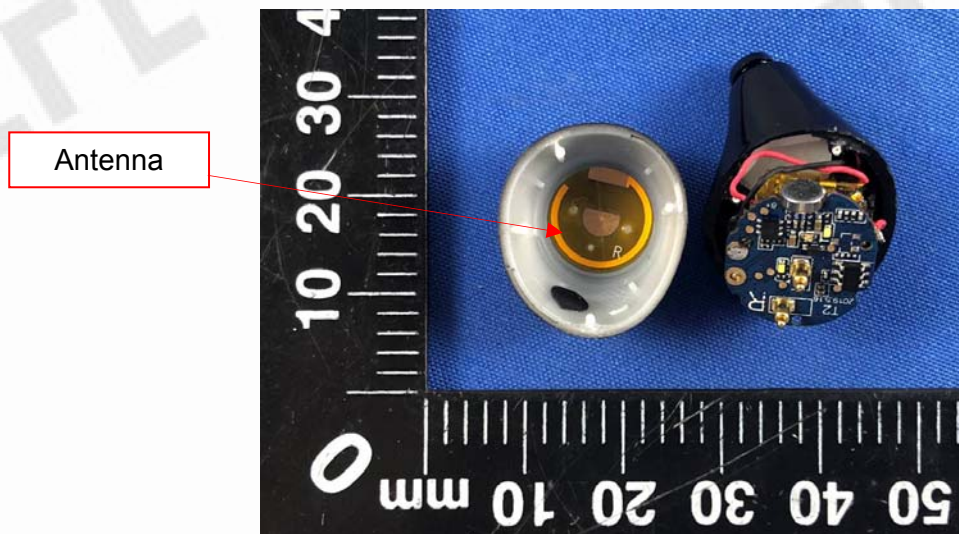

4. Test Setup Photos of the EUT

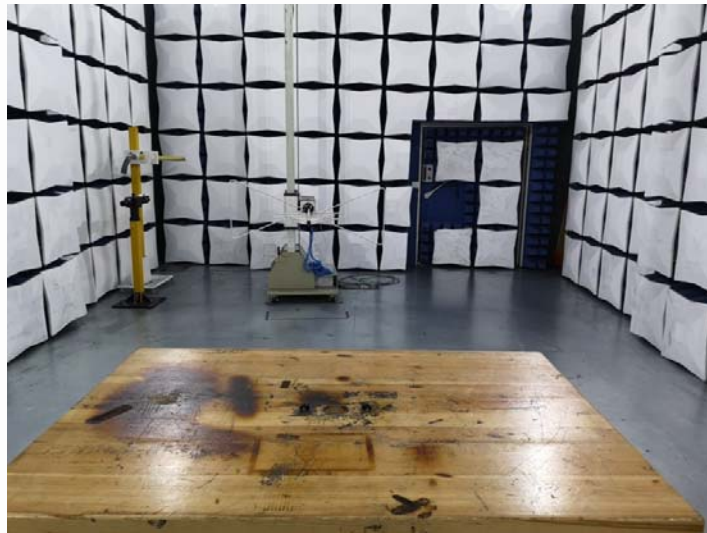

5. External and Internal Photos of the EUT

External Photos of EUT









Internal Photos of EUT

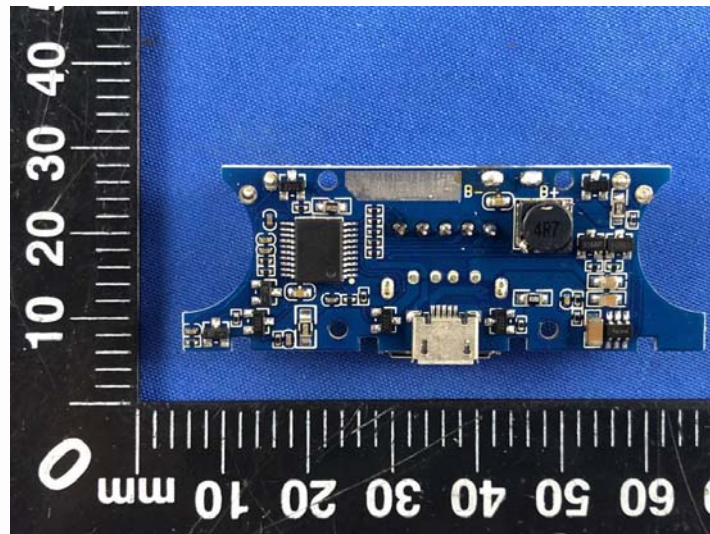
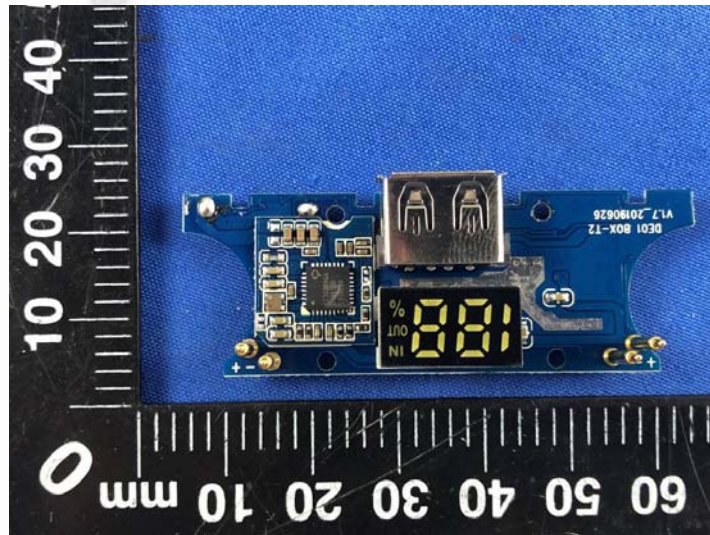
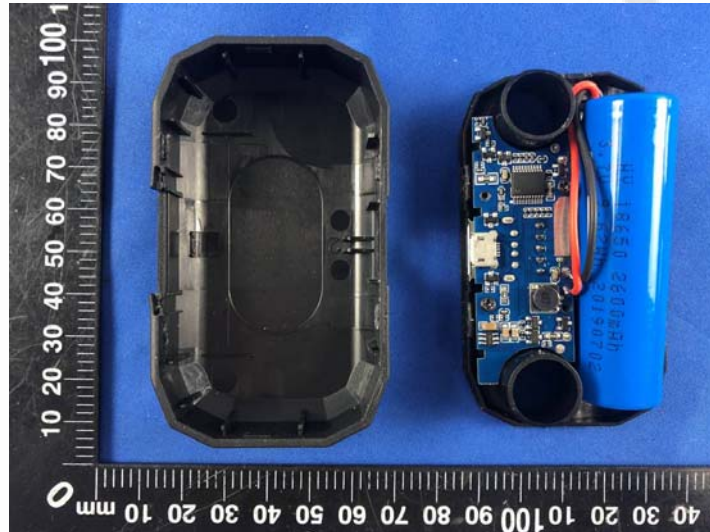



Antenna

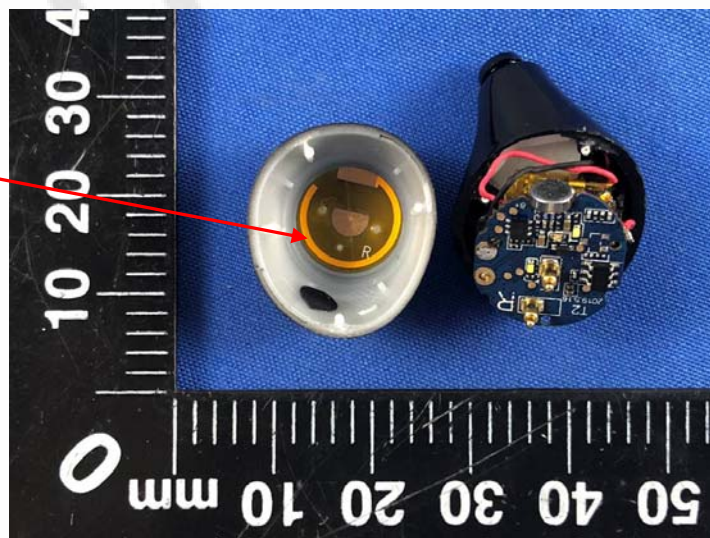

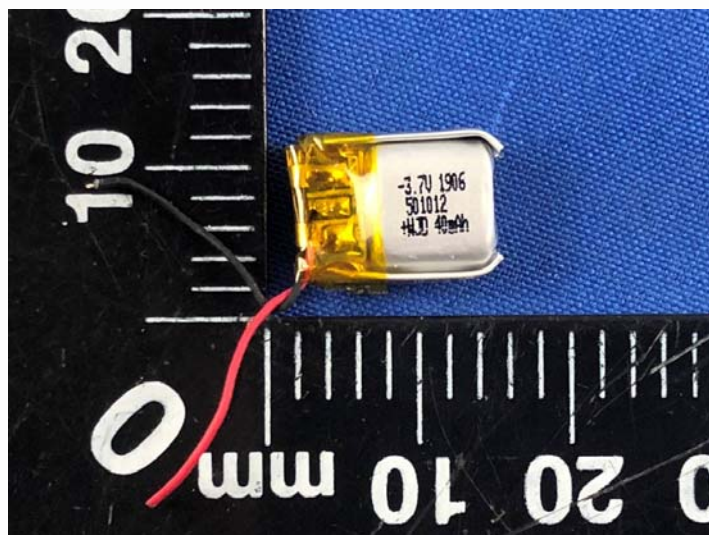
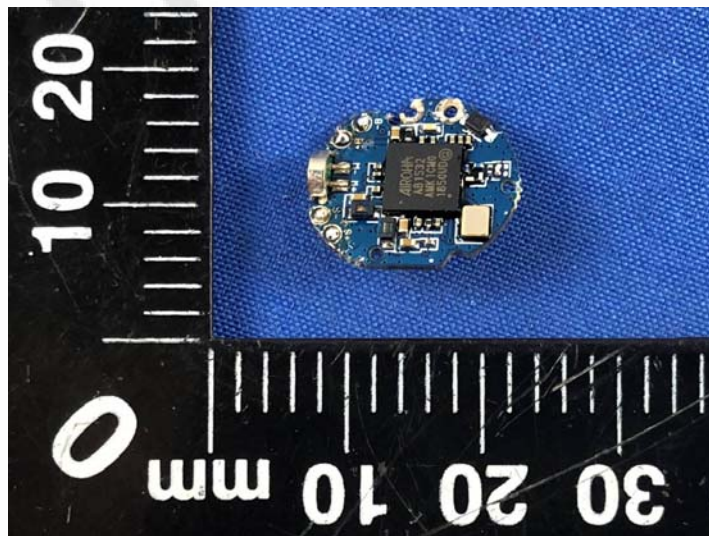
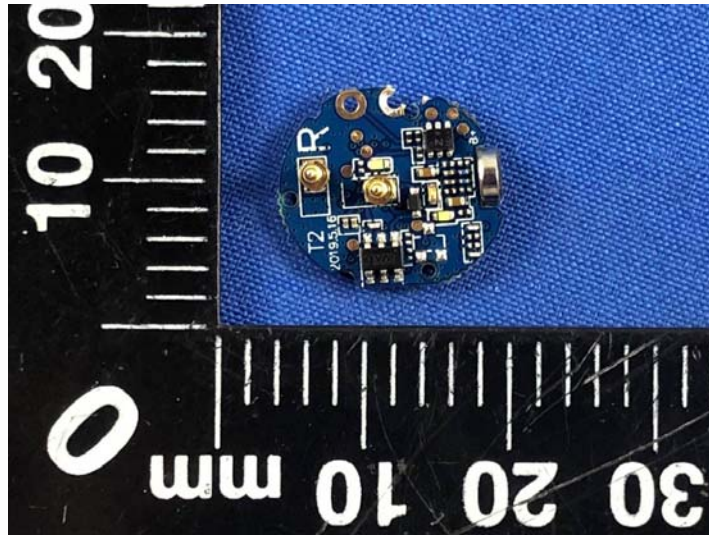

***** End of Report *****