

TEST REPORT

FCC ID :	2AR45-R2811A	
Test Report No :	TCT210827E006	
Date of issue :	Sep. 14, 2021	
Testing laboratory	SHENZHEN TONGCE TESTING LAB	
Testing location/ address:	TCT Testing Industrial Park Fuqiao 5th Industrial Zone, Fuhai Street, Bao'an District Shenzhen, Guangdong, 518103, People's Republic of China	
Applicant's name :	Shanghai Notion Information Technology CO. LTD	
Address :	Room 408,Building 2, Lane 666,Zhangheng Rd, Pudong New Area, Shanghai, China	
Manufacturer's name ... :	Shanghai Notion Information Technology CO. LTD	
Address :	Room 408,Building 2, Lane 666,Zhangheng Rd, Pudong New Area, Shanghai, China	
Standard(s)	47 CFR FCC Part 15.407 KDB905462 D02 UNII DFS Compliance Procedures New Rules v02 KDB 905462 D03 UNII Clients Without Radar Detection New Rules v01r02	
Test item description	CPE	
Trade Mark	N/A	
Model/Type reference :	R2811A, R281, R281A, P28, P28V	
Rating(s) :	Refer to EUT description of page 3	
Date of receipt of test item	Aug. 27, 2021	
Date (s) of performance of test :	Aug. 27, 2021 - Sep. 14, 2021	
Tested by (+signature) ... :	Rleo	
Check by (+signature) :	Beryl Zhao	
Approved by (+signature):	Tomsin	



General disclaimer:

This report shall not be reproduced except in full, without the written approval of SHENZHEN TONGCE TESTING LAB. This document may be altered or revised by SHENZHEN TONGCE TESTING LAB personnel only, and shall be noted in the revision section of the document. The test results in the report only apply to the tested sample.

TABLE OF CONTENTS

1. General Product Information 3

 1.1. EUT description 3

 1.2. Model(s) list..... 3

2. Test Result Summary 4

3. General Information..... 5

 3.1. RF General information..... 5

 3.2. Description of Support Units..... 5

 3.3. Test Instruments List 6

4. Facilities and Accreditations 7

 4.1. Facilities 7

 4.2. Location 7

 4.3. Measurement Uncertainty..... 7

5. Dynamic Frequency Selection (DFS) Test Result 8

 5.1. General DFS Information 8

 5.2. Radar Test Waveform Calibration 10

 5.3. UNII Detection Bandwidth..... 16

 5.4. Channel Availability Check (CAC)..... 23

 5.5. In-service Monitoring 28

 5.6. Statistical Performance Check..... 31

1. General Product Information

1.1. EUT description

Test item description	CPE
Model/Type reference.....	R2811A
Sample Number.....	TCT210827E006-0101
Support Mode	<input checked="" type="checkbox"/> Master <input type="checkbox"/> Slave
Operation Frequency	Band 2A: 5250MHz~5350MHz Band 2C: 5470MHz~5725MHz
Channel Separation.....	802.11a: 20MHz 802.11n: 20MHz, 40MHz 802.11ac: 20MHz, 40MHz, 80MHz
Modulation Technology	Orthogonal Frequency Division Multiplexing(OFDM)
Antenna Type.....	Integral Antenna
Antenna Gain.....	ANT 1: Band 2A: 2.0dBi, Band 2C: 2.0dBi ANT 2: Band 2A: 2.0dBi, Band 2C: 2.0dBi
Rating(s).....	Adapter Information1: Model: KFL-T43 Input: AC 100-240V, 50/60Hz, 0.8A Output: DC 12V, 1500mA Adapter Information2: MODEL: RD1202000-C55-154MG INPUT: AC 100-240V, 50/60Hz, 1.0A MAX OUTPUT: DC 12V, 2.0A
TPC	N/A(EIRP<500mW)

Note: The antenna gain listed in this report is provided by applicant, and the test laboratory is not responsible for this parameter.

1.2. Model(s) list

No.	Model No.	Tested with
1	R2811A	<input checked="" type="checkbox"/>
Other models	R281, R281A, P28, P28V	<input type="checkbox"/>

Note: R2811A is tested model, other models are derivative models. The models are identical in circuit and PCB layout, only different on the model names. So the test data of R2811A can represent the remaining models.

2. Test Result Summary

Description	Limit	Result
UNII Detection Bandwidth	>100% of the 99% BW	Pass
Channel Availability Check	> 60 sec	Pass
Channel Move Time	< 10sec	Pass
Channel Closing Transmission Time	200 milliseconds + an aggregate of 60 milliseconds over remaining	Pass
Non-Occupancy Period	> 30 min	Pass
Statistical Performance Check	Type1,2,3,4 ≥ 60% Type1~4&5 ≥ 70% Type6 ≥ 80%	Pass

3. General Information

3.1. RF General information

IEEE Std. 802.11	Channel Bandwidth (MHz)
a/n/ac (HT20)	20
n/ac (HT40)	40
ac(VHT80)	80
802.11a/n/ac uses a combination of OFDM-BPSK, QPSK, 16QAM, 64QAM modulation.	
Remark: All test are performed with conducted method	

3.2. Description of Support Units

The EUT has been tested as an independent unit together with other necessary accessories or support units. The following support units or accessories were used to form a representative test configuration during the tests.

Equipment	Model No.	Serial No.	FCC ID	Trade Name
Laptop	ThinkPad T430	PO1908049	/	Lenovo
AC Adapter	92P1154	11S92P1154Z1 ZDXP7CL957	/	Lenovo
Panel Computer	/	/	/	

Note:

1. All the equipment/cables were placed in the worst-case configuration to maximize the emission during the test.
2. Grounding was established in accordance with the manufacturer's requirements and conditions for the intended use.

3.3. Test Instruments List

DFS				
Name	Model No.	Manufacturer	Date of Cal.	Due Date
vector Signal Generator	N5182A	Agilent	Jul. 19, 2021	Jul. 18, 2022
Spectrum Analyzer	N9020A	Agilent	Jul. 19, 2021	Jul. 18, 2022
Combiner Box	AT890-RFB	Ascentest	Jul. 08, 2021	Jul. 07, 2022

4. Facilities and Accreditations

4.1. Facilities

The test facility is recognized, certified, or accredited by the following organizations:

- FCC - Registration No.: 645098

SHENZHEN TONGCE TESTING LAB

Designation Number: CN1205

The testing lab has been registered and fully described in a report with the (FCC) Federal Communications Commission. The acceptance letter from the FCC is maintained in our files.

- IC - Registration No.: 10668A-1

SHENZHEN TONGCE TESTING LAB

CAB identifier: CN0031

The testing lab has been registered by Certification and Engineering Bureau of Industry Canada for radio equipment testing.

4.2. Location

SHENZHEN TONGCE TESTING LAB

Address: TCT Testing Industrial Park Fuqiao 5th Industrial Zone, Fuhai Street, Bao'an District Shenzhen, Guangdong, 518103, People's Republic of China

TEL: +86-755-27673339

4.3. Measurement Uncertainty

The reported uncertainty of measurement $y \pm U$, where expanded uncertainty U is based on a standard uncertainty multiplied by a coverage factor of $k=2$, providing a level of confidence of approximately 95 %.

No.	Item	MU
1	Conducted Emission	± 3.10 dB
2	RF power, conducted	± 0.12 dB
3	Spurious emissions, conducted	± 0.11 dB
4	All emissions, radiated(<1 GHz)	± 4.56 dB
5	All emissions, radiated(1 GHz - 18 GHz)	± 4.22 dB
6	All emissions, radiated(18 GHz- 40 GHz)	± 4.36 dB

5. Dynamic Frequency Selection (DFS) Test Result

5.1. General DFS Information

5.1.1. DFS Parameters

Table D.1: DFS requirement values

Parameter	Value
Non-occupancy period	Minimum 30 minutes
Channel Availability Check Time	60 seconds
Channel Move Time	10 seconds See Note 1.
Channel Closing Transmission Time	200 milliseconds + an aggregate of 60 milliseconds over remaining 10 second periods. See Notes 1 and 2.
U-NII Detection Bandwidth	Minimum 100% of the 99% power bandwidth See Note 3.

Note 1: The instant that the *Channel Move Time* and the *Channel Closing Transmission Time* begins is as follows:

- For the Short pulse radar Test Signals this instant is the end of the *Burst*.
- For the Frequency Hopping radar Test Signal, this instant is the end of the last radar *Burst* generated.
- For the Long Pulse radar Test Signal this instant is the end of the 12 second period defining the radar transmission.

Note 2: The *Channel Closing Transmission Time* is comprised of 200 milliseconds starting at the beginning of the *Channel Move Time* plus any additional intermittent control signals required to facilitate *Channel* changes (an aggregate of 60 milliseconds) during the remainder of the 10 second period. The aggregate duration of control signals will not count quiet periods in between transmissions.

Note 3: During the *U-NII Detection Bandwidth* detection test, radar type 1 is used and for each frequency step the minimum percentage of detection is 90%. Measurements are performed with no data traffic.

Table D.2: Interference threshold values

Maximum Transmit Power	Value (see note)
≥ 200 milliwatt	-64 dBm
< 200 milliwatt	-62 dBm

Note 1: This is the level at the input of the receiver assuming a 0 dBi receive antenna.

Note 2: Throughout these test procedures an additional 1 dB has been added to the amplitude of the test transmission waveforms to account for variations in measurement equipment. This will ensure that the test signal is at or above the detection threshold level to trigger a DFS response.

Note 1: This is the level at the input of the receiver assuming a 0 dBi receive antenna.

Note 2: Throughout these test procedures an additional 1 dB has been added to the amplitude of the test transmission waveforms to account for variations in measurement equipment. This will ensure that the test signal is at or above the detection threshold level to trigger a DFS response.

5.1.2. Applicability of DFS Requirements Prior to Use of a Channel

Requirement	DFS Operational mode		
	Master	Client without radar detection	Client with radar detection
<i>Non-Occupancy Period</i>	Yes	Not required	Yes
<i>DFS Detection Threshold</i>	Yes	Not required	Yes
<i>Channel Availability Check Time</i>	Yes	Not required	Not required
<i>Uniform Spreading</i>	Yes	Not required	Not required
<i>U-NII Detection Bandwidth</i>	Yes	Not required	Yes

5.1.3. Applicability of DFS Requirements during Normal Operation

Requirement	DFS Operational mode		
	Master	Client without radar detection	Client with radar detection
<i>DFS Detection Threshold</i>	Yes	Not required	Yes
<i>Channel Closing Transmission Time</i>	Yes	Yes	Yes
<i>Channel Move Time</i>	Yes	Yes	Yes
<i>U-NII Detection Bandwidth</i>	Yes	Not required	Yes

5.2. Radar Test Waveform Calibration

5.2.1. Short Pulse Radar Test Waveforms

Table 5 – Short Pulse Radar Test Waveforms

Radar Type	Pulse Width (μsec)	PRI (μsec)	Number of Pulses	Minimum Percentage of Successful Detection	Minimum Number of Trials
0	1	1428	18	See Note 1	See Note 1
1	1	Test A: 15 unique PRI values randomly selected from the list of 23 PRI values in Table 5a	Roundup $\left\{ \left(\frac{1}{360} \right) \cdot \left(\frac{19 \cdot 10^6}{PRI_{\mu sec}} \right) \right\}$	60%	30
		Test B: 15 unique PRI values randomly selected within the range of 518-3066 μsec, with a minimum increment of 1 μsec, excluding PRI values selected in Test A			
2	1-5	150-230	23-29	60%	30
3	6-10	200-500	16-18	60%	30
4	11-20	200-500	12-16	60%	30
Aggregate (Radar Types 1-4)				80%	120
Note 1: Short Pulse Radar Type 0 should be used for the detection bandwidth test, channel move time, and channel closing time tests.					

A minimum of 30 unique waveforms are required for each of the short pulse radar types 2 through 4. For short pulse radar type 1, the same waveform is used a minimum of 30 times. If more than 30 waveforms are used for short pulse radar types 2 through 4, then each additional waveform must also be unique and not repeated from the previous waveforms. The aggregate is the average of the percentage of successful detections of short pulse radar types 1-4.

5.2.2. Long Pulse Radar Test Waveform

Radar Type	Pulse Width (µsec)	ChirpWidth (MHz)	PRI (µsec)	Number of Pulses per Burst	Number of Bursts	Minimum Percentage of Successful Detection	Minimum Trials
5	50-100	5-20	1000-2000	1-3	8-20	80%	30

Each waveform is defined as follows:

- ◆ The transmission period for the Long Pulse Radar test signal is 12 seconds.
- ◆ There are a total of 8 to 20 Bursts in the 12 second period, with the number of Bursts being randomly chosen. This number is Burst Count.
- ◆ Each Burst consists of 1 to 3 pulses, with the number of pulses being randomly chosen. Each Burst within the 12 second sequence may have a different number of pulses.
- ◆ The pulse width is between 50 and 100 microseconds, with the pulse width being randomly chosen. Each pulse within a Burst will have the same pulse width. Pulses in different Bursts may have different pulse widths.
- ◆ Each pulse has a linear FM chirp between 5 and 20 MHz, with the chirp width being randomly chosen. Each pulse within a Burst will have the same chirp width. Pulses in different Bursts may have different chirp widths. The chirp is centered on the pulse. For example, with a radar frequency of 5300 MHz and a 20 MHz chirped signal, the chirp starts at 5290 MHz and ends at 5310 MHz.
- ◆ If more than one pulse is present in a Burst, the time between the pulses will be between 1000 and 2000 microseconds, with the time being randomly chosen. If three pulses are present in a Burst, the time between the first and second pulses is chosen independently of the time between the second and third pulses.
- ◆ The 12 second transmission period is divided into even intervals. The number of intervals is equal to Burst_Count. Each interval is of length $(12,000,000 / \text{Burst_Count})$ microseconds. Each interval contains one Burst. The start time for the Burst, relative to the beginning of the interval, is between 1 and $[(12,000,000 / \text{Burst_Count}) - (\text{Total Burst Length}) + (\text{One Random PRI Interval})]$ microseconds, with the start time being randomly chosen. The step interval for the start time is 1 microsecond. The start time for each Burst is chosen independently.

5.2.3. Frequency Hopping Radar Test Waveform

Radar Type	Pulse Width (µsec)	PRI (µsec)	Pulses per Hop	Hopping Rate (kHz)	Hopping Sequence Length (ms)	Minimum Percentage of Successful Detection	Minimum Trials
6	1	333	9	0.333	300	70%	30

The FCC Type 6 waveform uses a static waveform with 100 bursts in the instruments ARB. In addition, the RF list mode is operated with a list containing 100 frequencies from a randomly generated list and it had be ensured that at least one of the random frequencies falls into the UNII Detection Bandwidth of the DUT. Each burst from the waveform file initiates a trigger pulse at the beginning that switches the RF list from one item to the next one.

5.2.4. DFS Threshold Level

DFS Threshold Level	
DFS Threshold level: -64 dBm	<input checked="" type="checkbox"/> at the antenna connector
	<input type="checkbox"/> in front of the antenna

5.2.5. Test Set up

Setup for Master with injection at the Master

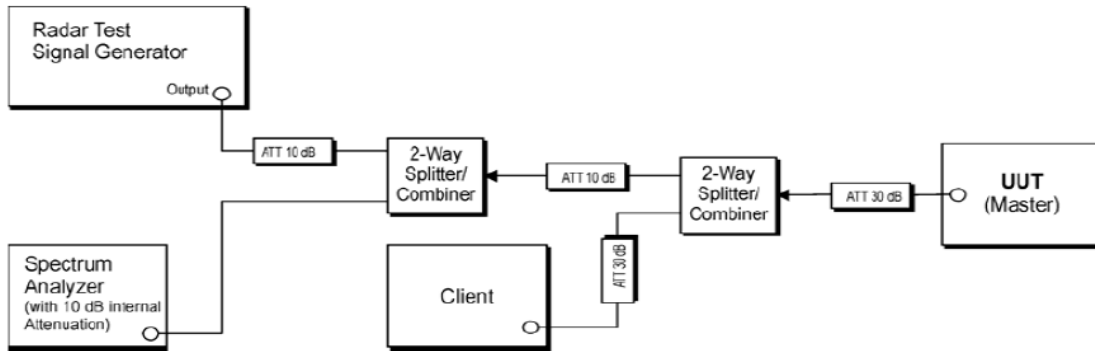

Calibration Plots

Radar #0

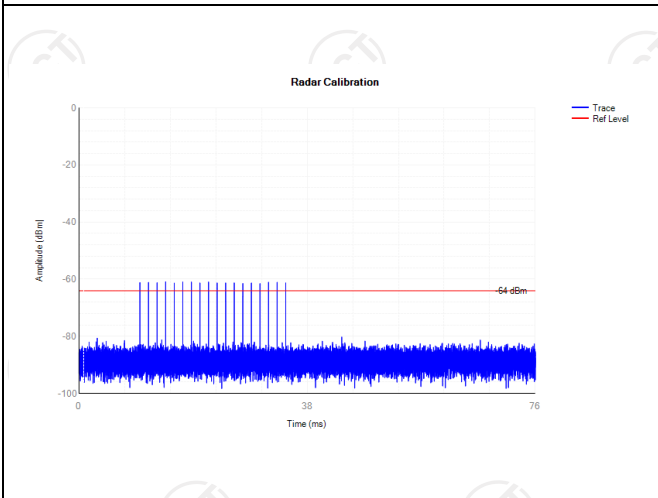

Radar #1

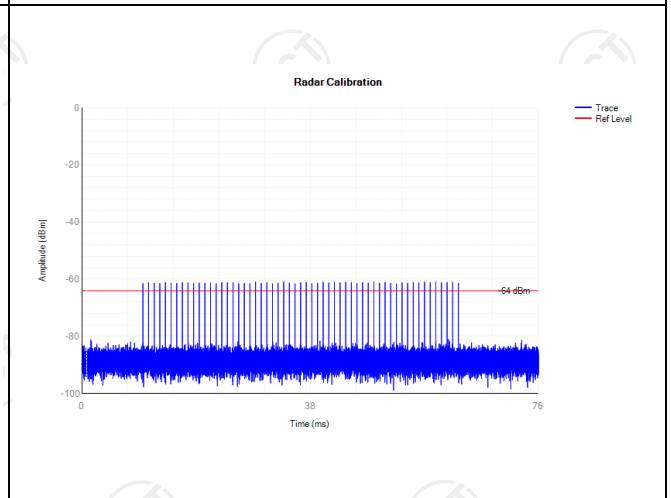

Radar #2

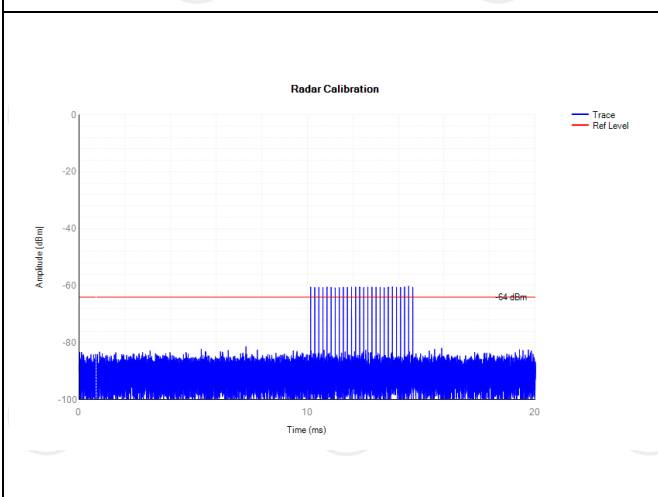

Radar #3

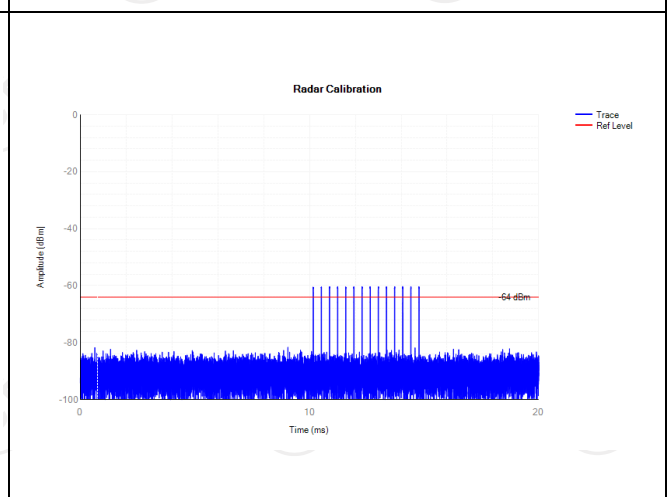

Radar #4

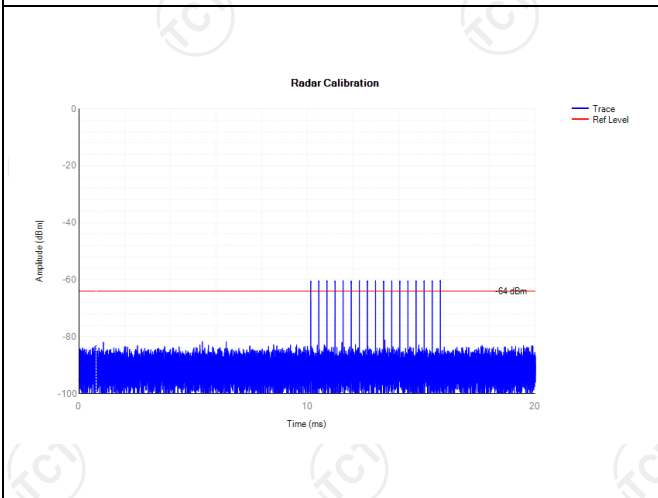

Radar #5

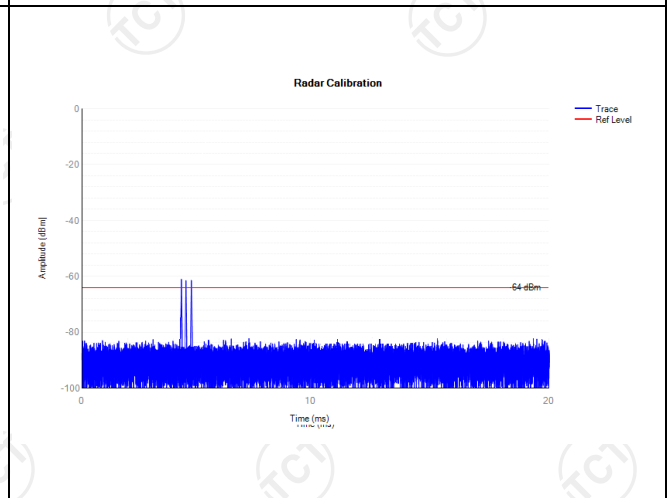

Radar #6

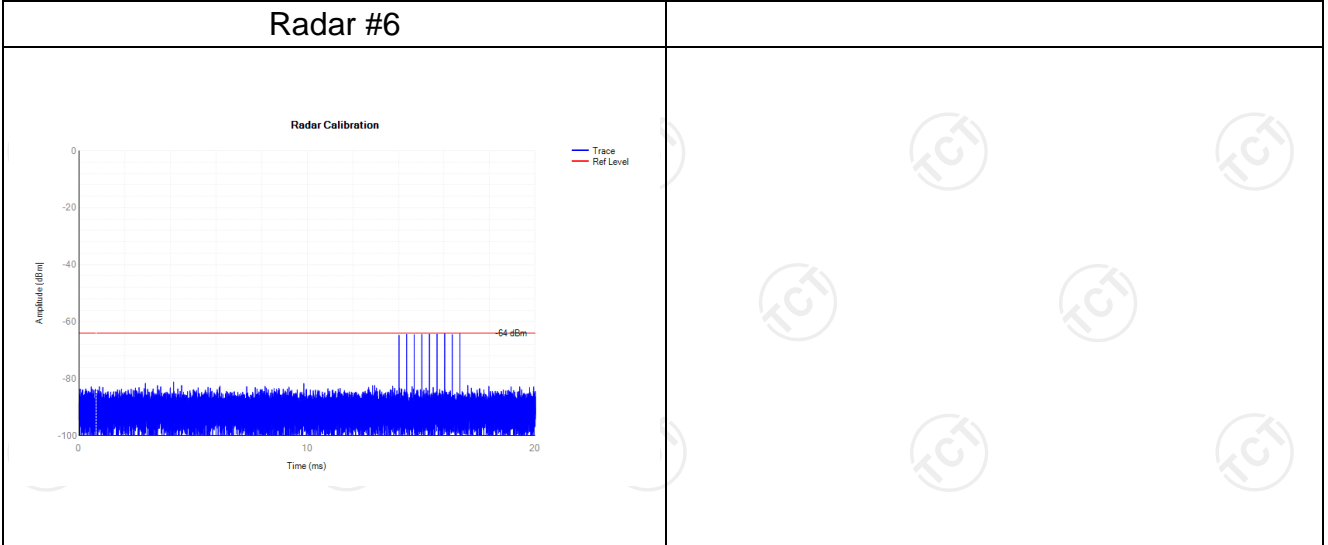

5.3. UNII Detection Bandwidth

5.3.1. UNII Detection Bandwidth Limit

Frequency (MHz)	Nominal Bandwidth (MHz)	99% Power Bandwidth (MHz)
5300(ac VHT20)	20	17.27
5270(ac VHT40)	40	36.42
5500(ac VHT20)	20	17.75
5510(ac VHT40)	40	36.46
5290(ac VHT80)	80	78.36
5530(ac VHT80)	80	78.45

UNII Detection Bandwidth is minimum 100% of the 99% power bandwidth. A single radar Burst is generated for a minimum of 10 trials, and the response of the UUT is noted. The UUT must detect the Radar Waveform 90% or more of the time.

5.3.2. Measuring Instruments

Refer a test equipment and calibration data table in this test report.

5.3.3. Test Procedures

Test Method
<input checked="" type="checkbox"/> Refer as KDB905462 D02 UNII DFS Compliance Procedures New Rules v02, clause 7.8.1 for UNII Detection Bandwidth test. During the U-NII Detection Bandwidth detection test, radar type 1 is used and for each frequency step the minimum percentage of detection is 90 percent. Measurements are performed with no data traffic. The EUT is set up as a standalone device (no associated Client and no traffic). The radar frequency is increased in 1 MHz steps, repeating the above test sequence, until the detection rate falls below 90%. The highest frequency at which detection is greater than or equal to 90% is denoted as FH. The radar frequency is decreased in 1 MHz steps, repeating the above test sequence, until the detection rate falls below 90%. The lowest frequency at which detection is greater than or equal to 90% is denoted as FL. UNII Detection Bandwidth = FH -FL

5.3.4. Test Result of UNII Detection Bandwidth

Channel 5300MHz

Radar Type		0										
Channel Bandwidth (MHz)		20										
Radar Freq. (MHz)	Trial Number (Y=Detection, N= No Detection)										Detection Rate (%)	FL/FH
	1	2	3	4	5	6	7	8	9	10		
5290	Y	Y	Y	Y	Y	Y	Y	Y	Y	Y	100	
5291	Y	Y	Y	Y	Y	Y	Y	Y	Y	Y	100	FL
5292	Y	Y	Y	Y	Y	Y	Y	Y	Y	Y	100	
5293	Y	Y	Y	Y	Y	Y	Y	Y	Y	Y	100	
5294	Y	Y	Y	Y	Y	Y	Y	Y	Y	Y	100	
5295	Y	Y	Y	Y	Y	Y	Y	Y	Y	Y	100	
5296	Y	Y	Y	Y	Y	Y	Y	Y	Y	Y	100	
5297	Y	Y	Y	Y	Y	Y	Y	Y	Y	Y	100	
5298	Y	Y	Y	Y	Y	Y	Y	Y	Y	Y	100	
5299	Y	Y	Y	Y	Y	Y	Y	Y	Y	Y	100	
5300	Y	Y	Y	Y	Y	Y	Y	Y	Y	Y	100	
5301	Y	Y	Y	Y	Y	Y	Y	Y	Y	Y	100	
5302	Y	Y	Y	Y	Y	Y	Y	Y	Y	Y	100	
5303	Y	Y	Y	Y	Y	Y	Y	Y	Y	Y	100	
5034	Y	Y	Y	Y	Y	Y	Y	Y	Y	Y	100	
5035	Y	Y	Y	Y	Y	Y	Y	Y	Y	Y	100	
5036	Y	Y	Y	Y	Y	Y	Y	Y	Y	Y	100	
5037	Y	Y	Y	Y	Y	Y	Y	Y	Y	Y	100	
5038	Y	Y	Y	Y	Y	Y	Y	Y	Y	Y	100	
5039	Y	Y	Y	Y	Y	Y	Y	Y	Y	Y	100	FH
5030	Y	Y	Y	Y	Y	Y	Y	Y	Y	Y	90	
EUT Bandwidth (MHz)												17.863
Result												PASS

Channel 5500MHz

Radar Type		0										
Channel Bandwidth (MHz)		20										
Radar Freq. (MHz)	Trial Number (Y=Detection, N= No Detection)										Detection Rate (%)	FL/FH
	1	2	3	4	5	6	7	8	9	10		
5490	Y	Y	Y	Y	Y	Y	Y	Y	Y	Y	100	
5491	Y	Y	Y	Y	Y	Y	Y	Y	Y	Y	100	FL
5492	Y	Y	Y	Y	Y	Y	Y	Y	Y	Y	100	
5493	Y	Y	Y	Y	Y	Y	Y	Y	Y	Y	100	
5494	Y	Y	Y	Y	Y	Y	Y	Y	Y	Y	100	
5495	Y	Y	Y	Y	Y	Y	Y	Y	Y	Y	100	
5496	Y	Y	Y	Y	Y	Y	Y	Y	Y	Y	100	
5497	Y	Y	Y	Y	Y	Y	Y	Y	Y	Y	100	
5498	Y	Y	Y	Y	Y	Y	Y	Y	Y	Y	100	
5499	Y	Y	Y	Y	Y	Y	Y	Y	Y	Y	100	
5500	Y	Y	Y	Y	Y	Y	Y	Y	Y	Y	100	
5501	Y	Y	Y	Y	Y	Y	Y	Y	Y	Y	100	
5502	Y	Y	Y	Y	Y	Y	Y	Y	Y	Y	100	
5503	Y	Y	Y	Y	Y	Y	Y	Y	Y	Y	100	
5504	Y	Y	Y	Y	Y	Y	Y	Y	Y	Y	100	
5505	Y	Y	Y	Y	Y	Y	Y	Y	Y	Y	100	
5506	Y	Y	Y	Y	Y	Y	Y	Y	Y	Y	100	
5507	Y	Y	Y	Y	Y	Y	Y	Y	Y	Y	100	
5508	Y	Y	Y	Y	Y	Y	Y	Y	Y	Y	100	
5509	Y	Y	Y	Y	Y	Y	Y	Y	Y	Y	100	FH
5510	Y	Y	Y	Y	Y	Y	Y	Y	Y	Y	100	
EUT Bandwidth (MHz)												17.857
Result												PASS

Channel 5270MHz

Radar Type		0										
Channel Bandwidth (MHz)		40										
Radar Freq. (MHz)	Trial Number (Y=Detection, N= No Detection)										Detection Rate (%)	FL/FH
	1	2	3	4	5	6	7	8	9	10		
5249	Y	Y	Y	Y	Y	Y	Y	Y	Y	Y	100	
5250	Y	Y	Y	Y	Y	Y	Y	Y	Y	Y	100	
5251	Y	Y	Y	Y	Y	Y	Y	Y	Y	Y	100	FL
5252	Y	Y	Y	Y	Y	Y	Y	Y	Y	Y	100	
5253	Y	Y	Y	Y	Y	Y	Y	Y	Y	Y	100	
5254	Y	Y	Y	Y	Y	Y	Y	Y	Y	Y	100	
5255	Y	Y	Y	Y	Y	Y	Y	Y	Y	Y	100	
5260	Y	Y	Y	Y	Y	Y	Y	Y	Y	Y	100	
5265	Y	Y	Y	Y	Y	Y	Y	Y	Y	Y	100	
5270	Y	Y	Y	Y	Y	Y	Y	Y	Y	Y	100	
5275	Y	Y	Y	Y	Y	Y	Y	Y	Y	Y	100	
5280	Y	Y	Y	Y	Y	Y	Y	Y	Y	Y	100	
5285	Y	Y	Y	Y	Y	Y	Y	Y	Y	Y	100	
5286	Y	Y	Y	Y	Y	Y	Y	Y	Y	Y	100	
5287	Y	Y	Y	Y	Y	Y	Y	Y	Y	Y	100	
5288	Y	Y	Y	Y	Y	Y	Y	Y	Y	Y	100	
5289	Y	Y	Y	Y	Y	Y	Y	Y	Y	Y	100	FH
5290	Y	Y	Y	Y	Y	Y	Y	Y	Y	Y	100	
5291	Y	Y	Y	Y	Y	Y	Y	Y	Y	Y	100	
EUT Bandwidth (MHz)												36.505
Result												PASS

Channel 5510MHz

Radar Type		0											
Channel Bandwidth (MHz)		40											
Radar Freq. (MHz)	Trial Number (Y=Detection, N= No Detection)										Detection Rate (%)	FL/FH	
	1	2	3	4	5	6	7	8	9	10			
5489	Y	Y	Y	Y	Y	Y	Y	Y	N	Y	Y	90	
5490	Y	Y	Y	Y	Y	Y	Y	Y	Y	Y	Y	100	
5491	Y	Y	Y	Y	Y	Y	Y	Y	Y	Y	Y	100	FL
5492	Y	Y	Y	Y	Y	Y	Y	Y	Y	Y	Y	100	
5493	Y	Y	Y	Y	Y	Y	Y	Y	Y	Y	Y	100	
5494	Y	Y	Y	Y	Y	Y	Y	Y	Y	Y	Y	100	
5495	Y	Y	Y	Y	Y	Y	Y	Y	Y	Y	Y	100	
5500	Y	Y	Y	Y	Y	Y	Y	Y	Y	Y	Y	100	
5505	Y	Y	Y	Y	Y	Y	Y	Y	Y	Y	Y	100	
5510	Y	Y	Y	Y	Y	Y	Y	Y	Y	Y	Y	100	
5515	Y	Y	Y	Y	Y	Y	Y	Y	Y	Y	Y	100	
5520	Y	Y	Y	Y	Y	Y	Y	Y	Y	Y	Y	100	
5525	Y	Y	Y	Y	Y	Y	Y	Y	Y	Y	Y	100	
5526	Y	Y	Y	Y	Y	Y	Y	Y	Y	Y	Y	100	
5527	Y	Y	Y	Y	Y	Y	Y	Y	Y	Y	Y	100	
5528	Y	Y	Y	Y	Y	Y	Y	Y	Y	Y	Y	100	
5529	Y	Y	Y	Y	Y	Y	Y	Y	Y	Y	Y	100	FH
5530	Y	Y	Y	Y	Y	Y	Y	Y	Y	Y	Y	100	
5531	Y	Y	Y	Y	Y	Y	Y	Y	Y	Y	Y	100	
EUT Bandwidth (MHz)												36.484	
Result												PASS	

Channel 5290MHz

Radar Type		0											
Channel Bandwidth (MHz)		80											
Radar Freq. (MHz)	Trial Number (Y=Detection, N= No Detection)										Detection Rate (%)	FL/FH	
	1	2	3	4	5	6	7	8	9	10			
5269	Y	Y	Y	Y	Y	Y	Y	Y	N	Y	Y	90	
5270	Y	Y	Y	Y	Y	Y	Y	Y	Y	Y	Y	100	
5271	Y	Y	Y	Y	Y	Y	Y	Y	Y	Y	Y	100	FL
5272	Y	Y	Y	Y	Y	Y	Y	Y	Y	Y	Y	100	
5273	Y	Y	Y	Y	Y	Y	Y	Y	Y	Y	Y	100	
5274	Y	Y	Y	Y	Y	Y	Y	Y	Y	Y	Y	100	
5275	Y	Y	Y	Y	Y	Y	Y	Y	Y	Y	Y	100	
5280	Y	Y	Y	Y	Y	Y	Y	Y	Y	Y	Y	100	
5285	Y	Y	Y	Y	Y	Y	Y	Y	Y	Y	Y	100	
5290	Y	Y	Y	Y	Y	Y	Y	Y	Y	Y	Y	100	
5295	Y	Y	Y	Y	Y	Y	Y	Y	Y	Y	Y	100	
5300	Y	Y	Y	Y	Y	Y	Y	Y	Y	Y	Y	100	
5305	Y	Y	Y	Y	Y	Y	Y	Y	Y	Y	Y	100	
5306	Y	Y	Y	Y	Y	Y	Y	Y	Y	Y	Y	100	
5307	Y	Y	Y	Y	Y	Y	Y	Y	Y	Y	Y	100	
5308	Y	Y	Y	Y	Y	Y	Y	Y	Y	Y	Y	100	
5309	Y	Y	Y	Y	Y	Y	Y	Y	Y	Y	Y	100	FH
5310	Y	Y	Y	Y	Y	Y	Y	Y	Y	Y	Y	100	
5311	Y	Y	Y	Y	Y	Y	Y	Y	Y	Y	Y	100	
EUT Bandwidth (MHz)												78.042	
Result												PASS	

Channel 5530MHz

Radar Type		0										
Channel Bandwidth (MHz)		80										
Radar Freq. (MHz)	Trial Number (Y=Detection, N= No Detection)										Detection Rate (%)	FL/FH
	1	2	3	4	5	6	7	8	9	10		
5509	Y	Y	Y	Y	Y	Y	Y	N	Y	Y	90	
5510	Y	Y	Y	Y	Y	Y	Y	Y	Y	Y	100	
5511	Y	Y	Y	Y	Y	Y	Y	Y	Y	Y	100	FL
5512	Y	Y	Y	Y	Y	Y	Y	Y	Y	Y	100	
5513	Y	Y	Y	Y	Y	Y	Y	Y	Y	Y	100	
5514	Y	Y	Y	Y	Y	Y	Y	Y	Y	Y	100	
5515	Y	Y	Y	Y	Y	Y	Y	Y	Y	Y	100	
5520	Y	Y	Y	Y	Y	Y	Y	Y	Y	Y	100	
5525	Y	Y	Y	Y	Y	Y	Y	Y	Y	Y	100	
5530	Y	Y	Y	Y	Y	Y	Y	Y	Y	Y	100	
5535	Y	Y	Y	Y	Y	Y	Y	Y	Y	Y	100	
5540	Y	Y	Y	Y	Y	Y	Y	Y	Y	Y	100	
5545	Y	Y	Y	Y	Y	Y	Y	Y	Y	Y	100	
5546	Y	Y	Y	Y	Y	Y	Y	Y	Y	Y	100	
5547	Y	Y	Y	Y	Y	Y	Y	Y	Y	Y	100	
5548	Y	Y	Y	Y	Y	Y	Y	Y	Y	Y	100	
5549	Y	Y	Y	Y	Y	Y	Y	Y	Y	Y	100	FH
5550	Y	Y	Y	Y	Y	Y	Y	Y	Y	Y	100	
5551	Y	Y	Y	Y	Y	Y	Y	Y	Y	Y	100	
EUT Bandwidth (MHz)											36.049	
Result											PASS	

5.4. Channel Availability Check (CAC)

5.4.1. Channel Availability Check Limit

Channel Availability Check Limit

- The EUT shall perform a Channel Availability Check to ensure that there is no radar operating on the channel. After power-up sequence, receive at least 1 minute (60 sec) on the intended operating frequency.

5.4.2. Measuring Instruments

Refer a test equipment and calibration data table in this test report

5.4.3. Test Procedures

Test Method

- Refer as KDB905462 D02 UNII DFS Compliance Procedures New Rules v02, clause 7.8.2.1 for Initial Channel Availability Check Time. The EUT does not emit beacon, control, or data signals on the test Channel until the power-up sequence has been completed and the UNII device checks for Radar Waveforms for one minute on the test Channel. This test does not use any Radar Waveforms.
- Refer as FCC 06-96 Appendix, clause 7.8.2.2 for Radar Burst at the Beginning of the Channel Availability Check Time. To verify successful radar detection on the selected Channel during a period equal to the Beginning of the Channel Availability Check Time.
- Refer as FCC 06-96 Appendix, clause 7.8.2.3 for Radar Burst at the End of the Channel Availability Check Time. To verify successful radar detection on the selected Channel during a period equal to the End of the Channel Availability Check Time.

5.4.4. Test Result of Channel Availability Check Time

Initial Channel Availability Check Time Result					
Modulation Mode	Freq.(MHz)	Radar Test Signal	Power-on Cycle(sec)	CAC Time (sec)	Observation Time (min)
VHT40	5270	0	92.54	60	2.5
Result 150s Timing Plot			PASS		

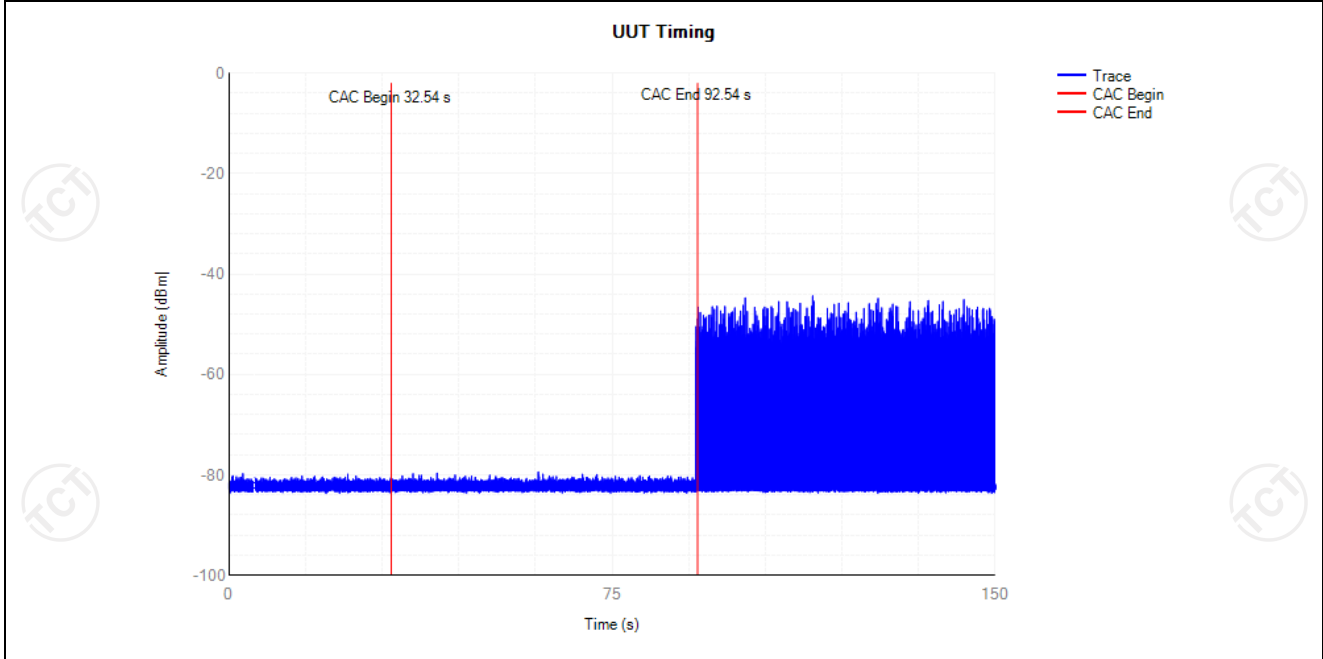

Beginning CAC of 150s Timing Plot

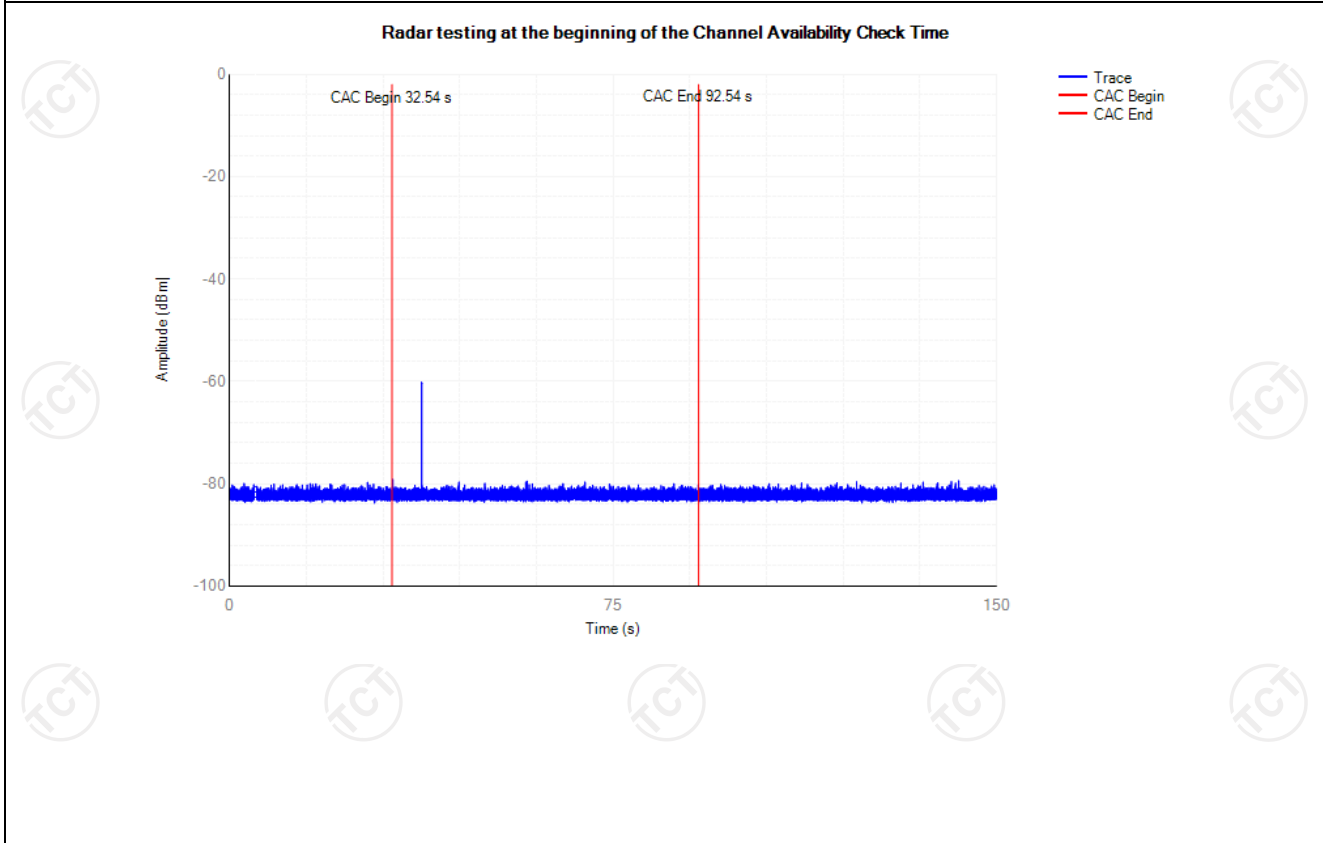

End CAC of 150s Timing Plot

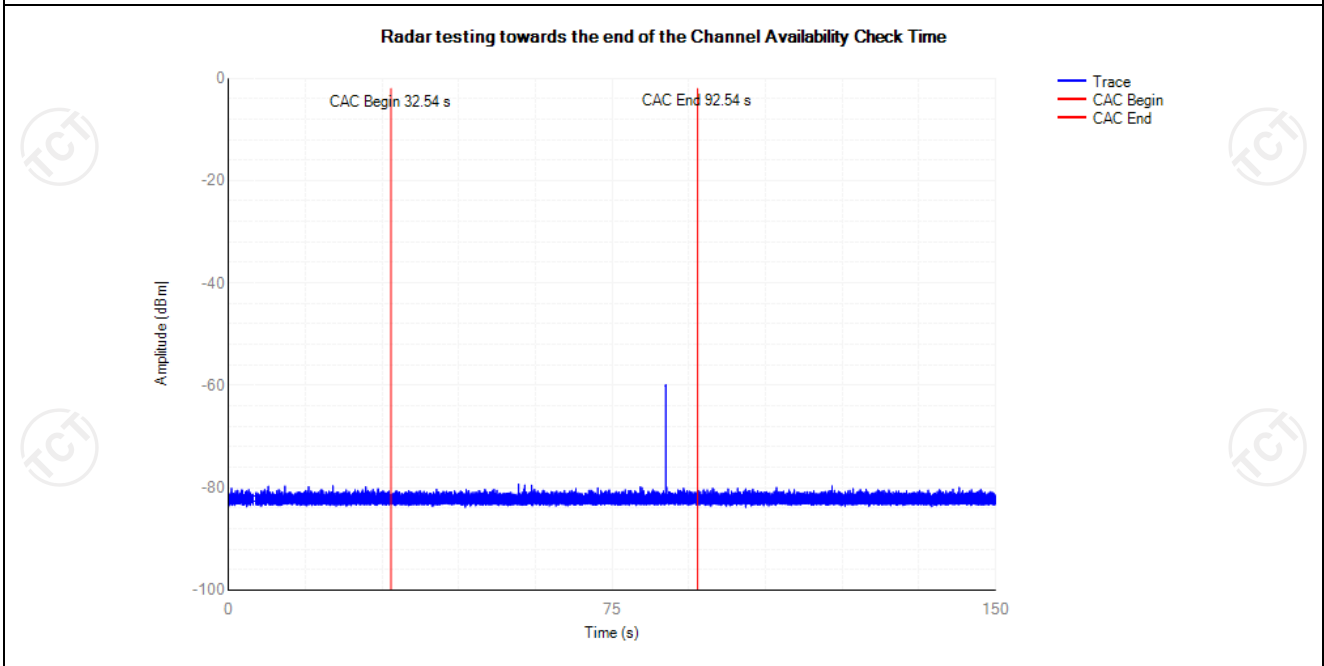

Initial Channel Availability Check Time Result

Modulation Mode	Freq.(MHz)	Radar Test Signal	Power-on Cycle(sec)	CAC Time (sec)	Observation Time (min)
VHT40	5510	0	92.12	60	2.5

Result 150s Timing Plot

PASS

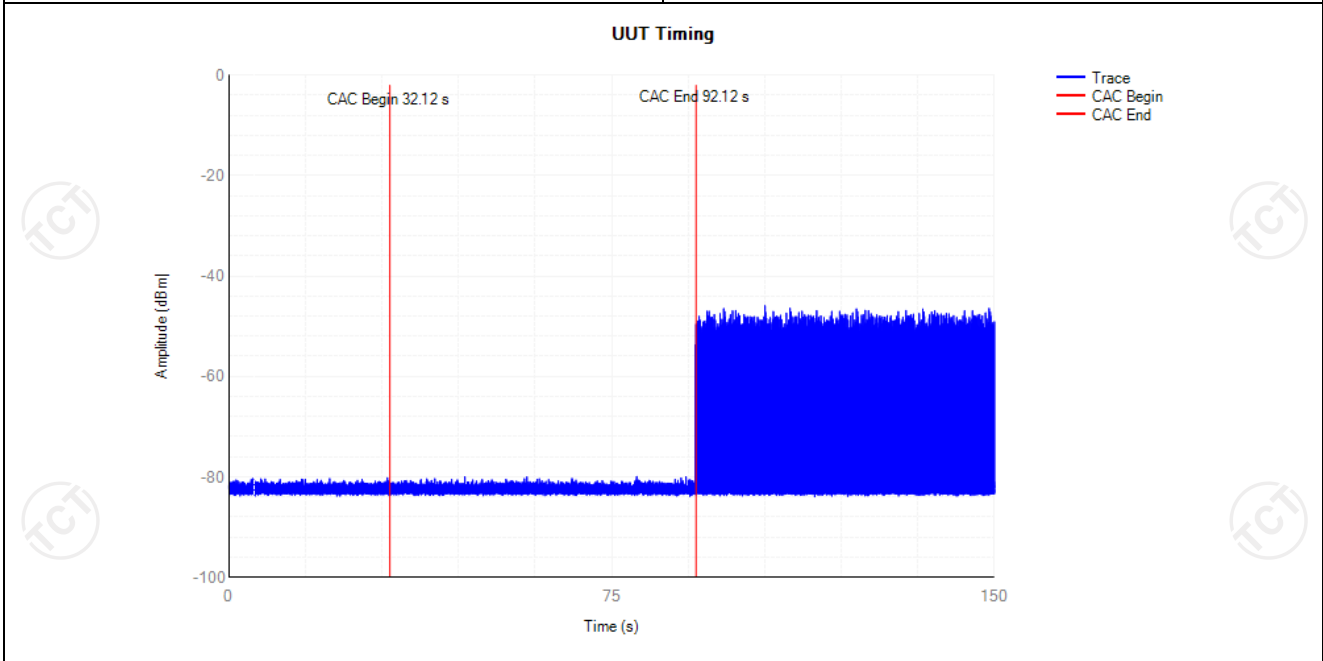

Beginning CAC of 150s Timing Plot

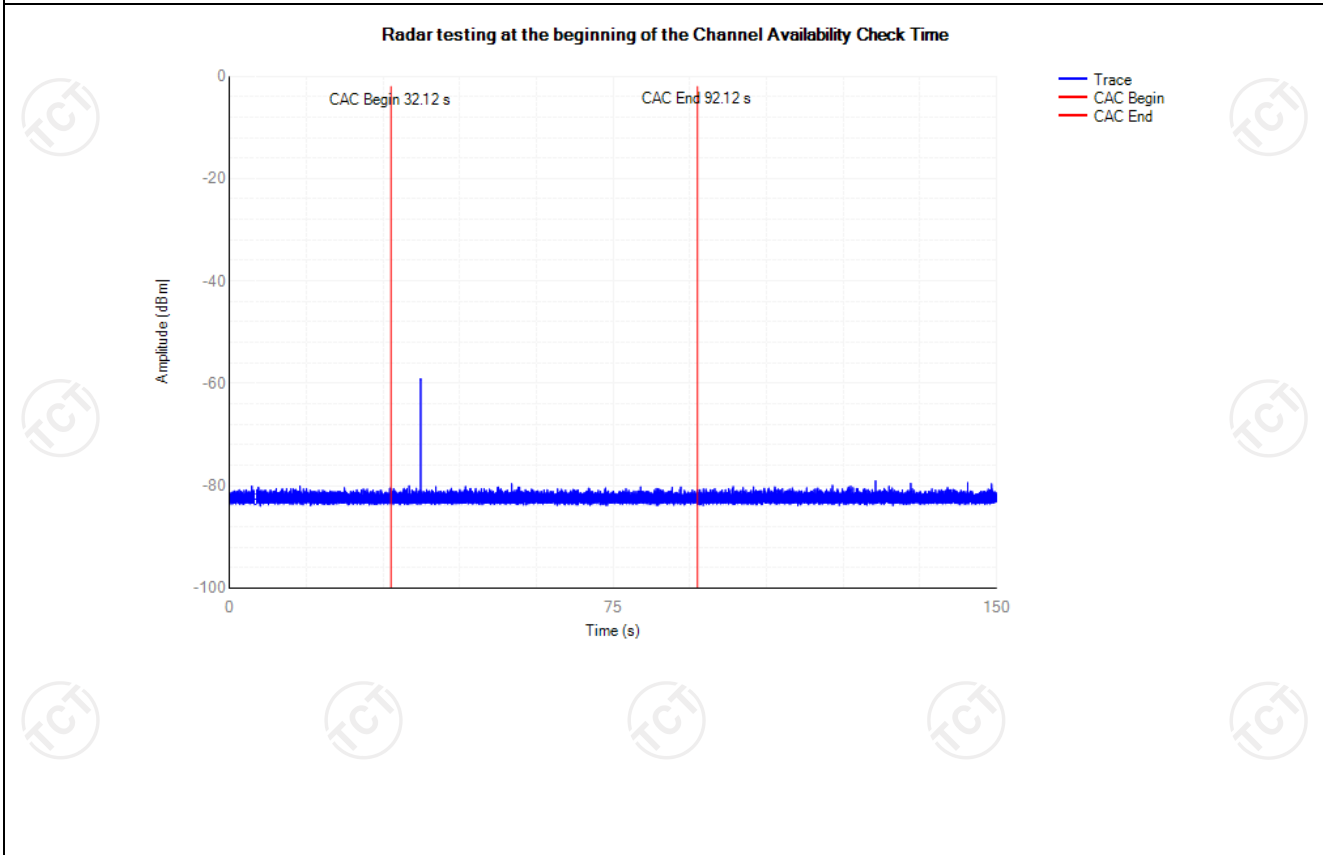

End CAC of 150s Timing Plot

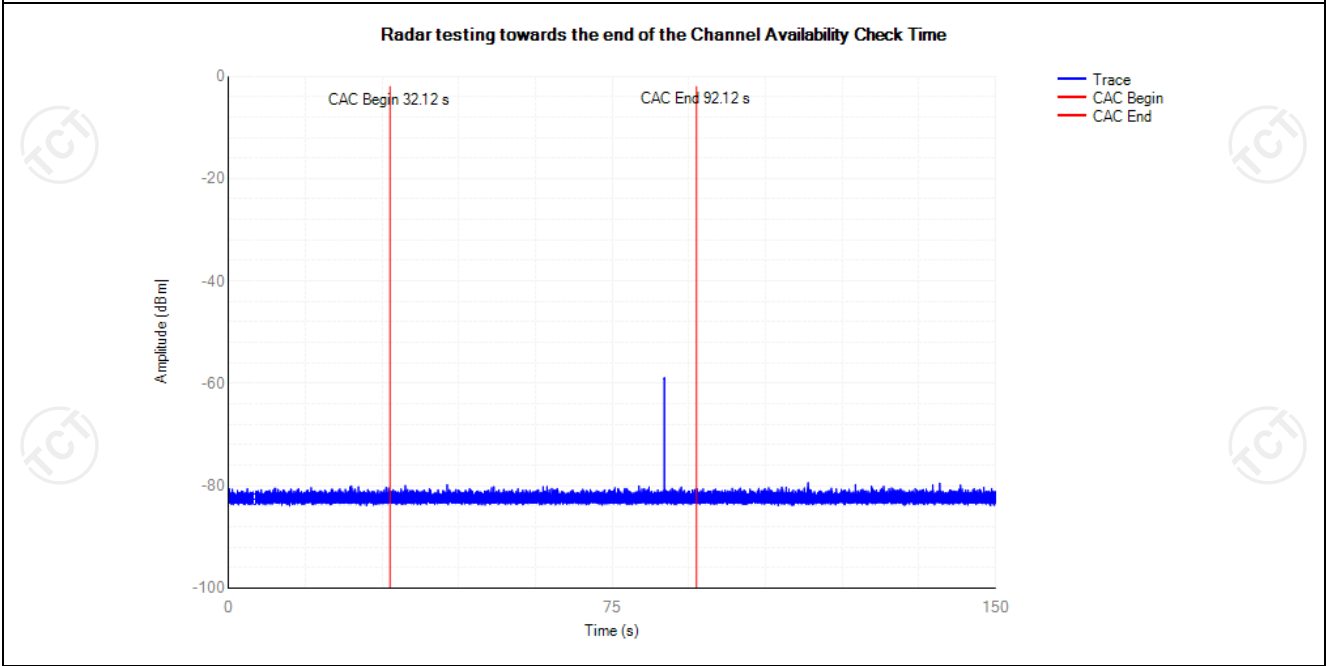

5.5. In-service Monitoring

5.5.1. In-service Monitoring Limit

In-service Monitoring Limit	
Channel Move Time	10 sec
Channel Closing Transmission Time	200 ms + an aggregate of 60 ms over remaining 10 sec periods.
Non-occupancy period	Minimum 30 minutes

5.5.2. Measuring Instruments

Refer a test equipment and calibration data table in this test report

5.5.3. Test Procedures

Test Method
<p><input checked="" type="checkbox"/> Refer as KDB905462 D02 UNII DFS Compliance Procedures New Rules v02, clause 7.8.3 verified during In-Service Monitoring; Channel Closing Transmission Time, Channel Move Time. Client Device will associate with the EUT. Observe the transmissions of the EUT at the end of the radar Burst on the Operating Channel for duration greater than 10 seconds. Measure and record the transmissions from the EUT during the observation time (Channel Move Time). Compare the Channel Move Time and Channel Closing Transmission Time limits.</p>
<p><input checked="" type="checkbox"/> Refer as KDB905462 D02 UNII DFS Compliance Procedures New Rules v02, clause 8.3 verified during In-Service Monitoring; Channel Closing Transmission Time, Channel Move Time. One 10 sec plot needs to be reported for the Short Pulse Radar Types 1-4 and one for the Long Pulse Radar Type in a 22 sec plot. And zoom-in a 600 ms plot verified channel closing time for the aggregate transmission time starting from 200ms after the end of the radar signal to the completion of the channel move.</p>
<p><input checked="" type="checkbox"/> Refer as KDB905462 D02 UNII DFS Compliance Procedures New Rules v02, clause 7.8.3 verified during In-Service Monitoring; Non-Occupancy Period. Client Device will associate with the EUT. Observe the transmissions of the EUT at the end of the radar Burst on the Operating Channel for duration greater than 10 seconds. Measure and record the transmissions from the EUT during the observation time (Non-Occupancy Period). Compare the Non-Occupancy Period limits.</p>

5.5.4. Test Result of In-service Monitoring

Channel Closing Transmission Time and Channel Move Time Result

Modulation Mode	Freq. (MHz)	Channel Move Time (s)	Limit Channel Move Time (s)	Close Transmission Time (s)	Limit Close Transmission Time (s)	Close Transmission Time after 200ms(s)	Limit Close Transmission Time after 200ms (s)	Verdict
VHT40	5270	0.3496	10	0.0032	0.26	0.0016	0.06	Pass

12 sec Timing Plot

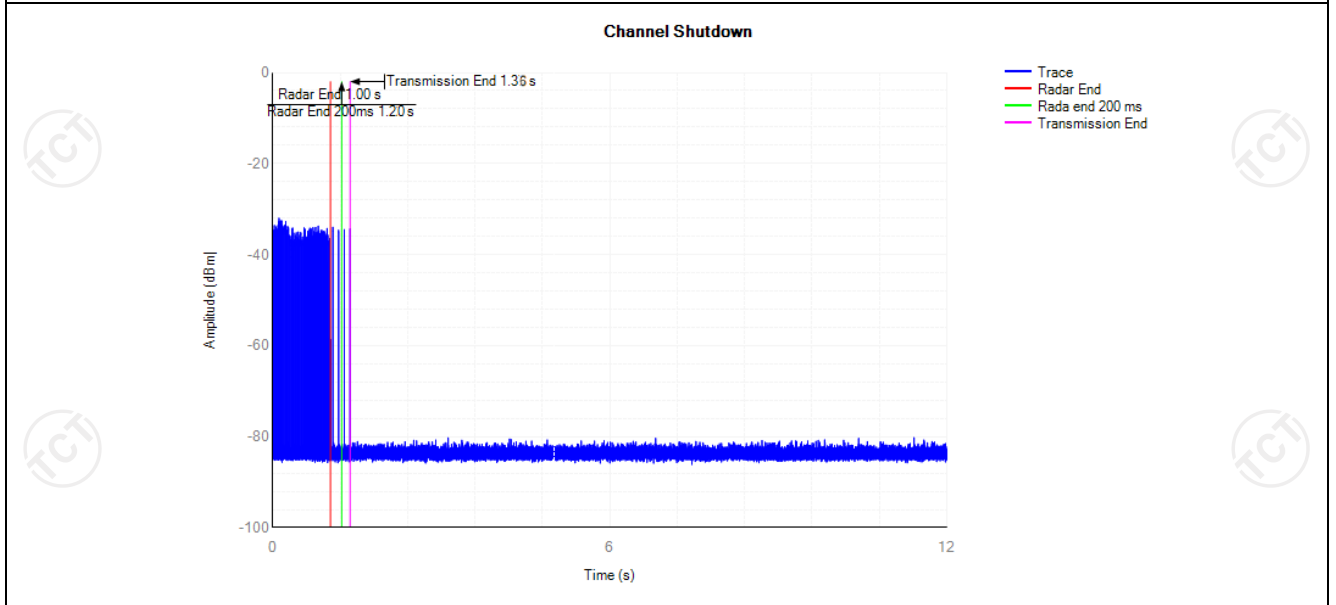

Non-Occupancy Period Result

Modulation Mode	Freq. (MHz)	Non-Occupancy Period		
		Measured	Limit	Verdict
HT40	5270	>30min	30min	PASS

1850 sec Timing Plot

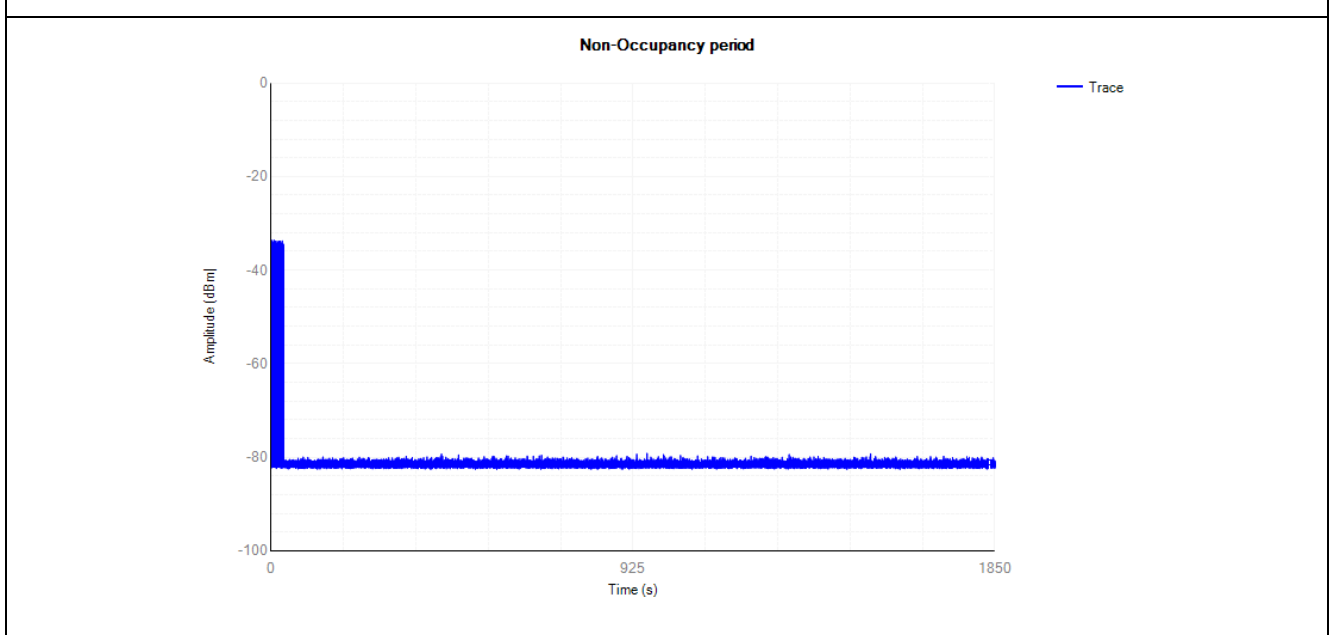

Channel Closing Transmission Time and Channel Move Time Result

Modulation Mode	Freq. (MHz)	Channel Move Time (s)	Limit Channel Move Time (s)	Close Transmission Time (s)	Limit Close Transmission Time (s)	Close Transmission Time after 200ms(s)	Limit Close Transmission Time after 200ms (s)	Verdict
VHT40	5510	0.3936	10	0.0032	0.26	0.0016	0.06	Pass

12 sec Timing Plot

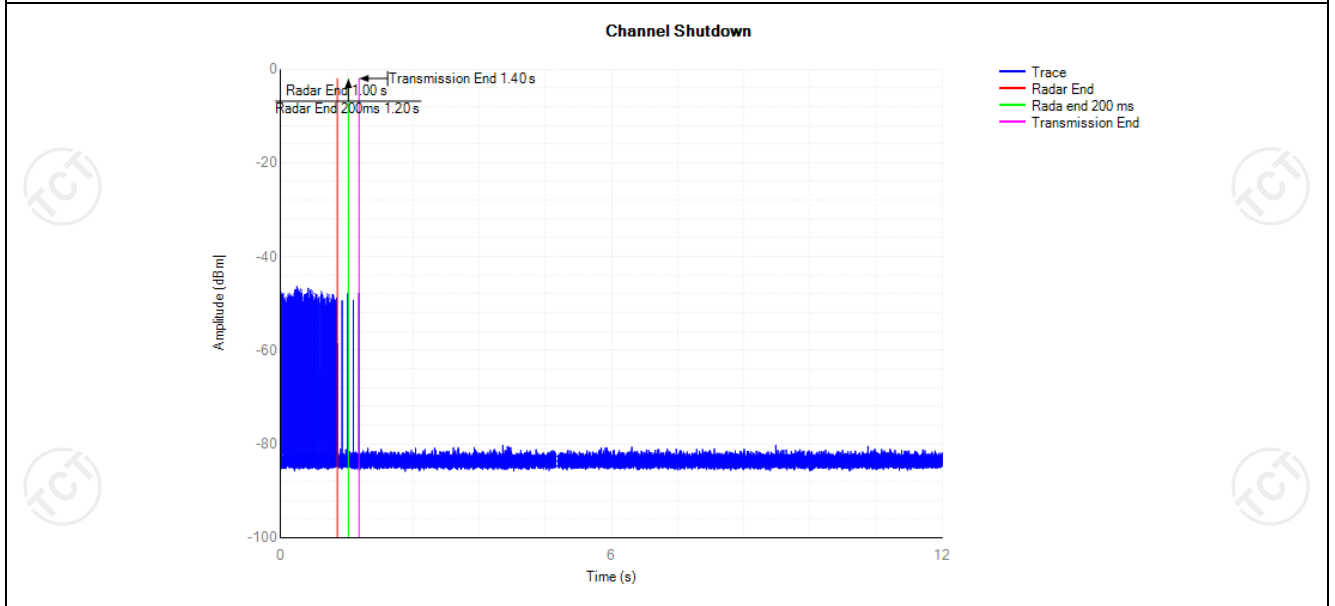

Non-Occupancy Period Result

Modulation Mode	Freq. (MHz)	Non-Occupancy Period		
		Measured	Limit	Verdict
VHT40	5510	>30min	30min	PASS

1850 sec Timing Plot

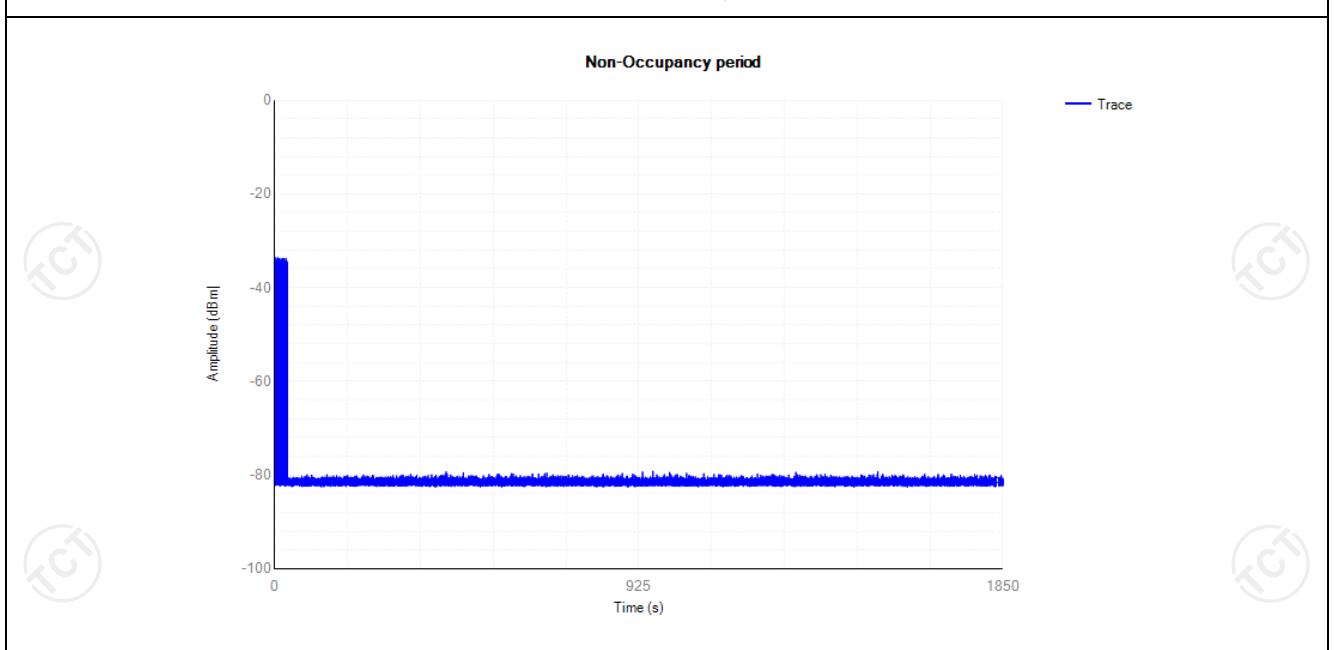

5.6. Statistical Performance Check

5.6.1. Statistical Performance Check Limit

Radar Type	Minimum Percentage of Successful Detection (Pd)	Minimum Trials
1	60%	30
2	60%	30
3	60%	30
4	60%	30
Aggregate (Radar Types 1-4)	80%	120
5	80%	30
6	70%	30

The percentage of successful detection is calculated by:

$$\frac{\text{Total Waveform Detections}}{\text{Total Waveform Trails}} \times 100 = \text{Probability of Detection Radar Waveform}$$

In addition an aggregate minimum percentage of successful detection across all Short Pulse Radar Types 1-4 is required and is calculated as follows:

$$\frac{\text{Pd1} + \text{Pd2} + \text{Pd3} + \text{Pd4}}{4}$$

5.6.2. Measuring Instruments

Refer a test equipment and calibration data table in this test report

5.6.3. Test Procedures

Test Method
<input checked="" type="checkbox"/> Refer as KDB905462 D02 UNII DFS Compliance Procedures New Rules v02, clause 7.8.4 for Statistical Performance Check test. Stream the MPEG test file from the Master Device to the Client Device on the test Channel for the entire period of the test. Observe the transmissions of the UUT at the end of the Burst on the Operating Channel for duration greater than 10 seconds for Short Pulse Radar Types 1-4 and 6 to ensure detection occurs. Then Observe the transmissions of the UUT at the end of the Burst on the Operating Channel for duration greater than 22 seconds for Long Pulse Radar Type 5 to ensure detection occurs. The device can utilize a test mode to demonstrate when detection occurs to prevent the need to reset the device between trial runs.

5.6.4. Test Result

Channel 5300MHz / 20MHz BW

Y=Detection, N= No Detection						
Trial Number	Type1	Type2	Type3	Type4	Type5	Type6
1	Y	Y	Y	Y	Y	Y
2	Y	Y	Y	Y	Y	Y
3	Y	Y	Y	Y	Y	Y
4	Y	Y	Y	Y	Y	Y
5	Y	Y	Y	N	Y	Y
6	Y	Y	Y	Y	Y	Y
7	Y	Y	Y	Y	Y	Y
8	Y	Y	N	Y	Y	Y
9	N	Y	Y	Y	Y	Y
10	Y	Y	Y	Y	Y	Y
11	Y	Y	Y	Y	Y	Y
12	Y	Y	Y	Y	Y	Y
13	Y	Y	Y	Y	Y	Y
14	Y	Y	Y	Y	Y	Y
15	Y	Y	Y	Y	Y	Y
16	Y	Y	Y	Y	Y	Y
17	Y	Y	Y	Y	Y	Y
18	Y	Y	Y	Y	Y	N
19	Y	Y	Y	Y	N	Y
20	Y	Y	Y	Y	Y	Y
21	N	Y	Y	N	Y	Y
22	Y	Y	Y	Y	Y	Y
23	Y	Y	Y	Y	Y	Y
24	Y	Y	Y	Y	Y	Y
25	Y	Y	N	Y	Y	Y
26	N	Y	Y	Y	Y	Y
27	Y	Y	Y	Y	Y	Y
28	Y	Y	Y	Y	Y	Y
29	Y	Y	Y	Y	Y	Y
30	Y	Y	Y	Y	Y	Y
Number of Successful Detections	28	27	28	28	29	27
Percentage of Successful Detection	96.26%	96.32%	96.64%	93.28%	93.28%	90.26%
Limit	≥60%	≥60%	≥60%	≥60%	≥80%	≥70%
Aggregate of Radar Types 1-4			96.64%		Limit	≥80%

Channel 5270MHz / 40MHz BW

Y=Detection, N= No Detection						
Trial Number	Type1	Type2	Type3	Type4	Type5	Type6
1	Y	Y	Y	Y	Y	Y
2	Y	Y	Y	Y	Y	Y
3	Y	Y	Y	Y	Y	Y
4	Y	Y	Y	Y	Y	N
5	N	Y	Y	Y	Y	Y
6	Y	Y	Y	Y	Y	Y
7	Y	Y	Y	N	Y	Y
8	Y	Y	Y	Y	Y	Y
9	Y	Y	Y	Y	Y	Y
10	Y	Y	Y	Y	Y	Y
11	Y	N	Y	Y	Y	Y
12	Y	Y	Y	Y	Y	Y
13	Y	Y	Y	Y	Y	Y
14	Y	Y	Y	Y	Y	Y
15	Y	Y	Y	Y	Y	N
16	Y	Y	N	Y	Y	Y
17	Y	Y	Y	Y	Y	Y
18	Y	Y	Y	Y	Y	Y
19	Y	Y	Y	Y	Y	Y
20	Y	Y	Y	Y	Y	Y
21	N	Y	Y	Y	Y	Y
22	Y	Y	Y	Y	Y	Y
23	Y	Y	Y	Y	Y	Y
24	Y	N	N	Y	Y	Y
25	Y	Y	Y	Y	Y	N
26	Y	N	Y	Y	N	Y
27	Y	Y	Y	Y	Y	Y
28	Y	Y	Y	Y	Y	Y
29	Y	Y	Y	Y	Y	Y
30	Y	Y	Y	Y	Y	Y
Number of Successful Detections	28	27	26	27	26	28
Percentage of Successful Detection	96.52%	92.24%	92.24%	96.30%	96.30%	90.26%
Limit	≥60%	≥60%	≥60%	≥60%	≥80%	≥70%
Aggregate of Radar Types 1-4			96.52%		Limit	≥80%

Channel 5290MHz / 80MHz BW

Y=Detection, N= No Detection						
Trial Number	Type1	Type2	Type3	Type4	Type5	Type6
1	Y	Y	Y	Y	Y	Y
2	Y	Y	Y	Y	Y	Y
3	Y	Y	Y	Y	Y	Y
4	Y	Y	Y	Y	Y	N
5	N	Y	Y	Y	Y	Y
6	Y	Y	Y	Y	Y	Y
7	Y	Y	Y	N	Y	Y
8	Y	Y	Y	Y	Y	Y
9	Y	Y	Y	Y	Y	Y
10	Y	Y	Y	Y	Y	Y
11	Y	N	Y	Y	Y	Y
12	Y	Y	Y	Y	Y	Y
13	Y	Y	Y	Y	Y	Y
14	Y	Y	Y	Y	Y	Y
15	Y	Y	Y	Y	Y	N
16	Y	Y	N	Y	Y	Y
17	Y	Y	Y	Y	Y	Y
18	Y	Y	Y	Y	Y	Y
19	Y	Y	Y	Y	Y	Y
20	Y	Y	Y	Y	Y	Y
21	N	Y	Y	Y	Y	N
22	Y	Y	Y	Y	Y	Y
23	Y	Y	Y	Y	Y	Y
24	Y	N	N	Y	Y	Y
25	Y	Y	Y	Y	Y	N
26	Y	N	Y	Y	N	Y
27	Y	Y	Y	Y	Y	Y
28	Y	Y	Y	Y	Y	Y
29	Y	Y	Y	Y	Y	Y
30	Y	Y	Y	Y	Y	Y
Number of Successful Detections	28	28	27	28	29	28
Percentage of Successful Detection	96.26%	96.67%	96.65%	93.48%	93.48%	90.58%
Limit	≥60%	≥60%	≥60%	≥60%	≥80%	≥70%
Aggregate of Radar Types 1-4			96.67%		Limit	≥80%

Y=Detection, N= No Detection						
Trial Number	Type1	Type2	Type3	Type4	Type5	Type6
1	Y	Y	Y	Y	Y	Y
2	Y	Y	Y	Y	Y	Y
3	Y	Y	Y	Y	Y	Y
4	Y	Y	Y	Y	Y	Y
5	Y	Y	Y	N	Y	Y
6	Y	Y	Y	Y	Y	Y
7	Y	Y	Y	Y	Y	Y
8	Y	Y	N	Y	Y	Y
9	N	Y	Y	Y	Y	Y
10	Y	Y	Y	Y	Y	Y
11	Y	Y	Y	Y	Y	Y
12	Y	Y	Y	Y	Y	Y
13	Y	Y	Y	Y	Y	Y
14	Y	Y	Y	Y	Y	Y
15	Y	Y	Y	Y	Y	Y
16	Y	Y	Y	Y	Y	Y
17	Y	Y	Y	Y	Y	Y
18	Y	Y	Y	Y	Y	N
19	Y	Y	Y	Y	N	Y
20	Y	Y	Y	Y	Y	Y
21	N	Y	Y	N	Y	Y
22	Y	Y	Y	Y	Y	Y
23	Y	Y	Y	Y	Y	Y
24	Y	Y	Y	Y	Y	Y
25	Y	Y	N	Y	Y	Y
26	N	Y	Y	Y	Y	Y
27	Y	Y	Y	Y	Y	Y
28	Y	Y	Y	Y	Y	Y
29	Y	Y	Y	Y	Y	Y
30	Y	Y	Y	Y	Y	Y
Number of Successful Detections	28	27	28	28	29	27
Percentage of Successful Detection	96.26%	96.32%	96.64%	93.28%	93.28%	90.26%
Limit	≥60%	≥60%	≥60%	≥60%	≥80%	≥70%
Aggregate of Radar Types 1-4			96.64%		Limit	≥80%

Y=Detection, N= No Detection						
Trial Number	Type1	Type2	Type3	Type4	Type5	Type6
1	Y	Y	Y	Y	Y	Y
2	Y	Y	Y	Y	Y	Y
3	Y	Y	Y	Y	Y	Y
4	Y	Y	Y	Y	Y	N
5	N	Y	Y	Y	Y	Y
6	Y	Y	Y	Y	Y	Y
7	Y	Y	Y	N	Y	Y
8	Y	Y	Y	Y	Y	Y
9	Y	Y	Y	Y	Y	Y
10	Y	Y	Y	Y	Y	Y
11	Y	N	Y	Y	Y	Y
12	Y	Y	Y	Y	Y	Y
13	Y	Y	Y	Y	Y	Y
14	Y	Y	Y	Y	Y	Y
15	Y	Y	Y	Y	Y	N
16	Y	Y	N	Y	Y	Y
17	Y	Y	Y	Y	Y	Y
18	Y	Y	Y	Y	Y	Y
19	Y	Y	Y	Y	Y	Y
20	Y	Y	Y	Y	Y	Y
21	N	Y	Y	Y	Y	Y
22	Y	Y	Y	Y	Y	Y
23	Y	Y	Y	Y	Y	Y
24	Y	N	N	Y	Y	Y
25	Y	Y	Y	Y	Y	N
26	Y	N	Y	Y	N	Y
27	Y	Y	Y	Y	Y	Y
28	Y	Y	Y	Y	Y	Y
29	Y	Y	Y	Y	Y	Y
30	Y	Y	Y	Y	Y	Y
Number of Successful Detections	28	27	26	27	26	28
Percentage of Successful Detection	96.52%	92.24%	92.24%	96.30%	96.30%	90.26%
Limit	≥60%	≥60%	≥60%	≥60%	≥80%	≥70%
Aggregate of Radar Types 1-4			96.52%		Limit	≥80%

Channel 5530MHz / 80MHz BW

Y=Detection, N= No Detection						
Trial Number	Type1	Type2	Type3	Type4	Type5	Type6
1	Y	Y	Y	Y	Y	Y
2	Y	Y	Y	Y	Y	Y
3	Y	Y	Y	Y	Y	Y
4	Y	Y	Y	Y	Y	N
5	N	Y	Y	Y	Y	Y
6	Y	Y	Y	Y	Y	Y
7	Y	Y	Y	N	Y	Y
8	Y	Y	Y	Y	Y	Y
9	Y	Y	Y	Y	Y	Y
10	Y	Y	Y	Y	Y	Y
11	Y	N	Y	Y	Y	Y
12	Y	Y	Y	Y	Y	Y
13	Y	Y	Y	Y	Y	Y
14	Y	Y	Y	Y	Y	Y
15	Y	Y	Y	Y	Y	N
16	Y	Y	N	Y	Y	Y
17	Y	Y	Y	Y	Y	Y
18	Y	Y	Y	Y	Y	Y
19	Y	Y	Y	Y	Y	Y
20	Y	Y	Y	Y	Y	Y
21	N	Y	Y	Y	Y	N
22	Y	Y	Y	Y	Y	Y
23	Y	Y	Y	Y	Y	Y
24	Y	N	N	Y	Y	Y
25	Y	Y	Y	Y	Y	N
26	Y	N	Y	Y	N	Y
27	Y	Y	Y	Y	Y	Y
28	Y	Y	Y	Y	Y	Y
29	Y	Y	Y	Y	Y	Y
30	Y	Y	Y	Y	Y	Y
Number of Successful Detections	28	28	27	28	29	28
Percentage of Successful Detection	96.26%	96.67%	96.65%	93.48%	93.48%	90.58%
Limit	≥60%	≥60%	≥60%	≥60%	≥80%	≥70%
Aggregate of Radar Types 1-4			96.67%		Limit	≥80%

5.6.5. Detection Data Sheet for Radar Types 1, 5, and 6

Band2A

Y=Detection, N= No Detection									
Trial Number	Type1			Type5			Type6		
	CH5300	CH5270	CH5290	CH5300	CH5270	CH5290	CH5300	CH5270	CH5290
1	Y	Y	Y	Y	Y	Y	Y	Y	Y
2	Y	Y	Y	Y	Y	Y	Y	Y	Y
3	Y	Y	Y	Y	Y	Y	Y	Y	Y
4	Y	Y	Y	Y	Y	Y	Y	N	N
5	Y	N	N	Y	Y	Y	Y	Y	Y
6	Y	Y	Y	Y	Y	Y	Y	Y	Y
7	Y	Y	Y	Y	Y	Y	Y	Y	Y
8	Y	Y	Y	Y	Y	Y	Y	Y	Y
9	N	Y	Y	Y	Y	Y	Y	Y	Y
10	Y	Y	Y	Y	Y	Y	Y	Y	Y
11	Y	Y	Y	Y	Y	Y	Y	Y	Y
12	Y	Y	Y	Y	Y	Y	Y	Y	Y
13	Y	Y	Y	Y	Y	Y	Y	Y	Y
14	Y	Y	Y	Y	Y	Y	Y	Y	Y
15	Y	Y	Y	Y	Y	Y	Y	N	N
16	Y	Y	Y	Y	Y	Y	Y	Y	Y
17	Y	Y	Y	Y	Y	Y	Y	Y	Y
18	Y	Y	Y	Y	Y	Y	N	Y	Y
19	Y	Y	Y	N	Y	Y	Y	Y	Y
20	Y	Y	Y	Y	Y	Y	Y	Y	Y
21	N	N	N	Y	Y	Y	Y	Y	N
22	Y	Y	Y	Y	Y	Y	Y	Y	Y
23	Y	Y	Y	Y	Y	Y	Y	Y	Y
24	Y	Y	Y	Y	Y	Y	Y	Y	Y
25	Y	Y	Y	Y	Y	Y	Y	N	N
26	N	Y	Y	N	Y	N	N	Y	Y
27	Y	Y	Y	Y	Y	Y	Y	Y	Y
28	Y	Y	Y	Y	Y	Y	Y	Y	Y
29	Y	Y	Y	Y	Y	Y	Y	Y	Y
30	Y	Y	Y	Y	Y	Y	Y	Y	Y

Y=Detection, N= No Detection

Band2C

Y=Detection, N= No Detection									
Trial Number	Type1			Type5			Type6		
	CH5500	CH5510	CH5530	CH5500	CH5510	CH5530	CH5500	CH5510	CH5530
1	Y	Y	Y	Y	Y	Y	Y	Y	Y
2	Y	Y	Y	Y	Y	Y	Y	Y	Y
3	Y	Y	Y	Y	Y	Y	Y	Y	Y
4	Y	Y	Y	Y	Y	Y	Y	Y	N
5	Y	Y	N	Y	Y	Y	Y	Y	Y
6	Y	Y	Y	Y	Y	Y	Y	Y	Y
7	Y	Y	Y	Y	Y	Y	N	Y	Y
8	Y	Y	Y	N	Y	Y	Y	Y	Y
9	Y	Y	Y	Y	N	Y	Y	Y	Y
10	Y	Y	Y	Y	Y	Y	Y	Y	Y
11	Y	Y	Y	Y	Y	Y	Y	Y	Y
12	Y	N	Y	Y	Y	Y	Y	Y	Y
13	Y	Y	Y	Y	Y	Y	Y	Y	Y
14	N	Y	Y	Y	Y	Y	Y	N	Y
15	Y	Y	Y	N	Y	Y	Y	Y	N
16	Y	Y	Y	Y	Y	Y	Y	Y	Y
17	Y	Y	Y	Y	Y	Y	Y	Y	Y
18	Y	Y	Y	Y	Y	Y	Y	Y	Y
19	Y	Y	Y	N	Y	Y	N	Y	Y
20	Y	Y	Y	Y	Y	Y	Y	Y	Y
21	Y	Y	N	Y	N	Y	Y	Y	N
22	Y	Y	Y	Y	Y	Y	Y	Y	Y
23	Y	Y	Y	Y	Y	Y	Y	Y	Y
24	Y	Y	Y	Y	Y	Y	Y	Y	Y
25	Y	Y	Y	Y	Y	Y	Y	Y	N
26	Y	Y	Y	Y	Y	N	Y	Y	Y
27	Y	Y	Y	Y	Y	Y	Y	Y	Y
28	Y	Y	Y	Y	Y	Y	Y	N	Y
29	Y	Y	Y	Y	Y	Y	N	Y	Y
30	Y	Y	Y	Y	Y	Y	Y	Y	Y

Y=Detection, N= No Detection

5.6.6. Data Sheet for Radar Type 2

Band2A

Radar Type	2					
Trail #	Pulse Width (us)	PRI (us)	Pulses / Burst	CH5300	CH5270	CH5290
1	2.73	169	28	Y	Y	Y
2	4.46	178	27	Y	Y	Y
3	4.13	212	29	Y	Y	Y
4	1.87	199	27	Y	Y	Y
5	3.73	188	27	Y	Y	Y
6	1.88	229	28	Y	Y	Y
7	1.88	154	23	Y	Y	Y
8	3.51	167	26	Y	Y	Y
9	1.50	157	24	Y	Y	Y
10	1.40	220	23	Y	Y	Y
11	3.41	224	28	Y	N	N
12	4.12	183	27	Y	Y	Y
13	3.45	225	27	Y	Y	Y
14	1.54	215	27	Y	Y	Y
15	4.08	182	27	Y	Y	Y
16	1.68	196	25	Y	Y	Y
17	1.43	228	26	Y	Y	Y
18	3.53	165	26	Y	Y	Y
19	1.72	210	25	Y	Y	Y
20	1.29	176	28	Y	Y	Y
21	3.32	155	29	Y	Y	Y
22	3.91	170	27	N	Y	Y
23	3.45	176	25	Y	Y	Y
24	1.77	198	27	Y	N	N
25	4.05	154	27	Y	Y	Y
26	1.53	155	28	Y	N	N
27	1.40	188	25	Y	Y	Y
28	3.90	178	28	Y	Y	Y
29	1.70	173	26	Y	Y	Y
30	1.55	208	26	Y	Y	Y
Detection Percentage (%)				96.62	90.53	91.47
Y=Detection, N= No Detection						

Band2C

Radar Type	2					
Trail #	Pulse Width (us)	PRI (us)	Pulses / Burst	CH5500	CH5510	CH5530
1	2.90	170	28	Y	Y	Y
2	4.47	179	27	Y	Y	Y
3	3.89	213	29	Y	Y	Y
4	1.37	200	27	Y	Y	Y
5	3.65	189	27	Y	N	Y
6	1.86	230	28	Y	Y	Y
7	1.34	155	23	Y	Y	Y
8	3.48	168	26	Y	Y	Y
9	1.47	158	24	Y	Y	Y
10	1.35	221	23	Y	Y	Y
11	2.71	228	28	Y	Y	N
12	3.81	189	27	Y	Y	Y
13	3.70	228	27	Y	Y	Y
14	1.34	210	27	Y	Y	Y
15	4.24	180	27	Y	Y	Y
16	1.43	190	25	Y	Y	Y
17	1.86	223	26	Y	N	Y
18	3.93	169	26	Y	Y	Y
19	1.72	207	25	Y	Y	Y
20	1.33	175	28	Y	Y	Y
21	2.97	152	29	N	Y	Y
22	3.82	168	27	Y	Y	Y
23	3.93	177	25	Y	Y	Y
24	1.71	198	27	Y	Y	N
25	3.95	151	27	Y	Y	Y
26	1.90	155	28	Y	N	N
27	1.94	188	24	Y	Y	Y
28	3.45	178	25	Y	Y	Y
29	1.15	173	25	Y	Y	Y
30	1.21	208	28	Y	Y	Y
Detection Percentage (%)				96.57	90.42	91.47
Y=Detection, N= No Detection						

5.6.7. Data Sheet for Radar Type 3

Band2A

Radar Type	3					
Trail #	Pulse Width (us)	PRI (us)	Pulses / Burst	CH5300	CH5270	CH5290
1	5.65	390	17	Y	Y	Y
2	8.41	409	17	Y	Y	Y
3	8.70	490	16	Y	Y	Y
4	7.18	394	17	Y	Y	Y
5	7.40	200	16	Y	Y	Y
6	8.48	226	16	Y	Y	Y
7	7.10	476	15	Y	Y	Y
8	6.90	496	16	N	Y	Y
9	7.62	491	15	Y	Y	Y
10	7.74	304	16	Y	Y	Y
11	9.25	443	17	Y	Y	Y
12	7.27	263	16	Y	Y	Y
13	7.53	461	17	Y	Y	Y
14	5.63	242	18	Y	Y	Y
15	7.35	330	17	Y	Y	Y
16	7.67	480	18	Y	N	N
17	6.37	324	17	Y	Y	Y
18	5.82	239	16	Y	Y	Y
19	5.71	258	17	Y	Y	Y
20	5.98	463	17	Y	Y	Y
21	8.98	287	17	Y	Y	Y
22	5.28	374	16	Y	Y	Y
23	8.44	376	17	Y	Y	Y
24	9.40	293	17	Y	N	N
25	8.83	437	16	N	Y	Y
26	6.16	289	16	Y	Y	Y
27	6.97	481	18	Y	Y	Y
28	8.78	314	17	Y	Y	Y
29	6.25	356	15	Y	Y	Y
30	9.25	385	17	Y	Y	Y
Detection Percentage (%)				93.33	93.35	93.14
Y=Detection, N= No Detection						

Band2C

Radar Type	3					
Trail #	Pulse Width (us)	PRI (us)	Pulses / Burst	CH5500	CH5510	CH5530
1	5.86	389	16	Y	Y	Y
2	8.82	410	16	Y	Y	Y
3	8.53	490	17	Y	Y	Y
4	6.98	395	16	N	Y	Y
5	7.64	200	16	Y	Y	Y
6	8.56	227	15	Y	Y	Y
7	7.64	476	15	Y	Y	Y
8	7.00	496	15	Y	Y	Y
9	7.12	491	15	Y	N	Y
10	8.12	303	16	Y	Y	Y
11	9.89	442	16	Y	Y	Y
12	7.72	263	17	Y	Y	Y
13	6.88	461	16	Y	Y	Y
14	5.94	241	17	Y	Y	Y
15	7.02	331	17	Y	Y	Y
16	7.36	480	16	Y	Y	N
17	6.05	324	18	Y	Y	Y
18	5.92	239	16	Y	Y	Y
19	5.72	257	16	Y	Y	Y
20	6.30	463	18	Y	Y	Y
21	8.45	287	16	Y	Y	Y
22	5.65	374	17	Y	Y	Y
23	8.20	376	16	Y	N	Y
24	8.94	292	16	Y	Y	N
25	8.99	437	17	Y	Y	Y
26	5.96	289	16	Y	Y	Y
27	6.88	481	16	Y	Y	Y
28	8.88	315	18	Y	Y	Y
29	6.47	356	16	Y	Y	Y
30	9.22	385	15	Y	Y	Y
Detection Percentage (%)				96.67	93.33	95.75
Note 1: 1=Detection ;0=No Detection						

5.6.8. Data Sheet for Radar Type 4

Band2A

Radar Type	4					
Trail #	Pulse Width (us)	PRI (us)	Pulses / Burst	CH5300	CH5270	CH5290
1	17.74	424	13	Y	Y	Y
2	16.47	283	14	Y	Y	Y
3	10.97	386	11	Y	Y	Y
4	13.36	470	12	Y	Y	Y
5	13.59	398	15	N	Y	Y
6	18.15	252	13	Y	Y	Y
7	11.10	369	11	Y	N	N
8	16.82	282	15	Y	Y	Y
9	13.57	391	15	Y	Y	Y
10	15.97	228	14	Y	Y	Y
11	15.52	326	14	Y	Y	Y
12	18.65	316	14	Y	Y	Y
13	17.51	433	13	Y	Y	Y
14	16.01	312	14	Y	Y	Y
15	14.57	485	15	Y	Y	Y
16	16.14	392	14	Y	Y	Y
17	18.82	353	11	Y	Y	Y
18	14.37	352	12	Y	Y	Y
19	13.58	478	12	Y	Y	Y
20	15.30	407	16	Y	Y	Y
21	15.98	316	11	N	Y	Y
22	18.37	464	14	Y	Y	Y
23	15.88	300	12	Y	Y	Y
24	10.84	226	13	Y	Y	Y
25	13.33	314	16	Y	Y	Y
26	15.32	292	11	Y	Y	Y
27	18.73	398	14	Y	Y	Y
28	14.88	323	14	Y	Y	Y
29	15.16	394	12	Y	Y	Y
30	14.84	376	12	Y	Y	Y
Detection Percentage (%)				94.17	96.62	95.49
Note 1: 1=Detection ;0=No Detection						

Band2C

Radar Type	4					
Trail #	Pulse Width (us)	PRI (us)	Pulses / Burst	CH5500	CH5510	CH5530
1	17.88	423	12	Y	Y	Y
2	16.87	282	14	Y	Y	Y
3	10.64	386	12	Y	Y	Y
4	13.39	471	12	Y	Y	Y
5	13.31	399	14	Y	N	Y
6	18.16	252	14	Y	Y	Y
7	10.58	370	12	Y	Y	N
8	17.08	282	15	Y	Y	Y
9	13.37	391	16	Y	Y	Y
10	15.69	229	14	Y	Y	Y
11	15.11	326	13	Y	Y	Y
12	17.99	317	14	Y	Y	Y
13	17.23	432	12	Y	Y	Y
14	15.56	311	14	Y	Y	Y
15	14.67	486	16	Y	Y	Y
16	16.57	392	14	Y	Y	Y
17	18.76	353	11	Y	Y	Y
18	14.39	353	13	Y	Y	Y
19	13.27	477	13	Y	Y	Y
20	15.32	407	16	Y	Y	Y
21	15.98	317	12	Y	Y	Y
22	18.50	464	14	N	Y	Y
23	15.40	301	12	Y	Y	Y
24	10.45	225	14	Y	Y	Y
25	13.73	315	15	Y	Y	Y
26	15.50	293	11	Y	Y	Y
27	19.14	398	14	Y	N	Y
28	15.46	323	15	N	Y	Y
29	14.96	394	12	Y	Y	Y
30	15.34	376	12	Y	Y	Y
Detection Percentage (%)				93.31	92.57	93.48
Note 1: 1=Detection ;0=No Detection						

5.6.9. Parameter Data Sheet for Radar Type 5

Statistical Performance Check Result						
Radar Test Signal (#)		5		Trail #		1
Burst	Number of Pulses	Pulse Width	Chirp Width (MHz)	Pulse 1-to-2 Spacing	Pulse 2-to-3 Spacing	Start Time (msec)
1	1	62.3	8			346
2	2	51.2	15	1745		2705
3	3	93.6	5	957	1634	3674
4	3	68.2	12	1668	1573	4884
5	3	83.1	8	1188	1888	6876
6	1	56.7	18			7876
7	2	60.6	18	1874		10409
8	3	75.5	13	1263	1683	11878

Statistical Performance Check Result						
Radar Test Signal (#)		5		Trail #		2
Burst	Number of Pulses	Pulse Width	Chirp Width (MHz)	Pulse 1-to-2 Spacing	Pulse 2-to-3 Spacing	Start Time (msec)
1	1	99.6	13			217
2	2	54.8	15	1727		2315.333
3	3	91.1	15	1120	1826	3607.666
4	2	76.2	7	1638		4476.999
5	1	88.9	13			5592.332
6	1	83	9			7558.665
7	1	83.9	12			8319.998
8	2	55.9	15	1613		9778.331
9	1	96.1	13	9		11445.664

Statistical Performance Check Result						
Radar Test Signal (#)		5		Trail #		3
Burst	Number of Pulses	Pulse Width	Chirp Width (MHz)	Pulse 1-to-2 Spacing	Pulse 2-to-3 Spacing	Start Time (msec)
1	2	82	6	1246		1017
2	1	93.2	13			1960
3	2	61.3	13	1175		2727
4	1	52.8	8			4424
5	3	70.6	19	929	1076	4915
6	1	80.3	17			6325
7	1	83.2	15			7879
8	2	94	9	1805		9288
9	2	67	8	1486		10449
10	1	56.4	20			11613

Statistical Performance Check Result						
Radar Test Signal (#)		5		Trail #		4
Burst	Number of Pulses	Pulse Width	Chirp Width (MHz)	Pulse 1-to-2 Spacing	Pulse 2-to-3 Spacing	Start Time (msec)
1	3	90.5	8	1149	1612	35
2	3	54.5	8	1094	1525	2104.909
3	1	57.1	18			3008.818
4	2	98.6	20	1292		3355.727
5	2	62.9	12	1433		5039.636
6	1	71.1	15			6162.545
7	1	96.7	5			7256.454
8	1	64.3	5			8120.363
9	3	61.2	8	1075	1524	9171.272
10	2	79.2	13	1877		10615.181
11	2	79.3	20	1313		11197.09

Statistical Performance Check Result						
Radar Test Signal (#)		5		Trail #		5
Burst	Number of Pulses	Pulse Width	Chirp Width (MHz)	Pulse 1-to-2 Spacing	Pulse 2-to-3 Spacing	Start Time (msec)
1	1	89.5	13			20
2	3	71.8	11	1446	1549	1117
3	3	53.7	15	1100	1517	2485
4	2	99.3	11	1571		3334
5	3	56.8	6	1594	1280	4468
6	1	97.4	11			5213
7	2	67.6	13	1831		6014
8	3	77.1	8	1683	1337	7267
9	1	98.5	17			8544
10	3	58.3	13	1924	1829	9159
11	1	98.4	14			10380
12	1	79.3	11			11257

Statistical Performance Check Result						
Radar Test Signal (#)		5		Trail #		6
Burst	Number of Pulses	Pulse Width	Chirp Width (MHz)	Pulse 1-to-2 Spacing	Pulse 2-to-3 Spacing	Start Time (msec)
1	2	53.8	14	1631		768
2	1	90	17			1453.077
3	3	87.2	18	1115	1297	2003.154
4	2	82	11	1728		3661.231
5	3	69.8	7	1641	1779	3888.308
6	2	63.1	20	1836		4946.385
7	1	59.8	6			6033.462
8	3	78.5	19	941	1921	7007.539
9	1	85.7	6			7603.616
10	3	67.7	9	1834	1450	8841.693
11	2	84.5	15	1376		9512.77
12	2	99.3	13	1570		10639.847
13	2	80.2	8	1088		11143.924

Statistical Performance Check Result						
Radar Test Signal (#)		5		Trail #		7
Burst	Number of Pulses	Pulse Width	Chirp Width (MHz)	Pulse 1-to-2 Spacing	Pulse 2-to-3 Spacing	Start Time (msec)
1	3	80.8	10	1061	1124	389
2	2	81	9	1479		1091.143
3	2	87.6	17	1247		2291.286
4	2	94.7	18	1041		3143.429
5	2	78	18	1267		3741.572
6	1	95.5	14			4337.715
7	2	97.6	15	1215		5199.858
8	3	88	9	1349	1598	6171.001
9	2	69.7	17	1711		7626.144
10	2	96.5	17	1431		7882.287
11	2	96.9	6	1871		8695.43
12	3	66.4	10	1824	1468	10194.573
13	1	78.8	10			10822.716
14	3	87.6	6	1080	1159	11856.859

Statistical Performance Check Result						
Radar Test Signal (#)		5		Trail #		8
Burst	Number of Pulses	Pulse Width	Chirp Width (MHz)	Pulse 1-to-2 Spacing	Pulse 2-to-3 Spacing	Start Time (msec)
1	2	71.8	14	1432		573
2	2	65.9	19	1762		1114
3	2	74.7	6	1754		1977
4	3	81.7	5	1133	974	2616
5	3	57.8	14	1176	1712	3329
6	1	80.6	6			4341
7	3	99.3	17	1268	1876	4965
8	1	79.8	12			6218
9	3	83	11	990	1738	6989
10	3	71.5	11	1473	1255	7206
11	1	77.4	11			8127
12	2	84.8	12	1390		9315
13	2	64.6	12	1653		9748
14	2	92.9	12	1881		10919
15	1	71.3	6			11501

Statistical Performance Check Result

Radar Test Signal (#)		5		Trail #		9
Burst	Number of Pulses	Pulse Width	Chirp Width (MHz)	Pulse 1-to-2 Spacing	Pulse 2-to-3 Spacing	Start Time (msec)
1	2	55.4	9	1318		383
2	2	80.8	18	1710		1284
3	1	88.8	9			1995
4	2	78	12	1818		2342
5	1	78.5	12			3108
6	2	55	13	1219		3873
7	2	75.9	20	1004		4623
8	2	70.9	7	1820		5796
9	2	71.7	18	1559		6476
10	2	73.9	19	1232		6985
11	1	59.2	20			7924
12	1	55.7	9			8641
13	3	60.9	12	1144	1370	9198
14	2	60.8	14	990		9766
15	3	60.6	19	1526	1326	11195
16	2	89	5	1029		11381

Statistical Performance Check Result						
Radar Test Signal (#)		5		Trail #	10	
Burst	Number of Pulses	Pulse Width	Chirp Width (MHz)	Pulse 1-to-2 Spacing	Pulse 2-to-3 Spacing	Start Time (msec)
1	2	72.1	14	1119		488
2	3	81.4	13	1142	961	1156.882
3	3	92.9	18	991	1147	1976.764
4	3	81.3	18	1793	1369	2402.646
5	3	76.4	20	1005	1793	2902.528
6	1	61.6	18			4032.41
7	1	66.6	19			4416.292
8	1	53.7	12			5357.174
9	2	58	8	1477		5754.056
10	2	64	18	1791		6493.938
11	2	80.3	12	1304		7574.82
12	3	77.3	5	1039	1668	8136.702
13	2	97.6	11	1593		8633.584
14	1	73	6			9323.466
15	3	65.1	8	1097	1927	9984.348
16	2	59.5	13	1569		10770.23
17	1	88.2	19			11947.112

Statistical Performance Check Result						
Radar Test Signal (#)		5		Trail #		11
Burst	Number of Pulses	Pulse Width	Chirp Width (MHz)	Pulse 1-to-2 Spacing	Pulse 2-to-3 Spacing	Start Time (msec)
1	2	56.1	12	1219		273
2	1	83.3	7			964.666
3	3	79.6	17	1218	1897	1492.333
4	2	95.8	7	1672		2480
5	2	79.6	8	920		3053.667
6	2	88.9	11	1779		3338.334
7	2	81.4	8	1645		4201.001
8	2	92	6	1454		4746.668
9	3	96	13	1518	1121	5525.335
10	2	65.6	11	1798		6349.002
11	2	98.7	5	1360		7082.669
12	2	52.9	15	1140		7985.336
13	2	76.5	8	1032		8092.003
14	3	73.8	18	1719	1383	9168.67
15	3	83.7	10	1270	1216	9676.337
16	2	89.6	10	1141		10108.004
17	2	67.2	20	1455		10938.671
18	3	55.7	14	1444	1475	11899.338

Statistical Performance Check Result						
Radar Test Signal (#)		5		Trail #	12	
Burst	Number of Pulses	Pulse Width	Chirp Width (MHz)	Pulse 1-to-2 Spacing	Pulse 2-to-3 Spacing	Start Time (msec)
1	2	70.6	15	1040		575
2	2	72.9	13	1460		809.579
3	3	88.9	5	1250	1629	1454.158
4	3	60.3	20	1757	1822	2362.737
5	3	92.1	19	1845	1198	3002.316
6	1	73	5			3689.895
7	1	50.4	15			3858.474
8	1	66.4	10			4754.053
9	1	79.1	18			5489.632
10	1	71.6	20			6108.211
11	2	95.6	13	1229		6813.79
12	1	74.4	9			7310.369
13	3	55.6	17	1263	1724	7701.948
14	2	78.3	13	1507		8247.527
15	3	54.1	13	1325	1249	9034.106
16	2	67.1	18	1584		9784.685
17	2	65.8	9	1195		10348.264
18	2	50.1	12	1755		10784.843
19	2	87.7	18	1359		11548.422

Statistical Performance Check Result						
Radar Test Signal (#)		5		Trail #		13
Burst	Number of Pulses	Pulse Width	Chirp Width (MHz)	Pulse 1-to-2 Spacing	Pulse 2-to-3 Spacing	Start Time (msec)
1	3	79.5	7	1808	1550	274
2	2	76.7	20	1632		1173
3	3	85.9	12	1305	1496	1218
4	3	86.6	14	968	1172	1933
5	2	74.9	14	1348		2448
6	3	82.2	20	1692	1310	3156
7	2	53.9	13	1342		3645
8	3	62.7	15	1839	1651	4276
9	2	86.2	6	1165		4891
10	1	63.1	11			5791
11	2	82.4	6	1416		6107
12	1	95.8	18			6848
13	2	75.7	9	993		7682
14	3	70.1	18	1563	1020	8154
15	3	85.8	13	1420	1084	8846
16	1	63.2	7			9265
17	1	75.1	11			9747
18	2	69.5	5	1802		10456
19	1	51.8	19			11222
20	2	62.3	5	1449		11704

Statistical Performance Check Result						
Radar Test Signal (#)		5		Trail #		14
Burst	Number of Pulses	Pulse Width	Chirp Width (MHz)	Pulse 1-to-2 Spacing	Pulse 2-to-3 Spacing	Start Time (msec)
1	3	74.9	5	1314	1466	1289
2	2	83.9	19	1442		2936
3	2	55.8	6	1147		3240
4	2	59.4	6	1490		5955
5	2	78.2	15	1665		7312
6	2	57.3	15	1357		7764
7	2	76.2	11	1651		9255
8	3	59	7	1460	1109	11910

Statistical Performance Check Result						
Radar Test Signal (#)		5		Trail #		15
Burst	Number of Pulses	Pulse Width	Chirp Width (MHz)	Pulse 1-to-2 Spacing	Pulse 2-to-3 Spacing	Start Time (msec)
1	3	77.7	19	1046	1568	17
2	2	98.2	20	1628		2210.333
3	2	95.3	8	1540		3732.666
4	2	78.8	15	1341		4821.999
5	2	52.8	20	988		6353.332
6	2	65.2	9	1480		7268.665
7	2	99.5	10	1867		8883.998
8	2	79.5	13	1148		9675.331
9	3	50.6	13	1030	1525	11987.664

Statistical Performance Check Result						
Radar Test Signal (#)		5		Trail #		16
Burst	Number of Pulses	Pulse Width	Chirp Width (MHz)	Pulse 1-to-2 Spacing	Pulse 2-to-3 Spacing	Start Time (msec)
1	2	97.5	11	1357		764
2	2	91.8	13	1896		1498
3	1	78.5	5			3517
4	1	60.1	11			4669
5	2	96.2	10	975		5957
6	2	56.6	18	1626		6701
7	1	77.1	20			7523
8	2	96.3	8	1682		8707
9	2	52.2	13	1017		9817
10	1	92.8	15			11116

Statistical Performance Check Result						
Radar Test Signal (#)		5		Trail #		17
Burst	Number of Pulses	Pulse Width	Chirp Width (MHz)	Pulse 1-to-2 Spacing	Pulse 2-to-3 Spacing	Start Time (msec)
1	2	57.3	8	1220		792
2	3	73.1	5	1717	1679	1935.909
3	2	54.1	14	967		2293.818
4	2	98.8	19	1137		3987.727
5	3	85.5	8	1068	960	4664.636
6	2	78.5	7	1387		6281.545
7	2	77.9	12	1869		7051.454
8	1	81.9	10			8185.363
9	1	50.4	9			9191.272
10	1	75.2	8			10608.181
11	2	92.7	7	1770		11876.09

Statistical Performance Check Result						
Radar Test Signal (#)		5		Trail #		18
Burst	Number of Pulses	Pulse Width	Chirp Width (MHz)	Pulse 1-to-2 Spacing	Pulse 2-to-3 Spacing	Start Time (msec)
1	2	79.1	6	1042		793
2	3	55.7	9	1327	1744	1159
3	1	95	20			2734
4	1	88.4	5			3523
5	1	92.3	15			4546
6	1	93.6	6			5208
7	2	95.1	12	1044		6894
8	1	59.5	17			7666
9	2	98.7	17	1422		8640
10	2	65.1	5	1104		9320
11	1	60.2	5			10060
12	1	88.7	8			11823

Statistical Performance Check Result						
Radar Test Signal (#)		5		Trail #		19
Burst	Number of Pulses	Pulse Width	Chirp Width (MHz)	Pulse 1-to-2 Spacing	Pulse 2-to-3 Spacing	Start Time (msec)
1	1	53.9	10			226
2	2	82.6	13	992		1777.077
3	1	87.7	8			2149.154
4	3	69	12	1696	1606	3297.231
5	1	68.6	12			3912.308
6	3	76.5	13	1333	1468	5004.385
7	2	95.8	17	1380		5595.462
8	2	55.6	19	1147		6795.539
9	2	78.6	14	1268		7512.616
10	2	65.4	17	1231		9220.693
11	2	76.6	18	1883		9748.77
12	1	93.2	6			0749.847
13	2	50.2	13	1836		11137.924

Statistical Performance Check Result						
Radar Test Signal (#)		5		Trail #		20
Burst	Number of Pulses	Pulse Width	Chirp Width (MHz)	Pulse 1-to-2 Spacing	Pulse 2-to-3 Spacing	Start Time (msec)
1	1	60.9	13			142
2	2	81.7	15	1831		1379.143
3	2	78.5	5	1396		2504.286
4	2	98.2	6	1652		2574.429
5	1	64.1	12			3842.572
6	3	53	18	1862	1902	4442.715
7	2	62.3	15	1490		5390.858
8	2	87	11	1411		6576.001
9	2	78.4	8	1090		7594.144
10	2	87.2	7	967		8057.287
11	3	71	13	1662	1841	8676.43
12	2	77.2	5	1557		10029.573
13	1	94.4	15			10393.716
14	1	90.6	13			11648.859

Statistical Performance Check Result						
Radar Test Signal (#)		5		Trail #		21
Burst	Number of Pulses	Pulse Width	Chirp Width (MHz)	Pulse 1-to-2 Spacing	Pulse 2-to-3 Spacing	Start Time (msec)
1	3	76.5	8	1870	1326	385
2	2	95.3	13	1162		873
3	3	58.9	9	1586	1909	2342
4	2	73.1	13	1460		2730
5	2	73.1	12	1488		3225
6	2	75.1	5	1331		4418
7	3	98.5	11	936	1532	5014
8	3	72.5	13	1110	1903	5987
9	3	67.4	12	1567	1513	6480
10	2	76.1	12	1005		7477
11	2	94.3	17	1413		8314
12	2	72.8	12	1778		8866
13	2	90.9	14	1793		9747
14	3	94.8	11	1012	1742	10841
15	3	95	12	912	1641	11809

Statistical Performance Check Result						
Radar Test Signal (#)		5		Trail #		22
Burst	Number of Pulses	Pulse Width	Chirp Width (MHz)	Pulse 1-to-2 Spacing	Pulse 2-to-3 Spacing	Start Time (msec)
1	1	96.7	9			308
2	2	78.3	13	1045		777
3	1	56.5	12			1574
4	3	88.5	14	1119	1020	2879
5	2	62.4	9	1436		3548
6	2	78.2	5	1147		4091
7	3	76.8	14	1069	1575	4860
8	2	91.6	18	978		5852
9	2	93.7	5	1130		6623
10	2	97.4	8	1100		7006
11	3	90.1	6	1629	1375	7608
12	2	79.9	18	1809		8433
13	2	83	10	1370		9477
14	2	89.1	13	1239		10234
15	2	58.3	8	1321		10776
16	1	85.2	13			11272

Statistical Performance Check Result						
Radar Test Signal (#)		5		Trail #		23
Burst	Number of Pulses	Pulse Width	Chirp Width (MHz)	Pulse 1-to-2 Spacing	Pulse 2-to-3 Spacing	Start Time (msec)
1	3	60	10	1097	1748	56
2	3	66.3	13	1391	1430	1126.882
3	2	88.5	15	1040		1994.764
4	2	72.1	8	1526		2278.646
5	1	72.3	8			3273.528
6	2	67.3	7	1022		3577.41
7	2	56.1	12	1325		4896.292
8	1	83.5	11			5636.174
9	3	99.4	13	1490	938	6052.056
10	1	54.2	12			6478.938
11	3	92.7	17	1251	1631	7423.82
12	3	95.1	17	1741	1162	7821.702
13	2	84	9	1597		8637.584
14	1	68.5	18			9688.466
15	1	76.5	20			10067.348
16	3	86.6	11	1774	1875	11045.23
17	2	62.2	9	1563		11786.112

Statistical Performance Check Result						
Radar Test Signal (#)		5		Trail #		24
Burst	Number of Pulses	Pulse Width	Chirp Width (MHz)	Pulse 1-to-2 Spacing	Pulse 2-to-3 Spacing	Start Time (msec)
1	1	86.6	19			621
2	2	95.3	17	926		794.666
3	1	76.2	12			1584.333
4	3	71.4	19	1287	1404	2269
5	3	51.7	12	1564	1339	3299.667
6	2	77	5	1899		3948.334
7	1	87.5	12			4375.001
8	3	59	17	1327	1615	5276.668
9	2	78.3	15	1551		5881.335
10	2	89.7	5	1718		6456.002
11	2	92.1	7	1403		6678.669
12	2	97.3	14	1338		7929.336
13	3	80.3	20	1354	1563	8484.003
14	1	98.2	8			9094.67
15	3	94.4	13	1795	1829	9845.337
16	2	90.4	13	1105		10342.004
17	2	73.6	19	1787		10958.671
18	1	82.9	7			11951.338

Statistical Performance Check Result						
Radar Test Signal (#)		5		Trail #		25
Burst	Number of Pulses	Pulse Width	Chirp Width (MHz)	Pulse 1-to-2 Spacing	Pulse 2-to-3 Spacing	Start Time (msec)
1	1	90	18			173
2	1	65.3	19			876.579
3	2	82.6	10	1756		1390.158
4	2	93.9	18	1557		2181.737
5	2	50.5	13	1479		2808.316
6	1	68	7			3333.895
7	3	88.4	11	1244	1076	4357.474
8	3	66.8	11	1288	1909	4869.053
9	2	88	12	1450		5579.632
10	3	51.1	6	1797	1935	5879.211
11	2	93.8	13	1073		6499.79
12	1	83.5	10			7453.369
13	2	96.9	12	1047		7845.948
14	3	87.2	18	1521	1450	8453.527
15	2	60.1	8	1545		9133.106
16	3	98	10	1842	1402	10027.685
17	3	57	19	1665	1732	10248.264
18	1	74.3	14			10767.843
19	2	57.8	10	1576		11977.422

Statistical Performance Check Result						
Radar Test Signal (#)		5		Trail #		26
Burst	Number of Pulses	Pulse Width	Chirp Width (MHz)	Pulse 1-to-2 Spacing	Pulse 2-to-3 Spacing	Start Time (msec)
1	2	92.8	9	1222		531
2	2	52.4	8	1547		768
3	3	56.8	7	1158	1184	1393
4	1	91.2	7			2365
5	3	61.2	10	1558	1664	2787
6	3	62	7	1518	1656	3391
7	2	69	5	1531		3927
8	2	67.3	18	1064		4225
9	1	94.1	5			4878
10	2	76	17	1190		5622
11	2	81.9	12	1815		6096
12	2	57.9	8	1594		6877
13	3	68.3	19	1427	1540	7241
14	2	53.3	7	1713		7848
15	2	85.3	15	1136		8448
16	1	65.3	20			9057
17	3	79.8	20	923	1259	9648
18	2	56.9	20	1357		10683
19	2	93	9	1686		10873
20	2	82.8	10	944		11752

		Statistical Performance Check Result				
Radar Test Signal (#)		5		Trail #	27	
Burst	Number of Pulses	Pulse Width	Chirp Width (MHz)	Pulse 1-to-2 Spacing	Pulse 2-to-3 Spacing	Start Time (msec)
1	3	50.9	11	1106	1077	1293
2	2	77.8	18	1836		2735
3	3	60.7	5	1069	1635	4092
4	2	77.2	13	1916		5843
5	2	91.6	13	1465		7466
6	2	56.8	17	1783		7876
7	1	59.5	20			9131
8	1	66.5	12			11524

		Statistical Performance Check Result				
Radar Test Signal (#)		5		Trail #	28	
Burst	Number of Pulses	Pulse Width	Chirp Width (MHz)	Pulse 1-to-2 Spacing	Pulse 2-to-3 Spacing	Start Time (msec)
1	2	72	9	1092		965
2	2	89.2	6	1550		2559.333
3	1	81.2	12			2943.666
4	2	80.6	15	1616		4457.999
5	2	62.8	10	1812		6081.332
6	1	71	8			7100.665
7	2	69.3	6	1027		9110.998
8	2	77.2	13	1076		9971.331
9	2	65.4	5	1582		10944.664

Statistical Performance Check Result						
Radar Test Signal (#)		5		Trail #	29	
Burst	Number of Pulses	Pulse Width	Chirp Width (MHz)	Pulse 1-to-2 Spacing	Pulse 2-to-3 Spacing	Start Time (msec)
1	1	51.5	19			151
2	1	82.3	13			2271
3	3	78.3	8	1115	1740	3046
4	2	99	14	1101		4309
5	3	98.8	7	1819	945	5356
6	2	80.9	19	922		6567
7	2	64	12	953		7781
8	1	79	20			9198
9	1	68	8			9712
10	2	50.4	13	1587		10826

Statistical Performance Check Result						
Radar Test Signal (#)		5		Trail #	30	
Burst	Number of Pulses	Pulse Width	Chirp Width (MHz)	Pulse 1-to-2 Spacing	Pulse 2-to-3 Spacing	Start Time (msec)
1	3	57.8	5	1324	1716	82
2	2	70.1	20	1733		1677.909
3	2	95.2	13	1188		2970.818
4	3	84.6	20	1042	1259	4293.727
5	3	96.5	7	1329	1596	4379.636
6	2	84.3	15	1606		6162.545
7	3	53.5	19	1783	1458	7283.454
8	3	74.9	5	1599	1891	8102.363
9	3	53.8	7	1494	1467	8979.272
10	2	60.5	14	1319		10282.181
11	1	73.3	10			11754.09

Appendix A: Photographs of Test Setup

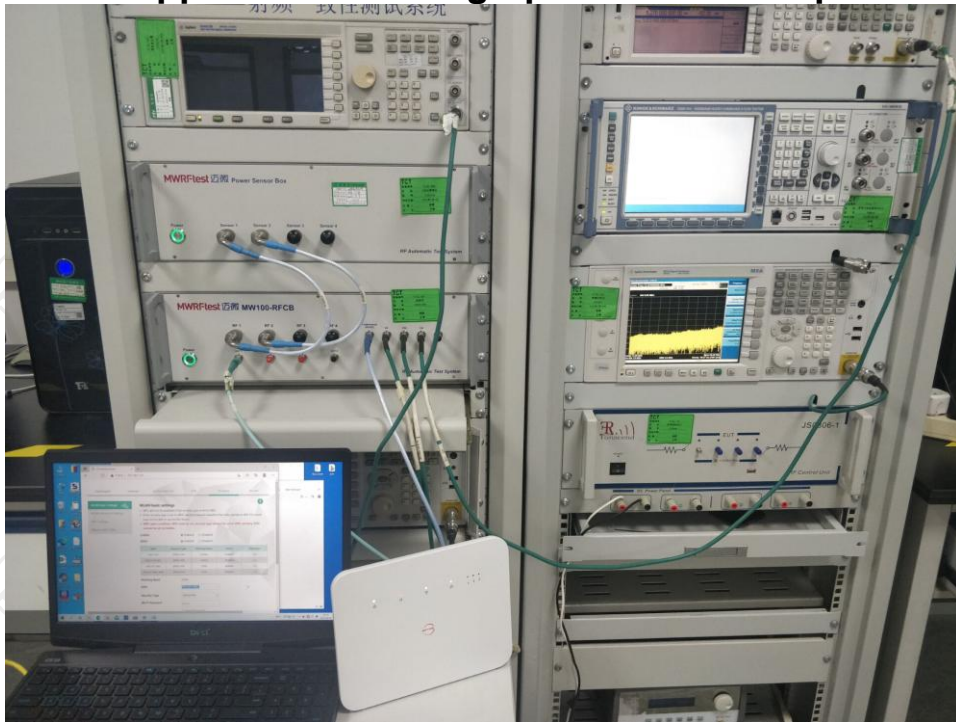

*******END OF REPORT*******