

# Test Report (LTE)

**Applicant:** Shanghai Notion Information Technology CO. LTD  
**Address of Applicant:** Floor 5,Building 5,NO 289,Bisheng Rd, Pudong district, Shanghai, China  
**Manufacturer:** Shanghai Notion Information Technology CO. LTD  
**Address of Manufacturer:** Floor 5,Building 5,NO 289,Bisheng Rd, Pudong district, Shanghai, China  
**Equipment Under Test (EUT)**

**Product Name:** LTE MiFi

**Model No.:** M022, M022T, M028, M028B, M028AT, M028A, M023, L02C, L02I, L02H, L02B

**FCC ID:** 2AR45-MIFI

**Applicable standards:** FCC CFR Title 47 Part 2  
FCC CFR Title 47 Part 27

**Date of sample receipt:** July 09, 2019

**Date of Test:** July 09-18, 2019

**Date of report issued:** July 19, 2019

**Test Result :** PASS \*

\* In the configuration tested, the EUT complied with the standards specified above.

Authorized Signature:



**Robinson Lo**  
**Laboratory Manager**

This results shown in this test report refer only to the sample(s) tested, this test report cannot be reproduced, except in full, without prior written permission of the company. The report would be invalid without specific stamp of test institute and the signatures of compiler and approver.

## 2 Version

Version No.	Date	Description
00	July 19, 2019	Original

**Prepared By:** Tiger Chen **Date:** July 19, 2019  
**Project Engineer**

**Check By:** Robinson **Date:** July 19, 2019  
**Reviewer**

## 3 Contents

Page

2	VERSION .....	2
3	CONTENTS .....	3
4	TEST SUMMARY .....	4
4.1	MEASUREMENT UNCERTAINTY .....	4
5	GENERAL INFORMATION .....	5
5.1	GENERAL DESCRIPTION OF EUT .....	5
5.2	RELATED SUBMITTAL(S) / GRANT (S) .....	6
5.3	TEST METHODOLOGY.....	6
5.4	DEVIATION FROM STANDARDS .....	6
5.5	ABNORMALITIES FROM STANDARD CONDITIONS.....	6
5.6	TEST FACILITY .....	6
5.7	TEST LOCATION.....	6
6	TEST INSTRUMENTS LIST .....	7
7	SYSTEM TEST CONFIGURATION .....	8
7.1	TEST MODE .....	8
7.2	CONFIGURATION OF TESTED SYSTEM .....	8
7.3	CONDUCTED AVERAGE OUTPUT POWER.....	9
7.4	PEAK-TO-AVERAGE RATIO .....	16
7.5	OCCUPY BANDWIDTH.....	17
7.6	MODULATION CHARACTERISTIC.....	25
7.7	OUT OF BAND EMISSION AT ANTENNA TERMINALS.....	25
7.8	FIELD STRENGTH OF SPURIOUS RADIATION MEASUREMENT.....	44
7.9	FREQUENCY STABILITY V.S. TEMPERATURE MEASUREMENT.....	49
7.10	FREQUENCY STABILITY V.S. VOLTAGE MEASUREMENT.....	51
8	TEST SETUP PHOTO .....	53
9	EUT CONSTRUCTIONAL DETAILS .....	53

## 4 Test Summary

Test Item	Section in CFR 47	Result
RF Exposure (SAR)	Part 1.1307 Part 2.1091	Pass* (Please refer to SAR Report)
RF Output Power	Part 2.1046 Part 27.50(c)(10)/(d)(4)	Pass
Peak-to-Average Ratio	FCC Part 27.50	Pass
Modulation Characteristics	Part 2.1047	N/A
99% & -26 dB Occupied Bandwidth	Part 2.1049 Part 27.53(h)/(g)	Pass
Spurious Emissions at Antenna Terminal	Part 2.1051 Part 27.53(h)/(g)	Pass
Field Strength of Spurious Radiation	Part 2.1053 Part 27.53(h)/(g)	Pass
Out of band emission, Band Edge	Part 27.53(h)/(g)	Pass
Frequency stability vs. temperature	Part 2.1055(a)(1)(b)	Pass
Frequency stability vs. voltage	Part 2.1055(d)(1)(2)	Pass

*Pass: The EUT complies with the essential requirements in the standard.*

*N/A: Not applicable.*

### 4.1 Measurement Uncertainty

Test Item	Frequency Range	Measurement Uncertainty	Notes
Radiated Emission	9kHz ~ 30MHz	±3.8039dB	(1)
Radiated Emission	30MHz ~ 1000MHz	± 3.9679dB	(1)
Radiated Emission	1GHz ~ 26.5GHz	± 4.29dB	(1)

Note (1): The measurement uncertainty is for coverage factor of k=2 and a level of confidence of 95%.

## 5 General Information

### 5.1 General Description of EUT

Product Name:	LTE MiFi
Model No.:	M022, M022T, M028, M028B, M028AT, M028A, M023, L02C, L02I, L02H, L02B
Test Model No:	M022
Remark: All above models are identical in the same PCB layout, interior structure and electrical circuits. The only difference is model name for commercial purpose.	
S/N:	M022T190712000001
Tested Sample(s) ID:	GTS201907000049-1
Hardware Version:	L02I_1_10
Software Version:	L02IAVANTEL1_M022T_LCD_V003_8801_2.174.000_tx_develop_20190719_1800
Support Networks:	LTE
Support Bands:	LTE Band 4, Band 28
TX Frequency:	Band 4:1710.70MHz-1754.30MHz Band 28:703MHz ~ 748MHz
Channel Bandwidth:	1.4MHz; 3MHz; 5MHz; 10MHz; 15MHz; 20MHz
Modulation type:	QPSK, 16QAM
Antenna type:	Integral antenna
Antenna gain:	3.0dBi
Power supply:	Power Adapter Model: SD-D05I100C Input: AC 100-240V, 50/60Hz, 0.2A Output: DC 5V/1A Or DC 3.7V 3000mAh(11.1Wh) Battery Li-Polymer

## 5.2 Related Submittal(s) / Grant (s)

This submittal(s) (test report) is filing to comply with Section Part 27 of the FCC CFR 47 Rules.

## 5.3 Test Methodology

Both conducted and radiated testing were performed according to the procedures document on ANSI / TIA / EIA-603-D-2010 and FCC KDB 971168 D01 Power Meas. License Digital Systems v03r01 and ANSI C63.26, FCC CFR 47.1046, 2.1047, 2.1049, 2.1051, 2.1053, 2.1055 and 2.1057

## 5.4 Deviation from Standards

None.

## 5.5 Abnormalities from Standard Conditions

None.

## 5.6 Test Facility

The test facility is recognized, certified, or accredited by the following organizations:

- **FCC —Registration No.: 381383**

Global United Technology Services Co., Ltd., Shenzhen EMC Laboratory has been registered and fully described in a report filed with the (FCC) Federal Communications Commission. The acceptance letter from the FCC is maintained in files. Registration 381383.

- **Industry Canada (IC) —Registration No.: 9079A-2**

The 3m Semi-anechoic chamber of Global United Technology Services Co., Ltd. has been registered by Certification and Engineering Bureau of Industry Canada for radio equipment testing with Registration No.: 9079A-2.

- **NVLAP (LAB CODE:600179-0)**

Global United Technology Services Co., Ltd., is accredited by the National Voluntary Laboratory Accreditation Program (NVLAP). LAB CODE:600179-0

## 5.7 Test Location

All tests were performed at:

Global United Technology Services Co., Ltd.

Address: No. 301-309, 3/F., Jinyuan Business Building, No.2, Laodong Industrial Zone, Xixiang Road, Baoan District, Shenzhen, Guangdong, China 518102

Tel: 0755-27798480

Fax: 0755-27798960

## 6 Test Instruments list

Radiated Emission:						
Item	Test Equipment	Manufacturer	Model No.	Inventory No.	Cal.Date (mm-dd-yy)	Cal.Due date (mm-dd-yy)
1	3m Semi- Anechoic Chamber	ZhongYu Electron	9.2(L)*6.2(W)* 6.4(H)	GTS250	July. 03 2015	July. 02 2020
2	Control Room	ZhongYu Electron	6.2(L)*2.5(W)* 2.4(H)	GTS251	N/A	N/A
3	EMI Test Receiver	Rohde & Schwarz	ESU26	GTS203	June. 26 2019	June. 25 2020
4	BiConiLog Antenna	SCHWARZBECK MESS-ELEKTRONIK	VULB9163	GTS214	June. 26 2019	June. 25 2020
5	Double -ridged waveguide horn	SCHWARZBECK MESS-ELEKTRONIK	BBHA 9120 D	GTS208	June. 26 2019	June. 25 2020
6	Horn Antenna	ETS-LINDGREN	3160	GTS217	June. 26 2019	June. 25 2020
7	EMI Test Software	AUDIX	E3	N/A	N/A	N/A
8	Coaxial Cable	GTS	N/A	GTS213	June. 26 2019	June. 25 2020
9	Coaxial Cable	GTS	N/A	GTS211	June. 26 2019	June. 25 2020
10	Coaxial cable	GTS	N/A	GTS210	June. 26 2019	June. 25 2020
11	Coaxial Cable	GTS	N/A	GTS212	June. 26 2019	June. 25 2020
12	Amplifier(100kHz-3GHz)	HP	8347A	GTS204	June. 26 2019	June. 25 2020
13	Amplifier(2GHz-20GHz)	HP	84722A	GTS206	June. 26 2019	June. 25 2020
14	Amplifier (18-26GHz)	Rohde & Schwarz	AFS33-18002 650-30-8P-44	GTS218	June. 26 2019	June. 25 2020
15	Band filter	Amindeon	82346	GTS219	June. 26 2019	June. 25 2020
16	Power Meter	Anritsu	ML2495A	GTS540	June. 26 2019	June. 25 2020
17	Power Sensor	Anritsu	MA2411B	GTS541	June. 26 2019	June. 25 2020
18	Wideband Radio Communication Tester	Rohde & Schwarz	CMW500	GTS575	June. 26 2019	June. 25 2020
19	Splitter	Agilent	11636B	GTS237	June. 26 2019	June. 25 2020
20	Loop Antenna	ZHINAN	ZN30900A	GTS534	June. 26 2019	June. 25 2020
21	Breitband hornantenne	SCHWARZBECK	BBHA 9170	GTS579	Oct. 20 2018	Oct. 19 2019
22	Amplifier	TDK	PA-02-02	GTS574	Oct. 20 2018	Oct. 19 2019
23	Amplifier	TDK	PA-02-03	GTS576	Oct. 20 2018	Oct. 19 2019
24	PSA Series Spectrum Analyzer	Rohde & Schwarz	FSP	GTS578	June. 26 2019	June. 25 2020

General used equipment:						
Item	Test Equipment	Manufacturer	Model No.	Inventory No.	Cal.Date (mm-dd-yy)	Cal.Due date (mm-dd-yy)
1	Humidity/ Temperature Indicator	KTJ	TA328	GTS243	June. 26 2019	June. 25 2020
2	Barometer	ChangChun	DYM3	GTS255	June. 26 2019	June. 25 2020

## 7 System test configuration

### 7.1 Test mode

During all testing, EUT is in link mode with base station emulator at maximum power level. The spurious emission measurements were carried out in semi-anechoic chamber with 3-meter test range, and EUT is rotated on three test planes to find out the worst emission.

Test modes		
Band	Radiated	Conducted
LTE Band 4	■ QPSK and 16QAM link	■ QPSK and 16QAM link

### 7.2 Configuration of Tested System

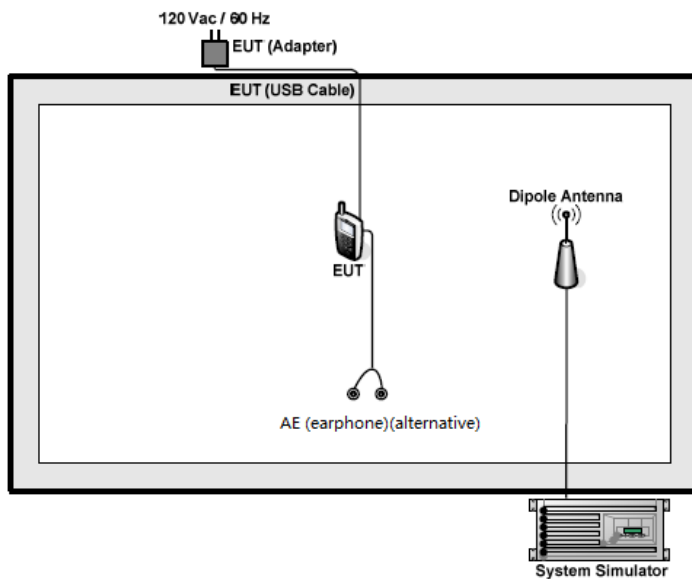

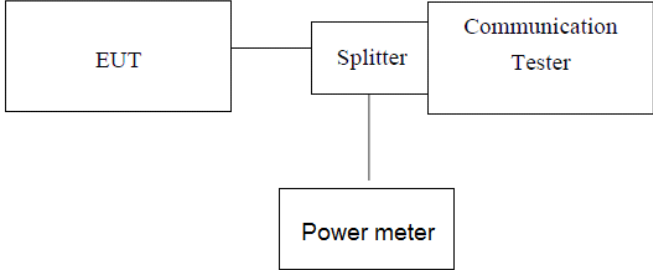

## 7.3 Conducted Average Output Power

Test Requirement for FCC:	Part 27.50(c)(10)/(d)(4)
Limit for FCC:	1W
Test setup:	 <p><i>Note: Measurement setup for testing on Antenna connector</i></p>
Test Procedure:	<ol style="list-style-type: none"> <li>1. The transmitter output port was connected to base station.</li> <li>2. The RF output of EUT was connected to the power meter by RF cable and attenuator, the path loss was compensated to the results for each measurement.</li> <li>3. Set EUT at maximum power through base station.</li> <li>4. Select lowest, middle, and highest channels for each band and different modulation.</li> <li>5. Measure the maximum burst average power.</li> </ol>
Test Instruments:	Refer to section 5.0 for details
Test mode:	Refer to section 6.1 for details
Test results:	Pass

Measurement Data

Band 4						
Bandwidth	Mode	RB Size	RB Offset	Actual output power(dBm)		
				Channel 19957 1710.7MHz	Channel 20175 1732.5MHz	Channel 20393 1754.3MHz
1.4MHz	QPSK	1	0	22.57	22.23	23.57
		1	2	23.75	23.02	22.17
		1	5	22.10	22.88	23.88
		3	0	22.70	23.59	23.18
		3	1	22.18	22.26	23.31
		3	2	22.34	23.67	23.27
		6	0	22.90	22.62	22.21
	16QAM	1	0	23.46	22.84	23.24
		1	2	22.29	22.62	22.44
		1	5	22.71	22.01	22.36
		3	0	23.83	23.06	22.56
		3	1	22.63	23.66	23.19
		3	2	22.88	22.30	22.19
		6	0	23.92	22.25	22.77
Bandwidth	Mode	RB Size	RB Offset	Actual output po2wer(dBm)		
				Channel 19965 1711.5MHz	Channel 20175 1732.5MHz	Channel 20385 753.5MHz
3MHz	QPSK	1	0	22.20	22.57	23.18
		1	8	23.63	23.32	23.68
		1	14	23.15	23.25	23.53
		8	0	22.54	22.57	23.24
		8	4	23.17	23.30	22.86
		8	7	22.44	23.70	23.58
		15	0	22.36	22.18	23.13
	16QAM	1	0	23.20	22.85	22.95
		1	8	23.94	22.99	23.69
		1	14	23.76	22.83	22.63
		8	0	22.84	22.07	23.18
		8	4	22.80	22.20	22.26
		8	7	23.20	23.04	23.88
		15	0	23.37	22.57	23.87

Bandwidth	Mode	RB Size	RB Offset	Actual output power(dBm)		
				Channel 19975 1712.5MHz	Channel 20175 1732.5MHz	Channel 20375 1752.5MHz
5MHz	QPSK	1	0	22.64	23.94	22.88
		1	13	22.65	22.36	23.49
		1	24	23.75	22.15	23.78
		12	0	22.97	23.62	23.80
		12	6	23.67	23.46	23.87
		12	13	22.31	22.27	22.81
		25	0	23.55	22.73	22.49
	16QAM	1	0	23.41	22.55	23.20
		1	13	23.94	23.38	23.44
		1	24	22.30	22.93	23.03
		12	0	22.74	22.19	23.66
		12	6	22.13	22.19	23.67
		12	13	22.23	23.44	23.95
		25	0	22.35	23.74	23.44
Bandwidth	Mode	RB Size	RB Offset	Actual output power(dBm)		
				Channel 20000 1715.0MHz	Channel 20175 1732.5MHz	Channel 20350 1750.0MHz
10MHz	QPSK	1	0	23.52	23.06	22.32
		1	25	23.55	22.98	23.46
		1	49	23.41	22.23	23.43
		25	0	22.66	23.07	23.03
		25	13	22.66	22.07	22.25
		25	25	22.12	23.41	22.82
		50	0	22.96	23.19	22.32
	16QAM	1	0	22.22	22.56	22.63
		1	25	23.52	22.99	22.04
		1	49	22.15	23.23	23.77
		25	0	22.94	23.41	23.69
		25	13	22.01	22.82	23.02
		25	25	23.17	22.37	22.80
		50	0	22.26	22.99	22.70

Bandwidth	Mode	RB Size	RB Offset	Actual output power(dBm)		
				Channel 20025 1717.5MHz	Channel 20175 1732.5MHz	Channel 20325 1747.5MHz
15MHz	QPSK	1	0	23.37	23.06	22.31
		1	38	23.28	23.55	22.67
		1	74	23.34	23.88	23.93
		36	0	22.38	23.11	22.36
		36	18	23.95	22.57	23.94
		36	39	23.96	22.02	22.81
		75	0	22.82	22.23	22.72
	16QAM	1	0	23.52	22.60	23.83
		1	38	22.64	23.95	23.28
		1	74	23.98	22.98	22.94
		36	0	23.09	22.78	23.61
		36	18	23.63	22.77	22.49
		36	39	22.49	22.50	22.22
		75	0	23.81	22.17	23.74
Bandwidth	Mode	RB Size	RB Offset	Actual output power(dBm)		
				Channel 20050 1720.0MHz	Channel 20175 1732.5MHz	Channel 20300 1745.0MHz
20MHz	QPSK	1	0	22.48	22.70	22.86
		1	50	22.28	23.53	22.81
		1	99	23.37	22.92	22.43
		50	0	23.45	23.51	23.75
		50	25	23.63	23.68	23.77
		50	50	23.01	22.71	22.81
		100	0	22.33	23.56	22.51
	16QAM	1	0	23.78	22.62	22.31
		1	50	23.12	23.64	22.33
		1	99	22.47	23.46	23.67
		50	0	23.82	23.59	22.01
		50	25	23.16	22.72	22.64
		50	50	23.22	23.21	22.30
		100	0	22.31	22.41	22.74

**EIRP:**

Band 4						
Bandwidth	Mode	RB Size	RB Offset	Actual output power(dBm)		
				Channel 19957 1710.7MHz	Channel 20175 1732.5MHz	Channel 20393 1754.3MHz
1.4MHz	QPSK	1	0	25.57	25.23	26.57
		1	2	26.75	26.02	25.17
		1	5	25.1	25.88	26.88
		3	0	25.7	26.59	26.18
		3	1	25.18	25.26	26.31
		3	2	25.34	26.67	26.27
		6	0	25.9	25.62	25.21
	16QAM	1	0	26.46	25.84	26.24
		1	2	25.29	25.62	25.44
		1	5	25.71	25.01	25.36
		3	0	26.83	26.06	25.56
		3	1	25.63	26.66	26.19
		3	2	25.88	25.3	25.19
		6	0	26.92	25.25	25.77
Bandwidth	Mode	RB Size	RB Offset	Actual output po2wer(dBm)		
				Channel 19965 1711.5MHz	Channel 20175 1732.5MHz	Channel 20385 753.5MHz
3MHz	QPSK	1	0	25.2	25.57	26.18
		1	8	26.63	26.32	26.68
		1	14	26.15	26.25	26.53
		8	0	25.54	25.57	26.24
		8	4	26.17	26.3	25.86
		8	7	25.44	26.7	26.58
		15	0	25.36	25.18	26.13
	16QAM	1	0	26.2	25.85	25.95
		1	8	26.94	25.99	26.69
		1	14	26.76	25.83	25.63
		8	0	25.84	25.07	26.18
		8	4	25.8	25.2	25.26
		8	7	26.2	26.04	26.88
		15	0	26.37	25.57	26.87

Bandwidth	Mode	RB Size	RB Offset	Actual output power(dBm)		
				Channel 19975 1712.5MHz	Channel 20175 1732.5MHz	Channel 20375 1752.5MHz
5MHz	QPSK	1	0	25.64	26.94	25.88
		1	13	25.65	25.36	26.49
		1	24	26.75	25.15	26.78
		12	0	25.97	26.62	26.8
		12	6	26.67	26.46	26.87
		12	13	25.31	25.27	25.81
	16QAM	25	0	26.55	25.73	25.49
		1	0	26.41	25.55	26.2
		1	13	26.94	26.38	26.44
		1	24	25.3	25.93	26.03
		12	0	25.74	25.19	26.66
		12	6	25.13	25.19	26.67
		12	13	25.23	26.44	26.95
		25	0	25.35	26.74	26.44
Bandwidth	Mode	RB Size	RB Offset	Actual output power(dBm)		
				Channel 20000 1715.0MHz	Channel 20175 1732.5MHz	Channel 20350 1750.0MHz
10MHz	QPSK	1	0	26.52	26.06	25.32
		1	25	26.55	25.98	26.46
		1	49	26.41	25.23	26.43
		25	0	25.66	26.07	26.03
		25	13	25.66	25.07	25.25
		25	25	25.12	26.41	25.82
		50	0	25.96	26.19	25.32
	16QAM	1	0	25.22	25.56	25.63
		1	25	26.52	25.99	25.04
		1	49	25.15	26.23	26.77
		25	0	25.94	26.41	26.69
		25	13	25.01	25.82	26.02
		25	25	26.17	25.37	25.8
		50	0	25.26	25.99	25.7

Bandwidth	Mode	RB Size	RB Offset	Actual output power(dBm)		
				Channel 20025 1717.5MHz	Channel 20175 1732.5MHz	Channel 20325 1747.5MHz
15MHz	QPSK	1	0	26.37	26.06	25.31
		1	38	26.28	26.55	25.67
		1	74	26.34	26.88	26.93
		36	0	25.38	26.11	25.36
		36	18	26.95	25.57	26.94
		36	39	26.96	25.02	25.81
		75	0	25.82	25.23	25.72
	16QAM	1	0	26.52	25.6	26.83
		1	38	25.64	26.95	26.28
		1	74	26.98	25.98	25.94
		36	0	26.09	25.78	26.61
		36	18	26.63	25.77	25.49
		36	39	25.49	25.5	25.22
		75	0	26.81	25.17	26.74
Bandwidth	Mode	RB Size	RB Offset	Actual output power(dBm)		
				Channel 20050 1720.0MHz	Channel 20175 1732.5MHz	Channel 20300 1745.0MHz
20MHz	QPSK	1	0	25.48	25.7	25.86
		1	50	25.28	26.53	25.81
		1	99	26.37	25.92	25.43
		50	0	26.45	26.51	26.75
		50	25	26.63	26.68	26.77
		50	50	26.01	25.71	25.81
		100	0	25.33	26.56	25.51
	16QAM	1	0	26.78	25.62	25.31
		1	50	26.12	26.64	25.33
		1	99	25.47	26.46	26.67
		50	0	26.82	26.59	25.01
		50	25	26.16	25.72	25.64
		50	50	26.22	26.21	25.3
		100	0	25.31	25.41	25.74

## 7.4 Peak-to-Average Ratio

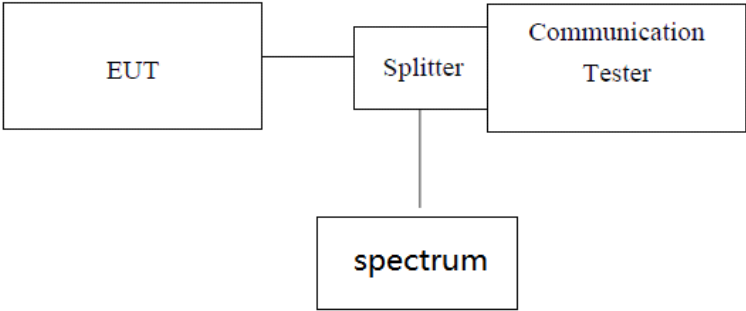
Test Requirement for FCC:	FCC part24.232(d) & FCC Part 27.50
Limit:	13db
Test setup:	 <p style="text-align: center;"><i>Note: Measurement setup for testing on Antenna connector</i></p>
Test Instruments:	Refer to section 5.0 for details
Test mode:	Refer to section 6.1 for details
Test results:	Pass

### Measurement data:

Modulation	Bandwidth	Peak to Average Ratio (dB)			Limit (dB)	Result
		Low Ch.	Middle Ch.	High Ch.		
QPSK	1.4MHz	2.42	2.72	2.62	13	PASS
	3MHz	3.21	3.13	3.57	13	PASS
	5MHz	4.15	4.96	4.31	13	PASS
	10MHz	5.66	5.84	5.42	13	PASS
	15MHz	5.31	5.53	5.30	13	PASS
	20MHz	6.48	6.48	6.87	13	PASS
16QAM	1.4MHz	2.31	2.48	2.49	13	PASS
	3MHz	3.71	3.23	3.11	13	PASS
	5MHz	4.75	4.91	4.73	13	PASS
	10MHz	6.00	5.26	5.48	13	PASS
	15MHz	5.01	5.44	5.03	13	PASS
	20MHz	6.51	6.72	6.91	13	PASS

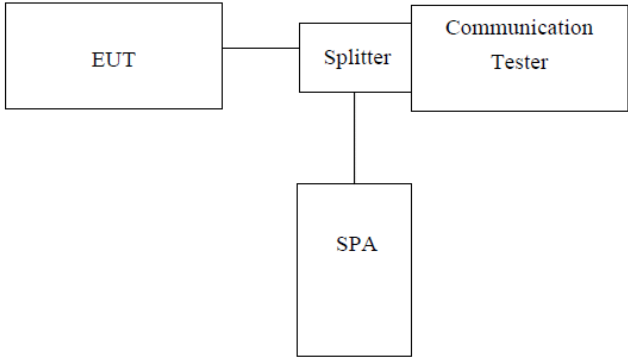

## 7.5 Occupancy Bandwidth

Test Requirement for FCC:	Part 24.238; FCC Part 27.53(h)/(g)
Test setup:	 <p style="text-align: center;"><i>Note: Measurement setup for testing on Antenna connector</i></p>
Test Procedure:	<ol style="list-style-type: none"> <li>1. The EUT's output RF connector was connected with a short cable to the spectrum analyzer</li> <li>2. RBW was set to about 1% of emission BW, VBW= 3 times RBW.</li> <li>3. -26dBc display line was placed on the screen (or 99% bandwidth), the occupied bandwidth is the delta frequency between the two points where the display line intersects the signal trace.</li> </ol>
Test Instruments:	Refer to section 5.0 for details
Test mode:	Refer to section 6.1 for details
Test results:	Pass

Measurement Data

Channel Bandwidth	Channel	RB Configure		QPSK		16QAM	
		RB Size	RB Offset	99% Occupy bandwidth (MHz)	-26dB bandwidth (MHz)	99% Occupy bandwidth (MHz)	-26dB bandwidth (MHz)
1.4MHz	Low	6	0	1.0966	1.268	1.1019	1.317
	Mid	6	0	1.0986	1.286	1.0953	1.286
	High	6	0	1.0967	1.276	1.0963	1.302
3MHz	Low	15	0	2.6699	2.867	2.6729	2.863
	Mid	15	0	2.6716	2.870	2.6733	2.858
	High	15	0	2.6745	2.874	2.6719	2.849
5MHz	Low	25	0	4.5223	5.208	4.5327	5.128
	Mid	25	0	4.5499	5.125	4.5232	5.092
	High	25	0	4.5319	5.168	4.5500	6.667
10MHz	Low	50	0	8.9524	9.896	8.9575	9.758
	Mid	50	0	8.9677	9.837	8.9634	9.886
	High	50	0	8.9676	9.878	8.9654	9.902
15MHz	Low	75	0	13.4562	14.905	13.4323	14.914
	Mid	75	0	13.4750	15.071	13.4493	14.735
	High	75	0	13.3973	14.766	13.4411	14.669
20MHz	Low	100	0	17.8316	19.250	17.8668	19.295
	Mid	100	0	17.8972	19.048	17.9313	17.405
	High	100	0	17.8255	19.543	17.7928	18.792

Test plot as follows:

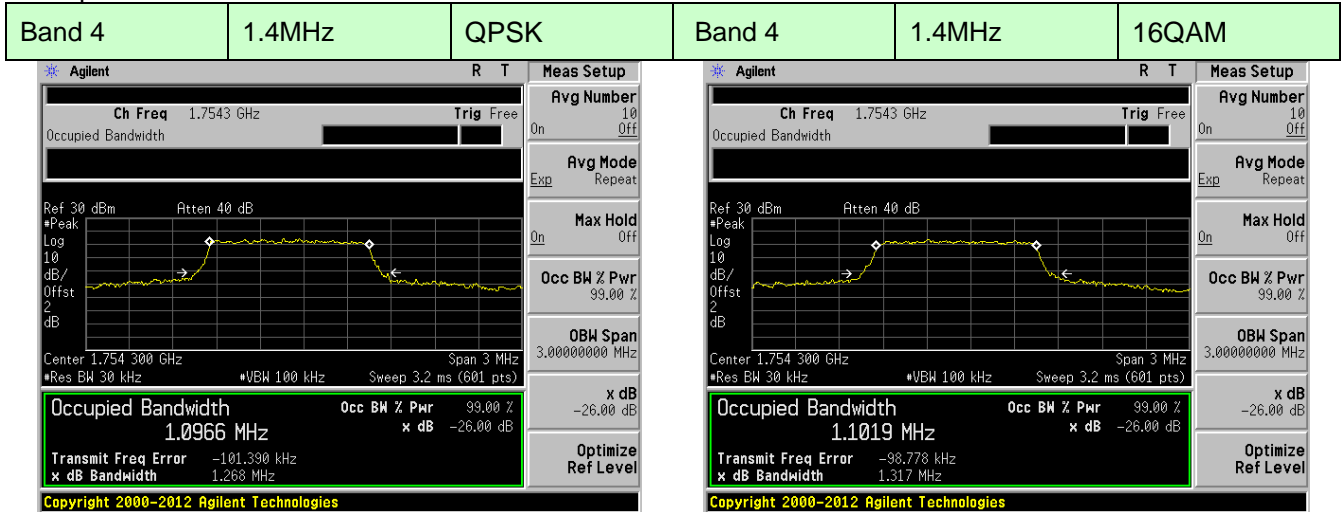

Lowest channel

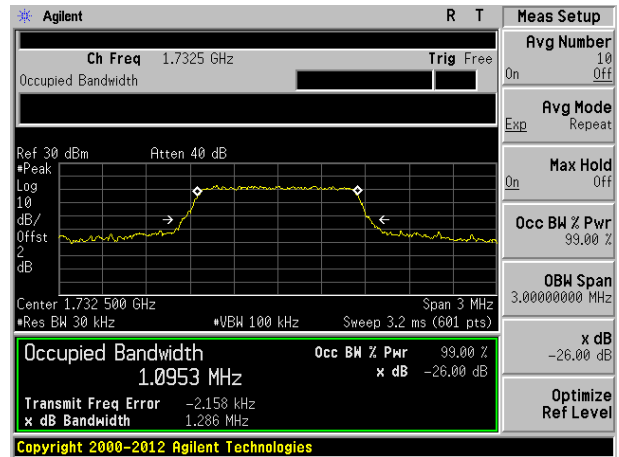
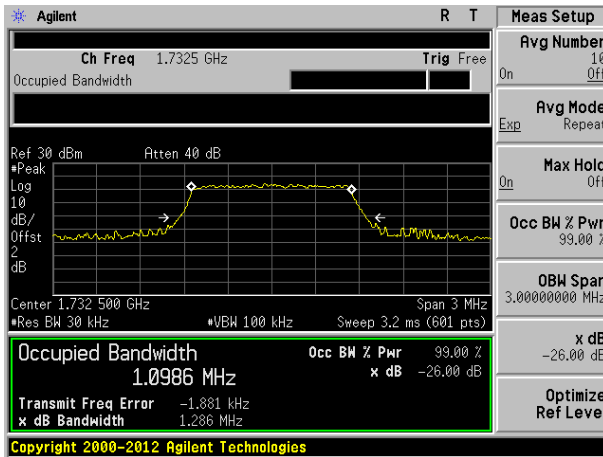

Middle channel

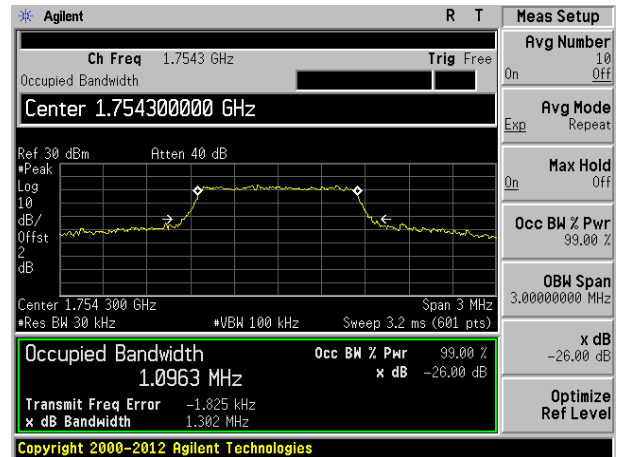
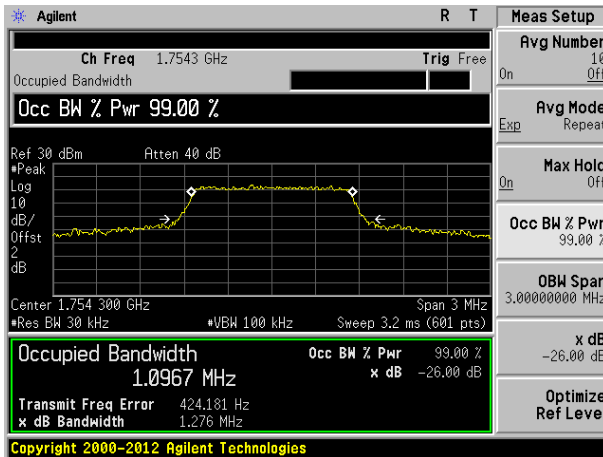

Highest channel

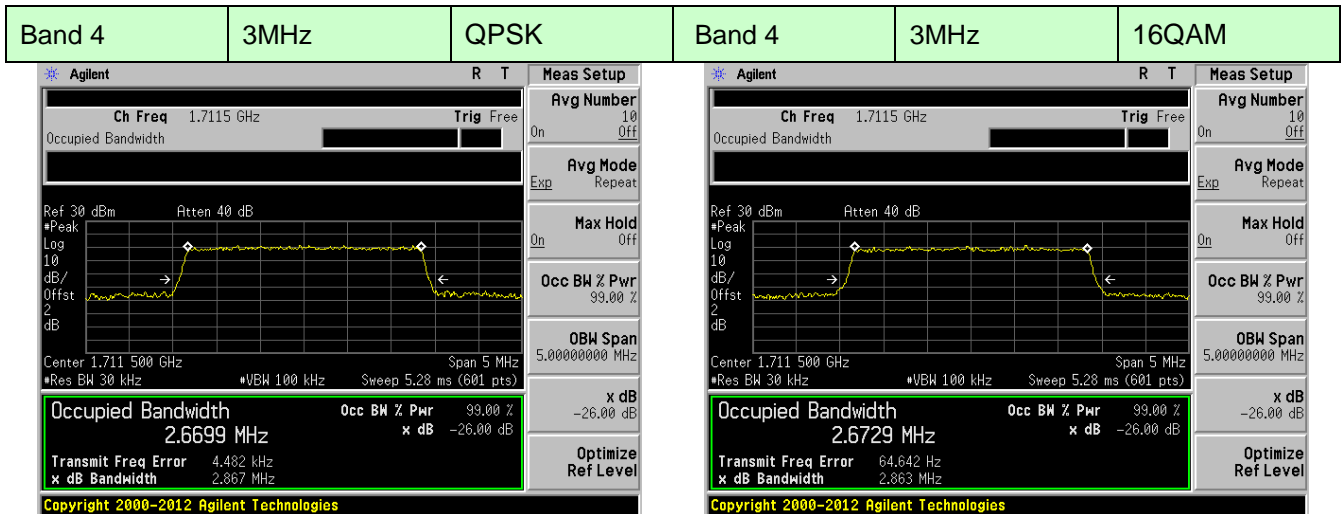

Lowest channel

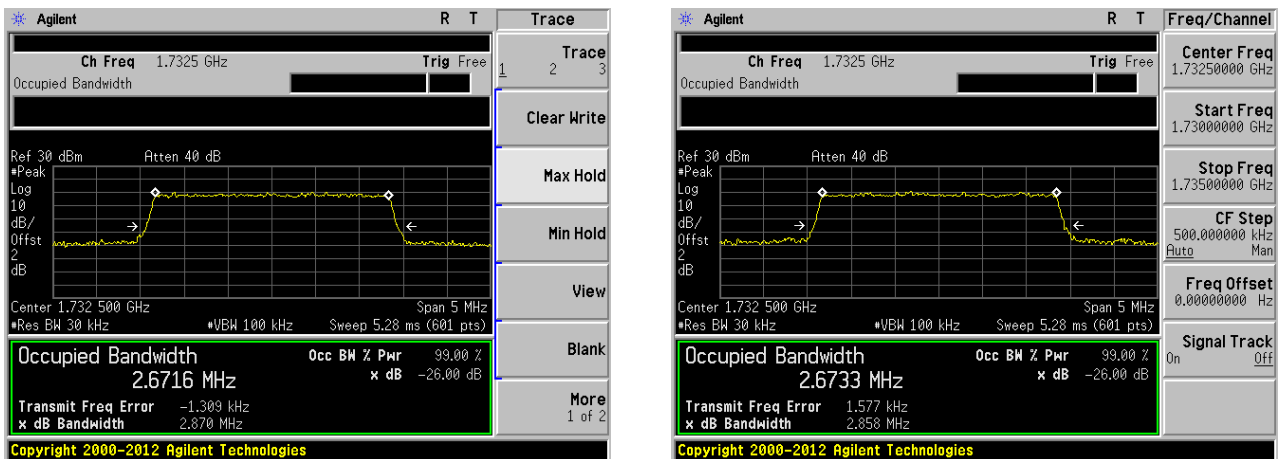

Middle channel

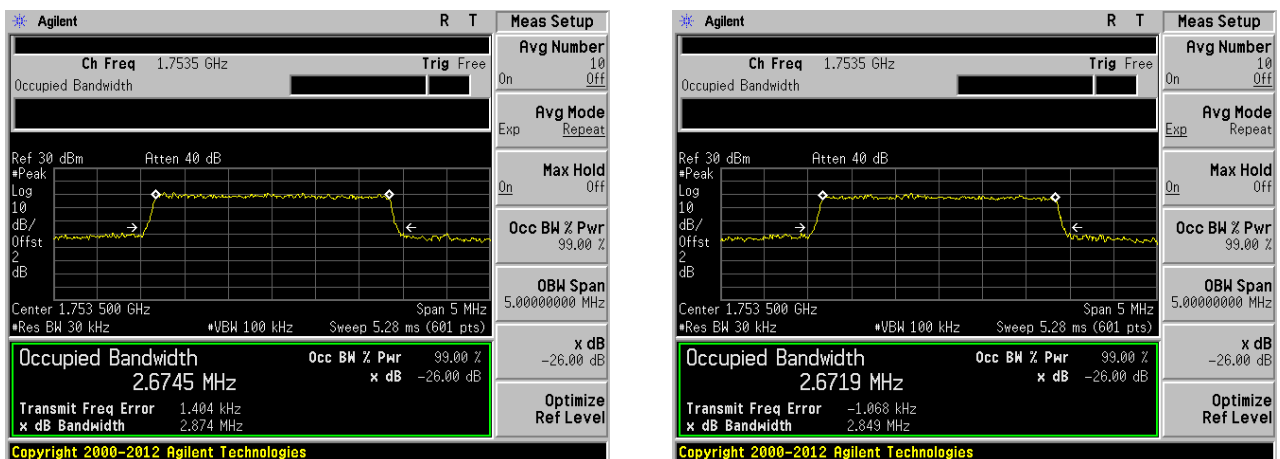

Highest channel

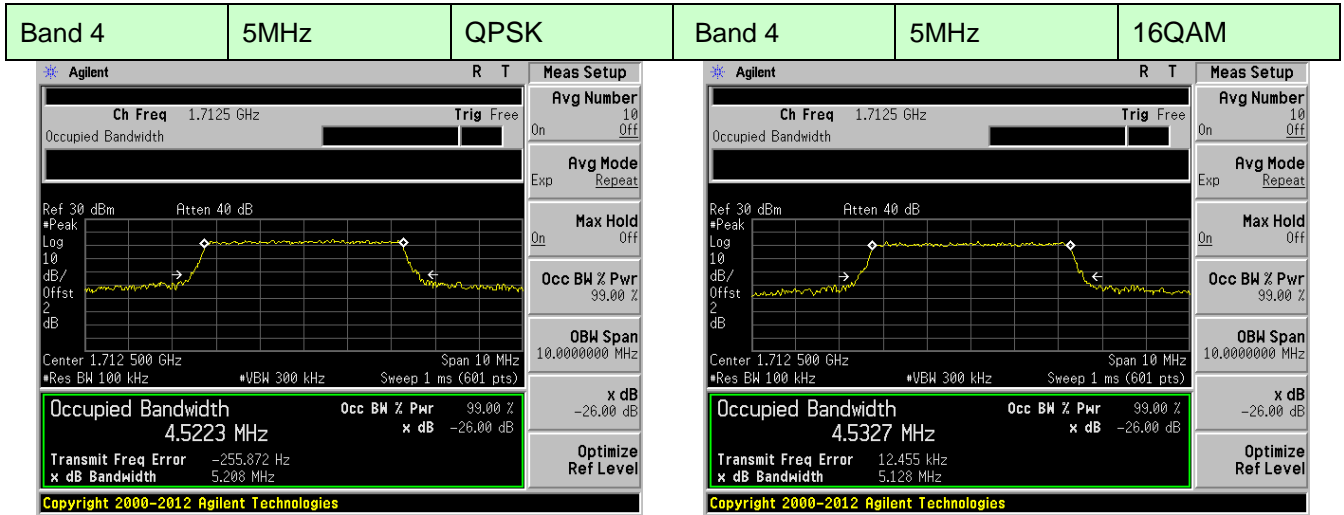

Lowest channel

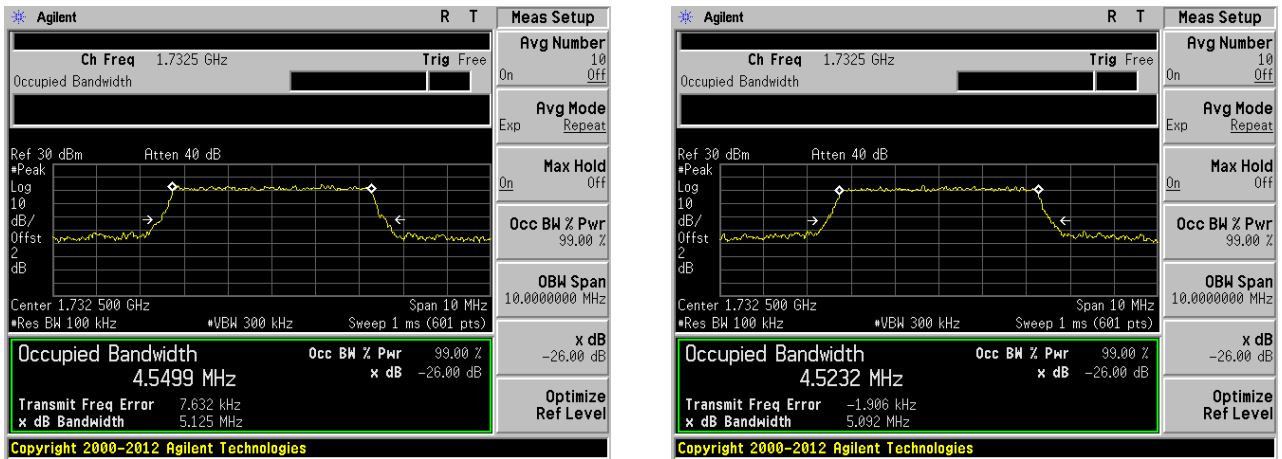

Middle channel

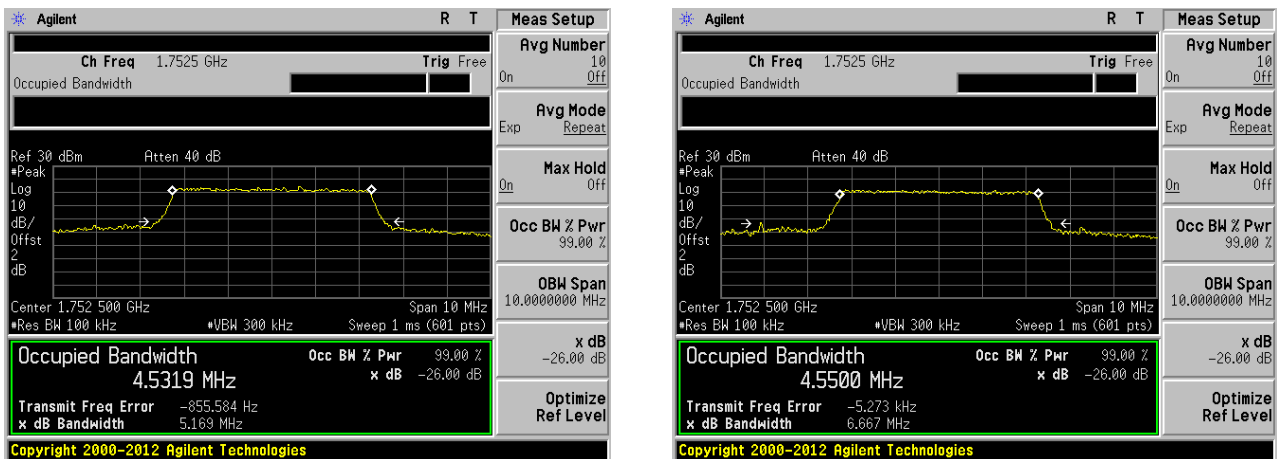

Highest channel

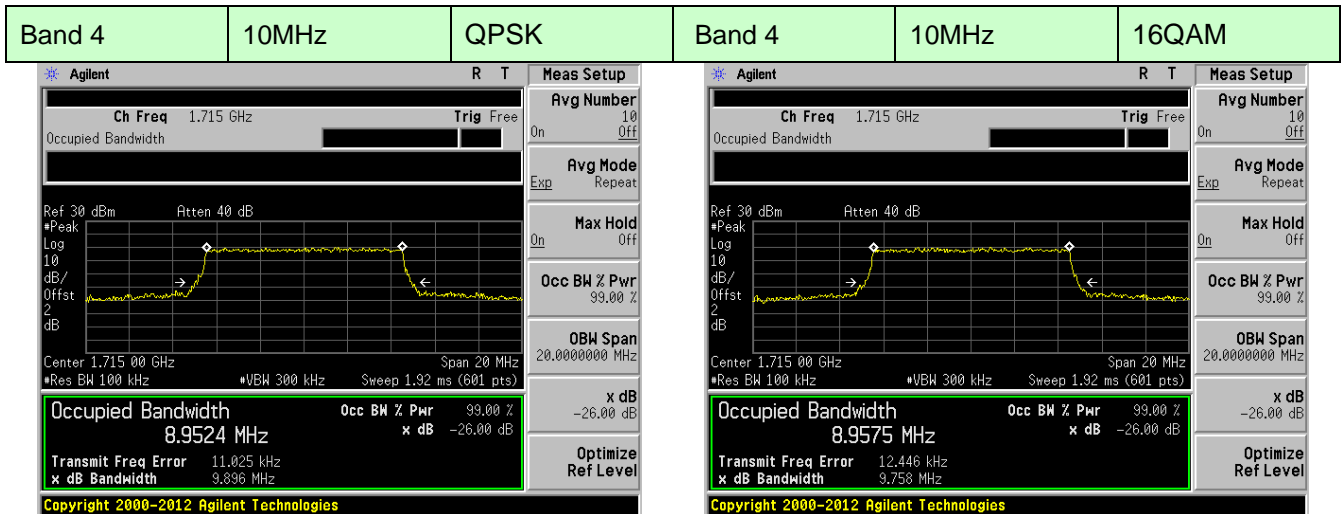

Lowest channel

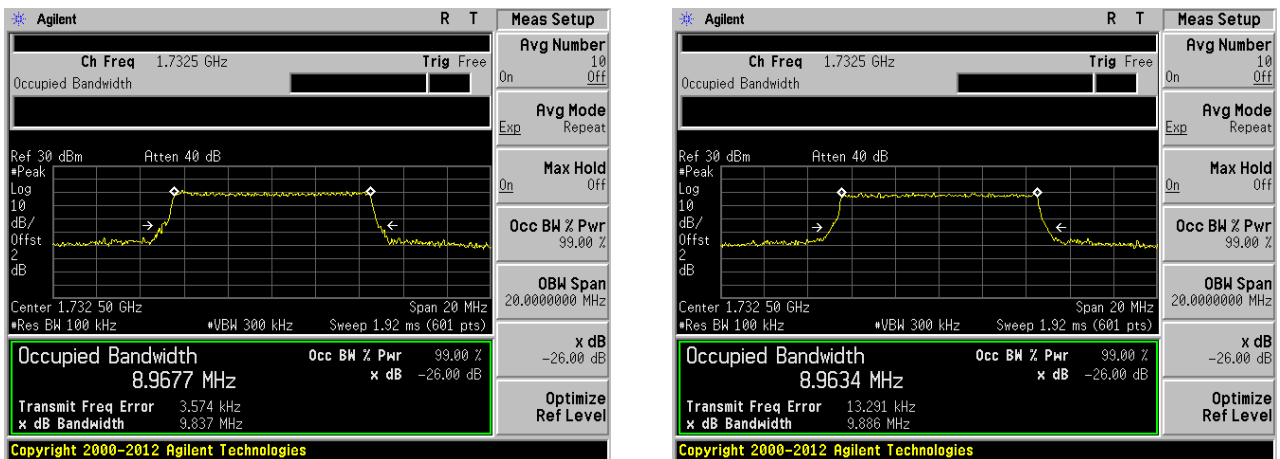

Middle channel

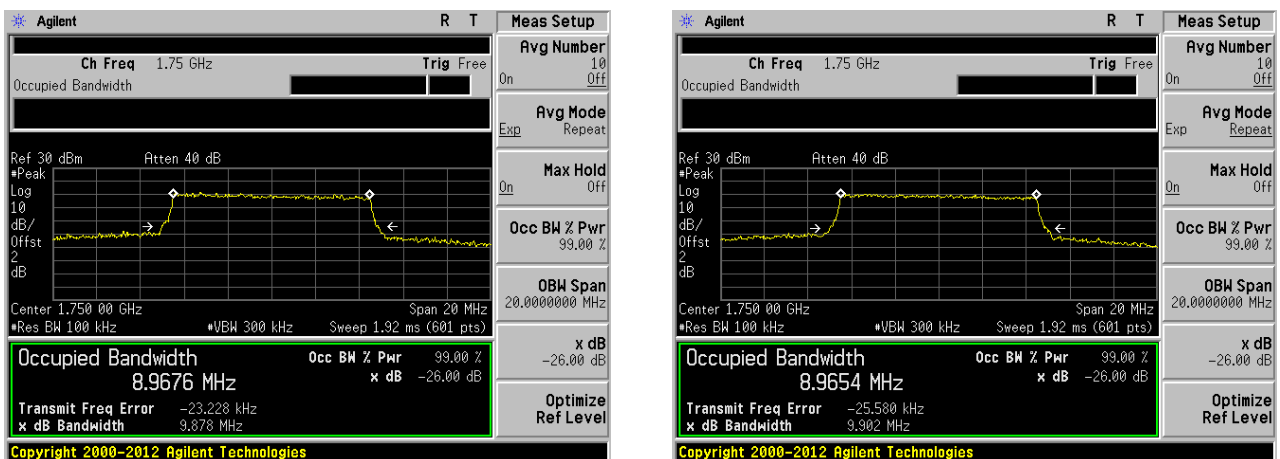

Highest channel

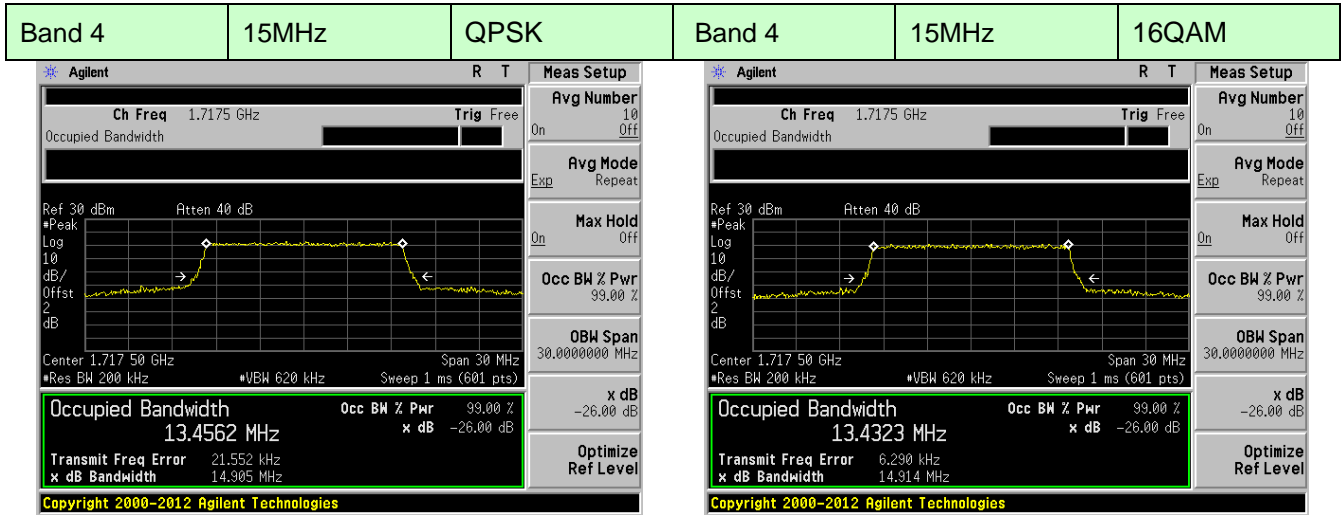

Lowest channel

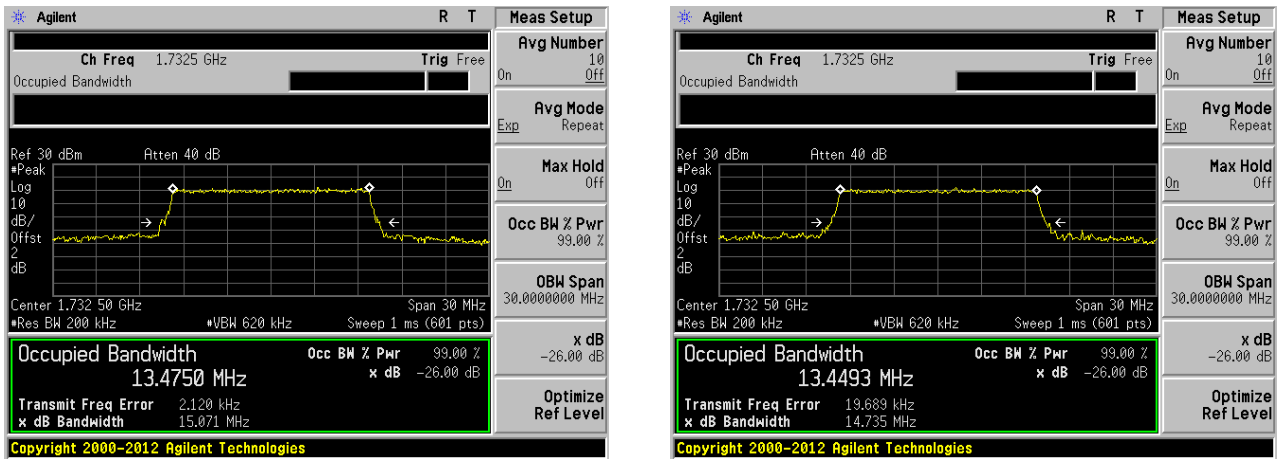

Middle channel

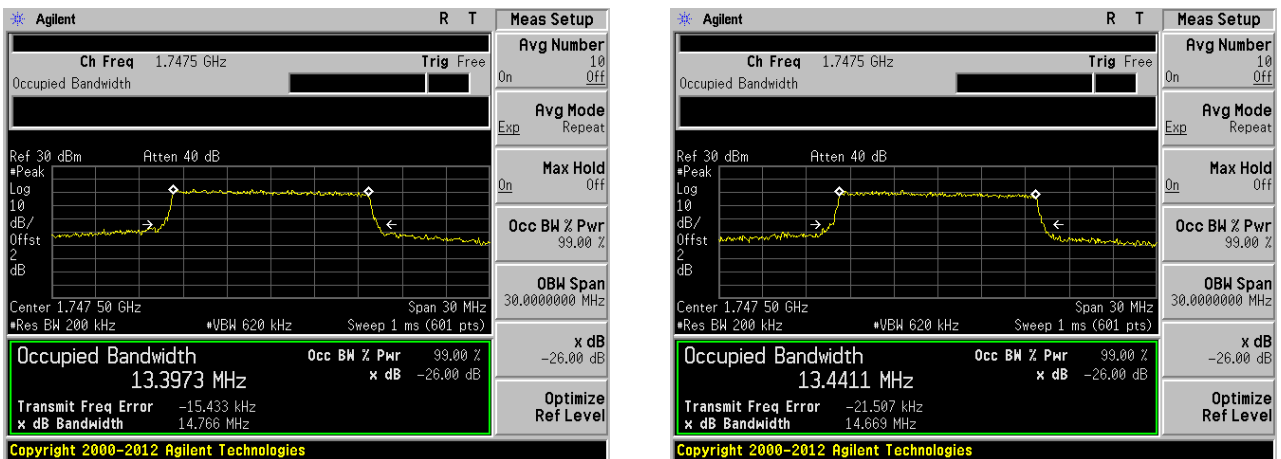

Highest channel

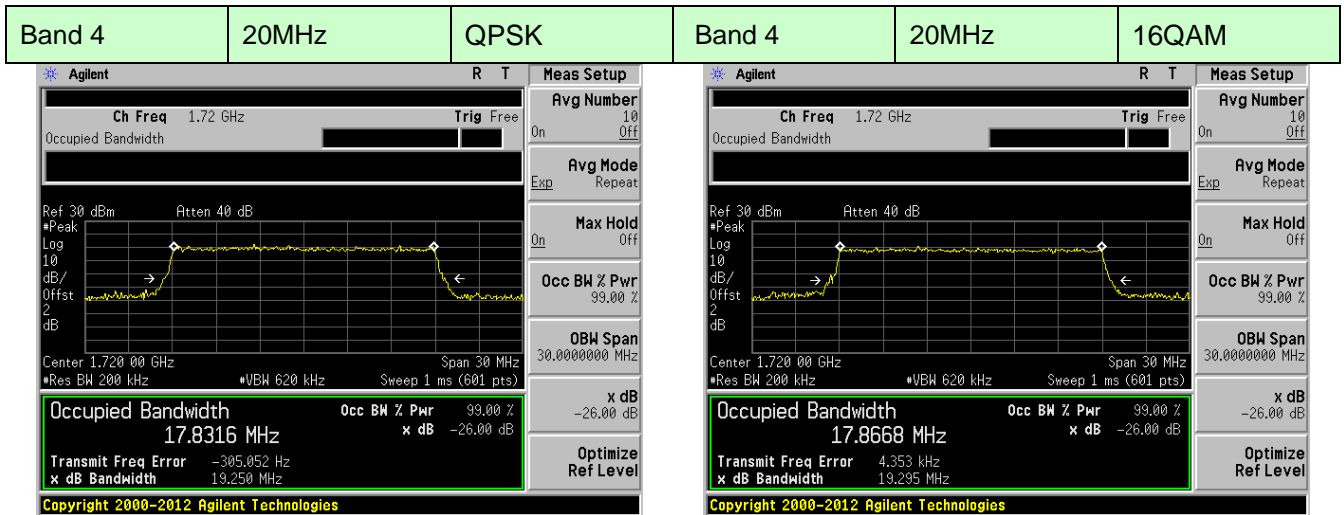

Lowest channel

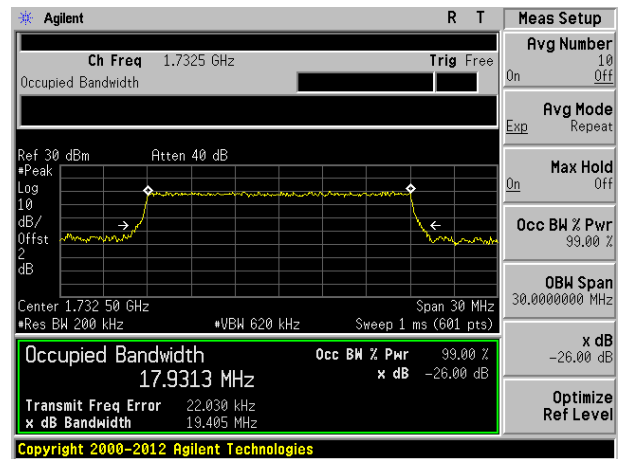
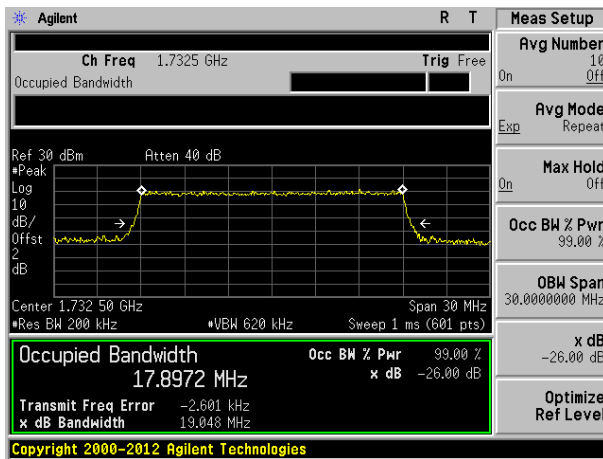

Middle channel

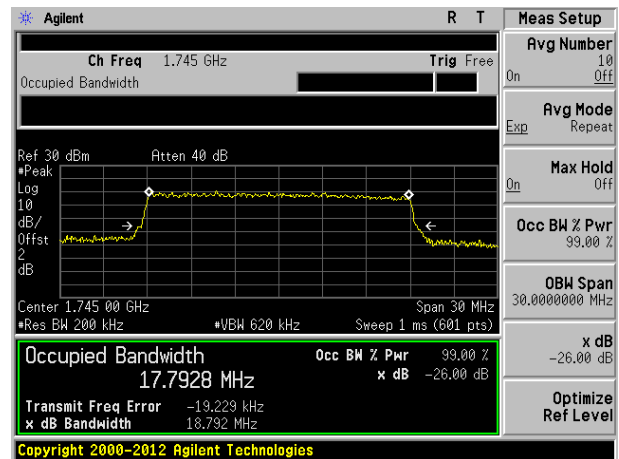
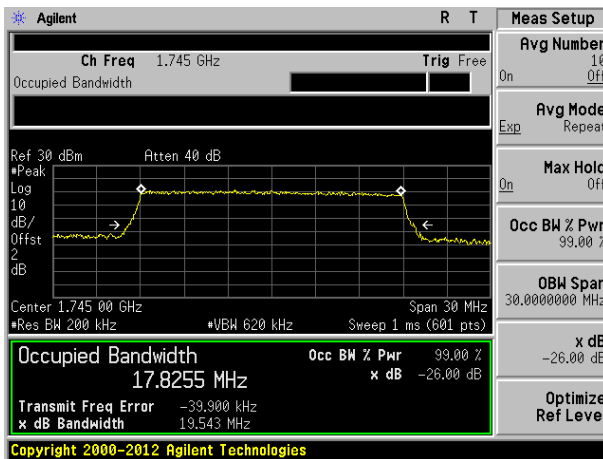

Highest channel



## 7.6 MODULATION CHARACTERISTIC

According to FCC § 2.1047(d), Part 27 there is no specific requirement for digital modulation, therefore modulation characteristic is not presented.

## 7.7 Out of band emission at antenna terminals

Test Requirement for FCC:	Part 24.238 (a); FCC Part 27.53(h)/(g)
Limit:	-13dBm
Test setup:	<pre> graph LR     EUT[EUT] --- Splitter[Splitter]     Splitter --- CT[Communication Tester]     Splitter --- Filter[Filter]     Filter --- SPA[SPA]     </pre> <p><i>Note: Measurement setup for testing on Antenna connector</i></p>
Test Procedure:	<ol style="list-style-type: none"> <li>1 The RF output of the transceiver was connected to a spectrum analyzer through appropriate attenuation.</li> <li>2 The resolution bandwidth of the spectrum analyzer was set at 1MHz, sufficient scans were taken to show the out of band Emissions if any up to 10th harmonic.</li> <li>3 For the out of band: Set the RBW, VBW = 1MHz, Start=30MHz, Stop= 10th harmonic.</li> <li>4 Band Edge Requirements: In the 1 MHz bands immediately outside and adjacent to the frequency block, a resolution bandwidth of at least 1 percent of the emission bandwidth of the fundamental emission of the transmitter may be employed to measure the out of band Emissions.</li> </ol>
Test Instruments:	Refer to section 5.0 for details
Test mode:	Refer to section 6.1 for details
Test results:	Pass

Test plot as follows:

Test Mode: LTE Band 4 Channel Bandwidth: 1.4MHz

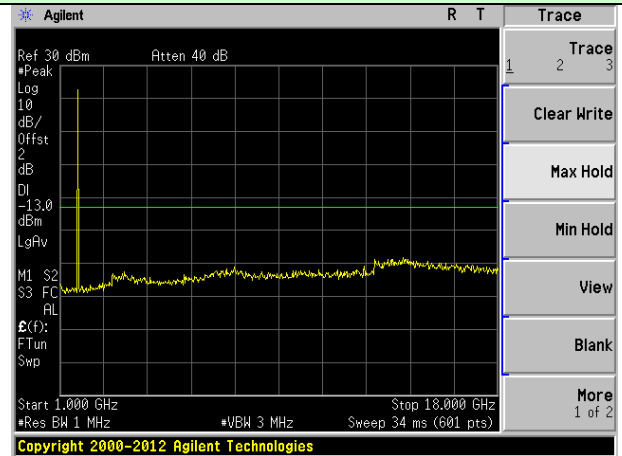
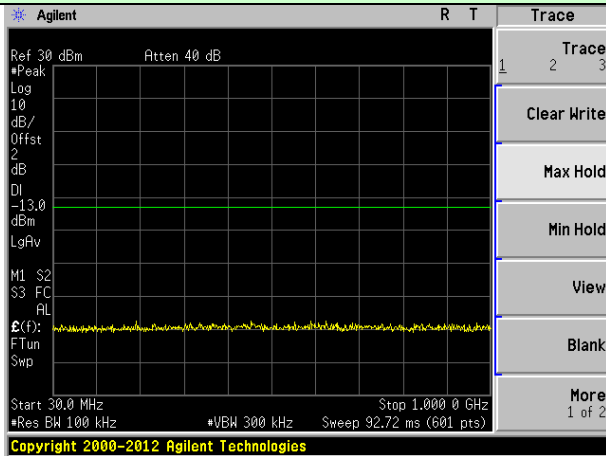

Lowest channel

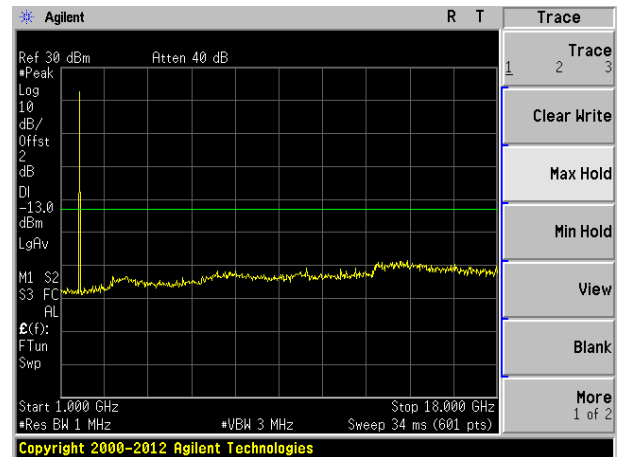
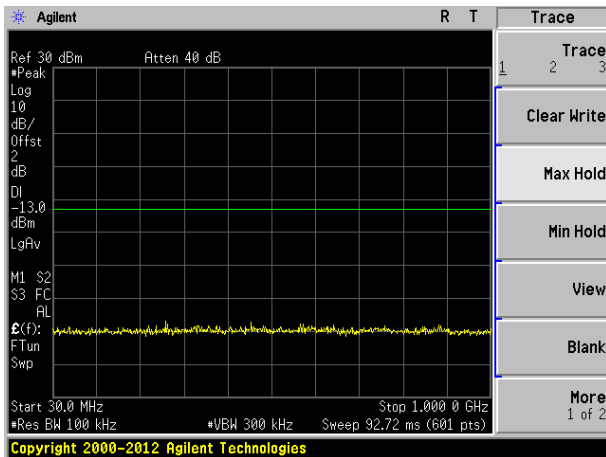

Middle channel

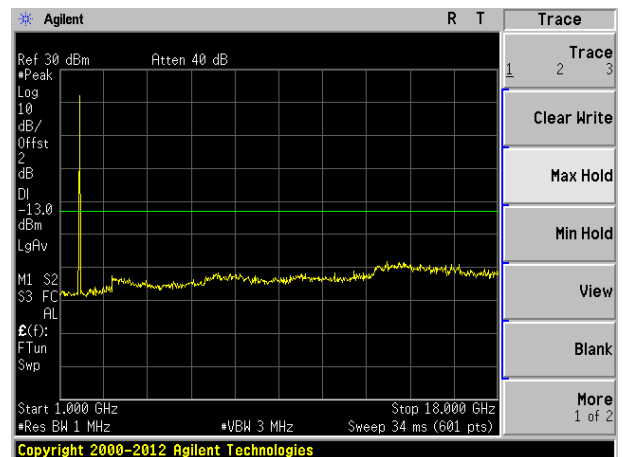
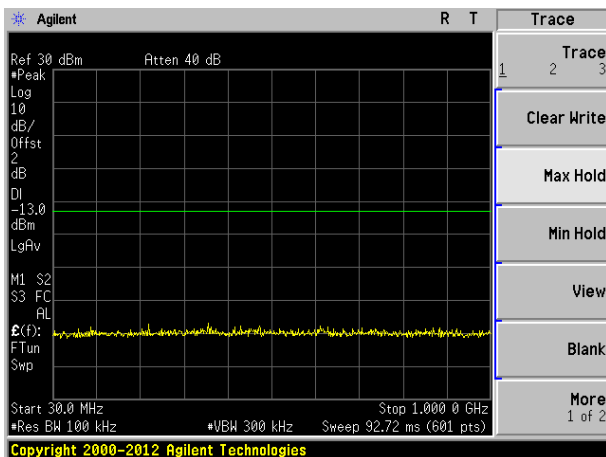

Highest channel

Test Mode: LTE Band 4 Channel Bandwidth: 3MHz

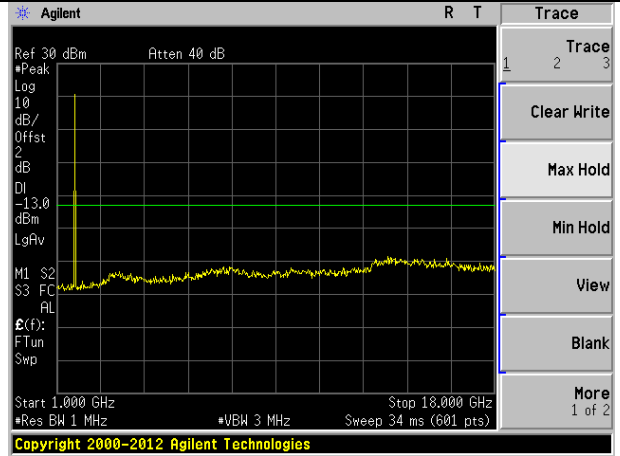
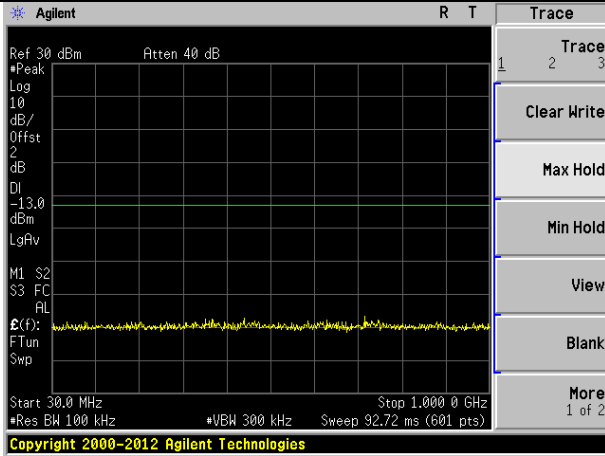

Lowest channel

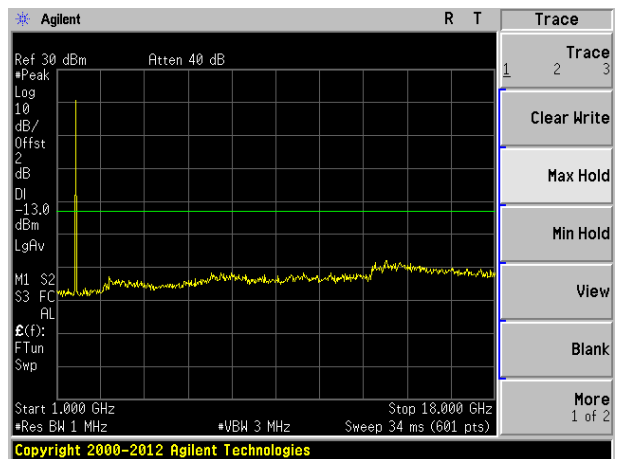
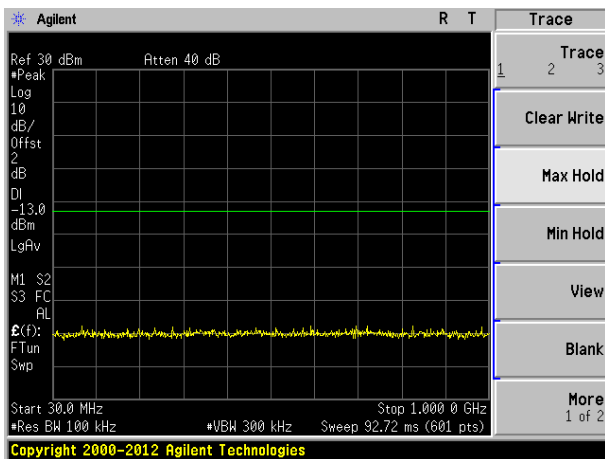

Middle channel

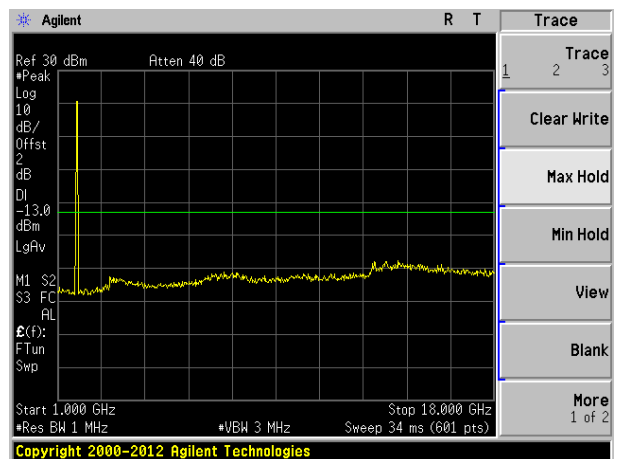
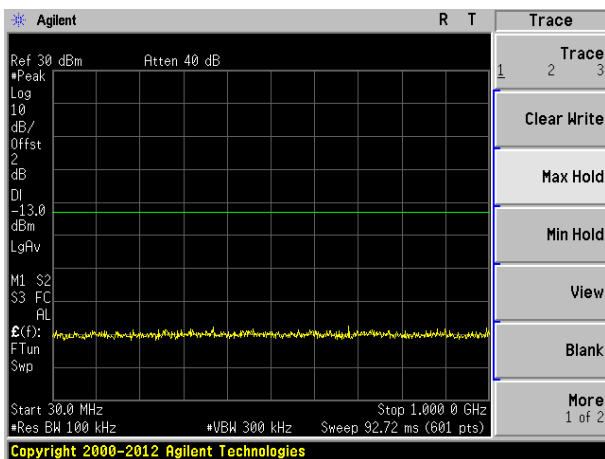

Highest channel

Test Mode: LTE Band 4 Channel Bandwidth: 5MHz

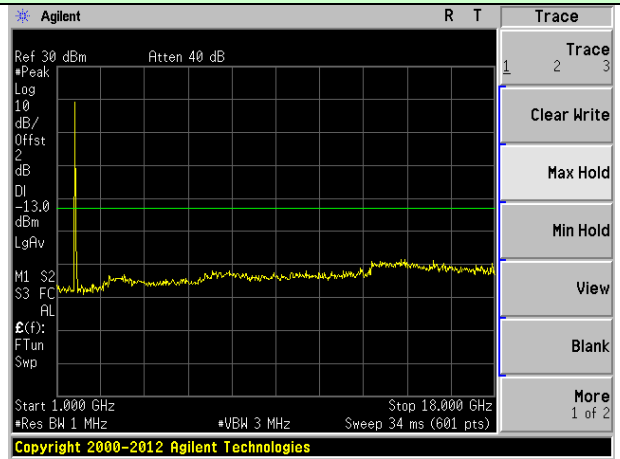
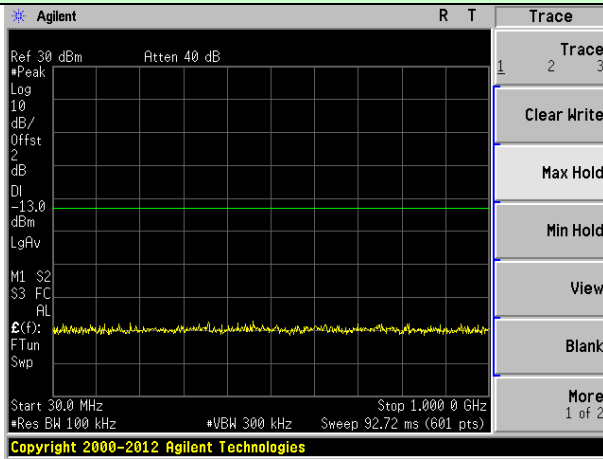

Lowest channel

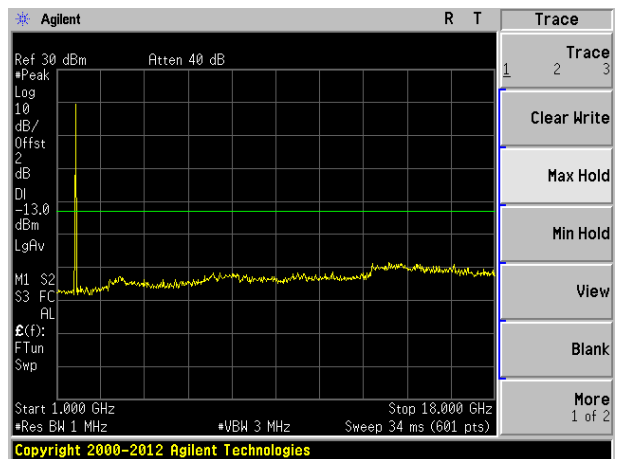
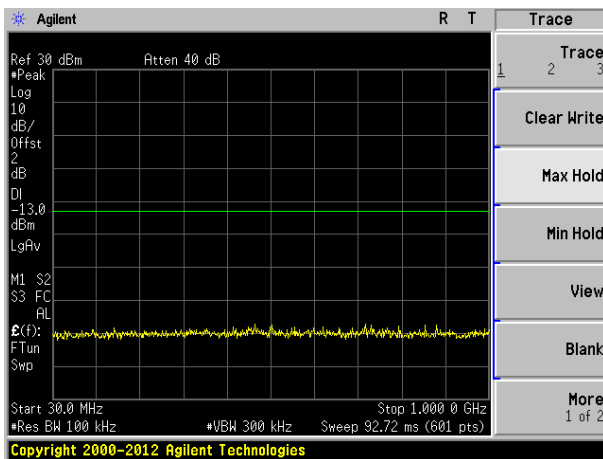

Middle channel

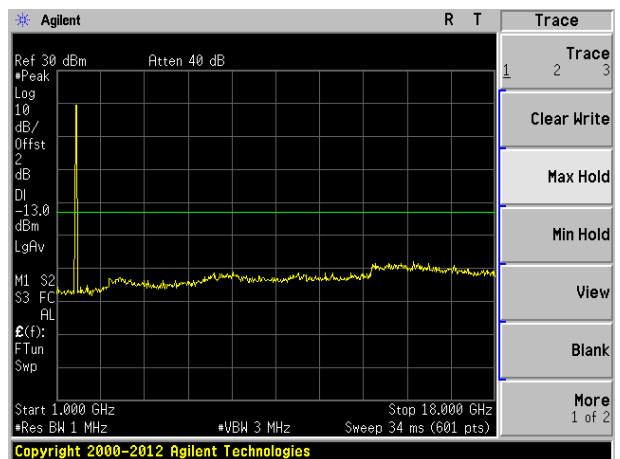
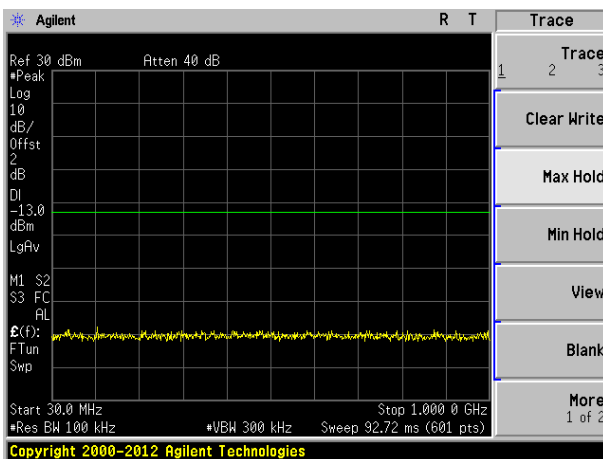

Highest channel

Test Mode: LTE Band 4 Channel Bandwidth: 10MHz

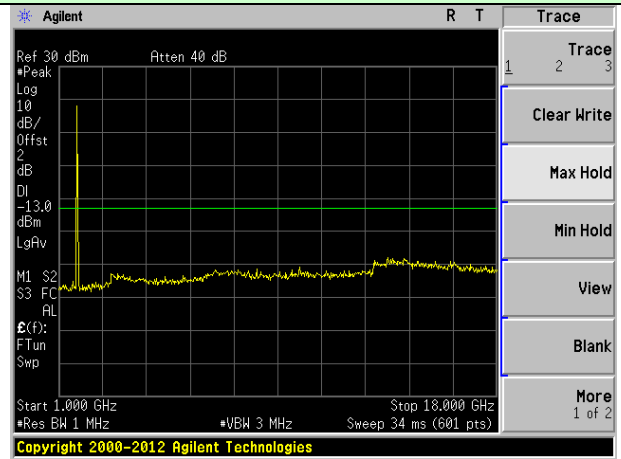
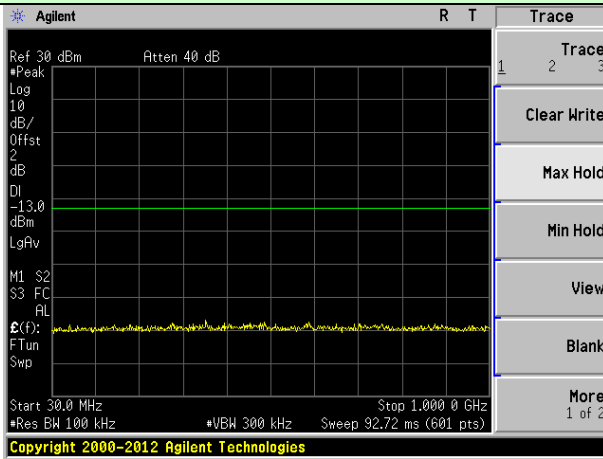

Lowest channel

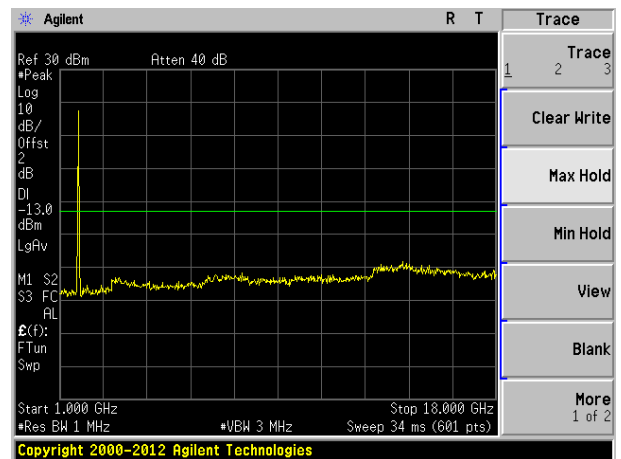
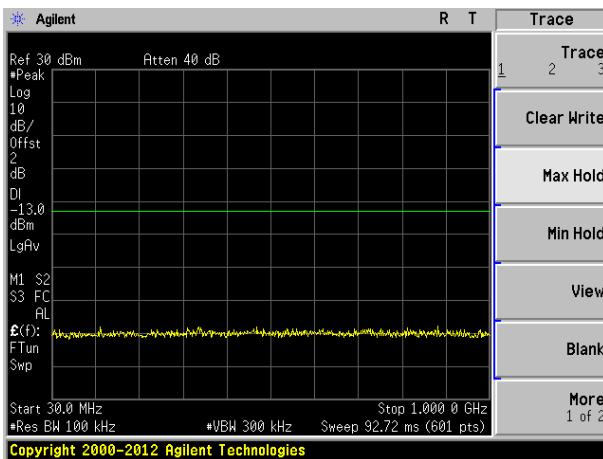

Middle channel

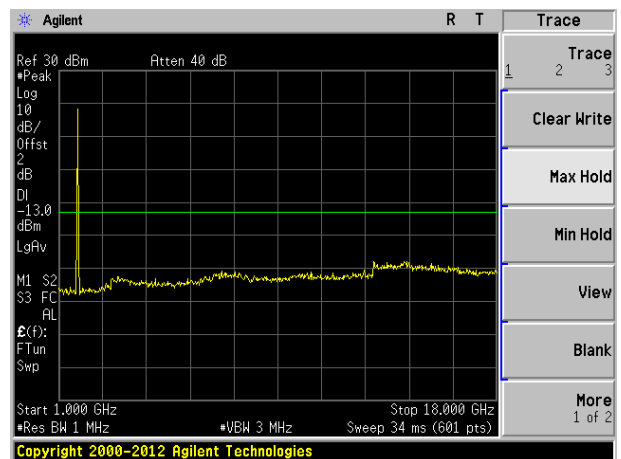
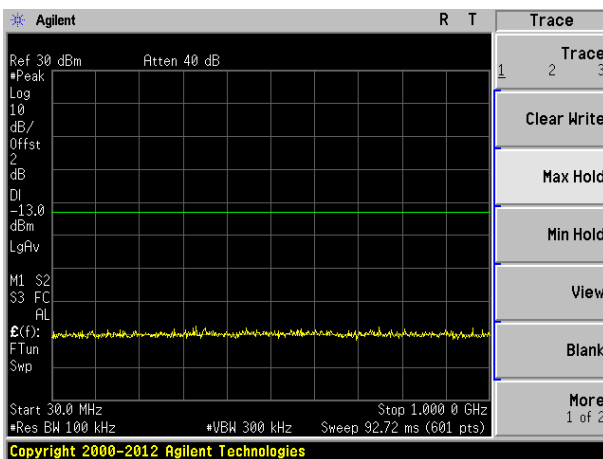

Highest channel

Test Mode: LTE Band 4 Channel Bandwidth: 15MHz

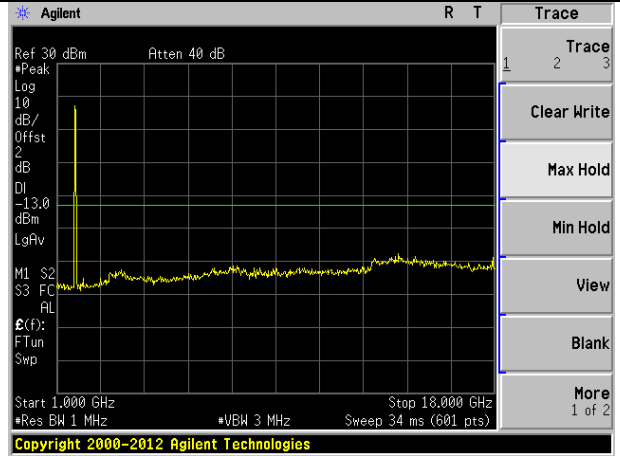
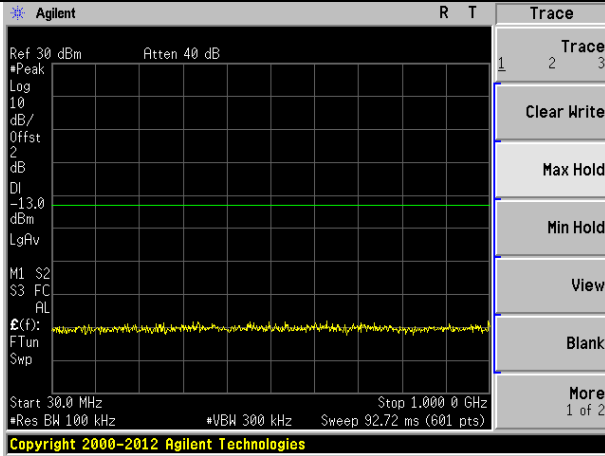

Lowest channel

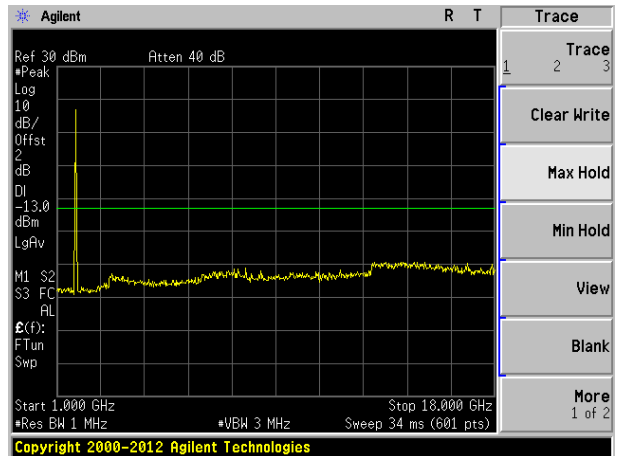
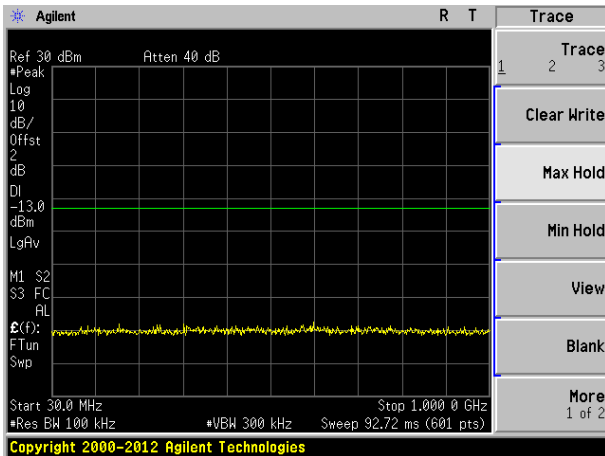

Middle channel

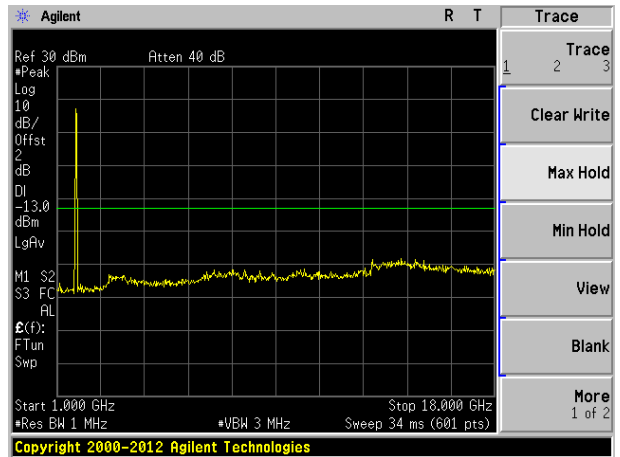
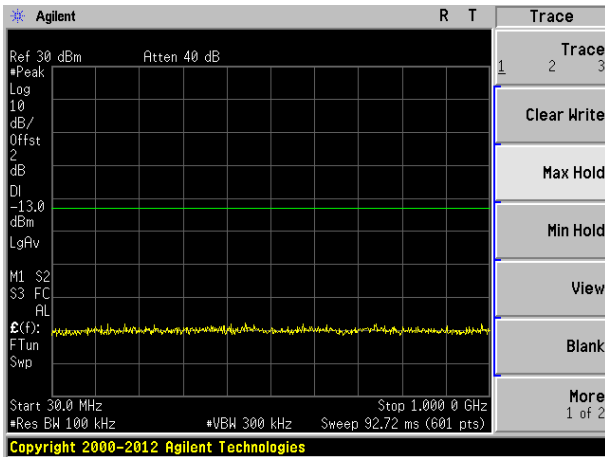

Highest channel

Test Mode: LTE Band 4 Channel Bandwidth: 20MHz

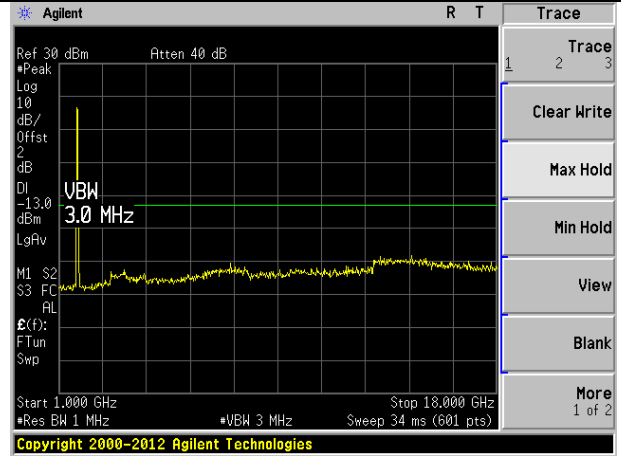
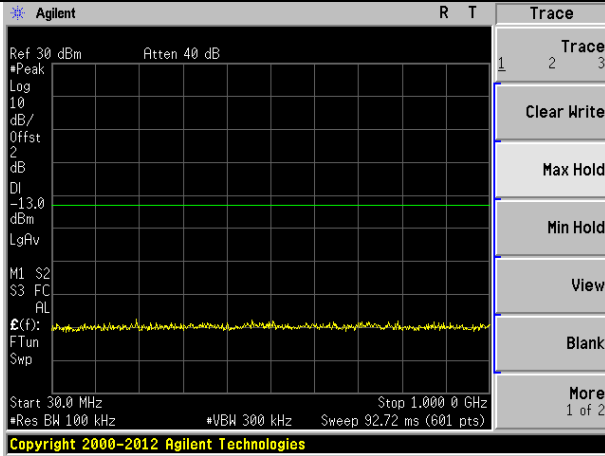

Lowest channel

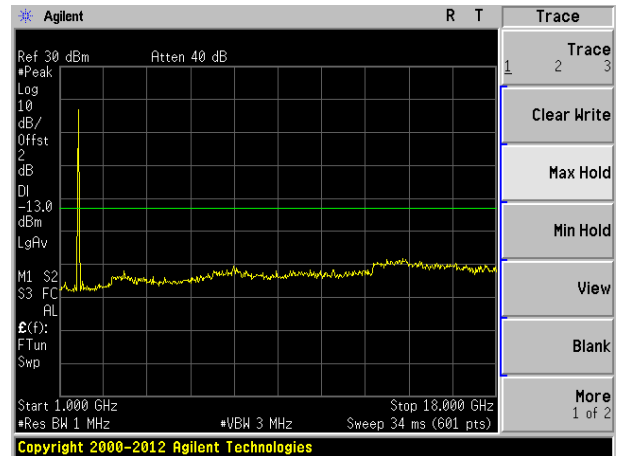
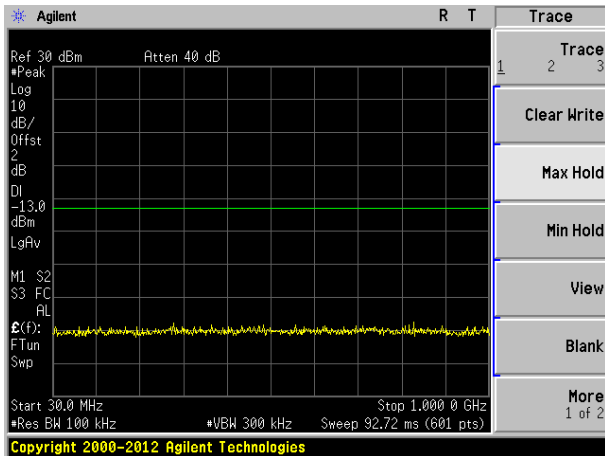

Middle channel

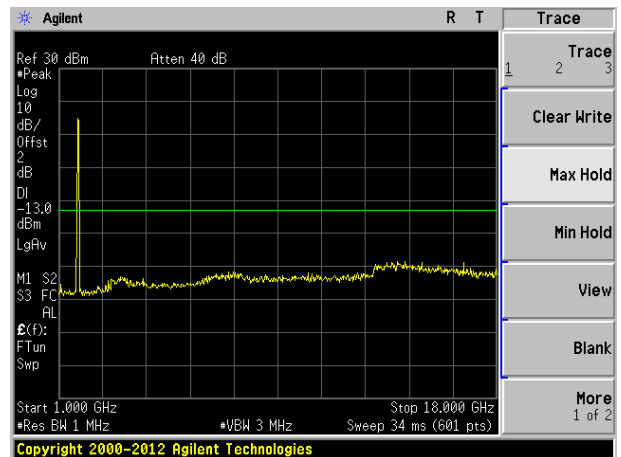
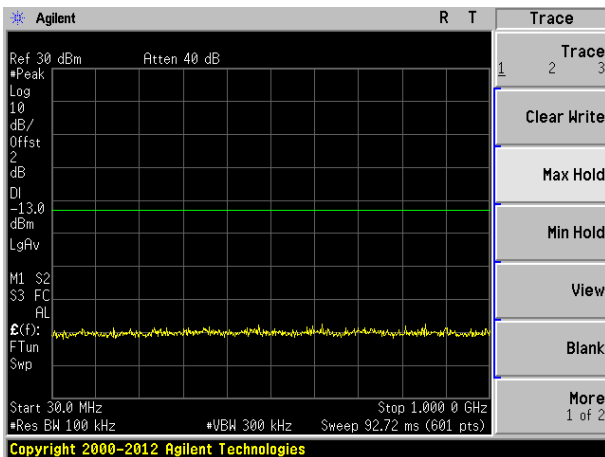

Highest channel

**Band Edge:**  
**QPSK mode: LTE Band 4**

1.4MHz Bandwidth (RB size:1# RB offset:0#)

1.4MHz Bandwidth (RB size:1# RB offset:5#)

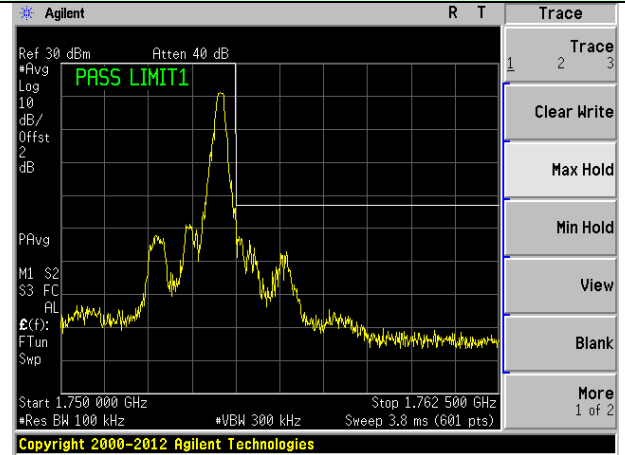
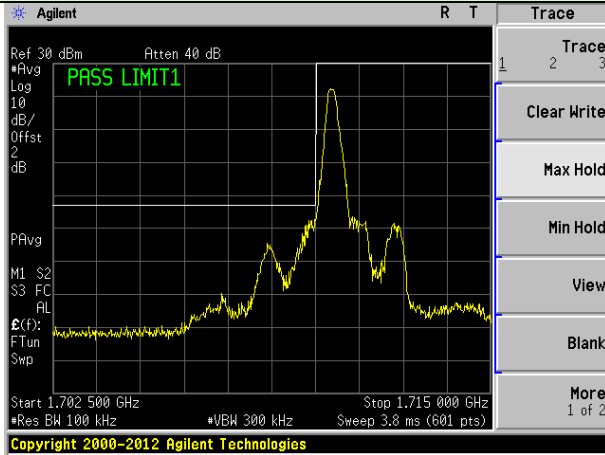

Lowest channel

Highest channel

1.4MHz Bandwidth (RB size:3# RB offset:0#)

1.4MHz Bandwidth (RB size:3# RB offset:2#)

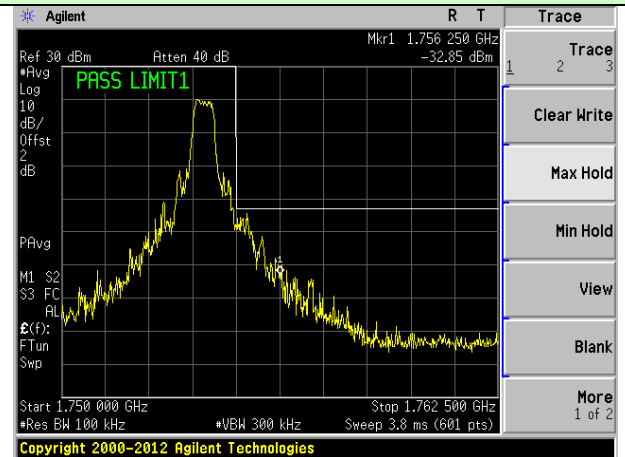
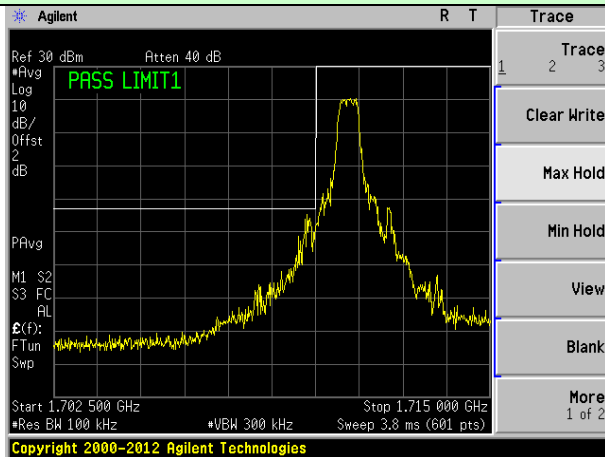

Lowest channel

Highest channel

1.4MHz Bandwidth (RB size:6# RB offset:0#)

1.4MHz Bandwidth (RB size:6# RB offset:0#)

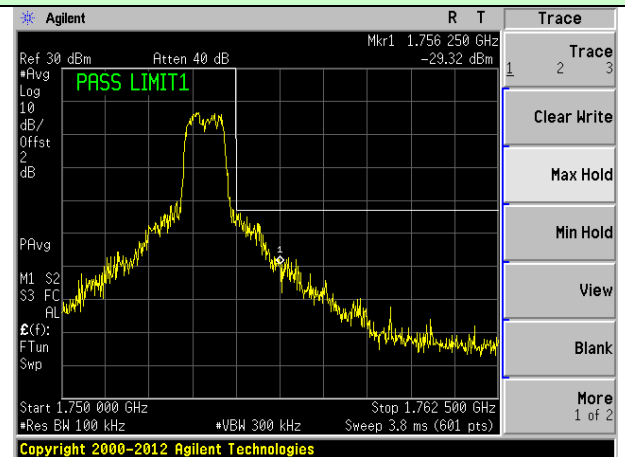
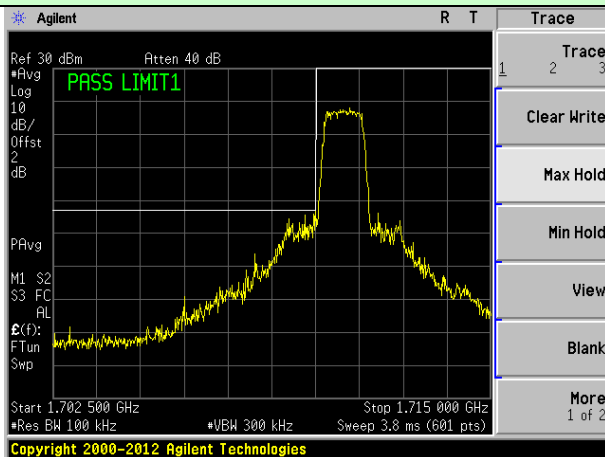

Lowest channel

Highest channel



**3MHz Bandwidth (RB size:1# RB offset:0#)**      **3MHz Bandwidth (RB size:1# RB offset:14#)**

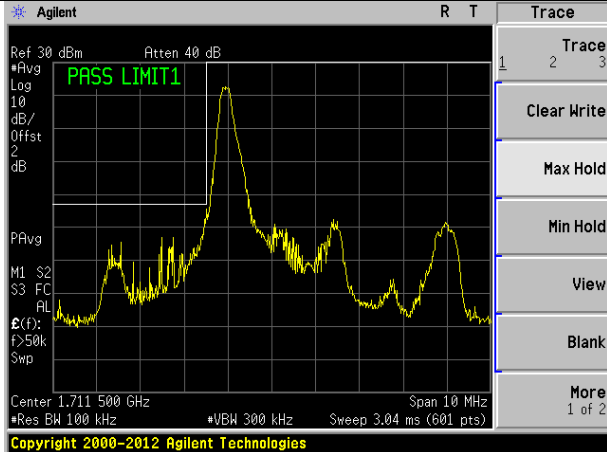

Lowest channel

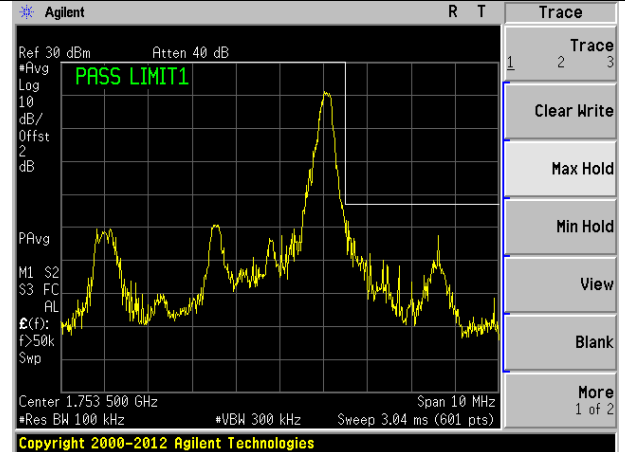

Highest channel

**3MHz Bandwidth (RB size:8# RB offset:0#)**      **3MHz Bandwidth (RB size:8# RB offset:7#)**

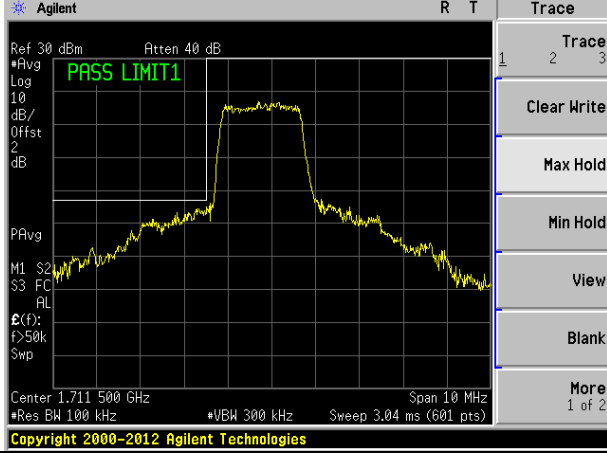

Lowest channel

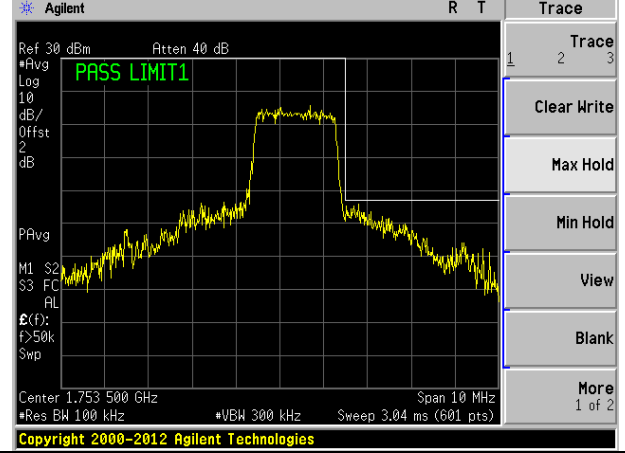

Highest channel

**3MHz Bandwidth (RB size:15# RB offset:0#)**      **3MHz Bandwidth (RB size:15# RB offset:0#)**

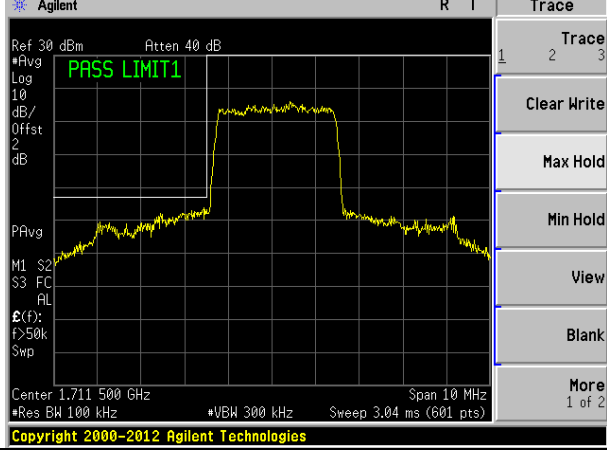

Lowest channel

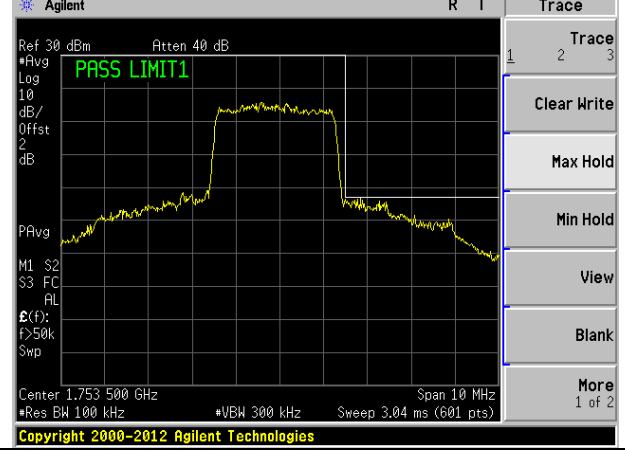

Highest channel

5MHz Bandwidth (RB size:1# RB offset:0#)      5MHz Bandwidth (RB size:1# RB offset:24#)

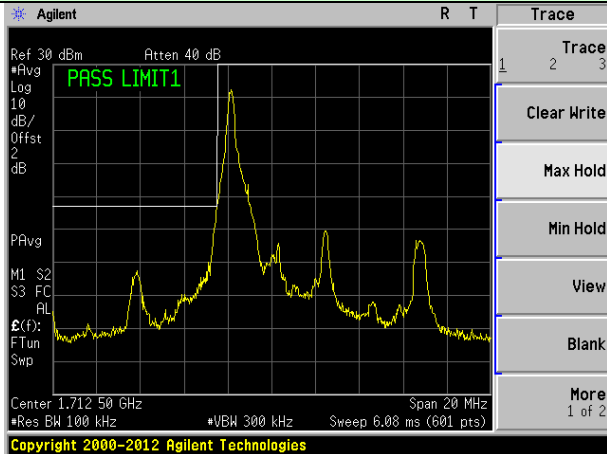

Lowest channel

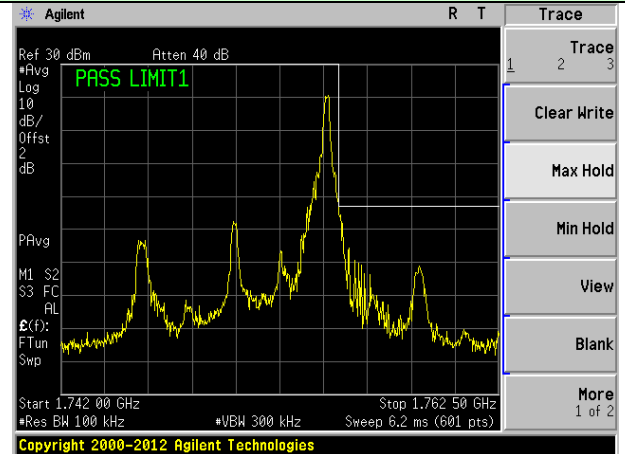

Highest channel

5MHz Bandwidth (RB size:12# RB offset:0#)      5MHz Bandwidth (RB size:12# RB offset:13#)

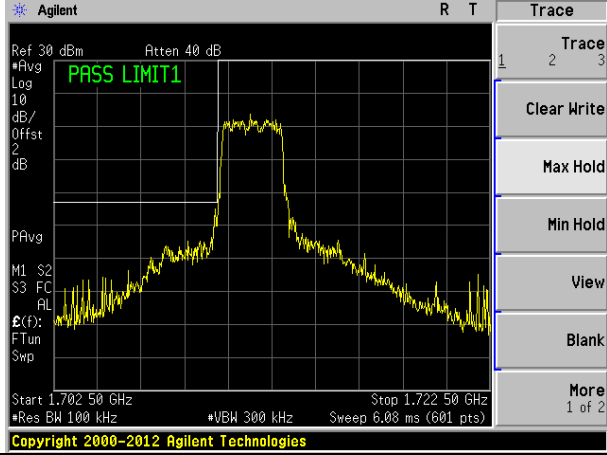

Lowest channel

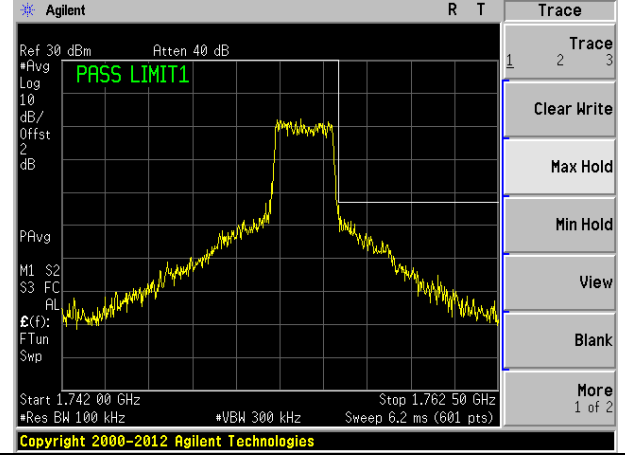

Highest channel

5MHz Bandwidth (RB size:25# RB offset:0#)      5MHz Bandwidth (RB size:25# RB offset:0#)

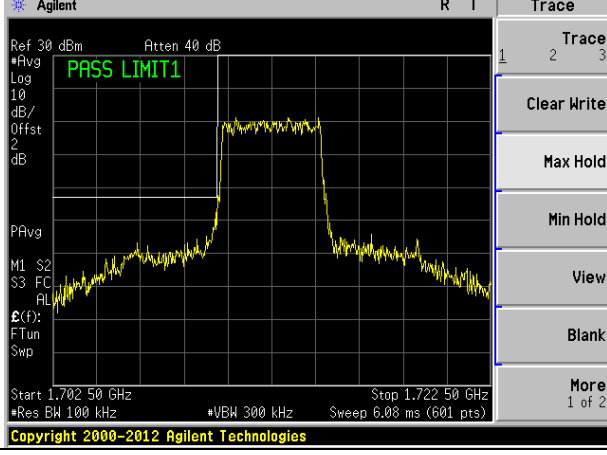

Lowest channel

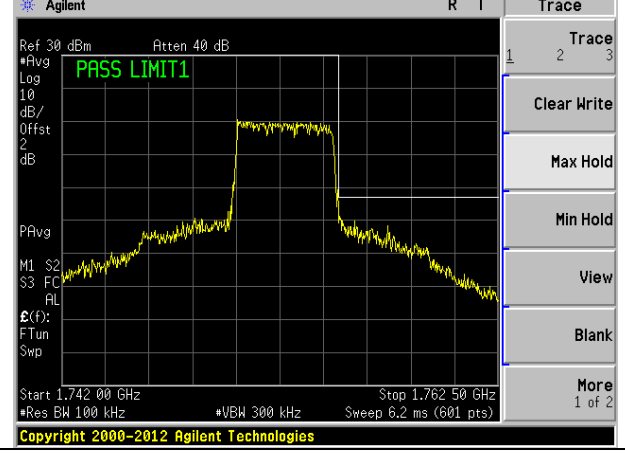

Highest channel

10MHz Bandwidth (RB size:1# RB offset:0#)      10MHz Bandwidth (RB size:1# RB offset:49#)

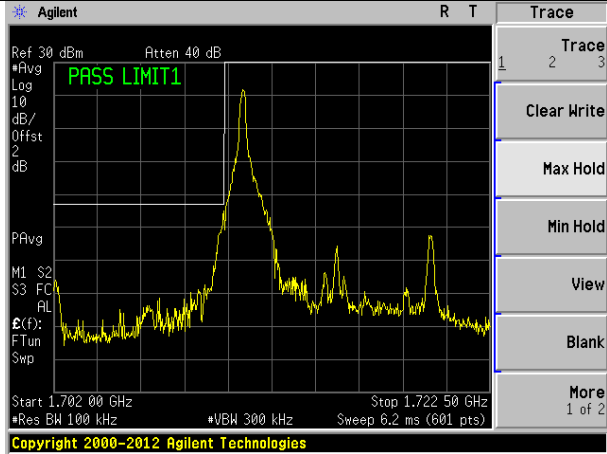

Lowest channel

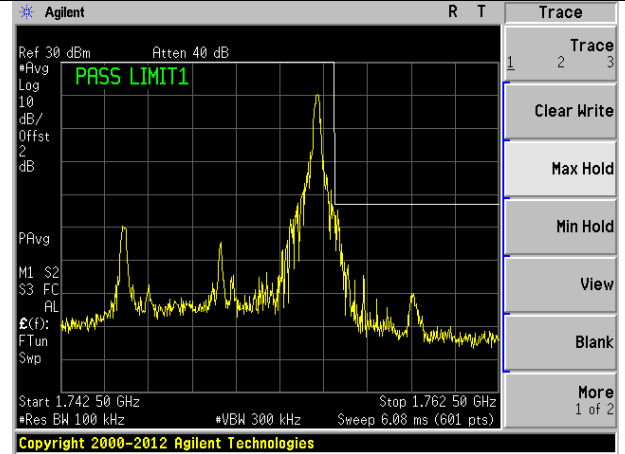

Highest channel

10MHz Bandwidth (RB size:25# RB offset:0#)      10MHz Bandwidth (RB size:25# RB offset:25#)

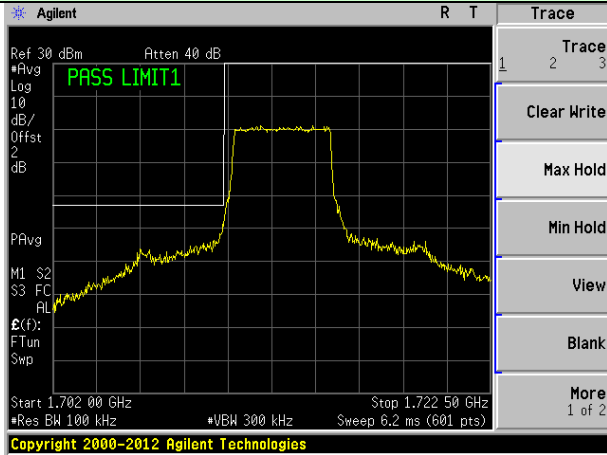

Lowest channel

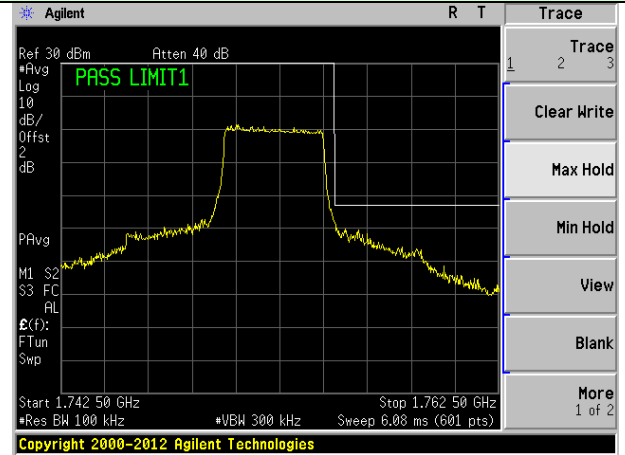

Highest channel

10MHz Bandwidth (RB size:50# RB offset:0#)      10MHz Bandwidth (RB size:50# RB offset:0#)

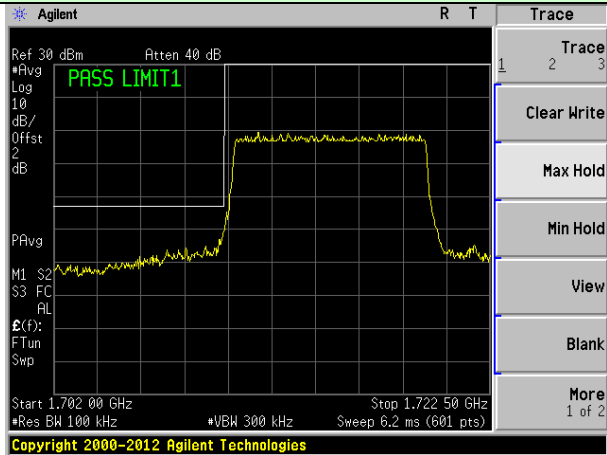

Lowest channel

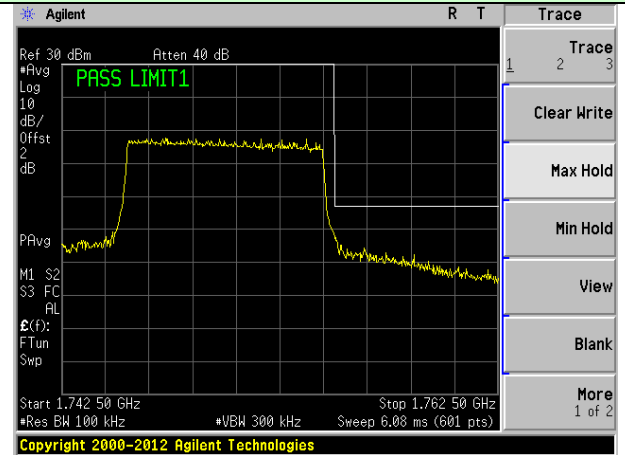

Highest channel

15MHz Bandwidth (RB size:1# RB offset:0#)      15MHz Bandwidth (RB size:1# RB offset:74#)

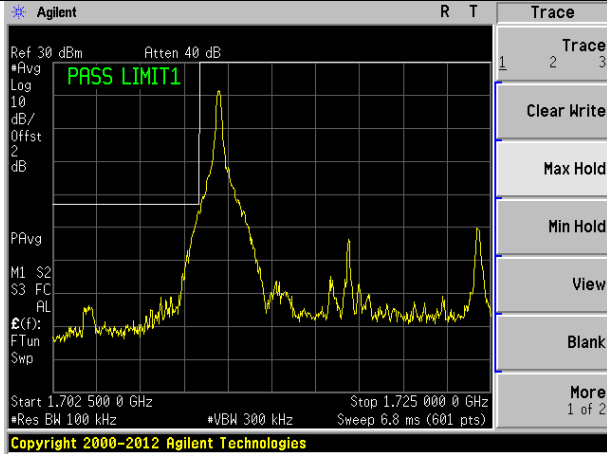

Lowest channel

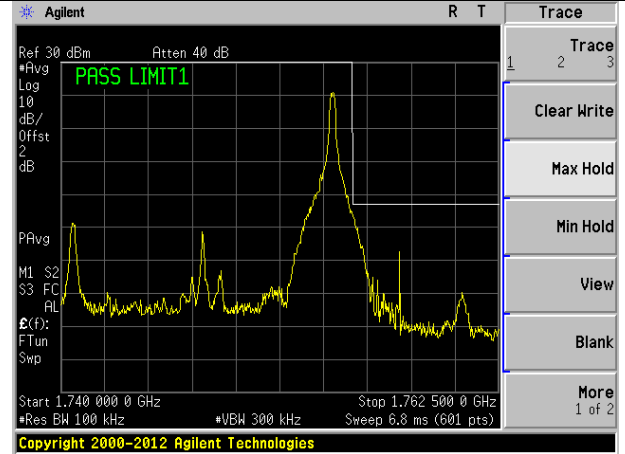

Highest channel

15MHz Bandwidth (RB size:36# RB offset:0#)      15MHz Bandwidth (RB size:36# RB offset:39#)

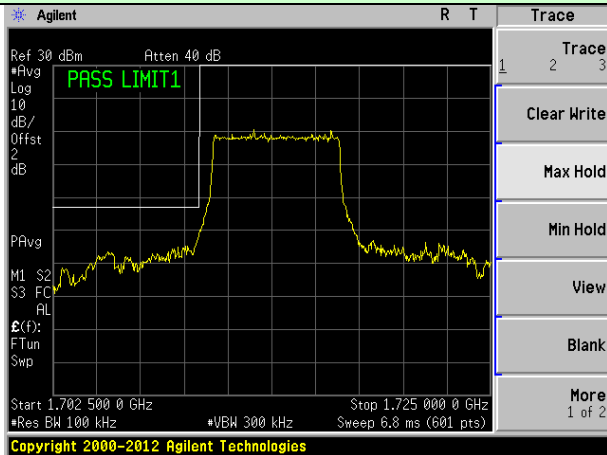

Lowest channel

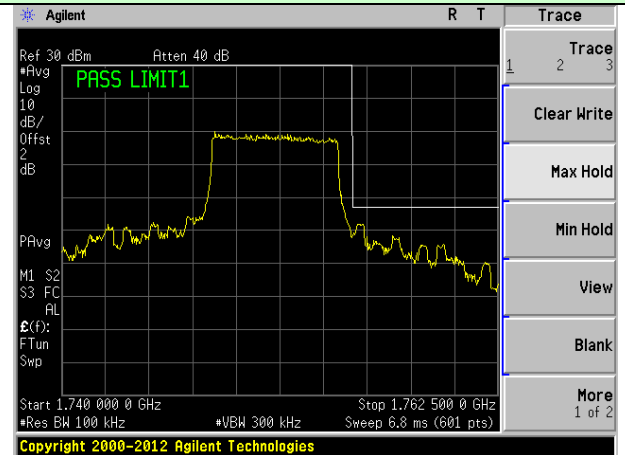

Highest channel

15MHz Bandwidth (RB size:75# RB offset:0#)      15MHz Bandwidth (RB size:75# RB offset:0#)

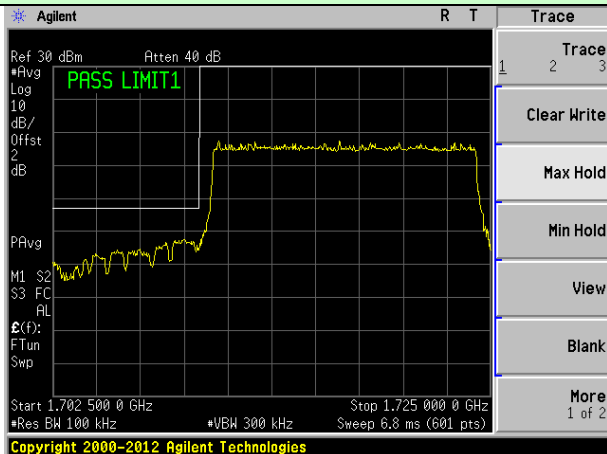

Lowest channel

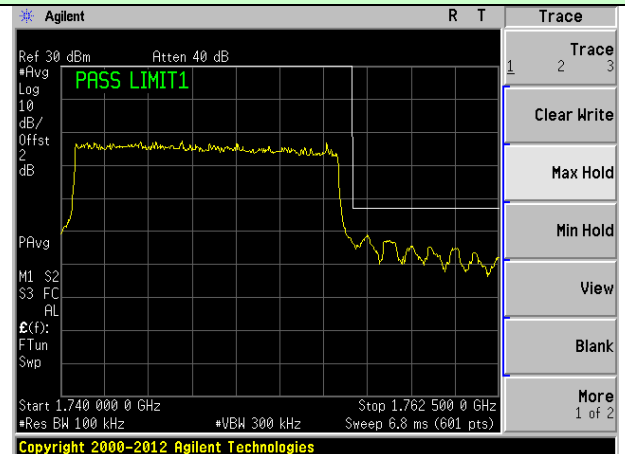

Highest channel

20MHz Bandwidth (RB size:1# RB offset:0#)      20MHz Bandwidth (RB size:1# RB offset:99#)

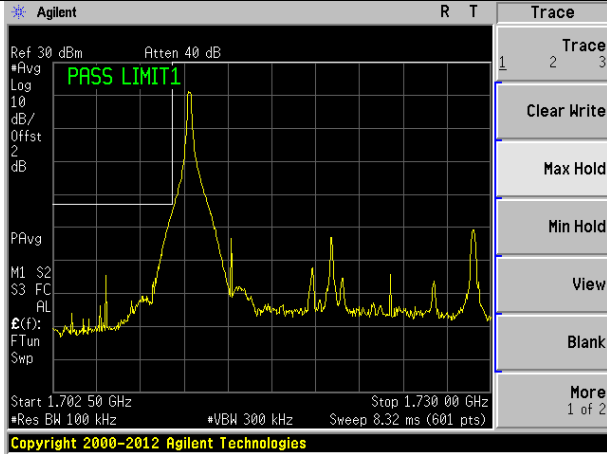

Lowest channel

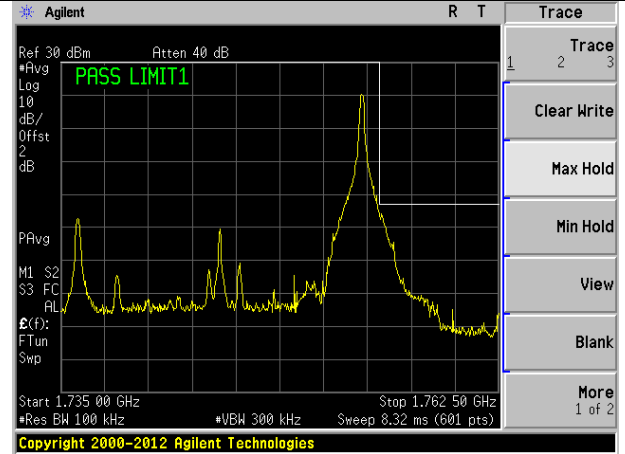

Highest channel

20MHz Bandwidth (RB size:50# RB offset:0#)      20MHz Bandwidth (RB size:50# RB offset:50#)

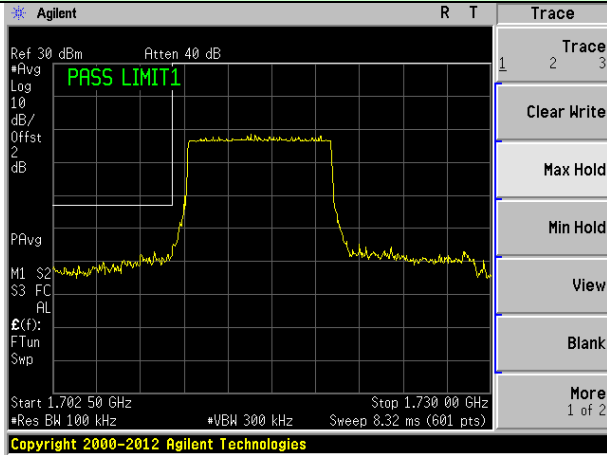

Lowest channel

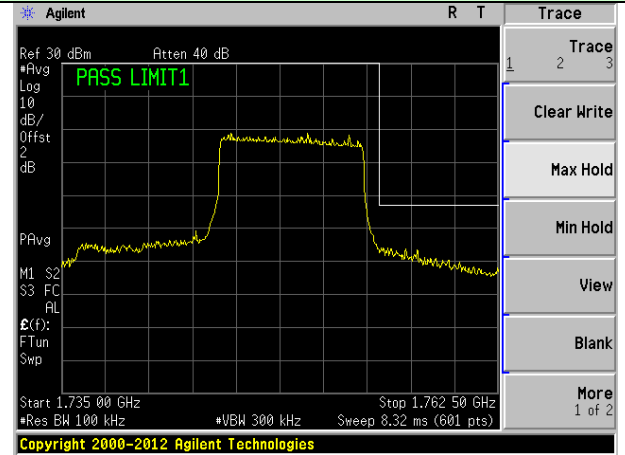

Highest channel

20MHz Bandwidth (RB size:100# RB offset:0#)      20MHz Bandwidth (RB size:100# RB offset:0#)

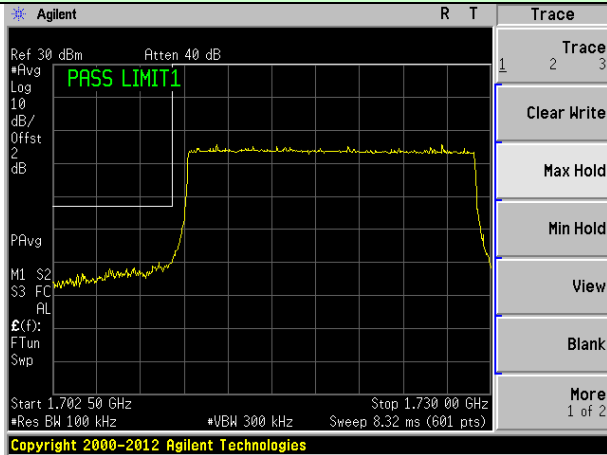

Lowest channel

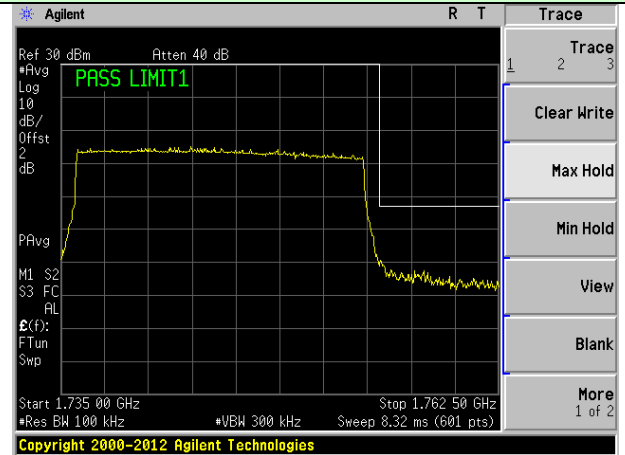

Highest channel

LTE Band 4 (16QAM mode):

1.4MHz Bandwidth (RB size:1# RB offset:0#)      1.4MHz Bandwidth (RB size:1# RB offset:5#)

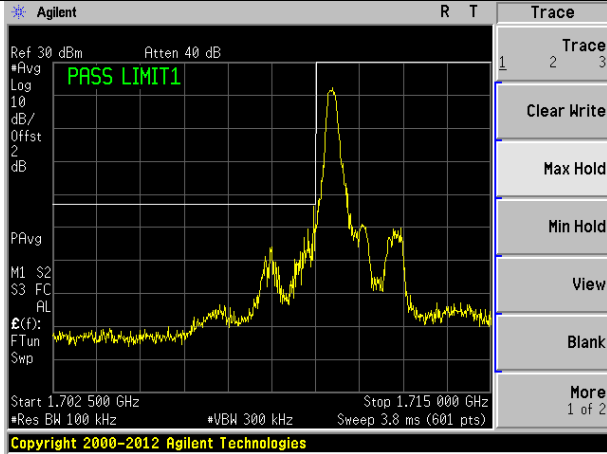

Lowest channel

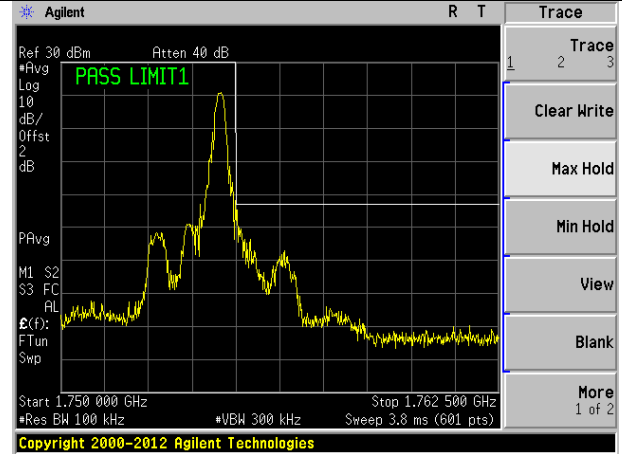

Highest channel

1.4MHz Bandwidth (RB size:3# RB offset:0#)      1.4MHz Bandwidth (RB size:3# RB offset:2#)

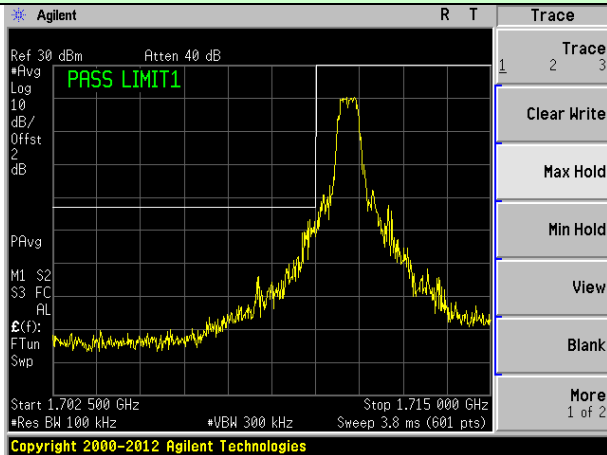

Lowest channel

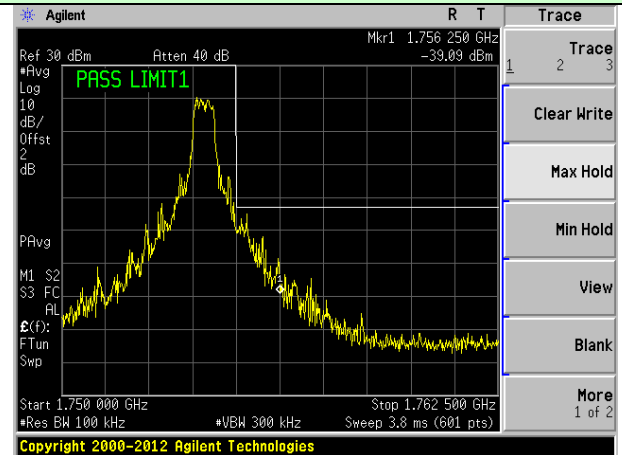

Highest channel

1.4MHz Bandwidth (RB size:6# RB offset:0#)      1.4MHz Bandwidth (RB size:6# RB offset:0#)

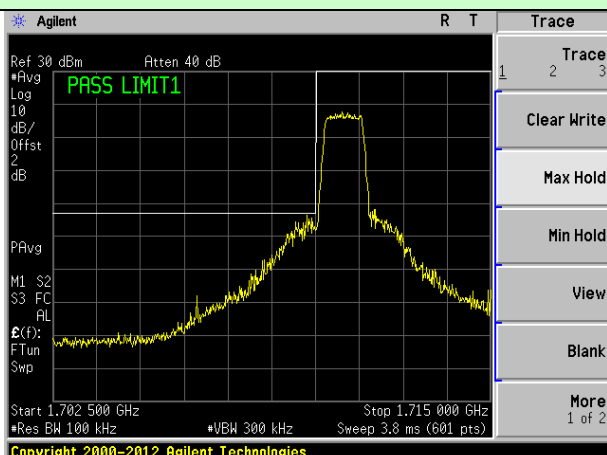

Lowest channel

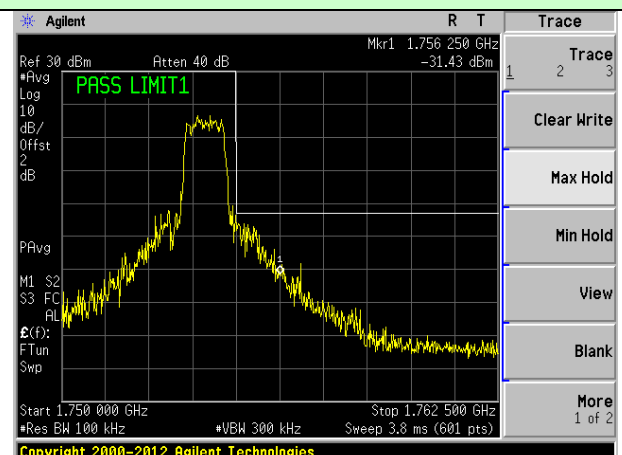

Highest channel

**3MHz Bandwidth (RB size:1# RB offset:0#)**      **3MHz Bandwidth (RB size:1# RB offset:14#)**



Lowest channel

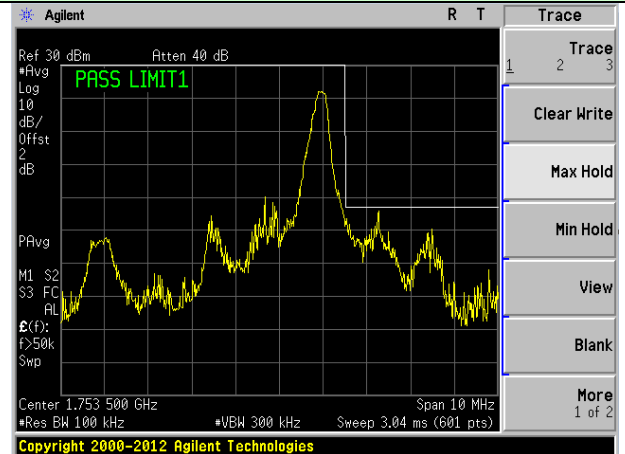

Highest channel

**3MHz Bandwidth (RB size:8# RB offset:0#)**      **3MHz Bandwidth (RB size:8# RB offset:7#)**

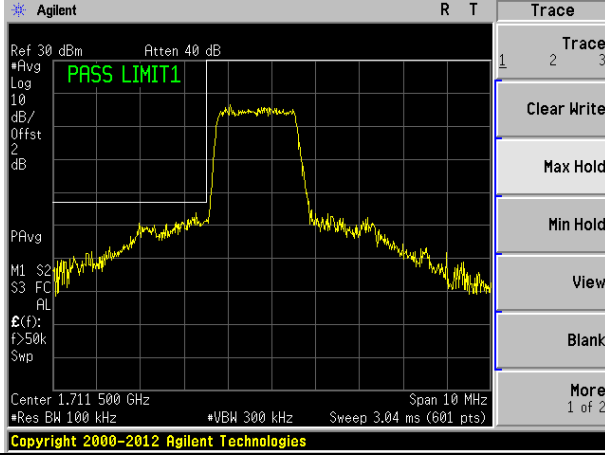

Lowest channel

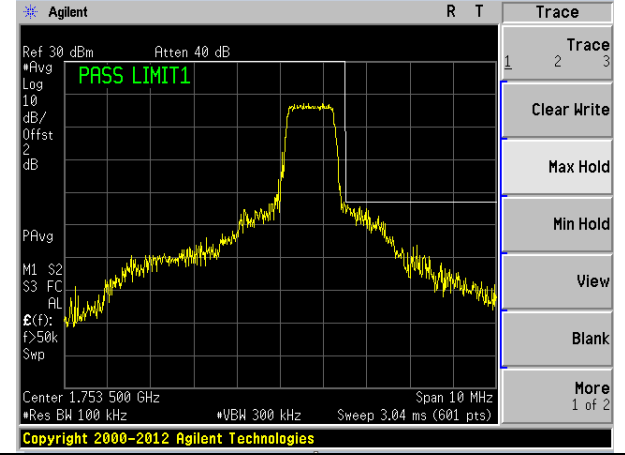

Highest channel

**3MHz Bandwidth (RB size:15# RB offset:0#)**      **3MHz Bandwidth (RB size:15# RB offset:0#)**

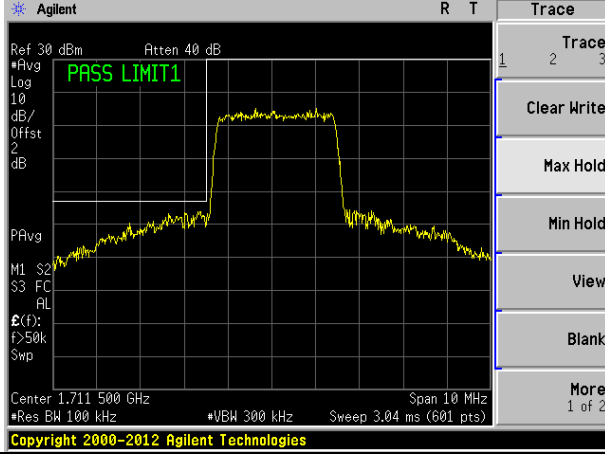

Lowest channel

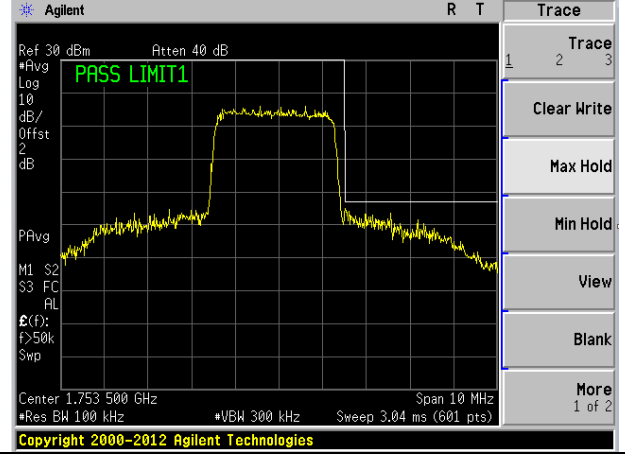

Highest channel

5MHz Bandwidth (RB size:1# RB offset:0#)      5MHz Bandwidth (RB size:1# RB offset:24#)

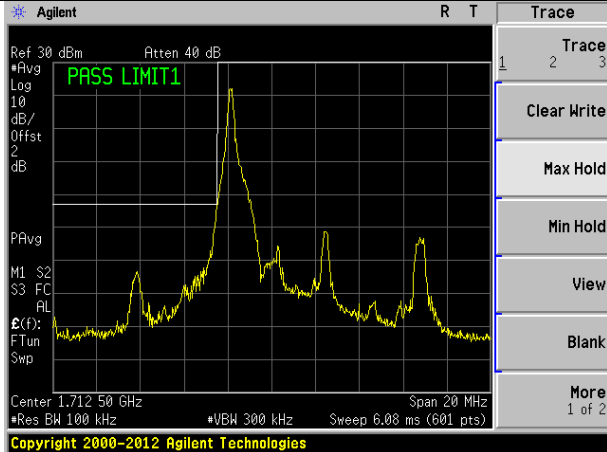

Lowest channel

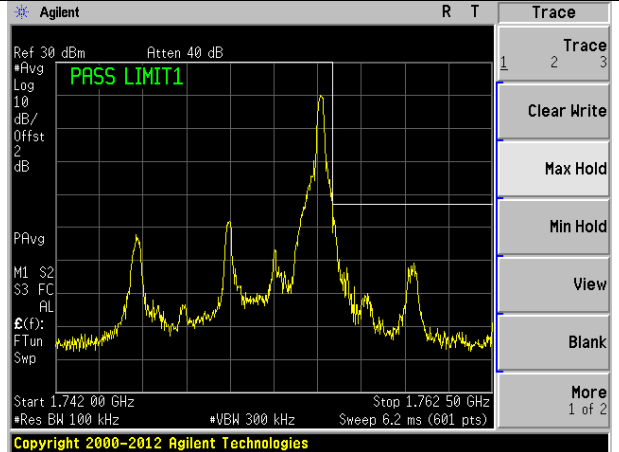

Highest channel

5MHz Bandwidth (RB size:12# RB offset:0#)      5MHz Bandwidth (RB size:12# RB offset:13#)

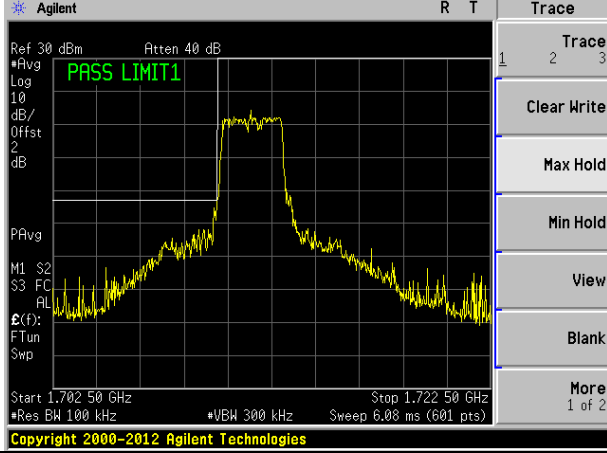

Lowest channel

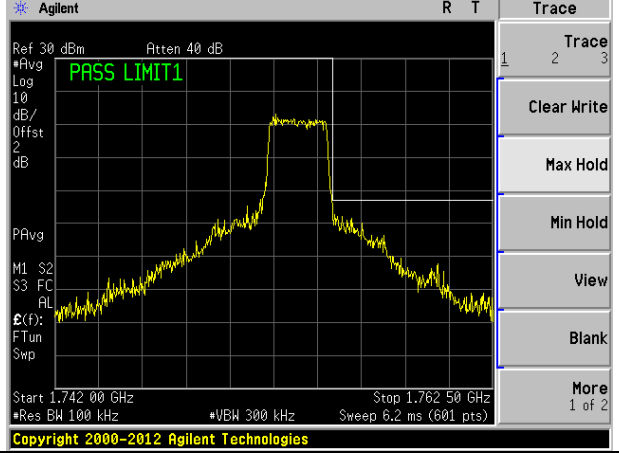

Highest channel

5MHz Bandwidth (RB size:25# RB offset:0#)      5MHz Bandwidth (RB size:25# RB offset:0#)

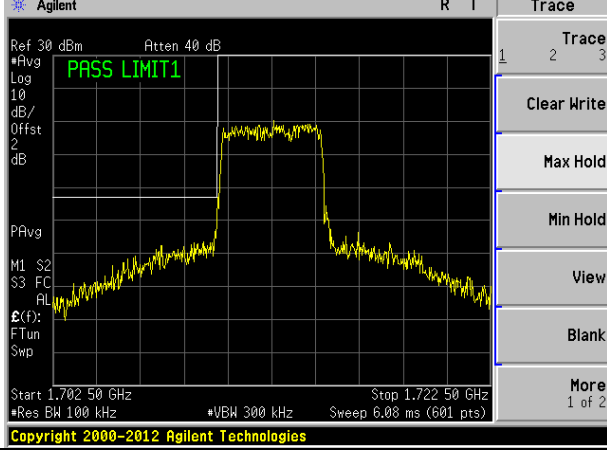

Lowest channel

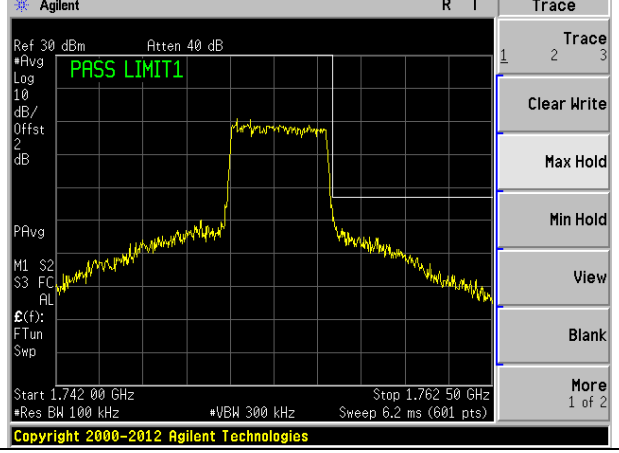

Highest channel



10MHz Bandwidth (RB size:1# RB offset:0#)      10MHz Bandwidth (RB size:1# RB offset:49#)

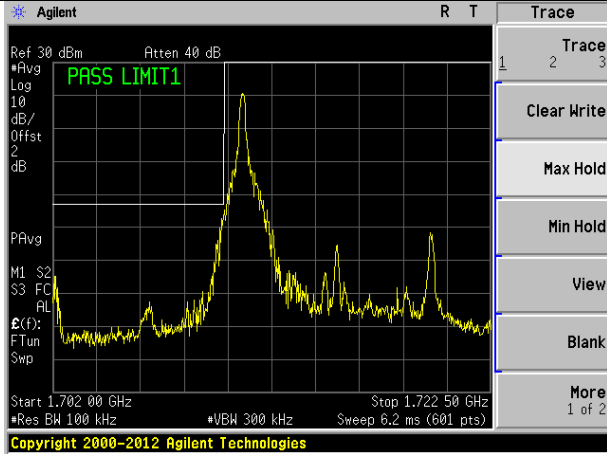

Lowest channel

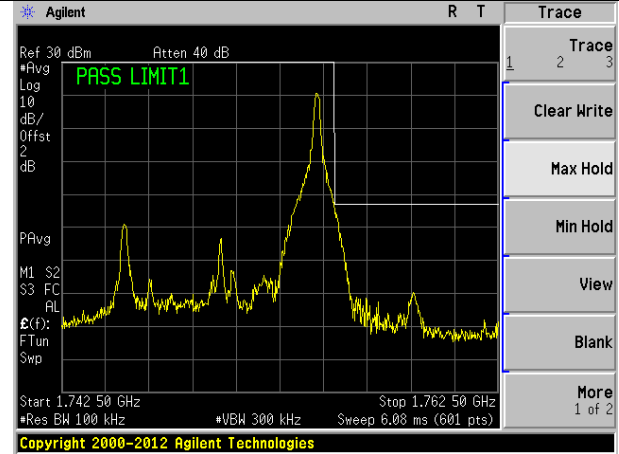

Highest channel

10MHz Bandwidth (RB size:25# RB offset:0#)      10MHz Bandwidth (RB size:25# RB offset:25#)

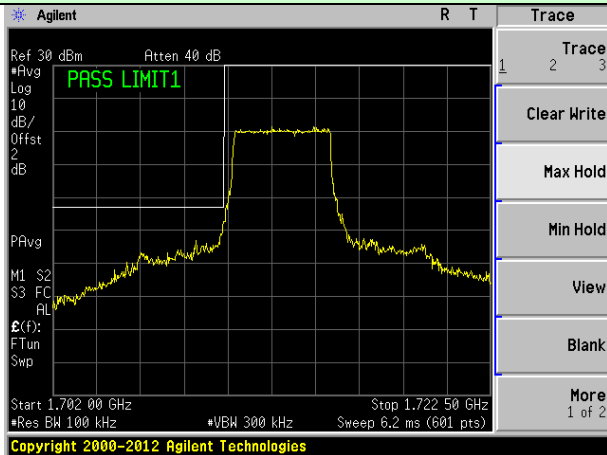

Lowest channel

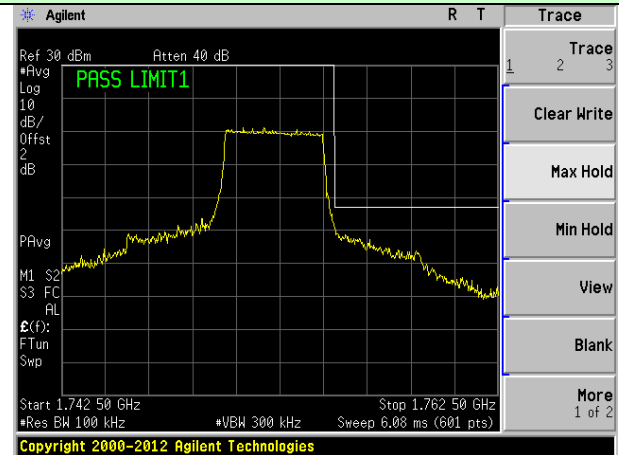

Highest channel

10MHz Bandwidth (RB size:50# RB offset:0#)      10MHz Bandwidth (RB size:50# RB offset:0#)

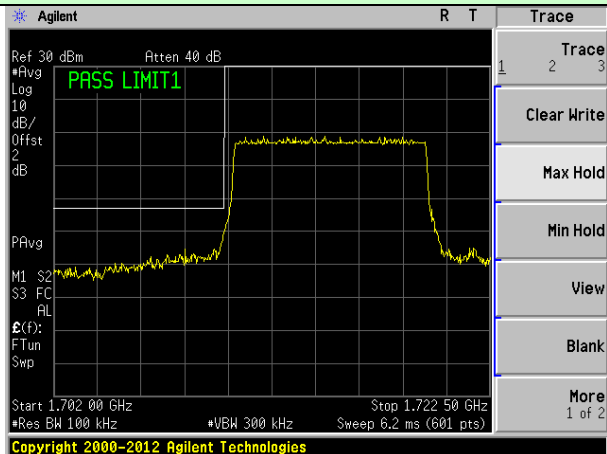

Lowest channel

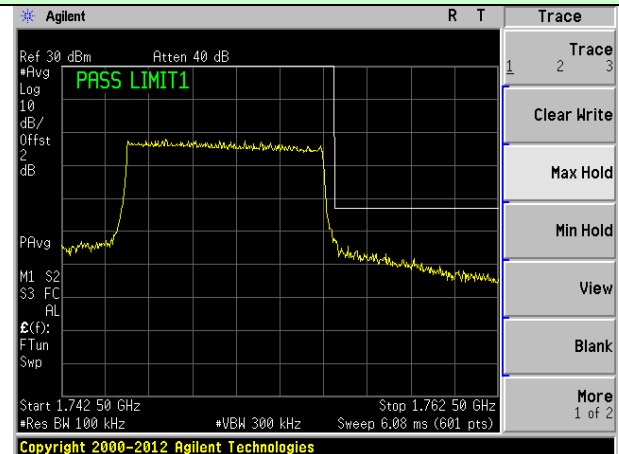

Highest channel

15MHz Bandwidth (RB size:1# RB offset:0#)      15MHz Bandwidth (RB size:1# RB offset:74#)

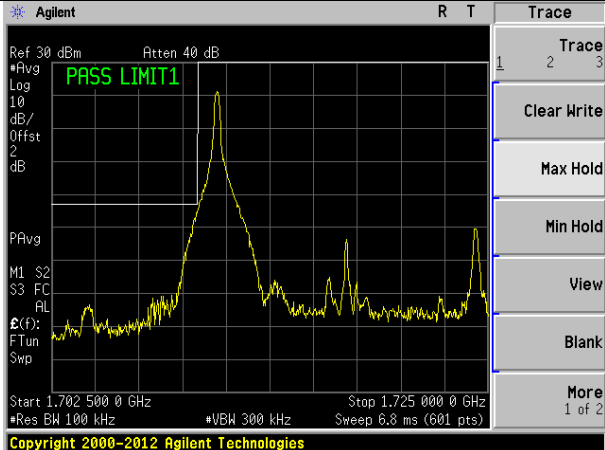

Lowest channel

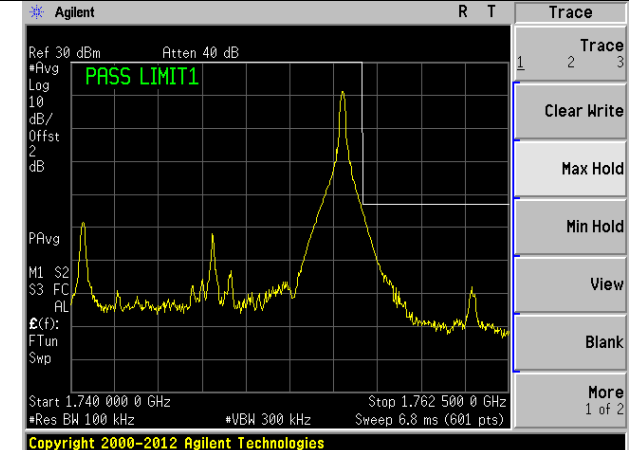

Highest channel

15MHz Bandwidth (RB size:36# RB offset:0#)      15MHz Bandwidth (RB size:36# RB offset:39#)

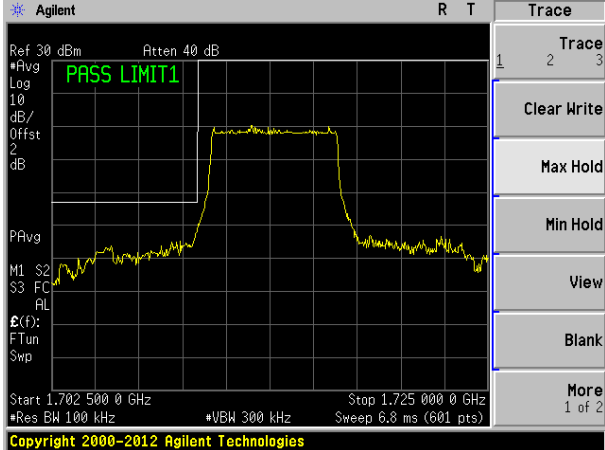

Lowest channel

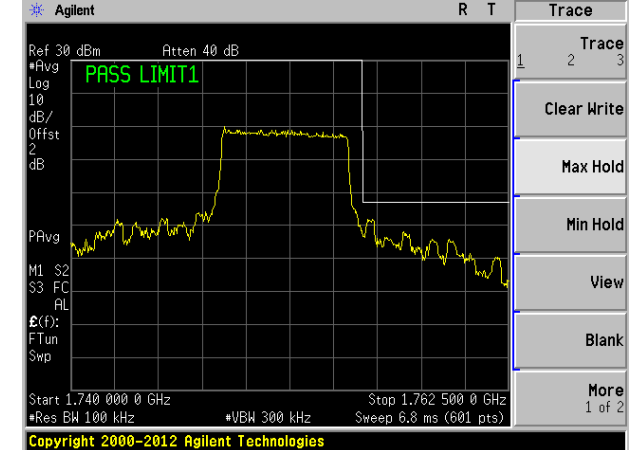

Highest channel

15MHz Bandwidth (RB size:75# RB offset:0#)      15MHz Bandwidth (RB size:75# RB offset:0#)

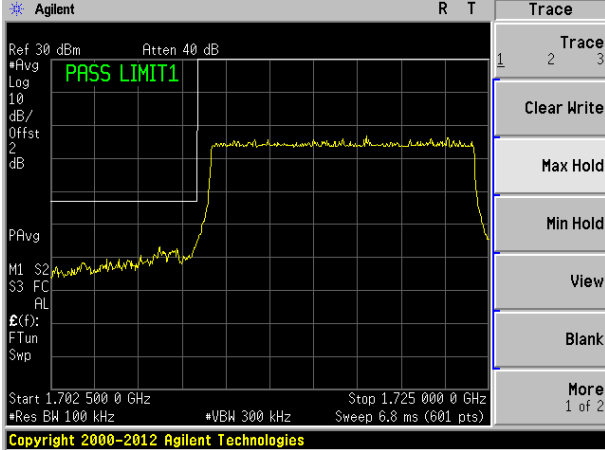

Lowest channel

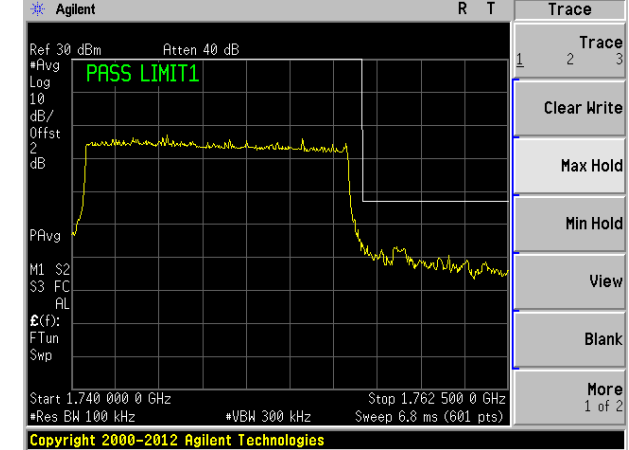

Highest channel

20MHz Bandwidth (RB size:1# RB offset:0#)      20MHz Bandwidth (RB size:1# RB offset:99#)

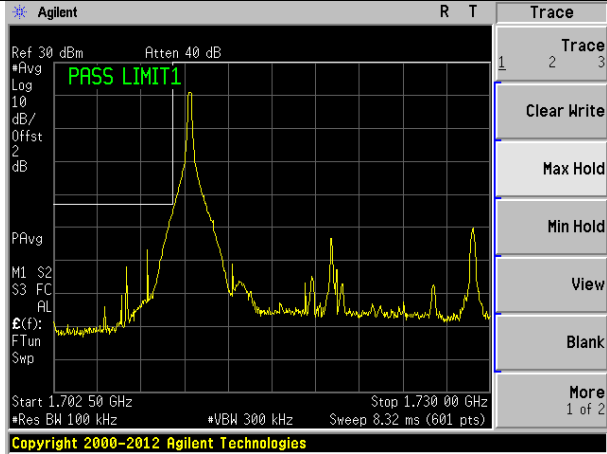

Lowest channel

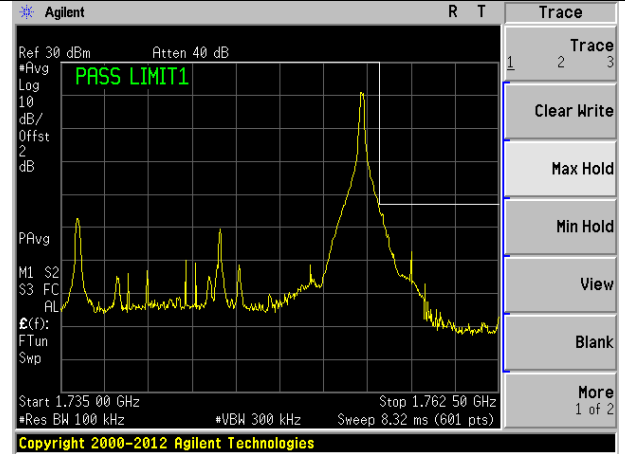

Highest channel

20MHz Bandwidth (RB size:50# RB offset:0#)      20MHz Bandwidth (RB size:50# RB offset:50#)

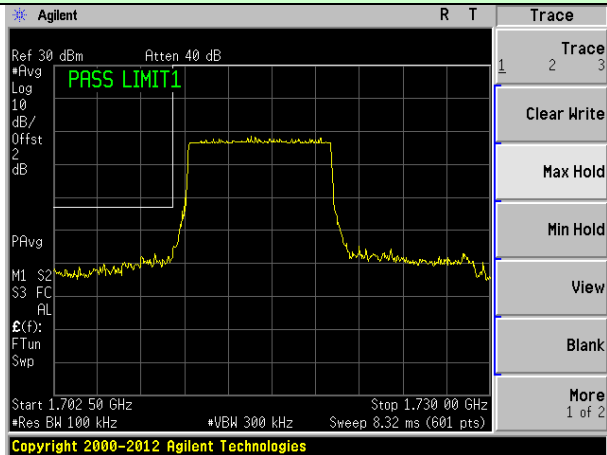

Lowest channel

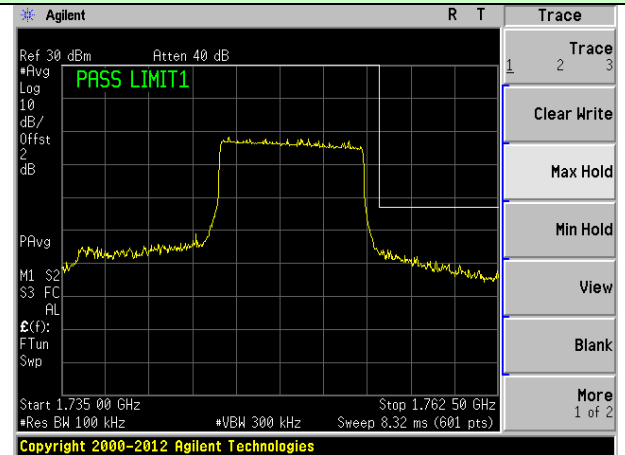

Highest channel

20MHz Bandwidth (RB size:100# RB offset:0#)      20MHz Bandwidth (RB size:100# RB offset:0#)

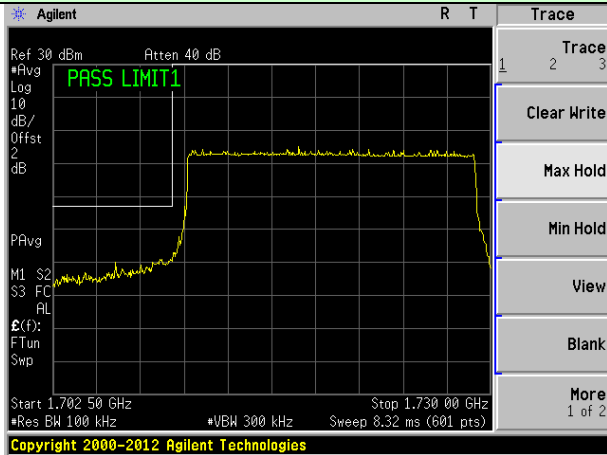

Lowest channel

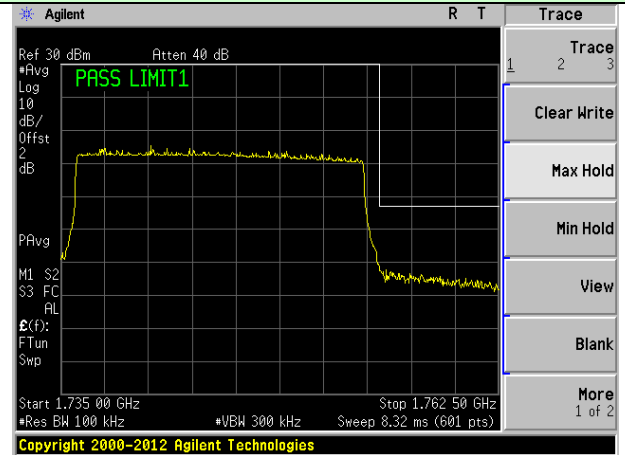

Highest channel

## 7.8 Field strength of spurious radiation measurement

Test Requirement for FCC:	Part 24.238 (a); FCC Part 27.53(h)/(g)					
Limit:	-13dBm					
Test setup:	Below 1GHz					
	Above 1GHz					
Substituted method:						
Test environment:	Temp.:	25 °C	Humid.:	52%	Press.:	1 012mbar
Test Instruments:	Refer to section 5.0 for details					
Test mode:	Refer to section 6.1 for details					
Test results:	Pass					

Measurement Data

Remark:

1. The emission behavior belongs to narrowband spurious emission.
2. The emission levels of below 1 GHz are very lower than the limit and not show in test report.

QPSK mode:

Test mode:	LTE Band 4(5MHz)		Test channel:	Lowest
Frequency (MHz)	Spurious Emission		Limit (dBm)	Result
	Polarization	Level (dBm)		
3425.00	Vertical	-42.79	-13.00	Pass
5137.50	V	-44.49		
6850.00	V	-41.71		
8562.50	V	-43.86		
10275.00	V	-43.01		
3425.00	Horizontal	-41.97	-13.00	Pass
5137.50	H	-45.78		
6850.00	H	-45.32		
8562.50	H	-45.00		
10275.00	H	-44.47		
Test mode:	LTE Band 4(5MHz)		Test channel:	Middle
Frequency (MHz)	Spurious Emission		Limit (dBm)	Result
	Polarization	Level (dBm)		
3465.00	Vertical	-43.91	-13.00	Pass
5197.50	V	-42.16		
6930.00	V	-42.02		
8662.50	V	-43.82		
10395.00	V	-45.22		
3465.00	Horizontal	-42.24	-13.00	Pass
5197.50	H	-45.42		
6930.00	H	-44.71		
8662.50	H	-45.95		
10395.00	H	-43.38		
Test mode:	LTE Band 4(5MHz)		Test channel:	Highest
Frequency (MHz)	Spurious Emission		Limit (dBm)	Result
	Polarization	Level (dBm)		
3505.00	Vertical	-42.95	-13.00	Pass
5257.50	V	-43.96		
7010.00	V	-44.61		
8762.50	V	-43.22		
10515.00	V	-43.56		
3505.00	Horizontal	-41.81	-13.00	Pass
5257.50	H	-44.65		
7010.00	H	-45.80		
8762.50	H	-47.80		
10515.00	H	-44.75		

Test mode:		LTE Band 4(20MHz)		Test channel:	Lowest
Frequency (MHz)	Spurious Emission		Limit (dBm)	Result	
	Polarization	Level (dBm)			
3440.00	Vertical	-43.36	-13.00	Pass	
5160.00	V	-44.77			
6880.00	V	-43.77			
8600.00	V	-41.68			
10320.00	V	-40.74			
3440.00	Horizontal	-41.98	-13.00	Pass	
5160.00	H	-43.40			
6880.00	H	-44.78			
8600.00	H	-43.19			
10320.00	H	-41.02			
Test mode:		LTE Band 4(20MHz)		Test channel:	Middle
Frequency (MHz)	Spurious Emission		Limit (dBm)	Result	
	Polarization	Level (dBm)			
3465.00	Vertical	-43.31	-13.00	Pass	
5197.50	V	-44.79			
6930.00	V	-42.84			
8662.50	V	-43.82			
10395.00	V	-39.73			
3465.00	Horizontal	-44.07	-13.00	Pass	
5197.50	H	-42.58			
6930.00	H	-44.01			
8662.50	H	-42.49			
10395.00	H	-40.84			
Test mode:		LTE Band 4(20MHz)		Test channel:	Highest
Frequency (MHz)	Spurious Emission		Limit (dBm)	Result	
	Polarization	Level (dBm)			
3490.00	Vertical	-42.35	-13.00	Pass	
5235.00	V	-43.76			
6980.00	V	-44.76			
8725.00	V	-42.67			
10470.00	V	-39.45			
3490.00	Horizontal	-40.97	-13.00	Pass	
5235.00	H	-44.39			
6980.00	H	-42.77			
8725.00	H	-43.18			
10470.00	H	-40.25			

16QAM mode:

Test mode:	LTE Band 4(5MHz)		Test channel:	Lowest
Frequency (MHz)	Spurious Emission		Limit (dBm)	Result
	Polarization	Level (dBm)		
3425.00	Vertical	-43.91	-13.00	Pass
5137.50	V	-40.68		
6850.00	V	-42.96		
8562.50	V	-45.15		
10275.00	V	-41.68		
3425.00	Horizontal	-43.21	-13.00	Pass
5137.50	H	-47.12		
6850.00	H	-44.71		
8562.50	H	-44.47		
10275.00	H	-41.18		
Test mode:	LTE Band 4(5MHz)		Test channel:	Middle
Frequency (MHz)	Spurious Emission		Limit (dBm)	Result
	Polarization	Level (dBm)		
3465.00	Vertical	-42.80	-13.00	Pass
5197.50	V	-41.76		
6930.00	V	-44.20		
8662.50	V	-43.54		
10395.00	V	-41.44		
3465.00	Horizontal	-44.47	-13.00	Pass
5197.50	H	-46.65		
6930.00	H	-44.35		
8662.50	H	-43.30		
10395.00	H	-41.36		
Test mode:	LTE Band 4(5MHz)		Test channel:	Highest
Frequency (MHz)	Spurious Emission		Limit (dBm)	Result
	Polarization	Level (dBm)		
3505.00	Vertical	-43.22	-13.00	Pass
5257.50	V	-42.33		
7010.00	V	-43.90		
8762.50	V	-42.36		
10515.00	V	-39.87		
3505.00	Horizontal	-44.18	-13.00	Pass
5257.50	H	-44.57		
7010.00	H	-44.86		
8762.50	H	-43.34		
10515.00	H	-40.94		

Test mode:		LTE Band 4(20MHz)		Test channel:	Lowest
Frequency (MHz)	Spurious Emission		Limit (dBm)	Result	
	Polarization	Level (dBm)			
3440.00	Vertical	-45.28	-13.00	Pass	
5160.00	V	-43.74			
6880.00	V	-42.40			
8600.00	V	-44.31			
10320.00	V	-42.97			
3440.00	Horizontal	-42.77	-13.00	Pass	
5160.00	H	-43.14			
6880.00	H	-44.54			
8600.00	H	-45.71			
10320.00	H	-43.45			
Test mode:		LTE Band 4(20MHz)		Test channel:	Middle
Frequency (MHz)	Spurious Emission		Limit (dBm)	Result	
	Polarization	Level (dBm)			
3465.00	Vertical	-43.86	-13.00	Pass	
5197.50	V	-46.19			
6930.00	V	-43.84			
8662.50	V	-43.32			
10395.00	V	-41.67			
3465.00	Horizontal	-45.36	-13.00	Pass	
5197.50	H	-43.30			
6930.00	H	-44.87			
8662.50	H	-43.11			
10395.00	H	-42.09			
Test mode:		LTE Band 4(20MHz)		Test channel:	Highest
Frequency (MHz)	Spurious Emission		Limit (dBm)	Result	
	Polarization	Level (dBm)			
3490.00	Vertical	-44.93	-13.00	Pass	
5235.00	V	-43.69			
6980.00	V	-43.45			
8725.00	V	-42.99			
10470.00	V	-42.21			
3490.00	Horizontal	-43.77	-13.00	Pass	
5235.00	H	-42.49			
6980.00	H	-47.92			
8725.00	H	-45.57			
10470.00	H	-43.22			

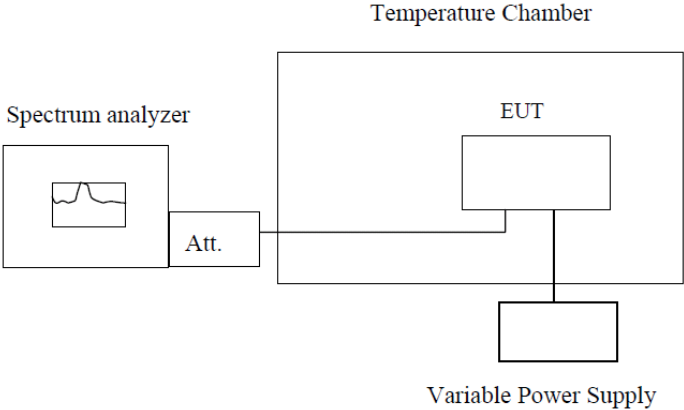

## 7.9 Frequency stability V.S. Temperature measurement

Test Requirement for FCC:	FCC Part2.1055(a)(1)(b)
Limit:	2.5ppm
Test setup:	 <p style="text-align: center;">Temperature Chamber</p> <p style="text-align: center;">Spectrum analyzer</p> <p style="text-align: center;">Att.</p> <p style="text-align: center;">EUT</p> <p style="text-align: center;">Variable Power Supply</p> <p><b>Note :</b> Measurement setup for testing on Antenna connector</p>
Test procedure:	<ol style="list-style-type: none"> <li>1. The equipment under test was connected to an external DC power supply and input rated voltage.</li> <li>2. RF output was connected to a frequency counter or spectrum analyzer via feed through attenuators.</li> <li>3. The EUT was placed inside the temperature chamber.</li> <li>4. Set the spectrum analyzer RBW low enough to obtain the desired frequency resolution and measure EUT 25°C operating frequency as reference frequency.</li> <li>5. Turn EUT off and set the chamber temperature to -20°C. After the temperature stabilized for approximately 30 minutes recorded the frequency.</li> <li>6. Repeat step measure with 10°C increased per stage until the highest temperature of +50°C reached.</li> </ol>
Test Instruments:	Refer to section 5.0 for details
Test mode:	Refer to section 6.1 for details
Test results:	Pass

Measurement Data

QPSK mode:

Reference Frequency: LTE Band 4 Middle channel=20175 channel=1732.5MHz					
Power supplied (Vdc)	Temperature (°C)	Frequency error		Limit (ppm)	Result
		Hz	ppm		
3.7	-30	113	0.0603	2.5	Pass
	-20	128	0.0683		
	-10	108	0.0577		
	0	88	0.0470		
	10	103	0.0550		
	20	88	0.0470		
	30	148	0.0789		
	40	133	0.0710		
	50	128	0.0683		

16QAM mode:

Reference Frequency: LTE Band 4 Middle channel=20175 channel=1732.5MHz					
Power supplied (Vdc)	Temperature (°C)	Frequency error		Limit (ppm)	Result
		Hz	ppm		
3.7	-30	93	0.0537	2.5	Pass
	-20	103	0.0595		
	-10	88	0.0508		
	0	78	0.0450		
	10	83	0.0479		
	20	73	0.0421		
	30	128	0.0739		
	40	108	0.0623		
	50	103	0.0595		

## 7.10 Frequency stability V.S. Voltage measurement

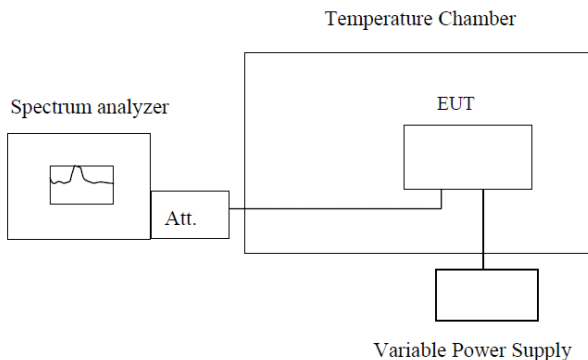
Test Requirement for FCC:	FCC Part2.1055(d)(1)(2)
Limit:	2.5ppm
Test setup:	 <p style="text-align: center;">Temperature Chamber</p> <p style="text-align: center;">Spectrum analyzer      Att.      EUT</p> <p style="text-align: center;">Variable Power Supply</p> <p><b>Note :</b> Measurement setup for testing on Antenna connector</p>
Test procedure:	<ol style="list-style-type: none"> <li>1. Set chamber temperature to 25°C. Use a variable DC power source to power the EUT and set the voltage to rated voltage.</li> <li>2. Set the spectrum analyzer RBW low enough to obtain the desired frequency resolution and recorded the frequency.</li> <li>3. Reduce the input voltage to specified extreme voltage variation (+/- 15%) and endpoint, record the maximum frequency change.</li> </ol>
Test Instruments:	Refer to section 5.0 for details
Test mode:	Refer to section 6.1 for details
Test results:	Pass

Measurement Data

QPSK mode:

Reference Frequency: LTE Band 4 Middle channel=20175 channel=1732.5MHz					
Temperature (°C)	Power supplied (Vc)	Frequency error		Limit (ppm)	Result
		Hz	ppm		
25	4.2	67	0.0356	2.5	Pass
	3.7	78	0.0413		
	3.3	88	0.0470		

16QAM mode:

Reference Frequency: LTE Band 4 Middle channel=20175 channel=1732.5MHz					
Temperature (°C)	Power supplied (Vdc)	Frequency error		Limit (ppm)	Result
		Hz	ppm		
25	4.2	103	0.0595	2.5	Pass
	3.7	75	0.0432		
	3.3	84	0.0486		

## **8 Test Setup Photo**

Reference to the **appendix I** for details.

## **9 EUT Constructional Details**

Reference to the **appendix II** for details.

-----End-----