

# TEST REPORT

of

## FCC Part 15 Subpart C

New Application;  Class I PC;  Class II PC

**Product :** ProDVX APPC-10SLBe  
**Brand:** ProDVX  
**Model:** APPC-10SLBe 10 inch Android Panel PC Impact  
**Model Difference:** N/A  
**FCC ID:** 2AR42APPC10SLBE  
**FCC Rule Part:** §15.247, Cat: DTS  
**Applicant:** ProDVX Europe B.V.  
**Address:** Europalaan 10, 5232 BC Den Bosch, The Netherlands

Test Performed by:

**International Standards Laboratory Corp. LT Lab.**



TEL: +886-3-263-8888 FAX: +886-3-263-8899

No. 120, Lane 180, Hsin Ho Rd., Lung-Tan Dist., Tao Yuan City 325, Taiwan

Report No.: ISL-22LR0167FC DTS  
Issue Date :2022/10/03



Test results given in this report apply only to the specific sample(s) tested and are traceable to national or international standard through calibration of the equipment and evaluating measurement uncertainty herein.

The uncertainty of the measurement does not include in consideration of the test result unless the customer required the determination of uncertainty via the agreement, regulation or standard document specification.

This test report shall not be reproduced except in full, without the written approval of International Standards Laboratory Corp.

## VERIFICATION OF COMPLIANCE

**Applicant:** ProDVX Europe B.V.  
**Product Description:** ProDVX APPC-10SLBe  
**Brand Name:** ProDVX  
**Model No.:** APPC-10SLBe 10 inch Android Panel PC Impact  
**Model Difference:** N/A  
**FCC ID:** 2AR42APPC10SLBE  
**Date of test:** 2022/09/12 ~ 2022/09/30  
**Date of EUT Received:** 2022/09/12

### We hereby certify that:

All the tests in this report have been performed and recorded in accordance with the standards described above and performed by an independent electromagnetic compatibility consultant, International Standards Laboratory Corp.

The test results contained in this report accurately represent the measurements of the characteristics and the energy generated by sample equipment under test at the time of the test. The sample equipment tested as described in this report is in compliance with the limits of above standards.

**Test By:**



**Date:**

2022/10/03

*Barry Lee / Senior Engineer*

**Prepared By:**



**Date:**

2022/10/03

*Gigi Yeh / Senior Engineer*

**Approved By:**

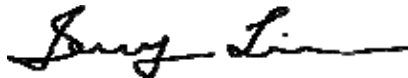

**Date:**

2022/10/03

*Jerry Liu / Assistant Manager*

## Version

Version No.	Date	Description
00	2022/10/03	Initial creation of document

## Uncertainty of Measurement

ISO/IEC 17025 requires that an estimate of measurement uncertainties associated with the emissions test results be included in the report. The measurement uncertainties given below are based on a 95% confidence level (based on a coverage factor (k=2)).

Parameter	Uncertainty (k=2)
Conducted Emission (AC power line)	±0.852 dB
Spurious emissions, radiated	±3.46 dB
RF power, conducted	±1.386 dB
Power Density	±1.432 dB
RF Frequency	±0.00298%
Time	±0.01%
DC Voltage	±0.808%

## Table of Contents

<b>1</b>	<b>General Information</b> .....	<b>6</b>
1.1	Related Submittal(s) / Grant (s) .....	8
1.2	Test Methodology .....	8
1.3	Test Facility.....	8
1.4	Special Accessories.....	8
1.5	Equipment Modifications.....	8
<b>2</b>	<b>System Test Configuration</b> .....	<b>9</b>
2.1	EUT Configuration .....	9
2.2	EUT Exercise .....	9
2.3	Test Procedure.....	9
2.4	Configuration of Tested System.....	10
<b>3</b>	<b>Summary of Test Results</b> .....	<b>12</b>
<b>4</b>	<b>Description of Test Modes</b> .....	<b>12</b>
<b>5</b>	<b>Conduced Emission Test</b> .....	<b>13</b>
5.1	Standard Applicable: .....	13
5.2	Measurement Equipment Used: .....	13
5.3	EUT Setup:.....	13
5.4	Measurement Procedure: .....	14
5.5	Measurement Result: .....	14
<b>6</b>	<b>Peak Output Power</b> .....	<b>17</b>
6.1	Standard Applicable: .....	17
6.2	Measurement Equipment Used: .....	18
6.3	Test Set-up: .....	19
6.4	Measurement Procedure: .....	19
6.5	Measurement Result: .....	20
<b>7</b>	<b>6dB Bandwidth</b> .....	<b>21</b>
7.1	Standard Applicable: .....	21
7.2	Measurement Equipment Used: .....	21
7.3	Test Set-up: .....	21
7.4	Measurement Procedure: .....	21
7.5	Measurement Result: .....	22
<b>8</b>	<b>Spurious Radiated Emission Test</b> .....	<b>31</b>
8.1	Standard Applicable .....	31
8.2	Measurement Equipment Used: .....	31
8.3	Test SET-UP:.....	32
8.4	Measurement Procedure: .....	33
8.5	Field Strength Calculation .....	34
8.6	Measurement Result: .....	34
<b>9.</b>	<b>100kHz Bandwidth of Band Edges Measurement</b> .....	<b>65</b>
9.1	Standard Applicable: .....	65
9.2	Measurement Equipment Used: .....	65
9.3	Test SET-UP:.....	67
9.4	Measurement Procedure: .....	68
9.5	Field Strength Calculation: .....	68
9.6	Measurement Result: .....	68
<b>10.</b>	<b>Peak Power Spectral Density</b> .....	<b>89</b>
10.1	Standard Applicable: .....	89
10.2	Measurement Equipment Used: .....	89
10.3	Test Set-up: .....	89
10.4	Measurement Procedure: .....	89



10.5 Measurement Result: .....90

**11. Antenna Requirement ..... 99**

11.1 Standard Applicable: .....99

11.2 Antenna Connected Construction: .....99

## 1 General Information

General:

General Information		
Product Name:	ProDVX APPC-10SLBe	
Brand Name:	ProDVX	
Model Name:	APPC-10SLBe 10 inch Android Panel PC Impact	
Model Difference:	N/A	
Temperature Range	0°C to 40°C	
Power Supply:	12V DC from adaptor	
	Adaptor:	Model:2AAJ024FC

WiFi Information		
WLAN Modular	AP6256	
Frequency Range:	WLAN 2.4GHz Band	
	802.11b/g	2412MHz ~ 2462MH
	802.11n(HT20)	2412MHz ~ 2462MH
	802.11n(HT40)	2412MHz ~ 2452MH
Max Output Power:	2412MHz ~ 2462MHz: 24.19dBm	
Channel number:	WLAN 2.4GHz Band	
	802.11b/g :	11ch
	802.11n(HT20) :	11ch
	802.11n(HT40) :	9ch
Product HW Version:	22080147	
Product SW Version:	11	
Product FW Version:	11	
Test SW Version:	Ampak RFTTestTool 7.3	
RF power setting:	Refer power table	

Bluetooth Information		
BT Modular:	AP6256	
Bluetooth Version:	V2.1 + EDR	V5.0
Frequency Range:	2402 – 2480MHz	2402 – 2480MHz
Max Output Power:	6.53dBm	7.13dBm
Channel number:	79 channels	40 channels
Modulation type:	FHSS	GFSK
Product HW Version:	22080147	
Product SW Version:	11	
Product FW Version:	11	
Test SW Version:	Ampak RFTTestTool 7.3	
RFpower setting:	default	

	Antenna Type	Brand	Model	Peak Gain	Frequency Range	Connector Type
1	PCB	TSKY CO., LTD.	A8-A006-00509	2.7dBi	2400-2485 MHz	i-pex

The EUT is compliance with IEEE 802.11 b/g/n Standard.  
This report applies for 2.4GHz Wifi + BLE.

**Remark:** The above DUT's information was declared by manufacturer. Please refer to the specifications or user's manual for more detailed description.

### 1.1 Related Submittal(s) / Grant (s)

This submittal(s) (test report) is intended for **FCC ID: 2AR42APPC10SLBE** filing to comply with Section 15.247 of the FCC Part 15, Subpart C Rules

### 1.2 Test Methodology

Both conducted and radiated testing were performed according to the procedures in ANSI C63.10: 2013. Radiated testing was performed at an antenna to EUT distance 3 meters.

KDB Document: 558074 D01 15.247 Meas Guidance v0.5r02

### 1.3 Test Facility

The measurement facilities used to collect the 3m Radiated Emission and AC power line conducted data are located on the address of International Standards Laboratory Corp. <LT Lab.> No. 120, Lane 180, Hsin Ho Rd., Lung-Tan Dist., Tao Yuan City 325, Taiwan which are constructed and calibrated to meet the FCC requirements in documents . FCC Registration Number is: 487532; Designation Number is: TW0997.

### 1.4 Special Accessories

Not available for this EUT intended for grant.

### 1.5 Equipment Modifications

Not available for this EUT intended for grant.



## **2 System Test Configuration**

### **2.1 EUT Configuration**

The EUT configuration for testing is installed on RF field strength measurement to meet the Commissions requirement and operating in a manner which intends to maximize its emission characteristics in a continuous normal application.

### **2.2 EUT Exercise**

The EUT (Transmitter) was operated in the engineering mode to fix the Tx frequency that was for the purpose of the measurements.

### **2.3 Test Procedure**

#### **2.3.1 Conducted Emissions**

The EUT is a placed on as turn table which is 0.8 m above ground plane. According to the requirements in Section 6 of ANSI C63.10: 2013. Con-ducted emissions from the EUT measured in the frequency range between 0.15 MHz and 30MHz using CISPR 16-1-1 Quasi-Peak and Average detector mode.

#### **2.3.2 Radiated Emissions**

The EUT is a placed on as turn table which is 0.8 m/1.5m (Frequency above 1GHz) above ground plane. The turn table shall rotate 360 degrees to determine the position of maxi-mum emission level. EUT is set 3m away from the receiving antenna which varied from 1m to 4m to find out the highest emission. And also, each emission was to be maximized by changing the polarization of receiving antenna both horizontal and vertical. In order to find out the max. emission, the relative positions of this hand-held transmitter(EUT) was rotated through three orthogonal axes according to the requirements in Section 6 and 11 of ANSI C63.10: 2013.

## 2.4 Configuration of Tested System

**Fig. 2-1 Configuration of Tested System (Fixed channel)**

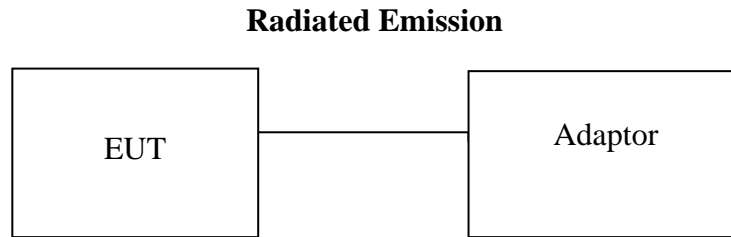

**Table 2-1 Equipment Used in Tested System**

Item	Equipment	Mfr/Brand	Model/ Type No.	Series No.	Data Cable	Power Cord
1	adaptor	CWT	2AAJ024FC	NA	NA	300cm

**Note:** All the above equipment/cables were placed in worse case positions to maximize emission signals during emission test.

**Grounding:** Grounding was in accordance with the manufacturer's requirements and conditions for the intended use.

**Fig. 2-2 Configuration of Tested System**

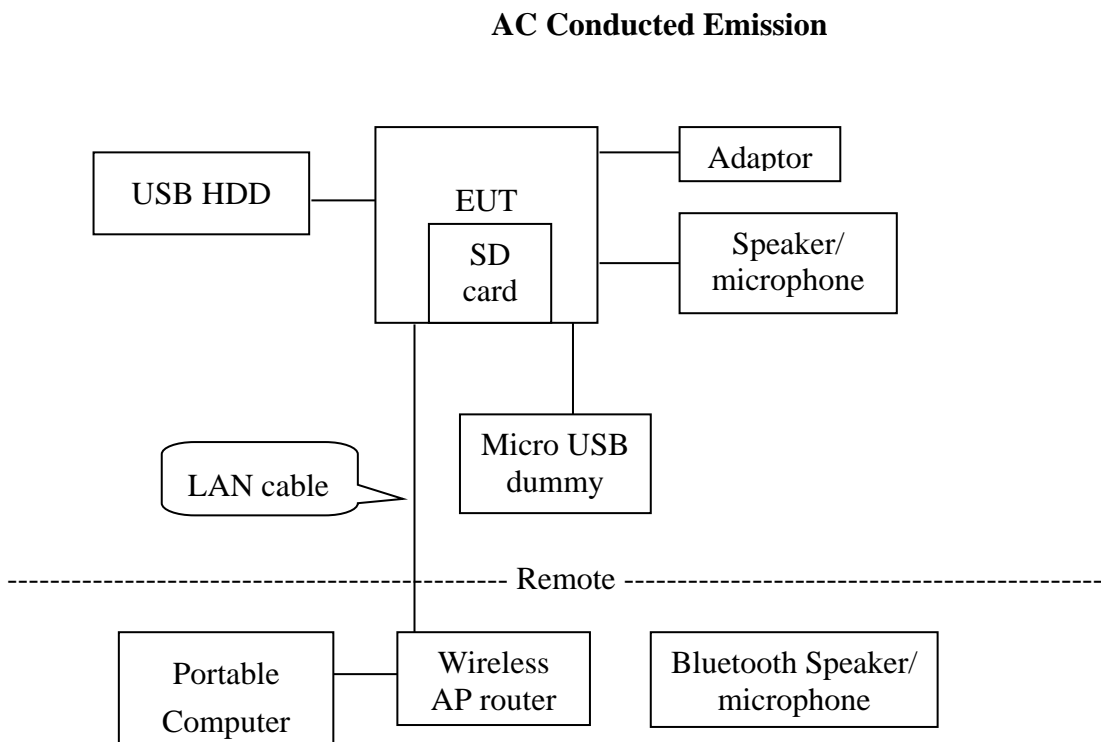

**Table 2-2 Equipment Used in Tested System**

Item	Equipment	Mfr/Brand	Model/ Type No.	Series No.	Data Cable	Power Cord
1	USB HDD	AKiTiO	SK2-U31AS-A KT	N/A	Shielded /1m	N/A
2	Portable Com- puter	Lenovo	TP00067B	N/A	N/A	Non-shielded /1.8m
3	Speaker/ microphone	KOKA	ST-304	N/A	Non-shielded /1.5m	N/A
4	Bluetooth Speaker/ microphone	N/A	SA-868	N/A	N/A	N/A
5	Wireless AP router	ASUS	RT-AC66U	N/A	Non-shield / 10m	Non-shield / 1.8m
6	SD card	SanDisk	11287080S2CA RD	N/A	N/A	N/A

**Note:** All the above equipment/cables were placed in worse case positions to maximize emission signals during emission test.

**Grounding:** Grounding was in accordance with the manufacturer's requirements and conditions for the intended use.

### 3 Summary of Test Results

FCC Rules	Description Of Test	Result
§15.207(a)	AC Power Line Conducted Emission	Compliant
§15.247(b) (3),(4)	Peak Output Power/ EIRP	Compliant
§15.247(a)(2)	6dB Power Bandwidth	Compliant
§15.247(d)	100 kHz Bandwidth Of Frequency Band Edges	Compliant
§15.247(d)	Spurious Emission	Compliant
§15.247(e)	Peak Power Density	Compliant
§15.203	Antenna Requirement	Compliant

### 4 Description of Test Modes

The EUT has been tested under engineering operating condition.

Test program used to control the EUT for staying in continuous transmitting mode is programmed.

Wifi:

802.11 b mode: Channel low (2412MHz), mid (2437MHz), high (2462MHz) with 1Mbps lowest data rate are chosen for full testing.

802.11 g mode: Channel low (2412MHz), mid (2437MHz), high (2462MHz) with 6Mbps lowest data rate are chosen for full testing.

802.11 n \_20MHz: Channel low (2412MHz), mid (2437MHz), high (2462MHz) with 6.5Mbps lowest data rate are chosen for full testing.

802.11 n \_40MHz: Channel low (2422MHz), mid (2437MHz), high (2452MHz) with 6.5Mbps lowest data rate are chosen for full testing.

BLE:

Channel low (2402MHz), mid (2442MHz) and high (2480MHz) with each modulation were chosen for full testing.

## 5 Conduced Emission Test

### 5.1 Standard Applicable:

According to §15.207, frequency range within 150kHz to 30MHz shall not exceed the Limit table as below.

Frequency range MHz	Limits dB(uV)	
	Quasi-peak	Average
0.15 to 0.50	66 to 56	56 to 46
0.50 to 5	56	46
5 to 30	60	50

Note

- 1.The lower limit shall apply at the transition frequencies
- 2.The limit decreases linearly with the logarithm of the frequency in the range 0.15 MHz to 0.50 MHz.

### 5.2 Measurement Equipment Used:

Location	Equipment Name	Brand	Model	S/N	Last Cal. Date	Next Cal. Date
Conduction 02	EMI Receiver 14	ROHDE& SCHWARZ	ESCI	101034	05/25/2022	05/25/2023
Conduction 02	Conduction 02-1 Cable	WOKEN	CFD 300-NL	Conduction 02 -1	10/13/2021	10/13/2022
Conduction 02	LISN 26	R&S	ENV216	102378	12/03/2021	12/03/2022
Conduction 02	LISN 21	R&S	ENV216	101476	07/20/2022	07/20/2023
Conduction 02	ISN T4 07	Teseq GmbH	ISN T400A	30449	07/28/2022	07/28/2023
Conduction 02	ISN T8 10	TESEQ	ISN T800	42773	08/05/2022	08/05/2023
Conduction 02	ISN T8 CAT6A_01	SCHWARZ-BECK	NTFM 8158	8158 0123	01/25/2022	01/25/2023
Conduction 02	CDN ISN ST08A_1	Teseq GmbH	CDN ISN ST08A	43352	10/07/2021	10/07/2022
Conduction 02	Capacitive Voltage Probe 01	SCHAFFNER	CVP 2200A	18711	02/23/2022	02/23/2023
Conduction 02	Current Probe	SCHAFFNER	SMZ 11	18030	02/23/2022	02/23/2023

### 5.3 EUT Setup:

1. The conducted emission tests were performed in the test site, using the setup in accordance with the ANSI C63.10: 2014.
2. The AC/DC Power adaptor of EUT was plug-in LISN. The EUT was placed flushed with the rear of the table.
3. The LISN was connected with 120Vac/60Hz power source.

#### **5.4 Measurement Procedure:**

1. The EUT was placed on a table which is 0.8m above ground plane.
2. Maximum procedure was performed on the six highest emissions to ensure EUT compliance.
3. Repeat above procedures until all frequency measured were complete.
4. Both 120V & 240V have been verified, and 120V/60Hz was defined as the worst-case and record in the report.

#### **5.5 Measurement Result:**

The initial step in collecting conducted data is a spectrum analyzer peak scan of the measurement range. Significant peaks are then marked as shown on the following data page, and these signals are then quasi-peaked.

Note: Refer to next page for measurement data and plots.

## AC POWER LINE CONDUCTED EMISSION TEST DATA



Address: No. 120, Lane 180, Hsin Ho Rd., Lung-Tan Dist.,  
Tao Yuan City 325, Taiwan.  
Tel: 03-2638888

### Conducted Emission Measurement

Date: 2022/10/6

operator: Martin  
Temperature: 25 °C  
Humidity: 53 %

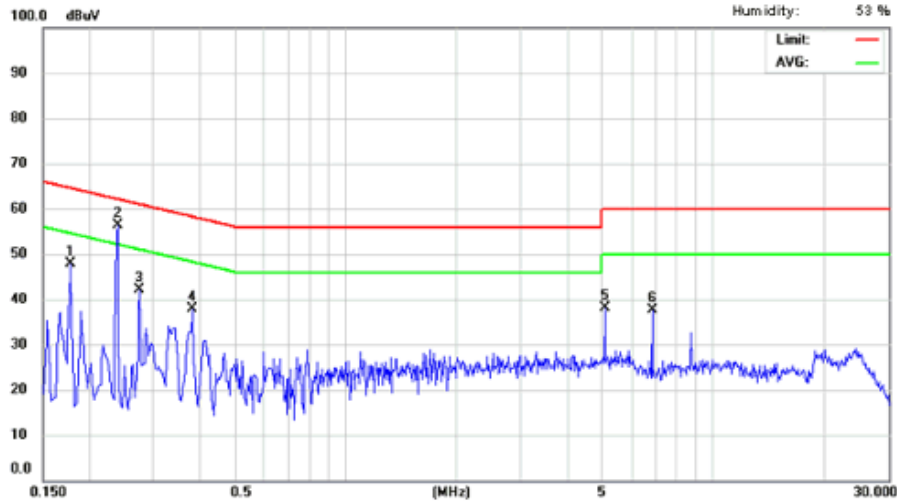

Site: Conduction 02

Phase: L1

No.	Frequency (MHz)	QP_R (dBuV)	AVG_R (dBuV)	Correct Factor (dB)	QP Emission (dBuV)	QP Limit (dBuV)	QP Margin (dB)	AVG Emission (dBuV)	AVG Limit (dBuV)	AVG Margin (dB)
1	0.178	30.87	6.71	9.67	40.54	64.58	-24.04	16.38	54.58	-38.20
2	0.238	24.93	4.41	9.67	34.60	62.17	-27.57	14.08	52.17	-38.09
3	0.274	21.73	5.36	9.67	31.40	61.00	-29.60	15.03	51.00	-35.97
4	0.382	19.13	11.76	9.68	28.81	58.24	-29.43	21.44	48.24	-26.80
5	5.074	13.23	6.43	9.81	23.04	60.00	-36.96	16.24	50.00	-33.76
6	6.834	9.91	3.19	9.84	19.75	60.00	-40.25	13.03	50.00	-36.97



Address: No. 120, Lane 180, Hsin Ho Rd., Lung-Tan Dist.,  
Tao Yuan City 325, Taiwan.  
Tel: 03-2698888

Conducted Emission Measurement

operator: Martin  
Temperature: 25 °C  
Humidity: 53 %

Date: 2022/10/6

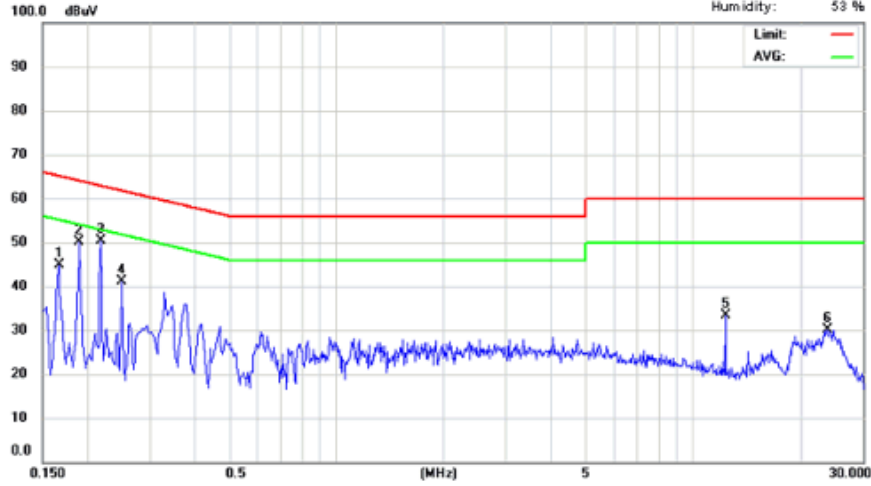

Site: Conduction 02

Phase: *N*

No.	Frequency (MHz)	QP_R (dBuV)	AVG_R (dBuV)	Correct Factor (dB)	QP Emission (dBuV)	QP Limit (dBuV)	QP Margin (dB)	AVG Emission (dBuV)	AVG Limit (dBuV)	AVG Margin (dB)
1	0.166	31.79	8.20	9.67	41.46	65.16	-23.70	17.87	55.16	-37.29
2	0.190	28.85	8.02	9.67	38.52	64.04	-25.52	17.69	54.04	-36.35
3	0.218	25.76	8.08	9.67	35.43	62.89	-27.46	17.75	52.89	-35.14
4	0.250	20.43	4.46	9.67	30.10	61.76	-31.66	14.13	51.76	-37.63
5	12.362	5.63	0.47	9.95	15.58	60.00	-44.42	10.42	50.00	-39.58
6	23.922	14.20	3.26	10.07	24.27	60.00	-35.73	13.33	50.00	-36.67



## 6 Peak Output Power

### 6.1 Standard Applicable:

According to §15.247(b)(3),(4)(b)

(3) For systems using digital modulation in the 902-928 MHz, 2400-2483.5 MHz, and 5725-5850 MHz bands: 1 Watt. As an alternative to a peak power measurement, compliance with the one Watt limit can be based on a measurement of the maximum conducted output power. Maximum Conducted Output Power is defined as the total transmit power delivered to all antennas and antenna elements averaged across all symbols in the signaling alphabet when the transmitter is operating at its maximum power control level. Power must be summed across all antennas and antenna elements. The average must not include any time intervals during which the transmitter is off or is transmitting at a reduced power level. If multiple modes of operation are possible (e.g., alternative modulation methods), the maximum conducted output power is the highest total transmit power occurring in any mode.

(4) The conducted output power limit specified in paragraph (b) of this section is based on the use of antennas with directional gains that do not exceed 6 dBi. Except as shown in paragraph (c) of this section, if transmitting antennas of directional gain greater than 6 dBi are used, the conducted output power from the intentional radiator shall be reduced below the stated values in paragraphs (b)(1), (b)(2), and (b)(3) of this section, as appropriate, by the amount in dB that the directional gain of the antenna exceeds 6 dBi.

(c) Operation with directional antenna gains greater than 6 dBi.

(1) Fixed point-to-point operation:

(i) Systems operating in the 2400-2483.5 MHz band that are used exclusively for fixed, point-to-point operations may employ transmitting antennas with directional gain greater than 6 dBi provided the maximum conducted output power of the intentional radiator is reduced by 1 dB for every 3 dB that the directional gain of the antenna exceeds 6 dBi.

(ii) Systems operating in the 5725-5850 MHz band that are used exclusively for fixed, point-to-point operations may employ transmitting antennas with directional gain greater than 6 dBi without any corresponding reduction in transmitter conducted output power.

## 6.2 Measurement Equipment Used:

Location Conducted	Equipment Name	Brand	Model	S/N	Last Cal. Date	Next Cal. Date
Conducted	Power Meter	Anritsu	ML2495A	1116010	09/29/2022	09/29/2023
Conducted	Power Sensor	Anritsu	MA2411B	34NKF50	09/29/2022	09/29/2023
Conducted	Power Sensor	DARE	RPR3006W	13I00030SNO33	01/07/2022	01/07/2023
Conducted	Power Sensor	DARE	RPR3006W	13I00030SNO34	01/07/2022	01/07/2023
Conducted	Power Sensor	DARE	RPR3006W	14I00889SNO35	06/29/2022	06/29/2023
Conducted	Power Sensor	DARE	RPR3006W	14I00889SNO36	06/29/2022	06/29/2023
Conducted	Temperature Chamber	KSON	THS-B4H100	2287	05/20/2022	05/20/2023
Conducted	DC Power supply	ABM	8185D	N/A	01/06/2022	01/06/2023
Conducted	AC Power supply	EXTECH	CFC105W	NA	N/A	N/A
Conducted	Spectrum analyzer	Keysight	N9010A	MY56070257	09/28/2022	09/28/2023
Conducted	Test Software	DARE	Radiation Ver:2013.1.23	NA	NA	NA
Conducted	Test Software	R&S	CMUGO Ver:2.0.0	N/A	N/A	N/A
Conducted	Universal Digital Radio Communication Tester	R&S	CMU200	111968	11/18/2021	11/18/2022
Conducted	Wideband Radio Communication Tester	R&S	CMW500	1201.002K50108 793-JG	10/26/2021	10/26/2022
Conducted	BT Simulator	Agilent	N4010A	MY48100200	NA	NA
Conducted	GPS SIMULATOR	WELNAVIGATE	GS-50	701523	NA	NA
Conducted (TS8997)	Wideband Radio Communication Tester	R&S	CMW500	168811	09/22/2022	09/22/2023
Conducted (TS8997)	Signal Generator	R&S	SMB100B	101085	09/21/2022	09/21/2023
Conducted (TS8997)	Vector Signal Generator	R&S	SMBV100A	263246	09/21/2022	09/21/2023
Conducted (TS8997)	Signal analyzer 40GHz	R&S	FSV40	101884	09/22/2022	09/22/2023
Conducted (TS8997)	OSP150 extension unit CAM-BUS	R&S	OSP150	101107	09/21/2022	09/21/2023
Conducted (TS8997)	Test Software	R&S	EMC32 Ver:11.10.00	NA	NA	NA

### 6.3 Test Set-up:

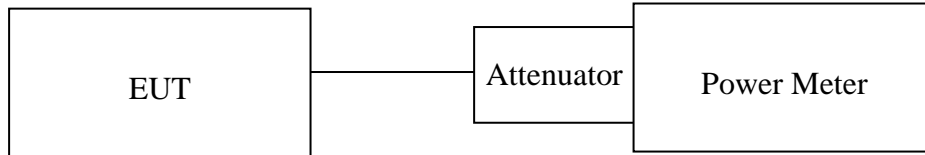

### 6.4 Measurement Procedure:

1. Place the EUT on the table and set it in transmitting mode.
2. Remove the antenna from the EUT and then connect a low loss RF cable from the antenna port to the power meter
3. Record the max. reading.
4. Repeat above procedures until all frequency measured were complete.

## 6.5 Measurement Result:

### Peak Power

Mode	Freq. (MHz)	Output Power (dBm)				Total Output Power (dBm)	Output Power Limit (dBm)
		Chain 0	Chain 1	Chain 2	Chain 3		
802.11b	2412	19.00				19.00	30.00
	2437	19.78				19.78	30.00
	2462	20.11				20.11	30.00
802.11g	2412	23.67				23.67	30.00
	2437	24.02				24.02	30.00
	2462	24.19				24.19	30.00
802.11n HT20	2412	23.54				23.54	30.00
	2437	23.99				23.99	30.00
	2462	23.91				23.91	30.00
802.11n HT40	2422	22.51				22.51	30.00
	2437	22.61				22.61	30.00
	2452	22.48				22.48	30.00

### Peak Power

Mode	Freq. (MHz)	Output Power (dBm)	Total Output Power (dBm)	Output Power Limit (dBm)
BLE (1M)	2402	5.87	5.87	30.00
	2442	7.13	7.13	30.00
	2480	6.71	6.71	30.00

## 7 6dB Bandwidth

### 7.1 Standard Applicable:

According to §15.247(a)(2), Systems using digital modulation techniques may operate in the 902 - 928 MHz, 2400 - 2483.5 MHz, and 5725 - 5850 MHz bands. The minimum 6 dB bandwidth shall be at least 500kHz.

### 7.2 Measurement Equipment Used:

Refer to section 6.2 for details.

### 7.3 Test Set-up:

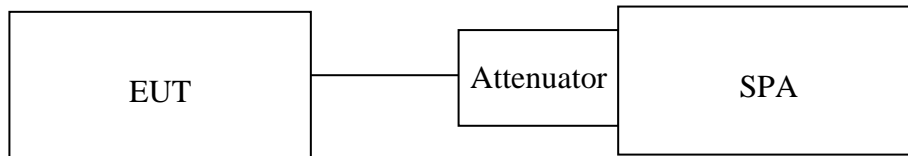

### 7.4 Measurement Procedure:

1. Place the EUT on the table and set it in transmitting mode.
2. Remove the antenna from the EUT and then connect a low loss RF cable from the antenna port to the spectrum analyzer.
3. Set the spectrum analyzer as RBW=100kHz, VBW = 3\*RBW, Span= cover the complete power envelope of the signal of the UUT Sweep=auto
4. Mark the peak frequency and -6dB (upper and lower) frequency.
5. Repeat above procedures until all frequency measured were complete.

## 7.5 Measurement Result:

802.11 b.g.n20.n40

Test mode	Frequency (MHz)	6dB Bandwidth (MHz)	6dB BW Limit (kHz)
802.11b	2412	8.59	> 500
	2437	8.57	> 500
	2462	9.06	> 500
802.11g	2412	16.10	> 500
	2437	16.30	> 500
	2462	15.79	> 500
802.11n HT20	2412	17.14	> 500
	2437	17.06	> 500
	2462	15.35	> 500
802.11n HT40	2422	35.79	> 500
	2437	35.57	> 500
	2452	35.85	> 500

BLE

Frequency (MHz)	6dB Bandwidth (MHz)	6dB BW Limit (kHz)
2402	0.721	> 500
2442	0.722	> 500
2480	0.720	> 500

Note: Refer to next page for plots.

802.11b

6dB Band Width Test Data CH-Low

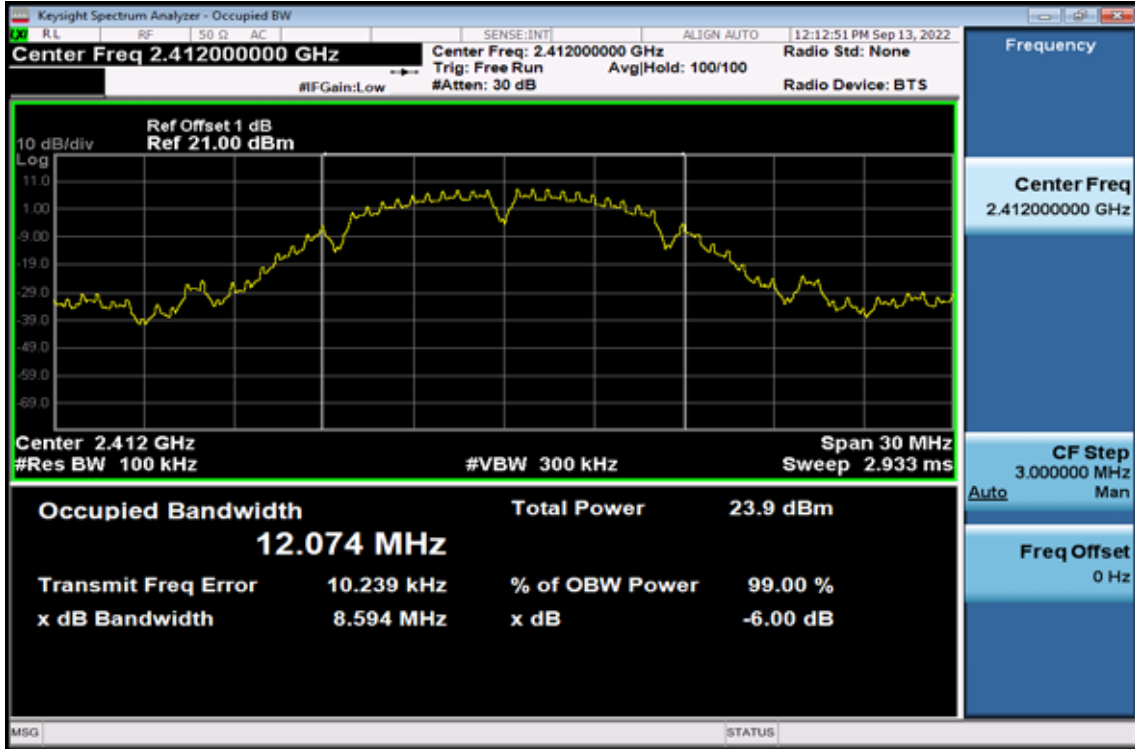

6dB Band Width Test Data CH-Mid

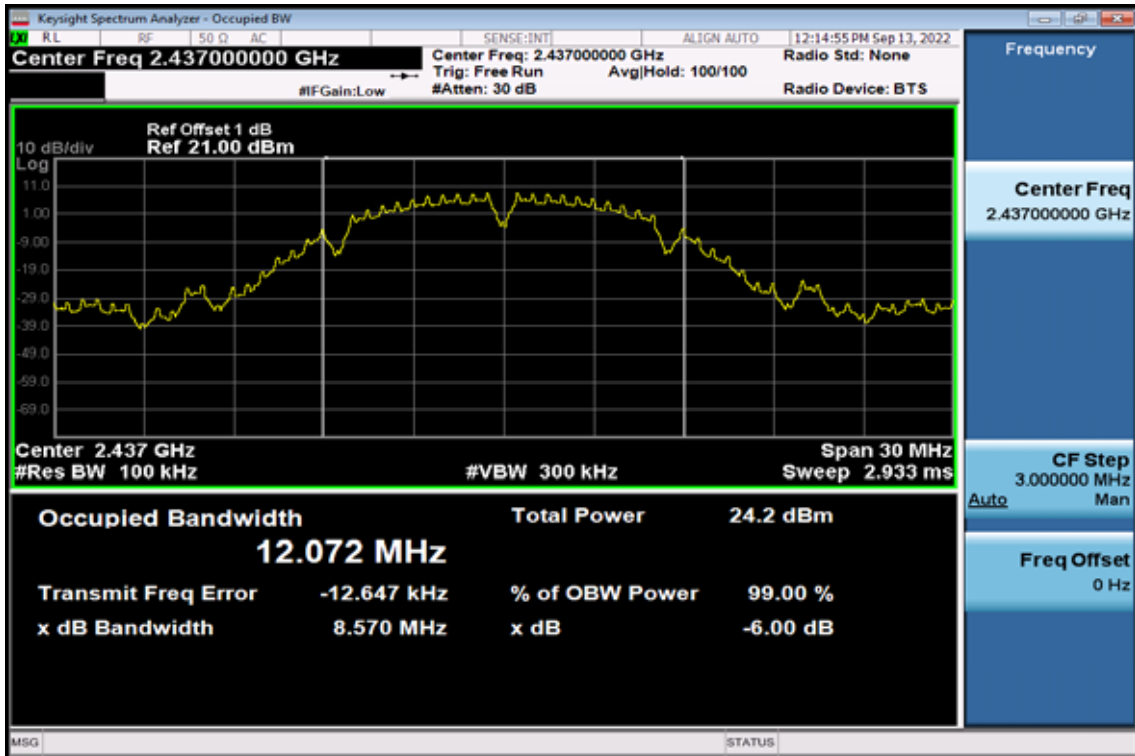

### 6dB Band Width Test Data CH-High

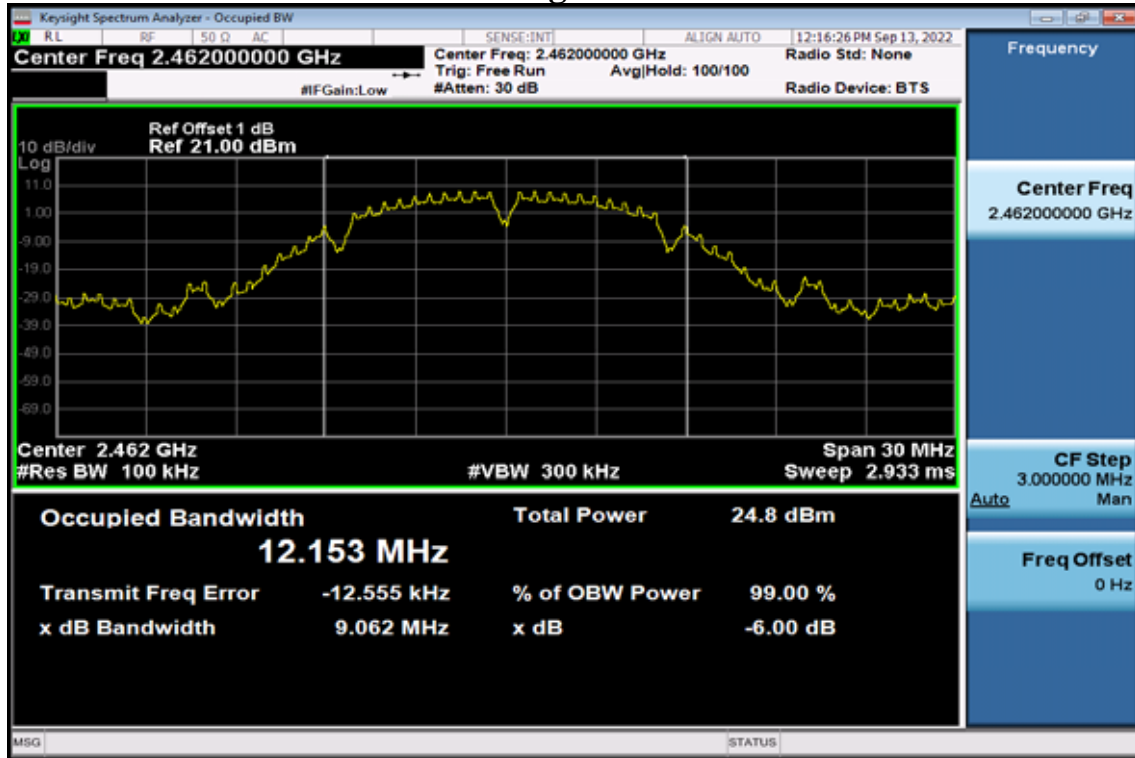

### 802.11g

### 6dB Band Width Test Data CH-Low

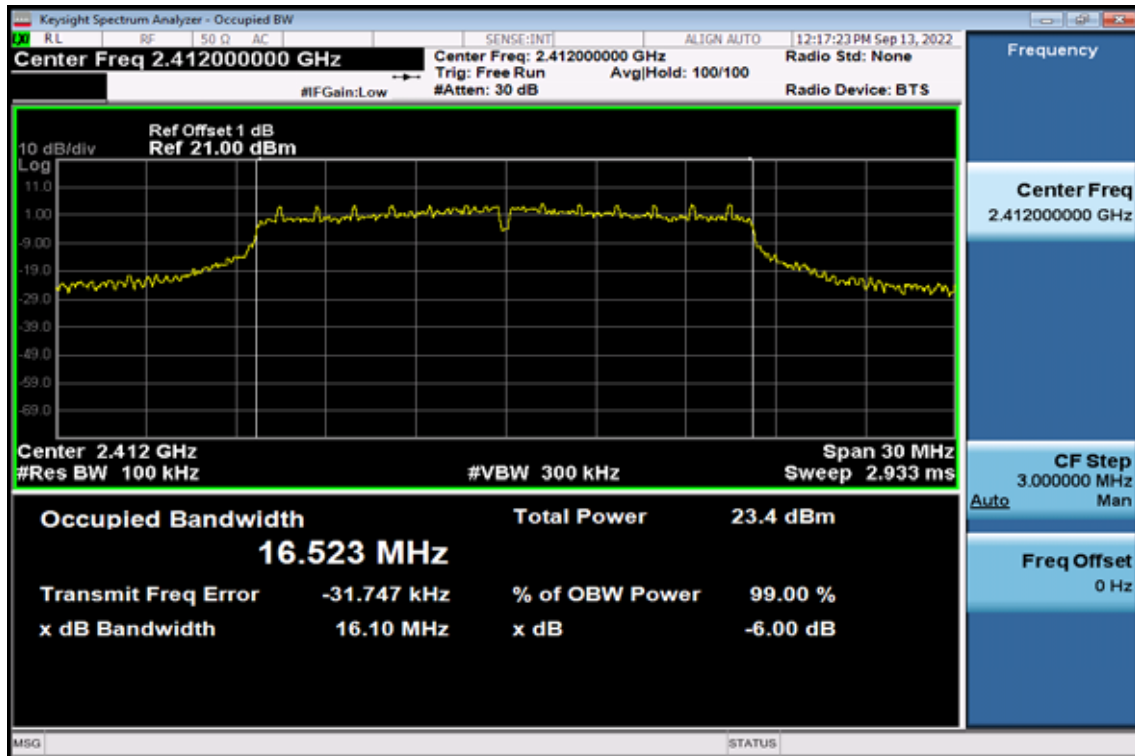



### 6dB Band Width Test Data CH-Mid

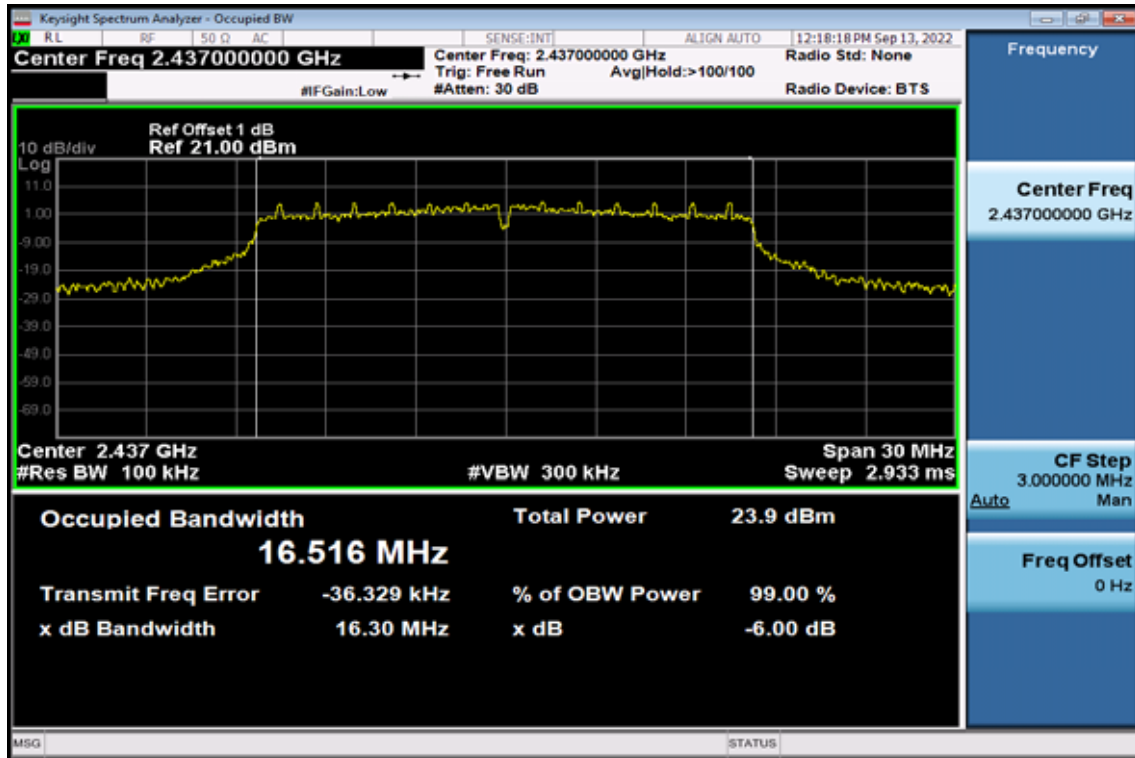

### 6dB Band Width Test Data CH-High

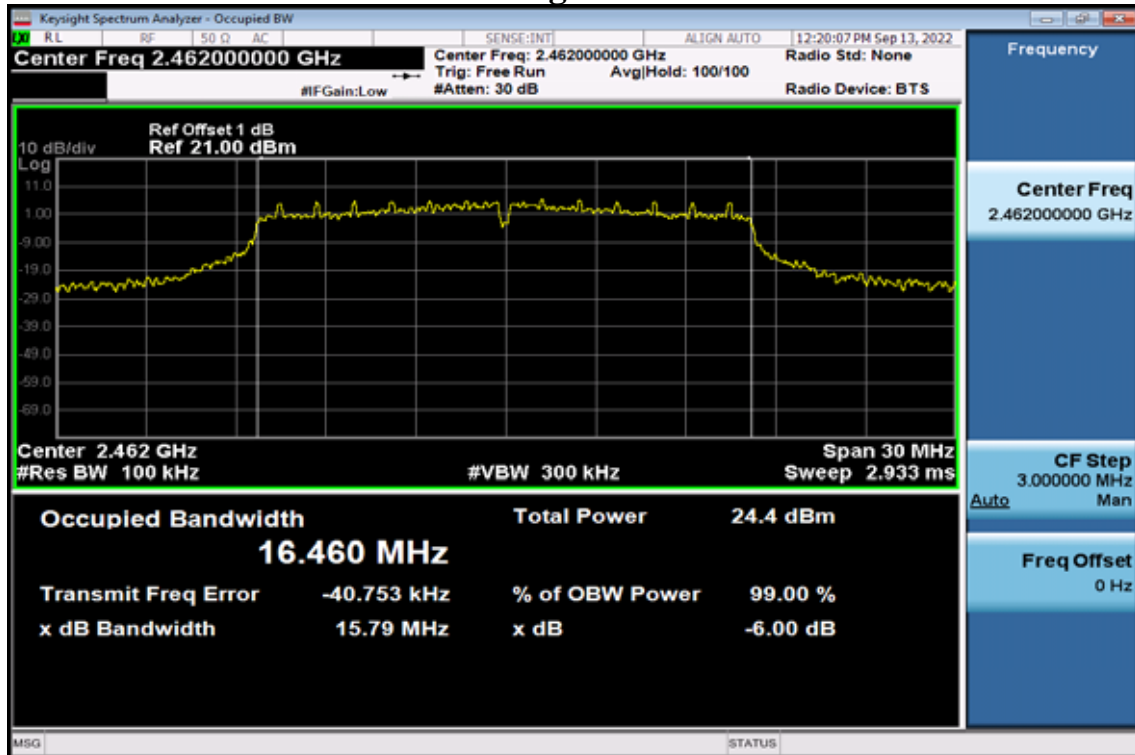

### 802.11n\_20M

#### 6dB Band Width Test Data CH-Low

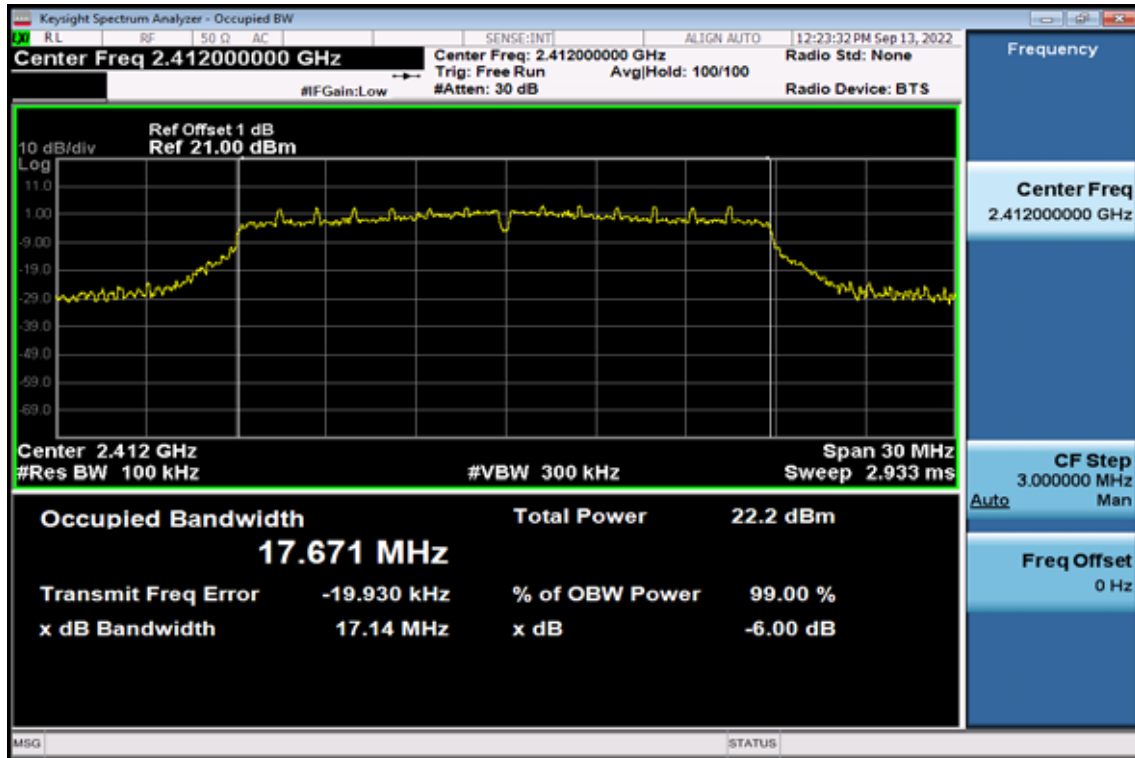

#### 6dB Band Width Test Data CH-Mid

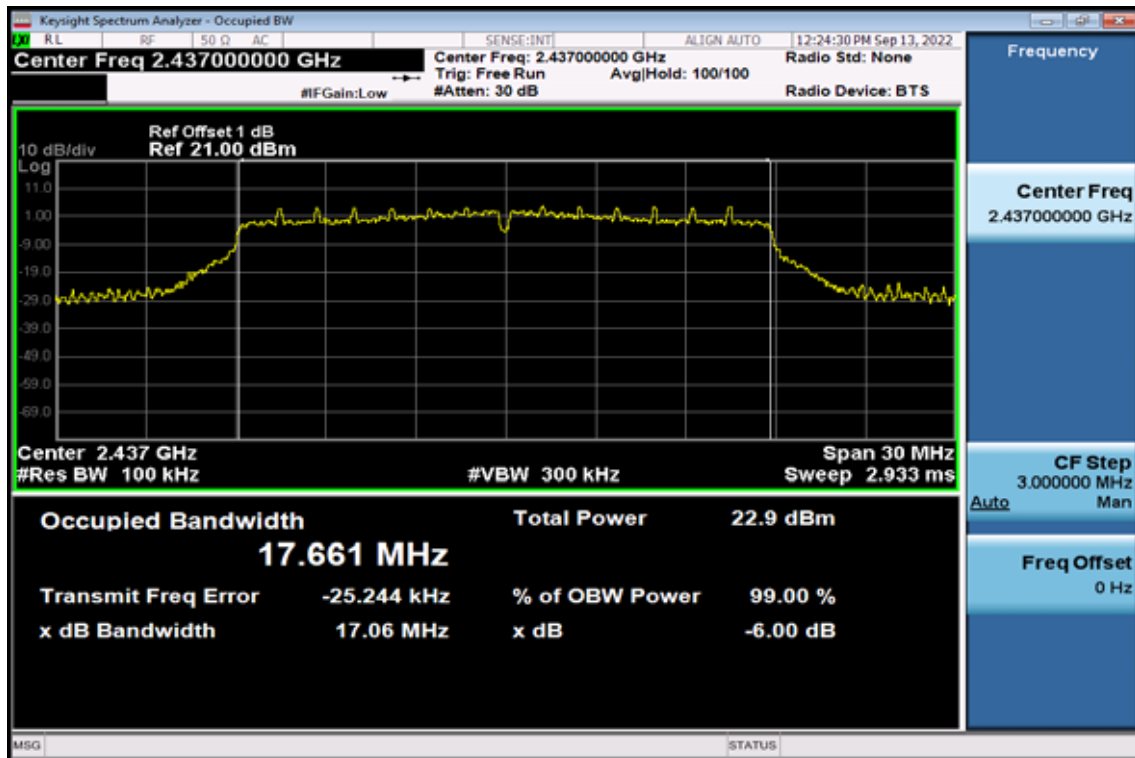

### 6dB Band Width Test Data CH-High

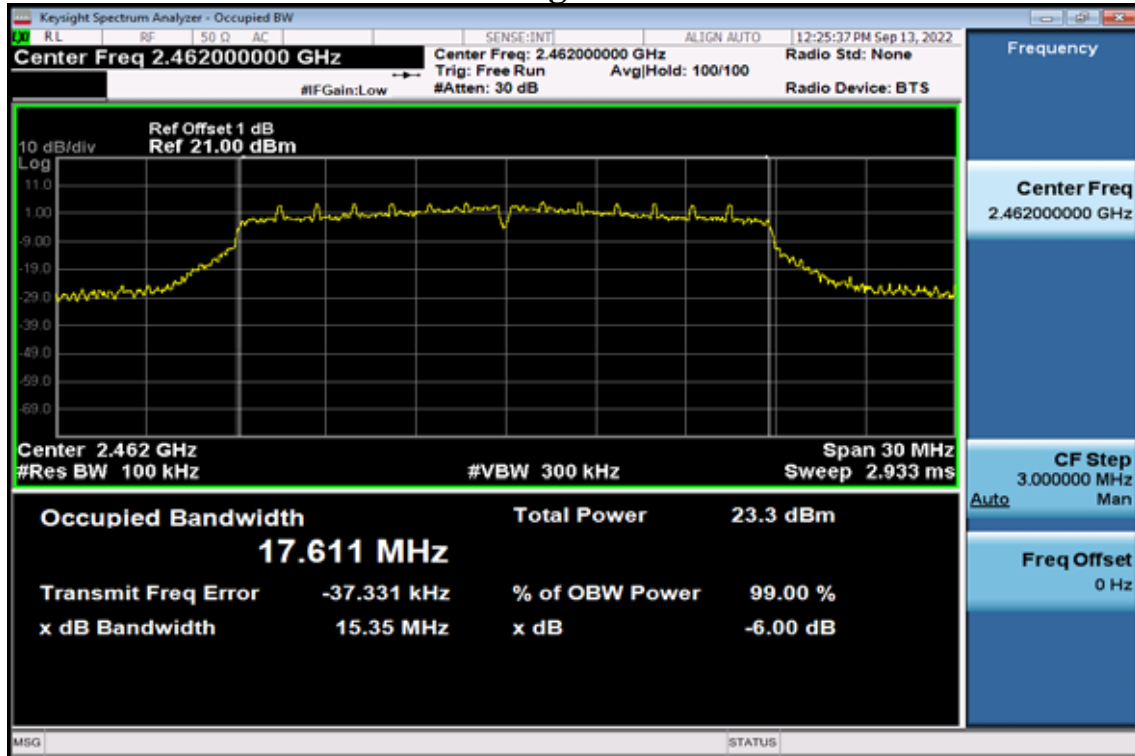

### 802.11n\_40M

### 6dB Band Width Test Data CH-Low

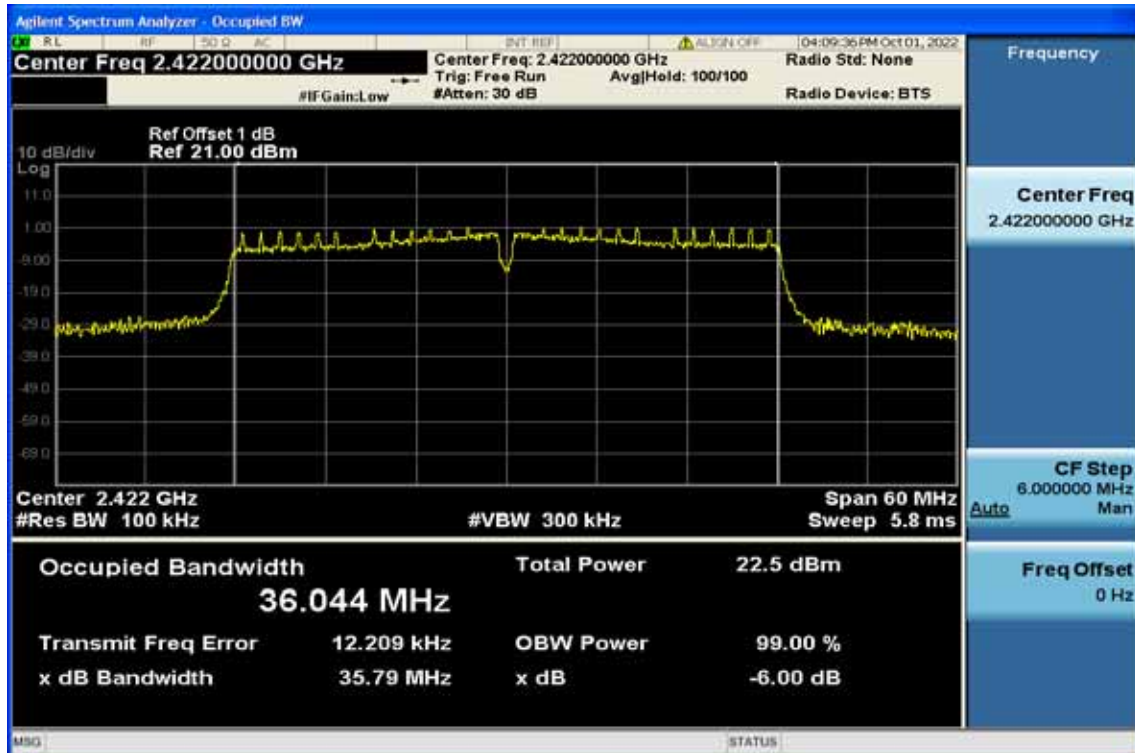

### 6dB Band Width Test Data CH-Mid

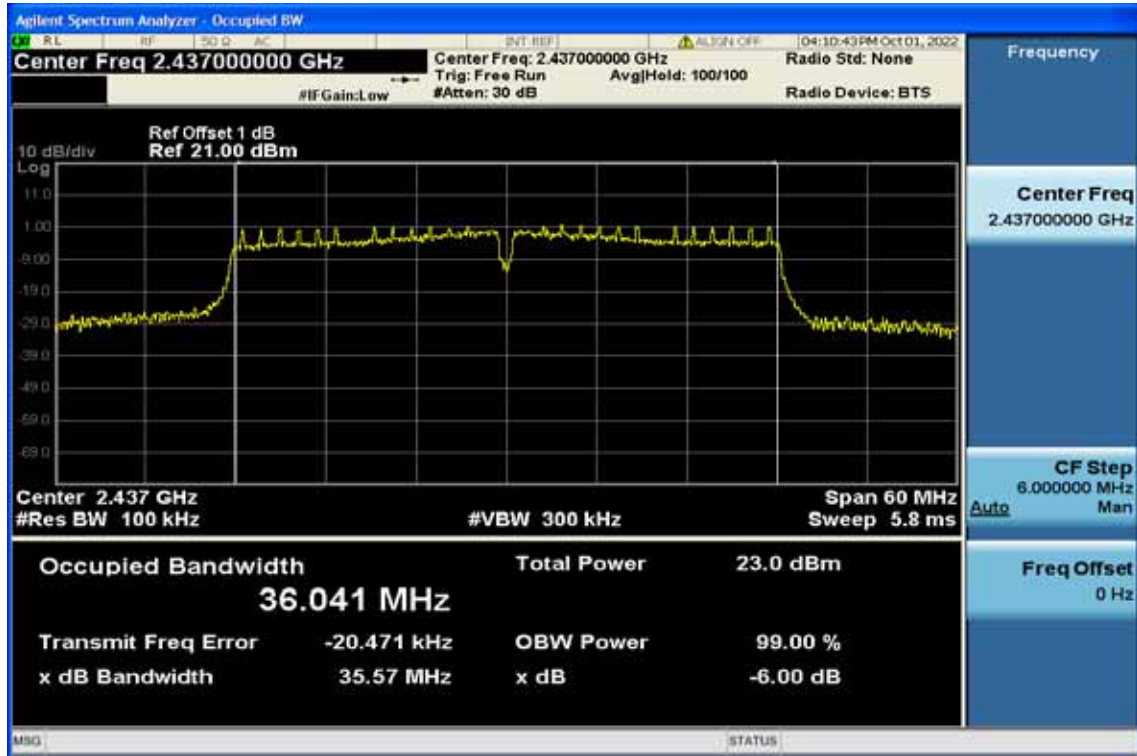

### 6dB Band Width Test Data CH-High

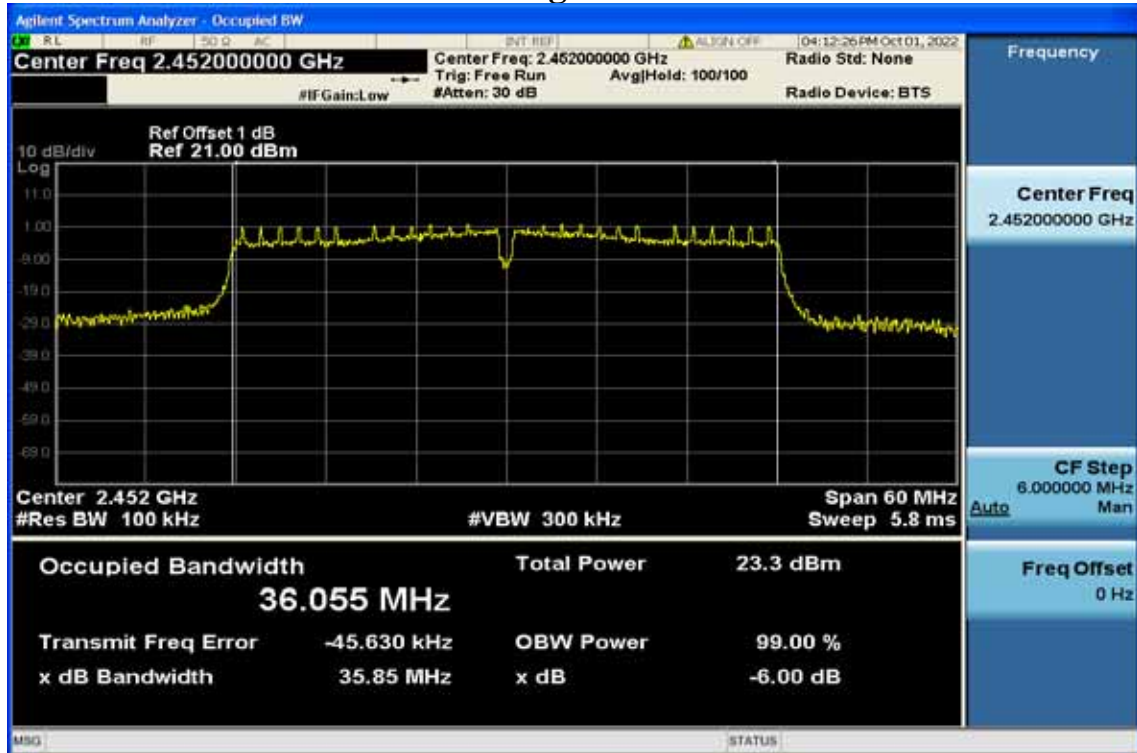

## BLE

### 6dB Band Width Test Data CH-Low

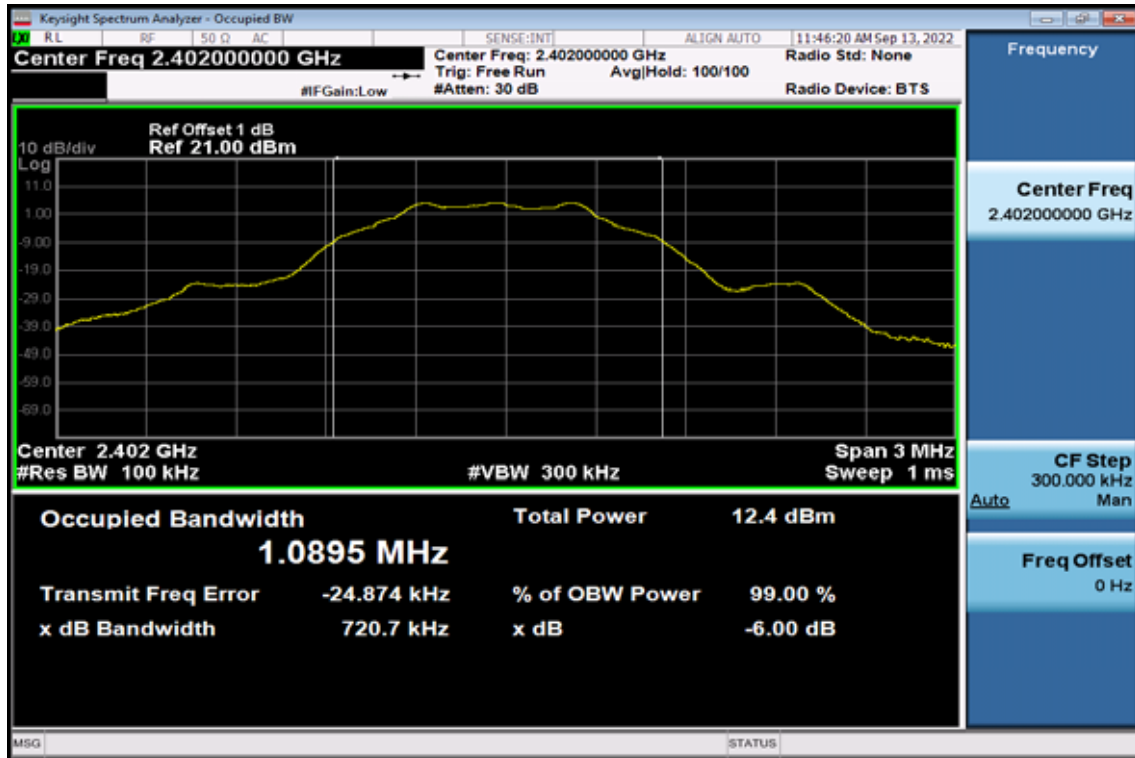

### 6dB Band Width Test Data CH-Mid

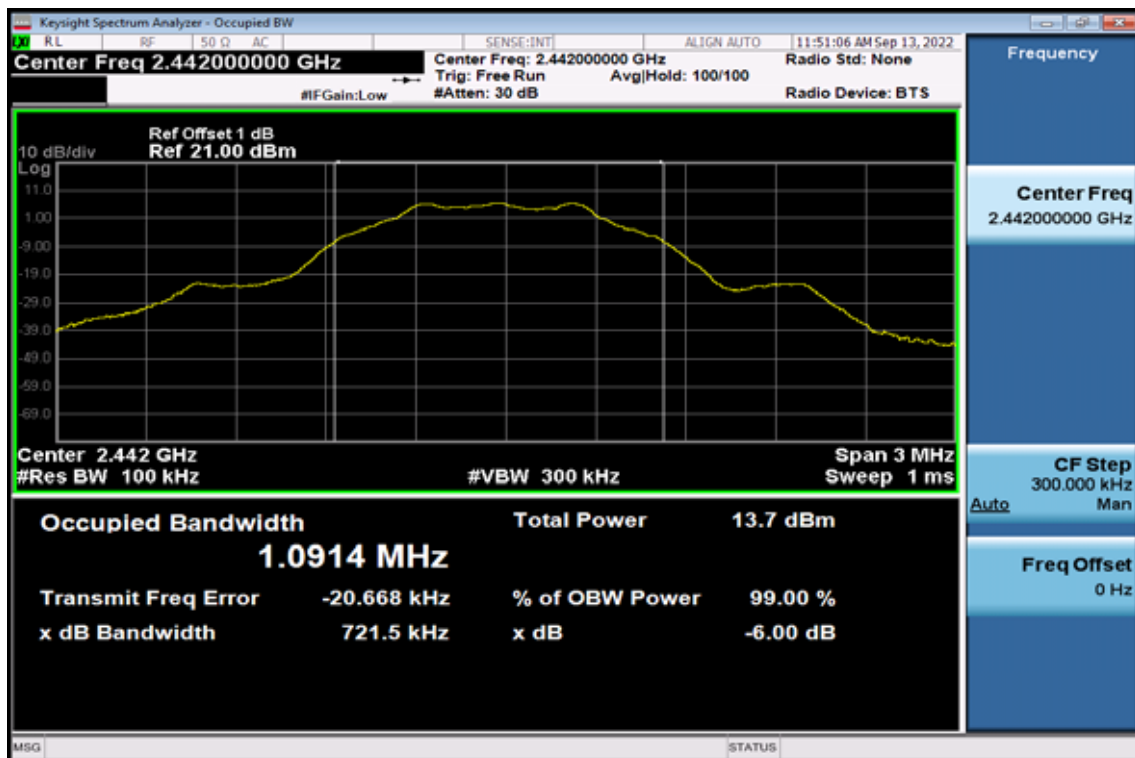

### 6dB Band Width Test Data CH-High

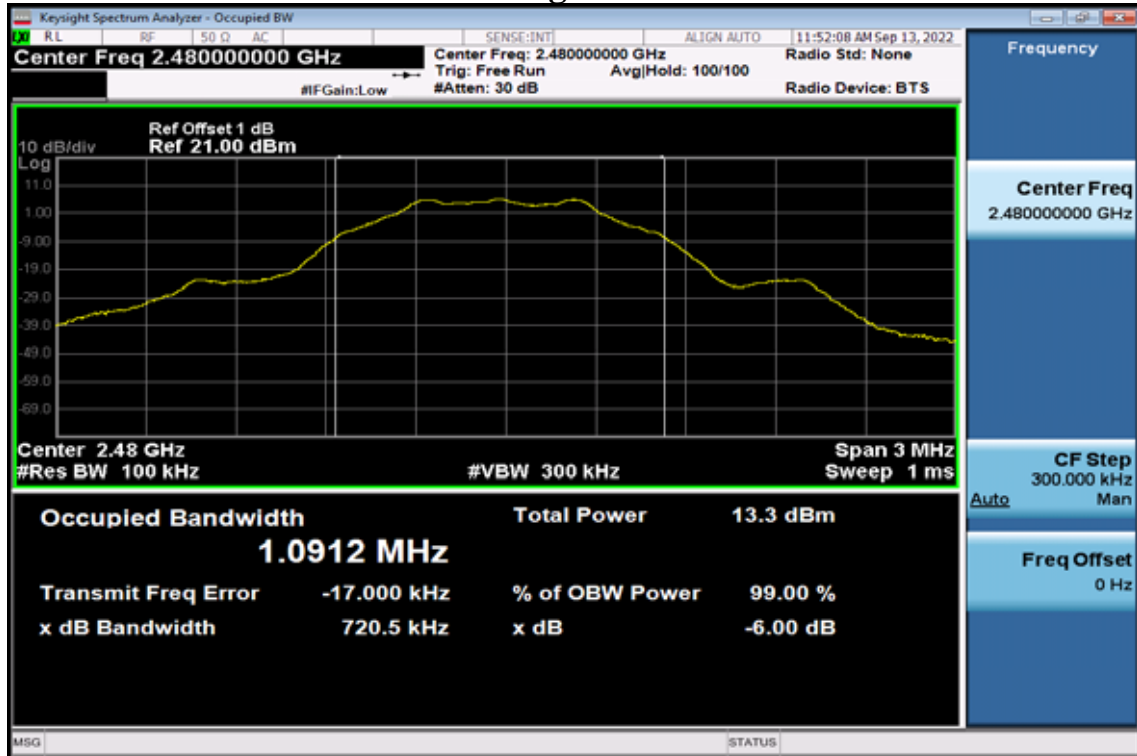

## 8 Spurious Radiated Emission Test

### 8.1 Standard Applicable

According to §15.247(d), all other emissions outside these bands shall not exceed the general radiated emission limits specified in §15.209(a). And according to §15.33(a)(1), for an intentional radiator operates below 10GHz, the frequency range of measurements: to the tenth harmonic of the highest fundamental frequency or to 40GHz, whichever is lower.

### 8.2 Measurement Equipment Used:

#### 8.2.1 Conducted Emission at antenna port:

Refer to section 6.2 for details.

#### 8.2.2 Radiated emission:

Location	Equipment Name	Brand	Model	S/N	Last Cal. Date	Next Cal. Date
Chamber 19	Signal analyzer	R&S	FSV40	101919	8/17/2022	8/17/2023
Chamber 19	EMI Receiver	R&S	ESR3	102461	05/10/2022	05/10/2023
Chamber 19	Loop Antenna	EM	EM-6879	271	10/05/2022	10/05/2023
Chamber 19	Bilog Antenna (30MHz-1GHz)	Schwarzbeck	VULB9168 w 6dB Att.	9168-736	03/09/2022	03/09/2023
Chamber 19	Horn antenna (1GHz-18GHz)	ETS	3117	00218718	10/12/2022	10/12/2023
Chamber 19	Horn antenna (18GHz-26GHz)	Com-power	AH-826	081001	11/30/2021	11/30/2022
Chamber 19	Horn antenna (26GHz-40GHz)	Com-power	AH-640	100A	03/18/2022	03/18/2023
Chamber 19	Preamplifier (9kHz-1GHz)	HP	8447F	3113A04621	06/24/2022	06/24/2023
Chamber 19	Preamplifier (1GHz - 26GHz)	EM	EM01M26G	060681	05/12/2022	05/12/2023
Chamber 19	Preamplifier (26GHz-40GHz)	MITEQ	JS4-26004000- 27-5A	818471	05/12/2022	05/12/2023
Chamber 19	RF Cable (100kHz-26.5GHz)	Huber Suhner & Woken	Sucoflex 104A & 18GHz SMA(M)-SM A(M)-10M	MY817/4A & 20200525	12/23/2021	12/23/2022
Chamber 19	RF Cable (18GHz-40GHz)	HUBER SU- HNER	Sucoflex 102	27963/2&374 21/2	11/17/2021	11/17/2022
Chamber 19	Signal Generator	Anritsu	MG3692A	20311	12/28/2021	12/28/2022
Chamber 19	Test Software	Audix	E3 Ver:6.120203b	N/A	N/A	N/A

### 8.3 Test SET-UP:

The test item only performed radiated mode

(A) Radiated Emission Test Set-Up, Frequency Below 1000MHz

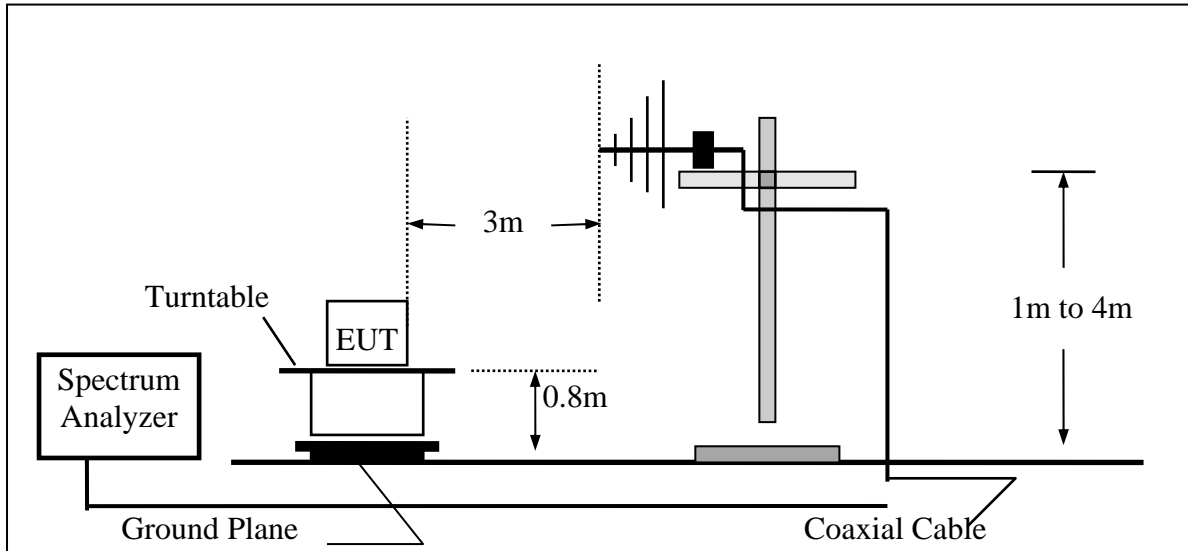

(B) Radiated Emission Test Set-UP Frequency Over 1 GHz

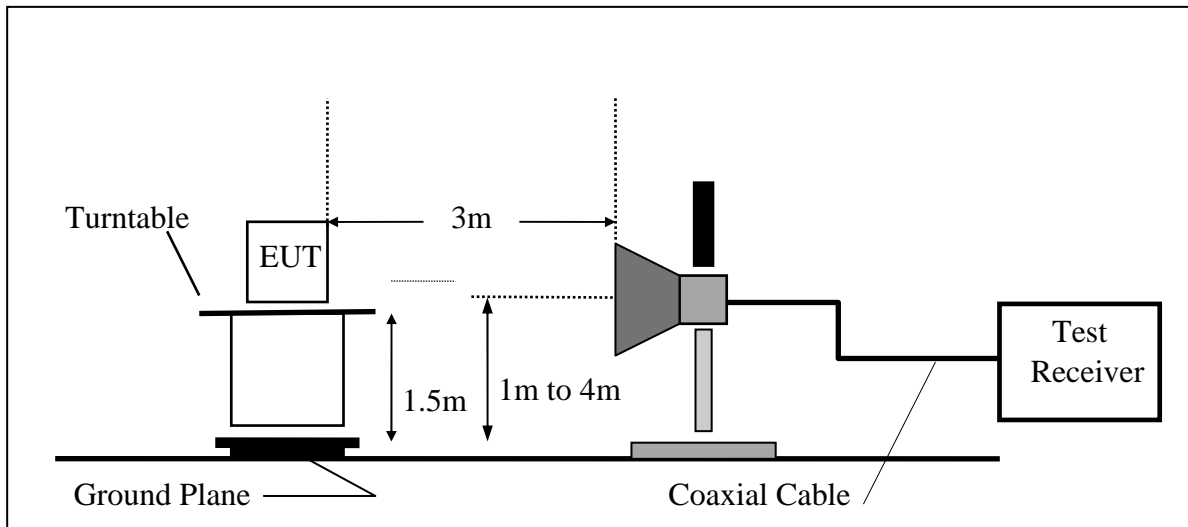



**8.4 Measurement Procedure:**

1. According 414788 section 2, Either OATS or chamber for radiated emission below 30MHz, the test was done at 966 chamber, the test site was evaluated with OATS and the Chamber has test signals level greater than OATS's.
2. The EUT was placed on a turn table which is 0.8m/1.5m above ground plane in 966 chamber.
3. The turn table shall rotate 360 degrees to determine the position of maximum emission level.
4. EUT is set 3m away from the receiving antenna which varied from 1m to 4m to find out the highest emissions.
5. When measurement procedures for electric field radiated emissions above 1 GHz the EUT measurement is to be made “while keeping the antenna in the ‘cone of radiation’ from that area and pointed at the area both in azimuth and elevation, with polarization oriented for maximum response.” is still within the 3dB illumination BW of the measurement antenna.
6. Maximum procedure was performed on the six highest emissions to ensure EUT compliance.
7. And also, each emission was to be maximized by changing the polarization of receiving antenna both horizontal and vertical.
8. Repeat above procedures until all frequency measured were complete.

Test receiver setting : Blew 1GHz  
 Detector : Average(9kHz – 90kHz, 110kHz – 90kHz), Quasi-Peak  
 Bandwidth : 200Hz, 120kHz  
 Test spectrum setting : Above 1GHz  
 Peak : RBW=1MHz, VBW=3MHz,Sweep=auto  
 Average (for Wi-Fi) : RBW=1MHz, VBW≥1/Ton, Sweep=auto  
 Average (for BLE) : RBW=1MHz, VBW ≥1/Ton 1, Sweep=auto

Average Measurement Setting (VBW)

Mode	ON time (ms)	Total time (ms)	Duty Cycle	Duty Factor	1/Ton (kHz)	VBW for average detector (kHz)
b	--	--	100.000%	0.00	--	0.01
g	1.386	1.439	96.335%	0.16	0.721	1
HT20	1.303	1.356	96.111%	0.17	0.767	1
HT40	0.635	0.690	92.029%	0.36	1.575	3
BLE	0.384	0.624	61.538%	2.11	2.604	3

## 8.5 Field Strength Calculation

The field strength is calculated by adding the Antenna Factor and Cable Factor and subtracting the Amplifier Gain and Duty Cycle Correction Factor(if any) from the measured reading. The basic equation with a sample calculation is as follows:

$$FS = RA + AF + CL - AG$$

Where	FS = Field Strength	CL = Cable Attenuation Factor (Cable Loss)
	RA = Reading Amplitude	AG = Amplifier Gain
	AF = Antenna Factor	

## 8.6 Measurement Result:

Note: Refer to next page spectrum analyzer data chart and tabular data sheets.

**Radiated Spurious Emission Measurement Result (below 1GHz) (802.11b mode)**

Operation Mode	TX mode	Test Date	2022/09/27
Channel number	CH Low	Test By	Barry
Temperature	25	Pol	Ver./Hor
Humidity	60 %		

No	Freq MHz	Reading dBuV	Factor dB	Level dBuV/m	Limit dBuV/m	Margin dB	Remark	Pol V/H
1	369.50	41.07	-3.12	37.95	46.00	-8.05	Peak	VERTICAL
2	399.57	38.75	-2.54	36.21	46.00	-9.79	Peak	VERTICAL
3	444.19	43.41	-1.11	42.30	46.00	-3.70	Peak	VERTICAL
4	625.58	37.92	2.00	39.92	46.00	-6.08	Peak	VERTICAL
5	740.04	36.88	4.03	40.91	46.00	-5.09	Peak	VERTICAL
6	888.45	32.81	5.96	38.77	46.00	-7.23	Peak	VERTICAL
1	295.78	43.41	-4.21	39.20	46.00	-6.80	Peak	HORIZONTAL
2	369.50	45.80	-3.12	42.68	46.00	-3.32	Peak	HORIZONTAL
3	592.60	40.13	1.58	41.71	46.00	-4.29	Peak	HORIZONTAL
4	600.36	38.72	1.79	40.51	46.00	-5.49	Peak	HORIZONTAL
5	625.58	38.92	2.00	40.92	46.00	-5.08	Peak	HORIZONTAL
6	888.45	36.01	5.96	41.97	46.00	-4.03	Peak	HORIZONTAL

Remark:

- 1 No further spurious emissions detected from the lowest internal frequency and 30MHz.
- 2 Measuring frequencies from the lowest internal frequency to the 1GHz.
- 3 Radiated emissions measured in frequency range from 9kHz to 1000MHz were made with an instrument detector setting 9-90kHz/110-490kHz using PK/AV and other Frequency Band using PK/QP
- 4 Measurement result within this frequency range shown “ - ” in the table above means the reading of emissions are attenuated more than 20dB below the permissible limits or the field strength is too small to be measured.

**Radiated Spurious Emission Measurement Result (below 1GHz) (802.11b mode)**

Operation Mode	TX mode	Test Date	2022/09/27
Channel number	CH Mid	Test By	Barry
Temperature	25	Pol	Ver./Hor
Humidity	60 %		

No	Freq MHz	Reading dBuV	Factor dB	Level dBuV/m	Limit dBuV/m	Margin dB	Remark	Pol V/H
1	369.50	44.01	-3.12	40.89	46.00	-5.11	Peak	VERTICAL
2	375.32	42.23	-2.91	39.32	46.00	-6.68	Peak	VERTICAL
3	399.57	43.94	-2.54	41.40	46.00	-4.60	Peak	VERTICAL
4	444.19	43.90	-1.11	42.79	46.00	-3.21	Peak	VERTICAL
5	625.58	39.99	2.00	41.99	46.00	-4.01	Peak	VERTICAL
6	888.45	37.11	5.96	43.07	46.00	-2.93	Peak	VERTICAL
1	216.24	48.88	-7.77	41.11	46.00	-4.89	Peak	HORIZONTAL
2	222.06	48.97	-7.93	41.04	46.00	-4.96	Peak	HORIZONTAL
3	295.78	47.40	-4.21	43.19	46.00	-2.81	Peak	HORIZONTAL
4	369.50	43.27	-3.12	40.15	46.00	-5.85	Peak	HORIZONTAL
5	591.63	38.83	1.55	40.38	46.00	-5.62	Peak	HORIZONTAL
6	888.45	36.30	5.96	42.26	46.00	-3.74	Peak	HORIZONTAL

Remark:

- 1 No further spurious emissions detected from the lowest internal frequency and 30MHz.
- 2 Measuring frequencies from the lowest internal frequency to the 1GHz.
- 3 Radiated emissions measured in frequency range from 9kHz to 1000MHz were made with an instrument detector setting 9-90kHz/110-490kHz using PK/AV and other Frequency Band using PK/QP
- 4 Measurement result within this frequency range shown “ - ” in the table above means the reading of emissions are attenuated more than 20dB below the permissible limits or the field strength is too small to be measured.

**Radiated Spurious Emission Measurement Result (below 1GHz) (802.11b mode)**

Operation Mode	TX mode	Test Date	2022/09/27
Channel number	CH High	Test By	Barry
Temperature	25	Pol	Ver./Hor
Humidity	60 %		

No	Freq MHz	Reading dBuV	Factor dB	Level dBuV/m	Limit dBuV/m	Margin dB	Remark	Pol V/H
1	369.50	40.87	-3.12	37.75	46.00	-8.25	Peak	VERTICAL
2	399.57	39.29	-2.54	36.75	46.00	-9.25	Peak	VERTICAL
3	444.19	43.92	-1.11	42.81	46.00	-3.19	Peak	VERTICAL
4	625.58	37.28	2.00	39.28	46.00	-6.72	Peak	VERTICAL
5	797.27	36.12	5.03	41.15	46.00	-4.85	Peak	VERTICAL
6	888.45	32.54	5.96	38.50	46.00	-7.50	Peak	VERTICAL
1	216.24	44.84	-7.77	37.07	46.00	-8.93	Peak	HORIZONTAL
2	222.06	46.42	-7.93	38.49	46.00	-7.51	Peak	HORIZONTAL
3	369.50	44.80	-3.12	41.68	46.00	-4.32	Peak	HORIZONTAL
4	591.63	42.18	1.55	43.73	46.00	-2.27	Peak	HORIZONTAL
5	625.58	37.33	2.00	39.33	46.00	-6.67	Peak	HORIZONTAL
6	888.45	36.84	5.96	42.80	46.00	-3.20	Peak	HORIZONTAL

Remark:

- 1 No further spurious emissions detected from the lowest internal frequency and 30MHz.
- 2 Measuring frequencies from the lowest internal frequency to the 1GHz.
- 3 Radiated emissions measured in frequency range from 9kHz to 1000MHz were made with an instrument detector setting 9-90kHz/110-490kHz using PK/AV and other Frequency Band using PK/QP
- 4 Measurement result within this frequency range shown “ - ” in the table above means the reading of emissions are attenuated more than 20dB below the permissible limits or the field strength is too small to be measured.

**Radiated Spurious Emission Measurement Result (below 1GHz) (802.11g mode)**

Operation Mode	TX mode	Test Date	2022/09/27
Channel number	CH Low	Test By	Barry
Temperature	25	Pol	Ver./Hor
Humidity	60 %		

No	Freq MHz	Reading dBuV	Factor dB	Level dBuV/m	Limit dBuV/m	Margin dB	Remark	Pol V/H
1	369.50	45.68	-3.12	42.56	46.00	-3.44	Peak	VERTICAL
2	375.32	43.10	-2.91	40.19	46.00	-5.81	Peak	VERTICAL
3	399.57	43.38	-2.54	40.84	46.00	-5.16	Peak	VERTICAL
4	444.19	43.55	-1.11	42.44	46.00	-3.56	Peak	VERTICAL
5	625.58	41.71	2.00	43.71	46.00	-2.29	Peak	VERTICAL
6	888.45	36.93	5.96	42.89	46.00	-3.11	Peak	VERTICAL
1	216.24	46.46	-7.77	38.69	46.00	-7.31	Peak	HORIZONTAL
2	222.06	47.08	-7.93	39.15	46.00	-6.85	Peak	HORIZONTAL
3	243.40	46.66	-6.19	40.47	46.00	-5.53	Peak	HORIZONTAL
4	369.50	43.74	-3.12	40.62	46.00	-5.38	Peak	HORIZONTAL
5	591.63	39.67	1.55	41.22	46.00	-4.78	Peak	HORIZONTAL
6	888.45	36.60	5.96	42.56	46.00	-3.44	Peak	HORIZONTAL

Remark:

- 1 No further spurious emissions detected from the lowest internal frequency and 30MHz.
- 2 Measuring frequencies from the lowest internal frequency to the 1GHz.
- 3 Radiated emissions measured in frequency range from 9kHz to 1000MHz were made with an instrument detector setting 9-90kHz/110-490kHz using PK/AV and other Frequency Band using PK/QP
- 4 Measurement result within this frequency range shown “ - ” in the table above means the reading of emissions are attenuated more than 20dB below the permissible limits or the field strength is too small to be measured.

**Radiated Spurious Emission Measurement Result (below 1GHz) (802.11g mode)**

Operation Mode	TX mode	Test Date	2022/09/27
Channel number	CH Mid	Test By	Barry
Temperature	25	Pol	Ver./Hor
Humidity	60 %		

No	Freq MHz	Reading dBuV	Factor dB	Level dBuV/m	Limit dBuV/m	Margin dB	Remark	Pol V/H
1	369.50	46.36	-3.12	43.24	46.00	-2.76	Peak	VERTICAL
2	375.32	45.04	-2.91	42.13	46.00	-3.87	Peak	VERTICAL
3	399.57	44.36	-2.54	41.82	46.00	-4.18	Peak	VERTICAL
4	444.19	45.31	-1.11	44.20	46.00	-1.80	Peak	VERTICAL
5	625.58	37.92	2.00	39.92	46.00	-6.08	Peak	VERTICAL
6	888.45	36.66	5.96	42.62	46.00	-3.38	Peak	VERTICAL
1	216.24	47.05	-7.77	39.28	46.00	-6.72	Peak	HORIZONTAL
2	222.06	48.91	-7.93	40.98	46.00	-5.02	Peak	HORIZONTAL
3	256.24	48.92	-5.75	43.17	46.00	-2.83	Peak	HORIZONTAL
4	369.50	45.13	-3.12	42.01	46.00	-3.99	Peak	HORIZONTAL
5	591.63	40.69	1.55	42.24	46.00	-3.76	Peak	HORIZONTAL
6	888.45	34.68	5.96	40.64	46.00	-5.36	Peak	HORIZONTAL

Remark:

- 1 No further spurious emissions detected from the lowest internal frequency and 30MHz.
- 2 Measuring frequencies from the lowest internal frequency to the 1GHz.
- 3 Radiated emissions measured in frequency range from 9kHz to 1000MHz were made with an instrument detector setting 9-90kHz/110-490kHz using PK/AV and other Frequency Band using PK/QP
- 4 Measurement result within this frequency range shown “ - ” in the table above means the reading of emissions are attenuated more than 20dB below the permissible limits or the field strength is too small to be measured.

**Radiated Spurious Emission Measurement Result (below 1GHz) (802.11g mode)**

Operation Mode	TX mode	Test Date	2022/09/27
Channel number	CH High	Test By	Barry
Temperature	25	Pol	Ver./Hor
Humidity	60 %		

No	Freq MHz	Reading dBuV	Factor dB	Level dBuV/m	Limit dBuV/m	Margin dB	Remark	Pol V/H
1	369.50	44.60	-3.12	41.48	46.00	-4.52	Peak	VERTICAL
2	375.32	43.13	-2.91	40.22	46.00	-5.78	Peak	VERTICAL
3	399.57	42.13	-2.54	39.59	46.00	-6.41	Peak	VERTICAL
4	444.19	44.55	-1.11	43.44	46.00	-2.56	Peak	VERTICAL
5	625.58	39.84	2.00	41.84	46.00	-4.16	Peak	VERTICAL
6	888.45	35.45	5.96	41.41	46.00	-4.59	Peak	VERTICAL
1	216.24	44.84	-7.77	37.07	46.00	-8.93	Peak	HORIZONTAL
2	222.06	46.29	-7.93	38.36	46.00	-7.64	Peak	HORIZONTAL
3	295.78	44.37	-4.21	40.16	46.00	-5.84	Peak	HORIZONTAL
4	369.50	45.72	-3.12	42.60	46.00	-3.40	Peak	HORIZONTAL
5	591.63	41.60	1.55	43.15	46.00	-2.85	Peak	HORIZONTAL
6	600.36	38.76	1.79	40.55	46.00	-5.45	Peak	HORIZONTAL

Remark:

- 1 No further spurious emissions detected from the lowest internal frequency and 30MHz.
- 2 Measuring frequencies from the lowest internal frequency to the 1GHz.
- 3 Radiated emissions measured in frequency range from 9kHz to 1000MHz were made with an instrument detector setting 9-90kHz/110-490kHz using PK/AV and other Frequency Band using PK/QP
- 4 Measurement result within this frequency range shown “ - ” in the table above means the reading of emissions are attenuated more than 20dB below the permissible limits or the field strength is too small to be measured.



**Radiated Spurious Emission Measurement Result (below 1GHz) (802.11n HT20 mode)**

Operation Mode	TX mode	Test Date	2022/09/27
Channel number	CH Low	Test By	Barry
Temperature	25	Pol	Ver./Hor
Humidity	60 %		

No	Freq MHz	Reading dBuV	Factor dB	Level dBuV/m	Limit dBuV/m	Margin dB	Remark	Pol V/H
1	369.50	44.75	-3.12	41.63	46.00	-4.37	Peak	VERTICAL
2	375.32	45.79	-2.91	42.88	46.00	-3.12	Peak	VERTICAL
3	399.57	43.89	-2.54	41.35	46.00	-4.65	Peak	VERTICAL
4	444.19	44.74	-1.11	43.63	46.00	-2.37	Peak	VERTICAL
5	625.58	37.63	2.00	39.63	46.00	-6.37	Peak	VERTICAL
6	888.45	32.53	5.96	38.49	46.00	-7.51	Peak	VERTICAL
1	216.24	49.43	-7.77	41.66	46.00	-4.34	Peak	HORIZONTAL
2	222.06	49.28	-7.93	41.35	46.00	-4.65	Peak	HORIZONTAL
3	243.40	45.32	-6.19	39.13	46.00	-6.87	Peak	HORIZONTAL
4	369.50	42.52	-3.12	39.40	46.00	-6.60	Peak	HORIZONTAL
5	592.60	41.28	1.58	42.86	46.00	-3.14	Peak	HORIZONTAL
6	888.45	37.17	5.96	43.13	46.00	-2.87	Peak	HORIZONTAL

Remark:

- 1 No further spurious emissions detected from the lowest internal frequency and 30MHz.
- 2 Measuring frequencies from the lowest internal frequency to the 1GHz.
- 3 Radiated emissions measured in frequency range from 9kHz to 1000MHz were made with an instrument detector setting 9-90kHz/110-490kHz using PK/AV and other Frequency Band using PK/QP
- 4 Measurement result within this frequency range shown “ - ” in the table above means the reading of emissions are attenuated more than 20dB below the permissible limits or the field strength is too small to be measured.

**Radiated Spurious Emission Measurement Result (below 1GHz) (802.11n HT20 mode)**

Operation Mode	TX mode	Test Date	2022/09/27
Channel number	CH Mid	Test By	Barry
Temperature	25	Pol	Ver./Hor
Humidity	60 %		

No	Freq MHz	Reading dBuV	Factor dB	Level dBuV/m	Limit dBuV/m	Margin dB	Remark	Pol V/H
1	369.50	46.44	-3.12	43.32	46.00	-2.68	Peak	VERTICAL
2	375.32	43.86	-2.91	40.95	46.00	-5.05	Peak	VERTICAL
3	399.57	44.40	-2.54	41.86	46.00	-4.14	Peak	VERTICAL
4	444.19	45.34	-1.11	44.23	46.00	-1.77	Peak	VERTICAL
5	625.58	41.05	2.00	43.05	46.00	-2.95	Peak	VERTICAL
6	888.45	36.27	5.96	42.23	46.00	-3.77	Peak	VERTICAL
1	216.24	45.32	-7.77	37.55	46.00	-8.45	Peak	HORIZONTAL
2	222.06	46.26	-7.93	38.33	46.00	-7.67	Peak	HORIZONTAL
3	369.50	46.13	-3.12	43.01	46.00	-2.99	Peak	HORIZONTAL
4	591.63	38.94	1.55	40.49	46.00	-5.51	Peak	HORIZONTAL
5	796.30	35.50	5.01	40.51	46.00	-5.49	Peak	HORIZONTAL
6	888.45	36.60	5.96	42.56	46.00	-3.44	Peak	HORIZONTAL

Remark:

- 1 No further spurious emissions detected from the lowest internal frequency and 30MHz.
- 2 Measuring frequencies from the lowest internal frequency to the 1GHz.
- 3 Radiated emissions measured in frequency range from 9kHz to 1000MHz were made with an instrument detector setting 9-90kHz/110-490kHz using PK/AV and other Frequency Band using PK/QP
- 4 Measurement result within this frequency range shown “ - ” in the table above means the reading of emissions are attenuated more than 20dB below the permissible limits or the field strength is too small to be measured.

**Radiated Spurious Emission Measurement Result (below 1GHz) (802.11n HT20 mode)**

Operation Mode	TX mode	Test Date	2022/09/27
Channel number	CH High	Test By	Barry
Temperature	25	Pol	Ver./Hor
Humidity	60 %		

No	Freq MHz	Reading dBuV	Factor dB	Level dBuV/m	Limit dBuV/m	Margin dB	Remark	Pol V/H
1	369.50	45.25	-3.12	42.13	46.00	-3.87	Peak	VERTICAL
2	375.32	43.74	-2.91	40.83	46.00	-5.17	Peak	VERTICAL
3	399.57	43.82	-2.54	41.28	46.00	-4.72	Peak	VERTICAL
4	444.19	43.94	-1.11	42.83	46.00	-3.17	Peak	VERTICAL
5	625.58	41.77	2.00	43.77	46.00	-2.23	Peak	VERTICAL
6	888.45	34.44	5.96	40.40	46.00	-5.60	Peak	VERTICAL
1	216.24	46.98	-7.77	39.21	46.00	-6.79	Peak	HORIZONTAL
2	222.06	49.30	-7.93	41.37	46.00	-4.63	Peak	HORIZONTAL
3	243.40	45.07	-6.19	38.88	46.00	-7.12	Peak	HORIZONTAL
4	369.50	44.46	-3.12	41.34	46.00	-4.66	Peak	HORIZONTAL
5	591.63	36.49	1.55	38.04	46.00	-7.96	Peak	HORIZONTAL
6	888.45	36.30	5.96	42.26	46.00	-3.74	Peak	HORIZONTAL

Remark:

- 1 No further spurious emissions detected from the lowest internal frequency and 30MHz.
- 2 Measuring frequencies from the lowest internal frequency to the 1GHz.
- 3 Radiated emissions measured in frequency range from 9kHz to 1000MHz were made with an instrument detector setting 9-90kHz/110-490kHz using PK/AV and other Frequency Band using PK/QP
- 4 Measurement result within this frequency range shown “ - ” in the table above means the reading of emissions are attenuated more than 20dB below the permissible limits or the field strength is too small to be measured.

**Radiated Spurious Emission Measurement Result (below 1GHz) (802.11n HT40 mode)**

Operation Mode	TX mode	Test Date	2022/09/27
Channel number	CH Low	Test By	Barry
Temperature	25	Pol	Ver./Hor
Humidity	60 %		

No	Freq MHz	Reading dBuV	Factor dB	Level dBuV/m	Limit dBuV/m	Margin dB	Remark	Pol V/H
1	369.50	44.78	-3.12	41.66	46.00	-4.34	Peak	VERTICAL
2	375.32	42.87	-2.91	39.96	46.00	-6.04	Peak	VERTICAL
3	399.57	44.57	-2.54	42.03	46.00	-3.97	Peak	VERTICAL
4	444.19	44.36	-1.11	43.25	46.00	-2.75	Peak	VERTICAL
5	625.58	40.71	2.00	42.71	46.00	-3.29	Peak	VERTICAL
6	888.45	35.65	5.96	41.61	46.00	-4.39	Peak	VERTICAL
1	216.24	47.81	-7.77	40.04	46.00	-5.96	Peak	HORIZONTAL
2	222.06	51.36	-7.93	43.43	46.00	-2.57	Peak	HORIZONTAL
3	243.40	45.97	-6.19	39.78	46.00	-6.22	Peak	HORIZONTAL
4	369.50	47.25	-3.12	44.13	46.00	-1.87	Peak	HORIZONTAL
5	591.63	41.47	1.55	43.02	46.00	-2.98	Peak	HORIZONTAL
6	625.58	39.57	2.00	41.57	46.00	-4.43	Peak	HORIZONTAL

Remark:

- 1 No further spurious emissions detected from the lowest internal frequency and 30MHz.
- 2 Measuring frequencies from the lowest internal frequency to the 1GHz.
- 3 Radiated emissions measured in frequency range from 9kHz to 1000MHz were made with an instrument detector setting 9-90kHz/110-490kHz using PK/AV and other Frequency Band using PK/QP
- 4 Measurement result within this frequency range shown “ - ” in the table above means the reading of emissions are attenuated more than 20dB below the permissible limits or the field strength is too small to be measured.

**Radiated Spurious Emission Measurement Result (below 1GHz) (802.11n HT40 mode)**

Operation Mode	TX mode	Test Date	2022/09/27
Channel number	CH Mid	Test By	Barry
Temperature	25	Pol	Ver./Hor
Humidity	60 %		

No	Freq MHz	Reading dBuV	Factor dB	Level dBuV/m	Limit dBuV/m	Margin dB	Remark	Pol V/H
1	332.64	44.84	-3.36	41.48	46.00	-4.52	Peak	VERTICAL
2	369.50	45.02	-3.12	41.90	46.00	-4.10	Peak	VERTICAL
3	399.57	44.52	-2.54	41.98	46.00	-4.02	Peak	VERTICAL
4	444.19	45.21	-1.11	44.10	46.00	-1.90	Peak	VERTICAL
5	625.58	40.14	2.00	42.14	46.00	-3.86	Peak	VERTICAL
6	888.45	35.67	5.96	41.63	46.00	-4.37	Peak	VERTICAL
1	216.24	45.86	-7.77	38.09	46.00	-7.91	Peak	HORIZONTAL
2	222.06	49.22	-7.93	41.29	46.00	-4.71	Peak	HORIZONTAL
3	369.50	45.71	-3.12	42.59	46.00	-3.41	Peak	HORIZONTAL
4	399.57	42.83	-2.54	40.29	46.00	-5.71	Peak	HORIZONTAL
5	591.63	39.33	1.55	40.88	46.00	-5.12	Peak	HORIZONTAL
6	888.45	33.85	5.96	39.81	46.00	-6.19	Peak	HORIZONTAL

Remark:

- 1 No further spurious emissions detected from the lowest internal frequency and 30MHz.
- 2 Measuring frequencies from the lowest internal frequency to the 1GHz.
- 3 Radiated emissions measured in frequency range from 9kHz to 1000MHz were made with an instrument detector setting 9-90kHz/110-490kHz using PK/AV and other Frequency Band using PK/QP
- 4 Measurement result within this frequency range shown “ - ” in the table above means the reading of emissions are attenuated more than 20dB below the permissible limits or the field strength is too small to be measured.

**Radiated Spurious Emission Measurement Result (below 1GHz) (802.11n HT40 mode)**

Operation Mode	TX mode	Test Date	2022/09/27
Channel number	CH High	Test By	Barry
Temperature	25	Pol	Ver./Hor
Humidity	60 %		

No	Freq MHz	Reading dBuV	Factor dB	Level dBuV/m	Limit dBuV/m	Margin dB	Remark	Pol V/H
1	332.64	42.02	-3.36	38.66	46.00	-7.34	Peak	VERTICAL
2	369.50	43.68	-3.12	40.56	46.00	-5.44	Peak	VERTICAL
3	399.57	42.43	-2.54	39.89	46.00	-6.11	Peak	VERTICAL
4	444.19	44.34	-1.11	43.23	46.00	-2.77	Peak	VERTICAL
5	625.58	40.11	2.00	42.11	46.00	-3.89	Peak	VERTICAL
6	888.45	35.91	5.96	41.87	46.00	-4.13	Peak	VERTICAL
1	216.24	46.78	-7.77	39.01	46.00	-6.99	Peak	HORIZONTAL
2	222.06	47.86	-7.93	39.93	46.00	-6.07	Peak	HORIZONTAL
3	369.50	45.82	-3.12	42.70	46.00	-3.30	Peak	HORIZONTAL
4	591.63	40.34	1.55	41.89	46.00	-4.11	Peak	HORIZONTAL
5	783.69	39.07	4.65	43.72	46.00	-2.28	Peak	HORIZONTAL
6	888.45	38.06	5.96	44.02	46.00	-1.98	Peak	HORIZONTAL

Remark:

- 1 No further spurious emissions detected from the lowest internal frequency and 30MHz.
- 2 Measuring frequencies from the lowest internal frequency to the 1GHz.
- 3 Radiated emissions measured in frequency range from 9kHz to 1000MHz were made with an instrument detector setting 9-90kHz/110-490kHz using PK/AV and other Frequency Band using PK/QP
- 4 Measurement result within this frequency range shown “ - ” in the table above means the reading of emissions are attenuated more than 20dB below the permissible limits or the field strength is too small to be measured.

**Radiated Spurious Emission Measurement Result (above 1GHz) (802.11b mode)**

Operation Mode	TX mode	Test Date	2022/09/27
Channel number	CH Low	Test By	Barry
Temperature	25	Pol	Ver./Hor
Humidity	60 %		

No	Freq MHz	Reading dBuV	Factor dB	Level dBuV/m	Limit dBuV/m	Margin dB	Remark	Pol V/H
1	4824.00	45.39	-5.83	39.56	74.00	-34.44	Peak	VERTICAL
2	7236.00	48.28	-2.23	46.05	74.00	-27.95	Peak	VERTICAL
1	4824.00	46.23	-5.83	40.40	74.00	-33.60	Peak	HORIZONTAL
2	7236.00	48.81	-2.23	46.58	74.00	-27.42	Peak	HORIZONTAL

Remark:

- 1 Measuring frequencies from the lowest internal frequency to the 10th of fundamental frequency
- 2 Field strength limits for frequency above 1000MHz are based on average limits. However, Peak mode field strength shall not exceed the average limits specified plus 20dB.
- 3 Measurement of data within this frequency range shown “ - ” in the table above means the reading of emissions are attenuated more than 20dB below the permissible limits or the field strength is too small to be measured.

**Radiated Spurious Emission Measurement Result (above 1GHz) (802.11b mode)**

Operation Mode	TX mode	Test Date	2022/09/27
Channel number	CH Mid	Test By	Barry
Temperature	25	Pol	Ver./Hor
Humidity	60 %		

No	Freq MHz	Reading dBuV	Factor dB	Level dBuV/m	Limit dBuV/m	Margin dB	Remark	Pol V/H
1	4874.00	45.54	-5.77	39.77	74.00	-34.23	Peak	VERTICAL
2	7311.00	44.85	-2.24	42.61	74.00	-31.39	Peak	VERTICAL
1	4874.00	46.13	-5.77	40.36	74.00	-33.64	Peak	HORIZONTAL
2	7311.00	45.61	-2.24	43.37	74.00	-30.63	Peak	HORIZONTAL

Remark:

- 1 Measuring frequencies from the lowest internal frequency to the 10th of fundamental frequency
- 2 Field strength limits for frequency above 1000MHz are based on average limits. However, Peak mode field strength shall not exceed the average limits specified plus 20dB.
- 3 Measurement of data within this frequency range shown “ - ” in the table above means the reading of emissions are attenuated more than 20dB below the permissible limits or the field strength is too small to be measured.



**Radiated Spurious Emission Measurement Result (above 1GHz) (802.11b mode)**

Operation Mode	TX mode	Test Date	2022/09/27
Channel number	CH High	Test By	Barry
Temperature	25	Pol	Ver./Hor
Humidity	60 %		

No	Freq MHz	Reading dBuV	Factor dB	Level dBuV/m	Limit dBuV/m	Margin dB	Remark	Pol V/H
1	4924.00	45.34	-5.67	39.67	74.00	-34.33	Peak	VERTICAL
2	7386.00	44.37	-2.09	42.28	74.00	-31.72	Peak	VERTICAL
1	4924.00	45.84	-5.67	40.17	74.00	-33.83	Peak	HORIZONTAL
2	7386.00	44.96	-2.09	42.87	74.00	-31.13	Peak	HORIZONTAL

Remark:

- 1 Measuring frequencies from the lowest internal frequency to the 10th of fundamental frequency
- 2 Field strength limits for frequency above 1000MHz are based on average limits. However, Peak mode field strength shall not exceed the average limits specified plus 20dB.
- 3 Measurement of data within this frequency range shown “ - ” in the table above means the reading of emissions are attenuated more than 20dB below the permissible limits or the field strength is too small to be measured.

**Radiated Spurious Emission Measurement Result (above 1GHz) (802.11g mode)**

Operation Mode	TX mode	Test Date	2022/09/27
Channel number	CH Low	Test By	Barry
Temperature	25	Pol	Ver./Hor
Humidity	60 %		

No	Freq MHz	Reading dBuV	Factor dB	Level dBuV/m	Limit dBuV/m	Margin dB	Remark	Pol V/H
1	4824.00	44.30	-5.83	38.47	74.00	-35.53	Peak	VERTICAL
2	7236.00	44.51	-2.23	42.28	74.00	-31.72	Peak	VERTICAL
1	4824.00	44.30	-5.83	38.47	74.00	-35.53	Peak	HORIZONTAL
2	7236.00	45.99	-2.23	43.76	74.00	-30.24	Peak	HORIZONTAL

Remark:

- 1 Measuring frequencies from the lowest internal frequency to the 10th of fundamental frequency
- 2 Field strength limits for frequency above 1000MHz are based on average limits. However, Peak mode field strength shall not exceed the average limits specified plus 20dB.
- 3 Measurement of data within this frequency range shown “ - ” in the table above means the reading of emissions are attenuated more than 20dB below the permissible limits or the field strength is too small to be measured.

**Radiated Spurious Emission Measurement Result (above 1GHz) (802.11g mode)**

Operation Mode	TX mode	Test Date	2022/09/27
Channel number	CH Mid	Test By	Barry
Temperature	25	Pol	Ver./Hor
Humidity	60 %		

No	Freq MHz	Reading dBuV	Factor dB	Level dBuV/m	Limit dBuV/m	Margin dB	Remark	Pol V/H
1	4874.00	46.16	-5.77	40.39	74.00	-33.61	Peak	VERTICAL
2	7311.00	44.61	-2.24	42.37	74.00	-31.63	Peak	VERTICAL
1	4874.00	45.51	-5.77	39.74	74.00	-34.26	Peak	HORIZONTAL
2	7311.00	45.78	-2.24	43.54	74.00	-30.46	Peak	HORIZONTAL

Remark:

- 1 Measuring frequencies from the lowest internal frequency to the 10th of fundamental frequency
- 2 Field strength limits for frequency above 1000MHz are based on average limits. However, Peak mode field strength shall not exceed the average limits specified plus 20dB.
- 3 Measurement of data within this frequency range shown “ - ” in the table above means the reading of emissions are attenuated more than 20dB below the permissible limits or the field strength is too small to be measured.

**Radiated Spurious Emission Measurement Result (above 1GHz) (802.11g mode)**

Operation Mode	TX mode	Test Date	2022/09/27
Channel number	CH High	Test By	Barry
Temperature	25	Pol	Ver./Hor
Humidity	60 %		

No	Freq MHz	Reading dBuV	Factor dB	Level dBuV/m	Limit dBuV/m	Margin dB	Remark	Pol V/H
1	4924.00	44.46	-5.67	38.79	74.00	-35.21	Peak	VERTICAL
2	7386.00	46.68	-2.09	44.59	74.00	-29.41	Peak	VERTICAL
1	4924.00	44.69	-5.67	39.02	74.00	-34.98	Peak	HORIZONTAL
2	7386.00	48.05	-2.09	45.96	74.00	-28.04	Peak	HORIZONTAL

Remark:

- 1 Measuring frequencies from the lowest internal frequency to the 10th of fundamental frequency
- 2 Field strength limits for frequency above 1000MHz are based on average limits. However, Peak mode field strength shall not exceed the average limits specified plus 20dB.
- 3 Measurement of data within this frequency range shown “ - ” in the table above means the reading of emissions are attenuated more than 20dB below the permissible limits or the field strength is too small to be measured.

**Radiated Spurious Emission Measurement Result (above 1GHz) (802.11n HT20 mode)**

Operation Mode	TX mode	Test Date	2022/09/27
Channel number	CH Low	Test By	Barry
Temperature	25	Pol	Ver./Hor
Humidity	60 %		

No	Freq MHz	Reading dBuV	Factor dB	Level dBuV/m	Limit dBuV/m	Margin dB	Remark	Pol V/H
1	4824.00	47.22	-5.83	41.39	74.00	-32.61	Peak	VERTICAL
2	7236.00	48.26	-2.23	46.03	74.00	-27.97	Peak	VERTICAL
1	4824.00	47.72	-5.83	41.89	74.00	-32.11	Peak	HORIZONTAL
2	7236.00	44.87	-2.23	42.64	74.00	-31.36	Peak	HORIZONTAL

Remark:

- 1 Measuring frequencies from the lowest internal frequency to the 10th of fundamental frequency
- 2 Field strength limits for frequency above 1000MHz are based on average limits. However, Peak mode field strength shall not exceed the average limits specified plus 20dB.
- 3 Measurement of data within this frequency range shown “ - ” in the table above means the reading of emissions are attenuated more than 20dB below the permissible limits or the field strength is too small to be measured.

**Radiated Spurious Emission Measurement Result (above 1GHz) (802.11n HT20 mode)**

Operation Mode	TX mode	Test Date	2022/09/27
Channel number	CH Mid	Test By	Barry
Temperature	25	Pol	Ver./Hor
Humidity	60 %		

No	Freq MHz	Reading dBuV	Factor dB	Level dBuV/m	Limit dBuV/m	Margin dB	Remark	Pol V/H
1	4874.00	44.02	-5.77	38.25	74.00	-35.75	Peak	VERTICAL
2	7311.00	44.66	-2.24	42.42	74.00	-31.58	Peak	VERTICAL
1	4874.00	46.54	-5.77	40.77	74.00	-33.23	Peak	HORIZONTAL
2	7311.00	44.37	-2.24	42.13	74.00	-31.87	Peak	HORIZONTAL

Remark:

- 1 Measuring frequencies from the lowest internal frequency to the 10th of fundamental frequency
- 2 Field strength limits for frequency above 1000MHz are based on average limits. However, Peak mode field strength shall not exceed the average limits specified plus 20dB.
- 3 Measurement of data within this frequency range shown “ - ” in the table above means the reading of emissions are attenuated more than 20dB below the permissible limits or the field strength is too small to be measured.

**Radiated Spurious Emission Measurement Result (above 1GHz) (802.11n HT20 mode)**

Operation Mode	TX mode	Test Date	2022/09/27
Channel number	CH High	Test By	Barry
Temperature	25	Pol	Ver./Hor
Humidity	60 %		

No	Freq MHz	Reading dBuV	Factor dB	Level dBuV/m	Limit dBuV/m	Margin dB	Remark	Pol V/H
1	4924.00	47.08	-5.67	41.41	74.00	-32.59	Peak	VERTICAL
2	7386.00	46.60	-2.09	44.51	74.00	-29.49	Peak	VERTICAL
1	4924.00	47.53	-5.67	41.86	74.00	-32.14	Peak	HORIZONTAL
2	7386.00	44.87	-2.09	42.78	74.00	-31.22	Peak	HORIZONTAL

Remark:

- 1 Measuring frequencies from the lowest internal frequency to the 10th of fundamental frequency
- 2 Field strength limits for frequency above 1000MHz are based on average limits. However, Peak mode field strength shall not exceed the average limits specified plus 20dB.
- 3 Measurement of data within this frequency range shown “ - ” in the table above means the reading of emissions are attenuated more than 20dB below the permissible limits or the field strength is too small to be measured.

**Radiated Spurious Emission Measurement Result (above 1GHz) (802.11n HT40 mode)**

Operation Mode	TX mode	Test Date	2022/09/27
Channel number	CH Low	Test By	Barry
Temperature	25	Pol	Ver./Hor
Humidity	60 %		

No	Freq MHz	Reading dBuV	Factor dB	Level dBuV/m	Limit dBuV/m	Margin dB	Remark	Pol V/H
1	4844.00	45.70	-5.81	39.89	74.00	-34.11	Peak	VERTICAL
2	7266.00	45.79	-2.25	43.54	74.00	-30.46	Peak	VERTICAL
1	4844.00	47.83	-5.81	42.02	74.00	-31.98	Peak	HORIZONTAL
2	7266.00	46.53	-2.25	44.28	74.00	-29.72	Peak	HORIZONTAL

Remark:

- 1 Measuring frequencies from the lowest internal frequency to the 10th of fundamental frequency
- 2 Field strength limits for frequency above 1000MHz are based on average limits. However, Peak mode field strength shall not exceed the average limits specified plus 20dB.
- 3 Measurement of data within this frequency range shown “ - ” in the table above means the reading of emissions are attenuated more than 20dB below the permissible limits or the field strength is too small to be measured.



**Radiated Spurious Emission Measurement Result (above 1GHz) (802.11n HT40 mode)**

Operation Mode	TX mode	Test Date	2022/09/27
Channel number	CH Mid	Test By	Barry
Temperature	25	Pol	Ver./Hor
Humidity	60 %		

No	Freq MHz	Reading dBuV	Factor dB	Level dBuV/m	Limit dBuV/m	Margin dB	Remark	Pol V/H
1	4874.00	44.51	-5.77	38.74	74.00	-35.26	Peak	VERTICAL
2	7311.00	47.22	-2.24	44.98	74.00	-29.02	Peak	VERTICAL
1	4874.00	49.25	-5.77	43.48	74.00	-30.52	Peak	HORIZONTAL
2	7311.00	47.59	-2.24	45.35	74.00	-28.65	Peak	HORIZONTAL

Remark:

- 1 Measuring frequencies from the lowest internal frequency to the 10th of fundamental frequency
- 2 Field strength limits for frequency above 1000MHz are based on average limits. However, Peak mode field strength shall not exceed the average limits specified plus 20dB.
- 3 Measurement of data within this frequency range shown “ - ” in the table above means the reading of emissions are attenuated more than 20dB below the permissible limits or the field strength is too small to be measured.

**Radiated Spurious Emission Measurement Result (above 1GHz) (802.11n HT40 mode)**

Operation Mode	TX mode	Test Date	2022/09/27
Channel number	CH High	Test By	Barry
Temperature	25	Pol	Ver./Hor
Humidity	60 %		

No	Freq MHz	Reading dBuV	Factor dB	Level dBuV/m	Limit dBuV/m	Margin dB	Remark	Pol V/H
1	4904.00	50.63	-5.73	44.90	74.00	-29.10	Peak	VERTICAL
2	7356.00	47.66	-2.21	45.45	74.00	-28.55	Peak	VERTICAL
1	4904.00	48.30	-5.73	42.57	74.00	-31.43	Peak	HORIZONTAL
2	7356.00	46.01	-2.21	43.80	74.00	-30.20	Peak	HORIZONTAL

Remark:

- 1 Measuring frequencies from the lowest internal frequency to the 10th of fundamental frequency
- 2 Field strength limits for frequency above 1000MHz are based on average limits. However, Peak mode field strength shall not exceed the average limits specified plus 20dB.
- 3 Measurement of data within this frequency range shown “ - ” in the table above means the reading of emissions are attenuated more than 20dB below the permissible limits or the field strength is too small to be measured.

**Radiated Spurious Emission Measurement Result (below 1GHz) BLE Mode**

Operation Mode	TX mode	Test Date	2022/09/27
Channel number	CH Low	Test By	Barry
Temperature	25	Pol	Ver./Hor
Humidity	60 %		

No	Freq MHz	Reading dBuV	Factor dB	Level dBuV/m	Limit dBuV/m	Margin dB	Remark	Pol V/H
1	369.50	45.67	-3.12	42.55	46.00	-3.45	Peak	VERTICAL
2	375.32	44.89	-2.91	41.98	46.00	-4.02	Peak	VERTICAL
3	399.57	43.02	-2.54	40.48	46.00	-5.52	Peak	VERTICAL
4	444.19	44.16	-1.11	43.05	46.00	-2.95	Peak	VERTICAL
5	625.58	41.49	2.00	43.49	46.00	-2.51	Peak	VERTICAL
6	889.42	37.71	5.97	43.68	46.00	-2.32	Peak	VERTICAL
1	216.24	46.00	-7.77	38.23	46.00	-7.77	Peak	HORIZONTAL
2	222.06	49.72	-7.93	41.79	46.00	-4.21	Peak	HORIZONTAL
3	369.50	46.09	-3.12	42.97	46.00	-3.03	Peak	HORIZONTAL
4	591.63	41.12	1.55	42.67	46.00	-3.33	Peak	HORIZONTAL
5	784.66	37.50	4.65	42.15	46.00	-3.85	Peak	HORIZONTAL
6	888.45	34.48	5.96	40.44	46.00	-5.56	Peak	HORIZONTAL

Remark:

- 1 No further spurious emissions detected from the lowest internal frequency and 30MHz.
- 2 Measuring frequencies from the lowest internal frequency to the 1GHz.
- 3 Radiated emissions measured in frequency range from 9kHz to 1000MHz were made with an instrument detector setting 9-90kHz/110-490kHz using PK/AV and other Frequency Band using PK/QP
- 4 Measurement result within this frequency range shown “ - ” in the table above means the reading of emissions are attenuated more than 20dB below the permissible limits or the field strength is too small to be measured.

**Radiated Spurious Emission Measurement Result (below 1GHz) BLE Mode**

Operation Mode	TX mode	Test Date	2022/09/27
Channel number	CH Mid	Test By	Barry
Temperature	25	Pol	Ver./Hor
Humidity	60 %		

No	Freq MHz	Reading dBuV	Factor dB	Level dBuV/m	Limit dBuV/m	Margin dB	Remark	Pol V/H
1	369.50	40.71	-3.12	37.59	46.00	-8.41	Peak	VERTICAL
2	375.32	45.93	-2.91	43.02	46.00	-2.98	Peak	VERTICAL
3	399.57	38.96	-2.54	36.42	46.00	-9.58	Peak	VERTICAL
4	444.19	44.29	-1.11	43.18	46.00	-2.82	Peak	VERTICAL
5	625.58	37.56	2.00	39.56	46.00	-6.44	Peak	VERTICAL
6	888.45	35.67	5.96	41.63	46.00	-4.37	Peak	VERTICAL
1	216.24	49.20	-7.77	41.43	46.00	-4.57	Peak	HORIZONTAL
2	295.78	44.08	-4.21	39.87	46.00	-6.13	Peak	HORIZONTAL
3	369.50	45.91	-3.12	42.79	46.00	-3.21	Peak	HORIZONTAL
4	399.57	45.03	-2.54	42.49	46.00	-3.51	Peak	HORIZONTAL
5	591.63	40.02	1.55	41.57	46.00	-4.43	Peak	HORIZONTAL
6	888.45	35.62	5.96	41.58	46.00	-4.42	Peak	HORIZONTAL

Remark:

- 1 No further spurious emissions detected from the lowest internal frequency and 30MHz.
- 2 Measuring frequencies from the lowest internal frequency to the 1GHz.
- 3 Radiated emissions measured in frequency range from 9kHz to 1000MHz were made with an instrument detector setting 9-90kHz/110-490kHz using PK/AV and other Frequency Band using PK/QP
- 4 Measurement result within this frequency range shown “ - ” in the table above means the reading of emissions are attenuated more than 20dB below the permissible limits or the field strength is too small to be measured.

**Radiated Spurious Emission Measurement Result (below 1GHz) BLE Mode**

Operation Mode	TX mode	Test Date	2022/09/27
Channel number	CH High	Test By	Barry
Temperature	25	Pol	Ver./Hor
Humidity	60 %		

No	Freq MHz	Reading dBuV	Factor dB	Level dBuV/m	Limit dBuV/m	Margin dB	Remark	Pol V/H
1	369.50	45.79	-3.12	42.67	46.00	-3.33	Peak	VERTICAL
2	375.32	42.87	-2.91	39.96	46.00	-6.04	Peak	VERTICAL
3	399.57	44.95	-2.54	42.41	46.00	-3.59	Peak	VERTICAL
4	444.19	43.11	-1.11	42.00	46.00	-4.00	Peak	VERTICAL
5	625.58	42.62	2.00	44.62	46.00	-1.38	Peak	VERTICAL
6	888.45	35.45	5.96	41.41	46.00	-4.59	Peak	VERTICAL
1	216.24	45.97	-7.77	38.20	46.00	-7.80	Peak	HORIZONTAL
2	222.06	48.37	-7.93	40.44	46.00	-5.56	Peak	HORIZONTAL
3	369.50	42.61	-3.12	39.49	46.00	-6.51	Peak	HORIZONTAL
4	592.60	39.36	1.58	40.94	46.00	-5.06	Peak	HORIZONTAL
5	625.58	40.29	2.00	42.29	46.00	-3.71	Peak	HORIZONTAL
6	888.45	36.25	5.96	42.21	46.00	-3.79	Peak	HORIZONTAL

Remark:

- 1 No further spurious emissions detected from the lowest internal frequency and 30MHz.
- 2 Measuring frequencies from the lowest internal frequency to the 1GHz.
- 3 Radiated emissions measured in frequency range from 9kHz to 1000MHz were made with an instrument detector setting 9-90kHz/110-490kHz using PK/AV and other Frequency Band using PK/QP
- 4 Measurement result within this frequency range shown “ - ” in the table above means the reading of emissions are attenuated more than 20dB below the permissible limits or the field strength is too small to be measured.

**Radiated Spurious Emission Measurement Result (above 1GHz) BLE Mode**

Operation Mode	TX mode	Test Date	2022/09/27
Channel number	CH Low	Test By	Barry
Temperature	25	Pol	Ver./Hor
Humidity	60 %		

No	Freq MHz	Reading dBuV	Factor dB	Level dBuV/m	Limit dBuV/m	Margin dB	Remark	Pol V/H
1	4804.00	44.41	-5.85	38.56	74.00	-35.44	Peak	VERTICAL
2	7206.00	46.94	-2.17	44.77	74.00	-29.23	Peak	VERTICAL
1	4804.00	46.76	-5.85	40.91	74.00	-33.09	Peak	HORIZONTAL
2	7206.00	43.72	-2.17	41.55	74.00	-32.45	Peak	HORIZONTAL

**Remark:**

- 1 Measuring frequencies from the lowest internal frequency to the 10th of fundamental frequency
- 2 Field strength limits for frequency above 1000MHz are based on average limits. However, Peak mode field strength shall not exceed the average limits specified plus 20dB.
- 3 Measurement of data within this frequency range shown “ - ” in the table above means the reading of emissions are attenuated more than 20dB below the permissible limits or the field strength is too small to be measured.

**Radiated Spurious Emission Measurement Result (above 1GHz) BLE Mode**

Operation Mode	TX mode	Test Date	2022/09/27
Channel number	CH Mid	Test By	Barry
Temperature	25	Pol	Ver./Hor
Humidity	60 %		

No	Freq MHz	Reading dBuV	Factor dB	Level dBuV/m	Limit dBuV/m	Margin dB	Remark	Pol V/H
1	4884.00	49.68	-5.77	43.91	74.00	-30.09	Peak	VERTICAL
2	7326.00	46.52	-2.24	44.28	74.00	-29.72	Peak	VERTICAL
1	4884.00	47.04	-5.77	41.27	74.00	-32.73	Peak	HORIZONTAL
2	7326.00	45.96	-2.24	43.72	74.00	-30.28	Peak	HORIZONTAL

Remark:

- 1 Measuring frequencies from the lowest internal frequency to the 10th of fundamental frequency
- 2 Field strength limits for frequency above 1000MHz are based on average limits. However, Peak mode field strength shall not exceed the average limits specified plus 20dB.
- 3 Measurement of data within this frequency range shown “ - ” in the table above means the reading of emissions are attenuated more than 20dB below the permissible limits or the field strength is too small to be measured.

**Radiated Spurious Emission Measurement Result (above 1GHz) BLE Mode**

Operation Mode	TX mode	Test Date	2022/09/27
Channel number	CH High	Test By	Barry
Temperature	25	Pol	Ver./Hor
Humidity	60 %		

No	Freq MHz	Reading dBuV	Factor dB	Level dBuV/m	Limit dBuV/m	Margin dB	Remark	Pol V/H
1	4960.00	44.42	-5.57	38.85	74.00	-35.15	Peak	VERTICAL
2	7440.00	46.88	-2.09	44.79	74.00	-29.21	Peak	VERTICAL
1	4960.00	49.61	-5.57	44.04	74.00	-29.96	Peak	HORIZONTAL
2	7440.00	46.46	-2.09	44.37	74.00	-29.63	Peak	HORIZONTAL

Remark:

- 1 Measuring frequencies from the lowest internal frequency to the 10th of fundamental frequency
- 2 Field strength limits for frequency above 1000MHz are based on average limits. However, Peak mode field strength shall not exceed the average limits specified plus 20dB.
- 3 Measurement of data within this frequency range shown “ - ” in the table above means the reading of emissions are attenuated more than 20dB below the permissible limits or the field strength is too small to be measured.



## **9. 100kHz Bandwidth of Band Edges Measurement**

### **9.1 Standard Applicable:**

According to §15.247(d), in any 100 kHz bandwidth outside the frequency bands in which the spread spectrum intentional radiator is operating, the radio frequency power that is produced by the intentional radiator shall be at least 20dB below that in the 100kHz bandwidth within the band that contains the highest level of the desired power, In addition, radiated emissions which fall in the restricted bands, as defined in §15.205(a), must also comply with the radiated emission limits specified in §15.209(a).

### **9.2 Measurement Equipment Used:**

#### **9.2.1. Conducted Emission at antenna port:**

Refer to section 6.2 for details.

**9.2.2. Radiated emission:**

Location	Equipment Name	Brand	Model	S/N	Last Cal. Date	Next Cal. Date
Chamber 19	Signal analyzer	R&S	FSV40	101919	8/17/2022	8/17/2023
Chamber 19	EMI Receiver	R&S	ESR3	102461	05/10/2022	05/10/2023
Chamber 19	Loop Antenna	EM	EM-6879	271	09/29/2021	09/29/2022
Chamber 19	Bilog Antenna (30MHz-1GHz)	Schwarzbeck	VULB9168 w 6dB Att.	9168-736	03/09/2022	03/09/2023
Chamber 19	Horn antenna (1GHz-18GHz)	ETS	3117	00218718	10/12/2021	10/12/2022
Chamber 19	Horn antenna (18GHz-26GHz)	Com-power	AH-826	081001	11/30/2021	11/30/2022
Chamber 19	Horn antenna (26GHz-40GHz)	Com-power	AH-640	100A	03/18/2022	03/18/2023
Chamber 19	Preamplifier (9kHz-1GHz)	HP	8447F	3113A04621	06/24/2022	06/24/2023
Chamber 19	Preamplifier (1GHz - 26GHz)	EM	EM01M26G	060681	05/12/2022	05/12/2023
Chamber 19	Preamplifier (26GHz-40GHz)	MITEQ	JS4-26004000- 27-5A	818471	05/12/2022	05/12/2023
Chamber 19	RF Cable (100kHz-26.5GHz)	Huber Suhner & Woken	Sucoflex 104A & 18GHz SMA(M)-SM A(M)-10M	MY817/4A & 20200525	12/23/2021	12/23/2022
Chamber 19	RF Cable (18GHz-40GHz)	HUBER SU- HNER	Sucoflex 102	27963/2&374 21/2	11/17/2021	11/17/2022
Chamber 19	Signal Generator	Anritsu	MG3692A	20311	12/28/2021	12/28/2022
Chamber 19	Test Software	Audix	E3 Ver:6.12023	N/A	N/A	N/A

### 9.3 Test SET-UP:

The test item only performed radiated mode

(A) Radiated Emission Test Set-Up, Frequency Below 1000MHz

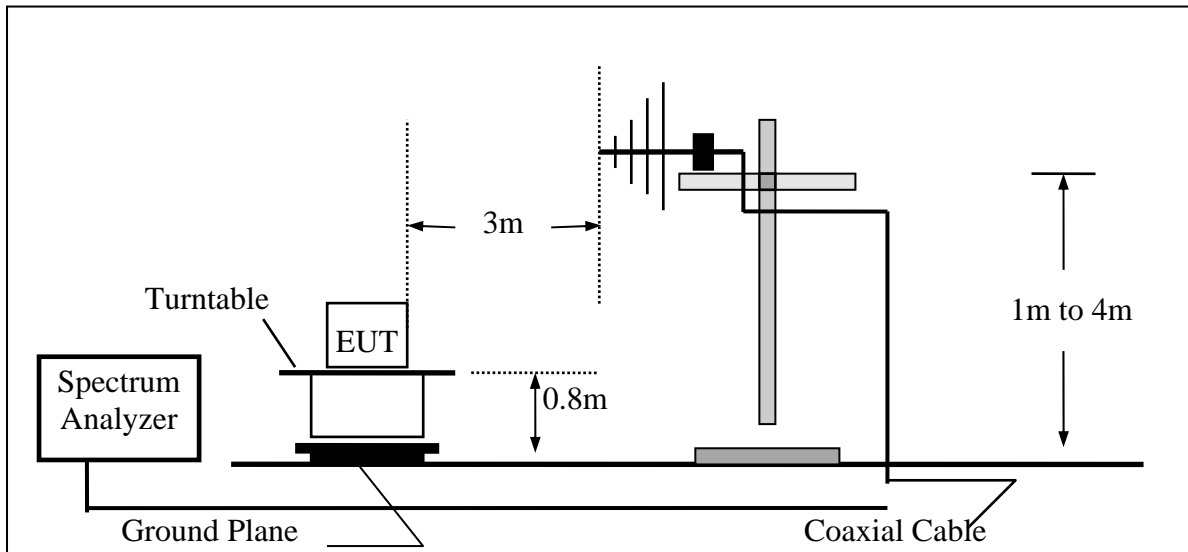

(B) Radiated Emission Test Set-Up Frequency Over 1 GHz

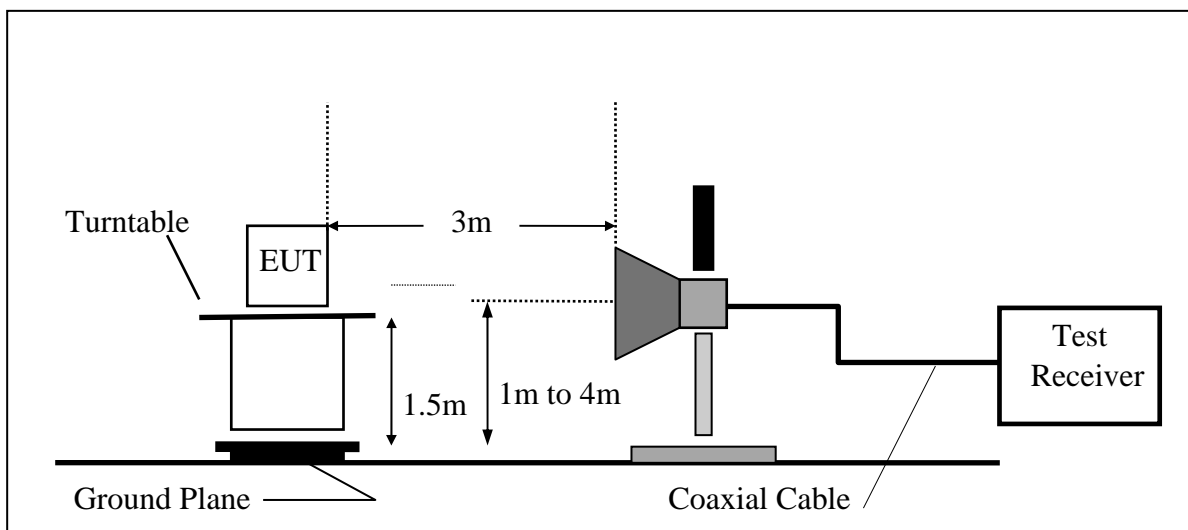

#### 9.4 Measurement Procedure:

1. Place the EUT on the table and set it in transmitting mode.
2. Remove the antenna from the EUT and then connect a low loss RF cable from the antenna port to the spectrum analyzer.
3. Set center frequency of spectrum analyzer = operating frequency.
4. Set the spectrum analyzer as RBW, VBW=100kHz, Span=25MHz, Sweep = auto
5. Mark Peak, 2.390GHz and 2.4835GHz and record the max. level.
6. Repeat above procedures until all frequency measured were complete.

#### 9.5 Field Strength Calculation:

The field strength is calculated by adding the Antenna Factor and Cable Factor and subtracting the Amplifier Gain and Duty Cycle Correction Factor(if any) from the measured reading. The basic equation with a sample calculation is as follows:

$$FS = RA + AF + CL - AG$$

Where	FS = Field Strength	CL = Cable Attenuation Factor (Cable Loss)
	RA = Reading Amplitude	AG = Amplifier Gain
	AF = Antenna Factor	

#### 9.6 Measurement Result:

Note: Refer to next page spectrum analyzer data chart and tabular data sheets.

**Radiated Emission: 802.11 b mode**

Operation Mode TX CH Low  
 Fundamental Frequency 2412 MHz  
 Temperature 25

Test Date 2022/09/27  
 Test By Barry  
 Humidity 60 %

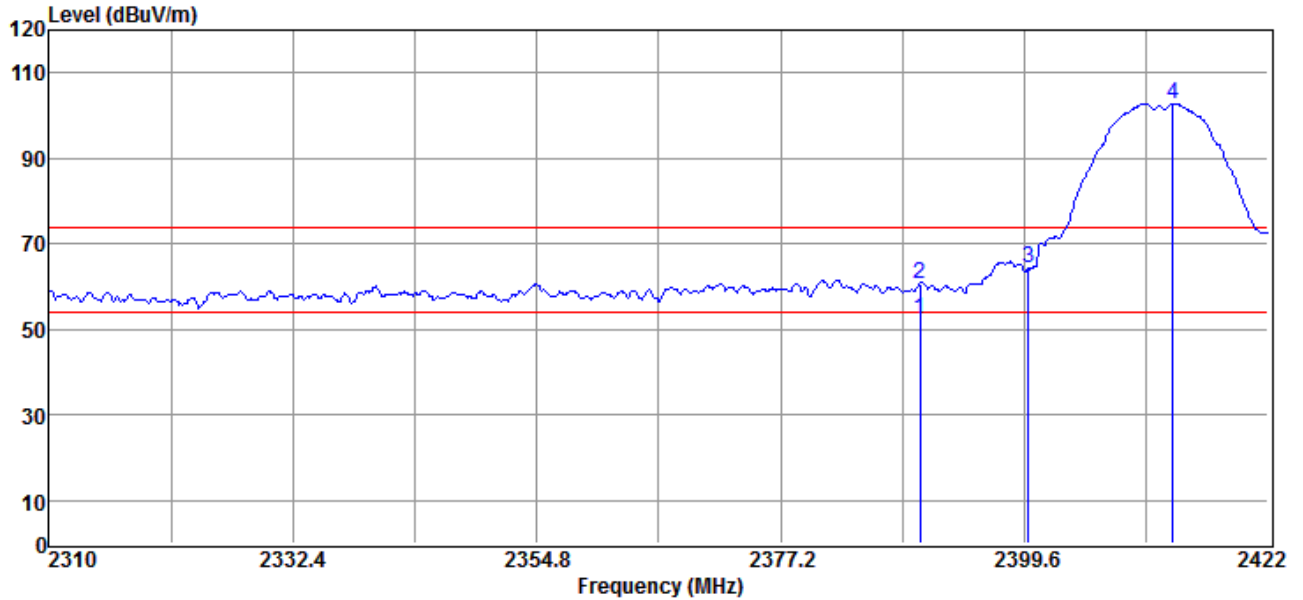

No	Freq MHz	Reading dBUV	Factor dB/m	Level dBUV/m	Limit dBUV/m	Margin dB	Remark	Pol V/H
1	2390.00	14.24	37.95	52.19	54.00	-1.81	Average	VERTICAL
2	2390.00	22.77	37.95	60.72	74.00	-13.28	Peak	VERTICAL
3	2400.00	26.11	38.05	64.16	82.78	-18.62	Peak	VERTICAL
4	2413.26	64.72	38.06	102.78	F	--	Peak	VERTICAL

Remark: F” denotes fundamental frequency

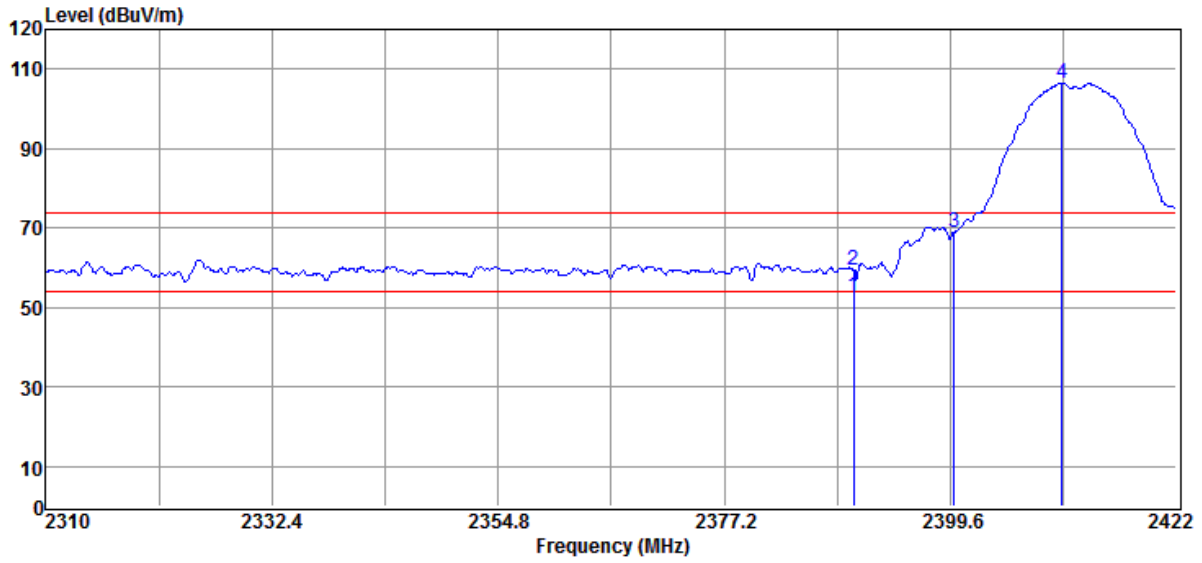

No	Freq MHz	Reading dBuV	Factor dB/m	Level dBuV/m	Limit dBuV/m	Margin dB	Remark	Pol V/H
1	2390.00	14.92	37.95	52.87	54.00	-1.13	Average	HORIZONTAL
2	2390.00	21.60	37.95	59.55	74.00	-14.45	Peak	HORIZONTAL
3	2400.00	30.80	38.05	68.85	86.48	-17.63	Peak	HORIZONTAL
4	2410.69	68.42	38.06	106.48	F	--	Peak	HORIZONTAL

Remark: F” denotes fundamental frequency

Operation Mode TX CH High  
 Fundamental Frequency 2462 MHz  
 Temperature 25

Test Date 2022/09/27  
 Test By Barry  
 Humidity 60 %

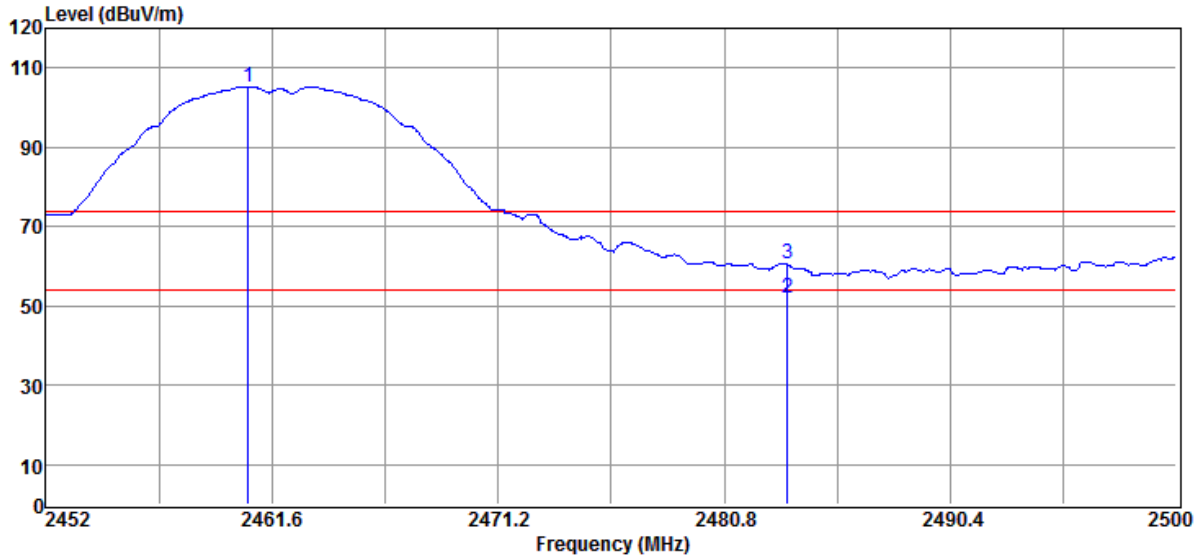

No	Freq MHz	Reading dBuV	Factor dB/m	Level dBuV/m	Limit dBuV/m	Margin dB	Remark	Pol V/H
1	2460.59	67.13	38.15	105.28	F	--	Peak	VERTICAL
2	2483.50	13.93	38.23	52.16	54.00	-1.84	Average	VERTICAL
3	2483.50	22.21	38.23	60.44	74.00	-13.56	Peak	VERTICAL

Remark: F” denotes fundamental frequency

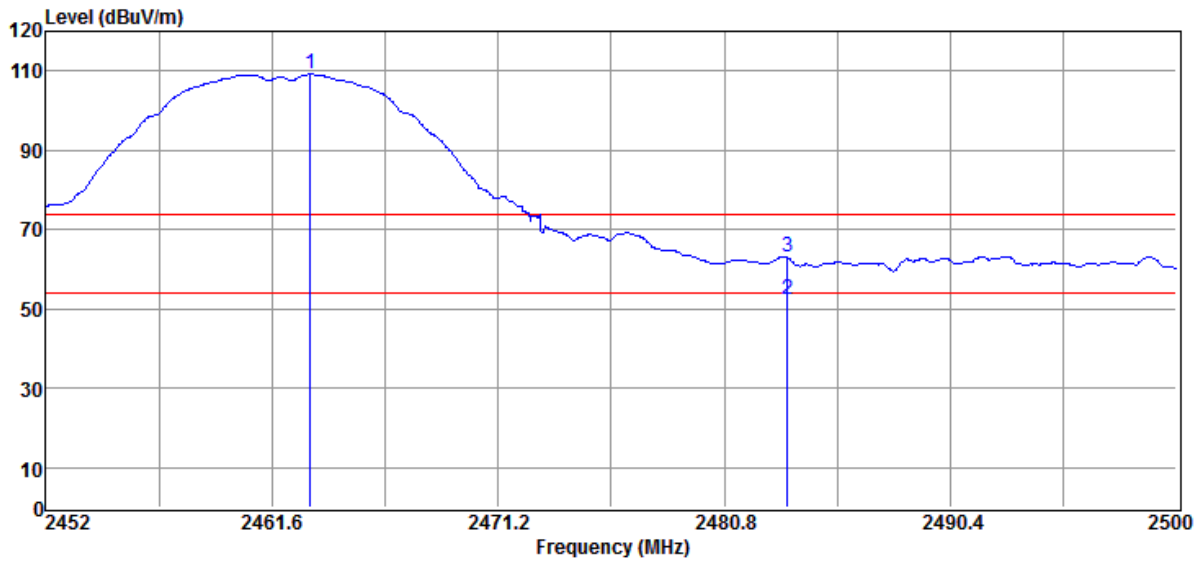

No	Freq MHz	Reading dBuV	Factor dB/m	Level dBuV/m	Limit dBuV/m	Margin dB	Remark	Pol V/H
1	2463.23	70.94	38.16	109.10	F	--	Peak	HORIZONTAL
2	2483.50	14.02	38.23	52.25	54.00	-1.75	Average	HORIZONTAL
3	2483.50	24.71	38.23	62.94	74.00	-11.06	Peak	HORIZONTAL

Remark: F” denotes fundamental frequency



**Radiated Emission: 802.11 g mode**

Operation Mode TX CH Low  
 Fundamental Frequency 2412 MHz  
 Temperature 25

Test Date 2022/09/27  
 Test By Barry  
 Humidity 60 %

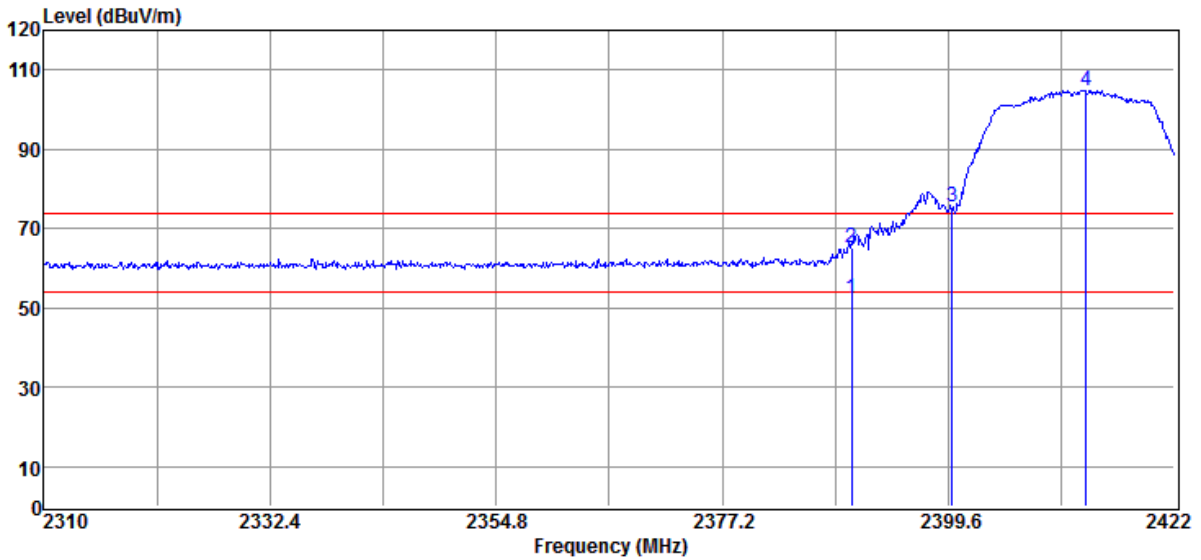

No	Freq MHz	Reading dBuV	Factor dB/m	Level dBuV/m	Limit dBuV/m	Margin dB	Remark	Pol V/H
1	2390.00	14.32	37.95	52.27	54.00	-1.73	Average	VERTICAL
2	2390.00	27.02	37.95	64.97	74.00	-9.03	Peak	VERTICAL
3	2400.00	37.30	38.05	75.35	84.94	-9.59	Peak	VERTICAL
4	2413.26	66.88	38.06	104.94	F	--	Peak	VERTICAL

Remark: F” denotes fundamental frequency

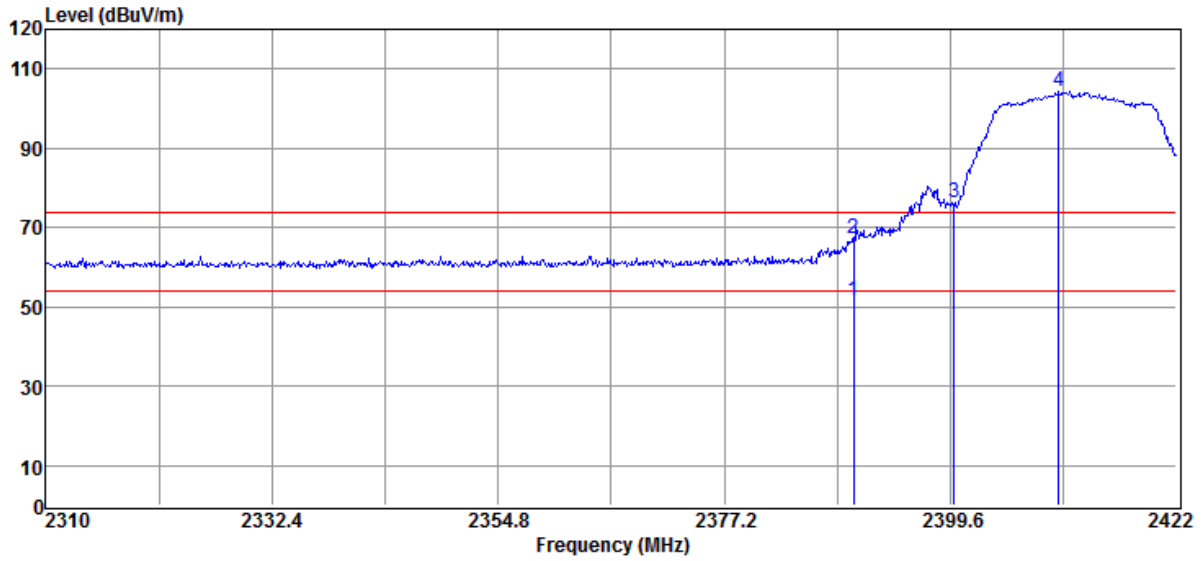

No	Freq MHz	Reading dBuV	Factor dB/m	Level dBuV/m	Limit dBuV/m	Margin dB	Remark	Pol V/H
1	2390.00	13.47	37.95	51.42	54.00	-2.58	Average	HORIZONTAL
2	2390.00	29.36	37.95	67.31	74.00	-6.69	Peak	HORIZONTAL
3	2400.00	38.03	38.05	76.08	84.2	-8.12	Peak	HORIZONTAL
4	2410.35	66.14	38.06	104.20	F	--	Peak	HORIZONTAL

Remark: F” denotes fundamental frequency

Operation Mode TX CH High  
 Fundamental Frequency 2462 MHz  
 Temperature 25

Test Date 2022/09/27  
 Test By Barry  
 Humidity 60 %

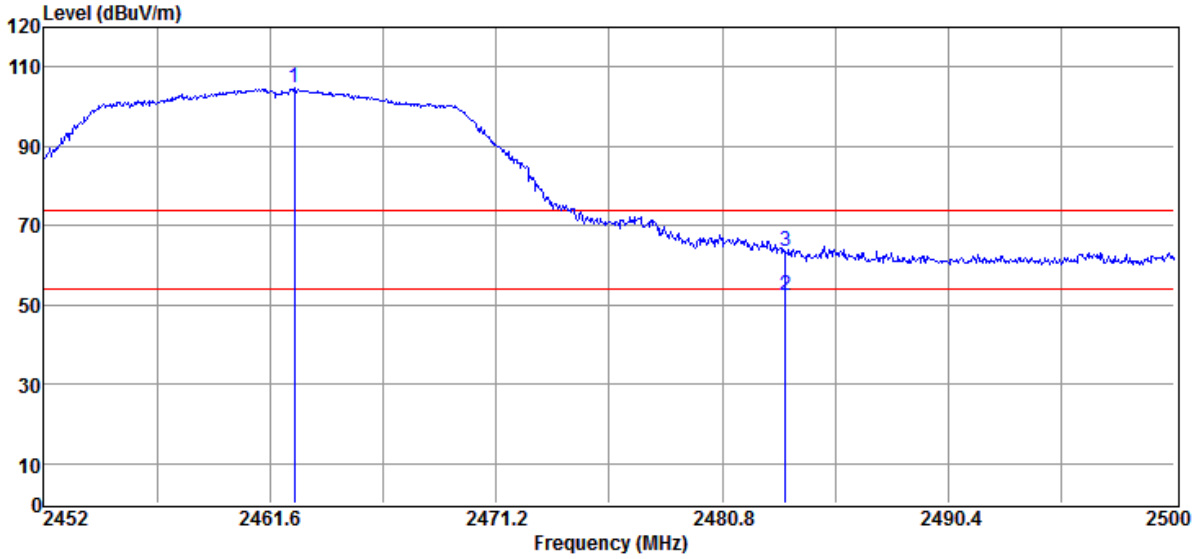

No	Freq MHz	Reading dBuV	Factor dB/m	Level dBuV/m	Limit dBuV/m	Margin dB	Remark	Pol V/H
1	2462.66	66.66	38.16	104.82	F	--	Peak	VERTICAL
2	2483.50	14.03	38.23	52.26	54.00	-1.74	Average	VERTICAL
3	2483.50	25.23	38.23	63.46	74.00	-10.54	Peak	VERTICAL

Remark: F” denotes fundamental frequency

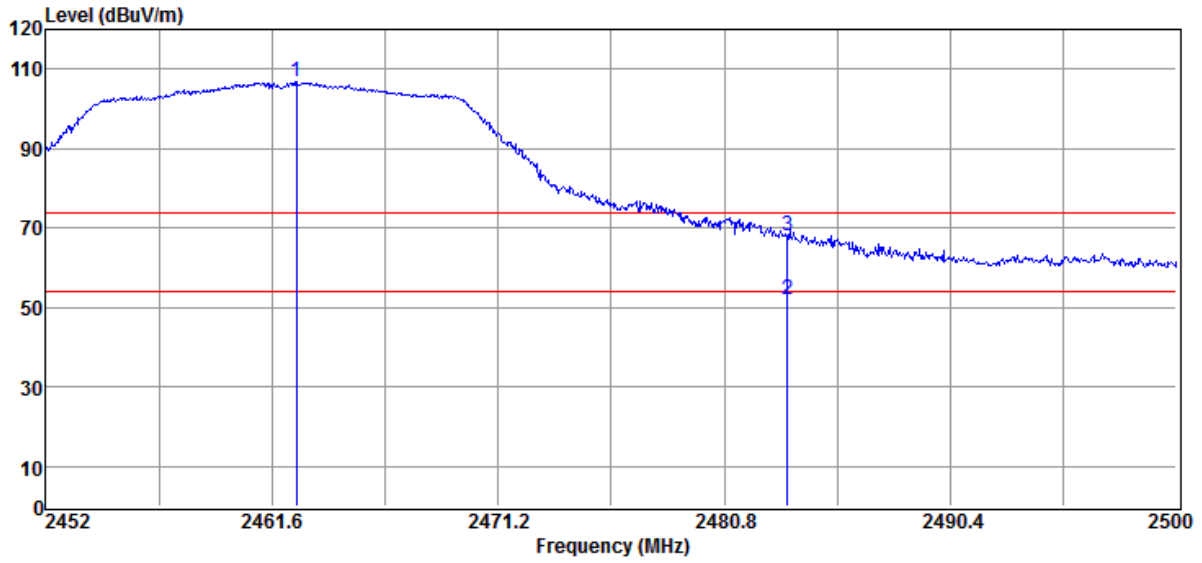

No	Freq MHz	Reading dBuV	Factor dB/m	Level dBuV/m	Limit dBuV/m	Margin dB	Remark	Pol V/H
1	2462.66	68.75	38.16	106.91	F	--	Peak	HORIZONTAL
2	2483.50	13.86	38.23	52.09	54.00	-1.91	Average	HORIZONTAL
3	2483.50	29.97	38.23	68.20	74.00	-5.80	Peak	HORIZONTAL

Remark: F” denotes fundamental frequency

**Radiated Emission: 802.11 n\_20 mode**

Operation Mode TX CH Low  
 Fundamental Frequency 2412 MHz  
 Temperature 25

Test Date 2022/09/27  
 Test By Barry  
 Humidity 60 %

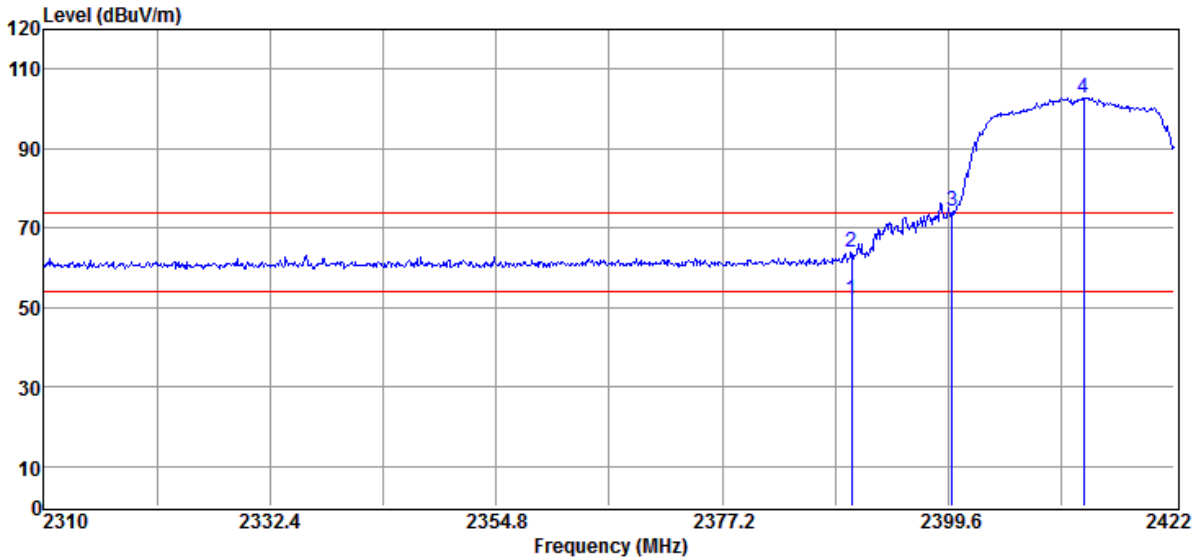

No	Freq MHz	Reading dBuV	Factor dB/m	Level dBuV/m	Limit dBuV/m	Margin dB	Remark	Pol V/H
1	2390.00	13.94	37.95	51.89	54.00	-2.11	Average	VERTICAL
2	2390.00	25.97	37.95	63.92	74.00	-10.08	Peak	VERTICAL
3	2400.00	36.37	38.05	74.42	82.78	-8.36	Peak	VERTICAL
4	2413.04	64.72	38.06	102.78	F	--	Peak	VERTICAL

Remark: F” denotes fundamental frequency

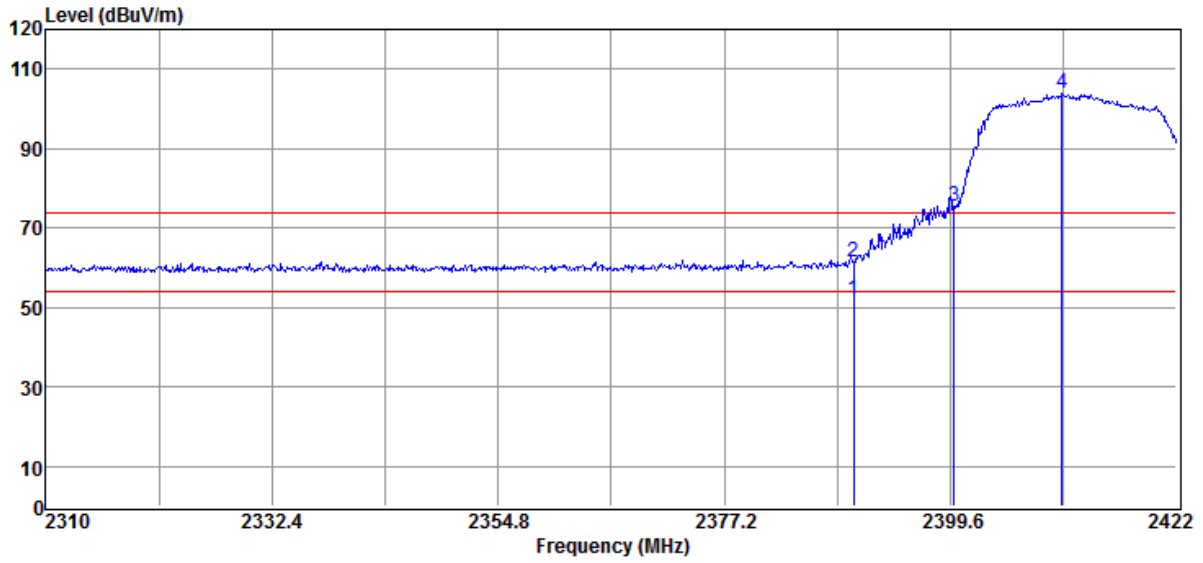

No	Freq MHz	Reading dBuV	Factor dB/m	Level dBuV/m	Limit dBuV/m	Margin dB	Remark	Pol V/H
1	2390.00	14.10	37.95	52.05	54.00	-1.95	Average	HORIZONTAL
2	2390.00	23.42	37.95	61.37	74.00	-12.63	Peak	HORIZONTAL
3	2400.00	37.41	38.05	75.46	83.82	-8.36	Peak	HORIZONTAL
4	2410.69	65.76	38.06	103.82	F	--	Peak	HORIZONTAL

Remark: F” denotes fundamental frequency

Operation Mode TX CH High  
 Fundamental Frequency 2462 MHz  
 Temperature 25

Test Date 2022/09/27  
 Test By Barry  
 Humidity 60 %

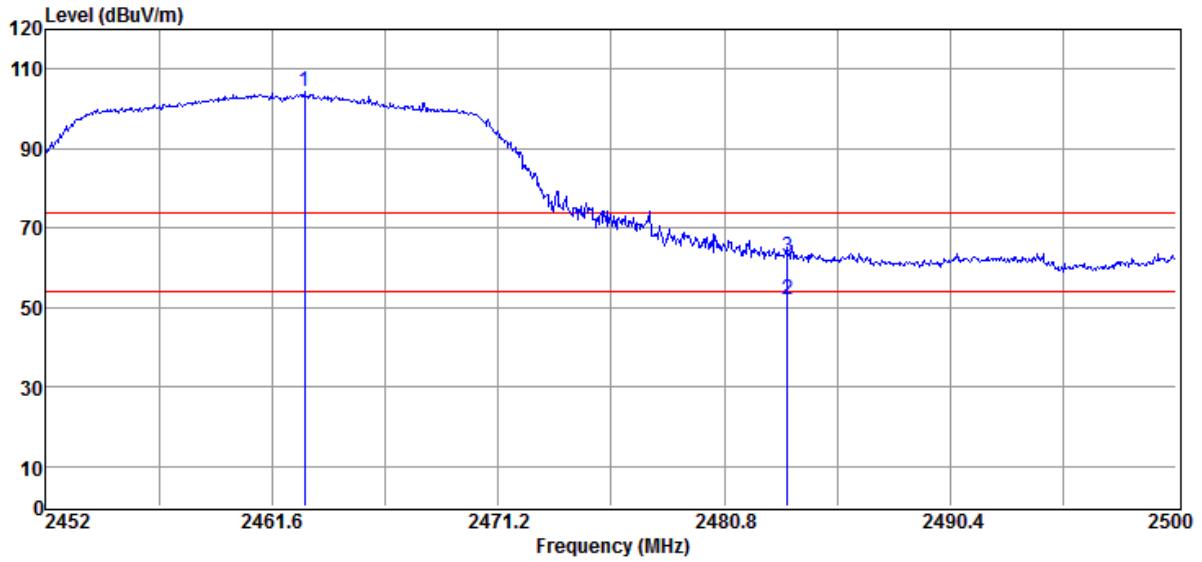

No	Freq MHz	Reading dBuV	Factor dB/m	Level dBuV/m	Limit dBuV/m	Margin dB	Remark	Pol V/H
1	2462.99	66.05	38.16	104.21	F	--	Peak	VERTICAL
2	2483.50	13.93	38.23	52.16	54.00	-1.84	Average	VERTICAL
3	2483.50	24.58	38.23	62.81	74.00	-11.19	Peak	VERTICAL

Remark: F” denotes fundamental frequency

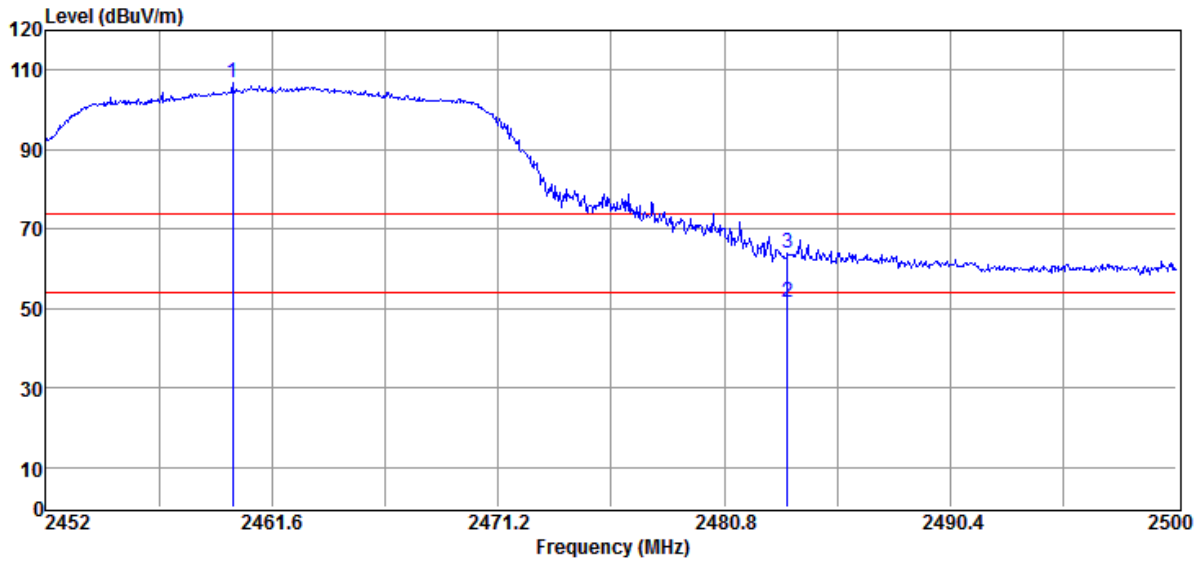

No	Freq MHz	Reading dBuV	Factor dB/m	Level dBuV/m	Limit dBuV/m	Margin dB	Remark	Pol V/H
1	2459.92	68.54	38.15	106.69	F	--	Peak	HORIZONTAL
2	2483.50	13.46	38.23	51.69	54.00	-2.31	Average	HORIZONTAL
3	2483.50	25.83	38.23	64.06	74.00	-9.94	Peak	HORIZONTAL

Remark: F” denotes fundamental frequency



**Radiated Emission: 802.11 n\_40 mode**

Operation Mode TX CH Low  
 Fundamental Frequency 2412 MHz  
 Temperature 25

Test Date 2022/09/27  
 Test By Barry  
 Humidity 60 %

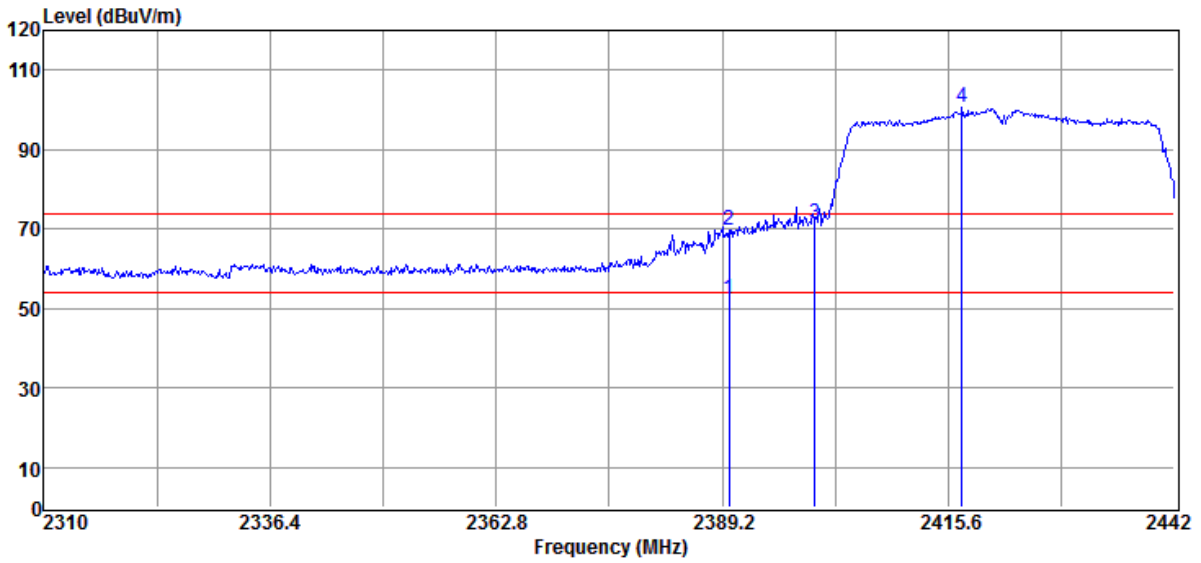

No	Freq MHz	Reading dBuV	Factor dB/m	Level dBuV/m	Limit dBuV/m	Margin dB	Remark	Pol V/H
1	2390.00	14.63	37.95	52.58	54.00	-1.42	Average	VERTICAL
2	2390.00	31.60	37.95	69.55	74.00	-4.45	Peak	VERTICAL
3	2400.00	33.27	38.05	71.32	80.5	-9.18	Peak	VERTICAL
4	2417.18	62.43	38.07	100.50	F	--	Peak	VERTICAL

Remark: F” denotes fundamental frequency

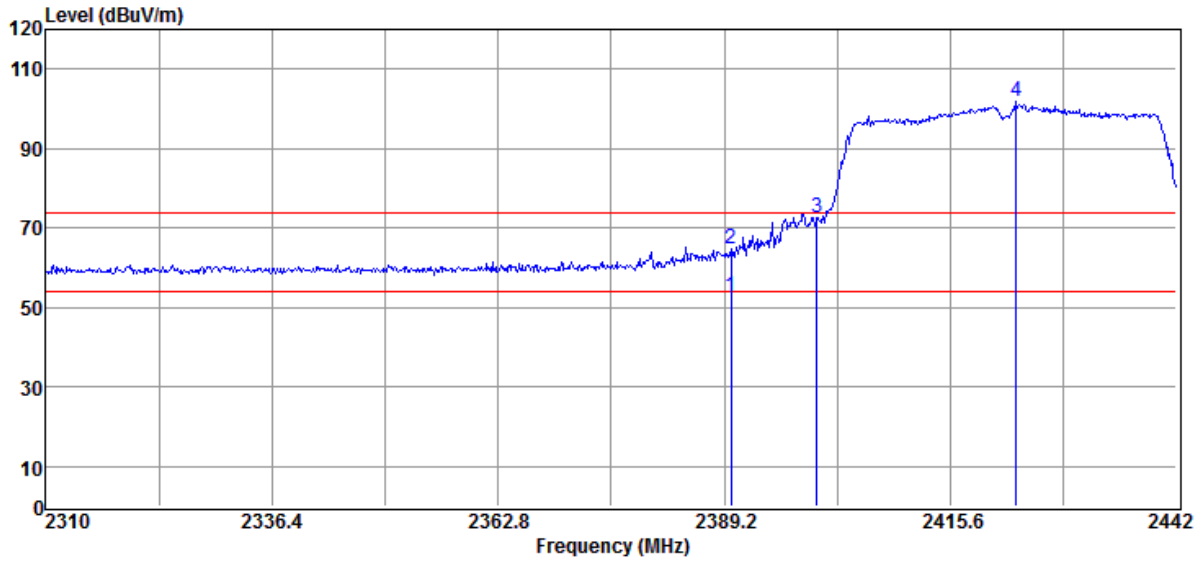

No	Freq MHz	Reading dBuV	Factor dB/m	Level dBuV/m	Limit dBuV/m	Margin dB	Remark	Pol V/H
1	2390.00	14.76	37.95	52.71	54.00	-1.29	Average	HORIZONTAL
2	2390.00	26.65	37.95	64.60	74.00	-9.40	Peak	HORIZONTAL
3	2400.00	34.57	38.05	72.62	81.67	-9.05	Peak	HORIZONTAL
4	2423.26	63.59	38.08	101.67	F	--	Peak	HORIZONTAL

Remark: F” denotes fundamental frequency

Operation Mode TX CH High  
 Fundamental Frequency 2452 MHz  
 Temperature 25

Test Date 2022/09/27  
 Test By Barry  
 Humidity 60 %

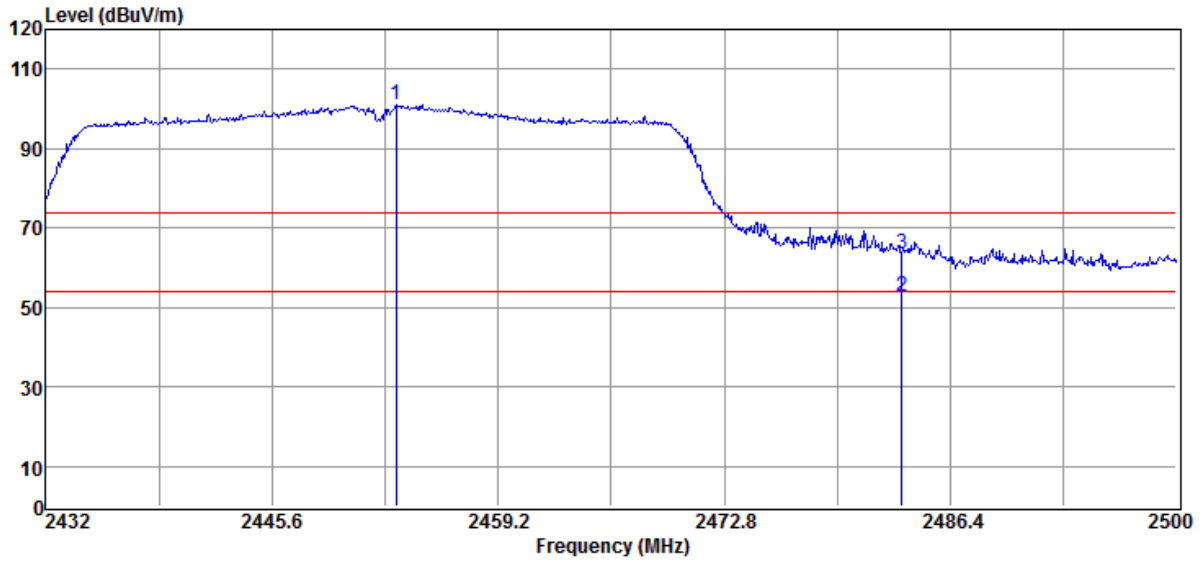

No	Freq MHz	Reading dBuV	Factor dB/m	Level dBuV/m	Limit dBuV/m	Margin dB	Remark	Pol V/H
1	2453.08	62.92	38.13	101.05	F	--	Peak	VERTICAL
2	2483.50	14.56	38.23	52.79	54.00	-1.21	Average	VERTICAL
3	2483.50	25.27	38.23	63.50	74.00	-10.50	Peak	VERTICAL

Remark: F” denotes fundamental frequency

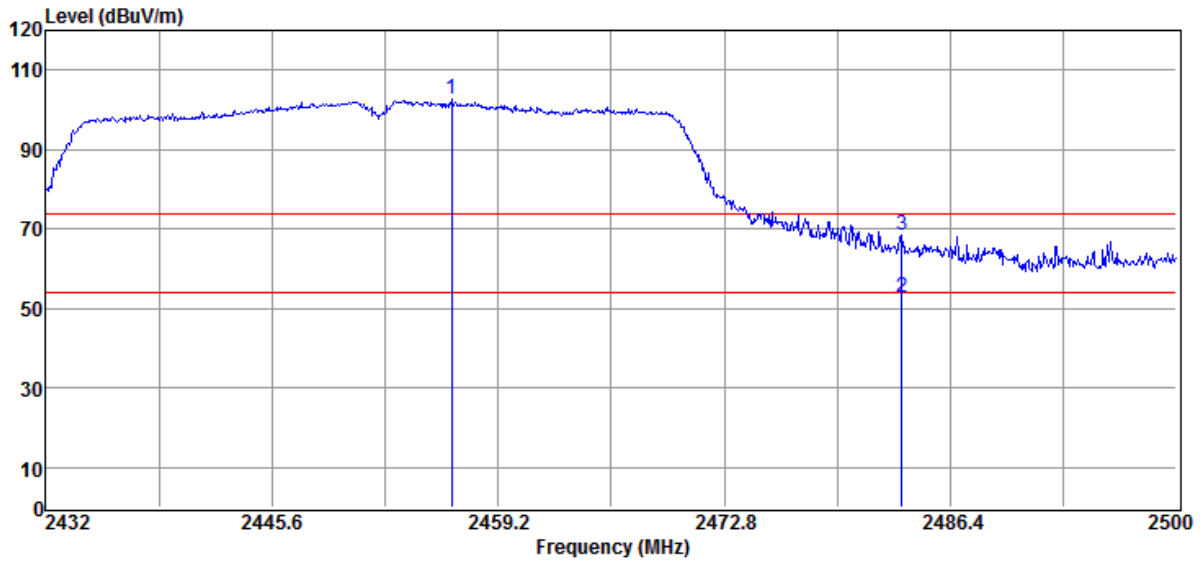

No	Freq MHz	Reading dBuV	Factor dB/m	Level dBuV/m	Limit dBuV/m	Margin dB	Remark	Pol V/H
1	2456.41	64.47	38.13	102.60	F	--	Peak	HORIZONTAL
2	2483.50	14.68	38.23	52.91	54.00	-1.09	Average	HORIZONTAL
3	2483.50	30.02	38.23	68.25	74.00	-5.75	Peak	HORIZONTAL

Remark: F” denotes fundamental frequency

**Radiated Emission: BLE mode**

Operation Mode TX CH Low  
 Fundamental Frequency 2402 MHz  
 Temperature 25

Test Date 2022/09/27  
 Test By Barry  
 Humidity 60 %

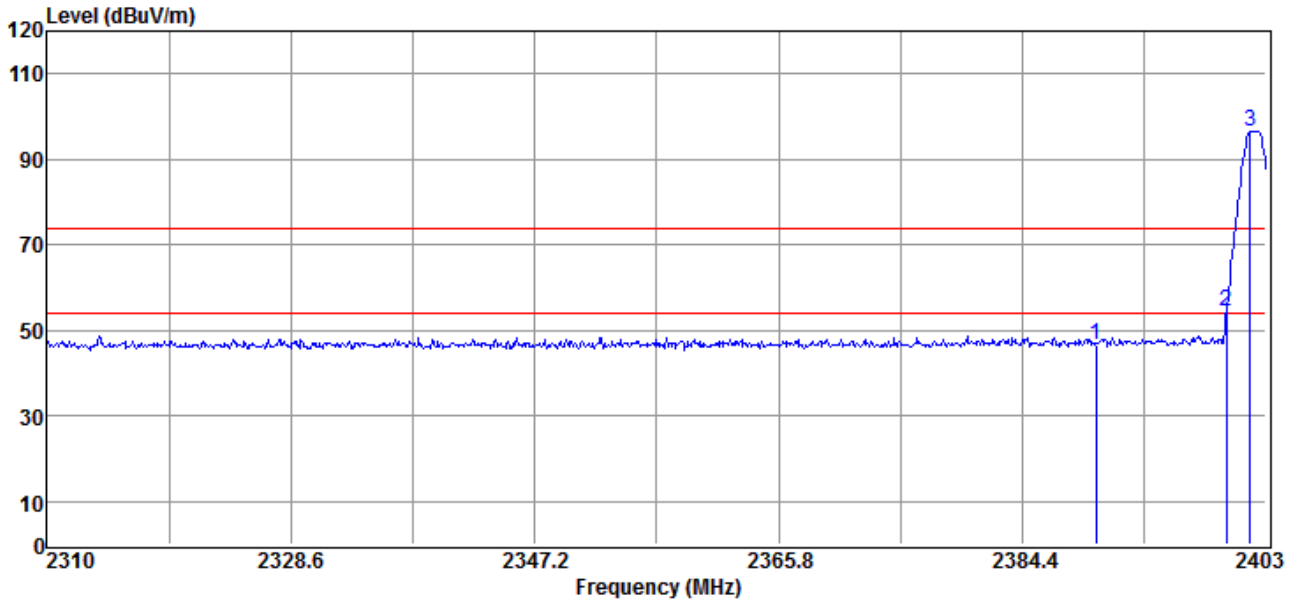

No	Freq MHz	Reading dBuV	Factor dB/m	Level dBuV/m	Limit dBuV/m	Margin dB	Remark	Pol V/H
1	2390.00	57.56	-10.79	46.77	74.00	-27.23	Peak	VERTICAL
2	2400.00	65.19	-10.70	54.49	76.64	-22.15	Peak	VERTICAL
3	2401.79	107.34	-10.70	96.64	F	--	Peak	VERTICAL

Remark: F” denotes fundamental frequency

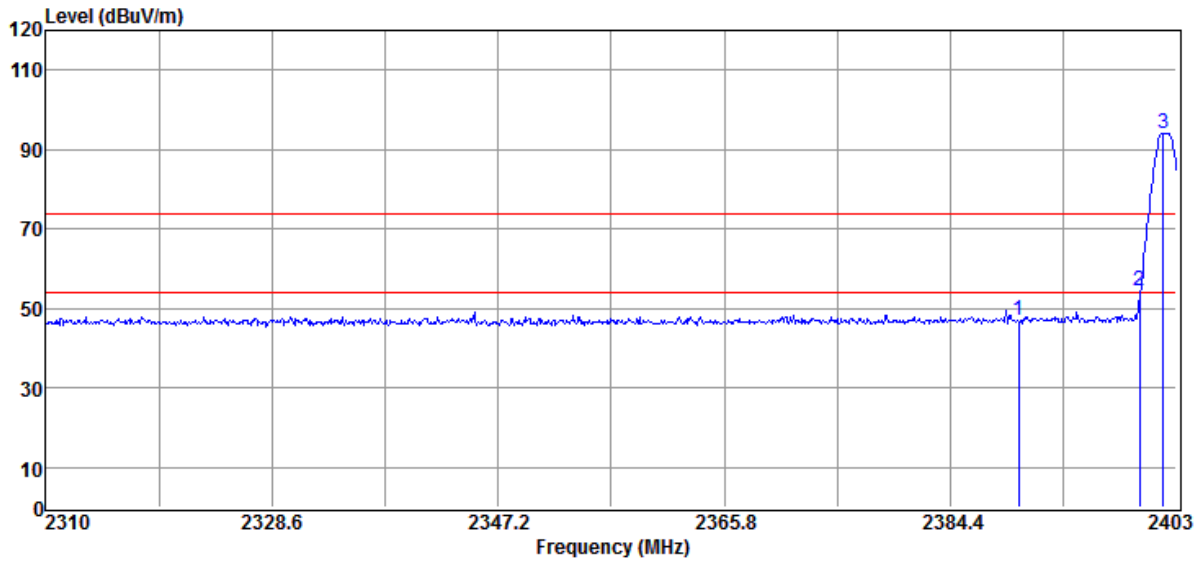

No	Freq MHz	Reading dBuV	Factor dB/m	Level dBuV/m	Limit dBuV/m	Margin dB	Remark	Pol V/H
1	2390.00	57.86	-10.79	47.07	74.00	-26.93	Peak	HORIZONTAL
2	2400.00	65.33	-10.70	54.63	74.17	-19.54	Peak	HORIZONTAL
3	2401.88	104.87	-10.70	94.17	F	--	Peak	HORIZONTAL

Remark: F'' denotes fundamental frequency

Operation Mode TX CH High  
 Fundamental Frequency 2480 MHz  
 Temperature 25

Test Date 2022/09/27  
 Test By Barry  
 Humidity 60 %

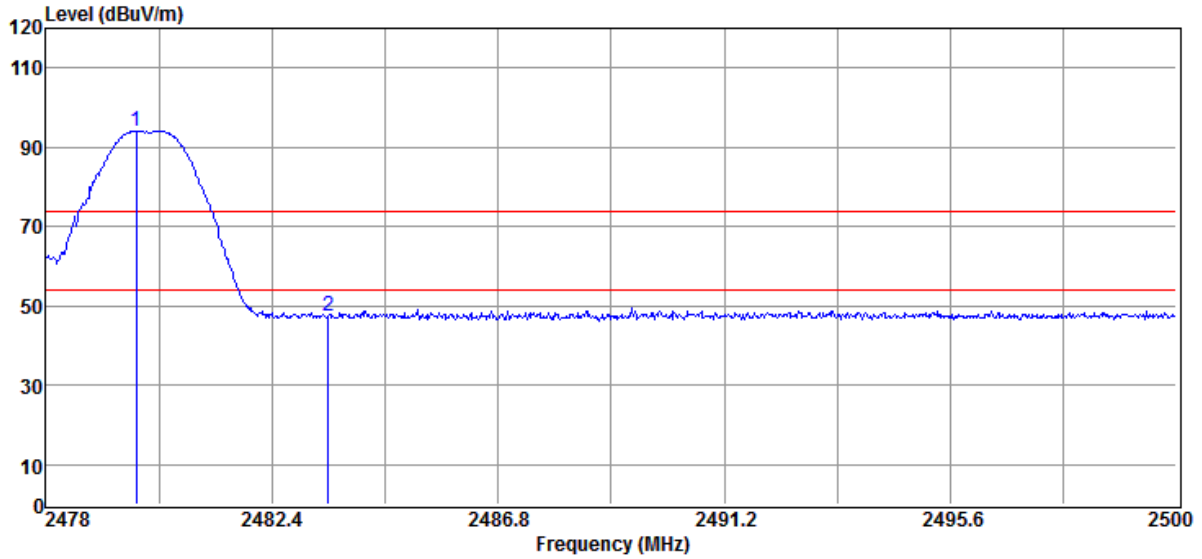

No	Freq MHz	Reading dBuV	Factor dB/m	Level dBuV/m	Limit dBuV/m	Margin dB	Remark	Pol V/H
1	2479.76	104.62	-10.57	94.05	F	--	Peak	VERTICAL
2	2483.50	57.98	-10.55	47.43	74.00	-26.57	Peak	VERTICAL

Remark: F” denotes fundamental frequency

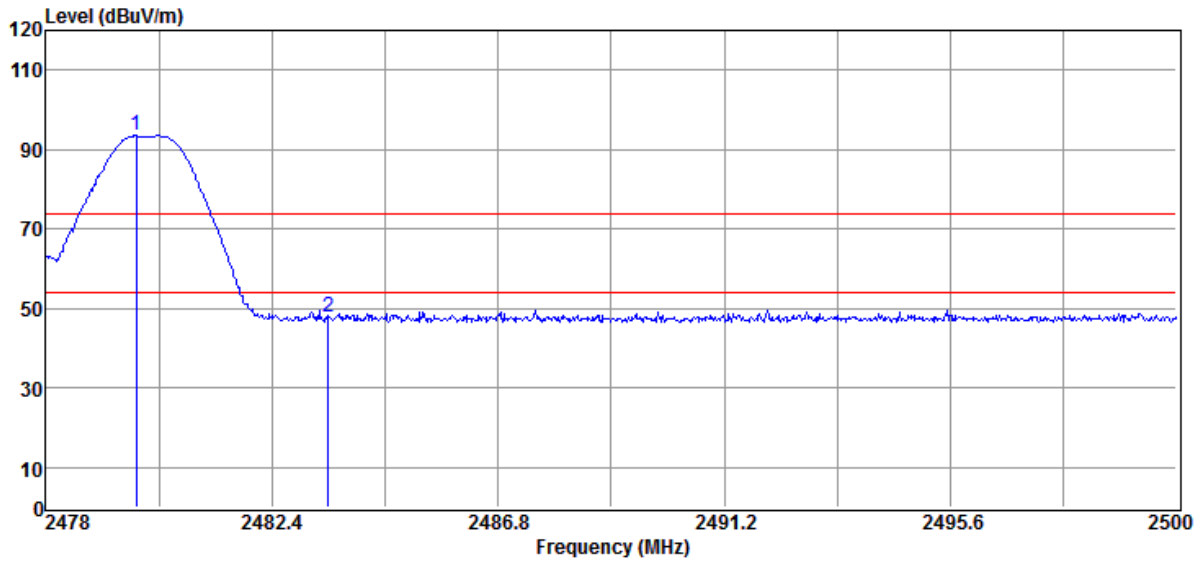

No	Freq MHz	Reading dBuV	Factor dB/m	Level dBuV/m	Limit dBuV/m	Margin dB	Remark	Pol V/H
1	2479.76	104.15	-10.57	93.58	F	--	Peak	HORIZONTAL
2	2483.50	58.33	-10.55	47.78	74.00	-26.22	Peak	HORIZONTAL

Remark: F” denotes fundamental frequency



## 10. Peak Power Spectral Density

### 10.1 Standard Applicable:

According to §15.247(e) For digitally modulated systems, the power spectral density conducted from the intentional radiator to the antenna shall not be greater than 8 dBm in any 3 kHz band during any time interval of continuous transmission. This power spectral density shall be determined in accordance with the provisions of paragraph (b) of this section. The same method of determining the conducted output power shall be used to determine the power spectral density.

### 10.2 Measurement Equipment Used:

Refer to section 6.2 for details.

### 10.3 Test Set-up:

Refer to section 7.3 for details.

### 10.4 Measurement Procedure:

1. Place the EUT on the table and set it in transmitting mode.
2. Remove the antenna from the EUT and then connect a low loss RF cable from the antenna port to the spectrum analyzer.
3. Set the spectrum analyzer as RBW =3kHz, VBW = 10kHz, Set the span to 1.5 DTS bandwidth., Sweep=Auto
4. Record the max. reading.
5. Repeat above procedures until all frequency measured were complete.

**10.5 Measurement Result:**

Mode	Frequency (MHz)	PSD (dBm/3kHz)				Total PSD (dBm/3kHz)	PSD Limit (dBm/3kHz)
		Chain 0	Chain 1	Chain 2	Chain 3		
802.11b	2412	-6.346				-6.35	8.00
	2437	-5.717				-5.72	8.00
	2462	-5.188				-5.19	8.00
802.11g	2412	-7.104				-7.10	8.00
	2437	-6.513				-6.51	8.00
	2462	-5.672				-5.67	8.00
802.11n HT20	2412	-9.189				-9.19	8.00
	2437	-8.718				-8.72	8.00
	2462	-8.499				-8.50	8.00
802.11n HT40	2422	-11.090				-11.09	8.00
	2437	-10.832				-10.83	8.00
	2452	-11.927				-11.93	8.00

Mode	Frequency (MHz)	PSD (dBm/3kHz)	Total PSD (dBm/3kHz)	PSD Limit (dBm/3kHz)
BLE (1M)	2402	-8.552	-8.55	8.00
	2442	-7.075	-7.08	8.00
	2480	-7.489	-7.49	8.00

### 802.11b Power Spectral Density Test Plot (CH-Low)



### Power Spectral Density Test Plot (CH-Mid)



### Power Spectral Density Test Plot (CH-High)



### 802.11g

### Power Spectral Density Test Plot (CH-Low)

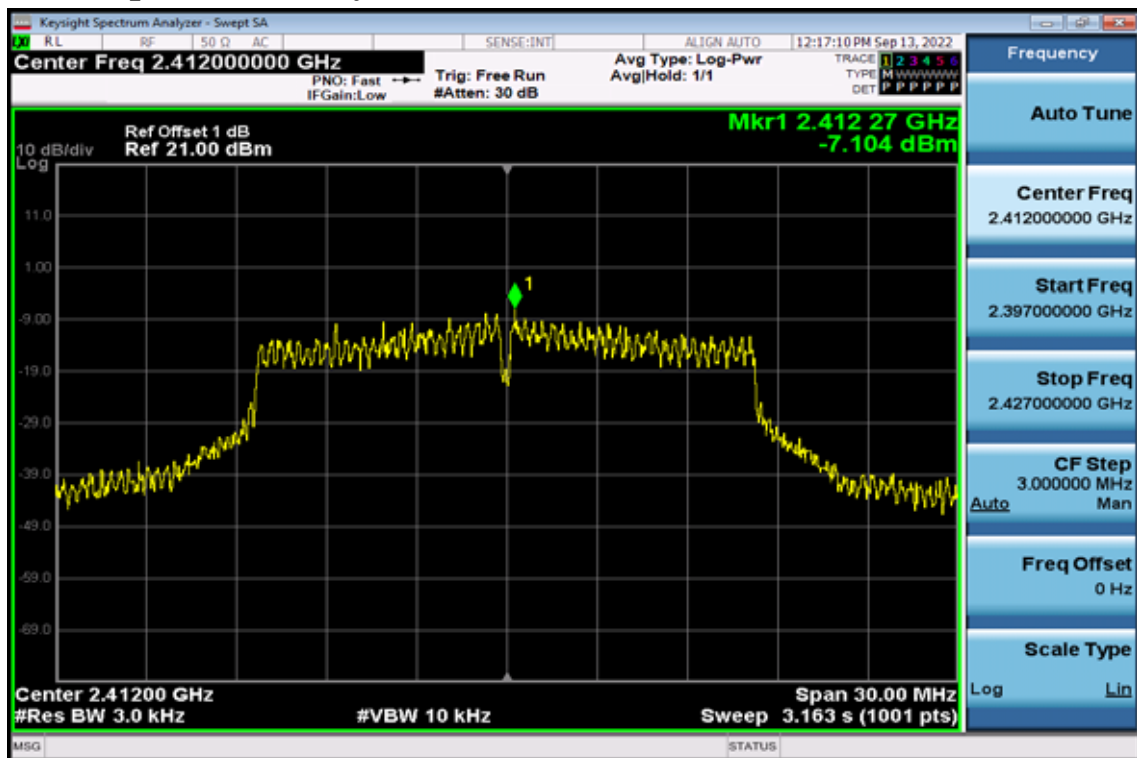

### Power Spectral Density Test Plot (CH-Mid)

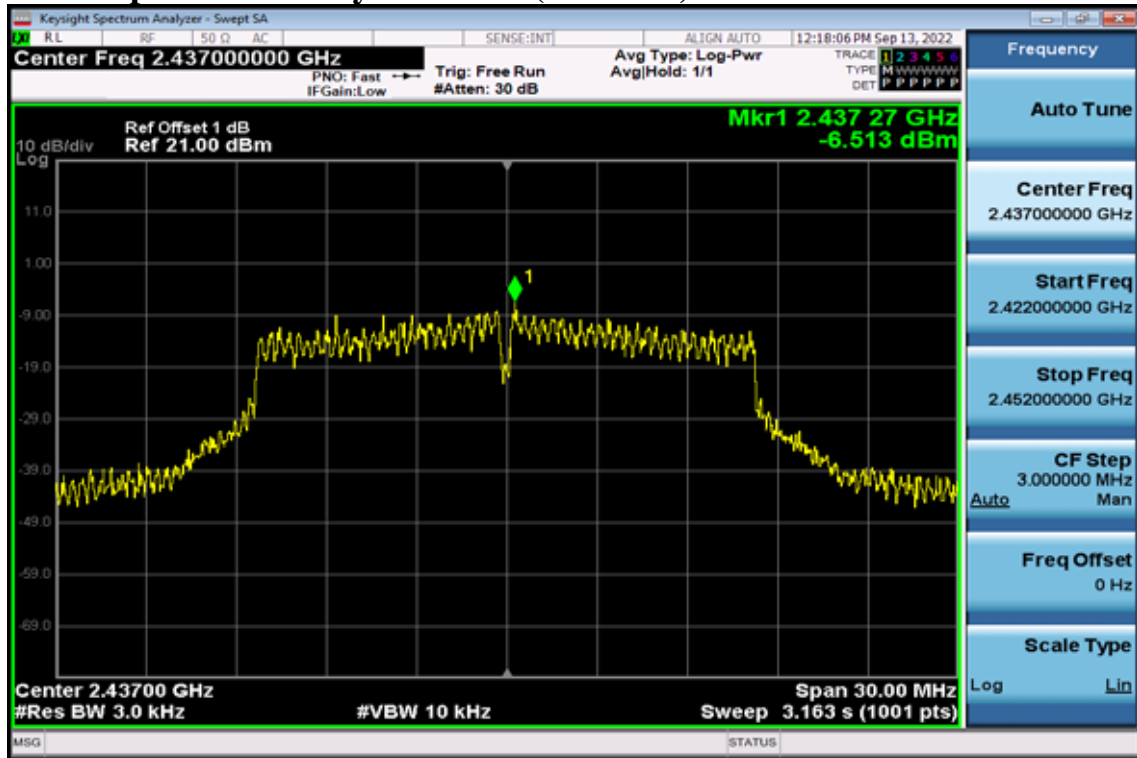

### Power Spectral Density Test Plot (CH-High)

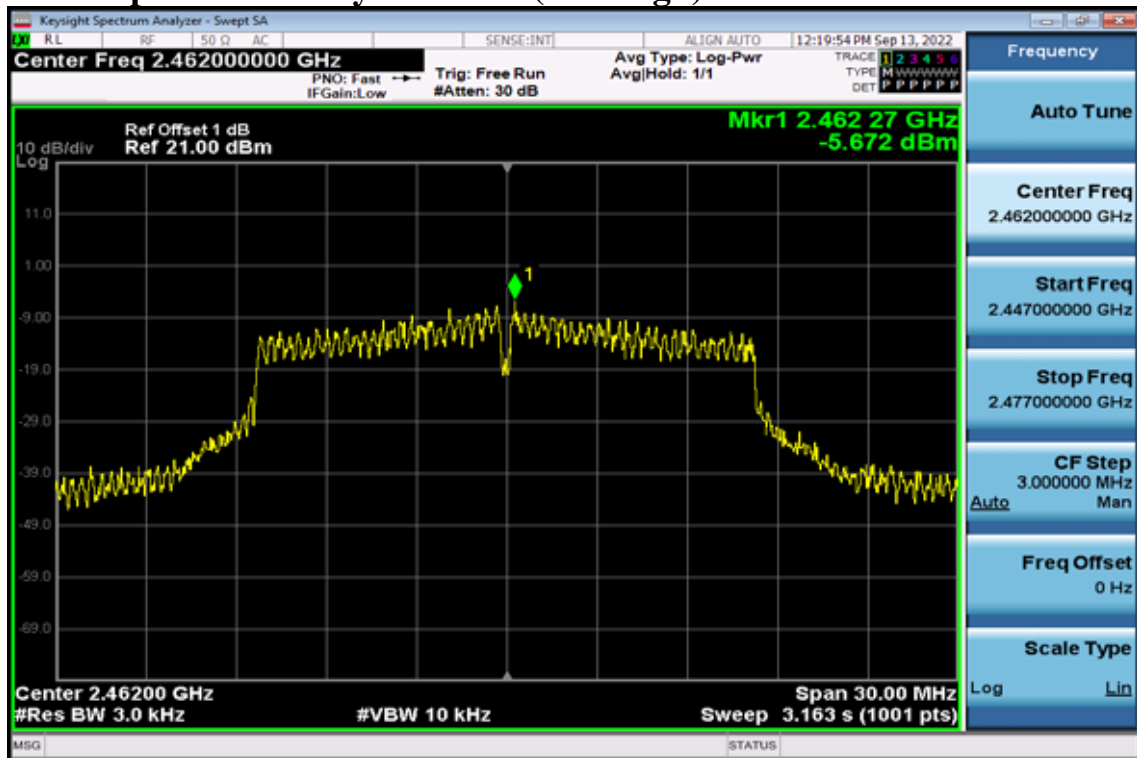

### 802.11n\_20M Power Spectral Density Test Plot (CH-Low)

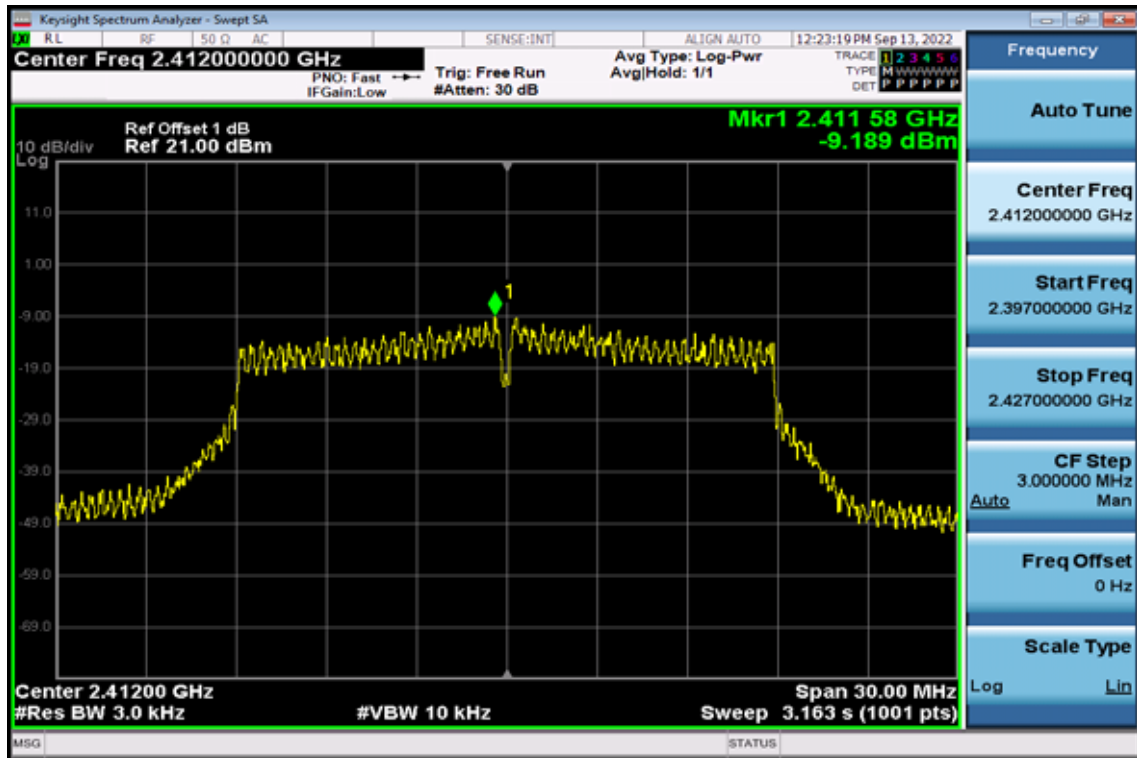

### Power Spectral Density Test Plot (CH-Mid)

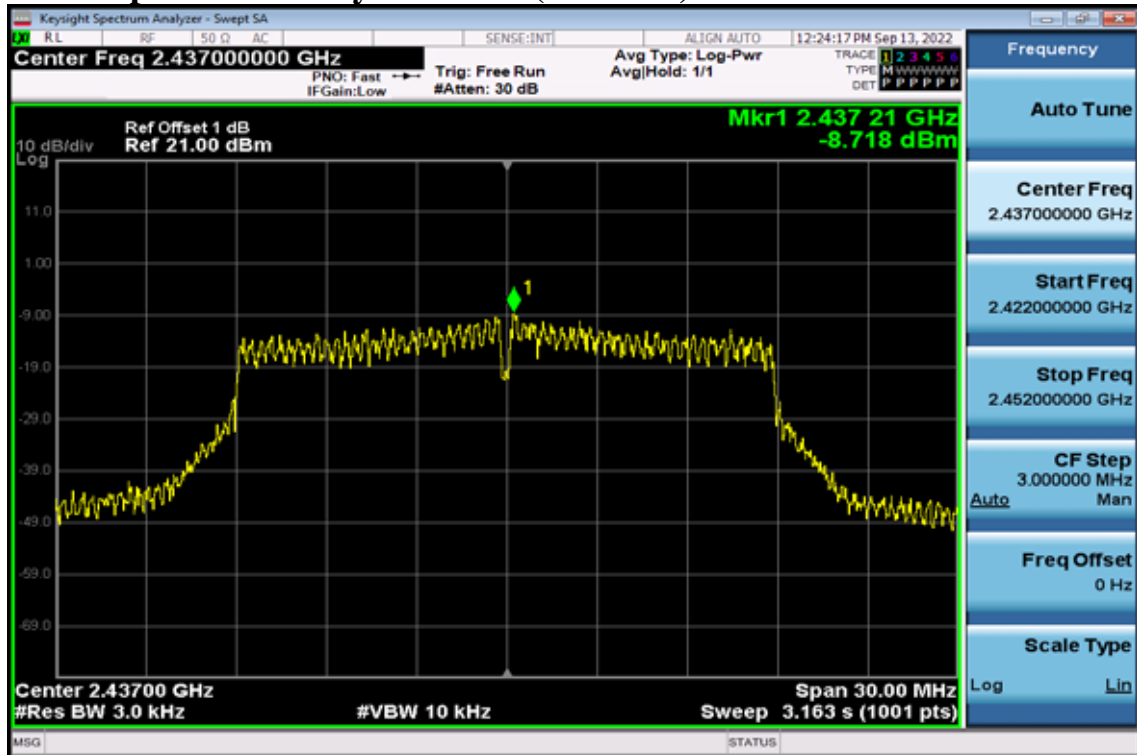

### Power Spectral Density Test Plot (CH-High)

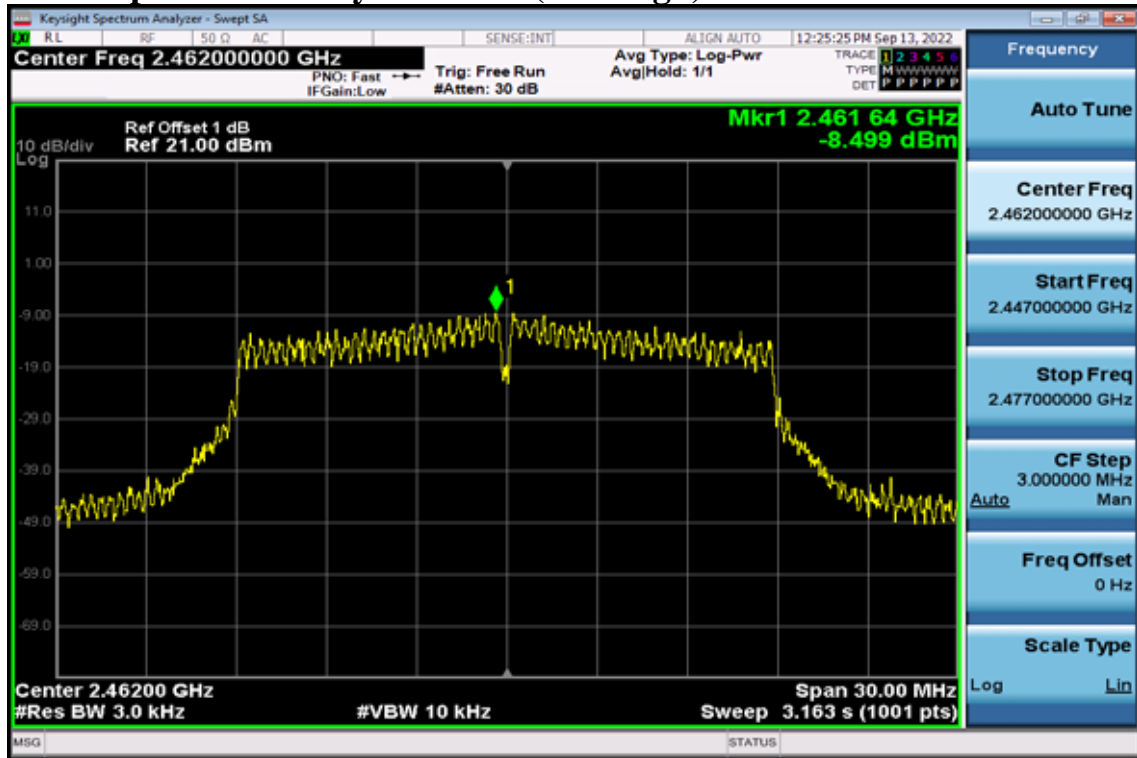

### 802.11n\_40M

### Power Spectral Density Test Plot (CH-Low)

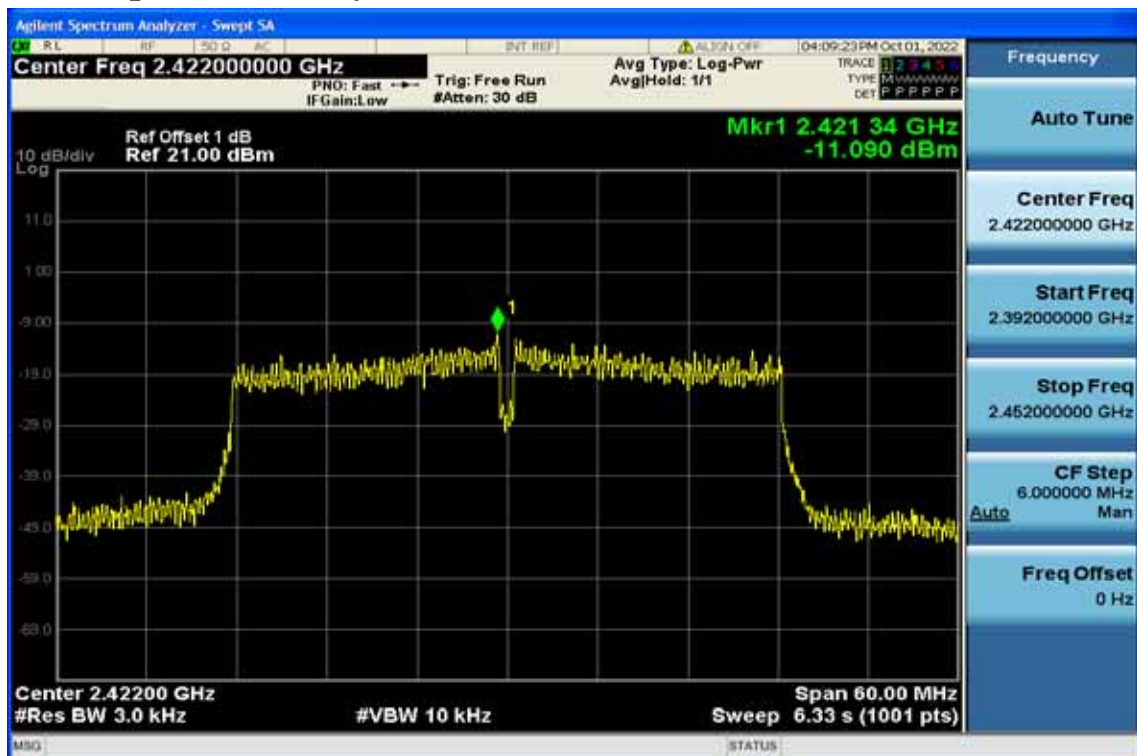

### Power Spectral Density Test Plot (CH-Mid)

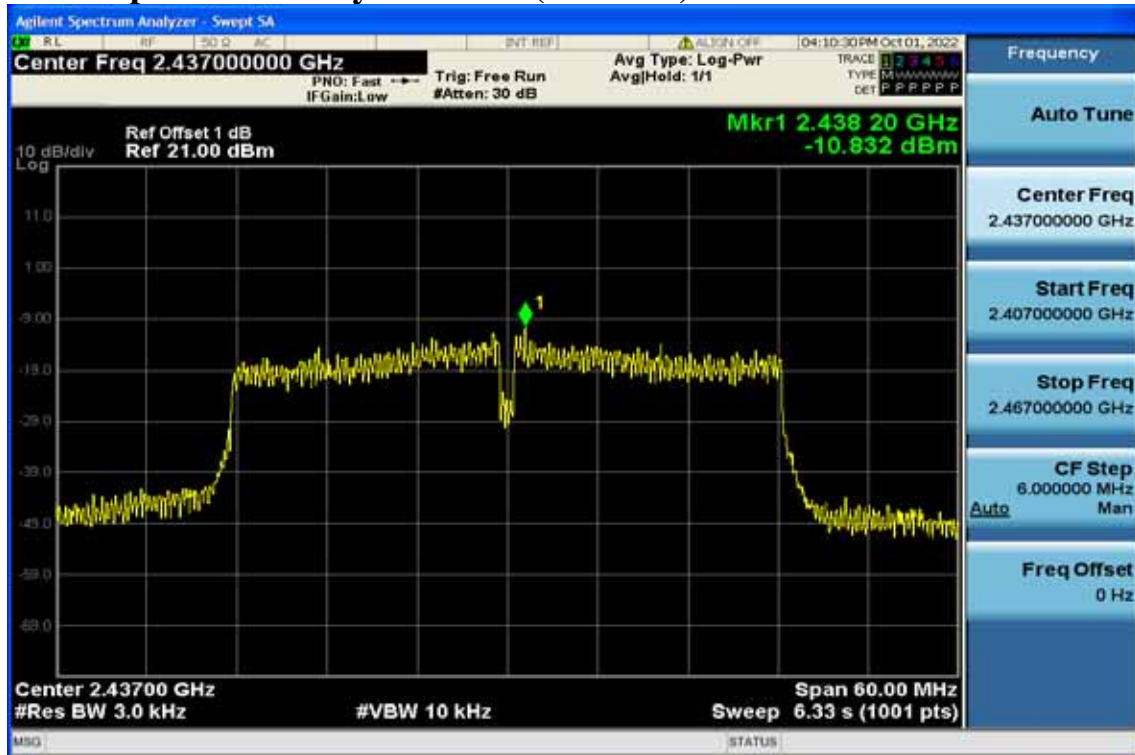

### Power Spectral Density Test Plot (CH-High)

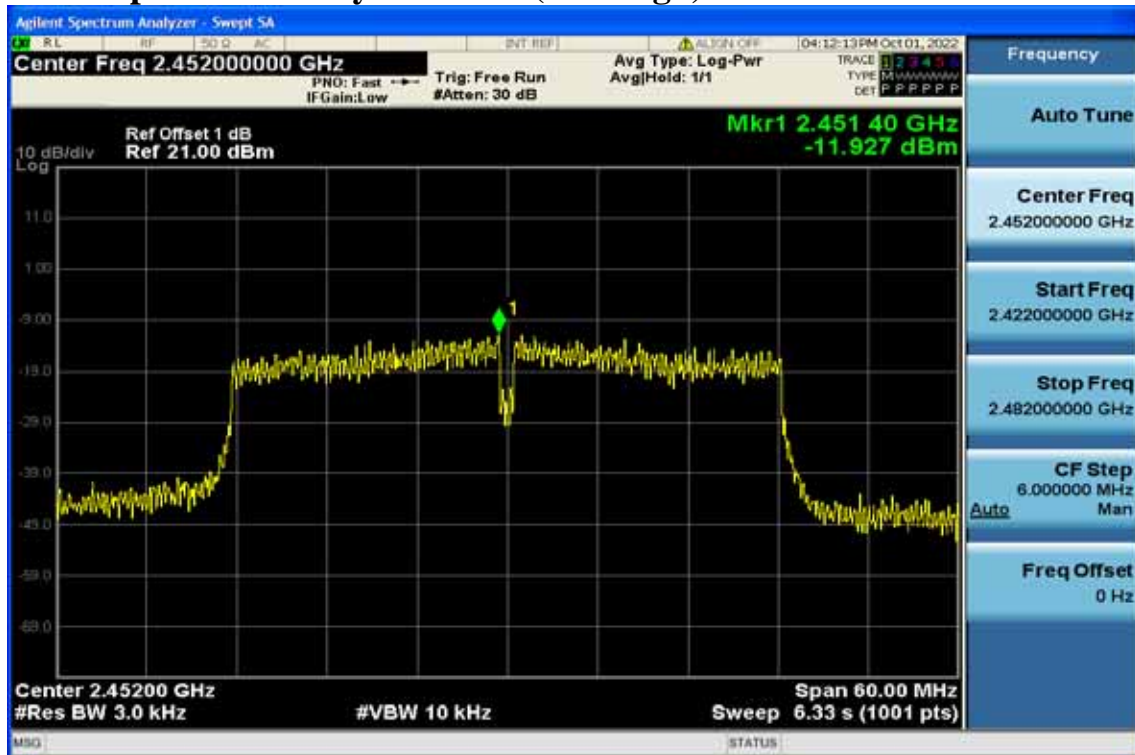



## BLE Power Spectral Density Test Plot (CH-Low)

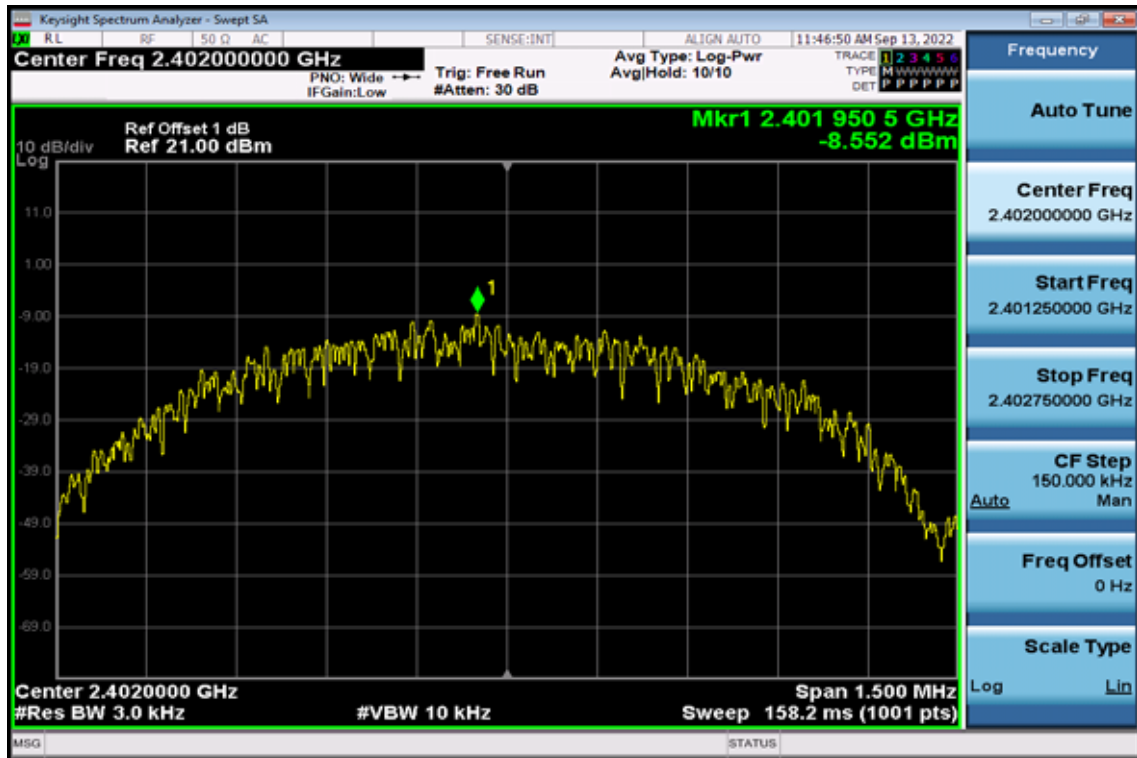

## Power Spectral Density Test Plot (CH-Mid)

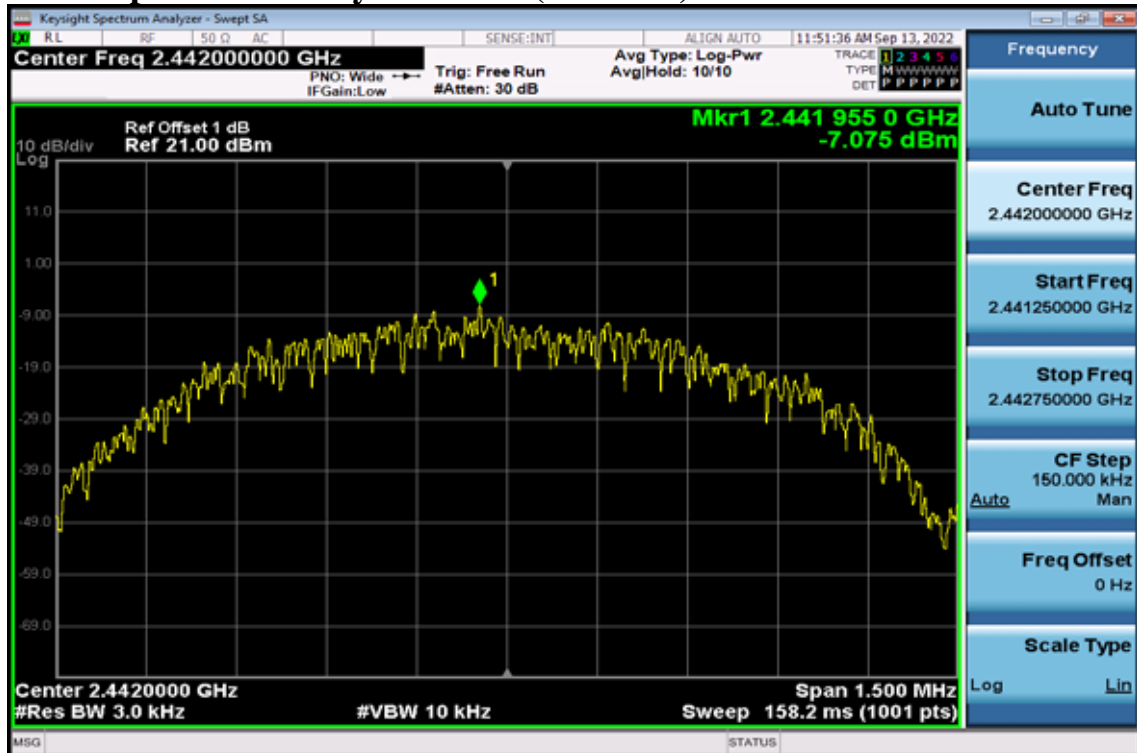

### Power Spectral Density Test Plot (CH-High)

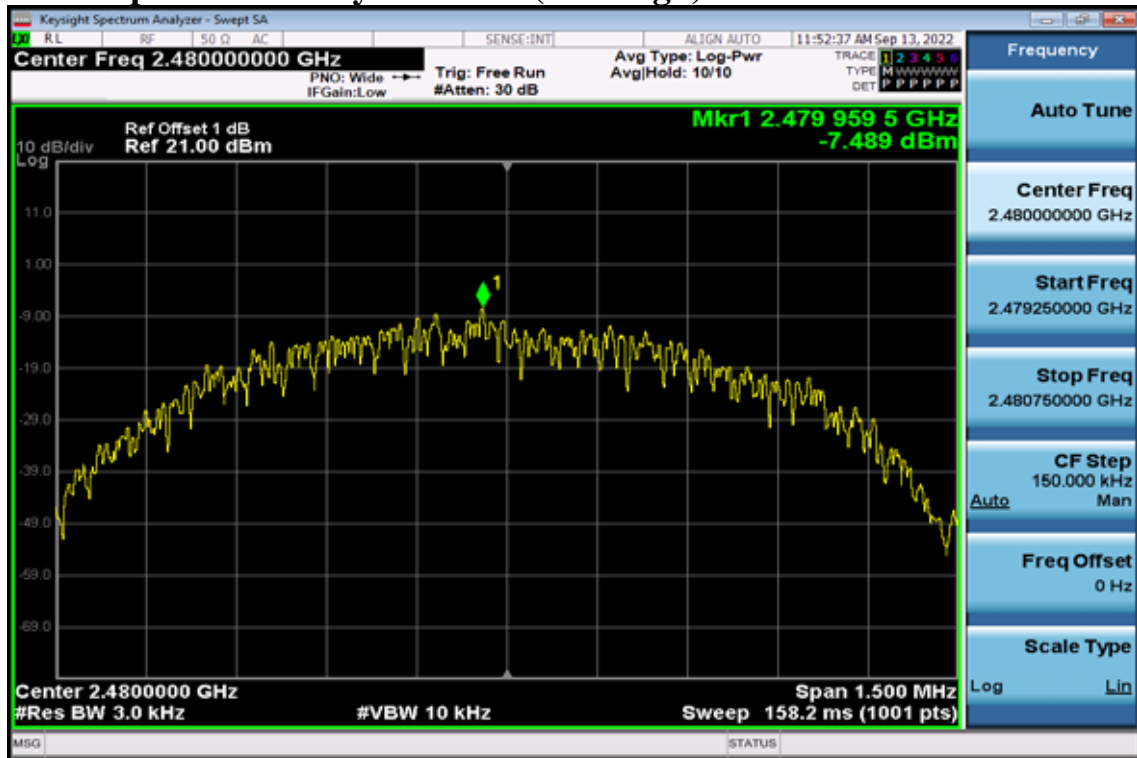

## 11. Antenna Requirement

### 11.1 Standard Applicable:

According to §15.203, Antenna requirement.

An intentional radiator shall be designed to ensure that no antenna other than that furnished by the responsible party shall be used with the device. The use of a permanently attached antenna or of an antenna that uses a unique coupling to the intentional radiator shall be considered sufficient to comply with the provisions of this Section. The manufacturer may design the unit so that a broken antenna can be replaced by the user, but the use of a standard antenna jack or electrical connector is prohibited. This requirement does not apply to carrier current devices or to devices operated under the provisions of Sections 15.211, 15.213, 15.217, 15.219, or 15.221. Further, this requirement does not apply to intentional radiators that must be professionally installed, such as perimeter protection systems and some field disturbance sensors, or to other intentional radiators which, in accordance with Section 15.31(d), must be measured at the installation site. However, the installer shall be responsible for ensuring that the proper antenna is employed so that the limits in this Part are not exceeded.

### 11.2 Antenna Connected Construction:

The directional gains of antenna used for transmitting is below table, and the antenna connector is designed with unique type RF connector and no consideration of replacement. Please see EUT photo and antenna spec. for details.

Antenna Designation:

	Antenna Type	Brand	Model	Peak Gain	Frequency Range	Connector Type
1	PCB	TSKY CO., LTD.	A8-A006-00509	2.7dBi	2400-2485 MHz	i-pex