

TEST REPORT

of

FCC PART 15 SUBPART E

New Application; Class I PC; Class II PC

Product : 10 inch Android Panel PC (SoC)
Brand: ProDVX
Model: APPC-10SLB
Model Difference: N/A
FCC ID: 2AR42APPC10SLB
FCC Rule Part: §15.407, Cat:NII
Applicant: ProDVX Europe B.V.
Address: Europalaan 12F, 5232 BC Den Bosch, The Netherlands

Test Performed by:

International Standards Laboratory Corp.

<LT Lab.>

*Site Registration No.

BSMI: SL2-IN-E-0013; MRA TW0997; TAF: 0997; IC: IC4067B-4;

*Address:

No. 120, Lane 180, Hsin Ho Rd., Lung-Tan Dist., Tao Yuan City 325, Taiwan

*Tel : 886-3-407-1718; Fax: 886-3-407-1738

Report No.: **ISL-18LR345FE**

Issue Date : **2018/12/18**



Test results given in this report apply only to the specific sample(s) tested and are traceable to national or international standard through calibration of the equipment and evaluating measurement uncertainty herein.

This report MUST not be used to claim product endorsement by TAF, NVLAP or any agency of the Government.

This test report shall not be reproduced except in full, without the written approval of International Standards Laboratory Corp.



VERIFICATION OF COMPLIANCE

Applicant: ProDVX Europe B.V.
Product Description: 10 inch Android Panel PC (SoC)
Brand Name: ProDVX
Model No.: APPC-10SLB
Model Difference: N/A
FCC ID: 2AR42APPC10SLB
Date of test: 2018/11/02 ~ 2018/12/13
Date of EUT Received: 2018/11/02

We hereby certify that:

All the tests in this report have been performed and recorded in accordance with the standards described above and performed by an independent electromagnetic compatibility consultant, International Standards Laboratory Corp.

The test results contained in this report accurately represent the measurements of the characteristics and the energy generated by sample equipment under test at the time of the test. The sample equipment tested as described in this report is in compliance with the limits of above standards.

Test By:		Date:	2018/12/18
	<hr/> <i>Barry Lee / Senior Engineer</i>		<hr/>
Prepared By:		Date:	2018/12/18
	<hr/> <i>Gigi Yeh / Senior Engineer</i>		<hr/>
Approved By:		Date:	2018/12/18
	<hr/> <i>Dino Chen / Senior Engineer</i>		<hr/>

Version

Version No.	Date	Description
00	2018/12/18	Initial creation of document

Uncertainty of Measurement

Description Of Test	Uncertainty
Conducted Emission (AC power line)	2.586 dB
Field Strength of Spurious Radiation	≤30MHz: 2.96dB 30-1GHz: 4.22 dB 1-40 GHz: 4.08 dB
Conducted Power	2.412 GHz: 1.30 dB 5.805 GHz: 1.55 dB
Power Density	2.412 GHz: 1.30 dB 5.805 GHz: 1.67 dB
Frequency	0.0032%
Time	0.01%
DC Voltage	1%

Table of Contents

1. General Information.....	6
1.1. Product Description	6
1.2. Related Submittal(s) / Grant (s)	9
1.3. Test Methodology	9
1.4. Test Facility.....	9
1.5. Special Accessories	9
1.6. Equipment Modifications.....	9
2. System Test Configuration.....	10
2.1. EUT Configuration	10
2.2. EUT Exercise	10
2.3. Test Procedure.....	10
2.4. Configuration of Tested System.....	11
3. Summary of Test Results.....	12
4. Description of Test Modes.....	13
5. Conducted Emission Test	15
5.1. Standard Applicable	15
5.2. Measurement Equipment Used:	15
5.3. EUT Setup:.....	15
5.4. Measurement Procedure:	16
5.5. Measurement Result:	16
6. Output Power / EIRP /Spectral Density Measurement.....	19
6.1. Standard Applicable	19
6.2. Measurement Procedure.....	21
6.3. Measurement Equipment Used:	22
6.4. Measurement Equipment Used:	22
6.5. Measurement Result.....	23
7. 26dB /99% Emission Bandwidth Measurement.....	44
7.1. Standard Applicable	44
7.2. Measurement Procedure.....	44
7.3. Measurement Equipment Used:	44
7.4. Test Set-up:	44
7.5. Measurement Result.....	45
8. 6dB Emission Bandwidth Measurement.....	58
8.1. Standard Applicable	58
8.2. Measurement Procedure.....	58
8.3. Measurement Equipment Used:	58
8.4. Test Set-up:	58

8.5.	Measurement Result.....	59
9.	Undesirable Emission – Radiated Measurement	65
9.1.	Standard Applicable	65
9.2.	EUT Setup.....	67
9.3.	Measurement Procedure.....	68
9.4.	Test SET-UP (Block Diagram of Configuration)	69
9.5.	Measurement Equipment Used:	70
9.6.	Field Strength Calculation	71
9.7.	Measurement Result.....	71
10.	Transmission in the Absence of Data	141
10.1.	Standard Applicable	141
10.2.	Result:	141
11.	Frequency Stability	142
11.1.	Standard Applicable	142
11.2.	Result	142
12.	Antenna Requirement	143
12.1.	Standard Applicable	143
12.2.	Antenna Connected Construction	143
13.	TPC and DFS Measurement	144
13.1.	TPC: Standard Applicable.....	144
13.2.	DFS: Standard Applicable.....	144
13.3.	Test Equipment Used:	150
13.4.	Test results	151

1. General Information

1.1. Product Description

General:

Product Name	10 inch Android Panel PC (SoC)	
Brand Name	ProDVX	
Model Name	APPC-10SLB	
Model Difference	N/A	
USB port	One provided	
Micro USB	One provided	
SD	One provided	
HDMI	One provided	
3.5 Jack in	One provided	
Power Supply	12Vdc from AC/DC adapter	
	Adapter:	<ol style="list-style-type: none"> 1. Model : 2ABL024F US Supplier: CWT 2. Model : SOY-1200200, Supplier: Shenzhen SOY Technology Co., Ltd. 3. Model : ZZU1588-200120 Supplier: JUNCTION GLOBAL TECHNOLOGY Co., LTD.

Bluetooth:

Frequency Range:	2402 – 2480MHz	
Bluetooth Version:	V2.1 + EDR	V4.0
Channel number:	79 channels	40 channels, 2MHz step
Modulation type	GFSK $+\pi$ / 4DQPSK + 8DPSK	Wide band Modulation (GFSK)
Tune up power:	0.52 dBm Peak, +/- 1 dB	1.4 dBm (Peak), +/- 1 dB
Dwell Time:	$\leq 0.4s$	N/A
Antenna Designation:	PCB Antenna Antenna 1 Gain: 2.42 dBi (Max) Antenna 2 Gain: 1.61 dBi	

This report applies for BT V2.1 + EDR

WLAN

Wi-Fi	Frequency Range (MHz)	Channels	Peak / Average Rated Power	Modulation Technology
802.11b	2412 – 2462(DTS)	11	20.68dBm (PK)	DSSS
802.11g	2412 – 2462(DTS)	11	25.34dBm (PK)	OFDM
802.11n (2.4G)	HT20 2412 – 2462(DTS)	11	25.28dBm (PK)	
802.11a	5150 – 5350(NII)	8	12.71dBm (AV)	
	5470 – 5725(NII)	11	12.53dBm (AV)	
	5725 – 5850(NII)	5	11.85dBm (AV)	
802.11n(5G)	HT20 5150 – 5350(NII)	8	12.3dBm (AV)	
	HT20 5470 – 5725(NII)	11	12.31dBm (AV)	
	HT20 5725 – 5850(NII)	5	11.54dBm (AV)	
	HT40 5150 – 5350(NII)	4	11.42dBm (AV)	
	HT40 5470 – 5725(NII)	5	11.34dBm (AV)	
	HT40 5725 – 5850(NII)	2	10.64dBm (AV)	
802.11ac	HT80 5150 – 5350(NII)	2	10.93dBm (AV)	
	HT80 5470 – 5725(NII)	2	10.69dBm (AV)	
	HT80 5725 – 5850(NII)	1	11.14dBm (AV)	
Modulation type		CCK, DQPSK, DBPSK for DSSS 256QAM.64QAM. 16QAM, QPSK, BPSK for OFDM		

Antenna Designation	<p>PCB Antenna WiFi 2.4G Antenna: PCB Antenna Antenna 1 Gain: 2.42 dBi (Max) Antenna 2 Gain: 1.61 dBi WiFi 5G Antenna: Antenna 1 Gain: 5150 -5350: 6.63 dBi (Max) 5470-5725: 5.78 dBi 5745-5850: 5.55 dBi Antenna 2 Gain: 5150 -5350: 3.98dBi 5470-5725: 3.8 dBi 5745-5850: 3.83 dBi</p> <p>According to KDB662911 D01 SM-MIMO signals could be considered uncorrelated for purposes of directional gain computation. Directional gain = GANT</p>
---------------------	---

The EUT is compliance with IEEE 802.11 a/n/ac Standard.

This report applies for Wifi frequency band 5150 MHz– 5250 MHz, 5725 MHz– 5850 MHz

Remark: The above DUT's information was declared by manufacturer. Please refer to the specifications or user's manual for more detailed description.

1.2. Related Submittal(s) / Grant (s)

This submittal(s) (test report) is intended for **FCC ID: 2AR42APPC10SLB** filing to comply with Section 15.407 of the FCC Part 15, Subpart E Rules.

1.3. Test Methodology

Both conducted and radiated testing were performed according to the procedures in ANSI C63.10: 2013. Radiated testing was performed at an antenna to EUT distance 3 meters.

KDB Document: 789033 D02 General UNII Test Procedures New Rules v02r01

FCC 14-30 Revision UNII

594280 D02 U-NII Device Security v01r03

1.4. Test Facility

The measurement facilities used to collect the 3m Radiated Emission and AC power line conducted data are located on the address of International Standards Laboratory Corp. <LT Lab.> No. 120, Lane 180, Hsin Ho Rd., Lung-Tan Dist., Tao Yuan City 325, Taiwan which are constructed and calibrated to meet the FCC requirements in documents ANSI C63.10: 2013. FCC Registration Number is: 487532; Designation Number is: TW0997, Canada Registration Number: 4067B-4.

1.5. Special Accessories

Not available for this EUT intended for grant.

1.6. Equipment Modifications

Not available for this EUT intended for grant.

2. System Test Configuration

2.1. EUT Configuration

The EUT configuration for testing is installed on RF field strength measurement to meet the Commissions requirement and operating in a manner which intends to maximize its emission characteristics in a continuous normal application.

2.2. EUT Exercise

The EUT (Transmitter) was operated in the engineering mode to fix the Tx frequency that was for the purpose of the measurements.

2.3. Test Procedure

2.3.1 Conducted Emissions

The EUT is a placed on as turn table which is 0.8 m above ground plane. According to the requirements in Section 6 of ANSI C63.10: 2013. Con-ducted emissions from the EUT measured in the frequency range between 0.15 MHz and 30MHz using CISPR 16-1-1 Quasi-Peak and Average detector mode.

2.3.2 Radiated Emissions

The EUT is a placed on as turn table which is 0.8 m/1.5m (Frequency above 1GHz) above ground plane. The turn table shall rotate 360 degrees to determine the position of maximum emission level. EUT is set 3m away from the receiving antenna which varied from 1m to 4m to find out the highest emission. And also, each emission was to be maximized by changing the polarization of receiving antenna both horizontal and vertical. In order to find out the max. emission, the relative positions of this hand-held transmitter (EUT) was rotated through three orthogonal axes and measurement procedures for electric field radiated emissions above 1 GHz the EUT measurement is to be made “while keeping the antenna in the ‘cone of radiation’ from that area and pointed at the area both in azimuth and elevation, with polarization oriented for maximum response.” is still within the 3dB illumination BW of the measurement antenna according to the requirements in Section 6 and 11 of ANSI C63.10: 2013

2.4. Configuration of Tested System

Fig. 2-1 Configuration of Tested System



Table 1-1 Equipment Used in Tested System

Item	Equipment	Mfr/Brand	Model/ Type No.	Series No.	Data Cable	Power Cord
1	N/A					

3. Summary of Test Results

FCC Rules	Description Of Test	Result
§15.207	AC Power Line Conducted Emission	Compliant
§15.407(a)(2)	Output Power/ EIRP/ Spectral Density Measurement	Compliant
§15.407(a)	26dB Emission Bandwidth	Compliant
§15.407(e)	6dB Emission Bandwidth	Compliant
§15.407(b)	Undesirable Emission – Radiated Measurement	Compliant
§15.407(c)	Transmission in case of Absence of Information	Compliant
§15.407(g)	Frequency Stability	Compliant
§15.407(a)	Antenna Requirement	Compliant
§15.407(d)	TPC and DFS Measurement	Compliant
§15.407(i)	Device Security	Compliant

4. Description of Test Modes

The EUT has been tested under operating condition.

Test program used to control the EUT for staying in continuous transmitting mode is programmed.

5150MHz-5250MHz:

802.11 a mode: Channel lowest (5180MHz), Mid (5200MHz) and Highest (5240MHz) with 6Mbps data rate is chosen for testing.

802.11 n HT 20 mode: Channel lowest (5180MHz), Mid (5200MHz) and Highest (5240MHz) with 6.5Mbps data rate is chosen for testing.

802.11 n HT 40 mode: Channel lowest (5190MHz) and high (5230MHz) with 13.5Mbps data rate is chosen for testing.

802.11 ac HT80: Channel (5210MHz) with 29.3Mbps lowest data rate is chosen for testing

The worst case Band 1, 802.11n HT40 was reported for Radiated Emission.

5250MHz-5350MHz:

802.11a mode: Channel low (5260MHz) and high (5320MHz) with 6Mbps lowest data rate are chosen for testing.

802.11 n HT20: Channel low (5260MHz) and high (5320MHz) with 6.5Mbps lowest data rate are chosen for testing.

802.11 n HT40: Channel low (5270MHz) and high (5310MHz) with 13.5Mbps lowest data rate are chosen for testing.

802.11 ac HT80: Channel (5290MHz) with 29.3Mbps lowest data rate is chosen for testing.

The worst case 802.11 n HT20 (5GHz) was reported for Radiated Emission.

5470MHz-5725MHz:

802.11a mode: Channel low (5500MHz), mid (5600MHz) and high (5700MHz) with 6Mbps lowest data rate are chosen for pre-test testing of radiated emissions.

802.11 n HT20: Channel low (5500MHz), mid (5600MHz) and high (5700MHz) with 6.5Mbps lowest data rate are chosen for pre-test testing of radiated emissions.

802.11 n HT40: Channel low (5510MHz), mid (5550MHz) and high (5670MHz) with 13.5Mbps lowest data rate are chosen for pre-test testing of radiated emissions.

802.11 ac HT80: Channel low (5530MHz) and high (5610MHz) with 29.3Mbps lowest data rate is chosen for pre-test testing of radiated emissions.

5725MHz-5850MHz:

802.11a mode: Channel low (5745MHz), mid (5785MHz) and high (5825MHz) with 6Mbps lowest data rate are chosen for pre-test testing of radiated emissions.

802.11 n HT20: Channel low (5745MHz), mid (5785MHz) and high (5825MHz) with 6.5Mbps lowest data rate are chosen for pre-test testing of radiated emissions.

802.11 n HT40: Channel low (5755MHz) and high (5795MHz) with 13.5Mbps lowest data rate are chosen for pre-test testing of radiated emissions.

802.11 ac HT80: Channel (5775MHz) with lowest data rate is chosen for full testing

The worst case Band 1&2, 802.11a was reported for Radiated Emission.

5. Conduced Emission Test

5.1. Standard Applicable

According to §15.207, frequency range within 150kHz to 30MHz shall not exceed the Limit table as below.

Frequency range MHz	Limits dB(uV)	
	Quasi-peak	Average
0.15 to 0.50	66 to 56	56 to 46
0.50 to 5	56	46
5 to 30	60	50

Note

- 1.The lower limit shall apply at the transition frequencies
- 2.The limit decreases linearly with the logarithm of the frequency in the range 0.15 MHz to 0.50 MHz.

5.2. Measurement Equipment Used:

Conducted Emission Test Site					
Equipment Type	MFR	Model Number	Serial Number	Last Cal.	Cal Due.
Conduction 04-3 Cable	WOKEN	CFD 300-NL	Conduction 04-3	08/30/2018	08/29/2019
EMI Receiver 16	Rohde & Schwarz	ESCI	101221	11/17/2018	11/16/2019
LISN 18	ROHDE & SCHWARZ	ENV216	101424	02/04/2018	02/03/2019
LISN 19	ROHDE & SCHWARZ	ENV216	101425	03/06/2018	03/05/2019
Test Software	Farad	EZEMC Ver:ISL-03A2	N/A	N/A	N/A

5.3. EUT Setup:

1. The conducted emission tests were performed in the test site, using the setup in accordance with the ANSI C63.10: 2013.
2. The AC/DC Power adaptor of EUT was plug-in LISN. The EUT was placed flushed with the rear of the table.
3. The LISN was connected with 120Vac/60Hz power source.

5.4. Measurement Procedure:

1. The EUT was placed on a table which is 0.8m above ground plane.
2. Maximum procedure was performed on the six highest emissions to ensure EUT compliance.
3. Repeat above procedures until all frequency measured were complete.

5.5. Measurement Result:

The initial step in collecting conducted data is a spectrum analyzer peak scan of the measurement range. Significant peaks are then marked as shown on the following data page, and these signals are then quasi-peaked.

Note: Refer to next page for measurement data and plots.

AC POWER LINE CONDUCTED EMISSION TEST DATA

Operation Mode:	Operation Mode	Test Date:	2017/06/22
Test By:	Barry		

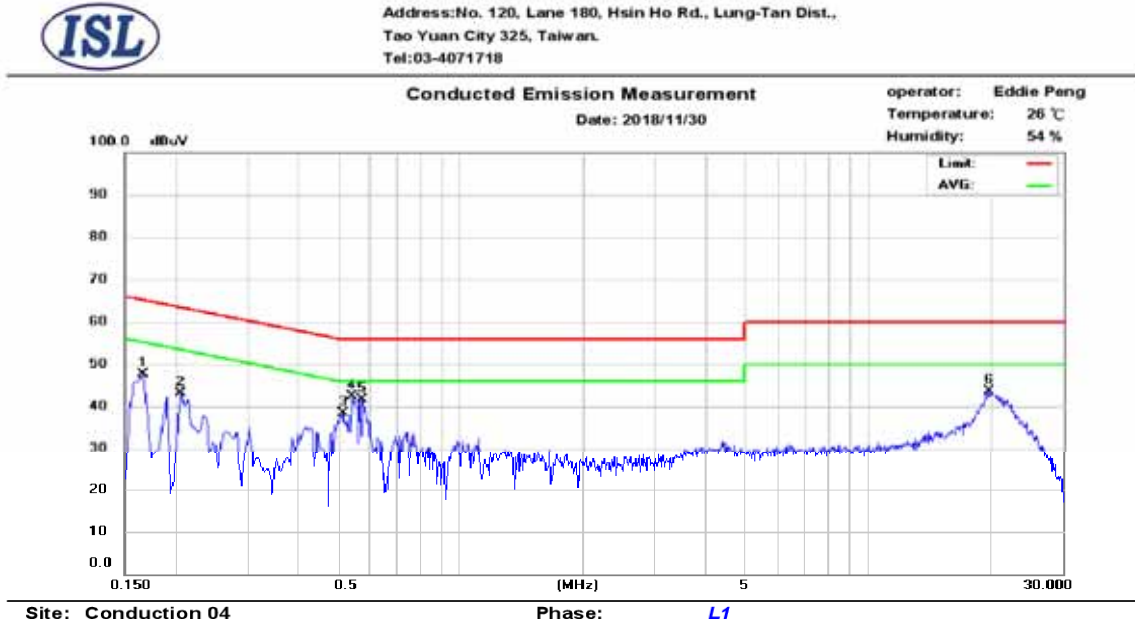

No.	Frequency (MHz)	QP_R (dBuV)	AVG_R (dBuV)	Correct Factor (dB)	QP Emission (dBuV)	QP Limit (dBuV)	QP Margin (dB)	AVG Emission (dBuV)	AVG Limit (dBuV)	AVG Margin (dB)
1	0.166	36.76	22.67	9.70	46.46	65.16	-18.70	32.37	55.16	-22.79
2	0.206	31.20	19.44	9.69	40.89	63.37	-22.48	29.13	53.37	-24.24
3	0.514	27.33	19.07	9.71	37.04	56.00	-18.96	28.78	46.00	-17.22
4	0.542	30.86	21.75	9.71	40.57	56.00	-15.43	31.46	46.00	-14.54
5	0.574	30.60	22.12	9.71	40.31	56.00	-15.69	31.83	46.00	-14.17
6	19.674	29.59	24.12	10.06	39.65	60.00	-20.35	34.18	50.00	-15.82



Address: No. 120, Lane 180, Hsin Ho Rd., Lung-Tan Dist.,
Tao Yuan City 325, Taiwan.
Tel: 03-4071718

Conducted Emission Measurement

Date: 2018/11/30

operator: Eddie Peng

Temperature: 26 °C

Humidity: 54 %

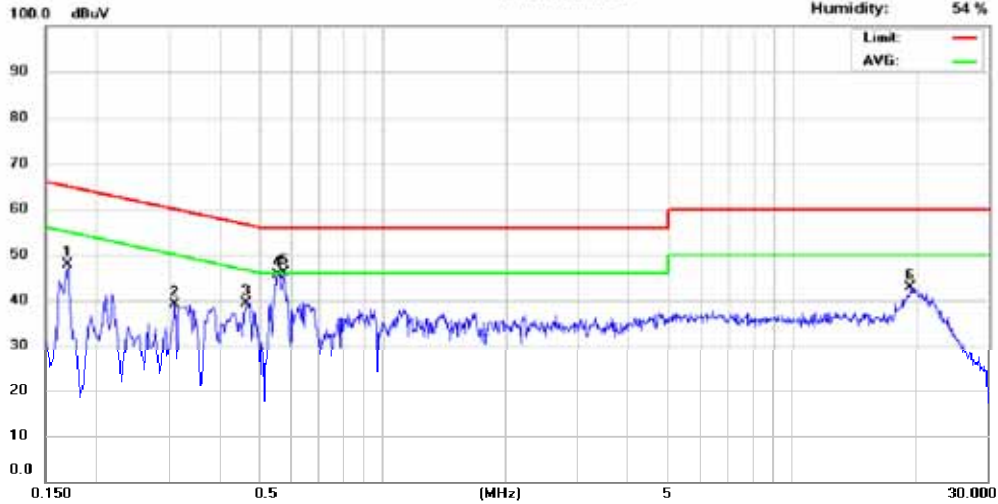

Site: Conduction 04

Phase: N

No.	Frequency (MHz)	QP_R (dBuV)	AVG_R (dBuV)	Correct Factor (dB)	QP Emission (dBuV)	QP Limit (dBuV)	QP Margin (dB)	AVG Emission (dBuV)	AVG Limit (dBuV)	AVG Margin (dB)
1	0.170	35.00	17.63	9.70	44.70	64.96	-20.26	27.33	54.96	-27.63
2	0.310	26.67	17.90	9.70	36.37	59.97	-23.60	27.60	49.97	-22.37
3	0.462	27.15	17.82	9.71	36.86	56.66	-19.80	27.53	46.66	-19.13
4	0.554	34.89	26.46	9.71	44.60	56.00	-11.40	36.17	46.00	-9.83
5	0.574	32.92	22.35	9.71	42.63	56.00	-13.37	32.06	46.00	-13.94
6	19.334	28.11	22.46	10.19	38.30	60.00	-21.70	32.65	50.00	-17.35

6. Output Power / EIRP /Spectral Density Measurement

6.1. Standard Applicable

According to §15.407(a) Power limits:

- (1) For the band 5.15 - 5.25 GHz.
 - (i) For an outdoor access point operating in the band 5.15 - 5.25 GHz, the maximum conducted output power over the frequency band of operation shall not exceed 1 W provided the maximum antenna gain does not exceed 6 dBi. In addition, the maximum power spectral density shall not exceed 17 dBm in any 1 megahertz band. If transmitting antennas of directional gain greater than 6 dBi are used, both the maximum conducted output power and the maximum power spectral density shall be reduced by the amount in dB that the directional gain of the antenna exceeds 6 dBi. The maximum e.i.r.p. at any elevation angle above 30 degrees as measured from the horizon must not exceed 125 mW (21 dBm).
 - (ii) For an indoor access point operating in the band 5.15 - 5.25 GHz, the maximum conducted output power over the frequency band of operation shall not exceed 1 W provided the maximum antenna gain does not exceed 6 dBi. In addition, the maximum power spectral density shall not exceed 17 dBm in any 1 megahertz band. If transmitting antennas of directional gain greater than 6 dBi are used, both the maximum conducted output power and the maximum power spectral density shall be reduced by the amount in dB that the directional gain of the antenna exceeds 6 dBi.
 - (iii) For fixed point-to-point access points operating in the band 5.15 - 5.25 GHz, the maximum conducted output power over the frequency band of operation shall not exceed 1 W. Fixed point-to-point U-NII devices may employ antennas with directional gain up to 23 dBi without any corresponding reduction in the maximum conducted output power or maximum power spectral density. For fixed point-to-point transmitters that employ a directional antenna gain greater than 23 dBi, a 1 dB reduction in maximum conducted output power and maximum power spectral density is required for each 1 dB of antenna gain in excess of 23 dBi. Fixed, point-to-point operations exclude the use of point-to-multipoint systems, omnidirectional applications, and multiple collocated transmitters transmitting the same information. The operator of the U-NII device, or if the equipment is professionally installed, the installer, is responsible for ensuring that systems employing high gain directional antennas are used exclusively for fixed, point-to-point operations.

- (iv) For mobile and portable client devices in the 5.15 - 5.25 GHz band, the maximum conducted output power over the frequency band of operation shall not exceed 250 mW provided the maximum antenna gain does not exceed 6 dBi. In addition, the maximum power spectral density shall not exceed 11 dBm in any 1 megahertz band. If transmitting antennas of directional gain greater than 6 dBi are used, both the maximum conducted output power and the maximum power spectral density shall be reduced by the amount in dB that the directional gain of the antenna exceeds 6 dBi.
- (2) For the 5.25 - 5.35 GHz and 5.47 - 5.725 GHz bands, the maximum conducted output power over the frequency bands of operation shall not exceed the lesser of 250 mW or $11 \text{ dBm} + 10 \log B$, where B is the 26 dB emission bandwidth in megahertz. In addition, the maximum power spectral density shall not exceed 11 dBm in any 1 megahertz band. If transmitting antennas of directional gain greater than 6 dBi are used, both the maximum conducted output power and the maximum power spectral density shall be reduced by the amount in dB that the directional gain of the antenna exceeds 6 dBi.
- (3) For the band 5.725 - 5.85 GHz, the maximum conducted output power over the frequency band of operation shall not exceed 1 W. In addition, the maximum power spectral density shall not exceed 30 dBm in any 500 kHz band. If transmitting antennas of directional gain greater than 6 dBi are used, both the maximum conducted output power and the maximum power spectral density shall be reduced by the amount in dB that the directional gain of the antenna exceeds 6 dBi. However, fixed point-to-point U-NII devices operating in this band may employ transmitting antennas with directional gain greater than 6 dBi without any corresponding reduction in transmitter conducted power. Fixed, point-to-point operations exclude the use of point-to-multipoint systems, omnidirectional applications, and multiple collocated transmitters transmitting the same information. The operator of the U-NII device, or if the equipment is professionally installed, the installer, is responsible for ensuring that systems employing high gain directional antennas are used exclusively for fixed, point-to-point operations.

6.2. Measurement Procedure

For Output Power

1. Place the EUT on the table and set it in transmitting mode.
2. Remove the antenna from the EUT and then connect a low loss RF cable from the antenna port to the power meter
3. Record the max. reading.
4. Repeat above procedures until all frequency measured were complete.

For Power Spectral Density

1. Place the EUT on the table and set it in transmitting mode.
2. Remove the antenna from the EUT and then connect a low loss RF cable from the antenna port to Spectrum.
3. Set RBW=1MHz,VBW=3MHz, Span=50MHz (Base Mode), Sweep time = Auto, traces 100 sweeps of video averaging for 5150-5725MHz;
4. Set RBW=500kHz,VBW=1.5MHz, Span=60MHz (Base Mode), Sweep time = Auto, traces 100 sweeps of video averaging for 5725-5850MHz;
5. Record the max. reading.
6. Repeat above procedures until all frequency measured were complete.

Refer to section E3 of KDB Document: KDB 789033 D02 General UNII Test Procedures New Rules v02r01

6.3. Measurement Equipment Used:

Conducted Emission Test Site					
Equipment Type	MFR	Model Number	Serial Number	Last Cal.	Cal Due.
Power Meter 05	Anritsu	ML2495A	1116010	10/28/2018	10/27/2019
Power Sensor 05	Anritsu	MA2411B	34NKF50	10/28/2018	10/27/2019
Power Sensor 06	DARE	RPR3006W	13I00030SN O33	12/12/2018	12/11/2019
Power Sensor 07	DARE	RPR3006W	13I00030SN O34	12/12/2018	12/11/2019
Temperature Chamber	KSON	THS-B4H100	2287	12/02/2018	12/01/2019
DC Power supply	ABM	8185D	N/A	11/16/2018	11/15/2019
AC Power supply	EXTECH	CFC105W	NA	12/25/2017	12/24/2018
Attenuator	Woken	Watt-65m3502	11051601	NA	NA
Splitter	MCLI	PS4-199	12465	12/26/2017	12/25/2019
Spectrum analyzer	keysight	N9010A	MY56070257	10/15/2018	10/14/2019
Spectrum analyzer	R&S	FSP40	100143	11/02/2018	11/01/2019
Test Software	DARE	Radimation Ver:2013.1.23	NA	NA	NA

6.4. Measurement Equipment Used:

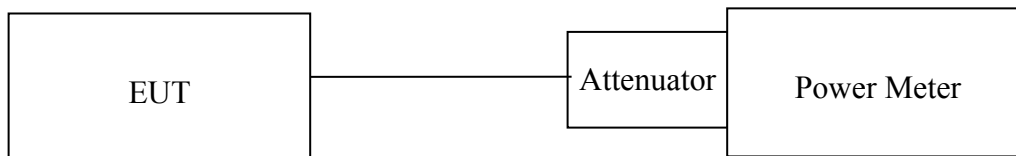

6.5. Measurement Result

Average Power Measurement:

802.11a

Mode	Channel	Power (dBm)	Limit(dBm)	Result
802.11a	5180	12.55	29.37	Pass
	5260	12.71	23.34	Pass
	5320	12.49	23.34	Pass
	5500	12.14	23.34	Pass
	5600	12.53	23.34	Pass
	5700	11.92	23.34	Pass
	5745	11.85	29.37	Pass
	5785	11.58	29.37	Pass
	5825	11.39	29.37	Pass

802.11n HT20

Mode	Channel	Power (dBm)	Limit(dBm)	Result
802.11n HT20	5180	12.3	29.37	Pass
	5260	12.23	23.34	Pass
	5320	12.12	23.34	Pass
	5500	11.87	23.34	Pass
	5600	12.09	23.34	Pass
	5700	12.31	23.34	Pass
	5745	11.54	29.37	Pass
	5785	11.32	29.37	Pass
	5825	11.03	29.37	Pass

802.11n HT40

Mode	Channel	Power (dBm)	Limit(dBm)	Result
802.11n HT40	5190	11.16	29.37	Pass
	5270	11.42	23.34	Pass
	5310	11.34	23.34	Pass
	5510	11.34	23.34	Pass
	5550	11.01	23.34	Pass
	5670	11.1	23.34	Pass
	5755	10.64	29.37	Pass
	5795	10.34	29.37	Pass

802.11ac HT80

Mode	Channel	Power (dBm)	Limit(dBm)	Result
802.11ac HT80	5210	10.87	29.37	Pass
	5290	10.93	23.34	Pass
	5530	10.69	23.34	Pass
	5610	10.27	29.37	Pass
	5775	11.14	29.37	Pass

Power Spectral Density Measurement:

802.11a Mode

Frequency MHz	RF Power Density Reading (dBm/MHz)	Maximum Limit (dBm/MHz)
5180	8.33	16.37
5260	7.88	10.37
5320	8.09	10.37
5500	9.03	10.37
5600	8.75	10.37
5700	7.93	10.37
Frequency MHz	RF Power Density Reading (dBm/500KHz)	Maximum Limit (dBm/500KHz)
5745	4.04	29.37
5785	3.62	29.37
5825	3.56	29.37

802.11n HT20

Frequency MHz	RF Power Density Reading (dBm/MHz)	Maximum Limit (dBm/MHz)
5180	7.60	16.37
5260	7.70	10.37
5320	7.48	10.37
5500	8.57	10.37
5600	8.44	10.37
5700	7.79	10.37
Frequency MHz	RF Power Density Reading (dBm/500KHz)	Maximum Limit (dBm/500KHz)
5745	3.38	29.37
5785	3.70	29.37
5825	2.84	29.37

802.11n HT40 Mode

Frequency MHz	RF Power Density Reading (dBm/MHz)	Maximum Limit (dBm/MHz)
5190	4.64	16.37
5270	3.83	10.37
5310	3.66	10.37
5510	4.82	10.37
5550	5.13	10.37
5670	4.23	10.37
Frequency MHz	RF Power Density Reading (dBm/500KHz)	Maximum Limit (dBm/500KHz)
5755	0.71	29.37
5795	-0.16	29.37

802.11AC HT80 Mode

Frequency MHz	RF Power Density Reading (dBm/MHz)	Maximum Limit (dBm/MHz)
5210	1.11	16.37
5290	1.46	10.37
5530	2.41	10.37
5610	2.62	10.37
Frequency MHz	RF Power Density Reading (dBm/500KHz)	Maximum Limit (dBm/500KHz)
5775	-2.88	29.37

BAND 1, 2
802.11a
Power Spectral Density Data Plot (CH Low)

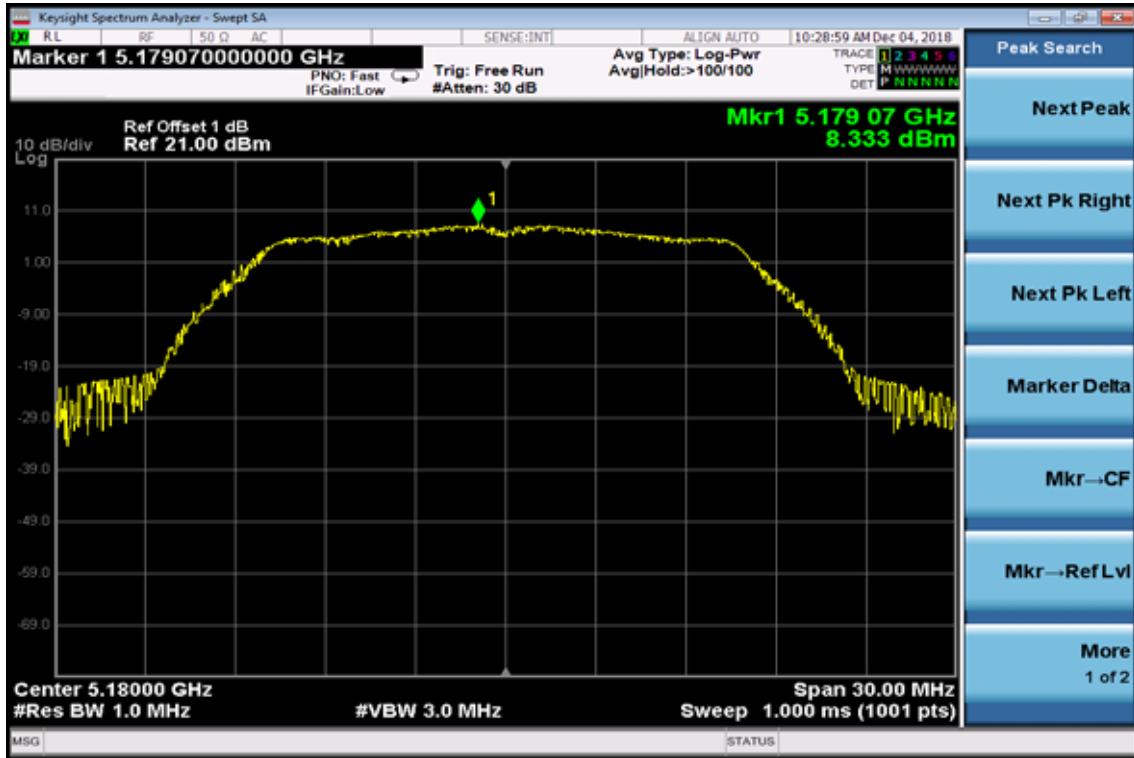

Power Spectral Density Data Plot (CH Mid)

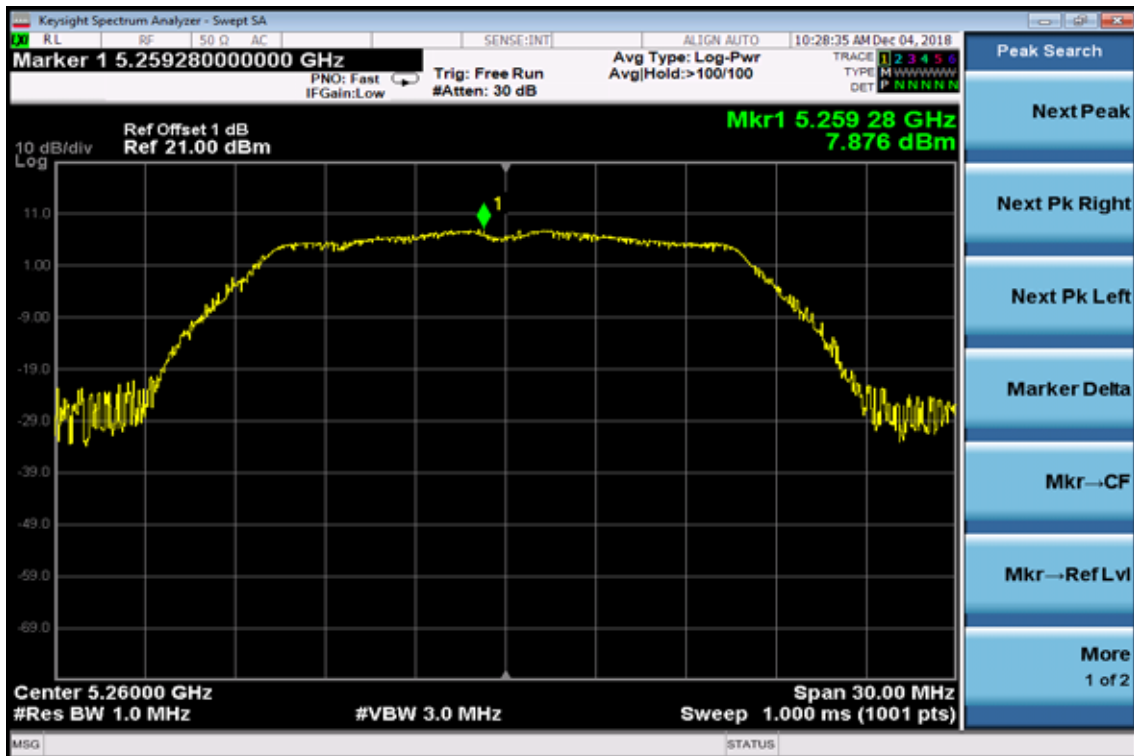

Power Spectral Density Data Plot (CH High)

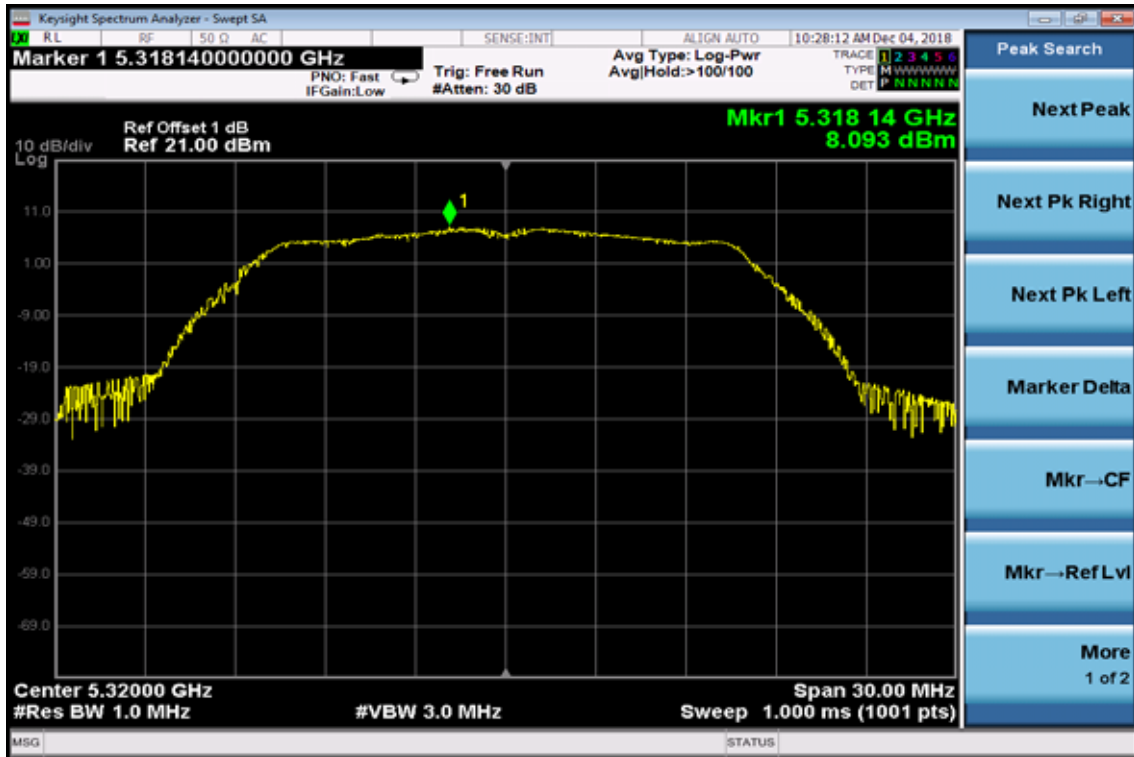

802.11n HT20

Power Spectral Density Test Plot (CH-Low)

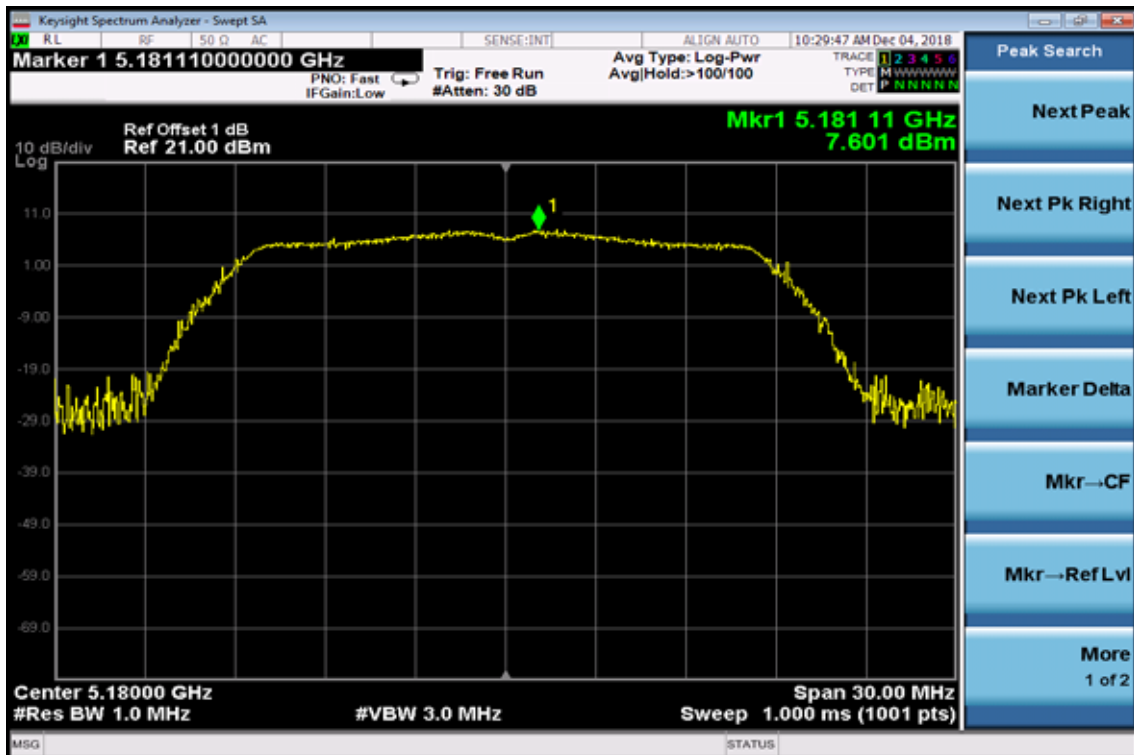

Power Spectral Density Test Plot (CH-Mid)

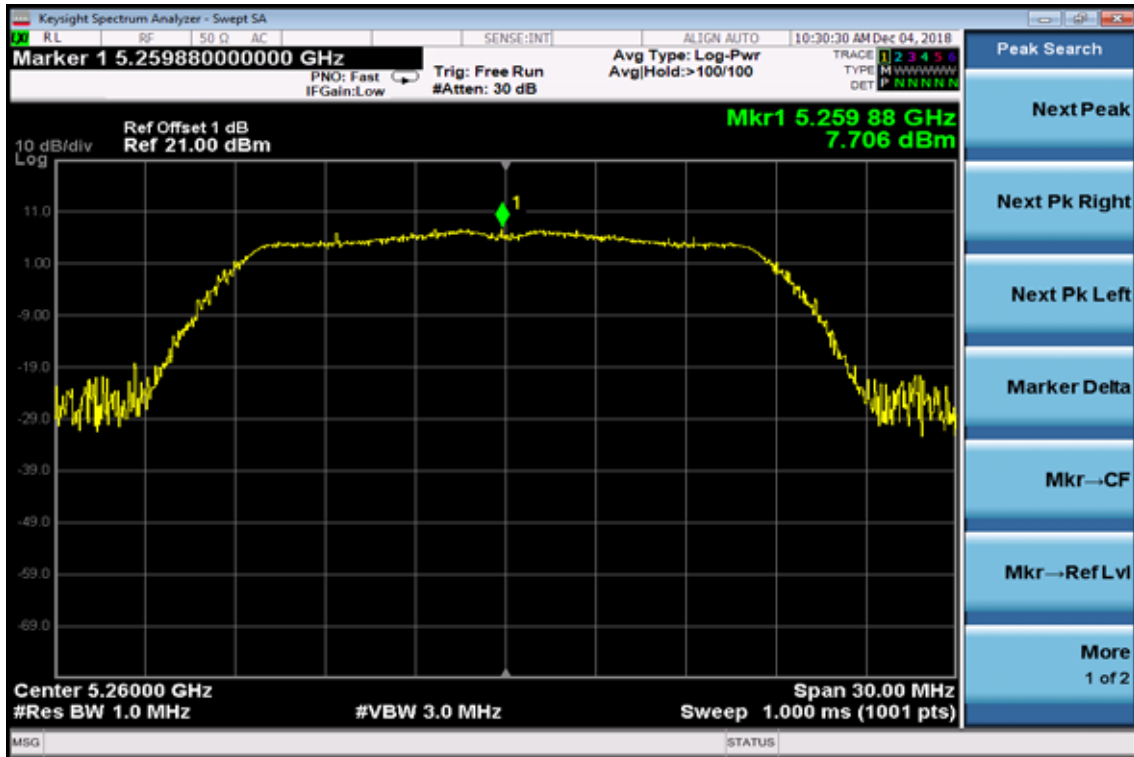

Power Spectral Density Test Plot (CH-High)

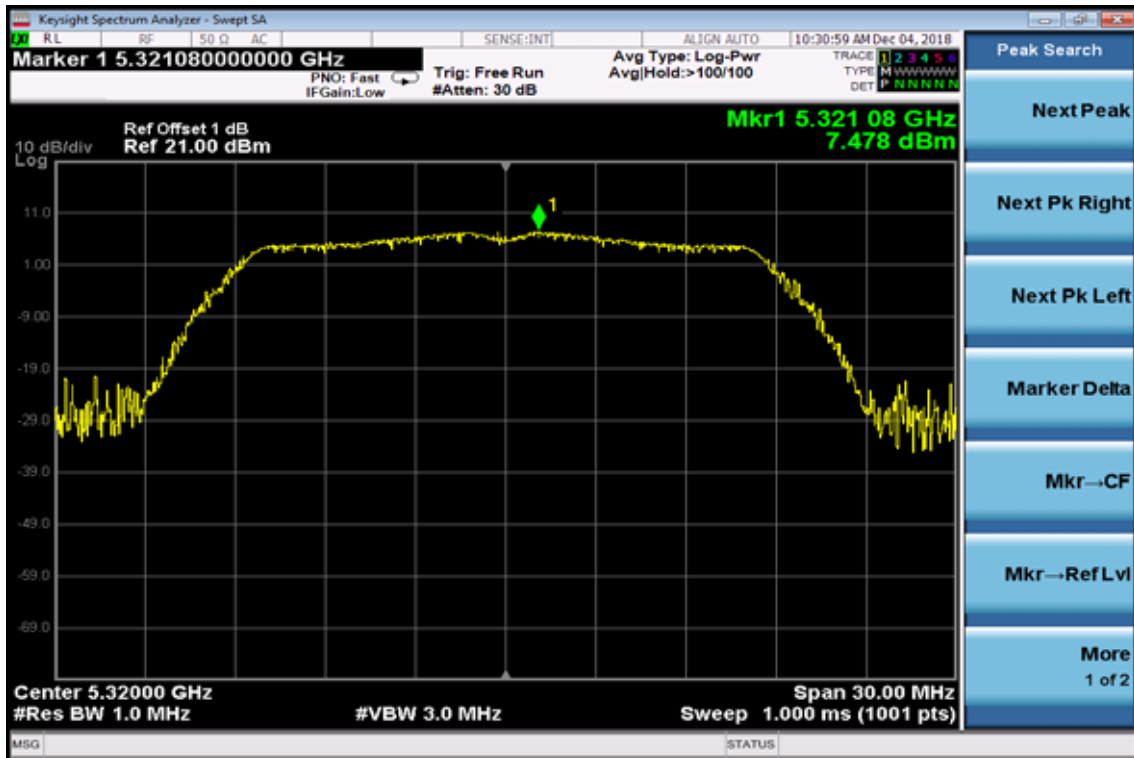

802.11n HT40

Power Spectral Density Test Plot (CH-Low)



Power Spectral Density Test Plot (CH-Mid)



Power Spectral Density Test Plot (CH-High)

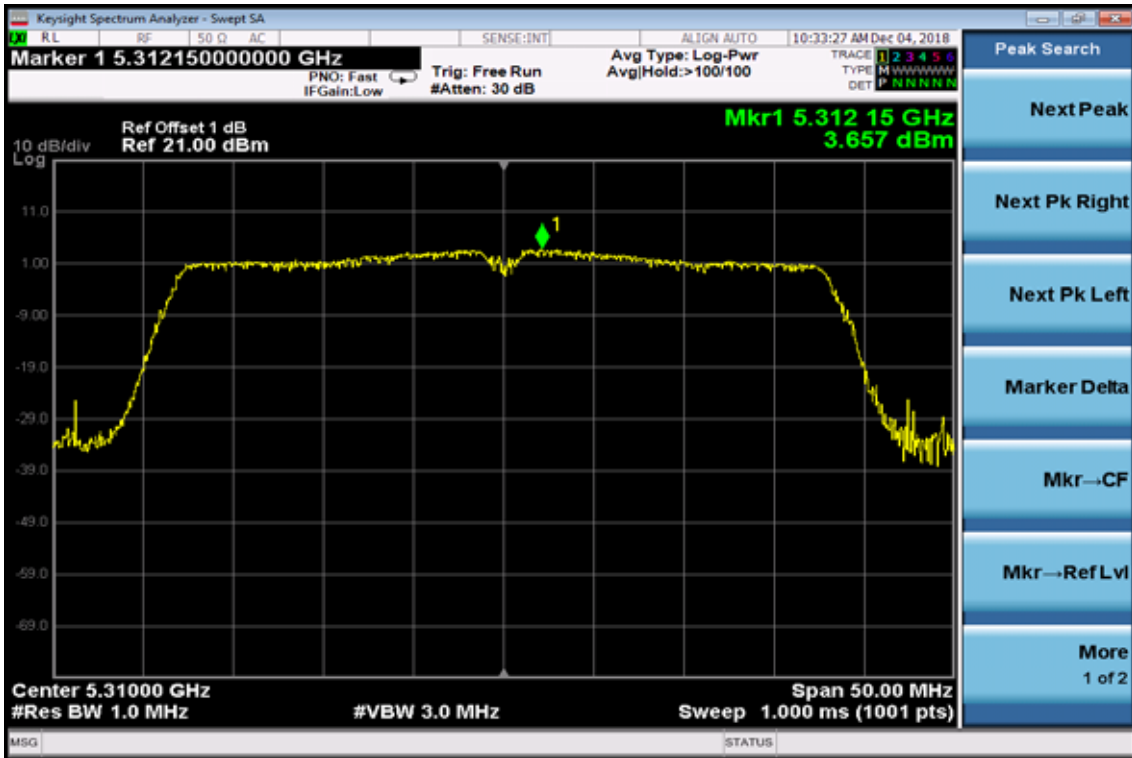

802.11ac HT80

Power Spectral Density Test Plot (CH-Low)

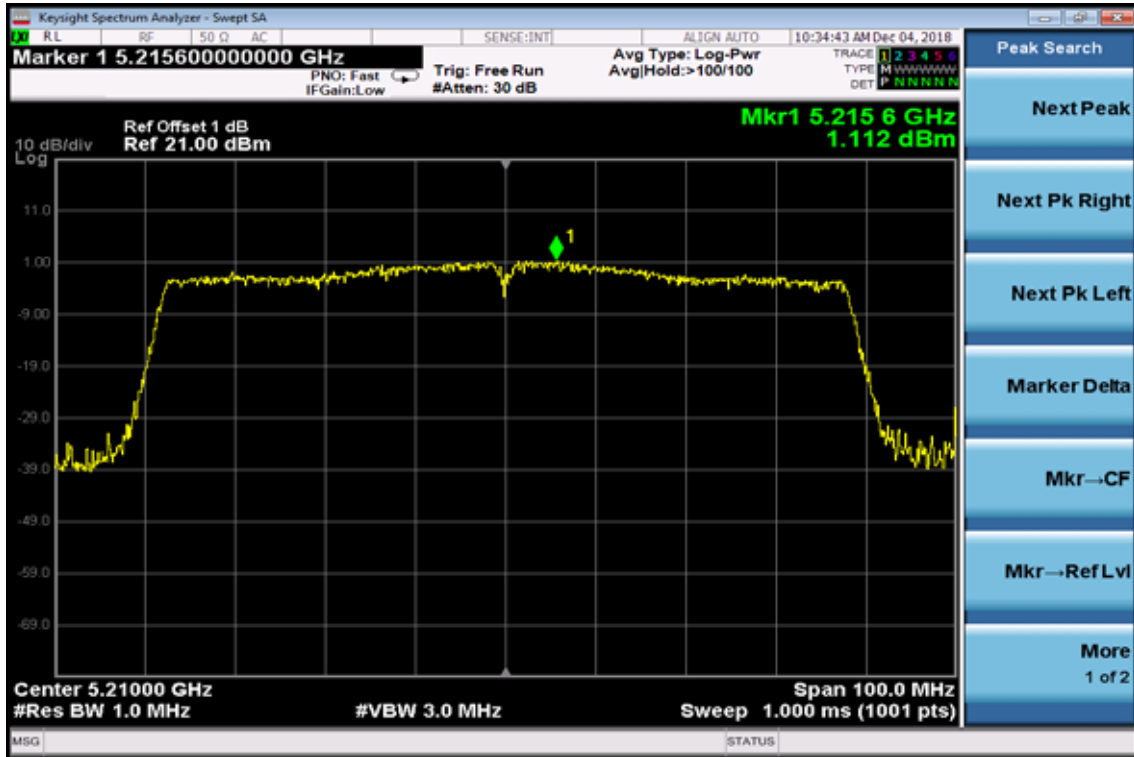

802.11ac HT80

Power Spectral Density Test Plot (CH-High)

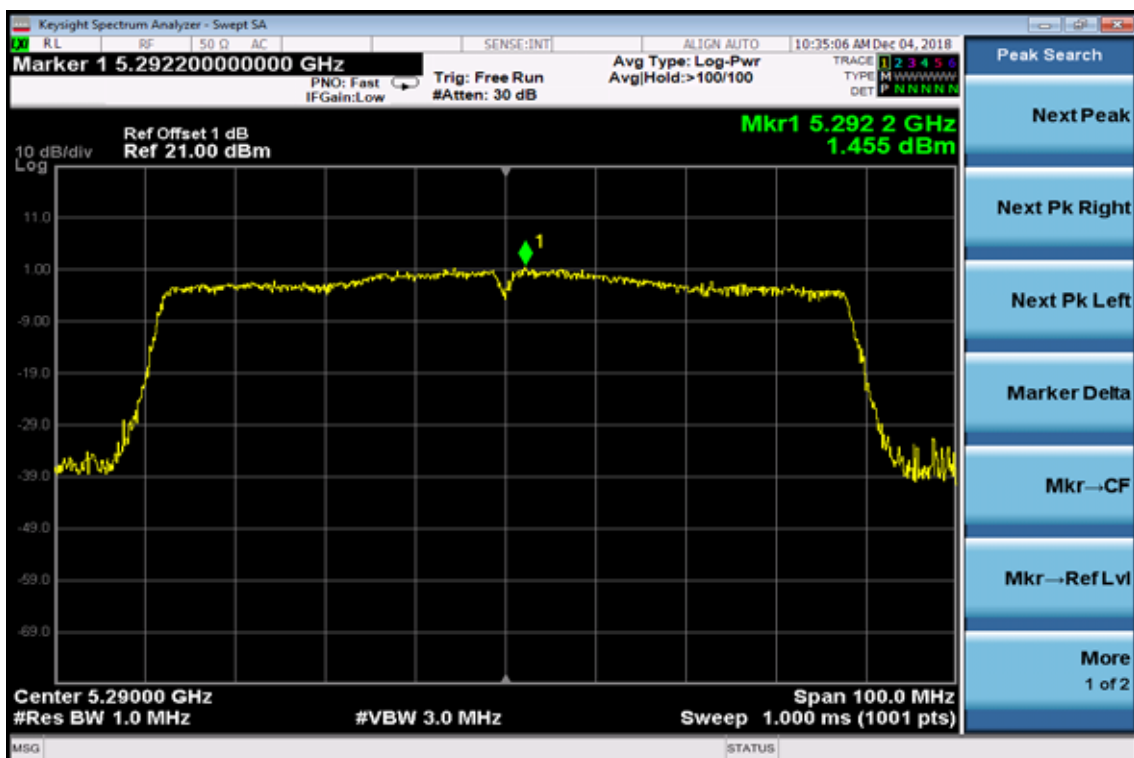

BAND 3

802.11a

Power Spectral Density Data Plot (CH Low)

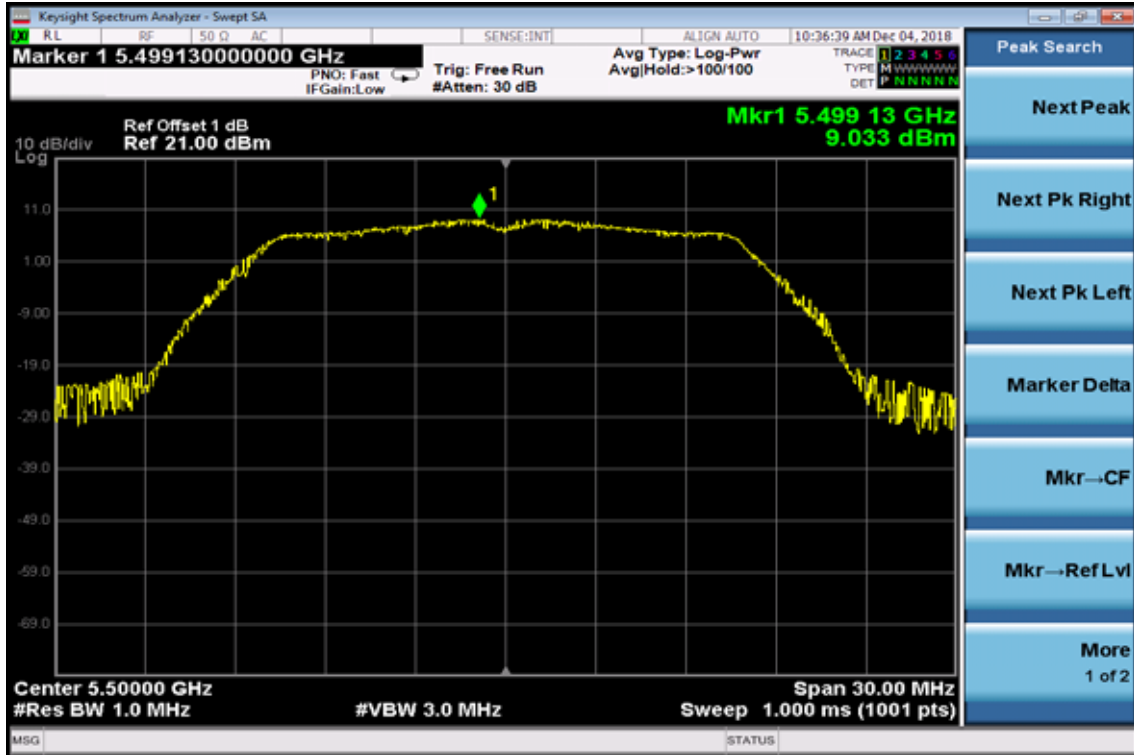

Power Spectral Density Data Plot (CH Mid)

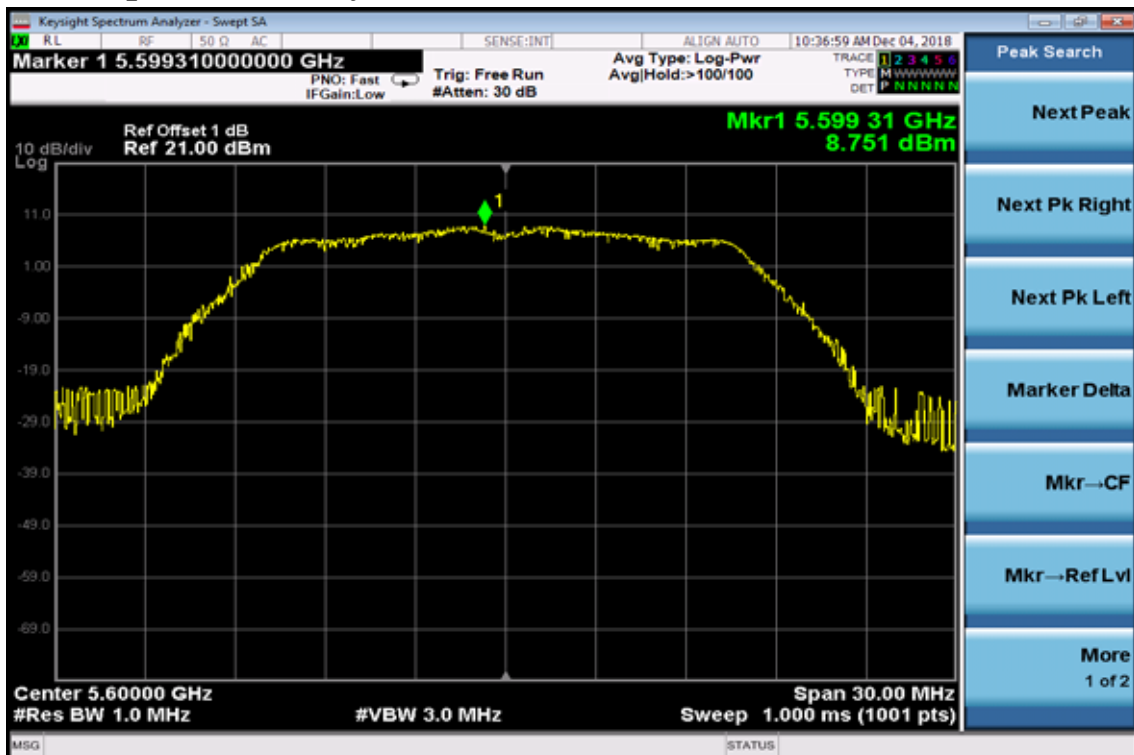

Power Spectral Density Data Plot (CH High)

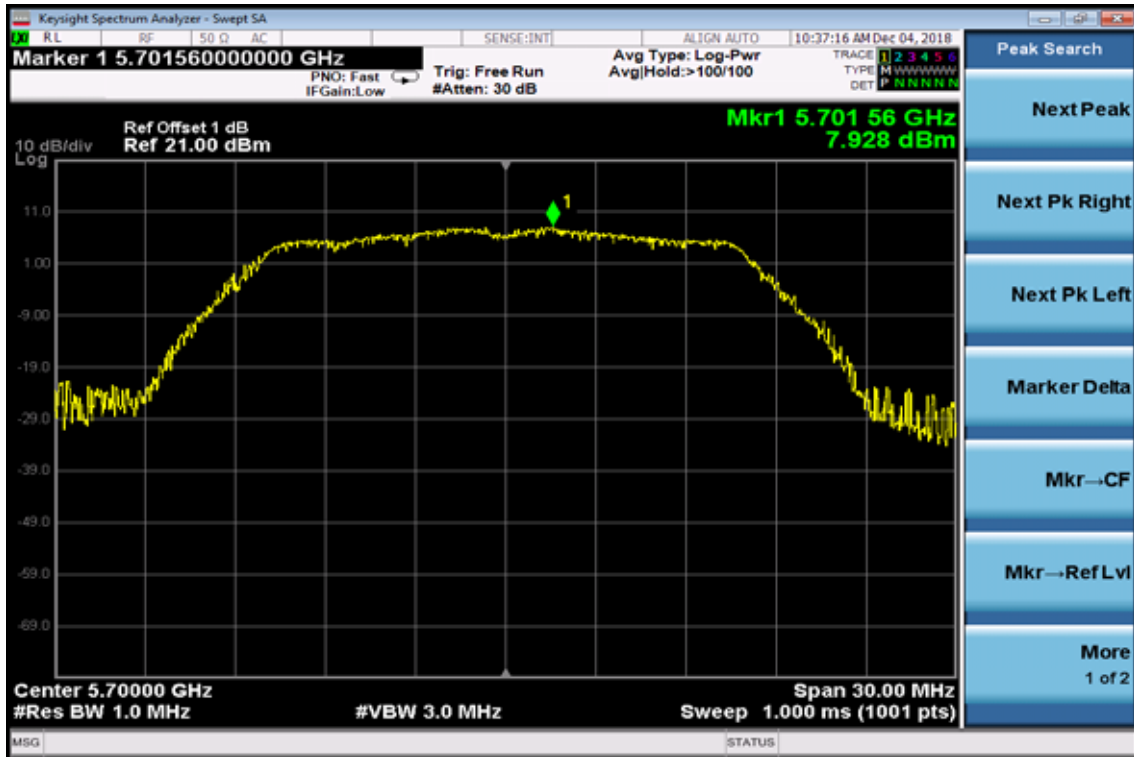

802.11n HT20

Power Spectral Density Test Plot (CH-Low)

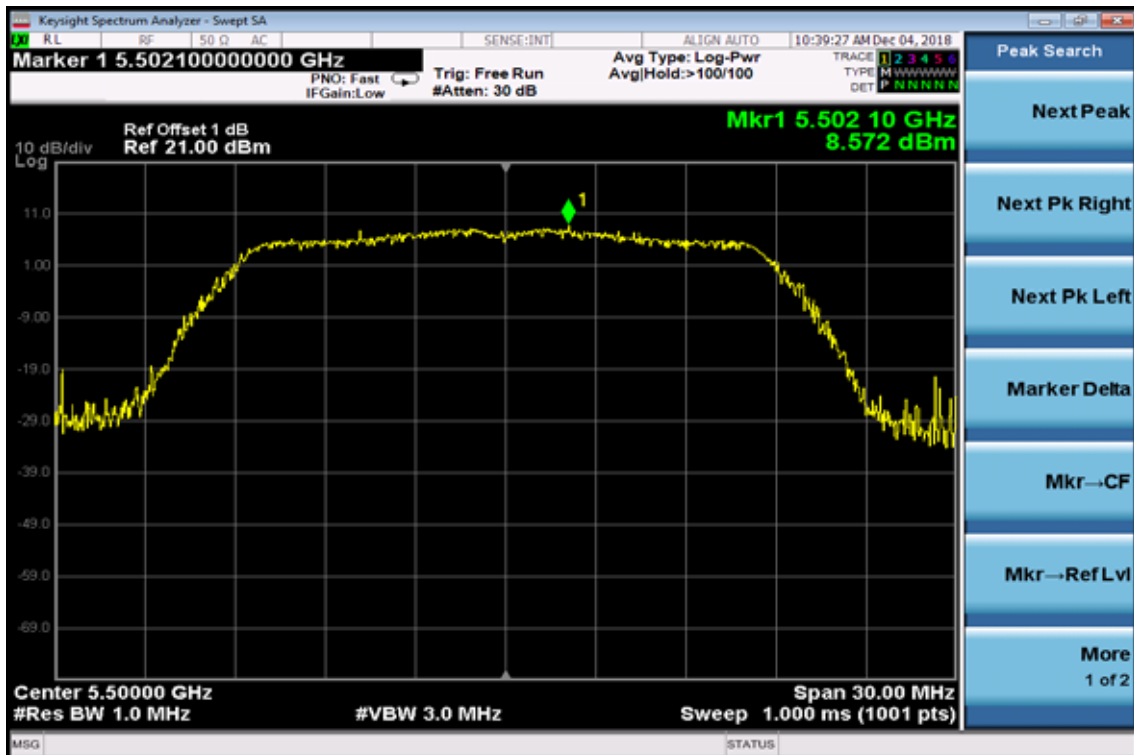

Power Spectral Density Test Plot (CH-Mid)

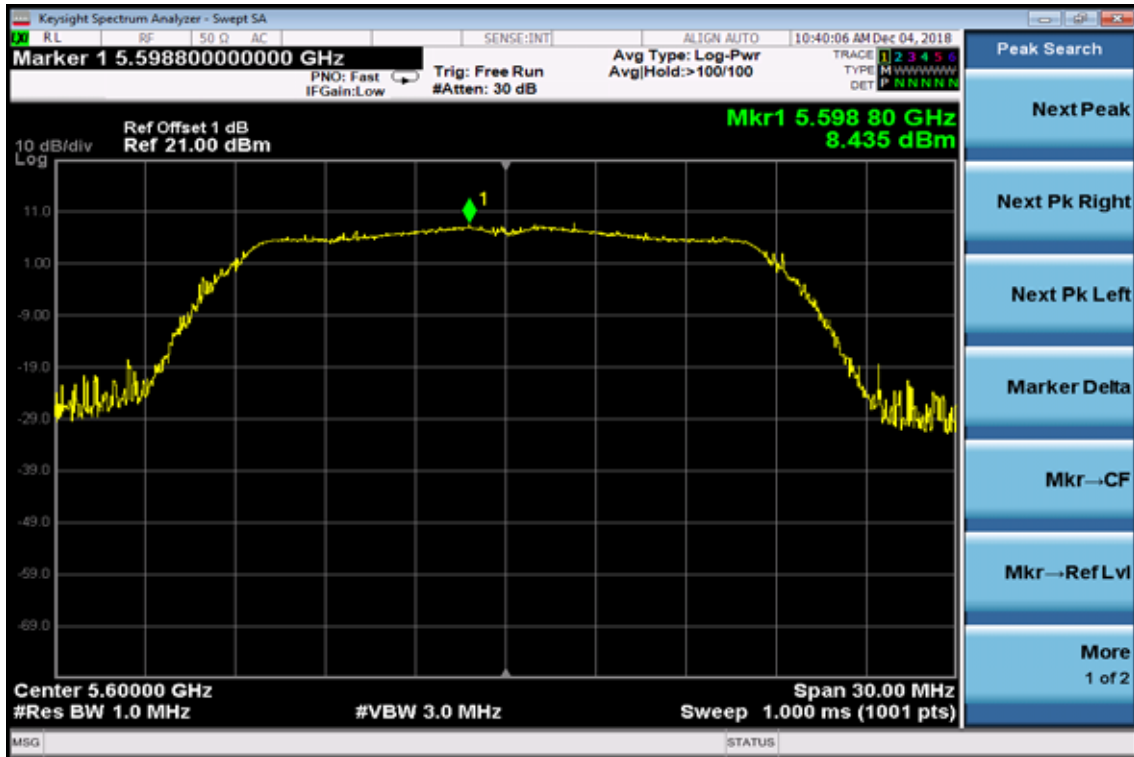

Power Spectral Density Test Plot (CH-High)

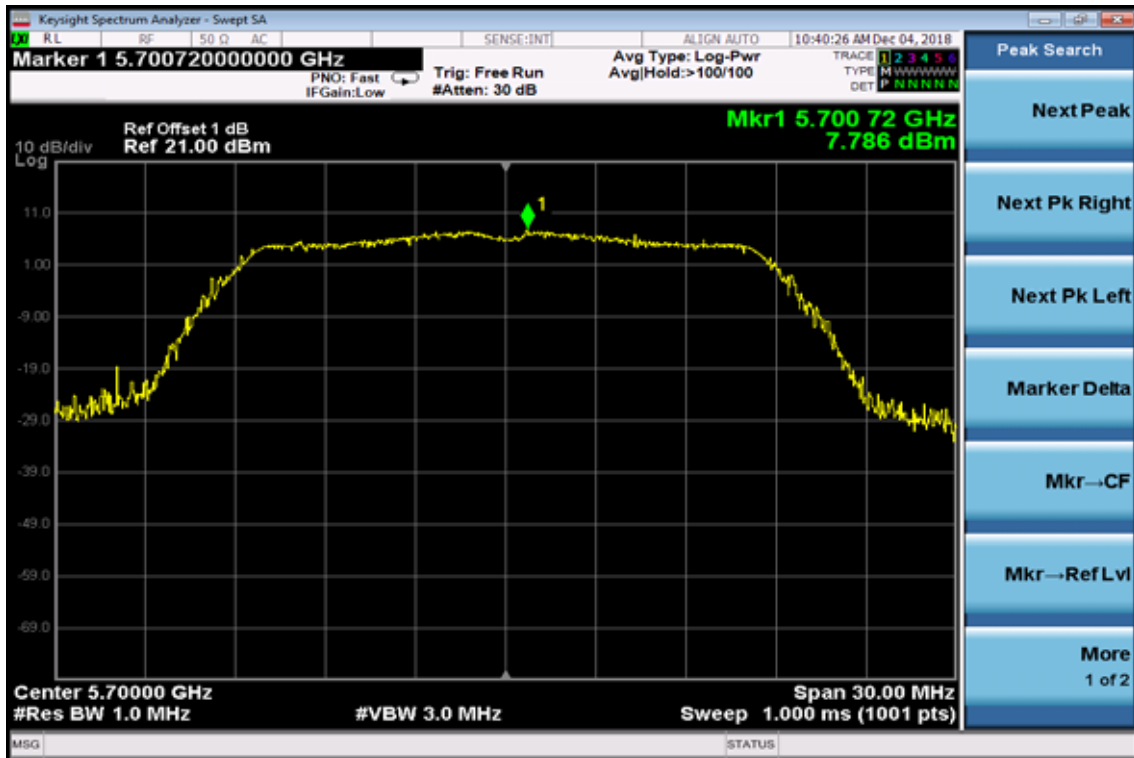

802.11n HT40 Power Spectral Density Test Plot (CH-Low)



Power Spectral Density Test Plot (CH-Mid)



Power Spectral Density Test Plot (CH-High)

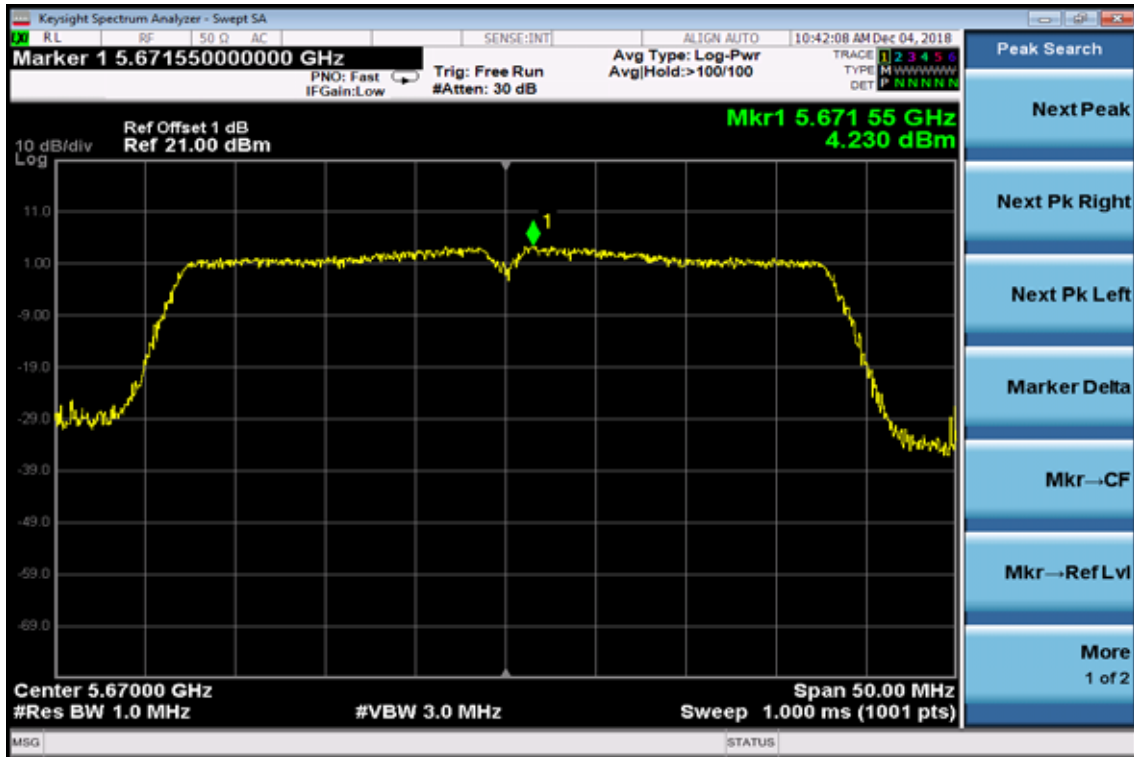

802.11ac HT80
Power Spectral Density Test Plot (CH-Low)

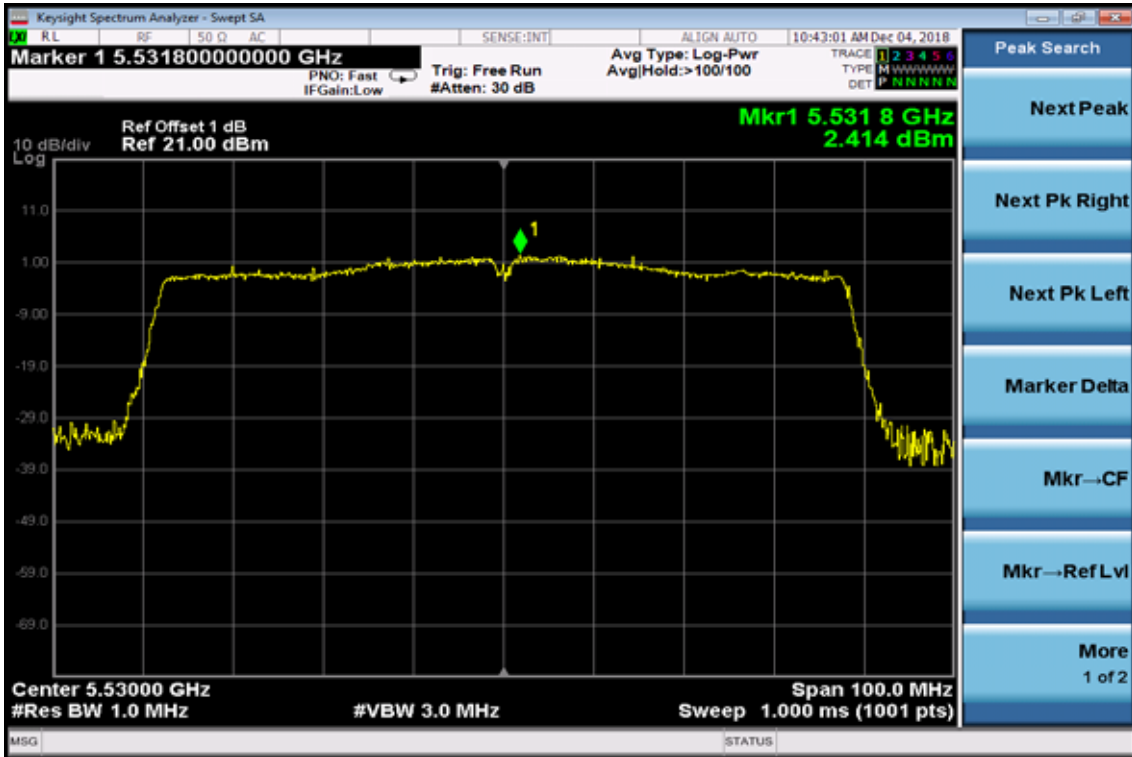

802.11ac HT80
Power Spectral Density Test Plot (CH-High)



BAND 4
802.11a
Power Spectral Density Data Plot (CH Low)

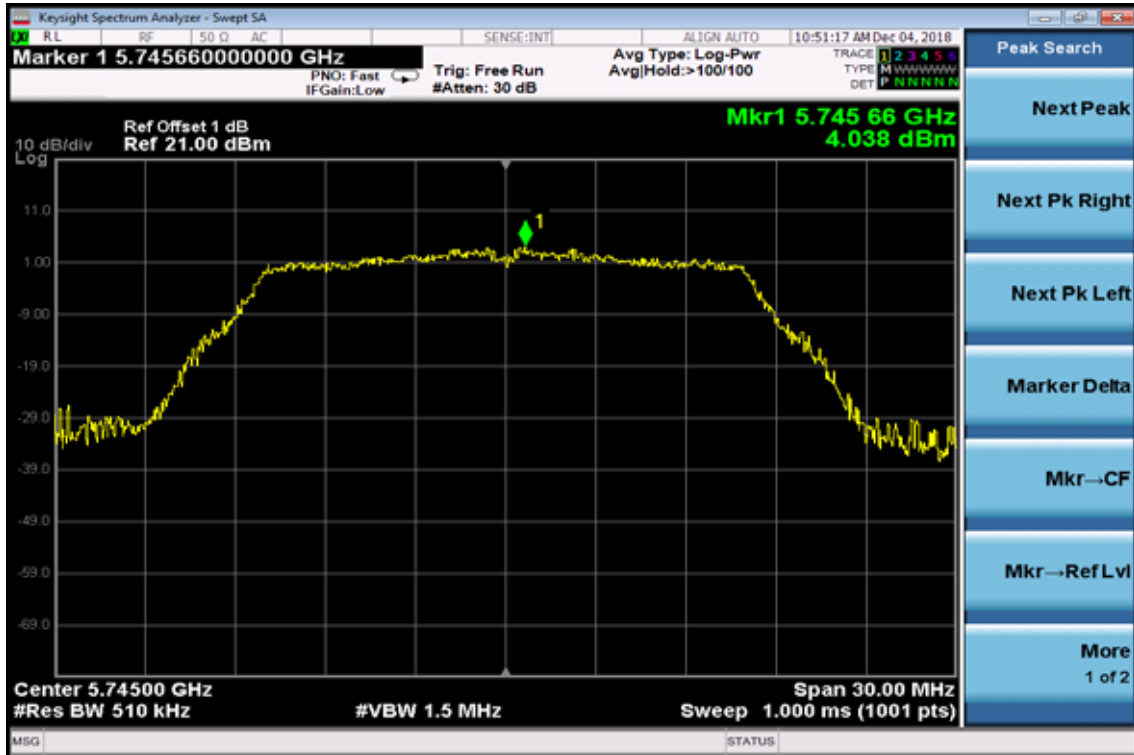

Power Spectral Density Data Plot (CH Mid)

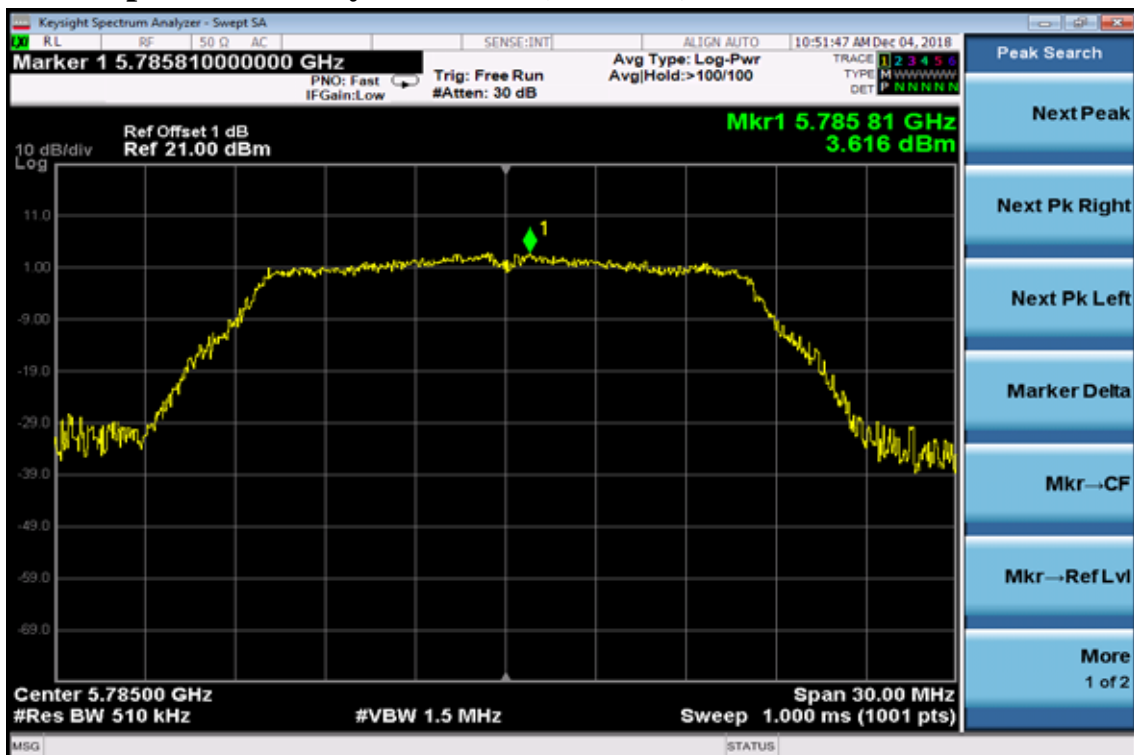

Power Spectral Density Data Plot (CH High)

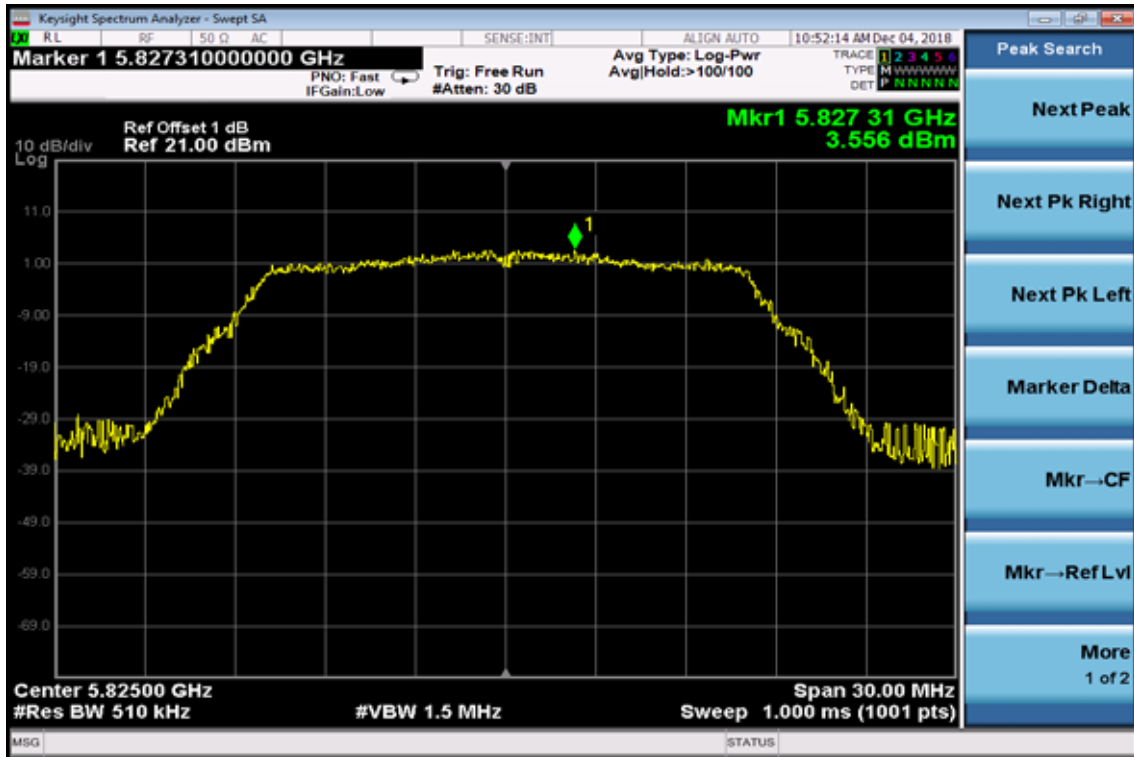

802.11n HT20

Power Spectral Density Test Plot (CH-Low)

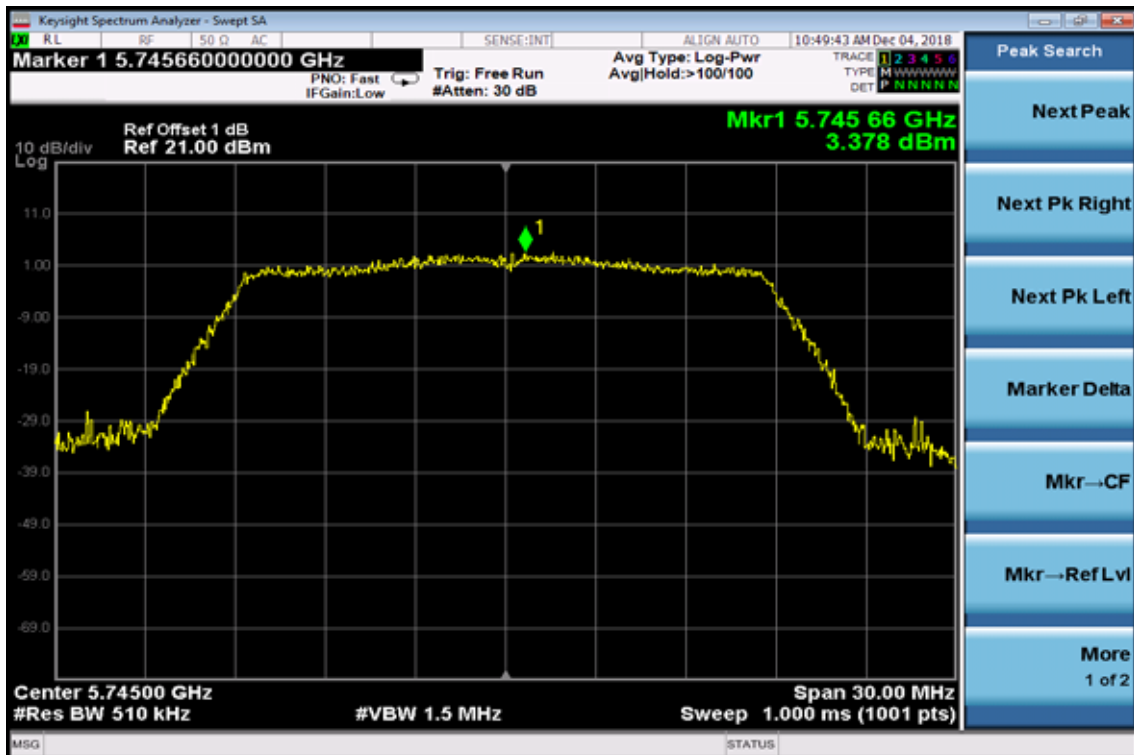

Power Spectral Density Test Plot (CH-Mid)

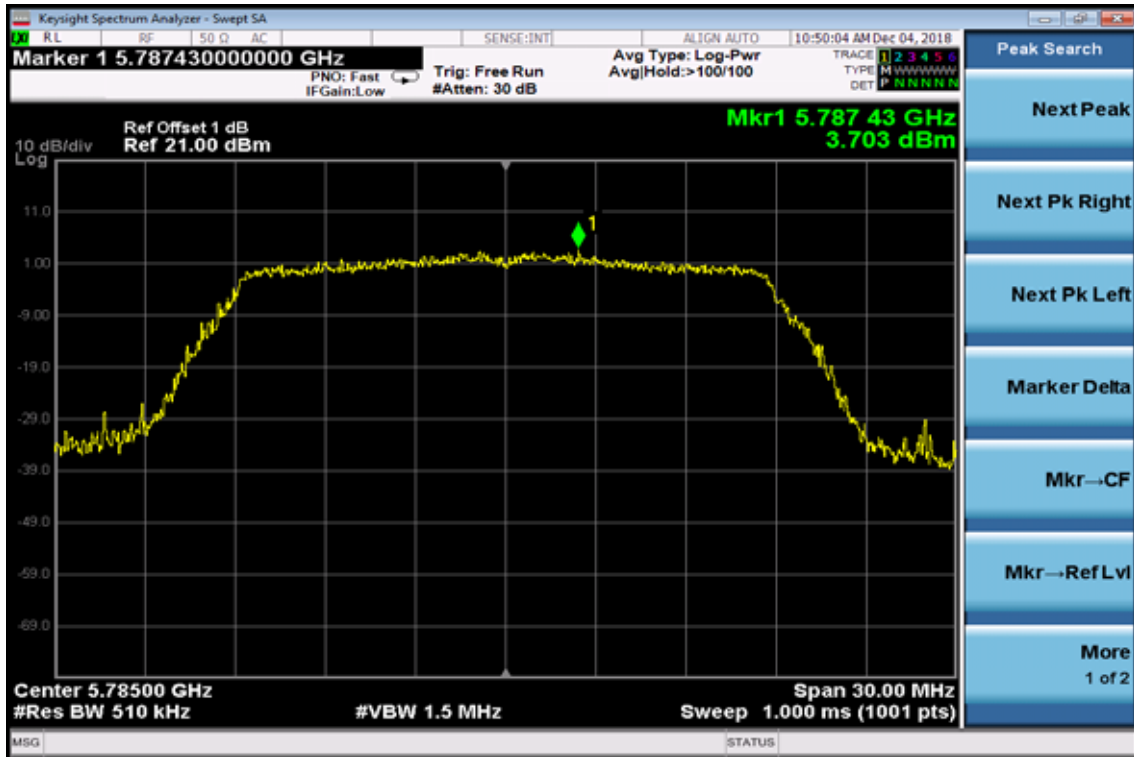

Power Spectral Density Test Plot (CH-High)

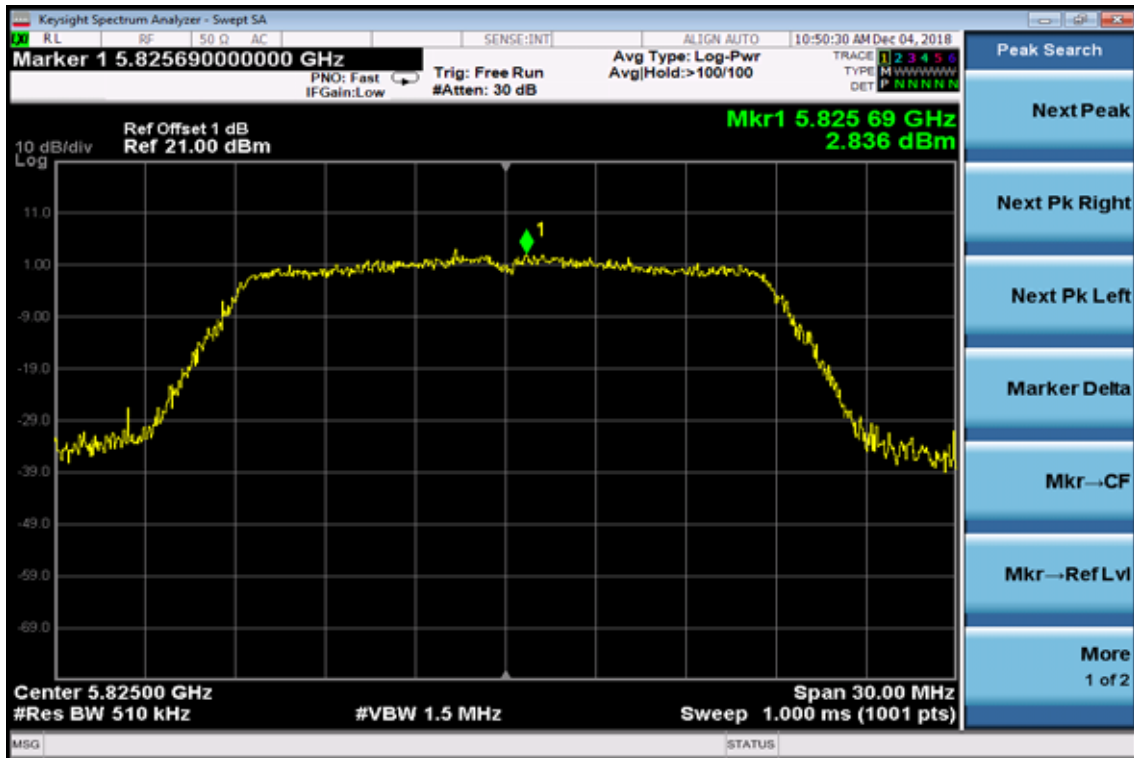

802.11n HT40

Power Spectral Density Test Plot (CH-Low)

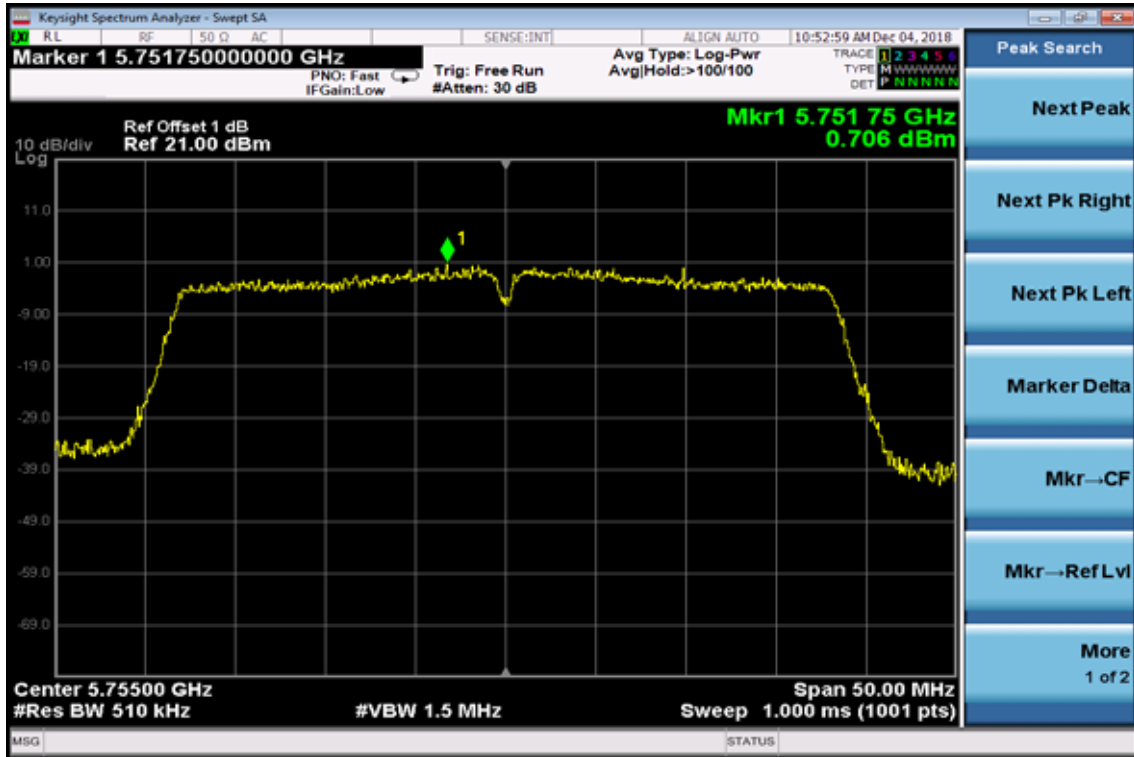

Power Spectral Density Test Plot (CH-High)

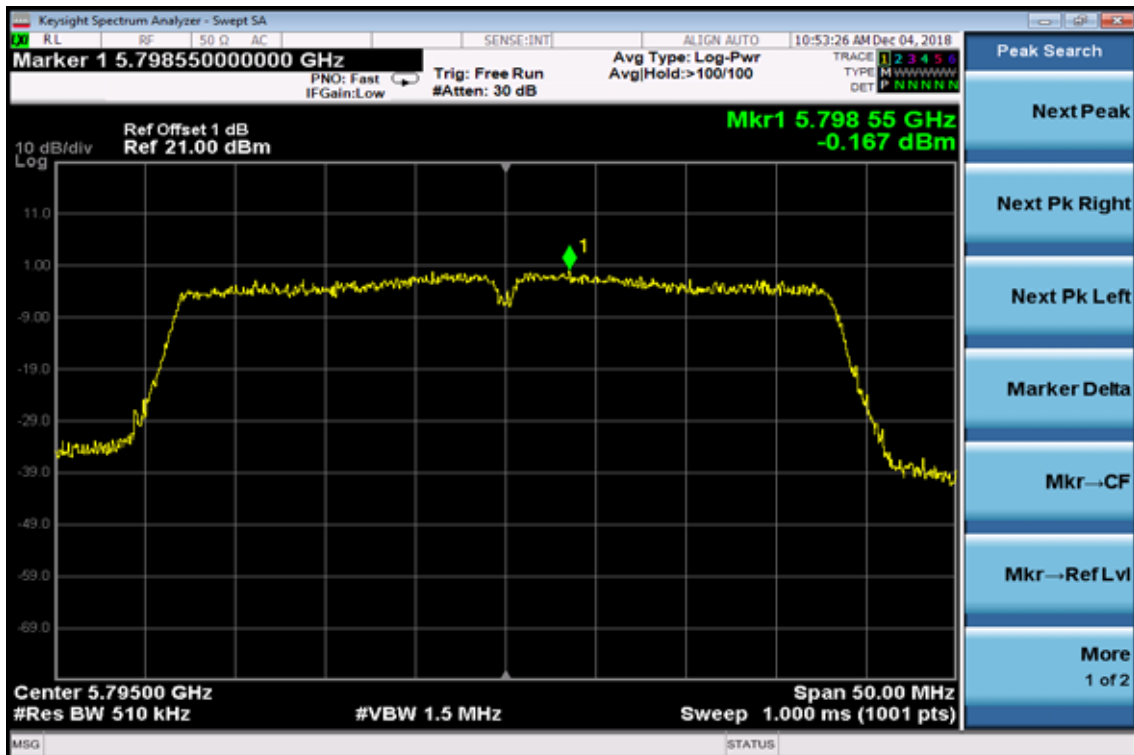

802.11ac HT80 Power Spectral Density Test Plot

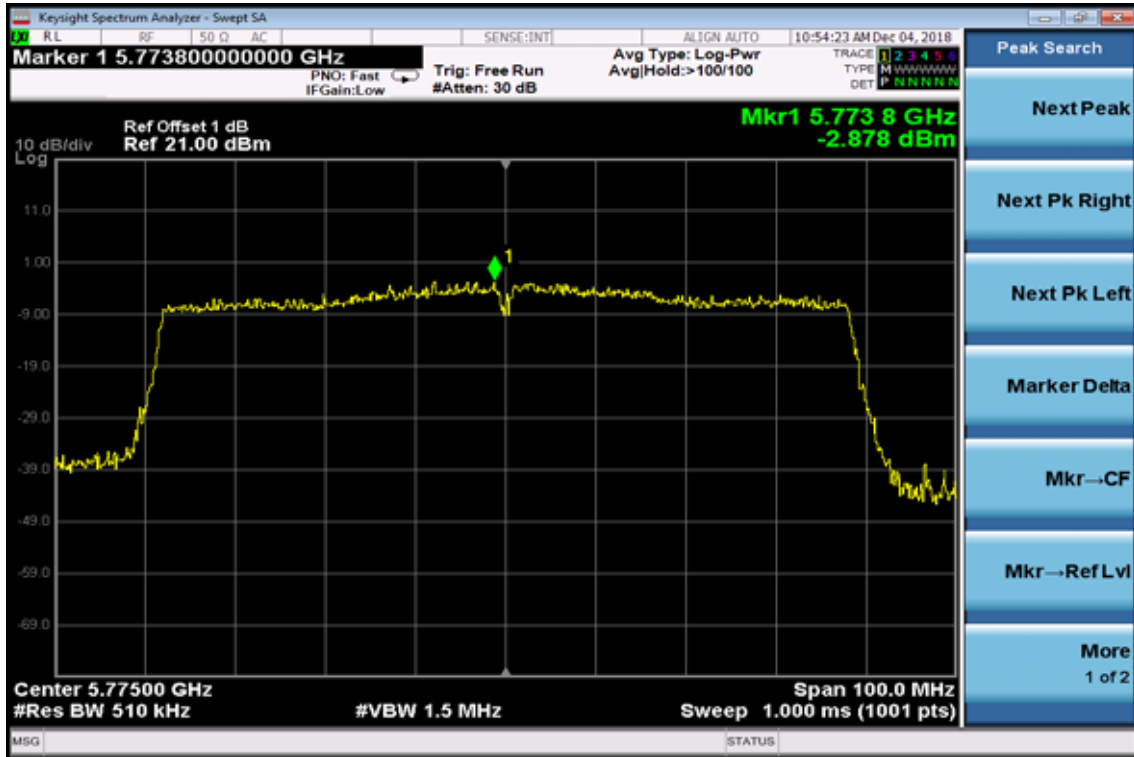

7. 26dB /99% Emission Bandwidth Measurement

7.1. Standard Applicable

According to §15.407(a) for band 1,2,3. No Limit required.

7.2. Measurement Procedure

1. Place the EUT on the table and set it in transmitting mode.
2. Remove the antenna from the EUT and then connect a low loss RF cable from the antenna port to the spectrum analyzer.
3. Set the spectrum analyzer as RBW=300kHz, VBW =1MHz, Span= 50MHz, Sweep=auto
4. Mark the peak frequency and -26dB (upper and lower) frequency.
5. Repeat above procedures until all frequency measured were complete.

Refer to section D of KDB Document: KDB 789033 D02 General UNII Test Procedures New Rules v02r01

7.3. Measurement Equipment Used:

Refer to section 6.3 for details.

7.4. Test Set-up:

Refer to section 6.4 for details.

7.5. Measurement Result

802.11a Mode

Frequency (MHz)	26dB Bandwidth (MHz)	99% Bandwidth (MHz)
5180	21.420	16.819
5260	21.110	16.753
5320	21.160	16.767
5500	21.540	16.835
5600	21.430	16.800
5700	21.260	16.775

802.11n HT20 Mode

Frequency (MHz)	26dB Bandwidth (MHz)	99% Bandwidth (MHz)
5180	21.480	17.863
5260	21.530	17.910
5320	21.420	16.802
5500	21.720	17.902
5600	21.530	17.841
5700	21.450	17.886

802.11n HT40 Mode

Frequency (MHz)	26dB Bandwidth (MHz)	99% Bandwidth (MHz)
5190	39.800	36.237
5270	39.440	36.212
5310	39.570	36.215
5510	39.700	36.266
5570	39.810	36.237
5670	40.100	36.224

802.11a HT80 Mode

Frequency (MHz)	26dB Bandwidth (MHz)	99% Bandwidth (MHz)
5210	80.820	75.529
5290	80.840	75.556
5530	81.230	75.522
5610	81.280	75.626

Band 1, 2

802.11a

26dB / 99% Band Width Test Data CH-Low

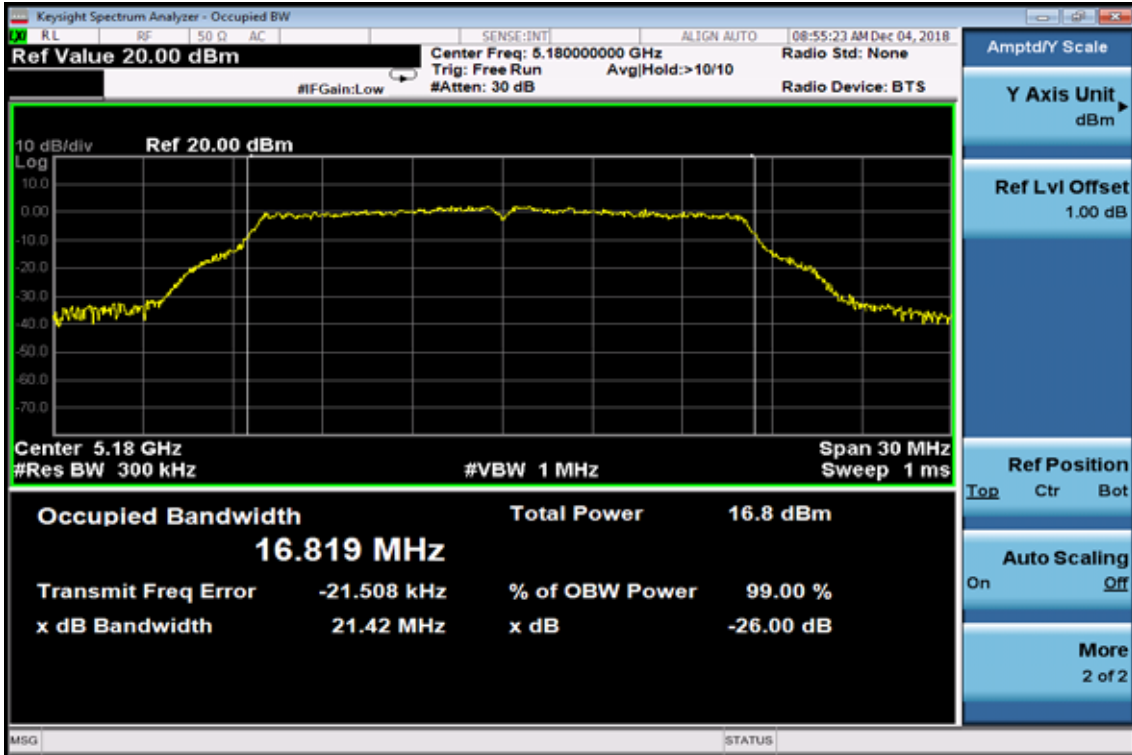

26dB / 99% Band Width Test Data CH-Mid

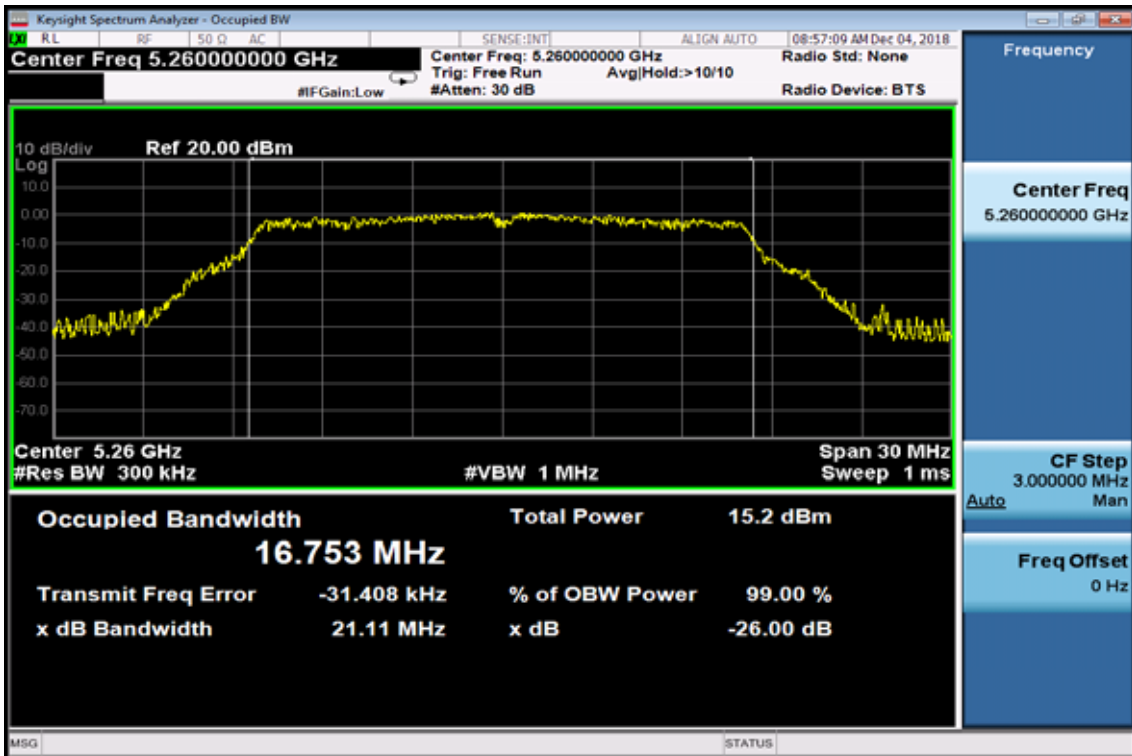

26dB / 99% Band Width Test Data CH-High

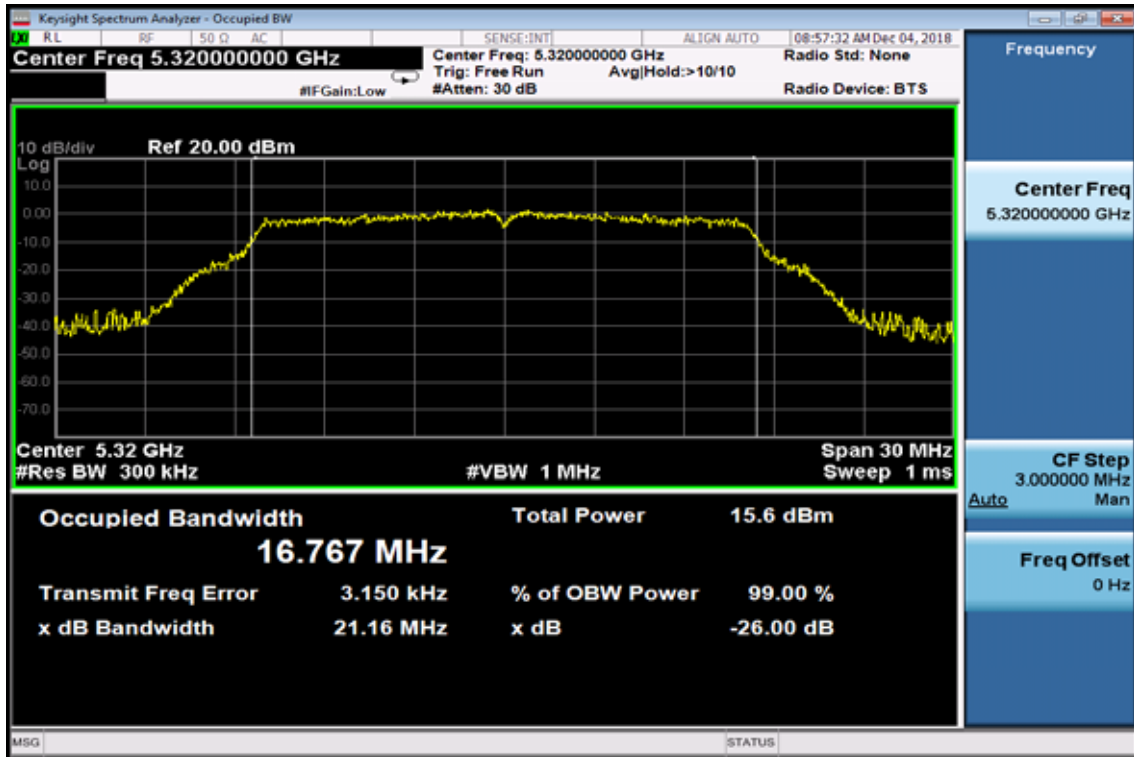

802.11n HT20

26dB / 99% Band Width Test Data CH-Low

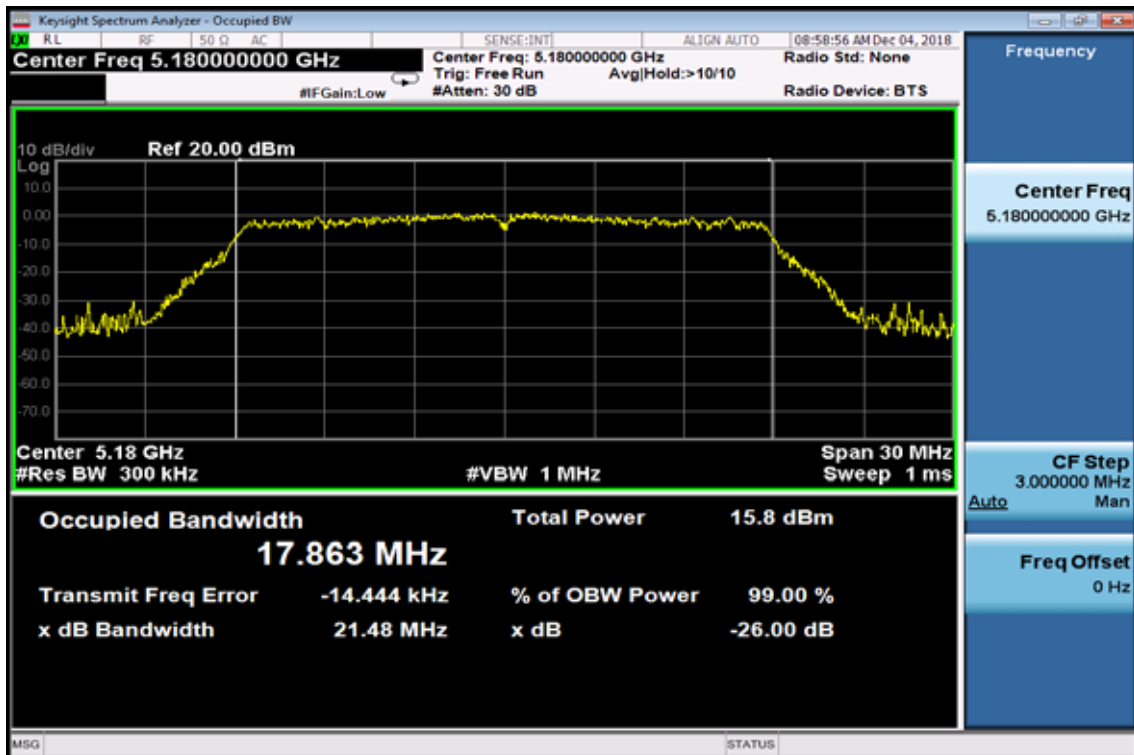

26dB / 99% Band Width Test Data CH-Mid

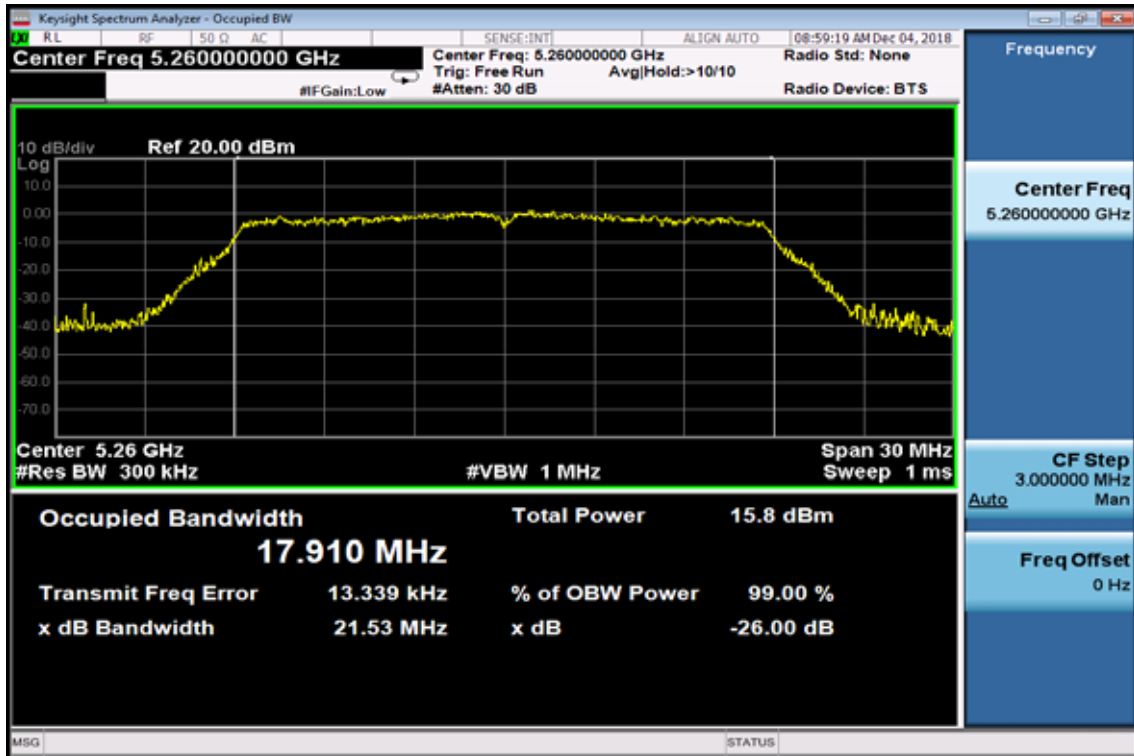

26dB / 99% Band Width Test Data CH-High

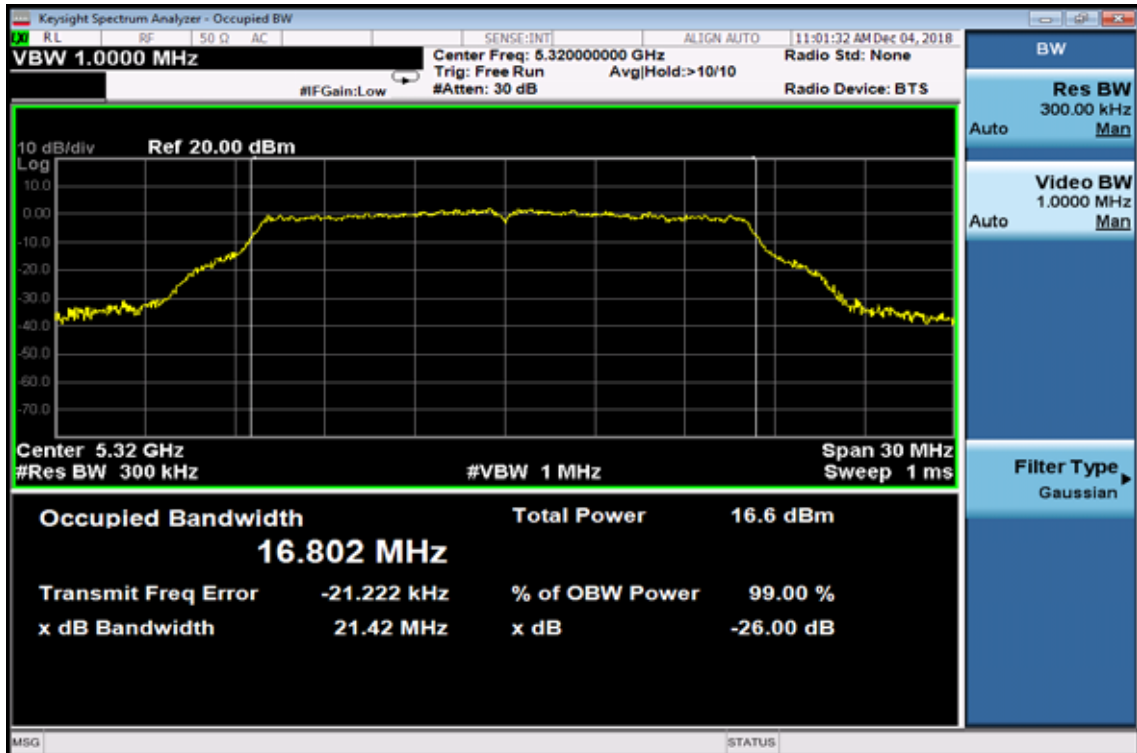

802.11n HT40

26dB / 99% Band Width Test Data CH-Low

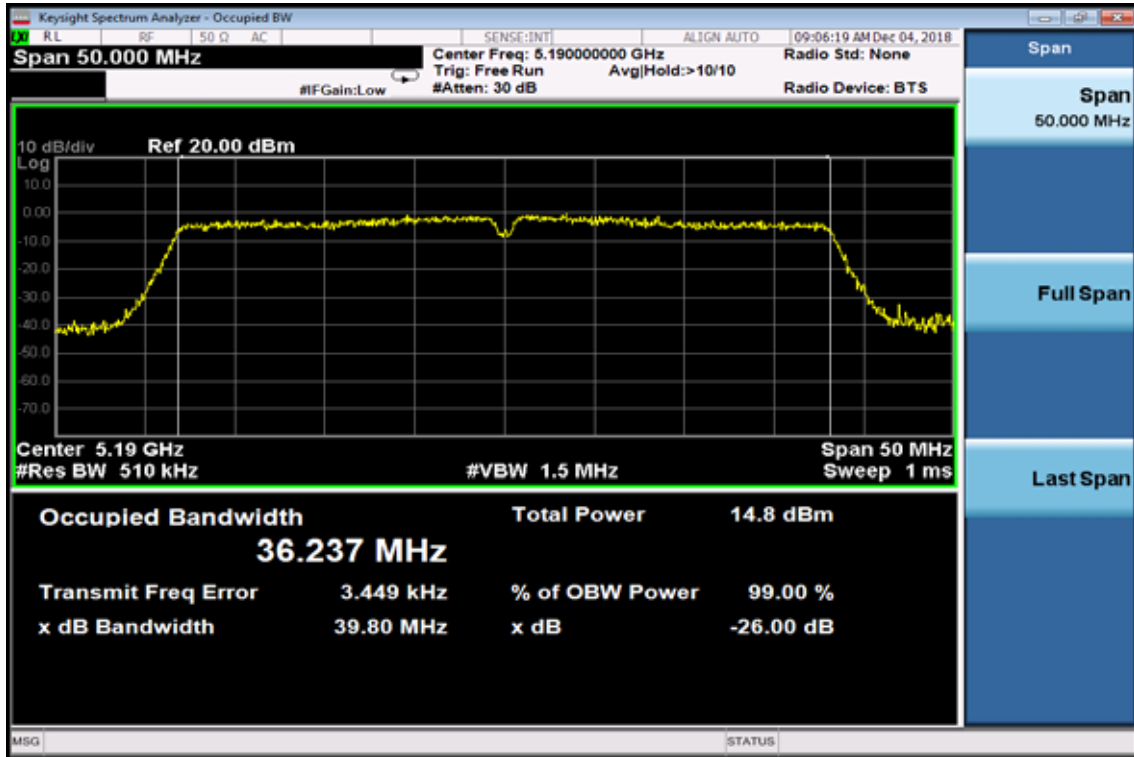

26dB / 99% Band Width Test Data CH-Mid

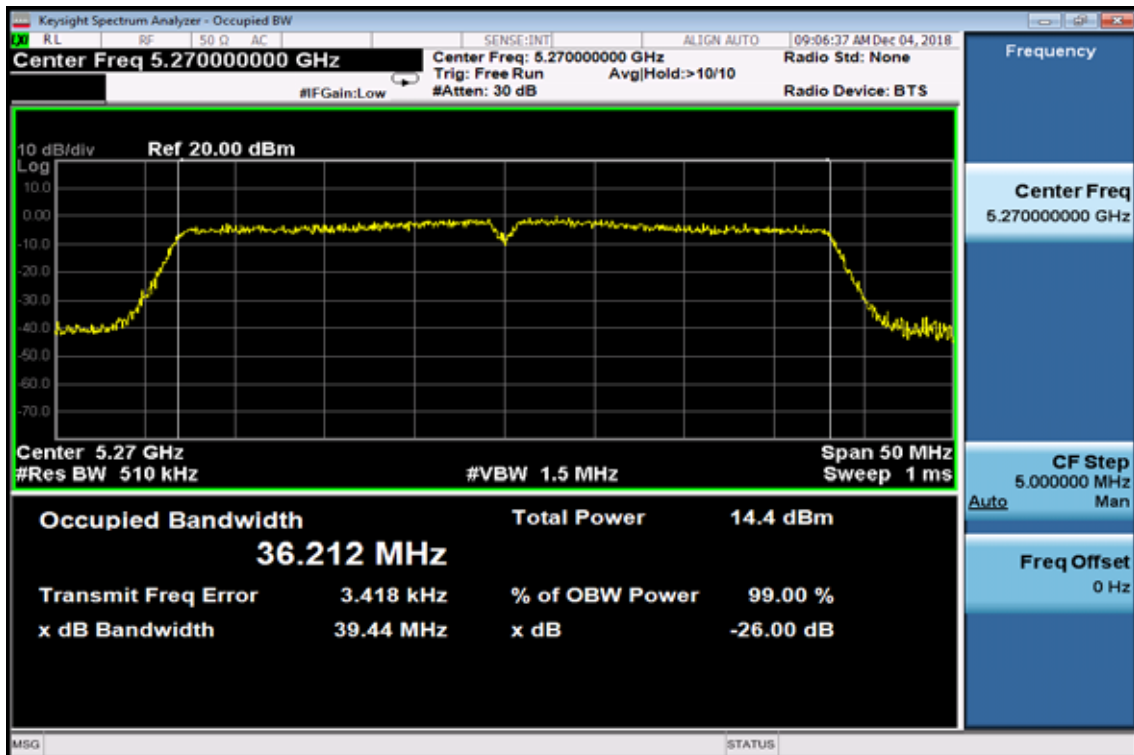

26dB / 99% Band Width Test Data CH-High

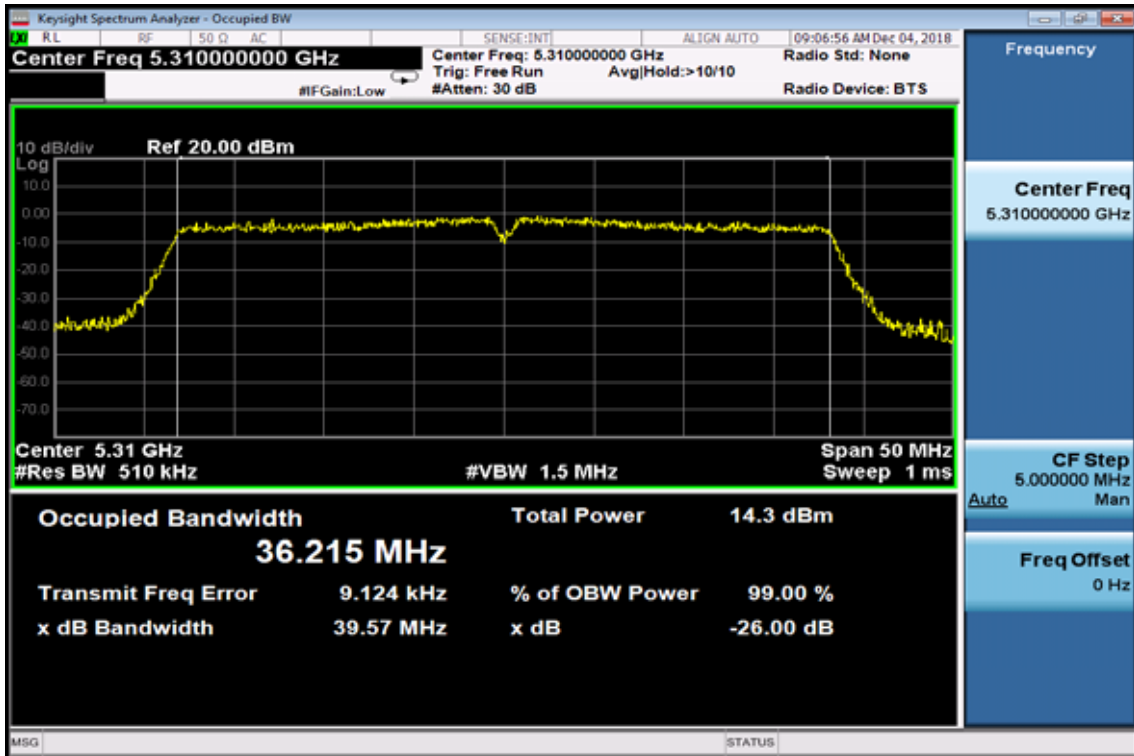

802.11ac HT80

26dB / 99% Band Width Test Data CH-Low

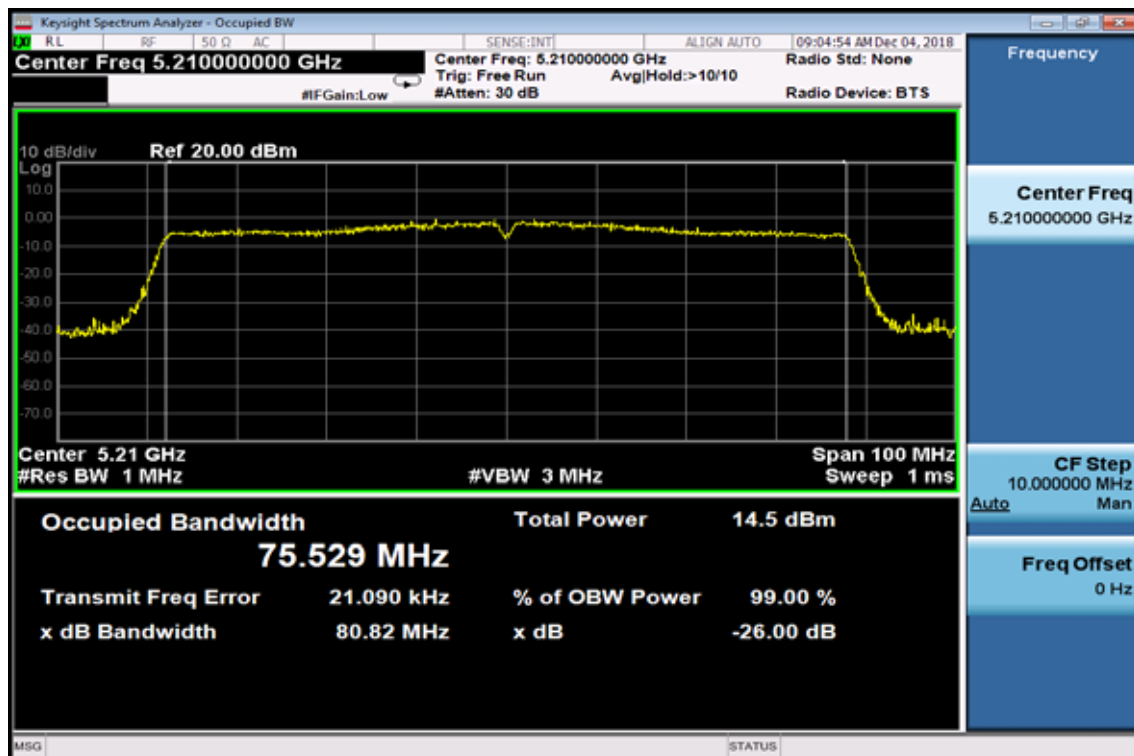

802.11ac HT80

26dB / 99% Band Width Test Data CH-High

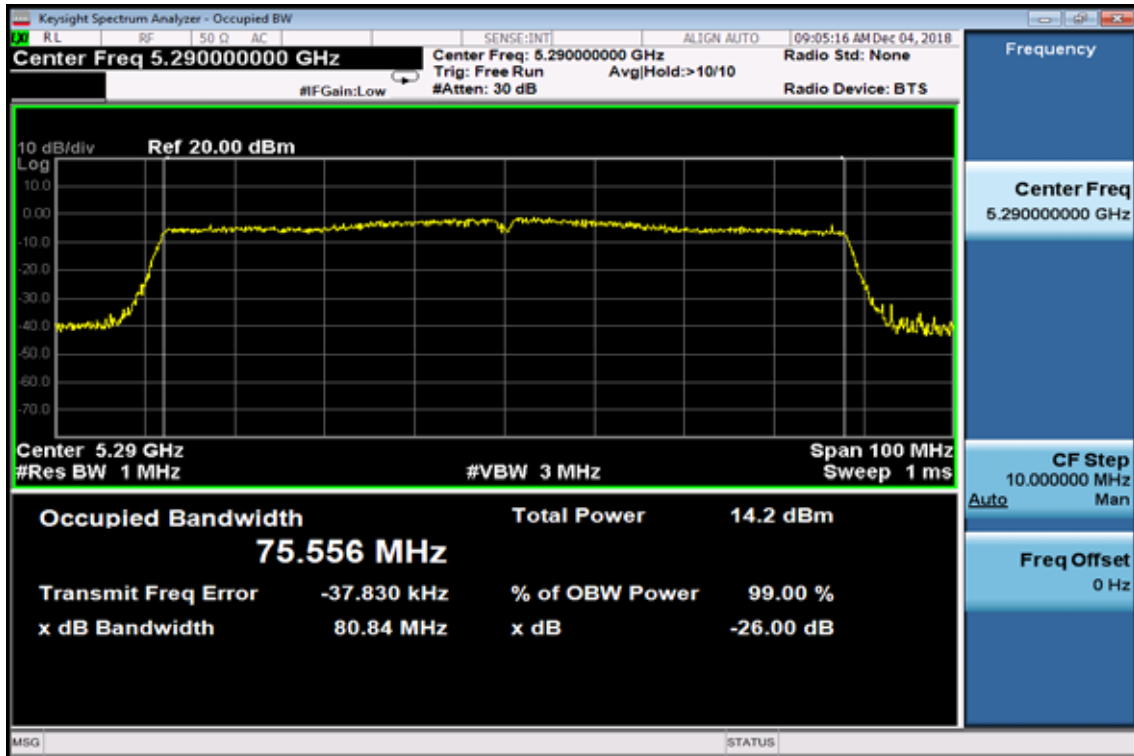

Band 3

802.11a

26dB / 99% Band Width Test Data CH-Low

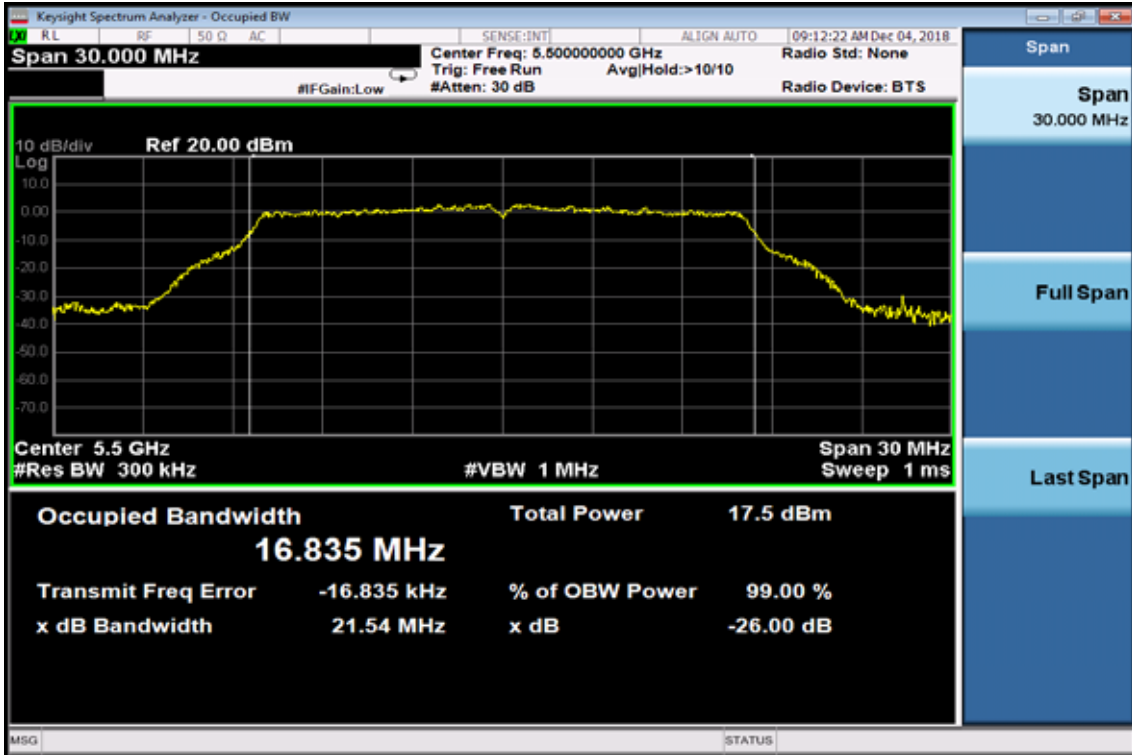

26dB / 99% Band Width Test Data CH-Mid

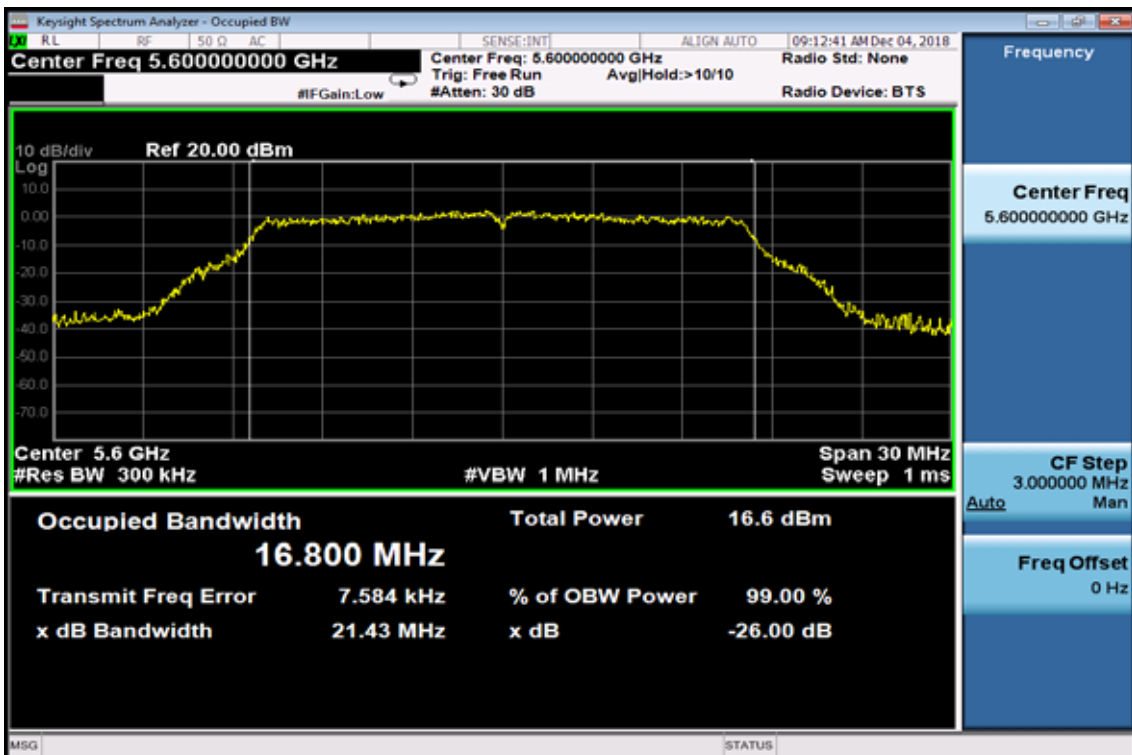

26dB / 99% Band Width Test Data CH-High

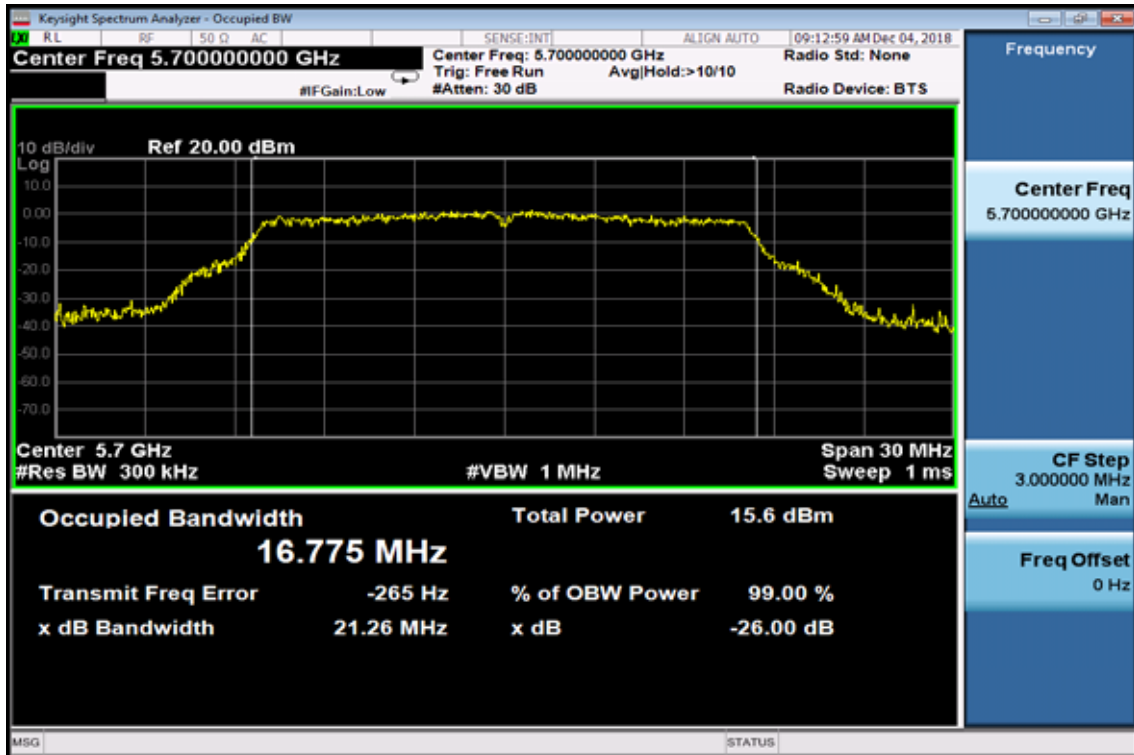

802.11n HT20

26dB / 99% Band Width Test Data CH-Low

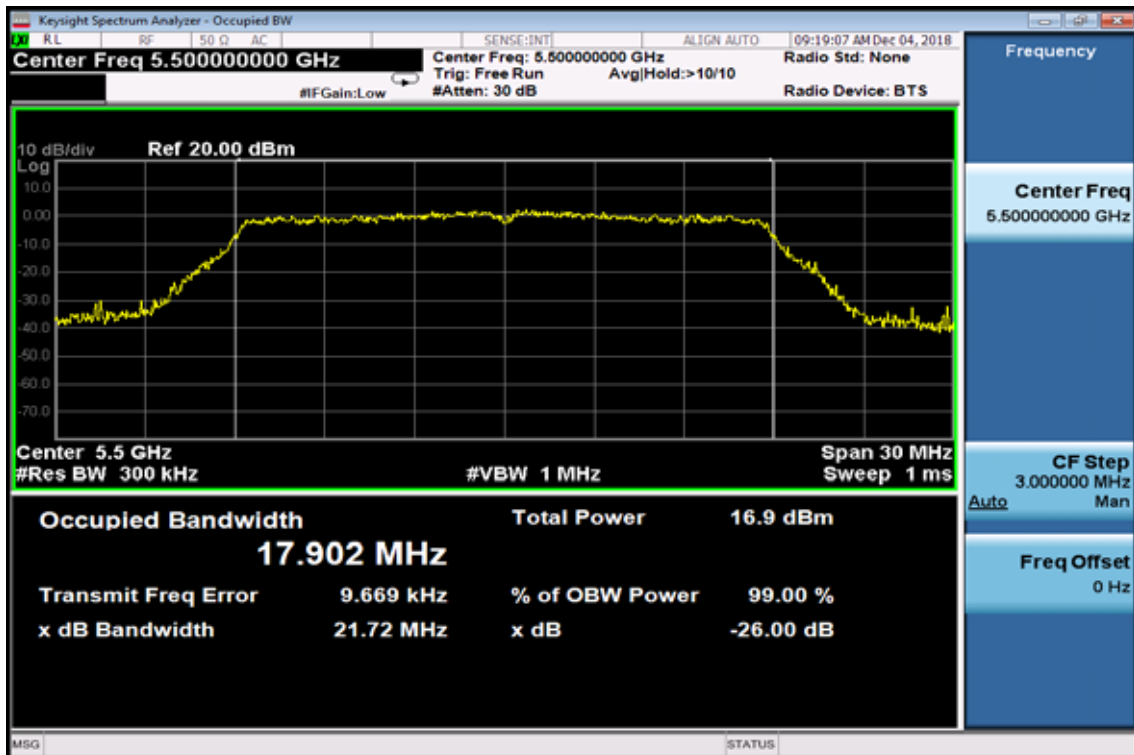

26dB / 99% Band Width Test Data CH-Mid

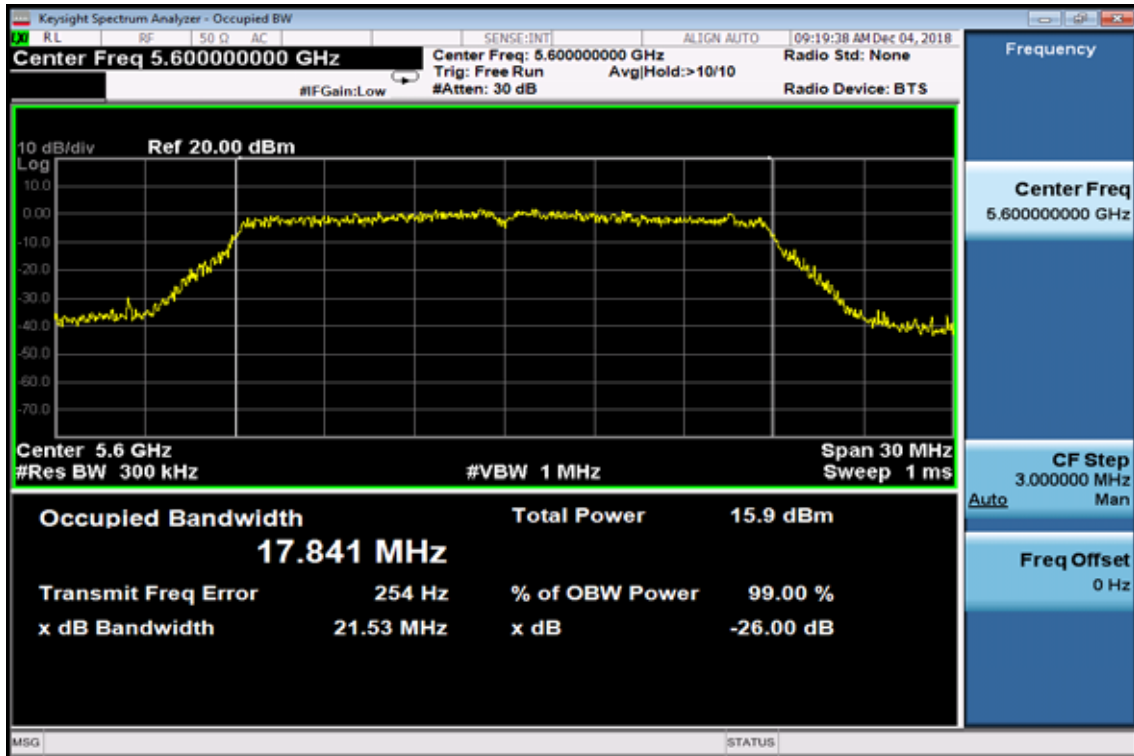

26dB / 99% Band Width Test Data CH-High

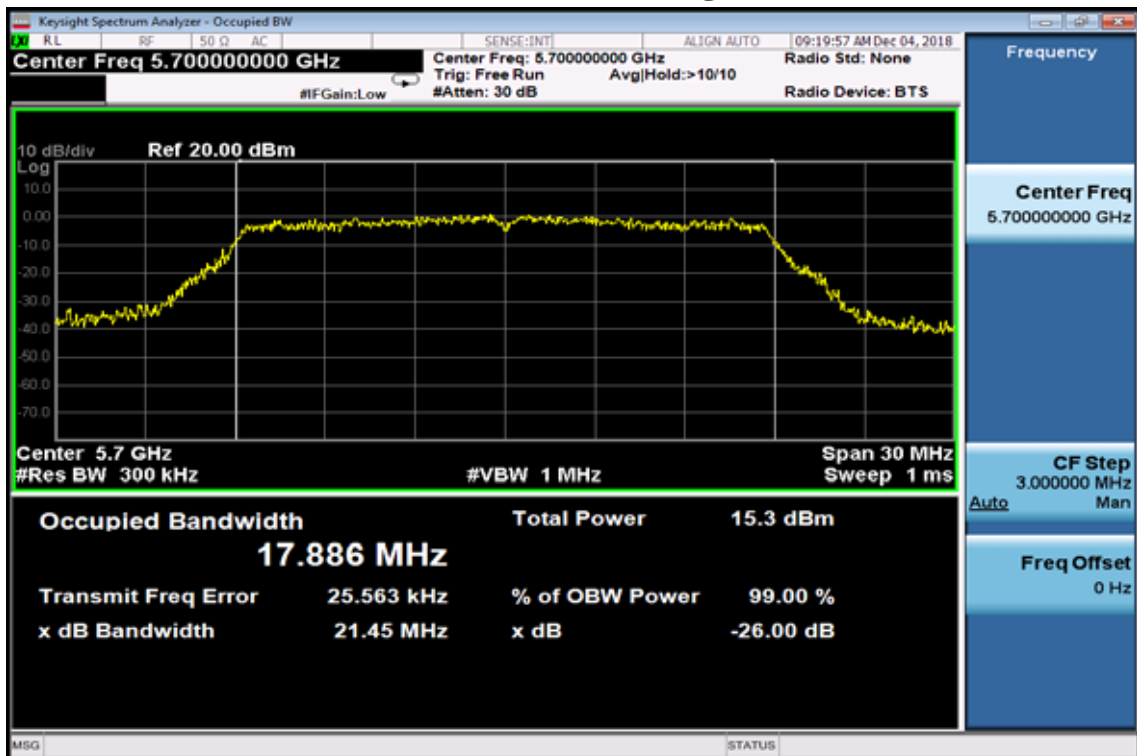

802.11n HT40

26dB / 99% Band Width Test Data CH-Low

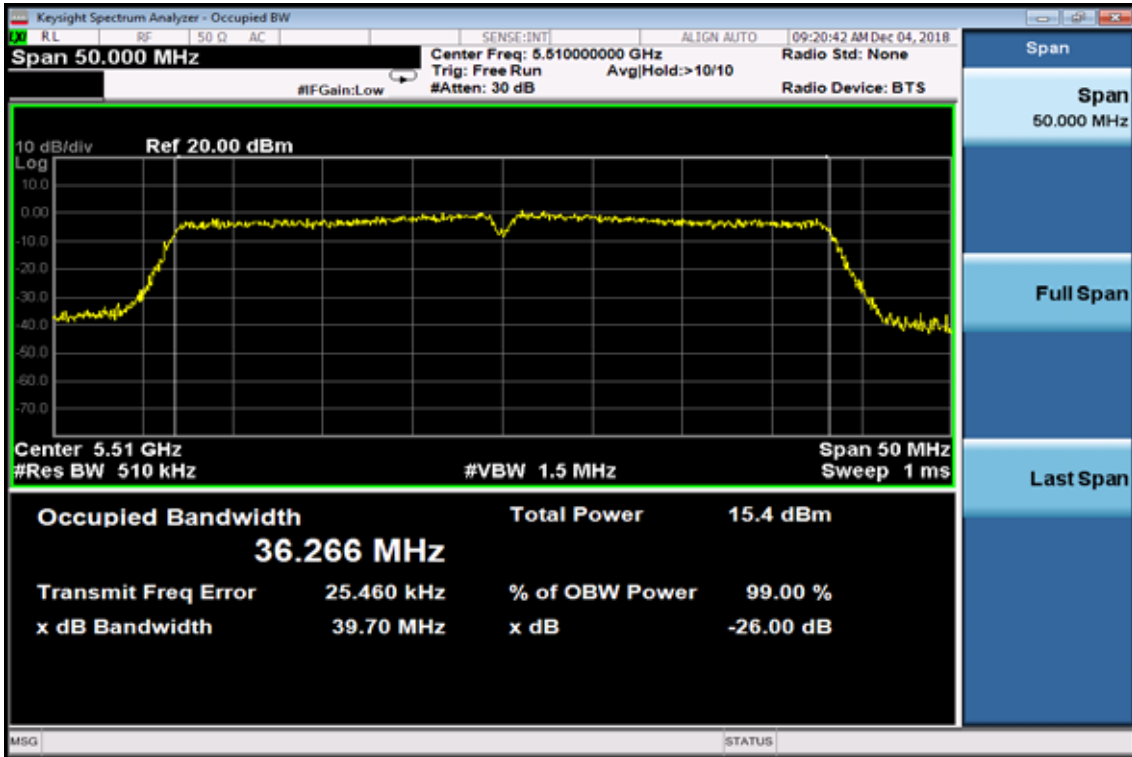

26dB / 99% Band Width Test Data CH-Mid

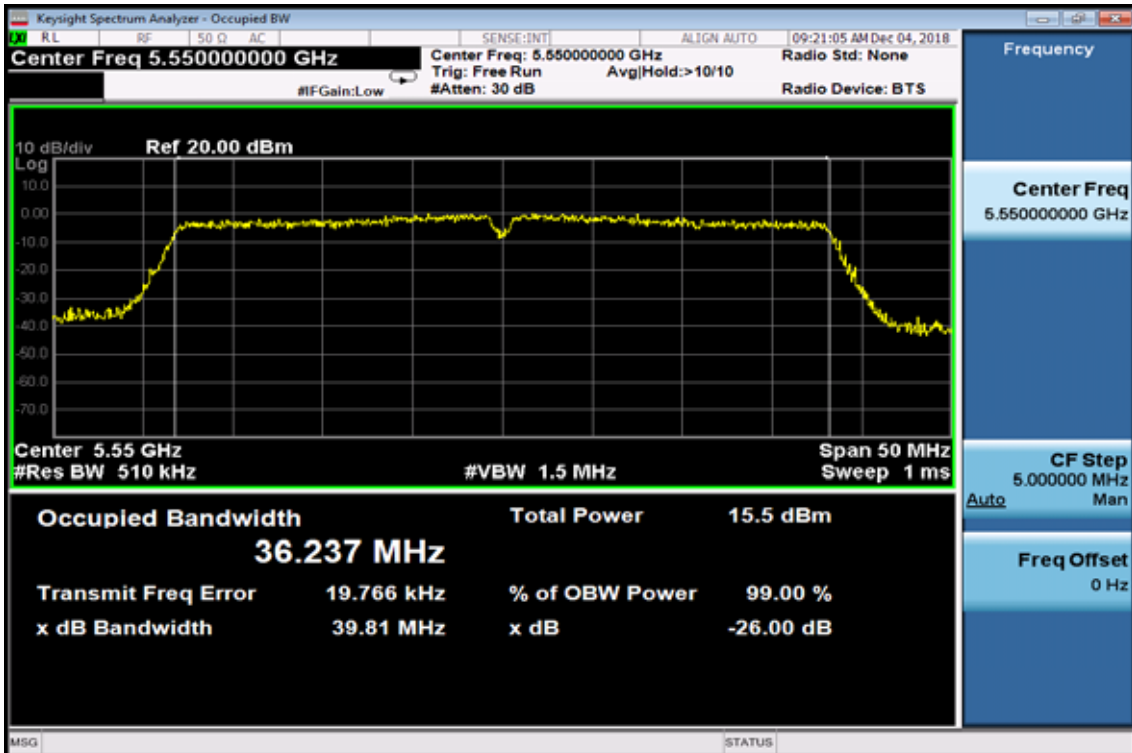

26dB / 99% Band Width Test Data CH-High

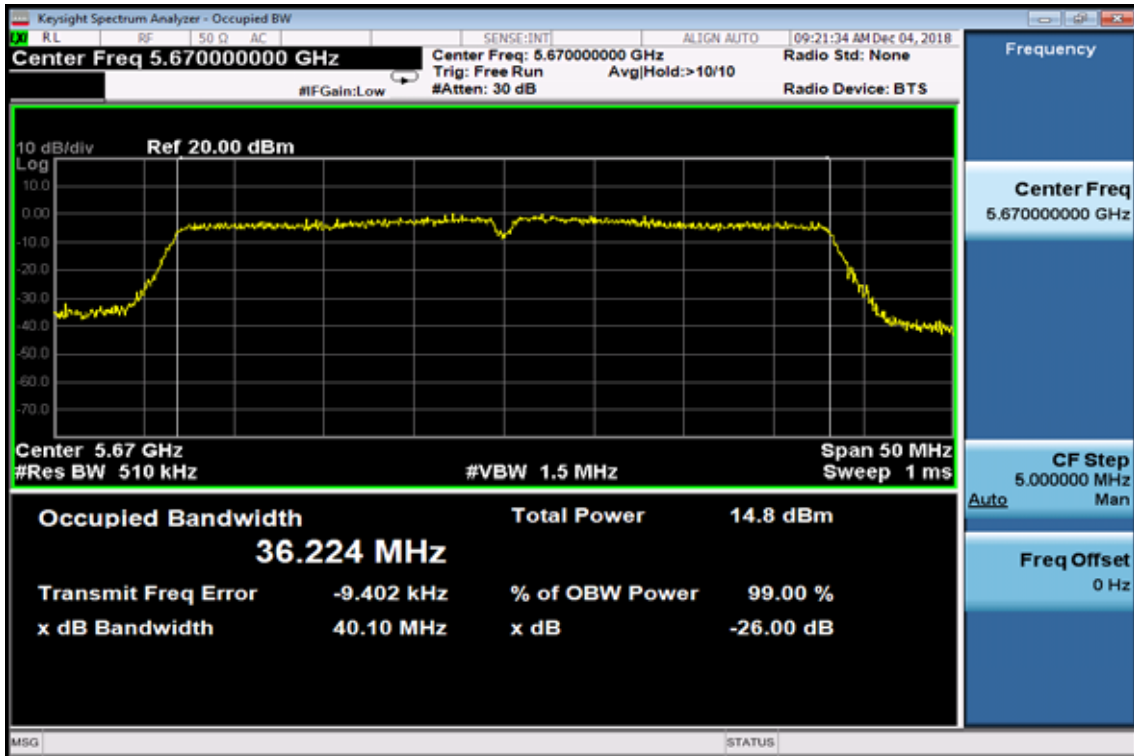

802.11ac HT80

26dB / 99% Band Width Test Data CH-Low

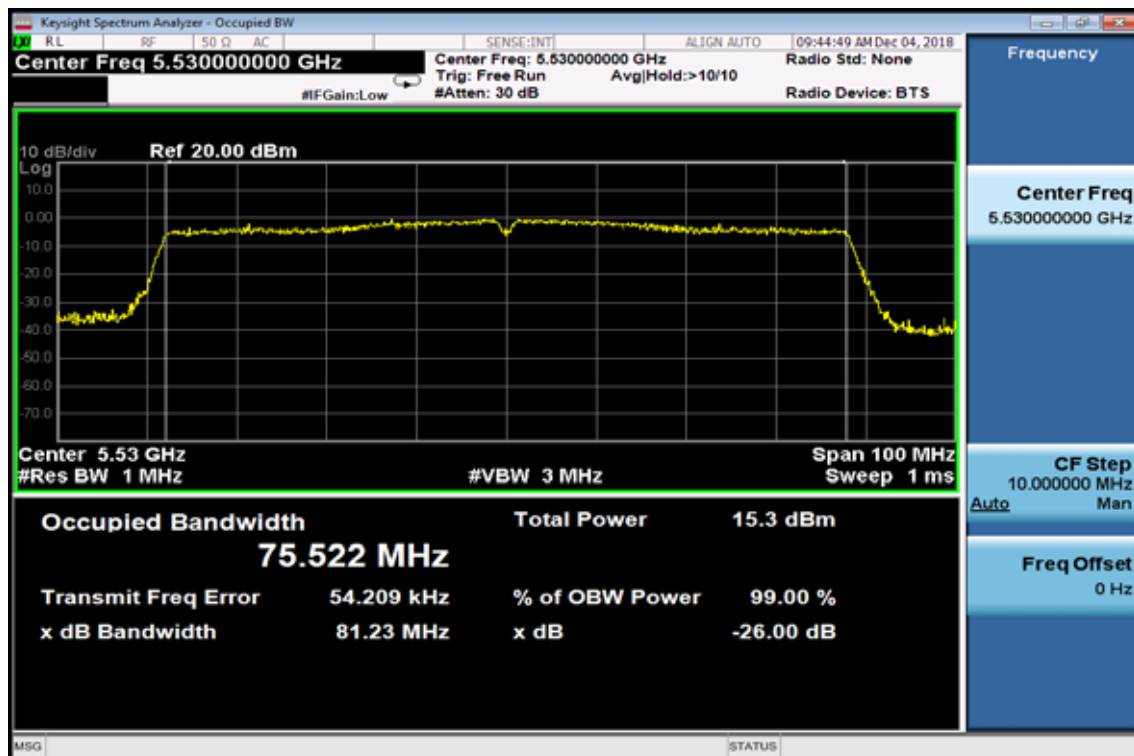

802.11ac HT80

26dB / 99% Band Width Test Data CH-High

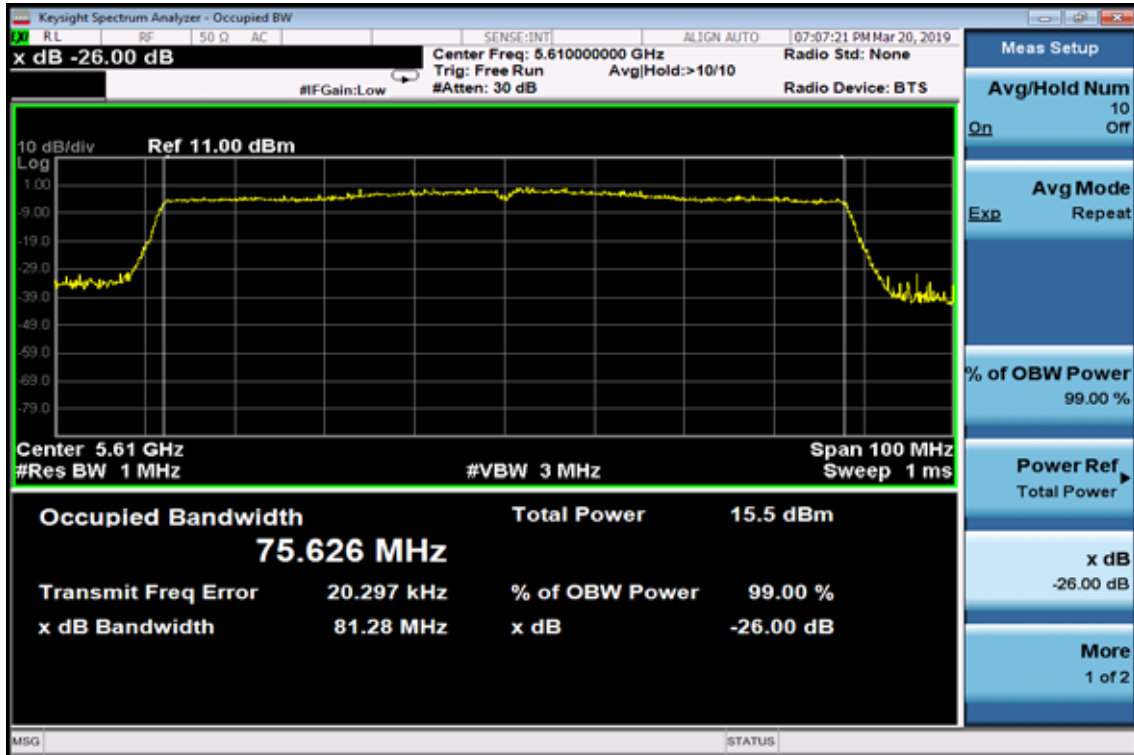

8. 6dB Emission Bandwidth Measurement

8.1. Standard Applicable

According to §15.407 (e) Within the 5.725-5.85 GHz band, the minimum 6 dB bandwidth of U-NII devices shall be at least 500 kHz.

8.2. Measurement Procedure

1. Place the EUT on the table and set it in transmitting mode.
2. Remove the antenna from the EUT and then connect a low loss RF cable from the antenna port to the spectrum analyzer.
3. Set the spectrum analyzer as RBW=100kHz, VBW =300MHz, Span= 50MHz, Sweep=auto
4. Mark the peak frequency and -6dB (upper and lower) frequency.
5. Repeat above procedures until all frequency measured were complete.

Refer to section D of KDB Document: KDB 789033 D02 General UNII Test Procedures New Rules v02r01

8.3. Measurement Equipment Used:

Refer to section 6.3 for details.

8.4. Test Set-up:

Refer to section 6.4 for details.

8.5. Measurement Result

802.11a Mode

Frequency (MHz)	6dB Bandwidth (MHz)	99% Bandwidth (MHz)	Limit (kHz)
5745	16.340	16.443	>500
5785	16.350	16.454	>500
5825	16.320	16.444	>500

802.11n HT20 Mode

Frequency (MHz)	6dB Bandwidth (MHz)	99% Bandwidth (MHz)	Limit (kHz)
5745	17.560	17.634	>500
5785	17.550	17.630	>500
5825	17.560	17.639	>500

802.11n HT40 Mode

Frequency (MHz)	6dB Bandwidth (MHz)	99% Bandwidth (MHz)	Limit (kHz)
5755	36.310	36.042	>500
5795	35.940	36.050	>500

802.11a HT80 Mode

Frequency (MHz)	6dB Bandwidth (MHz)	99% Bandwidth (MHz)	Limit (kHz)
5775	76.030	75.346	>500

5725-5850 MHz

802.11a

6dB Band Width Test Data CH-Low

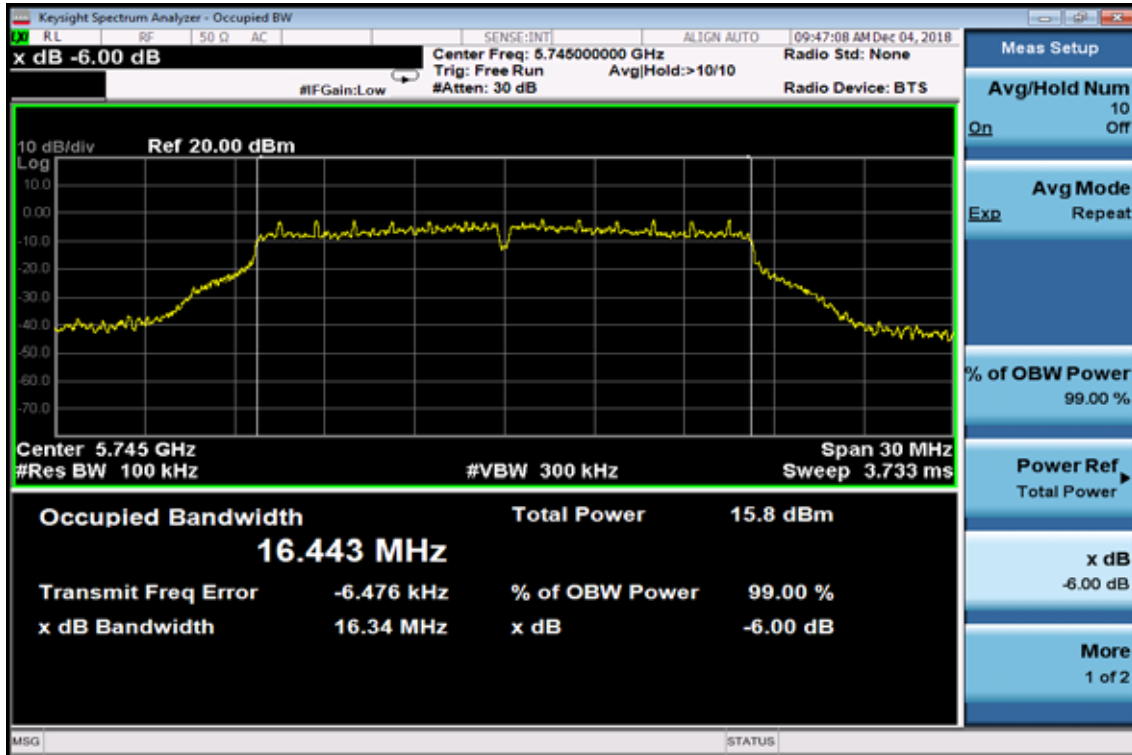

6dB Band Width Data CH-Mid

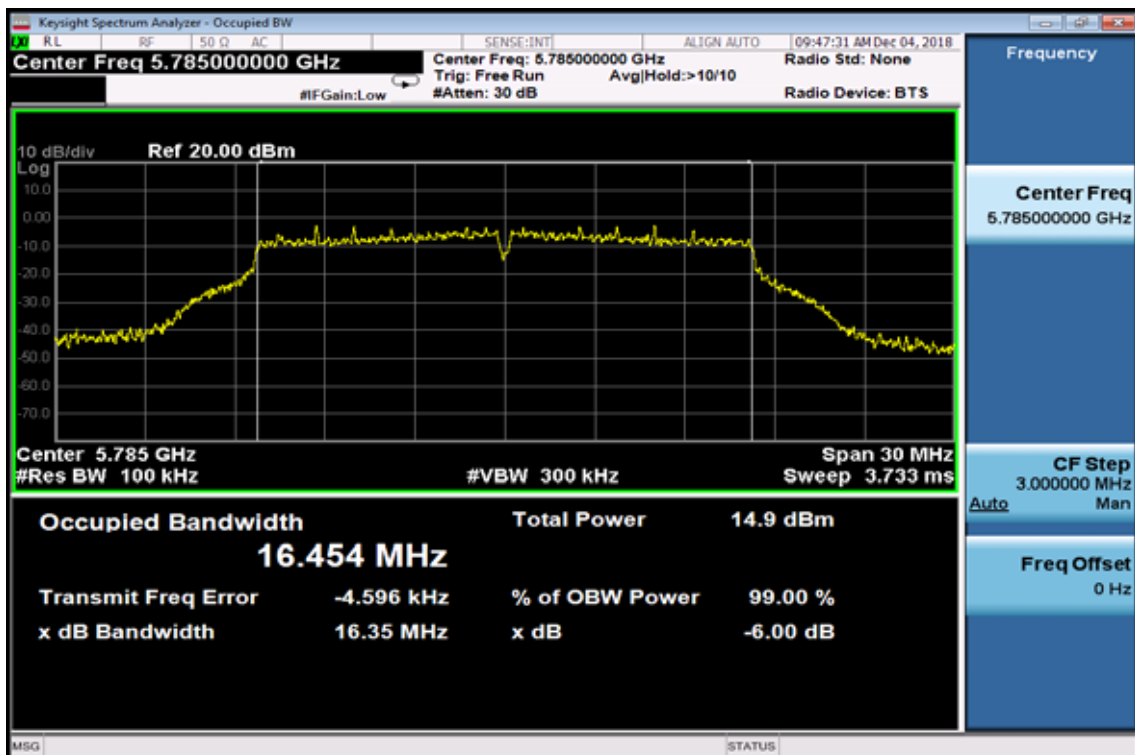

6dB Band Width Data CH-High

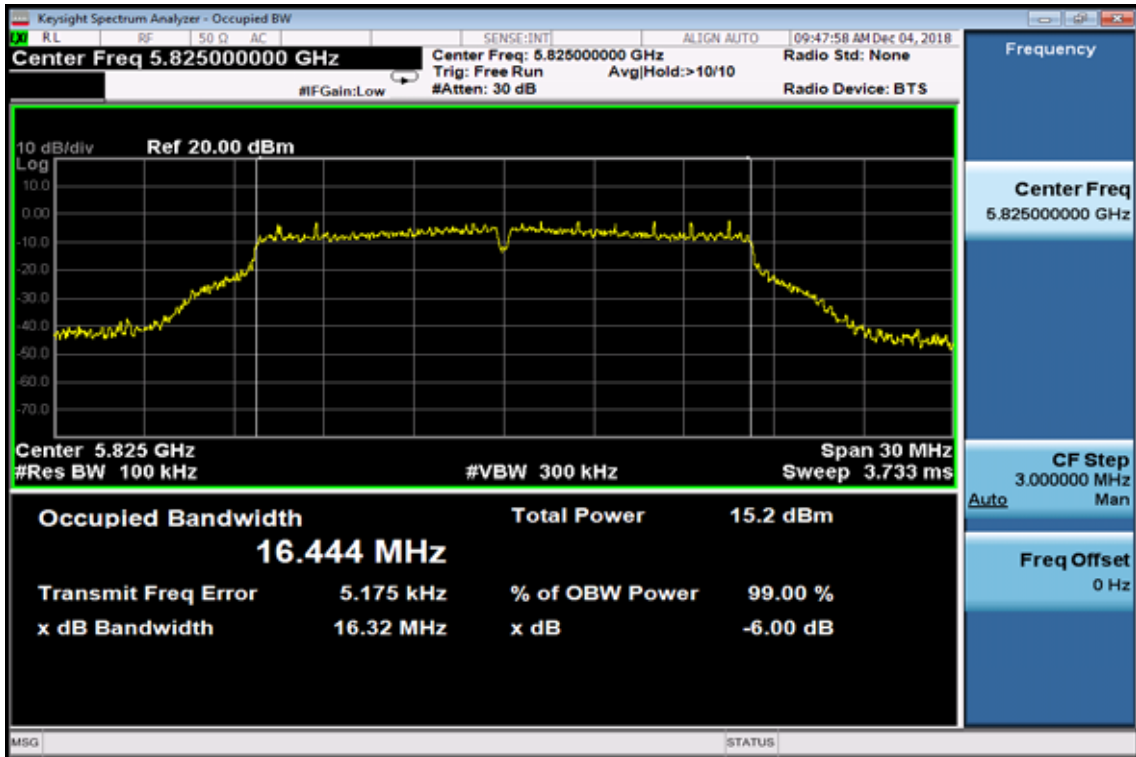

802.11n HT20

6dB Band Width Data CH-Low

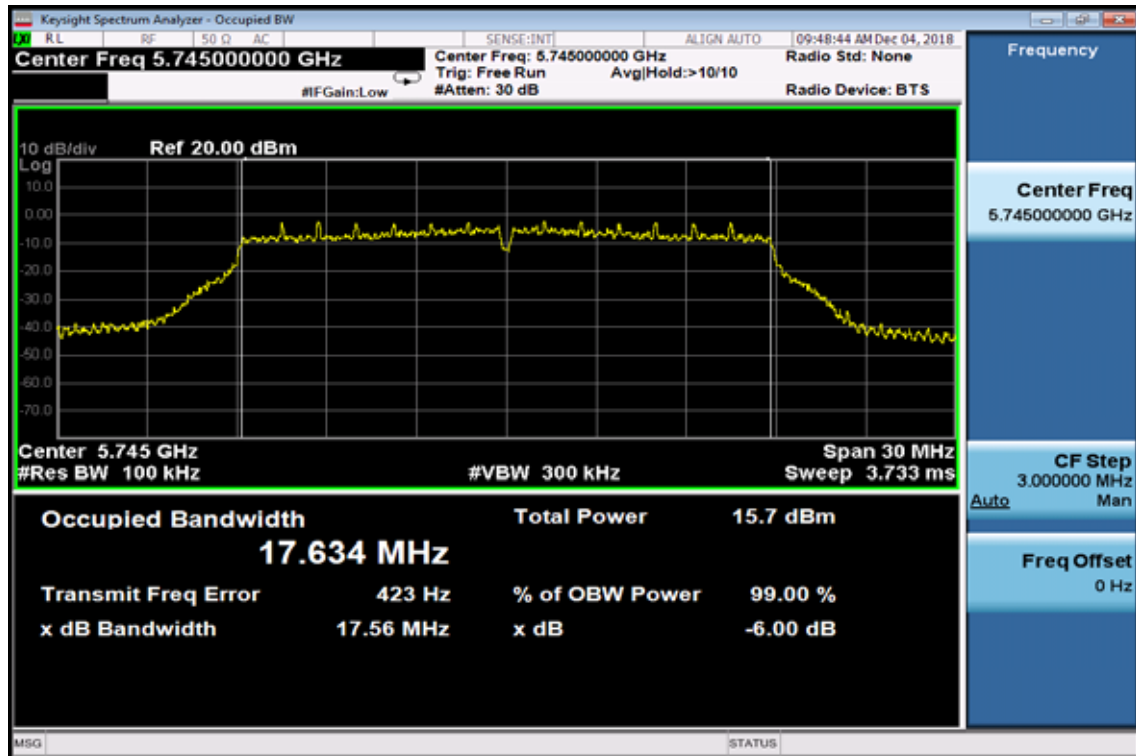

6dB Band Width Data CH-Mid

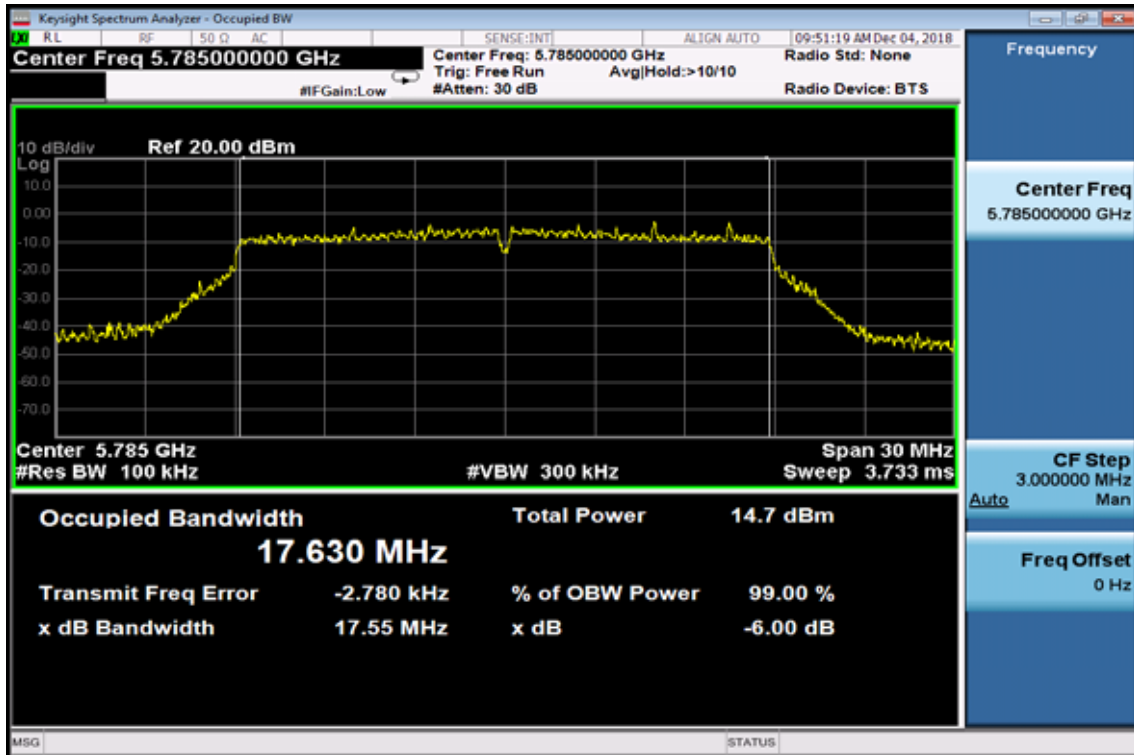

6dB Band Width Data CH-High

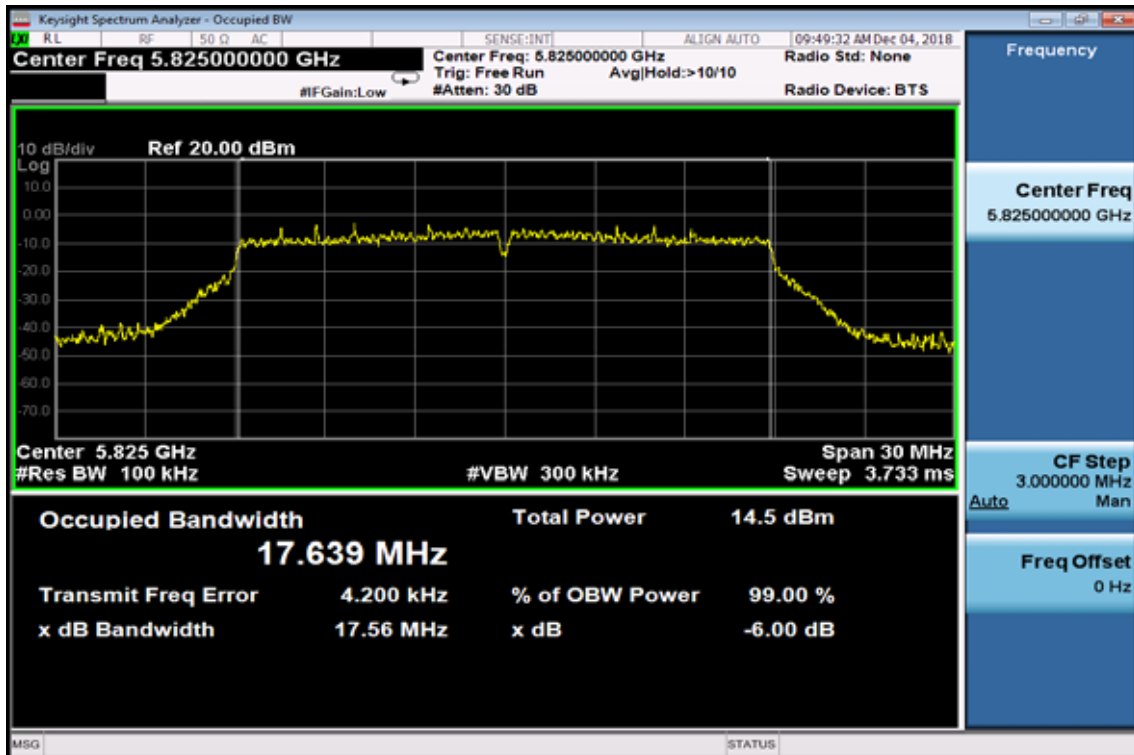

802.11n HT40

6dB Band Width Data CH-Low

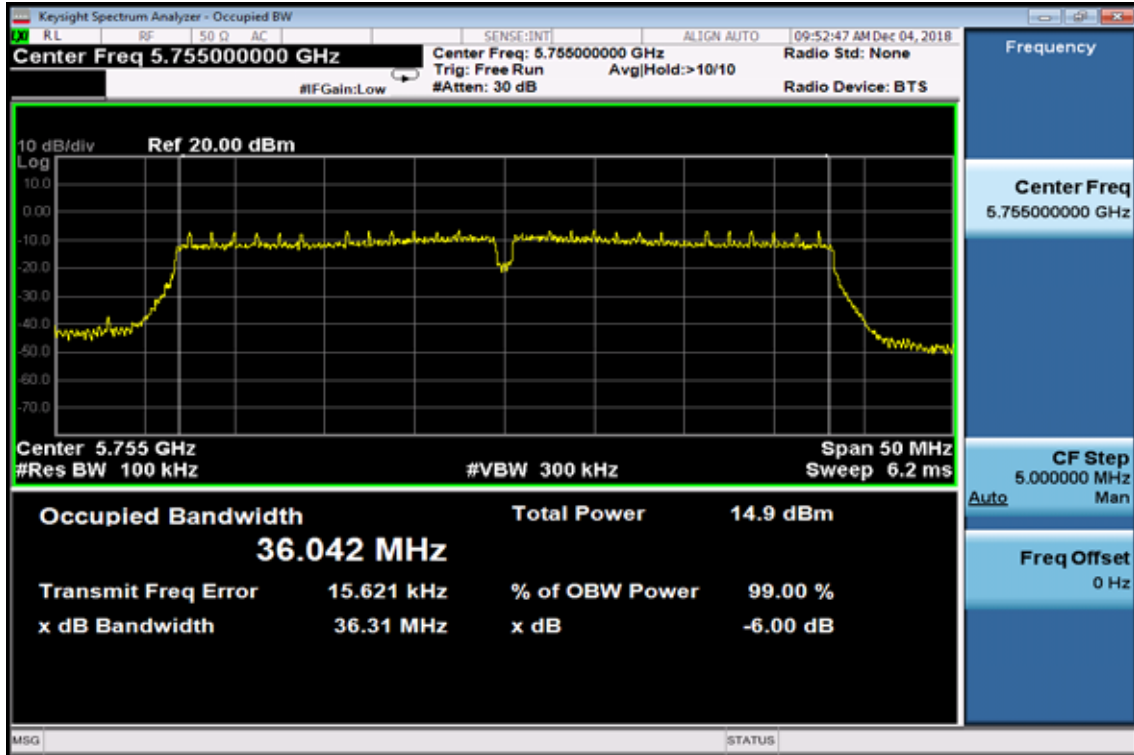

6dB Band Width Data CH-High

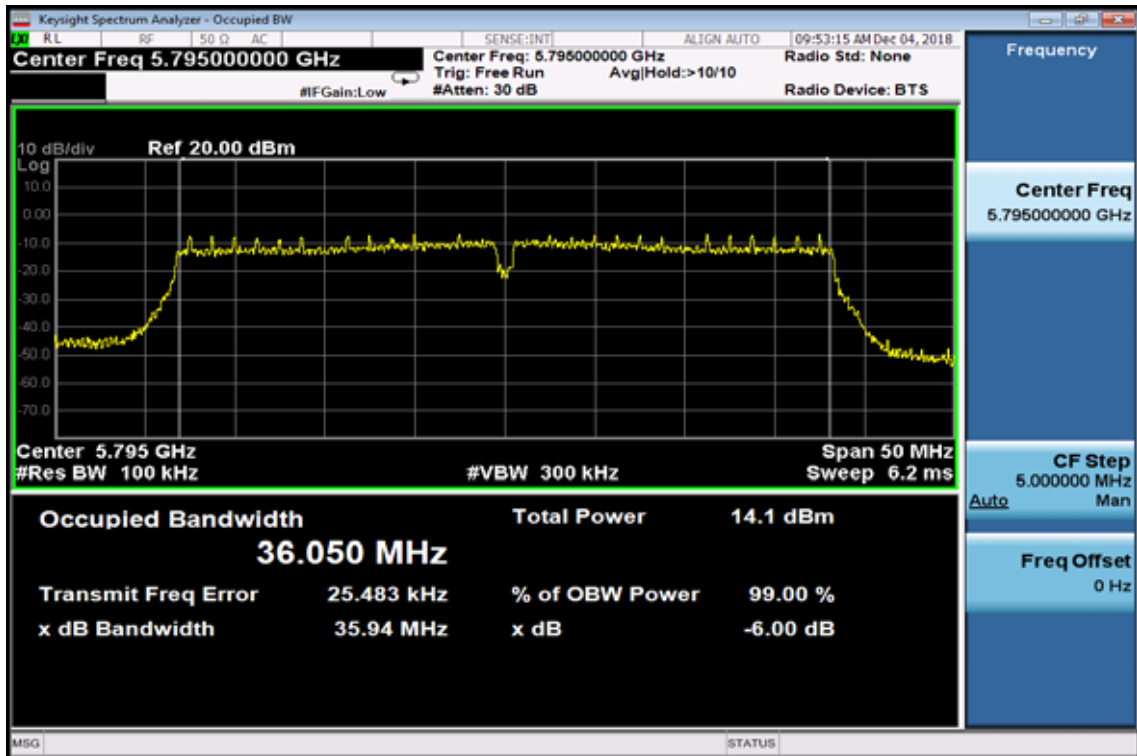

802.11ac HT80
6dB Band Width Data

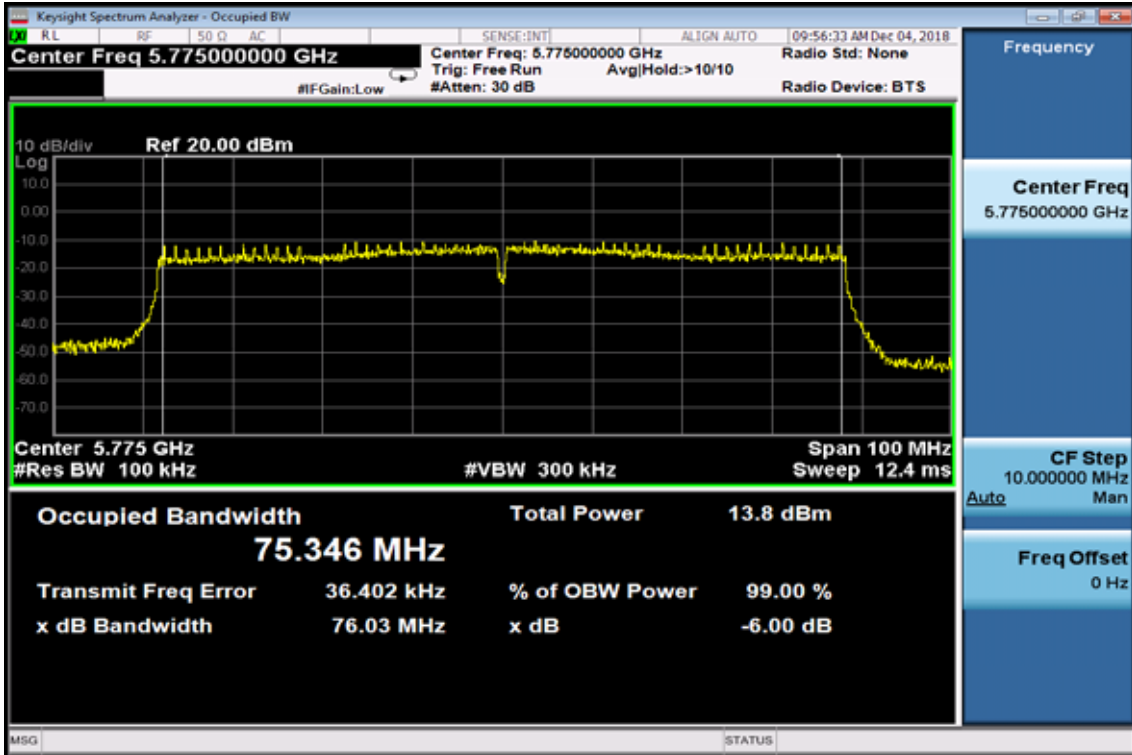

9. Undesirable Emission – Radiated Measurement

9.1. Standard Applicable

According to §15.407(b), Undesirable Emission Limits: Except as shown in Paragraph (b)(7) of this section, the peak emissions outside of the frequency bands of operation shall be attenuated in accordance with the following limits:

- (1) For transmitters operating in the 5.15-5.25 GHz band: all emissions outside of the 5.15-5.35 GHz band shall not exceed an e.i.r.p. of -27 dBm/MHz.
- (2) For transmitters operating in the 5.25-5.35 GHz band: all emissions outside of the 5.15-5.35 GHz band shall not exceed an e.i.r.p. of -27 dBm/MHz.
- (3) For transmitters operating in the 5.47-5.725 GHz band: all emissions outside of the 5.47-5.725 GHz band shall not exceed an e.i.r.p. of -27 dBm/MHz.
- (4) For transmitters operating in the 5.725-5.85 GHz band: all emissions within the frequency range from the band edge to 10 MHz above or below the band edge shall not exceed an e.i.r.p. of -17dBm/MHz; for frequencies 10 MHz or greater above or below the band edge, emissions shall not exceed an e.i.r.p. of -27 dBm/MHz.
- (5) The above emission measurements shall be performed using a minimum resolution bandwidth of 1 MHz. A lower resolution bandwidth may be employed near the band edge, when necessary, provided the measured energy is integrated to show the total power over 1 MHz.
- (6) Unwanted emissions below 1 GHz must comply with the general field strength limits set forth in Section 15.209. Further, any U-NII devices using an AC power line are required to comply also with the conducted limits set forth in Section 15.207.
- (7) The provisions of Section 15.205 of this part apply to intentional radiators operating under this section.
- (8) When measuring the emission limits, the nominal carrier frequency shall be adjusted as close to the upper and lower frequency band edges as the design of the equipment permits.

§15.205- RESTRICTED BANDS OF OPERATIONS

(a) Except as shown in paragraph (d) of this section, only spurious emissions are permitted in any of the frequency bands listed below:

MHz	MHz	MHz	GHz
0.090 - 0.110	16.42 - 16.423	399.9 - 410	4.5 - 5.15
¹ 0.495 - 0.505	16.69475 - 16.69525	608 - 614	5.35 - 5.46
2.1735 - 2.1905	16.80425 - 16.80475	960 - 1240	7.25 - 7.75
4.125 - 4.128	25.5 - 25.67	1300 - 1427	8.025 - 8.5
4.17725 - 4.17775	37.5 - 38.25	1435 - 1626.5	9.0 - 9.2
4.20725 - 4.20775	73 - 74.6	1645.5 - 1646.5	9.3 - 9.5
6.215 - 6.218	74.8 - 75.2	1660 - 1710	10.6 - 12.7
6.26775 - 6.26825	108 - 121.94	1718.8 - 1722.2	13.25 - 13.4
6.31175 - 6.31225	123 - 138	2200 - 2300	14.47 - 14.5
8.291 - 8.294	149.9 - 150.05	2310 - 2390	15.35 - 16.2
8.362 - 8.366	156.52475 -	2483.5 - 2500	17.7 - 21.4
8.37625 - 8.38675	156.52525	2655 - 2900	22.01 - 23.12
8.41425 - 8.41475	156.7 - 156.9	3260 - 3267	23.6 - 24.0
12.29 - 12.293	162.0125 - 167.17	3332 - 3339	31.2 - 31.8
12.51975 - 12.52025	167.72 - 173.2	3345.8 - 3358	36.43 - 36.5
12.57675 - 12.57725	240 - 285	3600 - 4400	(²)
13.36 - 13.41	322 - 335.4		

¹ Until February 1, 1999, this restricted band shall be 0.490-0.510 MHz.

² Above 38.6

(b) Except as provided in paragraphs (d) and (e), the field strength of emissions appearing within these frequency bands shall not exceed the limits shown in Section 15.209. At frequencies equal to or less than 1000 MHz, compliance with the limits in Section 15.209 shall be demonstrated using measurement instrumentation employing a CISPR quasi-peak detector. Above 1000 MHz, compliance with the emission limits in Section 15.209 shall be demonstrated based on the average value of the measured emissions. The provisions in Section 15.35 apply to these measurements.

§15.209- RADIATED EMISSION LIMITS: GENERAL REQUIREMENTS

FCC PART 15.209

MEASURING DISTANCE OF 3 METER		
FREQUENCY RANGE (MHz)	FIELD STRENGTH (Microvolts/m)	FIELD STRENGTH (dBuV/m)
30-88	100	40
88-216	150	43.5
216-960	200	46
Above 960	500	54

9.2. EUT Setup

1. The radiated emission tests were performed in the 3 meter open-test site, using the setup in accordance with the ANSI C63.10: 2013
2. The EUT was put in the front of the test table. The host PC system was placed on the center of the back edge on the test table. The peripherals like modem, monitor printer, K/B, and mouse were placed on the side of the host PC system. The rear of the EUT and peripherals were placed flushed with the rear of the tabletop.
3. The keyboard was placed directly in the front of the monitor, flushed with the front tabletop. The mouse was placed next to the Keyboard, flushed with the back of keyboard.
4. The spacing between the peripherals was 10 centimeters.
5. External I/O cables were draped along the edge of the test table and bundle when necessary.
6. The host PC system was connected with 120Vac/60Hz power source.

9.3. Measurement Procedure

1. The EUT was placed on a turn table which is 0.8m above ground plane.
2. The turn table shall rotate 360 degrees to determine the position of maximum emission level.
3. EUT is set 3m away from the receiving antenna which varied from 1m to 4m to find out the highest emissions.
4. Maximum procedure was performed on the six highest emissions to ensure EUT compliance.
5. And also, each emission was to be maximized by changing the polarization of receiving antenna both horizontal and vertical.
6. Repeat above procedures until all frequency measured were complete.

Refer to section F of KDB Document: KDB 789033 D02 General UNII Test Procedures New Rules v02r01

9.4. Test SET-UP (Block Diagram of Configuration)

(A) Radiated Emission Test Setup, Frequency below 1000MHz

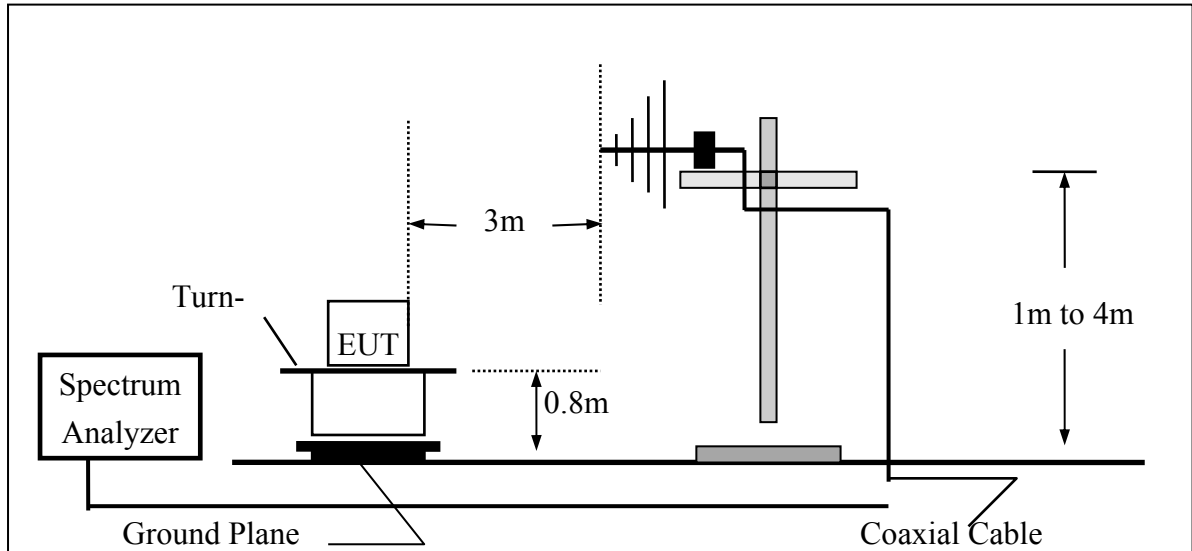

(B) Radiated Emission Test Setup Frequency above 1 GHz

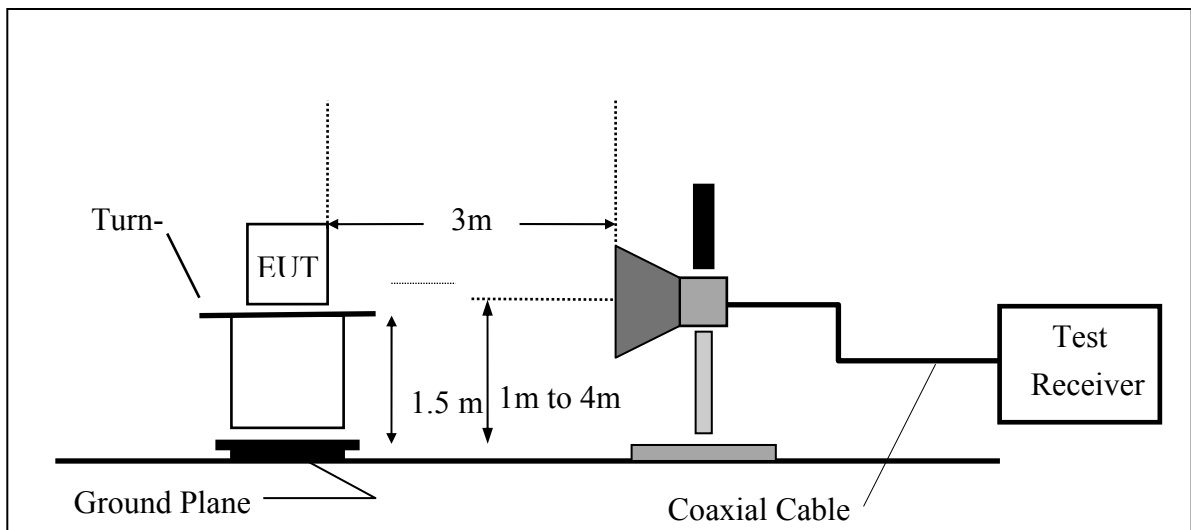

9.5. Measurement Equipment Used:

Chamber 19(966)					
Equipment Type	MFR	Model Number	Serial Number	Last Cal.	Cal Due.
966 Chamber	Chance Most	Chamber 19	N/A	08/13/2018	08/12/2019
Spectrum Analyzer 21(3Hz-44GHz)	Agilent	N9030A	MY51360021	11/18/2018	11/17/2019
EMI Receiver	SCHWARZBECK	FCVU1534	1534149	12/06/2017	12/05/2019
Loop Antenna(9K-30M)	EM	EM-6879	271	06/06/2018	06/05/2020
Bilog Antenna (30M-1G)	SCHWARZBECK	VULB9168 w 5dB Att	736	10/30/2018	10/29/2019
Horn antenna (1G-18G)	SCHWARZBECK	9120D	9120D-1627	11/27/2017	11/26/2019
Horn antenna (18G-26G)	Com-power	AH-826	081001	11/21/2017	11/20/2019
Horn antenna (26G-40G)	Com-power	AH-640	100A	02/22/2017	02/21/2019
Preamplifier (9k-1000M)	HP	8447F	3113A04621	12/08/2018	12/07/2019
Preamplifier(1G-26G)	Agilent	8449B	3008A02471	10/29/2018	10/28/2019
Preamplifier (26G-40G)	MITEQ	JS4-26004000- 27-5A	818471	11/20/2017	07/21/2019
RF Cable (9k-18G)	HUBER SUHNER	SUCOFLEX 104A	MY1397/4A	11/12/2018	11/11/2019
RF cable (18G~40G)	HUBER SUHNER	Sucoflex 102	27963/2&37421/2	11/12/2018	11/11/2019
Turn Table	MF	Turn Table-19	Turn Table-19	N/A	N/A
Mast Tower	MF	JSDS-15A	1308283	N/A	N/A
Controller	MF	MF-7802BS	MF780208460	N/A	N/A
AC power source	T-Power	TFC-1005	40006471	N/A	N/A
Signal Generator	R&S	SMU200A	102330	03/14/2018	03/13/2019
Signal Generator	Anritsu	MG3692A	20311	12/07/2018	12/06/2019
2.4G Filter	Micro-Tronics	Brm50702	76	12/25/2017	12/24/2018
5G Filter	Micro-Tronics	Brm50716	005	12/25/2017	12/24/2018
Test Software	Audix	E3 Ver:6.12023	N/A	N/A	N/A

9.6. Field Strength Calculation

The field strength is calculated by adding the Antenna Factor and Cable Factor and subtracting the Amplifier Gain and Duty Cycle Correction Factor (if any) from the measured reading. The basic equation with a sample calculation is as follows:

$$FS = RA + AF + CL - AG$$

Where	FS = Field Strength	CL = Cable Attenuation Factor (Cable Loss)
	RA = Reading Amplitude	AG = Amplifier Gain
	AF = Antenna Factor	

9.7. Measurement Result

Refer to attach tabular data sheets.

NOTE:

The resolution bandwidth and video bandwidth of test receiver/spectrum analyzer is 100kHz for Peak detection (PK) and Quasi-peak detection (QP) at frequency below 1GHz. And RBW 1MHz for frequency above 1GHz.

Radiated Spurious Emission Measurement Result (below 1GHz)

(Worst case: Band 1, 2 a mode)

Operation Mode	TX MODE	Test Date	2018/12/04
Channel Number	CH Low	Test By	Barry
Temperature	25	Pol	Ver./Hor
Humidity	65 %		

No	Freq MHz	Reading dBuV	Factor dB	Level dBuV/m	Limit dBuV/m	Margin dB	Remark	Pol V/H
1	v	29.73	-4.04	25.69	46.00	-20.31	Peak	VERTICAL
2	430.61	29.07	-2.42	26.65	46.00	-19.35	Peak	VERTICAL
3	500.45	31.55	-1.64	29.91	46.00	-16.09	Peak	VERTICAL
4	604.24	31.13	0.47	31.60	46.00	-14.40	Peak	VERTICAL
5	750.71	28.83	3.09	31.92	46.00	-14.08	Peak	VERTICAL
6	772.05	29.23	3.31	32.54	46.00	-13.46	Peak	VERTICAL
1	375.32	40.95	-3.49	37.46	46.00	-8.54	Peak	HORIZONTAL
2	468.44	29.90	-1.92	27.98	46.00	-18.02	Peak	HORIZONTAL
3	500.45	31.10	-1.64	29.46	46.00	-16.54	Peak	HORIZONTAL
4	625.58	33.25	0.71	33.96	46.00	-12.04	Peak	HORIZONTAL
5	697.36	29.64	1.84	31.48	46.00	-14.52	Peak	HORIZONTAL
6	826.37	29.77	3.99	33.76	46.00	-12.24	Peak	HORIZONTAL

Remark:

- 1 emission is 20dB lower, so that emission as measured between 9kHz to 30MHz is not reported
- 2 Measuring frequencies from the lowest internal frequency to the 1GHz.
- 3 Radiated emissions measured in frequency range from 9MHz to 1000MHz were made with an instrument detector setting 9-90kHz/110-490kHz using PK/AV and other Frequency Band using PK/QP
- 4 Measurement result within this frequency range shown “ - ” in the table above means the reading of emissions are attenuated more than 20dB below the permissible limits or the field strength is too small to be measured.
- 5 The IF bandwidth of SPA between 9kHz to 30MHz was 10kHz, VBW= 30kHz; between 30MHz to 1GHz was 100kHz, VBW=300kHz.

Radiated Spurious Emission Measurement Result (below 1GHz)

Operation Mode	TX MODE	Test Date	2018/12/04
Channel Number	CH Mid	Test By	Barry
Temperature	25	Pol	Ver./Hor
Humidity	65 %		

No	Freq MHz	Reading dBuV	Factor dB	Level dBuV/m	Limit dBuV/m	Margin dB	Remark	Pol V/H
1	409.27	29.25	-2.81	26.44	46.00	-19.56	Peak	VERTICAL
2	462.62	29.47	-1.96	27.51	46.00	-18.49	Peak	VERTICAL
3	556.71	29.40	-0.65	28.75	46.00	-17.25	Peak	VERTICAL
4	684.75	29.99	1.62	31.61	46.00	-14.39	Peak	VERTICAL
5	783.69	30.27	3.42	33.69	46.00	-12.31	Peak	VERTICAL
6	824.43	31.73	3.97	35.70	46.00	-10.30	Peak	VERTICAL
1	409.27	29.25	-2.81	26.44	46.00	-19.56	Peak	HORIZONTAL
2	462.62	29.47	-1.96	27.51	46.00	-18.49	Peak	HORIZONTAL
3	556.71	29.40	-0.65	28.75	46.00	-17.25	Peak	HORIZONTAL
4	684.75	29.99	1.62	31.61	46.00	-14.39	Peak	HORIZONTAL
5	783.69	30.27	3.42	33.69	46.00	-12.31	Peak	HORIZONTAL
6	824.43	31.73	3.97	35.70	46.00	-10.30	Peak	HORIZONTAL

Remark:

- 1 emission is 20dB lower, so that emission as measured between 9kHz to 30MHz is not reported
- 2 Measuring frequencies from the lowest internal frequency to the 1GHz.
- 3 Radiated emissions measured in frequency range from 9MHz to 1000MHz were made with an instrument detector setting 9-90kHz/110-490kHz using PK/AV and other Frequency Band using PK/QP
- 4 Measurement result within this frequency range shown “ - ” in the table above means the reading of emissions are attenuated more than 20dB below the permissible limits or the field strength is too small to be measured.
- 5 The IF bandwidth of SPA between 9kHz to 30MHz was 10kHz, VBW= 30kHz; between 30MHz to 1GHz was 100kHz, VBW=300kHz.

Radiated Spurious Emission Measurement Result (below 1GHz)

Operation Mode	TX MODE	Test Date	2018/12/04
Channel Number	CH High	Test By	Barry
Temperature	25	Pol	Ver./Hor
Humidity	65 %		

No	Freq MHz	Reading dBuV	Factor dB	Level dBuV/m	Limit dBuV/m	Margin dB	Remark	Pol V/H
1	367.56	29.95	-3.65	26.30	46.00	-19.70	Peak	VERTICAL
2	500.45	31.73	-1.64	30.09	46.00	-15.91	Peak	VERTICAL
3	625.58	31.65	0.71	32.36	46.00	-13.64	Peak	VERTICAL
4	750.71	29.09	3.09	32.18	46.00	-13.82	Peak	VERTICAL
5	785.63	29.85	3.45	33.30	46.00	-12.70	Peak	VERTICAL
6	878.75	29.97	4.90	34.87	46.00	-11.13	Peak	VERTICAL
1	375.32	41.25	-3.49	37.76	46.00	-8.24	Peak	HORIZONTAL
2	444.19	29.57	-2.18	27.39	46.00	-18.61	Peak	HORIZONTAL
3	578.05	30.14	-0.12	30.02	46.00	-15.98	Peak	HORIZONTAL
4	625.58	34.06	0.71	34.77	46.00	-11.23	Peak	HORIZONTAL
5	703.18	29.83	1.96	31.79	46.00	-14.21	Peak	HORIZONTAL
6	847.71	30.15	4.33	34.48	46.00	-11.52	Peak	HORIZONTAL

Remark:

- 1 emission is 20dB lower, so that emission as measured between 9kHz to 30MHz is not reported
- 2 Measuring frequencies from the lowest internal frequency to the 1GHz.
- 3 Radiated emissions measured in frequency range from 9MHz to 1000MHz were made with an instrument detector setting 9-90kHz/110-490kHz using PK/AV and other Frequency Band using PK/QP
- 4 Measurement result within this frequency range shown “ - ” in the table above means the reading of emissions are attenuated more than 20dB below the permissible limits or the field strength is too small to be measured.
- 5 The IF bandwidth of SPA between 9kHz to 30MHz was 10kHz, VBW= 30kHz; between 30MHz to 1GHz was 100kHz, VBW=300kHz.

**Radiated Spurious Emission Measurement Result (below 1GHz)
(Band 1, 2 HT40 mode)**

Operation Mode	TX MODE	Test Date	2018/12/04
Channel Number	CH Low	Test By	Barry
Temperature	25	Pol	Ver./Hor
Humidity	65 %		

No	Freq MHz	Reading dBuV	Factor dB	Level dBuV/m	Limit dBuV/m	Margin dB	Remark	Pol V/H
1	312.27	30.63	-4.62	26.01	46.00	-19.99	Peak	VERTICAL
2	446.13	29.89	-2.14	27.75	46.00	-18.25	Peak	VERTICAL
3	582.90	29.71	0.00	29.71	46.00	-16.29	Peak	VERTICAL
4	628.49	30.20	0.76	30.96	46.00	-15.04	Peak	VERTICAL
5	734.22	29.22	2.70	31.92	46.00	-14.08	Peak	VERTICAL
6	851.59	29.58	4.39	33.97	46.00	-12.03	Peak	VERTICAL
1	375.32	41.36	-3.49	37.87	46.00	-8.13	Peak	HORIZONTAL
2	487.84	30.78	-1.76	29.02	46.00	-16.98	Peak	HORIZONTAL
3	625.58	33.51	0.71	34.22	46.00	-11.78	Peak	HORIZONTAL
4	800.18	29.03	3.59	32.62	46.00	-13.38	Peak	HORIZONTAL
5	833.16	30.28	4.10	34.38	46.00	-11.62	Peak	HORIZONTAL
6	895.24	30.78	5.21	35.99	46.00	-10.01	Peak	HORIZONTAL

Remark:

- 1 emission is 20dB lower, so that emission as measured between 9kHz to 30MHz is not reported
- 2 Measuring frequencies from the lowest internal frequency to the 1GHz.
- 3 Radiated emissions measured in frequency range from 9MHz to 1000MHz were made with an instrument detector setting 9-90kHz/110-490kHz using PK/AV and other Frequency Band using PK/QP
- 4 Measurement result within this frequency range shown “ - ” in the table above means the reading of emissions are attenuated more than 20dB below the permissible limits or the field strength is too small to be measured.
- 5 The IF bandwidth of SPA between 9kHz to 30MHz was 10kHz, VBW= 30kHz; between 30MHz to 1GHz was 100kHz, VBW=300kHz.

Radiated Spurious Emission Measurement Result (below 1GHz)

Operation Mode	TX MODE	Test Date	2018/12/04
Channel Number	CH Mid	Test By	Barry
Temperature	25	Pol	Ver./Hor
Humidity	65 %		

No	Freq MHz	Reading dBuV	Factor dB	Level dBuV/m	Limit dBuV/m	Margin dB	Remark	Pol V/H
1	395.69	30.50	-3.06	27.44	46.00	-18.56	Peak	VERTICAL
2	500.45	31.53	-1.64	29.89	46.00	-16.11	Peak	VERTICAL
3	620.73	29.83	0.67	30.50	46.00	-15.50	Peak	VERTICAL
4	761.38	30.00	3.20	33.20	46.00	-12.80	Peak	VERTICAL
5	839.95	30.23	4.20	34.43	46.00	-11.57	Peak	VERTICAL
6	923.37	30.27	5.78	36.05	46.00	-9.95	Peak	VERTICAL
1	331.67	29.03	-4.32	24.71	46.00	-21.29	Peak	HORIZONTAL
2	375.32	41.14	-3.49	37.65	46.00	-8.35	Peak	HORIZONTAL
3	515.97	29.76	-1.37	28.39	46.00	-17.61	Peak	HORIZONTAL
4	625.58	33.05	0.71	33.76	46.00	-12.24	Peak	HORIZONTAL
5	739.07	29.39	2.82	32.21	46.00	-13.79	Peak	HORIZONTAL
6	838.98	30.34	4.19	34.53	46.00	-11.47	Peak	HORIZONTAL

Remark:

- 1 emission is 20dB lower, so that emission as measured between 9kHz to 30MHz is not reported
- 2 Measuring frequencies from the lowest internal frequency to the 1GHz.
- 3 Radiated emissions measured in frequency range from 9MHz to 1000MHz were made with an instrument detector setting 9-90kHz/110-490kHz using PK/AV and other Frequency Band using PK/QP
- 4 Measurement result within this frequency range shown “ - ” in the table above means the reading of emissions are attenuated more than 20dB below the permissible limits or the field strength is too small to be measured.
- 5 The IF bandwidth of SPA between 9kHz to 30MHz was 10kHz, VBW= 30kHz; between 30MHz to 1GHz was 100kHz, VBW=300kHz.

Radiated Spurious Emission Measurement Result (below 1GHz)

Operation Mode	TX MODE	Test Date	2018/12/04
Channel Number	CH High	Test By	Barry
Temperature	25	Pol	Ver./Hor
Humidity	65 %		

No	Freq MHz	Reading dBuV	Factor dB	Level dBuV/m	Limit dBuV/m	Margin dB	Remark	Pol V/H
1	424.79	30.30	-2.53	27.77	46.00	-18.23	Peak	VERTICAL
2	492.69	32.61	-1.72	30.89	46.00	-15.11	Peak	VERTICAL
3	646.92	29.59	0.98	30.57	46.00	-15.43	Peak	VERTICAL
4	713.85	30.05	2.22	32.27	46.00	-13.73	Peak	VERTICAL
5	808.91	29.43	3.73	33.16	46.00	-12.84	Peak	VERTICAL
6	848.68	30.83	4.34	35.17	46.00	-10.83	Peak	VERTICAL
1	341.37	31.14	-4.16	26.98	46.00	-19.02	Peak	HORIZONTAL
2	375.32	40.83	-3.49	37.34	46.00	-8.66	Peak	HORIZONTAL
3	573.20	30.37	-0.23	30.14	46.00	-15.86	Peak	HORIZONTAL
4	625.58	33.80	0.71	34.51	46.00	-11.49	Peak	HORIZONTAL
5	716.76	30.08	2.29	32.37	46.00	-13.63	Peak	HORIZONTAL
6	869.05	29.70	4.73	34.43	46.00	-11.57	Peak	HORIZONTAL

Remark:

- 1 emission is 20dB lower, so that emission as measured between 9kHz to 30MHz is not reported
- 2 Measuring frequencies from the lowest internal frequency to the 1GHz.
- 3 Radiated emissions measured in frequency range from 9MHz to 1000MHz were made with an instrument detector setting 9-90kHz/110-490kHz using PK/AV and other Frequency Band using PK/QP
- 4 Measurement result within this frequency range shown “ - ” in the table above means the reading of emissions are attenuated more than 20dB below the permissible limits or the field strength is too small to be measured.
- 5 The IF bandwidth of SPA between 9kHz to 30MHz was 10kHz, VBW= 30kHz; between 30MHz to 1GHz was 100kHz, VBW=300kHz.

Radiated Spurious Emission Measurement Result (below 1GHz)

(Band 1, 2 ac80 mode)

Operation Mode	TX MODE	Test Date	2018/12/04
Channel Number	CH Low	Test By	Barry
Temperature	25	Pol	Ver./Hor
Humidity	65 %		

No	Freq MHz	Reading dBuV	Factor dB	Level dBuV/m	Limit dBuV/m	Margin dB	Remark	Pol V/H
1	71.71	45.50	-9.10	36.40	40.00	-3.60	Peak	VERTICAL
2	120.21	45.49	-8.55	36.94	43.50	-6.56	Peak	VERTICAL
3	209.45	39.22	-8.57	30.65	43.50	-12.85	Peak	VERTICAL
4	371.44	32.43	-3.61	28.82	46.00	-17.18	Peak	VERTICAL
5	666.32	33.71	1.24	34.95	46.00	-11.05	Peak	VERTICAL
6	860.32	38.70	4.48	43.18	46.00	-2.82	Peak	VERTICAL
1	125.06	42.21	-8.05	34.16	43.50	-9.34	Peak	HORIZONTAL
2	250.19	47.44	-6.71	40.73	46.00	-5.27	Peak	HORIZONTAL
3	375.32	42.52	-3.53	38.99	46.00	-7.01	Peak	HORIZONTAL
4	500.45	37.12	-1.69	35.43	46.00	-10.57	Peak	HORIZONTAL
5	624.61	42.61	0.65	43.26	46.00	-2.74	Peak	HORIZONTAL
6	860.32	33.65	4.48	38.13	46.00	-7.87	Peak	HORIZONTAL

Remark:

- 1 emission is 20dB lower, so that emission as measured between 9kHz to 30MHz is not reported
- 2 Measuring frequencies from the lowest internal frequency to the 1GHz.
- 3 Radiated emissions measured in frequency range from 9MHz to 1000MHz were made with an instrument detector setting 9-90kHz/110-490kHz using PK/AV and other Frequency Band using PK/QP
- 4 Measurement result within this frequency range shown “ - ” in the table above means the reading of emissions are attenuated more than 20dB below the permissible limits or the field strength is too small to be measured.
- 5 The IF bandwidth of SPA between 9kHz to 30MHz was 10kHz, VBW= 30kHz; between 30MHz to 1GHz was 100kHz, VBW=300kHz.

Radiated Spurious Emission Measurement Result (below 1GHz)

Operation Mode	TX MODE	Test Date	2018/12/04
Channel Number	CH High	Test By	Barry
Temperature	25	Pol	Ver./Hor
Humidity	65 %		

No	Freq MHz	Reading dBuV	Factor dB	Level dBuV/m	Limit dBuV/m	Margin dB	Remark	Pol V/H
1	70.74	44.49	-8.85	35.64	40.00	-4.36	Peak	VERTICAL
2	120.21	45.07	-8.55	36.52	43.50	-6.98	Peak	VERTICAL
3	375.32	41.71	-3.53	38.18	46.00	-7.82	Peak	VERTICAL
4	624.61	41.85	0.65	42.50	46.00	-3.50	Peak	VERTICAL
5	860.32	38.72	4.48	43.20	46.00	-2.80	Peak	VERTICAL
6	874.87	39.73	4.77	44.50	46.00	-1.50	Peak	VERTICAL
1	125.06	43.91	-8.05	35.86	43.50	-7.64	Peak	HORIZONTAL
2	250.19	47.93	-6.71	41.22	46.00	-4.78	Peak	HORIZONTAL
3	375.32	42.85	-3.53	39.32	46.00	-6.68	Peak	HORIZONTAL
4	500.45	35.43	-1.69	33.74	46.00	-12.26	Peak	HORIZONTAL
5	624.61	43.73	0.65	44.38	46.00	-1.62	Peak	HORIZONTAL
6	860.32	34.21	4.48	38.69	46.00	-7.31	Peak	HORIZONTAL

Remark:

- 1 emission is 20dB lower, so that emission as measured between 9kHz to 30MHz is not reported
- 2 Measuring frequencies from the lowest internal frequency to the 1GHz.
- 3 Radiated emissions measured in frequency range from 9MHz to 1000MHz were made with an instrument detector setting 9-90kHz/110-490kHz using PK/AV and other Frequency Band using PK/QP
- 4 Measurement result within this frequency range shown “ - ” in the table above means the reading of emissions are attenuated more than 20dB below the permissible limits or the field strength is too small to be measured.
- 5 The IF bandwidth of SPA between 9kHz to 30MHz was 10kHz, VBW= 30kHz; between 30MHz to 1GHz was 100kHz, VBW=300kHz.

Radiated Spurious Emission Measurement Result (below 1GHz)

(Worst case: Band 3, 802.11a mode)

Operation Mode	TX MODE	Test Date	2018/12/04
Channel Number	CH Low	Test By	Barry
Temperature	25	Pol	Ver./Hor
Humidity	65 %		

No	Freq MHz	Reading dBuV	Factor dB	Level dBuV/m	Limit dBuV/m	Margin dB	Remark	Pol V/H
1	375.32	38.07	-3.49	34.58	46.00	-11.42	Peak	VERTICAL
2	395.69	31.78	-3.06	28.72	46.00	-17.28	Peak	VERTICAL
3	534.40	29.25	-1.07	28.18	46.00	-17.82	Peak	VERTICAL
4	619.76	30.31	0.65	30.96	46.00	-15.04	Peak	VERTICAL
5	772.05	30.76	3.31	34.07	46.00	-11.93	Peak	VERTICAL
6	875.84	29.70	4.85	34.55	46.00	-11.45	Peak	VERTICAL
1	375.32	34.69	-3.49	31.20	46.00	-14.80	Peak	HORIZONTAL
2	500.45	30.56	-1.64	28.92	46.00	-17.08	Peak	HORIZONTAL
3	625.58	33.19	0.71	33.90	46.00	-12.10	Peak	HORIZONTAL
4	738.10	29.54	2.80	32.34	46.00	-13.66	Peak	HORIZONTAL
5	838.01	30.31	4.17	34.48	46.00	-11.52	Peak	HORIZONTAL
6	878.75	30.69	4.90	35.59	46.00	-10.41	Peak	HORIZONTAL

Remark:

- 1 emission is 20dB lower, so that emission as measured between 9kHz to 30MHz is not reported
- 2 Measuring frequencies from the lowest internal frequency to the 1GHz.
- 3 Radiated emissions measured in frequency range from 9MHz to 1000MHz were made with an instrument detector setting 9-90kHz/110-490kHz using PK/AV and other Frequency Band using PK/QP
- 4 Measurement result within this frequency range shown “ - ” in the table above means the reading of emissions are attenuated more than 20dB below the permissible limits or the field strength is too small to be measured.
- 5 The IF bandwidth of SPA between 9kHz to 30MHz was 10kHz, VBW= 30kHz; between 30MHz to 1GHz was 100kHz, VBW=300kHz.

Radiated Spurious Emission Measurement Result (below 1GHz)

Operation Mode	TX MODE	Test Date	2018/12/04
Channel Number	CH Mid	Test By	Barry
Temperature	25	Pol	Ver./Hor
Humidity	65 %		

No	Freq MHz	Reading dBuV	Factor dB	Level dBuV/m	Limit dBuV/m	Margin dB	Remark	Pol V/H
1	375.32	36.89	-3.49	33.40	46.00	-12.60	Peak	VERTICAL
2	467.47	29.97	-1.92	28.05	46.00	-17.95	Peak	VERTICAL
3	625.58	31.93	0.71	32.64	46.00	-13.36	Peak	VERTICAL
4	760.41	29.85	3.19	33.04	46.00	-12.96	Peak	VERTICAL
5	797.27	30.59	3.56	34.15	46.00	-11.85	Peak	VERTICAL
6	920.46	28.40	5.73	34.13	46.00	-11.87	Peak	VERTICAL
1	375.32	34.09	-3.49	30.60	46.00	-15.40	Peak	HORIZONTAL
2	402.48	30.12	-2.93	27.19	46.00	-18.81	Peak	HORIZONTAL
3	558.65	30.34	-0.60	29.74	46.00	-16.26	Peak	HORIZONTAL
4	625.58	35.54	0.71	36.25	46.00	-9.75	Peak	HORIZONTAL
5	755.56	30.16	3.14	33.30	46.00	-12.70	Peak	HORIZONTAL
6	840.92	30.59	4.22	34.81	46.00	-11.19	Peak	HORIZONTAL

Remark:

- 1 emission is 20dB lower, so that emission as measured between 9kHz to 30MHz is not reported
- 2 Measuring frequencies from the lowest internal frequency to the 1GHz.
- 3 Radiated emissions measured in frequency range from 9MHz to 1000MHz were made with an instrument detector setting 9-90kHz/110-490kHz using PK/AV and other Frequency Band using PK/QP
- 4 Measurement result within this frequency range shown “ - ” in the table above means the reading of emissions are attenuated more than 20dB below the permissible limits or the field strength is too small to be measured.
- 5 The IF bandwidth of SPA between 9kHz to 30MHz was 10kHz, VBW= 30kHz; between 30MHz to 1GHz was 100kHz, VBW=300kHz.

Radiated Spurious Emission Measurement Result (below 1GHz)

Operation Mode	TX MODE	Test Date	2018/12/04
Channel Number	CH High	Test By	Barry
Temperature	25	Pol	Ver./Hor
Humidity	65 %		

No	Freq MHz	Reading dBuV	Factor dB	Level dBuV/m	Limit dBuV/m	Margin dB	Remark	Pol V/H
1	36.79	44.16	-6.91	37.25	40.00	-2.75	Peak	VERTICAL
2	250.19	30.28	-6.67	23.61	46.00	-22.39	Peak	VERTICAL
3	375.32	37.63	-3.49	34.14	46.00	-11.86	Peak	VERTICAL
4	479.11	29.34	-1.83	27.51	46.00	-18.49	Peak	VERTICAL
5	625.58	30.45	0.71	31.16	46.00	-14.84	Peak	VERTICAL
6	676.99	31.27	1.49	32.76	46.00	-13.24	Peak	VERTICAL
1	375.32	34.89	-3.49	31.40	46.00	-14.60	Peak	HORIZONTAL
2	494.63	29.74	-1.69	28.05	46.00	-17.95	Peak	HORIZONTAL
3	585.81	30.00	0.07	30.07	46.00	-15.93	Peak	HORIZONTAL
4	625.58	35.64	0.71	36.35	46.00	-9.65	Peak	HORIZONTAL
5	764.29	30.03	3.24	33.27	46.00	-12.73	Peak	HORIZONTAL
6	813.76	29.65	3.81	33.46	46.00	-12.54	Peak	HORIZONTAL

Remark:

- 1 emission is 20dB lower, so that emission as measured between 9kHz to 30MHz is not reported
- 2 Measuring frequencies from the lowest internal frequency to the 1GHz.
- 3 Radiated emissions measured in frequency range from 9MHz to 1000MHz were made with an instrument detector setting 9-90kHz/110-490kHz using PK/AV and other Frequency Band using PK/QP
- 4 Measurement result within this frequency range shown “ - ” in the table above means the reading of emissions are attenuated more than 20dB below the permissible limits or the field strength is too small to be measured.
- 5 The IF bandwidth of SPA between 9kHz to 30MHz was 10kHz, VBW= 30kHz; between 30MHz to 1GHz was 100kHz, VBW=300kHz.

Radiated Spurious Emission Measurement Result (below 1GHz)
(Band 3, 802.11HT40 mode)

Operation Mode	TX MODE	Test Date	2018/12/04
Channel Number	CH Low	Test By	Barry
Temperature	25	Pol	Ver./Hor
Humidity	65 %		

No	Freq MHz	Reading dBuV	Factor dB	Level dBuV/m	Limit dBuV/m	Margin dB	Remark	Pol V/H
1	375.32	37.17	-3.49	33.68	46.00	-12.32	Peak	VERTICAL
2	500.45	30.49	-1.64	28.85	46.00	-17.15	Peak	VERTICAL
3	625.58	30.40	0.71	31.11	46.00	-14.89	Peak	VERTICAL
4	715.79	30.50	2.27	32.77	46.00	-13.23	Peak	VERTICAL
5	778.84	29.60	3.37	32.97	46.00	-13.03	Peak	VERTICAL
6	844.80	29.86	4.28	34.14	46.00	-11.86	Peak	VERTICAL
1	375.32	34.68	-3.49	31.19	46.00	-14.81	Peak	HORIZONTAL
2	500.45	31.14	-1.64	29.50	46.00	-16.50	Peak	HORIZONTAL
3	625.58	33.40	0.71	34.11	46.00	-11.89	Peak	HORIZONTAL
4	645.95	30.75	0.97	31.72	46.00	-14.28	Peak	HORIZONTAL
5	773.02	29.84	3.32	33.16	46.00	-12.84	Peak	HORIZONTAL
6	835.10	29.66	4.13	33.79	46.00	-12.21	Peak	HORIZONTAL

Remark:

- 1 emission is 20dB lower, so that emission as measured between 9kHz to 30MHz is not reported
- 2 Measuring frequencies from the lowest internal frequency to the 1GHz.
- 3 Radiated emissions measured in frequency range from 9MHz to 1000MHz were made with an instrument detector setting 9-90kHz/110-490kHz using PK/AV and other Frequency Band using PK/QP
- 4 Measurement result within this frequency range shown “ - ” in the table above means the reading of emissions are attenuated more than 20dB below the permissible limits or the field strength is too small to be measured.
- 5 The IF bandwidth of SPA between 9kHz to 30MHz was 10kHz, VBW= 30kHz; between 30MHz to 1GHz was 100kHz, VBW=300kHz.

Radiated Spurious Emission Measurement Result (below 1GHz)

Operation Mode	TX MODE	Test Date	2018/12/04
Channel Number	CH Mid	Test By	Barry
Temperature	25	Pol	Ver./Hor
Humidity	65 %		

No	Freq MHz	Reading dBuV	Factor dB	Level dBuV/m	Limit dBuV/m	Margin dB	Remark	Pol V/H
1	375.32	37.81	-3.49	34.32	46.00	-11.68	Peak	VERTICAL
2	461.65	31.39	-1.98	29.41	46.00	-16.59	Peak	VERTICAL
3	541.19	30.74	-0.96	29.78	46.00	-16.22	Peak	VERTICAL
4	625.58	30.61	0.71	31.32	46.00	-14.68	Peak	VERTICAL
5	682.81	29.99	1.58	31.57	46.00	-14.43	Peak	VERTICAL
6	750.71	30.28	3.09	33.37	46.00	-12.63	Peak	VERTICAL
1	375.32	35.41	-3.49	31.92	46.00	-14.08	Peak	HORIZONTAL
2	430.61	29.45	-2.42	27.03	46.00	-18.97	Peak	HORIZONTAL
3	490.75	29.79	-1.73	28.06	46.00	-17.94	Peak	HORIZONTAL
4	610.06	31.35	0.54	31.89	46.00	-14.11	Peak	HORIZONTAL
5	625.58	34.92	0.71	35.63	46.00	-10.37	Peak	HORIZONTAL
6	698.33	30.42	1.86	32.28	46.00	-13.72	Peak	HORIZONTAL

Remark:

- 1 emission is 20dB lower, so that emission as measured between 9kHz to 30MHz is not reported
- 2 Measuring frequencies from the lowest internal frequency to the 1GHz.
- 3 Radiated emissions measured in frequency range from 9MHz to 1000MHz were made with an instrument detector setting 9-90kHz/110-490kHz using PK/AV and other Frequency Band using PK/QP
- 4 Measurement result within this frequency range shown “ - ” in the table above means the reading of emissions are attenuated more than 20dB below the permissible limits or the field strength is too small to be measured.
- 5 The IF bandwidth of SPA between 9kHz to 30MHz was 10kHz, VBW= 30kHz; between 30MHz to 1GHz was 100kHz, VBW=300kHz.

Radiated Spurious Emission Measurement Result (below 1GHz)

Operation Mode	TX MODE	Test Date	2018/12/04
Channel Number	CH High	Test By	Barry
Temperature	25	Pol	Ver./Hor
Humidity	65 %		

No	Freq MHz	Reading dBuV	Factor dB	Level dBuV/m	Limit dBuV/m	Margin dB	Remark	Pol V/H
1	375.32	37.28	-3.49	33.79	46.00	-12.21	Peak	VERTICAL
2	395.69	31.11	-3.06	28.05	46.00	-17.95	Peak	VERTICAL
3	595.51	30.06	0.31	30.37	46.00	-15.63	Peak	VERTICAL
4	625.58	30.45	0.71	31.16	46.00	-14.84	Peak	VERTICAL
5	834.13	30.12	4.11	34.23	46.00	-11.77	Peak	VERTICAL
6	844.80	30.77	4.28	35.05	46.00	-10.95	Peak	VERTICAL
1	375.32	33.88	-3.49	30.39	46.00	-15.61	Peak	HORIZONTAL
2	500.45	29.96	-1.64	28.32	46.00	-17.68	Peak	HORIZONTAL
3	625.58	34.15	0.71	34.86	46.00	-11.14	Peak	HORIZONTAL
4	740.04	29.36	2.85	32.21	46.00	-13.79	Peak	HORIZONTAL
5	772.05	29.41	3.31	32.72	46.00	-13.28	Peak	HORIZONTAL
6	844.80	30.07	4.28	34.35	46.00	-11.65	Peak	HORIZONTAL

Remark:

- 1 emission is 20dB lower, so that emission as measured between 9kHz to 30MHz is not reported
- 2 Measuring frequencies from the lowest internal frequency to the 1GHz.
- 3 Radiated emissions measured in frequency range from 9MHz to 1000MHz were made with an instrument detector setting 9-90kHz/110-490kHz using PK/AV and other Frequency Band using PK/QP
- 4 Measurement result within this frequency range shown “ - ” in the table above means the reading of emissions are attenuated more than 20dB below the permissible limits or the field strength is too small to be measured.
- 5 The IF bandwidth of SPA between 9kHz to 30MHz was 10kHz, VBW= 30kHz; between 30MHz to 1GHz was 100kHz, VBW=300kHz.

**Radiated Spurious Emission Measurement Result (below 1GHz)
(Band 3, 802.11ac80 mode)**

Operation Mode	TX MODE	Test Date	2018/12/04
Channel Number	CH Low	Test By	Barry
Temperature	25	Pol	Ver./Hor
Humidity	65 %		

No	Freq MHz	Reading dBuV	Factor dB	Level dBuV/m	Limit dBuV/m	Margin dB	Remark	Pol V/H
1	71.71	45.47	-9.10	36.37	40.00	-3.63	Peak	VERTICAL
2	120.21	45.08	-8.55	36.53	43.50	-6.97	Peak	VERTICAL
3	375.32	40.26	-3.53	36.73	46.00	-9.27	Peak	VERTICAL
4	500.45	36.76	-1.69	35.07	46.00	-10.93	Peak	VERTICAL
5	624.61	41.54	0.65	42.19	46.00	-3.81	Peak	VERTICAL
6	874.87	39.35	4.77	44.12	46.00	-1.88	Peak	VERTICAL
1	120.21	43.67	-8.55	35.12	43.50	-8.38	Peak	HORIZONTAL
2	212.36	43.51	-8.48	35.03	43.50	-8.47	Peak	HORIZONTAL
3	250.19	48.62	-6.71	41.91	46.00	-4.09	Peak	HORIZONTAL
4	375.32	43.11	-3.53	39.58	46.00	-6.42	Peak	HORIZONTAL
5	624.61	42.73	0.65	43.38	46.00	-2.62	Peak	HORIZONTAL
6	859.35	31.97	4.47	36.44	46.00	-9.56	Peak	HORIZONTAL

Remark:

- 1 emission is 20dB lower, so that emission as measured between 9kHz to 30MHz is not reported
- 2 Measuring frequencies from the lowest internal frequency to the 1GHz.
- 3 Radiated emissions measured in frequency range from 9MHz to 1000MHz were made with an instrument detector setting 9-90kHz/110-490kHz using PK/AV and other Frequency Band using PK/QP
- 4 Measurement result within this frequency range shown “ - ” in the table above means the reading of emissions are attenuated more than 20dB below the permissible limits or the field strength is too small to be measured.
- 5 The IF bandwidth of SPA between 9kHz to 30MHz was 10kHz, VBW= 30kHz; between 30MHz to 1GHz was 100kHz, VBW=300kHz.

**Radiated Spurious Emission Measurement Result (below 1GHz)
(Band 3, 802.11ac80 mode)**

Operation Mode	TX MODE	Test Date	2018/12/04
Channel Number	CH Highc	Test By	Barry
Temperature	25	Pol	Ver./Hor
Humidity	65 %		

No	Freq MHz	Reading dBuV	Factor dB	Level dBuV/m	Limit dBuV/m	Margin dB	Remark	Pol V/H
1	35.82	40.59	-7.00	33.59	40.00	-6.41	Peak	VERTICAL
2	250.19	33.76	-6.67	27.09	46.00	-18.91	Peak	VERTICAL
3	375.32	46.54	-3.49	43.05	46.00	-2.95	Peak	VERTICAL
4	500.45	38.00	-1.64	36.36	46.00	-9.64	Peak	VERTICAL
5	625.58	34.85	0.71	35.56	46.00	-10.44	Peak	VERTICAL
6	750.71	29.83	3.09	32.92	46.00	-13.08	Peak	VERTICAL
1	125.06	39.36	-8.04	31.32	43.50	-12.18	Peak	HORIZONTAL
2	197.81	39.14	-8.54	30.60	43.50	-12.90	Peak	HORIZONTAL
3	250.19	37.45	-6.67	30.78	46.00	-15.22	Peak	HORIZONTAL
4	375.32	44.60	-3.49	41.11	46.00	-4.89	Peak	HORIZONTAL
5	500.45	34.92	-1.64	33.28	46.00	-12.72	Peak	HORIZONTAL
6	625.58	41.58	0.71	42.29	46.00	-3.71	Peak	HORIZONTAL

Remark:

- 1 emission is 20dB lower, so that emission as measured between 9kHz to 30MHz is not reported
- 2 Measuring frequencies from the lowest internal frequency to the 1GHz.
- 3 Radiated emissions measured in frequency range from 9MHz to 1000MHz were made with an instrument detector setting 9-90kHz/110-490kHz using PK/AV and other Frequency Band using PK/QP
- 4 Measurement result within this frequency range shown “ - ” in the table above means the reading of emissions are attenuated more than 20dB below the permissible limits or the field strength is too small to be measured.
- 5 The IF bandwidth of SPA between 9kHz to 30MHz was 10kHz, VBW= 30kHz; between 30MHz to 1GHz was 100kHz, VBW=300kHz.

**Radiated Spurious Emission Measurement Result (below 1GHz)
(Band 4, 802.11a mode)**

Operation Mode	TX MODE	Test Date	2018/12/04
Channel Number	CH Low	Test By	Barry
Temperature	25	Pol	Ver./Hor
Humidity	65 %		

No	Freq MHz	Reading dBuV	Factor dB	Level dBuV/m	Limit dBuV/m	Margin dB	Remark	Pol V/H
1	375.32	37.53	-3.49	34.04	46.00	-11.96	Peak	VERTICAL
2	450.98	30.98	-2.06	28.92	46.00	-17.08	Peak	VERTICAL
3	520.82	30.14	-1.30	28.84	46.00	-17.16	Peak	VERTICAL
4	608.12	30.91	0.51	31.42	46.00	-14.58	Peak	VERTICAL
5	825.40	30.49	3.98	34.47	46.00	-11.53	Peak	VERTICAL
6	948.59	30.44	6.28	36.72	46.00	-9.28	Peak	VERTICAL
1	375.32	33.90	-3.49	30.41	46.00	-15.59	Peak	HORIZONTAL
2	625.58	34.40	0.71	35.11	46.00	-10.89	Peak	HORIZONTAL
3	636.25	31.74	0.85	32.59	46.00	-13.41	Peak	HORIZONTAL
4	713.85	29.53	2.22	31.75	46.00	-14.25	Peak	HORIZONTAL
5	792.42	29.29	3.51	32.80	46.00	-13.20	Peak	HORIZONTAL
6	905.91	28.88	5.42	34.30	46.00	-11.70	Peak	HORIZONTAL

Remark:

- 1 emission is 20dB lower, so that emission as measured between 9kHz to 30MHz is not reported
- 2 Measuring frequencies from the lowest internal frequency to the 1GHz.
- 3 Radiated emissions measured in frequency range from 9MHz to 1000MHz were made with an instrument detector setting 9-90kHz/110-490kHz using PK/AV and other Frequency Band using PK/QP
- 4 Measurement result within this frequency range shown “ - ” in the table above means the reading of emissions are attenuated more than 20dB below the permissible limits or the field strength is too small to be measured.
- 5 The IF bandwidth of SPA between 9kHz to 30MHz was 10kHz, VBW= 30kHz; between 30MHz to 1GHz was 100kHz, VBW=300kHz.

Radiated Spurious Emission Measurement Result (below 1GHz)

Operation Mode	TX MODE	Test Date	2018/12/04
Channel Number	CH Mid	Test By	Barry
Temperature	25	Pol	Ver./Hor
Humidity	65 %		

No	Freq MHz	Reading dBuV	Factor dB	Level dBuV/m	Limit dBuV/m	Margin dB	Remark	Pol V/H
1	375.32	36.92	-3.49	33.43	46.00	-12.57	Peak	VERTICAL
2	396.66	30.42	-3.05	27.37	46.00	-18.63	Peak	VERTICAL
3	590.66	29.82	0.19	30.01	46.00	-15.99	Peak	VERTICAL
4	625.58	30.72	0.71	31.43	46.00	-14.57	Peak	VERTICAL
5	760.41	29.78	3.19	32.97	46.00	-13.03	Peak	VERTICAL
6	889.42	30.67	5.11	35.78	46.00	-10.22	Peak	VERTICAL
1	375.32	33.83	-3.49	30.34	46.00	-15.66	Peak	HORIZONTAL
2	586.78	29.50	0.09	29.59	46.00	-16.41	Peak	HORIZONTAL
3	625.58	34.72	0.71	35.43	46.00	-10.57	Peak	HORIZONTAL
4	741.01	29.55	2.88	32.43	46.00	-13.57	Peak	HORIZONTAL
5	793.39	29.66	3.53	33.19	46.00	-12.81	Peak	HORIZONTAL
6	926.28	29.06	5.84	34.90	46.00	-11.10	Peak	HORIZONTAL

Remark:

- 1 emission is 20dB lower, so that emission as measured between 9kHz to 30MHz is not reported
- 2 Measuring frequencies from the lowest internal frequency to the 1GHz.
- 3 Radiated emissions measured in frequency range from 9MHz to 1000MHz were made with an instrument detector setting 9-90kHz/110-490kHz using PK/AV and other Frequency Band using PK/QP
- 4 Measurement result within this frequency range shown “ - ” in the table above means the reading of emissions are attenuated more than 20dB below the permissible limits or the field strength is too small to be measured.
- 5 The IF bandwidth of SPA between 9kHz to 30MHz was 10kHz, VBW= 30kHz; between 30MHz to 1GHz was 100kHz, VBW=300kHz.

Radiated Spurious Emission Measurement Result (below 1GHz)

Operation Mode	TX MODE	Test Date	2018/12/04
Channel Number	CH High	Test By	Barry
Temperature	25	Pol	Ver./Hor
Humidity	65 %		

No	Freq MHz	Reading dBuV	Factor dB	Level dBuV/m	Limit dBuV/m	Margin dB	Remark	Pol V/H
1	106.63	36.19	-10.07	26.12	43.50	-17.38	Peak	VERTICAL
2	250.19	31.55	-6.67	24.88	46.00	-21.12	Peak	VERTICAL
3	375.32	38.15	-3.49	34.66	46.00	-11.34	Peak	VERTICAL
4	561.56	30.06	-0.53	29.53	46.00	-16.47	Peak	VERTICAL
5	708.03	30.07	2.08	32.15	46.00	-13.85	Peak	VERTICAL
6	838.01	29.75	4.17	33.92	46.00	-12.08	Peak	VERTICAL
1	375.32	34.29	-3.49	30.80	46.00	-15.20	Peak	HORIZONTAL
2	478.14	30.36	-1.84	28.52	46.00	-17.48	Peak	HORIZONTAL
3	515.00	31.45	-1.40	30.05	46.00	-15.95	Peak	HORIZONTAL
4	625.58	33.37	0.71	34.08	46.00	-11.92	Peak	HORIZONTAL
5	817.64	29.56	3.86	33.42	46.00	-12.58	Peak	HORIZONTAL
6	831.22	31.17	4.07	35.24	46.00	-10.76	Peak	HORIZONTAL

Remark:

- 1 emission is 20dB lower, so that emission as measured between 9kHz to 30MHz is not reported
- 2 Measuring frequencies from the lowest internal frequency to the 1GHz.
- 3 Radiated emissions measured in frequency range from 9MHz to 1000MHz were made with an instrument detector setting 9-90kHz/110-490kHz using PK/AV and other Frequency Band using PK/QP
- 4 Measurement result within this frequency range shown “ - ” in the table above means the reading of emissions are attenuated more than 20dB below the permissible limits or the field strength is too small to be measured.
- 5 The IF bandwidth of SPA between 9kHz to 30MHz was 10kHz, VBW= 30kHz; between 30MHz to 1GHz was 100kHz, VBW=300kHz.

**Radiated Spurious Emission Measurement Result (below 1GHz)
(Band 4, 802.11 HT40 mode)**

Operation Mode	TX MODE	Test Date	2018/12/04
Channel Number	CH Low	Test By	Barry
Temperature	25	Pol	Ver./Hor
Humidity	65 %		

No	Freq MHz	Reading dBuV	Factor dB	Level dBuV/m	Limit dBuV/m	Margin dB	Remark	Pol V/H
1	375.32	37.03	-3.49	33.54	46.00	-12.46	Peak	VERTICAL
2	395.69	30.98	-3.06	27.92	46.00	-18.08	Peak	VERTICAL
3	607.15	30.85	0.51	31.36	46.00	-14.64	Peak	VERTICAL
4	625.58	30.79	0.71	31.50	46.00	-14.50	Peak	VERTICAL
5	695.42	30.15	1.80	31.95	46.00	-14.05	Peak	VERTICAL
6	805.03	29.36	3.67	33.03	46.00	-12.97	Peak	VERTICAL
1	375.32	33.75	-3.49	30.26	46.00	-15.74	Peak	HORIZONTAL
2	603.27	31.28	0.47	31.75	46.00	-14.25	Peak	HORIZONTAL
3	625.58	33.89	0.71	34.60	46.00	-11.40	Peak	HORIZONTAL
4	634.31	31.55	0.82	32.37	46.00	-13.63	Peak	HORIZONTAL
5	706.09	30.44	2.02	32.46	46.00	-13.54	Peak	HORIZONTAL
6	750.71	30.04	3.09	33.13	46.00	-12.87	Peak	HORIZONTAL

Remark:

- 1 emission is 20dB lower, so that emission as measured between 9kHz to 30MHz is not reported
- 2 Measuring frequencies from the lowest internal frequency to the 1GHz.
- 3 Radiated emissions measured in frequency range from 9MHz to 1000MHz were made with an instrument detector setting 9-90kHz/110-490kHz using PK/AV and other Frequency Band using PK/QP
- 4 Measurement result within this frequency range shown “ - ” in the table above means the reading of emissions are attenuated more than 20dB below the permissible limits or the field strength is too small to be measured.
- 5 The IF bandwidth of SPA between 9kHz to 30MHz was 10kHz, VBW= 30kHz; between 30MHz to 1GHz was 100kHz, VBW=300kHz.

Radiated Spurious Emission Measurement Result (below 1GHz)

Operation Mode	TX MODE	Test Date	2018/12/04
Channel Number	CH Mid	Test By	Barry
Temperature	25	Pol	Ver./Hor
Humidity	65 %		

No	Freq MHz	Reading dBuV	Factor dB	Level dBuV/m	Limit dBuV/m	Margin dB	Remark	Pol V/H
1	375.32	38.17	-3.49	34.68	46.00	-11.32	Peak	VERTICAL
2	549.92	31.26	-0.81	30.45	46.00	-15.55	Peak	VERTICAL
3	625.58	31.48	0.71	32.19	46.00	-13.81	Peak	VERTICAL
4	710.94	30.70	2.15	32.85	46.00	-13.15	Peak	VERTICAL
5	750.71	30.33	3.09	33.42	46.00	-12.58	Peak	VERTICAL
6	802.12	29.77	3.62	33.39	46.00	-12.61	Peak	VERTICAL
1	375.32	34.59	-3.49	31.10	46.00	-14.90	Peak	HORIZONTAL
2	468.44	30.04	-1.92	28.12	46.00	-17.88	Peak	HORIZONTAL
3	545.07	29.90	-0.90	29.00	46.00	-17.00	Peak	HORIZONTAL
4	625.58	34.07	0.71	34.78	46.00	-11.22	Peak	HORIZONTAL
5	811.82	29.67	3.77	33.44	46.00	-12.56	Peak	HORIZONTAL
6	855.47	30.53	4.46	34.99	46.00	-11.01	Peak	HORIZONTAL

Remark:

- 1 emission is 20dB lower, so that emission as measured between 9kHz to 30MHz is not reported
- 2 Measuring frequencies from the lowest internal frequency to the 1GHz.
- 3 Radiated emissions measured in frequency range from 9MHz to 1000MHz were made with an instrument detector setting 9-90kHz/110-490kHz using PK/AV and other Frequency Band using PK/QP
- 4 Measurement result within this frequency range shown “ - ” in the table above means the reading of emissions are attenuated more than 20dB below the permissible limits or the field strength is too small to be measured.
- 5 The IF bandwidth of SPA between 9kHz to 30MHz was 10kHz, VBW= 30kHz; between 30MHz to 1GHz was 100kHz, VBW=300kHz.

Radiated Spurious Emission Measurement Result (below 1GHz)

Operation Mode	TX MODE	Test Date	2018/12/04
Channel Number	CH High	Test By	Barry
Temperature	25	Pol	Ver./Hor
Humidity	65 %		

No	Freq MHz	Reading dBuV	Factor dB	Level dBuV/m	Limit dBuV/m	Margin dB	Remark	Pol V/H
1	106.63	37.07	-10.07	27.00	43.50	-16.50	Peak	VERTICAL
2	375.32	37.15	-3.49	33.66	46.00	-12.34	Peak	VERTICAL
3	451.95	29.74	-2.06	27.68	46.00	-18.32	Peak	VERTICAL
4	566.41	31.05	-0.42	30.63	46.00	-15.37	Peak	VERTICAL
5	676.99	28.87	1.49	30.36	46.00	-15.64	Peak	VERTICAL
6	792.42	29.31	3.51	32.82	46.00	-13.18	Peak	VERTICAL
1	375.32	34.15	-3.49	30.66	46.00	-15.34	Peak	HORIZONTAL
2	500.45	30.30	-1.64	28.66	46.00	-17.34	Peak	HORIZONTAL
3	625.58	34.28	0.71	34.99	46.00	-11.01	Peak	HORIZONTAL
4	770.11	29.35	3.29	32.64	46.00	-13.36	Peak	HORIZONTAL
5	829.28	29.78	4.03	33.81	46.00	-12.19	Peak	HORIZONTAL
6	895.24	29.56	5.21	34.77	46.00	-11.23	Peak	HORIZONTAL

Remark:

- 1 emission is 20dB lower, so that emission as measured between 9kHz to 30MHz is not reported
- 2 Measuring frequencies from the lowest internal frequency to the 1GHz.
- 3 Radiated emissions measured in frequency range from 9MHz to 1000MHz were made with an instrument detector setting 9-90kHz/110-490kHz using PK/AV and other Frequency Band using PK/QP
- 4 Measurement result within this frequency range shown “ - ” in the table above means the reading of emissions are attenuated more than 20dB below the permissible limits or the field strength is too small to be measured.
- 5 The IF bandwidth of SPA between 9kHz to 30MHz was 10kHz, VBW= 30kHz; between 30MHz to 1GHz was 100kHz, VBW=300kHz.

Radiated Spurious Emission Measurement Result (below 1GHz)

(Band 4, 802.11ac80 mode)

Operation Mode	TX MODE	Test Date	2018/12/04
Channel Number	CH Low	Test By	Barry
Temperature	25	Pol	Ver./Hor
Humidity	65 %		

No	Freq MHz	Reading dBuV	Factor dB	Level dBuV/m	Limit dBuV/m	Margin dB	Remark	Pol V/H
1	375.32	34.15	-3.49	30.66	46.00	-15.34	Peak	VERTICAL
2	564.47	31.05	-0.45	30.60	46.00	-15.40	Peak	VERTICAL
3	625.58	34.28	0.71	34.99	46.00	-11.01	Peak	VERTICAL
4	770.11	29.35	3.29	32.64	46.00	-13.36	Peak	VERTICAL
5	837.04	29.77	4.16	33.93	46.00	-12.07	Peak	VERTICAL
6	895.24	29.56	5.21	34.77	46.00	-11.23	Peak	VERTICAL
1	375.32	34.15	-3.49	30.66	46.00	-15.34	Peak	HORIZONTAL
2	564.47	31.05	-0.45	30.60	46.00	-15.40	Peak	HORIZONTAL
3	625.58	34.28	0.71	34.99	46.00	-11.01	Peak	HORIZONTAL
4	720.64	30.16	2.38	32.54	46.00	-13.46	Peak	HORIZONTAL
5	770.11	29.35	3.29	32.64	46.00	-13.36	Peak	HORIZONTAL
6	895.24	29.56	5.21	34.77	46.00	-11.23	Peak	HORIZONTAL

Remark:

- 1 emission is 20dB lower, so that emission as measured between 9kHz to 30MHz is not reported
- 2 Measuring frequencies from the lowest internal frequency to the 1GHz.
- 3 Radiated emissions measured in frequency range from 9MHz to 1000MHz were made with an instrument detector setting 9-90kHz/110-490kHz using PK/AV and other Frequency Band using PK/QP
- 4 Measurement result within this frequency range shown “ - ” in the table above means the reading of emissions are attenuated more than 20dB below the permissible limits or the field strength is too small to be measured.
- 5 The IF bandwidth of SPA between 9kHz to 30MHz was 10kHz, VBW= 30kHz; between 30MHz to 1GHz was 100kHz, VBW=300kHz.

Radiated Spurious Emission Measurement Result (below 1GHz)
(Band 4, 802.11ac80 mode)

Operation Mode	TX MODE	Test Date	2018/12/04
Channel Number	CH Highc	Test By	Barry
Temperature	25	Pol	Ver./Hor
Humidity	65 %		

No	Freq MHz	Reading dBuV	Factor dB	Level dBuV/m	Limit dBuV/m	Margin dB	Remark	Pol V/H
1	68.80	44.23	-8.43	35.80	40.00	-4.20	Peak	VERTICAL
2	120.21	45.88	-8.55	37.33	43.50	-6.17	Peak	VERTICAL
3	375.32	38.40	-3.53	34.87	46.00	-11.13	Peak	VERTICAL
4	624.61	41.77	0.65	42.42	46.00	-3.58	Peak	VERTICAL
5	859.35	38.77	4.47	43.24	46.00	-2.76	Peak	VERTICAL
6	874.87	39.07	4.77	43.84	46.00	-2.16	Peak	VERTICAL
1	120.21	43.55	-8.55	35.00	43.50	-8.50	Peak	HORIZONTAL
2	215.27	41.59	-8.37	33.22	43.50	-10.28	Peak	HORIZONTAL
3	250.19	47.07	-6.71	40.36	46.00	-5.64	Peak	HORIZONTAL
4	500.45	33.01	-1.69	31.32	46.00	-14.68	Peak	HORIZONTAL
5	539.25	32.38	-1.05	31.33	46.00	-14.67	Peak	HORIZONTAL
6	859.35	33.43	4.47	37.90	46.00	-8.10	Peak	HORIZONTAL

Remark:

- 1 emission is 20dB lower, so that emission as measured between 9kHz to 30MHz is not reported
- 2 Measuring frequencies from the lowest internal frequency to the 1GHz.
- 3 Radiated emissions measured in frequency range from 9MHz to 1000MHz were made with an instrument detector setting 9-90kHz/110-490kHz using PK/AV and other Frequency Band using PK/QP
- 4 Measurement result within this frequency range shown “ - ” in the table above means the reading of emissions are attenuated more than 20dB below the permissible limits or the field strength is too small to be measured.
- 5 The IF bandwidth of SPA between 9kHz to 30MHz was 10kHz, VBW= 30kHz; between 30MHz to 1GHz was 100kHz, VBW=300kHz.

Radiated Spurious Emission Measurement Result (above 1GHz)

(Worst case: Band 1-2, 802.11a mode)

Operation Mode	TX MODE	Test Date	2018/12/04
Channel Number	CH Low	Test By	Barry
Temperature	25	Humidity	60 %

No	Freq MHz	Reading dBuV	Factor dB	Level dBuV/m	Limit dBuV/m	Margin dB	Remark	Pol V/H
1	4094.00	50.68	-11.67	39.01	74.00	-34.99	Peak	VERTICAL
2	5802.00	50.72	-6.55	44.17	68.20	-24.03	Peak	VERTICAL
3	10360.00	36.56	4.29	40.85	68.20	-27.35	Peak	VERTICAL
4	15540.00	39.07	8.02	47.09	74.00	-26.91	Peak	VERTICAL
1	4948.00	51.31	-8.89	42.42	68.20	-25.78	Peak	HORIZONTAL
2	7174.00	49.12	-1.85	47.27	68.20	-20.93	Peak	HORIZONTAL
3	10360.00	35.70	4.29	39.99	68.20	-28.21	Peak	HORIZONTAL
4	15540.00	40.96	8.02	48.98	74.00	-25.02	Peak	HORIZONTAL

Remark:

- 1 Field strength limits for frequency above 1000MHz are based on average limits. However, Peak mode field strength shall not exceed the average limits specified plus 20dB.
- 2 Measurement of data within this frequency range shown “ - ” in the table above means the reading of emissions are attenuated more than 20dB below the permissible limits or the field strength is too small to be measured.
- 3 Spectrum Peak mode IF bandwidth Setting : 1GHz- 26GHz, RBW= 1MHz, Sweep time= 200 ms., the VBW setting was 3 MHz.
- 4 Spectrum AV mode if bandwidth Setting : 1GHz- 26GHz, RBW= 1MHz, VBW= 10Hz, Sweep time= 200 ms.

Radiated Spurious Emission Measurement Result (above 1GHz)

Operation Mode	TX MODE	Test Date	2018/12/04
Channel Number	CH Mid	Test By	Barry
Temperature	25	Humidity	60 %

No	Freq MHz	Reading dBuV	Factor dB	Level dBuV/m	Limit dBuV/m	Margin dB	Remark	Pol V/H
1	3058.00	52.45	-14.43	38.02	68.20	-30.18	Peak	VERTICAL
2	6537.00	49.10	-3.97	45.13	68.20	-23.07	Peak	VERTICAL
3	10520.00	37.45	4.74	42.19	68.20	-26.01	Peak	VERTICAL
4	15780.00	42.49	7.25	49.74	74.00	-24.26	Peak	VERTICAL
1	2456.00	51.60	-15.72	35.88	68.20	-32.32	Peak	HORIZONTAL
2	6355.00	49.06	-4.57	44.49	68.20	-23.71	Peak	HORIZONTAL
3	10520.00	35.90	4.74	40.64	68.20	-27.56	Peak	HORIZONTAL
4	15780.00	37.91	7.25	45.16	74.00	-28.84	Peak	HORIZONTAL

Remark:

- 1 Field strength limits for frequency above 1000MHz are based on average limits. However, Peak mode field strength shall not exceed the average limits specified plus 20dB.
- 2 Measurement of data within this frequency range shown “ - ” in the table above means the reading of emissions are attenuated more than 20dB below the permissible limits or the field strength is too small to be measured.
- 3 Spectrum Peak mode IF bandwidth Setting : 1GHz- 26GHz, RBW= 1MHz, Sweep time= 200 ms., the VBW setting was 3 MHz.
- 4 Spectrum AV mode if bandwidth Setting : 1GHz- 26GHz, RBW= 1MHz, VBW= 10Hz, Sweep time= 200 ms.

Radiated Spurious Emission Measurement Result (above 1GHz)

Operation Mode	TX MODE	Test Date	2018/12/04
Channel Number	CH High	Test By	Barry
Temperature	25	Humidity	60 %

No	Freq MHz	Reading dBuV	Factor dB	Level dBuV/m	Limit dBuV/m	Margin dB	Remark	Pol V/H
1	4577.00	51.14	-10.06	41.08	74.00	-32.92	Peak	VERTICAL
2	5802.00	50.32	-6.55	43.77	68.20	-24.43	Peak	VERTICAL
3	10640.00	36.82	5.11	41.93	74.00	-32.07	Peak	VERTICAL
4	15960.00	38.62	6.67	45.29	74.00	-28.71	Peak	VERTICAL
1	4178.00	51.21	-11.41	39.80	74.00	-34.20	Peak	HORIZONTAL
2	7125.00	50.52	-2.12	48.40	68.20	-19.80	Peak	HORIZONTAL
3	10640.00	35.91	5.11	41.02	74.00	-32.98	Peak	HORIZONTAL
4	15960.00	38.81	6.67	45.48	74.00	-28.52	Peak	HORIZONTAL

Remark:

- 1 Field strength limits for frequency above 1000MHz are based on average limits. However, Peak mode field strength shall not exceed the average limits specified plus 20dB.
- 2 Measurement of data within this frequency range shown “ - ” in the table above means the reading of emissions are attenuated more than 20dB below the permissible limits or the field strength is too small to be measured.
- 3 Spectrum Peak mode IF bandwidth Setting : 1GHz- 26GHz, RBW= 1MHz, Sweep time= 200 ms., the VBW setting was 3 MHz.
- 4 Spectrum AV mode if bandwidth Setting : 1GHz- 26GHz, RBW= 1MHz, VBW= 10Hz, Sweep time= 200 ms.

**Radiated Spurious Emission Measurement Result (above 1GHz)
(Band 1-2, 802.11 HT40 mode)**

Operation Mode	TX MODE	Test Date	2018/12/04
Channel Number	CH Low	Test By	Barry
Temperature	25	Humidity	60 %

No	Freq MHz	Reading dBuV	Factor dB	Level dBuV/m	Limit dBuV/m	Margin dB	Remark	Pol V/H
1	2470.00	52.85	-15.72	37.13	68.20	-31.07	Peak	VERTICAL
2	3947.00	50.62	-12.17	38.45	74.00	-35.55	Peak	VERTICAL
3	10380.00	35.61	4.35	39.96	68.20	-28.24	Peak	VERTICAL
4	15570.00	36.65	7.94	44.59	74.00	-29.41	Peak	VERTICAL
1	2225.00	50.93	-15.65	35.28	74.00	-38.72	Peak	HORIZONTAL
2	3856.00	50.11	-12.55	37.56	74.00	-36.44	Peak	HORIZONTAL
3	10380.00	35.99	4.35	40.34	68.20	-27.86	Peak	HORIZONTAL
4	15570.00	39.79	7.94	47.73	74.00	-26.27	Peak	HORIZONTAL

Remark:

- 1 Field strength limits for frequency above 1000MHz are based on average limits. However, Peak mode field strength shall not exceed the average limits specified plus 20dB.
- 2 Measurement of data within this frequency range shown “ - ” in the table above means the reading of emissions are attenuated more than 20dB below the permissible limits or the field strength is too small to be measured.
- 3 Spectrum Peak mode IF bandwidth Setting : 1GHz- 26GHz, RBW= 1MHz, Sweep time= 200 ms., the VBW setting was 3 MHz.
- 4 Spectrum AV mode if bandwidth Setting : 1GHz- 26GHz, RBW= 1MHz, VBW= 10Hz, Sweep time= 200 ms.

Radiated Spurious Emission Measurement Result (above 1GHz)

Operation Mode	TX MODE	Test Date	2018/12/04
Channel Number	CH Mid	Test By	Barry
Temperature	25	Humidity	60 %

No	Freq MHz	Reading dBuV	Factor dB	Level dBuV/m	Limit dBuV/m	Margin dB	Remark	Pol V/H
1	2764.00	53.00	-15.15	37.85	74.00	-36.15	Peak	VERTICAL
2	3513.00	51.88	-13.66	38.22	68.20	-29.98	Peak	VERTICAL
3	10540.00	35.19	4.81	40.00	68.20	-28.20	Peak	VERTICAL
4	15810.00	39.29	7.14	46.43	74.00	-27.57	Peak	VERTICAL
1	2281.00	50.58	-15.61	34.97	74.00	-39.03	Peak	HORIZONTAL
2	4066.00	49.97	-11.75	38.22	68.20	-29.98	Peak	HORIZONTAL
3	10540.00	35.34	4.81	40.15	68.20	-28.05	Peak	HORIZONTAL
4	15810.00	37.55	7.14	44.69	74.00	-29.31	Peak	HORIZONTAL

Remark:

- 1 Field strength limits for frequency above 1000MHz are based on average limits. However, Peak mode field strength shall not exceed the average limits specified plus 20dB.
- 2 Measurement of data within this frequency range shown “ - ” in the table above means the reading of emissions are attenuated more than 20dB below the permissible limits or the field strength is too small to be measured.
- 3 Spectrum Peak mode IF bandwidth Setting : 1GHz- 26GHz, RBW= 1MHz, Sweep time= 200 ms., the VBW setting was 3 MHz.
- 4 Spectrum AV mode if bandwidth Setting : 1GHz- 26GHz, RBW= 1MHz, VBW= 10Hz, Sweep time= 200 ms.

Radiated Spurious Emission Measurement Result (above 1GHz)

Operation Mode	TX MODE	Test Date	2018/12/04
Channel Number	CH High	Test By	Barry
Temperature	25	Humidity	60 %

No	Freq MHz	Reading dBuV	Factor dB	Level dBuV/m	Limit dBuV/m	Margin dB	Remark	Pol V/H
1	2771.00	55.26	-15.15	40.11	74.00	-33.89	Peak	VERTICAL
2	4556.00	52.12	-10.12	42.00	74.00	-32.00	Peak	VERTICAL
3	10620.00	35.06	5.05	40.11	74.00	-33.89	Peak	VERTICAL
4	15930.00	38.06	6.75	44.81	74.00	-29.19	Peak	VERTICAL
1	2498.00	53.87	-15.71	38.16	74.00	-35.84	Peak	HORIZONTAL
2	4038.00	51.39	-11.85	39.54	74.00	-34.46	Peak	HORIZONTAL
3	10620.00	35.46	5.05	40.51	74.00	-33.49	Peak	HORIZONTAL
4	15930.00	39.25	6.75	46.00	74.00	-28.00	Peak	HORIZONTAL

Remark:

- 1 Field strength limits for frequency above 1000MHz are based on average limits. However, Peak mode field strength shall not exceed the average limits specified plus 20dB.
- 2 Measurement of data within this frequency range shown “ - ” in the table above means the reading of emissions are attenuated more than 20dB below the permissible limits or the field strength is too small to be measured.
- 3 Spectrum Peak mode IF bandwidth Setting : 1GHz- 26GHz, RBW= 1MHz, Sweep time= 200 ms., the VBW setting was 3 MHz.
- 4 Spectrum AV mode if bandwidth Setting : 1GHz- 26GHz, RBW= 1MHz, VBW= 10Hz, Sweep time= 200 ms.

Radiated Spurious Emission Measurement Result (above 1GHz)
(Band 1-2, 802.11 ac80 mode)

Operation Mode	TX MODE	Test Date	2018/12/04
Channel Number	CH Low	Test By	Barry
Temperature	25	Humidity	60 %

No	Freq MHz	Reading dBuV	Factor dB	Level dBuV/m	Limit dBuV/m	Margin dB	Remark	Pol V/H
1	2764.00	49.52	-15.15	34.37	74.00	-39.63	Peak	VERTICAL
2	3128.00	49.37	-14.34	35.03	68.20	-33.17	Peak	VERTICAL
3	10420.00	32.20	4.47	36.67	68.20	-31.53	Peak	VERTICAL
4	15630.00	37.09	7.74	44.83	74.00	-29.17	Peak	VERTICAL
1	2386.00	48.73	-15.71	33.02	74.00	-40.98	Peak	HORIZONTAL
2	3926.00	47.79	-12.26	35.53	74.00	-38.47	Peak	HORIZONTAL
3	10420.00	32.61	4.47	37.08	68.20	-31.12	Peak	HORIZONTAL
4	15630.00	38.01	7.74	45.75	74.00	-28.25	Peak	HORIZONTAL

Remark:

- 1 Field strength limits for frequency above 1000MHz are based on average limits. However, Peak mode field strength shall not exceed the average limits specified plus 20dB.
- 2 Measurement of data within this frequency range shown “ - ” in the table above means the reading of emissions are attenuated more than 20dB below the permissible limits or the field strength is too small to be measured.
- 3 Spectrum Peak mode IF bandwidth Setting : 1GHz- 26GHz, RBW= 1MHz, Sweep time= 200 ms., the VBW setting was 3 MHz.
- 4 Spectrum AV mode if bandwidth Setting : 1GHz- 26GHz, RBW= 1MHz, VBW= 10Hz, Sweep time= 200 ms.

Radiated Spurious Emission Measurement Result (above 1GHz)

(Worst case: Band 3, 802.11a mode)

Operation Mode	TX MODE	Test Date	2018/12/04
Channel Number	CH Low	Test By	Barry
Temperature	25	Humidity	60 %

No	Freq MHz	Reading dBuV	Factor dB	Level dBuV/m	Limit dBuV/m	Margin dB	Remark	Pol V/H
1	2498.00	55.65	-15.71	39.94	74.00	-34.06	Peak	VERTICAL
2	4297.00	50.68	-11.05	39.63	74.00	-34.37	Peak	VERTICAL
3	11000.00	36.90	6.19	43.09	74.00	-30.91	Peak	VERTICAL
4	16500.00	37.08	7.89	44.97	68.20	-23.23	Peak	VERTICAL
1	2498.00	54.21	-15.71	38.50	74.00	-35.50	Peak	HORIZONTAL
2	4248.00	50.56	-11.21	39.35	74.00	-34.65	Peak	HORIZONTAL
3	11000.00	35.78	6.19	41.97	74.00	-32.03	Peak	HORIZONTAL
4	16500.00	38.48	7.89	46.37	68.20	-21.83	Peak	HORIZONTAL

Remark:

- 1 Field strength limits for frequency above 1000MHz are based on average limits. However, Peak mode field strength shall not exceed the average limits specified plus 20dB.
- 2 Measurement of data within this frequency range shown “ - ” in the table above means the reading of emissions are attenuated more than 20dB below the permissible limits or the field strength is too small to be measured.
- 3 Spectrum Peak mode IF bandwidth Setting : 1GHz- 26GHz, RBW= 1MHz, Sweep time= 200 ms., the VBW setting was 3 MHz.
- 4 Spectrum AV mode if bandwidth Setting : 1GHz- 26GHz, RBW= 1MHz, VBW= 10Hz, Sweep time= 200 ms.

Radiated Spurious Emission Measurement Result (above 1GHz)

Operation Mode	TX MODE	Test Date	2018/12/04
Channel Number	CH Mid	Test By	Barry
Temperature	25	Humidity	60 %

No	Freq MHz	Reading dBuV	Factor dB	Level dBuV/m	Limit dBuV/m	Margin dB	Remark	Pol V/H
1	2764.00	52.35	-15.15	37.20	74.00	-36.80	Peak	VERTICAL
2	4430.00	50.09	-10.57	39.52	68.20	-28.68	Peak	VERTICAL
3	11200.00	35.16	6.41	41.57	74.00	-32.43	Peak	VERTICAL
4	16800.00	38.85	8.89	47.74	68.20	-20.46	Peak	VERTICAL
1	3492.00	51.61	-13.77	37.84	74.00	-36.16	Peak	HORIZONTAL
2	4647.00	49.81	-9.79	40.02	74.00	-33.98	Peak	HORIZONTAL
3	11200.00	33.43	6.41	39.84	74.00	-34.16	Peak	HORIZONTAL
4	16800.00	37.20	8.89	46.09	68.20	-22.11	Peak	HORIZONTAL

Remark:

- 1 Field strength limits for frequency above 1000MHz are based on average limits. However, Peak mode field strength shall not exceed the average limits specified plus 20dB.
- 2 Measurement of data within this frequency range shown “ - ” in the table above means the reading of emissions are attenuated more than 20dB below the permissible limits or the field strength is too small to be measured.
- 3 Spectrum Peak mode IF bandwidth Setting : 1GHz- 26GHz, RBW= 1MHz, Sweep time= 200 ms., the VBW setting was 3 MHz.
- 4 Spectrum AV mode if bandwidth Setting : 1GHz- 26GHz, RBW= 1MHz, VBW= 10Hz, Sweep time= 200 ms.

Radiated Spurious Emission Measurement Result (above 1GHz)

Operation Mode	TX MODE	Test Date	2018/12/04
Channel Number	CH High	Test By	Barry
Temperature	25	Humidity	60 %

No	Freq MHz	Reading dBuV	Factor dB	Level dBuV/m	Limit dBuV/m	Margin dB	Remark	Pol V/H
1	2778.00	51.08	-15.13	35.95	74.00	-38.05	Peak	VERTICAL
2	4465.00	50.20	-10.43	39.77	68.20	-28.43	Peak	VERTICAL
3	11400.00	32.71	6.62	39.33	74.00	-34.67	Peak	VERTICAL
4	17100.00	36.01	10.45	46.46	68.20	-21.74	Peak	VERTICAL
1	3121.00	50.59	-14.33	36.26	68.20	-31.94	Peak	HORIZONTAL
2	4360.00	50.48	-10.82	39.66	74.00	-34.34	Peak	HORIZONTAL
3	11400.00	35.50	6.62	42.12	74.00	-31.88	Peak	HORIZONTAL
4	17100.00	36.72	10.45	47.17	68.20	-21.03	Peak	HORIZONTAL

Remark:

- 1 Field strength limits for frequency above 1000MHz are based on average limits. However, Peak mode field strength shall not exceed the average limits specified plus 20dB.
- 2 Measurement of data within this frequency range shown “ - ” in the table above means the reading of emissions are attenuated more than 20dB below the permissible limits or the field strength is too small to be measured.
- 3 Spectrum Peak mode IF bandwidth Setting : 1GHz- 26GHz, RBW= 1MHz, Sweep time= 200 ms., the VBW setting was 3 MHz.
- 4 Spectrum AV mode if bandwidth Setting : 1GHz- 26GHz, RBW= 1MHz, VBW= 10Hz, Sweep time= 200 ms.

Radiated Spurious Emission Measurement Result (above 1GHz)

(Band 3, 802.11 HT40 mode)

Operation Mode	TX MODE	Test Date	2018/12/04
Channel Number	CH Low	Test By	Barry
Temperature	25	Humidity	60 %

No	Freq MHz	Reading dBuV	Factor dB	Level dBuV/m	Limit dBuV/m	Margin dB	Remark	Pol V/H
1	3086.00	51.72	-14.36	37.36	68.20	-30.84	Peak	VERTICAL
2	4556.00	51.82	-10.12	41.70	74.00	-32.30	Peak	VERTICAL
3	11020.00	37.20	6.21	43.41	74.00	-30.59	Peak	VERTICAL
4	16530.00	37.96	8.00	45.96	68.20	-22.24	Peak	VERTICAL
1	3065.00	51.67	-14.42	37.25	68.20	-30.95	Peak	HORIZONTAL
2	4094.00	51.85	-11.67	40.18	74.00	-33.82	Peak	HORIZONTAL
3	11020.00	34.19	6.21	40.40	74.00	-33.60	Peak	HORIZONTAL
4	16530.00	38.11	8.00	46.11	68.20	-22.09	Peak	HORIZONTAL

Remark:

- 1 Field strength limits for frequency above 1000MHz are based on average limits. However, Peak mode field strength shall not exceed the average limits specified plus 20dB.
- 2 Measurement of data within this frequency range shown “ - ” in the table above means the reading of emissions are attenuated more than 20dB below the permissible limits or the field strength is too small to be measured.
- 3 Spectrum Peak mode IF bandwidth Setting : 1GHz- 26GHz, RBW= 1MHz, Sweep time= 200 ms., the VBW setting was 3 MHz.
- 4 Spectrum AV mode if bandwidth Setting : 1GHz- 26GHz, RBW= 1MHz, VBW= 10Hz, Sweep time= 200 ms.

Radiated Spurious Emission Measurement Result (above 1GHz)

Operation Mode	TX MODE	Test Date	2018/12/04
Channel Number	CH Mid	Test By	Barry
Temperature	25	Humidity	60 %

No	Freq MHz	Reading dBuV	Factor dB	Level dBuV/m	Limit dBuV/m	Margin dB	Remark	Pol V/H
1	2834.00	51.73	-15.04	36.69	74.00	-37.31	Peak	VERTICAL
2	4073.00	51.32	-11.74	39.58	74.00	-34.42	Peak	VERTICAL
3	11100.00	35.06	6.30	41.36	74.00	-32.64	Peak	VERTICAL
4	16650.00	38.04	8.40	46.44	68.20	-21.76	Peak	VERTICAL
1	3653.00	51.52	-13.18	38.34	74.00	-35.66	Peak	HORIZONTAL
2	4752.00	50.85	-9.42	41.43	74.00	-32.57	Peak	HORIZONTAL
3	11100.00	35.38	6.30	41.68	74.00	-32.32	Peak	HORIZONTAL
4	16650.00	35.42	8.40	43.82	68.20	-24.38	Peak	HORIZONTAL

Remark:

- 1 Field strength limits for frequency above 1000MHz are based on average limits. However, Peak mode field strength shall not exceed the average limits specified plus 20dB.
- 2 Measurement of data within this frequency range shown “ - ” in the table above means the reading of emissions are attenuated more than 20dB below the permissible limits or the field strength is too small to be measured.
- 3 Spectrum Peak mode IF bandwidth Setting : 1GHz- 26GHz, RBW= 1MHz, Sweep time= 200 ms., the VBW setting was 3 MHz.
- 4 Spectrum AV mode if bandwidth Setting : 1GHz- 26GHz, RBW= 1MHz, VBW= 10Hz, Sweep time= 200 ms.

Radiated Spurious Emission Measurement Result (above 1GHz)

Operation Mode	TX MODE	Test Date	2018/12/04
Channel Number	CH High	Test By	Barry
Temperature	25	Humidity	60 %

No	Freq MHz	Reading dBuV	Factor dB	Level dBuV/m	Limit dBuV/m	Margin dB	Remark	Pol V/H
1	3170.00	51.74	-14.36	37.38	68.20	-30.82	Peak	VERTICAL
2	3709.00	51.02	-13.04	37.98	74.00	-36.02	Peak	VERTICAL
3	11340.00	37.41	6.56	43.97	74.00	-30.03	Peak	VERTICAL
4	17010.00	39.53	9.65	49.18	68.20	-19.02	Peak	VERTICAL
1	2330.00	51.58	-15.65	35.93	74.00	-38.07	Peak	HORIZONTAL
2	4605.00	49.39	-9.97	39.42	74.00	-34.58	Peak	HORIZONTAL
3	11340.00	35.29	6.56	41.85	74.00	-32.15	Peak	HORIZONTAL
4	17010.00	38.44	9.65	48.09	68.20	-20.11	Peak	HORIZONTAL

Remark:

- 1 Field strength limits for frequency above 1000MHz are based on average limits. However, Peak mode field strength shall not exceed the average limits specified plus 20dB.
- 2 Measurement of data within this frequency range shown “ - ” in the table above means the reading of emissions are attenuated more than 20dB below the permissible limits or the field strength is too small to be measured.
- 3 Spectrum Peak mode IF bandwidth Setting : 1GHz- 26GHz, RBW= 1MHz, Sweep time= 200 ms., the VBW setting was 3 MHz.
- 4 Spectrum AV mode if bandwidth Setting : 1GHz- 26GHz, RBW= 1MHz, VBW= 10Hz, Sweep time= 200 ms.

**Radiated Spurious Emission Measurement Result (above 1GHz)
(Band 3, 802.11 ac80 mode)**

Operation Mode	TX MODE	Test Date	2018/12/04
Channel Number	CH Low	Test By	Barry
Temperature	25	Humidity	60 %

No	Freq MHz	Reading dBuV	Factor dB	Level dBuV/m	Limit dBuV/m	Margin dB	Remark	Pol V/H
1	2778.00	52.92	-15.13	37.79	74.00	-36.21	Peak	VERTICAL
2	4752.00	47.36	-9.42	37.94	74.00	-36.06	Peak	VERTICAL
3	11060.00	32.01	6.26	38.27	74.00	-35.73	Peak	VERTICAL
4	16590.00	38.18	8.20	46.38	68.20	-21.82	Peak	VERTICAL
1	2631.00	48.34	-15.37	32.97	68.20	-35.23	Peak	HORIZONTAL
2	4402.00	48.42	-10.68	37.74	68.20	-30.46	Peak	HORIZONTAL
3	11060.00	32.92	6.26	39.18	74.00	-34.82	Peak	HORIZONTAL
4	16590.00	35.92	8.20	44.12	68.20	-24.08	Peak	HORIZONTAL

Remark:

- 1 Field strength limits for frequency above 1000MHz are based on average limits. However, Peak mode field strength shall not exceed the average limits specified plus 20dB.
- 2 Measurement of data within this frequency range shown “ - ” in the table above means the reading of emissions are attenuated more than 20dB below the permissible limits or the field strength is too small to be measured.
- 3 Spectrum Peak mode IF bandwidth Setting : 1GHz- 26GHz, RBW= 1MHz, Sweep time= 200 ms., the VBW setting was 3 MHz.
- 4 Spectrum AV mode if bandwidth Setting : 1GHz- 26GHz, RBW= 1MHz, VBW= 10Hz, Sweep time= 200 ms.

Radiated Spurious Emission Measurement Result (above 1GHz)

(Worst case: Band 4, 802.11a mode)

Operation Mode	TX MODE	Test Date	2018/12/04
Channel Number	CH Low	Test By	Barry
Temperature	25	Humidity	60 %

No	Freq MHz	Reading dBuV	Factor dB	Level dBuV/m	Limit dBuV/m	Margin dB	Remark	Pol V/H
1	2778.00	52.81	-15.13	37.68	74.00	-36.32	Peak	VERTICAL
2	4535.00	49.68	-10.19	39.49	74.00	-34.51	Peak	VERTICAL
3	11490.00	36.35	6.72	43.07	74.00	-30.93	Peak	VERTICAL
4	17235.00	38.00	11.66	49.66	68.20	-18.54	Peak	VERTICAL
1	2771.00	51.59	-15.15	36.44	74.00	-37.56	Peak	HORIZONTAL
2	4073.00	50.95	-11.74	39.21	74.00	-34.79	Peak	HORIZONTAL
3	11490.00	35.54	6.72	42.26	74.00	-31.74	Peak	HORIZONTAL
4	17235.00	33.77	11.66	45.43	68.20	-22.77	Peak	HORIZONTAL

Remark:

- 1 Field strength limits for frequency above 1000MHz are based on average limits. However, Peak mode field strength shall not exceed the average limits specified plus 20dB.
- 2 Measurement of data within this frequency range shown “ - ” in the table above means the reading of emissions are attenuated more than 20dB below the permissible limits or the field strength is too small to be measured.
- 3 Spectrum Peak mode IF bandwidth Setting : 1GHz- 26GHz, RBW= 1MHz, Sweep time= 200 ms., the VBW setting was 3 MHz.
- 4 Spectrum AV mode if bandwidth Setting : 1GHz- 26GHz, RBW= 1MHz, VBW= 10Hz, Sweep time= 200 ms.

Radiated Spurious Emission Measurement Result (above 1GHz)

Operation Mode	TX MODE	Test Date	2018/12/04
Channel Number	CH Mid	Test By	Barry
Temperature	25	Humidity	60 %

No	Freq MHz	Reading dBuV	Factor dB	Level dBuV/m	Limit dBuV/m	Margin dB	Remark	Pol V/H
1	2764.00	53.09	-15.15	37.94	74.00	-36.06	Peak	VERTICAL
2	4549.00	51.73	-10.15	41.58	74.00	-32.42	Peak	VERTICAL
3	11570.00	36.01	6.74	42.75	74.00	-31.25	Peak	VERTICAL
4	17355.00	37.83	12.73	50.56	68.20	-17.64	Peak	VERTICAL
1	3093.00	51.07	-14.34	36.73	68.20	-31.47	Peak	HORIZONTAL
2	3723.00	51.98	-13.01	38.97	74.00	-35.03	Peak	HORIZONTAL
3	11570.00	36.21	6.74	42.95	74.00	-31.05	Peak	HORIZONTAL
4	17355.00	35.47	12.73	48.20	68.20	-20.00	Peak	HORIZONTAL

Remark:

- 1 Field strength limits for frequency above 1000MHz are based on average limits. However, Peak mode field strength shall not exceed the average limits specified plus 20dB.
- 2 Measurement of data within this frequency range shown “ - ” in the table above means the reading of emissions are attenuated more than 20dB below the permissible limits or the field strength is too small to be measured.
- 3 Spectrum Peak mode IF bandwidth Setting : 1GHz- 26GHz, RBW= 1MHz, Sweep time= 200 ms., the VBW setting was 3 MHz.
- 4 Spectrum AV mode if bandwidth Setting : 1GHz- 26GHz, RBW= 1MHz, VBW= 10Hz, Sweep time= 200 ms.

Radiated Spurious Emission Measurement Result (above 1GHz)

Operation Mode	TX MODE	Test Date	2018/12/04
Channel Number	CH High	Test By	Barry
Temperature	25	Humidity	60 %

No	Freq MHz	Reading dBuV	Factor dB	Level dBuV/m	Limit dBuV/m	Margin dB	Remark	Pol V/H
1	1980.00	53.38	-17.87	35.51	68.20	-32.69	Peak	VERTICAL
2	4724.00	50.42	-9.51	40.91	74.00	-33.09	Peak	VERTICAL
3	11650.00	35.86	6.75	42.61	74.00	-31.39	Peak	VERTICAL
4	17475.00	37.82	13.81	51.63	68.20	-16.57	Peak	VERTICAL
1	3254.00	51.63	-14.52	37.11	68.20	-31.09	Peak	HORIZONTAL
2	4801.00	49.27	-9.28	39.99	74.00	-34.01	Peak	HORIZONTAL
3	11650.00	37.08	6.75	43.83	74.00	-30.17	Peak	HORIZONTAL
4	17475.00	34.80	13.81	48.61	68.20	-19.59	Peak	HORIZONTAL

Remark:

- 1 Field strength limits for frequency above 1000MHz are based on average limits. However, Peak mode field strength shall not exceed the average limits specified plus 20dB.
- 2 Measurement of data within this frequency range shown “ - ” in the table above means the reading of emissions are attenuated more than 20dB below the permissible limits or the field strength is too small to be measured.
- 3 Spectrum Peak mode IF bandwidth Setting : 1GHz- 26GHz, RBW= 1MHz, Sweep time= 200 ms., the VBW setting was 3 MHz.
- 4 Spectrum AV mode if bandwidth Setting : 1GHz- 26GHz, RBW= 1MHz, VBW= 10Hz, Sweep time= 200 ms.

Radiated Spurious Emission Measurement Result (above 1GHz)

(Band 4, 802.11 HT40 mode)

Operation Mode	TX MODE	Test Date	2018/12/04
Channel Number	CH Low	Test By	Barry
Temperature	25	Humidity	60 %

No	Freq MHz	Reading dBuV	Factor dB	Level dBuV/m	Limit dBuV/m	Margin dB	Remark	Pol V/H
1	3611.00	52.22	-13.28	38.94	74.00	-35.06	Peak	VERTICAL
2	4899.00	49.87	-9.02	40.85	74.00	-33.15	Peak	VERTICAL
3	11570.00	36.70	6.74	43.44	74.00	-30.56	Peak	VERTICAL
4	17355.00	37.78	12.73	50.51	68.20	-17.69	Peak	VERTICAL
1	2330.00	51.71	-15.65	36.06	74.00	-37.94	Peak	HORIZONTAL
2	4150.00	50.89	-11.49	39.40	74.00	-34.60	Peak	HORIZONTAL
3	11570.00	34.30	6.74	41.04	74.00	-32.96	Peak	HORIZONTAL
4	17355.00	37.80	12.73	50.53	68.20	-17.67	Peak	HORIZONTAL

Remark:

- 1 Field strength limits for frequency above 1000MHz are based on average limits. However, Peak mode field strength shall not exceed the average limits specified plus 20dB.
- 2 Measurement of data within this frequency range shown “ - ” in the table above means the reading of emissions are attenuated more than 20dB below the permissible limits or the field strength is too small to be measured.
- 3 Spectrum Peak mode IF bandwidth Setting : 1GHz- 26GHz, RBW= 1MHz, Sweep time= 200 ms., the VBW setting was 3 MHz.
- 4 Spectrum AV mode if bandwidth Setting : 1GHz- 26GHz, RBW= 1MHz, VBW= 10Hz, Sweep time= 200 ms.

Radiated Spurious Emission Measurement Result (above 1GHz)

Operation Mode	TX MODE	Test Date	2018/12/04
Channel Number	CH Mid	Test By	Barry
Temperature	25	Humidity	60 %

No	Freq MHz	Reading dBuV	Factor dB	Level dBuV/m	Limit dBuV/m	Margin dB	Remark	Pol V/H
1	3107.00	51.15	-14.32	36.83	68.20	-31.37	Peak	VERTICAL
2	4864.00	50.30	-9.11	41.19	74.00	-32.81	Peak	VERTICAL
3	11650.00	36.56	6.75	43.31	74.00	-30.69	Peak	VERTICAL
4	17475.00	37.30	13.81	51.11	68.20	-17.09	Peak	VERTICAL
1	2764.00	51.03	-15.15	35.88	74.00	-38.12	Peak	HORIZONTAL
2	4031.00	51.20	-11.86	39.34	74.00	-34.66	Peak	HORIZONTAL
3	11650.00	35.48	6.75	42.23	74.00	-31.77	Peak	HORIZONTAL
4	17475.00	34.69	13.81	48.50	68.20	-19.70	Peak	HORIZONTAL

Remark:

- 1 Field strength limits for frequency above 1000MHz are based on average limits. However, Peak mode field strength shall not exceed the average limits specified plus 20dB.
- 2 Measurement of data within this frequency range shown “ - ” in the table above means the reading of emissions are attenuated more than 20dB below the permissible limits or the field strength is too small to be measured.
- 3 Spectrum Peak mode IF bandwidth Setting : 1GHz- 26GHz, RBW= 1MHz, Sweep time= 200 ms., the VBW setting was 3 MHz.
- 4 Spectrum AV mode if bandwidth Setting : 1GHz- 26GHz, RBW= 1MHz, VBW= 10Hz, Sweep time= 200 ms.

Radiated Spurious Emission Measurement Result (above 1GHz)

Operation Mode	TX MODE	Test Date	2018/12/04
Channel Number	CH High	Test By	Barry
Temperature	25	Humidity	60 %

No	Freq MHz	Reading dBuV	Factor dB	Level dBuV/m	Limit dBuV/m	Margin dB	Remark	Pol V/H
1	1182.00	56.13	-19.93	36.20	74.00	-37.80	Peak	VERTICAL
2	2778.00	52.28	-15.13	37.15	74.00	-36.85	Peak	VERTICAL
3	11510.00	37.85	6.73	44.58	74.00	-29.42	Peak	VERTICAL
4	17265.00	37.06	11.93	48.99	68.20	-19.21	Peak	VERTICAL
1	3338.00	52.49	-14.57	37.92	74.00	-36.08	Peak	HORIZONTAL
2	3639.00	51.46	-13.21	38.25	74.00	-35.75	Peak	HORIZONTAL
3	11510.00	35.82	6.73	42.55	74.00	-31.45	Peak	HORIZONTAL
4	17265.00	38.57	11.93	50.50	68.20	-17.70	Peak	HORIZONTAL

Remark:

- 1 Field strength limits for frequency above 1000MHz are based on average limits. However, Peak mode field strength shall not exceed the average limits specified plus 20dB.
- 2 Measurement of data within this frequency range shown “ - ” in the table above means the reading of emissions are attenuated more than 20dB below the permissible limits or the field strength is too small to be measured.
- 3 Spectrum Peak mode IF bandwidth Setting : 1GHz- 26GHz, RBW= 1MHz, Sweep time= 200 ms., the VBW setting was 3 MHz.
- 4 Spectrum AV mode if bandwidth Setting : 1GHz- 26GHz, RBW= 1MHz, VBW= 10Hz, Sweep time= 200 ms.

**Radiated Spurious Emission Measurement Result (above 1GHz)
(Band 4, 802.11 ac80 mode)**

Operation Mode	TX MODE	Test Date	2018/12/04
Channel Number	CH Low	Test By	Barry
Temperature	25	Humidity	60 %

No	Freq MHz	Reading dBuV	Factor dB	Level dBuV/m	Limit dBuV/m	Margin dB	Remark	Pol V/H
1	2939.00	51.25	-14.78	36.47	68.20	-31.73	Peak	VERTICAL
2	6558.00	49.65	-3.93	45.72	68.20	-22.48	Peak	VERTICAL
3	11590.00	36.50	6.74	43.24	74.00	-30.76	Peak	VERTICAL
4	17385.00	35.43	13.00	48.43	68.20	-19.77	Peak	VERTICAL
1	2568.00	52.80	-15.53	37.27	68.20	-30.93	Peak	HORIZONTAL
2	4507.00	50.01	-10.28	39.73	74.00	-34.27	Peak	HORIZONTAL
3	11590.00	36.08	6.74	42.82	74.00	-31.18	Peak	HORIZONTAL
4	17385.00	35.33	13.00	48.33	68.20	-19.77	Peak	HORIZONTAL

Remark:

- 1 Field strength limits for frequency above 1000MHz are based on average limits. However, Peak mode field strength shall not exceed the average limits specified plus 20dB.
- 2 Measurement of data within this frequency range shown “ - ” in the table above means the reading of emissions are attenuated more than 20dB below the permissible limits or the field strength is too small to be measured.
- 3 Spectrum Peak mode IF bandwidth Setting : 1GHz- 26GHz, RBW= 1MHz, Sweep time= 200 ms., the VBW setting was 3 MHz.
- 4 Spectrum AV mode if bandwidth Setting : 1GHz- 26GHz, RBW= 1MHz, VBW= 10Hz, Sweep time= 200 ms.

Band Edges test (Band 1-2, 802.11a mode) -Radiated

Operation Mode	TX CH Low	Test Date	2018/12/04
Channel Number	5180 MHz	Test By	Barry
Temperature	25	Humidity	65 %

No	Freq MHz	Reading dBuV	Factor dB	Level dBuV/m	Limit dBuV/m	Margin dB	Remark	Pol V/H
1	5150.00	51.60	-8.39	43.21	68.2	-24.99	Peak	VERTICAL
2	5174.10	101.52	-8.34	93.18	F	--	Peak	VERTICAL
1	5150.00	49.56	-8.39	41.17	68.2	-27.03	Peak	HORIZONTAL
2	5183.90	97.54	-8.32	89.22	F	--	Peak	HORIZONTAL

Operation Mode	TX CH High	Test Date	2018/12/04
Channel Number	5320MHz	Test By	Barry
Temperature	25	Humidity	65 %

No	Freq MHz	Reading dBuV	Factor dB	Level dBuV/m	Limit dBuV/m	Margin dB	Remark	Pol V/H
1	5321.25	102.13	-8.03	94.10	F	--	Peak	VERTICAL
2	5350.00	51.83	-7.98	43.85	68.2	-24.35	Peak	VERTICAL
1	5323.65	100.84	-8.02	92.82	F	--	Peak	HORIZONTAL
2	5350.00	49.32	-7.98	41.34	68.2	-26.86	Peak	HORIZONTAL

Remark:

- 1 Measuring frequencies from the lowest internal frequency to the 10th of fundamental frequency
- 2 Field strength limits for frequency above 1000MHz are based on average limits. However, Peak mode field strength shall not exceed the average limits specified plus 20dB.
- 3 Measurement of data within this frequency range shown “ - ” in the table above means the reading of emissions are attenuated more than 20dB below the permissible limits or the field strength is too small to be measured.
- 4 Spectrum Peak mode IF bandwidth Setting : 1GHz- 26GHz, RBW= 1MHz, Sweep time= 200 ms., the VBW setting was 3 MHz.
- 5 Spectrum AV mode if bandwidth Setting : 1GHz- 26GHz, RBW= 1MHz, VBW= 10Hz, Sweep time= 200 ms.

Band Edges test (Band 1-2, 802.11n HT20 mode) -Radiated

Operation Mode	TX CH Low	Test Date	2018/12/04
Channel Number	5180 MHz	Test By	Barry
Temperature	25	Humidity	65 %

No	Freq MHz	Reading dBuV	Factor dB	Level dBuV/m	Limit dBuV/m	Margin dB	Remark	Pol V/H
1	5150.00	51.53	-8.39	43.14	68.2	-25.06	Peak	VERTICAL
2	5185.30	101.60	-8.31	93.29	F	--	Peak	VERTICAL
1	5150.00	50.69	-8.39	42.30	68.2	-25.9	Peak	HORIZONTAL
2	5181.10	98.21	-8.32	89.89	F	--	Peak	HORIZONTAL

Operation Mode	TX CH High	Test Date	2018/12/04
Channel Number	5320MHz	Test By	Barry
Temperature	25	Humidity	65 %

No	Freq MHz	Reading dBuV	Factor dB	Level dBuV/m	Limit dBuV/m	Margin dB	Remark	Pol V/H
1	5323.65	101.17	-8.02	93.15	F	--	Peak	VERTICAL
2	5350.00	50.54	-7.98	42.56	68.2	-25.64	Peak	VERTICAL
1	5321.85	98.56	-8.02	90.54	F	--	Peak	HORIZONTAL
2	5350.00	50.51	-7.98	42.53	68.2	-25.67	Peak	HORIZONTAL

Remark:

- 1 Measuring frequencies from the lowest internal frequency to the 10th of fundamental frequency
- 2 Field strength limits for frequency above 1000MHz are based on average limits. However, Peak mode field strength shall not exceed the average limits specified plus 20dB.
- 3 Measurement of data within this frequency range shown “ - ” in the table above means the reading of emissions are attenuated more than 20dB below the permissible limits or the field strength is too small to be measured.
- 4 Spectrum Peak mode IF bandwidth Setting : 1GHz- 26GHz, RBW= 1MHz, Sweep time= 200 ms., the VBW setting was 3 MHz.
- 5 Spectrum AV mode if bandwidth Setting : 1GHz- 26GHz, RBW= 1MHz, VBW= 10Hz, Sweep time= 200 ms.

Band Edges test (Band 1-2, 802.11n HT40 mode) -Radiated

Operation Mode	TX CH Low	Test Date	2018/12/04
Channel Number	5190 MHz	Test By	Barry
Temperature	25	Humidity	65 %

No	Freq MHz	Reading dBuV	Factor dB	Level dBuV/m	Limit dBuV/m	Margin dB	Remark	Pol V/H
1	5150.00	54.56	-8.39	46.17	68.2	-22.03	Peak	VERTICAL
2	5185.15	97.60	-8.32	89.28	F	--	Peak	VERTICAL
1	5150.00	53.06	-8.39	44.67	68.2	-23.53	Peak	HORIZONTAL
2	5184.44	95.00	-8.32	86.68	F	--	Peak	HORIZONTAL

Operation Mode	TX CH High	Test Date	2018/12/04
Channel Number	5310MHz	Test By	Barry
Temperature	25	Humidity	65 %

No	Freq MHz	Reading dBuV	Factor dB	Level dBuV/m	Limit dBuV/m	Margin dB	Remark	Pol V/H
1	5302.41	97.91	-8.07	89.84	F	--	Peak	VERTICAL
2	5350.00	53.65	-7.98	45.67	68.2	-22.53	Peak	VERTICAL
1	5312.44	96.48	-8.05	88.43	F	--	Peak	HORIZONTAL
2	5350.00	50.02	-7.98	42.04	68.2	-26.16	Peak	HORIZONTAL

Remark:

- 1 Measuring frequencies from the lowest internal frequency to the 10th of fundamental frequency
- 2 Field strength limits for frequency above 1000MHz are based on average limits. However, Peak mode field strength shall not exceed the average limits specified plus 20dB.
- 3 Measurement of data within this frequency range shown “ - ” in the table above means the reading of emissions are attenuated more than 20dB below the permissible limits or the field strength is too small to be measured.
- 4 Spectrum Peak mode IF bandwidth Setting : 1GHz- 26GHz, RBW= 1MHz, Sweep time= 200 ms., the VBW setting was 3 MHz.
- 5 Spectrum AV mode if bandwidth Setting : 1GHz- 26GHz, RBW= 1MHz, VBW= 10Hz, Sweep time= 200 ms.

Band Edges test (Band 1-2, 802.11ac 80 mode) -Radiated

Operation Mode	TX CH Low	Test Date	2018/12/04
Channel Number	5210 MHz	Test By	Barry
Temperature	25	Humidity	65 %

No	Freq MHz	Reading dBuV	Factor dB	Level dBuV/m	Limit dBuV/m	Margin dB	Remark	Pol V/H
1	5150.00	51.30	-8.39	42.91	48.2	-5.29	Average	VERTICAL
2	5150.00	62.78	-8.39	54.39	68.2	-13.81	Peak	VERTICAL
3	5212.50	100.72	-8.25	92.47	F	--	Peak	VERTICAL
1	5150.00	59.97	-8.39	51.58	68.2	-16.62	Peak	HORIZONTAL
2	5215.50	98.53	-8.25	90.28	F	--	Peak	HORIZONTAL

Operation Mode	TX CH High	Test Date	2018/12/04
Channel Number	5290MHz	Test By	Barry
Temperature	25	Humidity	65 %

No	Freq MHz	Reading dBuV	Factor dB	Level dBuV/m	Limit dBuV/m	Margin dB	Remark	Pol V/H
1	5293.47	101.74	-8.08	93.66	F	--	Peak	VERTICAL
2	5350.00	52.57	-7.98	44.59	48.2	-3.61	Average	VERTICAL
3	5350.00	61.99	-7.98	54.01	68.2	-14.19	Peak	VERTICAL
1	5280.03	99.85	-8.12	91.73	F	--	Peak	HORIZONTAL
2	5350.00	59.93	-7.98	51.95	68.2	-16.25	Peak	HORIZONTAL

Remark:

- 1 Measuring frequencies from the lowest internal frequency to the 10th of fundamental frequency
- 2 Field strength limits for frequency above 1000MHz are based on average limits. However, Peak mode field strength shall not exceed the average limits specified plus 20dB.
- 3 Measurement of data within this frequency range shown “ - ” in the table above means the reading of emissions are attenuated more than 20dB below the permissible limits or the field strength is too small to be measured.
- 4 Spectrum Peak mode IF bandwidth Setting : 1GHz- 26GHz, RBW= 1MHz, Sweep time= 200 ms., the VBW setting was 3 MHz.
- 5 Spectrum AV mode if bandwidth Setting : 1GHz- 26GHz, RBW= 1MHz, VBW= 10Hz, Sweep time= 200 ms.

Band Edges test (Band 3, 802.11a mode) -Radiated

Operation Mode	TX CH Low	Test Date	2018/12/04
Channel Number	5500 MHz	Test By	Barry
Temperature	25	Humidity	65 %

No	Freq MHz	Reading dBuV	Factor dB	Level dBuV/m	Limit dBuV/m	Margin dB	Remark	Pol V/H
1	5470.00	50.43	-7.65	42.78	68.2	-25.42	Peak	VERTICAL
2	5493.83	101.35	-7.58	93.77	F	--	Peak	VERTICAL
1	5470.00	49.24	-7.65	41.59	68.9	-27.31	Peak	HORIZONTAL
2	5492.51	96.49	-7.59	88.90	F	--	Peak	HORIZONTAL

Operation Mode	TX CH High	Test Date	2018/12/04
Channel Number	5700MHz	Test By	Barry
Temperature	25	Humidity	65 %

No	Freq MHz	Reading dBuV	Factor dB	Level dBuV/m	Limit dBuV/m	Margin dB	Remark	Pol V/H
1	5693.68	98.51	-6.92	91.59	F	--	Peak	VERTICAL
2	5725.00	51.91	-6.82	45.09	68.2	-23.11	Peak	VERTICAL
1	5698.64	94.38	-6.90	87.48	F	--	Peak	HORIZONTAL
2	5725.00	49.01	-6.82	42.19	68.2	-26.01	Peak	HORIZONTAL

Remark:

- 1 Measuring frequencies from the lowest internal frequency to the 10th of fundamental frequency
- 2 Field strength limits for frequency above 1000MHz are based on average limits. However, Peak mode field strength shall not exceed the average limits specified plus 20dB.
- 3 Measurement of data within this frequency range shown “ - ” in the table above means the reading of emissions are attenuated more than 20dB below the permissible limits or the field strength is too small to be measured.
- 4 Spectrum Peak mode IF bandwidth Setting : 1GHz- 26GHz, RBW= 1MHz, Sweep time= 200 ms., the VBW setting was 3 MHz.
- 5 Spectrum AV mode if bandwidth Setting : 1GHz- 26GHz, RBW= 1MHz, VBW= 10Hz, Sweep time= 200 ms.

Band Edges test (Band 3, 802.11n HT20 mode) -Radiated

Operation Mode	TX CH Low	Test Date	2018/12/04
Channel Number	5500 MHz	Test By	Barry
Temperature	25	Humidity	65 %

No	Freq MHz	Reading dBuV	Factor dB	Level dBuV/m	Limit dBuV/m	Margin dB	Remark	Pol V/H
1	5470.00	50.31	-7.65	42.66	68.2	-25.54	Peak	VERTICAL
2	5502.52	101.09	-7.56	93.53	F	--	Peak	VERTICAL
1	5470.00	49.23	-7.65	41.58	68.2	-26.62	Peak	HORIZONTAL
2	5493.83	96.81	-7.58	89.23	F	--	Peak	HORIZONTAL

Operation Mode	TX CH High	Test Date	2018/12/04
Channel Number	5700MHz	Test By	Barry
Temperature	25	Humidity	65 %

No	Freq MHz	Reading dBuV	Factor dB	Level dBuV/m	Limit dBuV/m	Margin dB	Remark	Pol V/H
1	5694.96	98.40	-6.91	91.49	F	--	Peak	VERTICAL
2	5725.00	52.24	-6.82	45.42	68.2	-22.78	Peak	VERTICAL
1	5707.44	95.49	-6.87	88.62	F	--	Peak	HORIZONTAL
2	5725.00	48.65	-6.82	41.83	68.2	-26.37	Peak	HORIZONTAL

Remark:

- 1 Measuring frequencies from the lowest internal frequency to the 10th of fundamental frequency
- 2 Field strength limits for frequency above 1000MHz are based on average limits. However, Peak mode field strength shall not exceed the average limits specified plus 20dB.
- 3 Measurement of data within this frequency range shown “ - ” in the table above means the reading of emissions are attenuated more than 20dB below the permissible limits or the field strength is too small to be measured.
- 4 Spectrum Peak mode IF bandwidth Setting : 1GHz- 26GHz, RBW= 1MHz, Sweep time= 200 ms., the VBW setting was 3 MHz.
- 5 Spectrum AV mode if bandwidth Setting : 1GHz- 26GHz, RBW= 1MHz, VBW= 10Hz, Sweep time= 200 ms.

Band Edges test (Band 3, 802.11n HT40 mode) -Radiated

Operation Mode	TX CH Low	Test Date	2018/12/04
Channel Number	5510 MHz	Test By	Barry
Temperature	25	Humidity	65 %

No	Freq MHz	Reading dBuV	Factor dB	Level dBuV/m	Limit dBuV/m	Margin dB	Remark	Pol V/H
1	5470.00	56.09	-7.65	48.44	68.2	-19.76	Peak	VERTICAL
2	5521.29	97.66	-7.49	90.17	F	--	Peak	VERTICAL
1	5470.00	51.78	-7.65	44.13	68.2	-19.76	Peak	HORIZONTAL
2	5505.04	93.23	-7.55	85.68	F	--	Peak	HORIZONTAL

Operation Mode	TX CH High	Test Date	2018/12/04
Channel Number	5670MHz	Test By	Barry
Temperature	25	Humidity	65 %

No	Freq MHz	Reading dBuV	Factor dB	Level dBuV/m	Limit dBuV/m	Margin dB	Remark	Pol V/H
1	5666.20	96.14	-7.01	89.13	F	--	Peak	VERTICAL
2	5725.00	48.50	-6.82	41.68	68.2	-26.52	Peak	VERTICAL
1	5652.40	90.79	-7.06	83.73	F	--	Peak	HORIZONTAL
2	5725.00	48.96	-6.82	42.14	68.2	-26.52	Peak	HORIZONTAL

Remark:

- 1 Measuring frequencies from the lowest internal frequency to the 10th of fundamental frequency
- 2 Field strength limits for frequency above 1000MHz are based on average limits. However, Peak mode field strength shall not exceed the average limits specified plus 20dB.
- 3 Measurement of data within this frequency range shown “ - ” in the table above means the reading of emissions are attenuated more than 20dB below the permissible limits or the field strength is too small to be measured.
- 4 Spectrum Peak mode IF bandwidth Setting : 1GHz- 26GHz, RBW= 1MHz, Sweep time= 200 ms., the VBW setting was 3 MHz.
- 5 Spectrum AV mode if bandwidth Setting : 1GHz- 26GHz, RBW= 1MHz, VBW= 10Hz, Sweep time= 200 ms.

Band Edges test (Band 3, 802.11ac 80 mode) -Radiated

Operation Mode	TX CH Low	Test Date	2018/12/04
Channel Number	5530 MHz	Test By	Barry
Temperature	25	Humidity	65 %

No	Freq MHz	Reading dBuV	Factor dB	Level dBuV/m	Limit dBuV/m	Margin dB	Remark	Pol V/H
1	5470.00	53.42	-7.65	45.77	68.2	-26.52	Average	VERTICAL
2	5470.00	64.02	-7.65	56.37	68.2	-26.52	Peak	VERTICAL
3	5536.68	102.35	-7.44	94.91	F	--	Peak	VERTICAL
1	5470.00	53.67	-7.65	46.02	48.2	-2.18	Average	HORIZONTAL
2	5470.00	63.54	-7.65	55.89	68.2	-12.31	Peak	HORIZONTAL
3	5519.00	98.68	-7.50	91.18	F	--	Peak	HORIZONTAL

Operation Mode	TX CH High	Test Date	2018/12/04
Channel Number	5610MHz	Test By	Barry
Temperature	25	Humidity	65 %

No	Freq MHz	Reading dBuV	Factor dB	Level dBuV/m	Limit dBuV/m	Margin dB	Remark	Pol V/H
1	5613.68	104.57	-7.20	97.37	F	--	Peak	VERTICAL
2	5725.00	56.77	-6.82	49.95	68.2	-18.25	Peak	VERTICAL
1	5612.84	100.38	-7.21	93.17	F	--	Peak	HORIZONTAL
2	5725.00	57.60	-6.82	50.78	68.2	-17.42	Peak	HORIZONTAL

Remark:

- 1 Measuring frequencies from the lowest internal frequency to the 10th of fundamental frequency
- 2 Field strength limits for frequency above 1000MHz are based on average limits. However, Peak mode field strength shall not exceed the average limits specified plus 20dB.
- 3 Measurement of data within this frequency range shown “ - ” in the table above means the reading of emissions are attenuated more than 20dB below the permissible limits or the field strength is too small to be measured.
- 4 Spectrum Peak mode IF bandwidth Setting : 1GHz- 26GHz, RBW= 1MHz, Sweep time= 200 ms., the VBW setting was 3 MHz.
- 5 Spectrum AV mode if bandwidth Setting : 1GHz- 26GHz, RBW= 1MHz, VBW= 10Hz, Sweep time= 200 ms.

Band Edges test (Band 4, 802.11a mode) –Radiated

Operation Mode TX CH Low
 Channel Number 5745 MHz
 Temperature 25

Test Date 2018/11/23
 Test By Barry
 Humidity 65 %

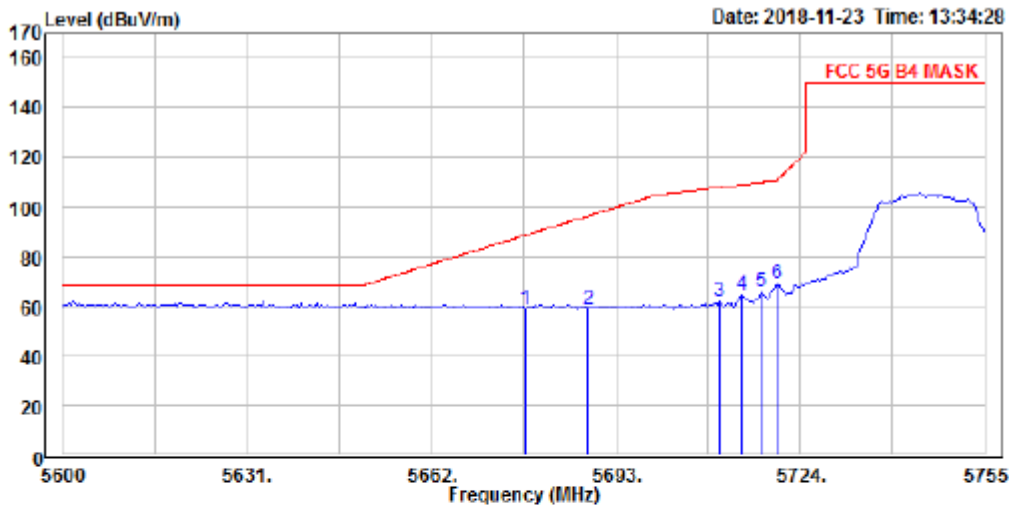

Condition: FCC 5G B4 MASK 3m Vertical
 : RBW:1000kHz VBW:1000kHz SWT:Auto DET:Positive
 EUT : 5G a mode mask low ch
 Mode :
 Note :

	Read		Limit	Over		
Freq	Level	Factor	Level	Line	Limit	Pol/Phase
MHz	dBuV	dB/m	dBuV/m	dBuV/m	dB	
1 PP 5677.810	59.14	0.00	59.14	88.82	-29.68	Vertical
2 5688.350	58.99	0.00	58.99	96.61	-37.62	Vertical
3 5710.360	62.11	0.00	62.11	108.10	-45.99	Vertical
4 5714.080	64.81	0.00	64.81	109.14	-44.33	Vertical
5 5717.490	65.77	0.00	65.77	110.10	-44.33	Vertical
6 5719.970	69.20	0.00	69.20	110.79	-41.59	Vertical

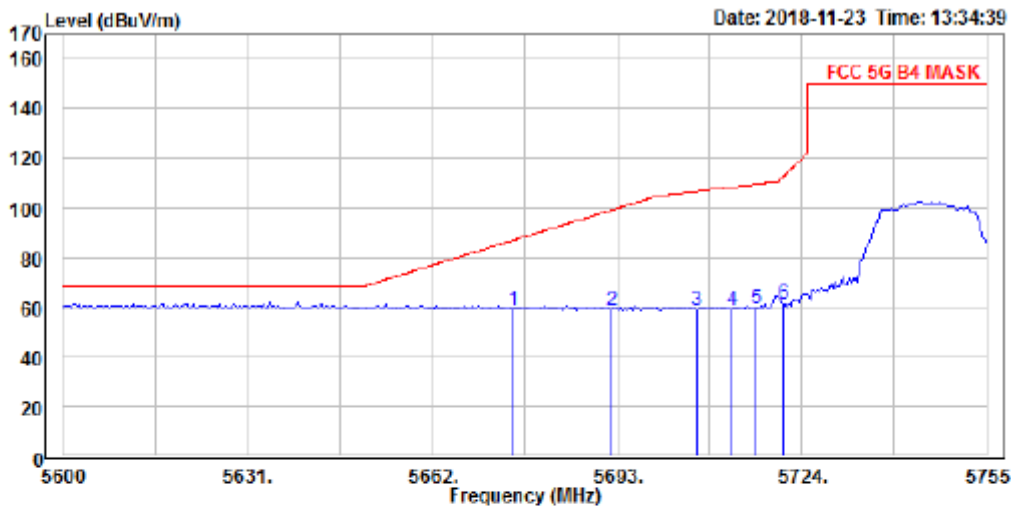

Condition: FCC 5G B4 MASK 3m Horizontal
 : RBW:1000kHz VBW:1000kHz SWT:Auto DET:Positive
 EUT : 5G a mode mask low ch
 Mode :
 Note :

	Read		Limit	Over		
Freq	Level	Factor	Level	Line	Limit	Pol/Phase
MHz	dBuV	dB/m	dBuV/m	dBuV/m	dB	
1 PP 5675.640	59.10	0.00	59.10	87.21	-28.11	Horizontal
2 5692.070	58.96	0.00	58.96	99.35	-40.39	Horizontal
3 5706.330	58.96	0.00	58.96	106.97	-48.01	Horizontal
4 5712.220	59.13	0.00	59.13	108.62	-49.49	Horizontal
5 5716.250	59.35	0.00	59.35	109.75	-50.40	Horizontal
6 5720.900	61.13	0.00	61.13	112.85	-51.72	Horizontal

Operation Mode TX CH High
 Channel Number 5825MHz
 Temperature 25

Test Date 2018/11/23
 Test By Barry
 Humidity 65 %

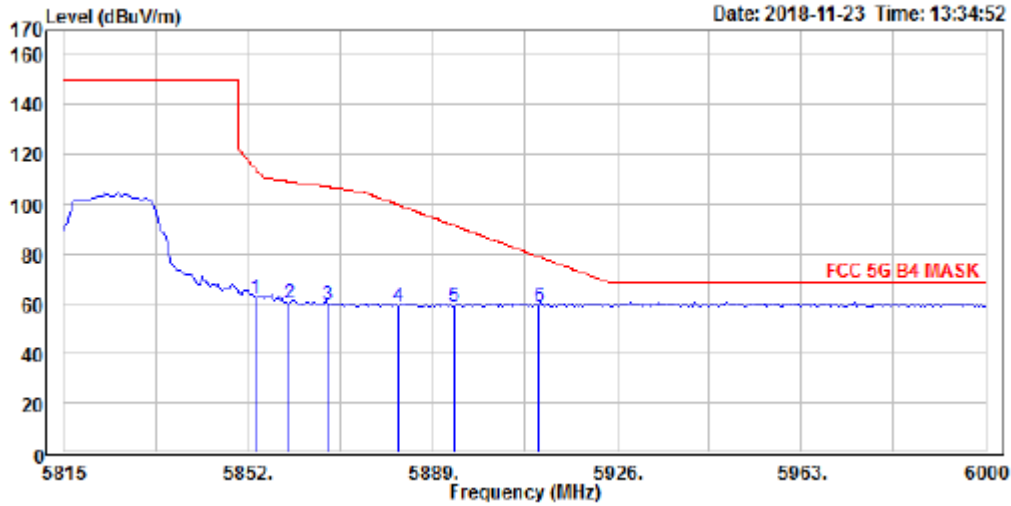

Condition: FCC 5G B4 MASK 3m Vertical
 : RBW:1000kHz VBW:1000kHz SWT:Auto DET:Positive
 EUT : 5G a mode mask high ch
 Mode :
 Note :

	Read Freq	Read Level	Factor	Level	Limit	Over	Pol/Phase
	MHz	dBuV	dB/m	dBuV/m	dBuV/m	dB	
1	5853.480	62.16	0.00	62.16	114.26	-52.10	Vertical
2	5860.140	60.08	0.00	60.08	109.36	-49.28	Vertical
3	5867.910	59.78	0.00	59.78	107.18	-47.40	Vertical
4	5881.970	59.00	0.00	59.00	100.02	-41.02	Vertical
5	5893.440	58.81	0.00	58.81	91.52	-32.71	Vertical
6 PP	5910.460	58.79	0.00	58.79	78.93	-20.14	Vertical

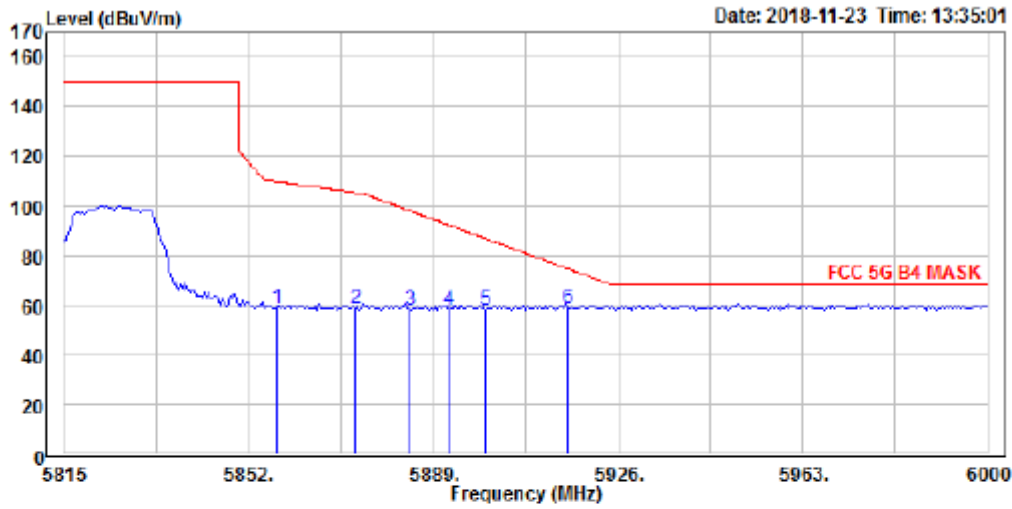

Condition: FCC 5G B4 MASK 3m Horizontal
 : RBW:1000kHz VBW:1000kHz SWT:Auto DET:Positive
 EUT : 5G a mode mask high ch
 Mode :
 Note :

	Read	Limit	Over			
Freq	Level	Factor	Level	Line	Limit	Pol/Phase
MHz	dBuV	dB/m	dBuV/m	dBuV/m	dB	
1	5857.550	58.90	0.00	58.90	110.08	-51.18 Horizontal
2	5873.460	58.67	0.00	58.67	105.63	-46.96 Horizontal
3	5884.190	58.31	0.00	58.31	98.38	-40.07 Horizontal
4	5891.960	58.17	0.00	58.17	92.61	-34.44 Horizontal
5	5899.360	58.44	0.00	58.44	87.13	-28.69 Horizontal
6 PP	5916.010	58.55	0.00	58.55	74.83	-16.28 Horizontal

Band Edges test (Band 4, 802.11n HT20 mode) –Radiated

Operation Mode TX CH Low
 Channel Number 5745 MHz
 Temperature 25

Test Date 2018/11/23
 Test By Barry
 Humidity 65 %

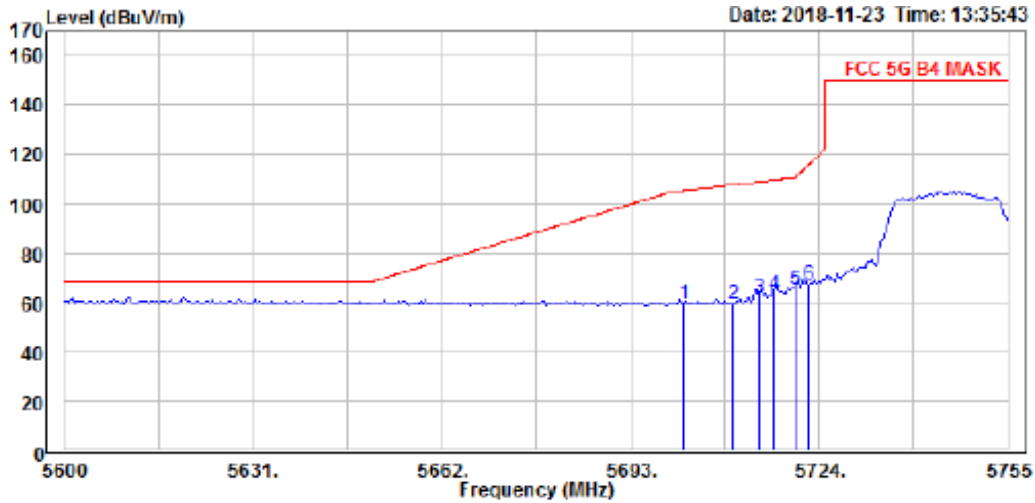

Condition: FCC 5G B4 MASK 3m Vertical
 : RBW:1000kHz VBW:1000kHz SWT:Auto DET:Positive
 EUT : 5G n20 mode mask low ch
 Mode :
 Note :

	Read		Limit	Over		
Freq	Level	Factor	Level	Line	Limit	Pol/Phase
MHz	dBuV	dB/m	dBuV/m	dBuV/m	dB	
1	5701.680	59.26	0.00	59.26	105.67	-46.41 Vertical
2	5709.740	59.35	0.00	59.35	107.93	-48.58 Vertical
3	5714.080	61.84	0.00	61.84	109.14	-47.30 Vertical
4	5716.560	63.40	0.00	63.40	109.84	-46.44 Vertical
5 PP	5719.970	65.11	0.00	65.11	110.79	-45.68 Vertical
6	5722.140	67.53	0.00	67.53	115.68	-48.15 Vertical

Operation Mode TX CH High
 Channel Number 5825 MHz
 Temperature 25

Test Date 2018/11/23
 Test By Barry
 Humidity 65 %

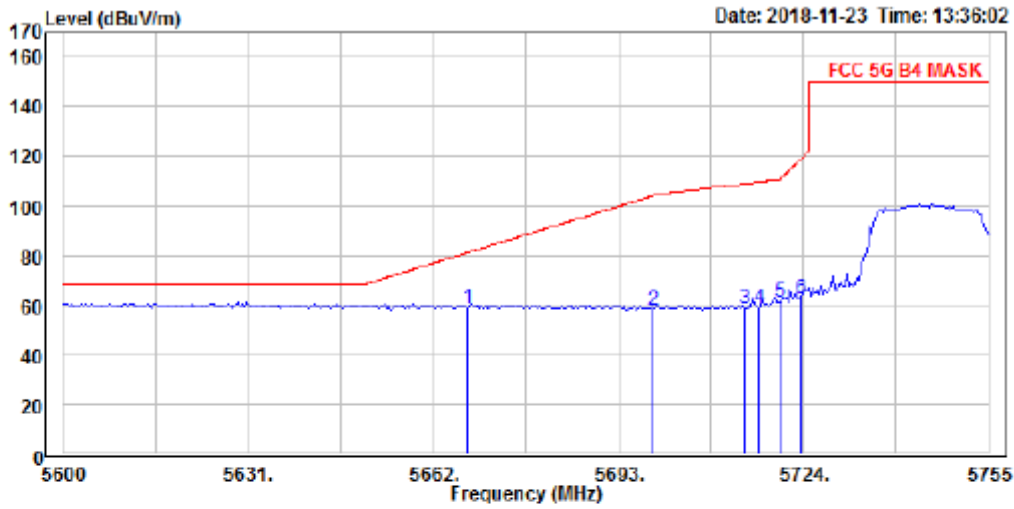

Condition: FCC 5G B4 MASK 3m Vertical
 : RBW:1000kHz VBW:1000kHz SWT:Auto DET:Positive
 EUT : 5G n20 mode mask low ch
 Mode :
 Note :

	Read		Limit	Over		
Freq	Level	Factor	Level	Line	Limit	Pol/Phase
MHz	dBuV	dB/m	dBuV/m	dBuV/m	dB	
1 PP 5667.890	59.02	0.00	59.02	81.48	-22.46	Vertical
2 5698.890	58.44	0.00	58.44	104.38	-45.94	Vertical
3 5714.080	58.55	0.00	58.55	109.14	-50.59	Vertical
4 5716.560	58.61	0.00	58.61	109.84	-51.23	Vertical
5 5719.970	61.16	0.00	61.16	110.79	-49.63	Vertical
6 5723.690	62.50	0.00	62.50	119.21	-56.71	Vertical

Operation Mode TX CH High
 Channel Number 5825MHz
 Temperature 25

Test Date 2018/11/23
 Test By Barry
 Humidity 65 %

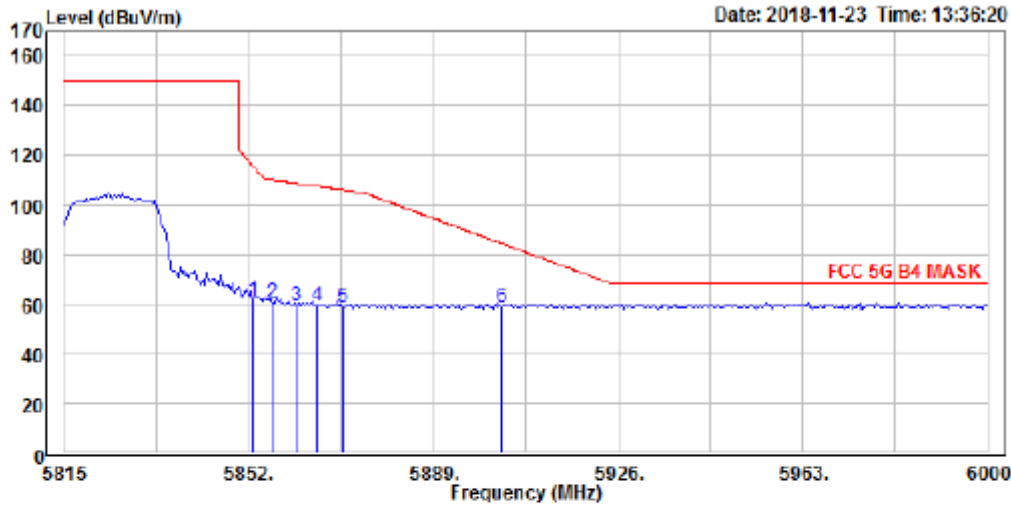

Condition: FCC 5G B4 MASK 3m Vertical
 : RBW:1000kHz VBW:1000kHz SWT:Auto DET:Positive
 EUT : 5G n20 mode mask high ch
 Mode :
 Note :

	Read Freq	Read Level	Read Factor	Limit Level	Limit Line	Over Limit	Pol/Phase
	MHz	dBuV	dB/m	dBuV/m	dBuV/m	dB	
1	5852.740	61.56	0.00	61.56	115.95	-54.39	Vertical
2	5856.810	60.85	0.00	60.85	110.29	-49.44	Vertical
3	5861.620	59.39	0.00	59.39	108.94	-49.55	Vertical
4	5865.690	59.72	0.00	59.72	107.80	-48.08	Vertical
5	5870.870	58.99	0.00	58.99	106.35	-47.36	Vertical
6 PP	5902.690	58.71	0.00	58.71	84.67	-25.96	Vertical

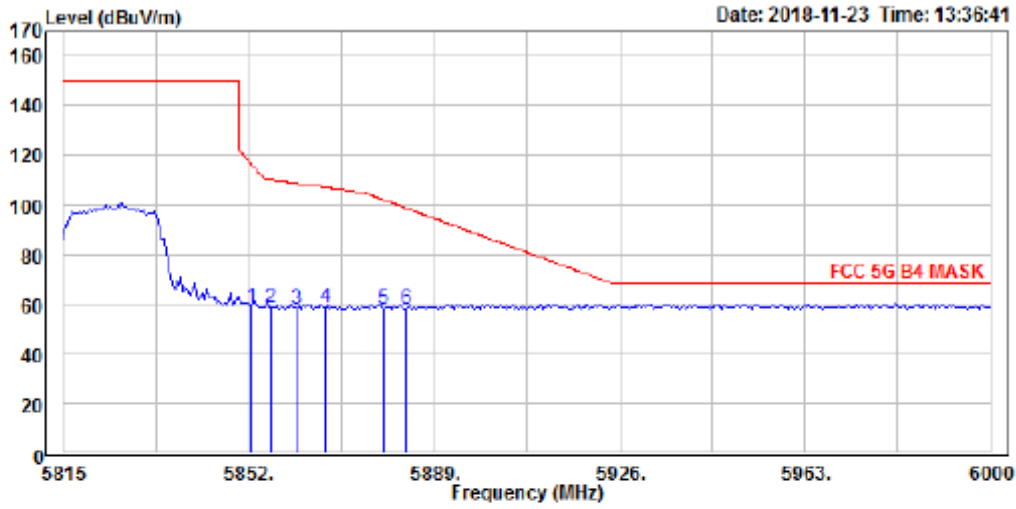

Condition: FCC 5G B4 MASK 3m Horizontal
 : RBW:1000kHz VBW:1000kHz SWT:Auto DET:Positive
 EUT : 5G n20 mode mask high ch
 Mode :
 Note :

	Read		Limit	Over		
Freq	Level	Factor	Level	Line	Limit	Pol/Phase
MHz	dBuV	dB/m	dBuV/m	dBuV/m	dB	
1	5852.370	59.14	0.00	59.14	116.79	-57.65 Horizontal
2	5856.440	58.60	0.00	58.60	110.40	-51.80 Horizontal
3	5861.620	58.33	0.00	58.33	108.94	-50.61 Horizontal
4	5867.170	58.54	0.00	58.54	107.39	-48.85 Horizontal
5	5879.010	58.12	0.00	58.12	102.22	-44.10 Horizontal
6 PP	5883.450	58.30	0.00	58.30	98.92	-40.62 Horizontal

Band Edges test (Band 4, 802.11n HT40 mode) –Radiated

Operation Mode TX CH Low
 Channel Number 5755 MHz
 Temperature 25

Test Date 2018/11/23
 Test By Barry
 Humidity 65 %

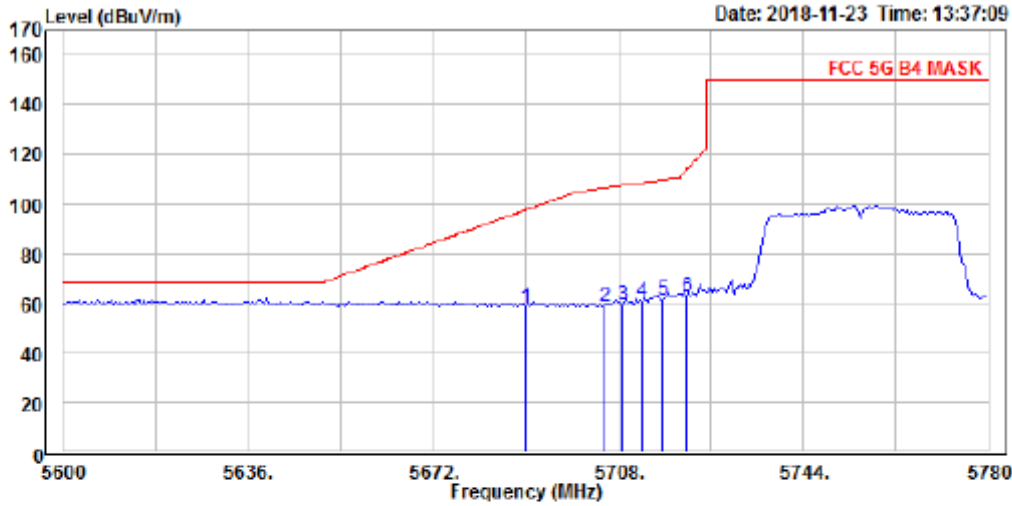

Condition: FCC 5G B4 MASK 3m Vertical
 : RBW:1000kHz VBW:1000kHz SWT:Auto DET:Positive
 EUT : 5G n40 mode mask low ch
 Mode :
 Note :

	Read		Limit	Over		
Freq	Level	Factor	Level	Line	Limit	Pol/Phase
MHz	dBuV	dB/m	dBuV/m	dBuV/m	dB	
1 PP 5690.000	58.45	0.00	58.45	97.83	-39.38	Vertical
2 5705.480	58.94	0.00	58.94	106.74	-47.80	Vertical
3 5708.720	59.43	0.00	59.43	107.64	-48.21	Vertical
4 5712.680	60.55	0.00	60.55	108.75	-48.20	Vertical
5 5716.640	61.47	0.00	61.47	109.86	-48.39	Vertical
6 5721.320	62.55	0.00	62.55	113.81	-51.26	Vertical

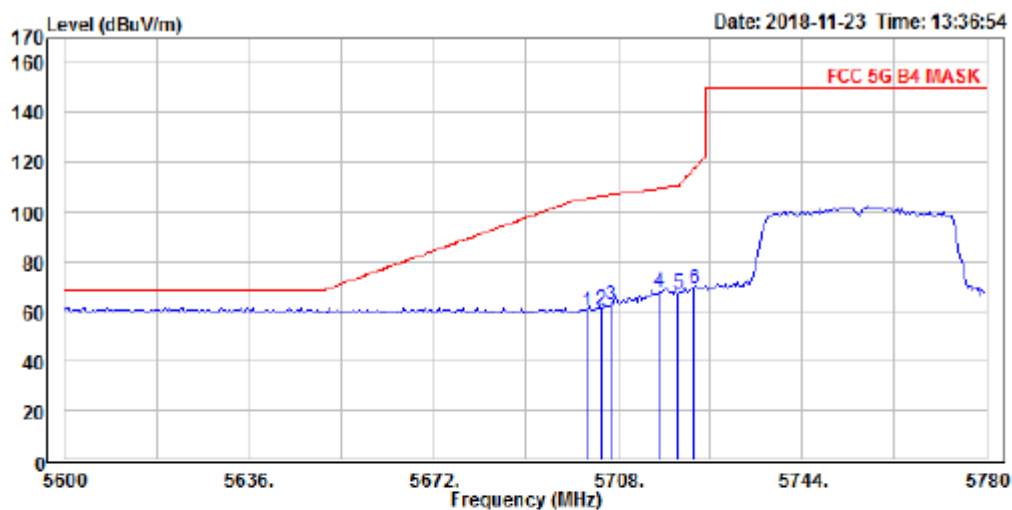

Condition: FCC 5G B4 MASK 3m Horizontal
 : RBW:1000kHz VBW:1000kHz SWT:Auto DET:Positive
 EUT : 5G n40 mode mask low ch
 Mode :
 Note :

		Read			Limit	Over	
	Freq	Level	Factor	Level	Line	Limit	Pol/Phase
	MHz	dBuV	dB/m	dBuV/m	dBuV/m	dB	
1	5701.880	60.38	0.00	60.38	105.73	-45.35	Horizontal
2	5704.760	60.99	0.00	60.99	106.53	-45.54	Horizontal
3	5706.560	62.92	0.00	62.92	107.04	-44.12	Horizontal
4	PP 5715.920	67.56	0.00	67.56	109.66	-42.10	Horizontal
5	5719.880	67.01	0.00	67.01	110.77	-43.76	Horizontal
6	5722.760	69.19	0.00	69.19	117.09	-47.90	Horizontal

Operation Mode TX CH High
 Channel Number 5795MHz
 Temperature 25

Test Date 2018/11/23
 Test By Barry
 Humidity 65 %

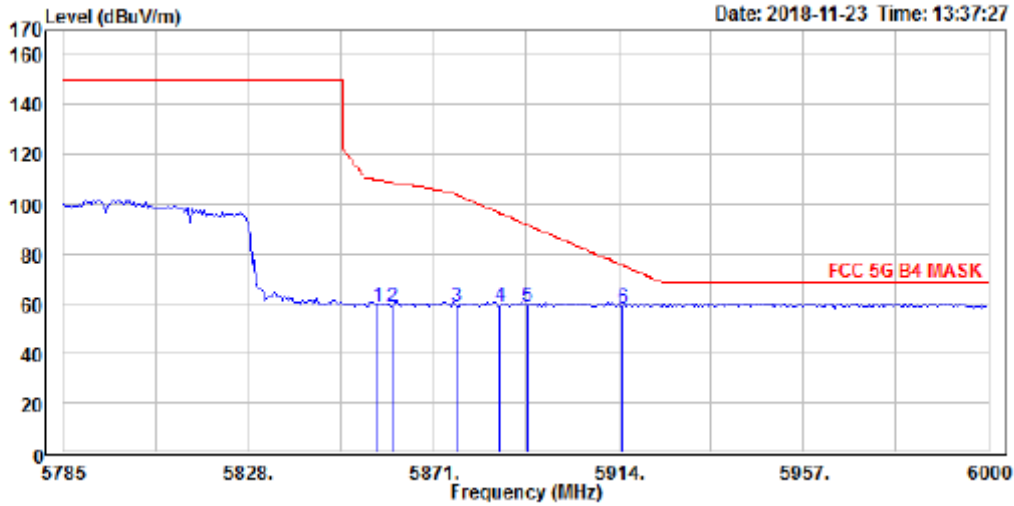

Condition: FCC 5G B4 MASK 3m Vertical
 : RBW:1000kHz VBW:1000kHz SWT:Auto DET:Positive
 EUT : 5G n40 mode mask high ch
 Mode :
 Note :

	Read Freq	Read Level	Read Factor	Limit Level	Limit Line	Over Limit	Pol/Phase
	MHz	dBuV	dB/m	dBuV/m	dBuV/m	dB	
1	5858.100	58.81	0.00	58.81	109.93	-51.12	Vertical
2	5861.540	58.65	0.00	58.65	108.97	-50.32	Vertical
3	5876.590	59.08	0.00	59.08	104.02	-44.94	Vertical
4	5886.480	58.92	0.00	58.92	96.68	-37.76	Vertical
5	5892.930	58.78	0.00	58.78	91.90	-33.12	Vertical
6 PP	5914.860	58.32	0.00	58.32	75.68	-17.36	Vertical

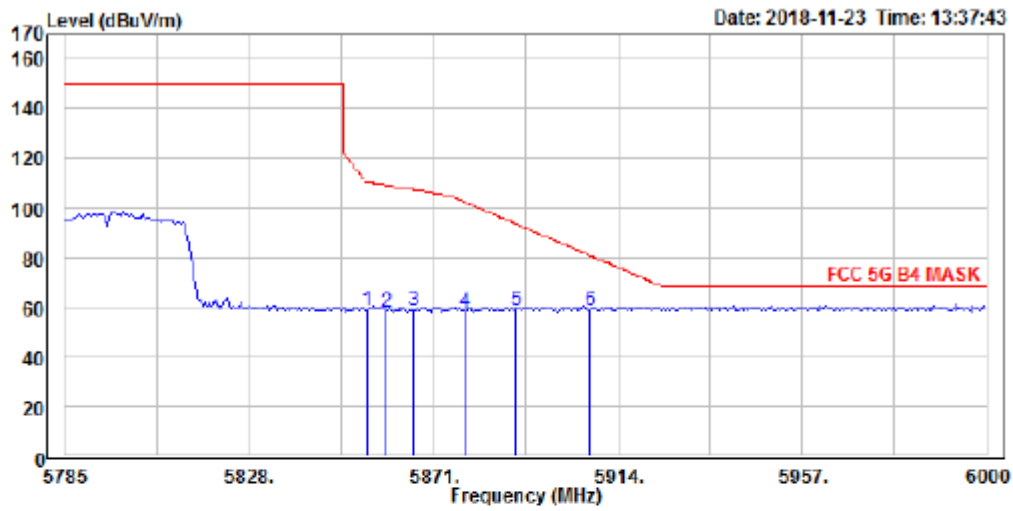

Condition: FCC 5G B4 MASK 3m Horizontal
 : RBW:1000kHz VBW:1000kHz SWT:Auto DET:Positive
 EUT : 5G n40 mode mask high ch
 Mode :
 Note :

	Read Freq	Level dBuV	Factor dB/m	Level dBuV/m	Limit Line dBuV/m	Over Limit dB	Pol/Phase
1	5855.520	58.91	0.00	58.91	110.65	-51.74	Horizontal
2	5859.820	58.35	0.00	58.35	109.45	-51.10	Horizontal
3	5866.270	58.62	0.00	58.62	107.64	-49.02	Horizontal
4	5878.310	58.40	0.00	58.40	102.74	-44.34	Horizontal
5	5890.350	58.87	0.00	58.87	93.81	-34.94	Horizontal
6 PP	5987.550	58.53	0.00	58.53	81.08	-22.55	Horizontal

Band Edges test (Band 4, 802.11ac HT80 mode) –Radiated

Operation Mode TX CH Low
 Channel Number 5775 MHz
 Temperature 25

Test Date 2018/12/08
 Test By Barry
 Humidity 65 %

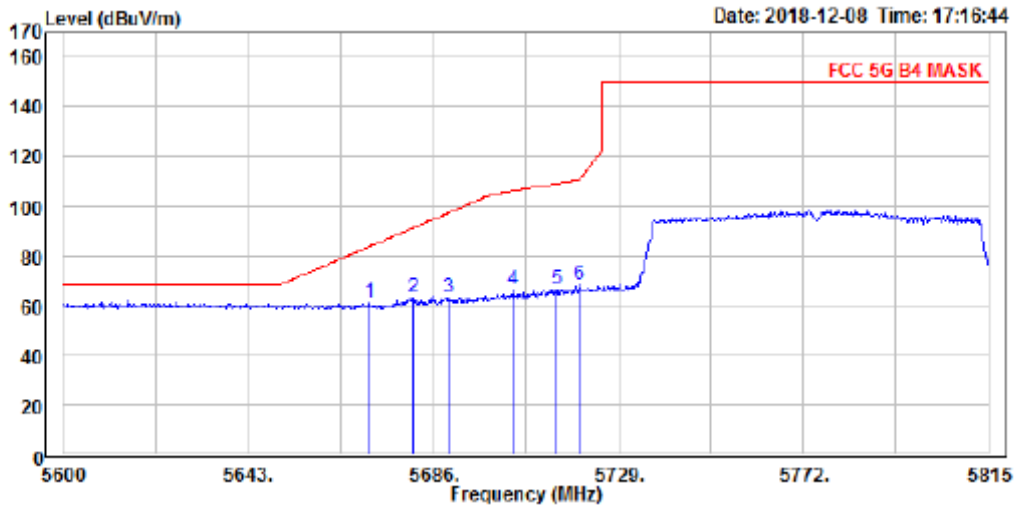

Condition: FCC 5G B4 MASK 3m Vertical
 : RBW:1000kHz VBW:1000kHz SWT:Auto DET:Positive
 EUT : 5G n80 mode mask high ch
 Mode :
 Note :

	Read		Limit	Over		
Freq	Level	Factor	Level	Line	Limit	Pol/Phase
MHz	dBuV	dB/m	dBuV/m	dBuV/m	dB	
1 PP 5671.165	61.38	0.00	61.38	83.90	-22.52	Vertical
2 5681.485	63.33	0.00	63.33	91.54	-28.21	Vertical
3 5689.440	63.29	0.00	63.29	97.41	-34.12	Vertical
4 5704.705	66.55	0.00	66.55	106.52	-39.97	Vertical
5 5714.595	66.76	0.00	66.76	109.29	-42.53	Vertical
6 5719.970	68.51	0.00	68.51	110.79	-42.28	Vertical

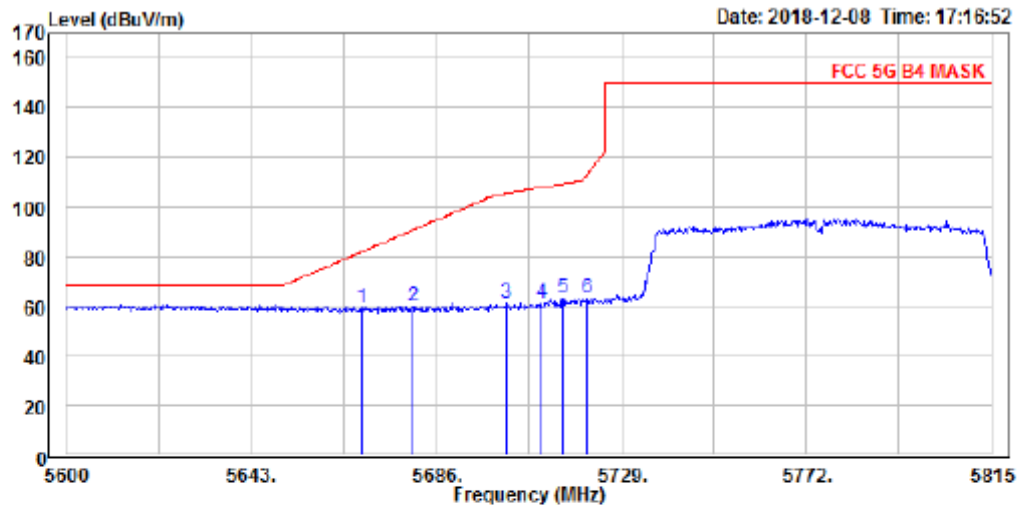

Condition: FCC 5G B4 MASK 3m Horizontal
 : RBW:1000kHz VBW:1000kHz SWT:Auto DET:Positive
 EUT : 5G n80 mode mask high ch
 Mode :
 Note :

	Read		Limit	Over		
Freq	Level	Factor	Level	Line	Limit	Pol/Phase
MHz	dBuV	dB/m	dBuV/m	dBuV/m	dB	
1 PP 5668.585	59.77	0.00	59.77	81.99	-22.22	Horizontal
2 5680.625	60.26	0.00	60.26	90.90	-30.64	Horizontal
3 5702.125	61.29	0.00	61.29	105.80	-44.51	Horizontal
4 5710.510	61.41	0.00	61.41	108.15	-46.74	Horizontal
5 5715.240	63.24	0.00	63.24	109.47	-46.23	Horizontal
6 5721.045	63.42	0.00	63.42	113.18	-49.76	Horizontal

Operation Mode TX CH High
 Channel Number 5775 MHz
 Temperature 25

Test Date 2018/12/08
 Test By Barry
 Humidity 65 %

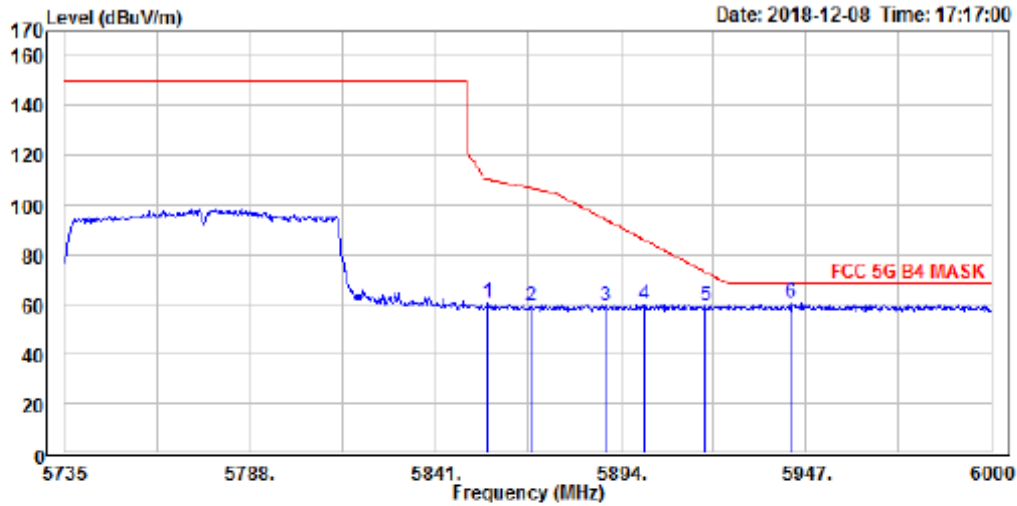

Condition: FCC 5G B4 MASK 3m Vertical
 : RBW:1000kHz VBW:1000kHz SWT:Auto DET:Positive
 EUT : 5G n80 mode mask high ch
 Mode :
 Note :

	Read Freq	Read Level	Read Factor	Limit Level	Over Limit	Over Limit	Pol/Phase
	MHz	dBuV	dB/m	dBuV/m	dBuV/m	dB	
1	5856.105	60.45	0.00	60.45	110.49	-50.04	Vertical
2	5868.295	59.77	0.00	59.77	107.08	-47.31	Vertical
3	5889.760	59.70	0.00	59.70	94.25	-34.55	Vertical
4	5900.890	60.23	0.00	60.23	86.00	-25.77	Vertical
5	5918.115	59.62	0.00	59.62	73.28	-13.66	Vertical
6 PP	5942.495	60.57	0.00	60.57	68.20	-7.63	Vertical

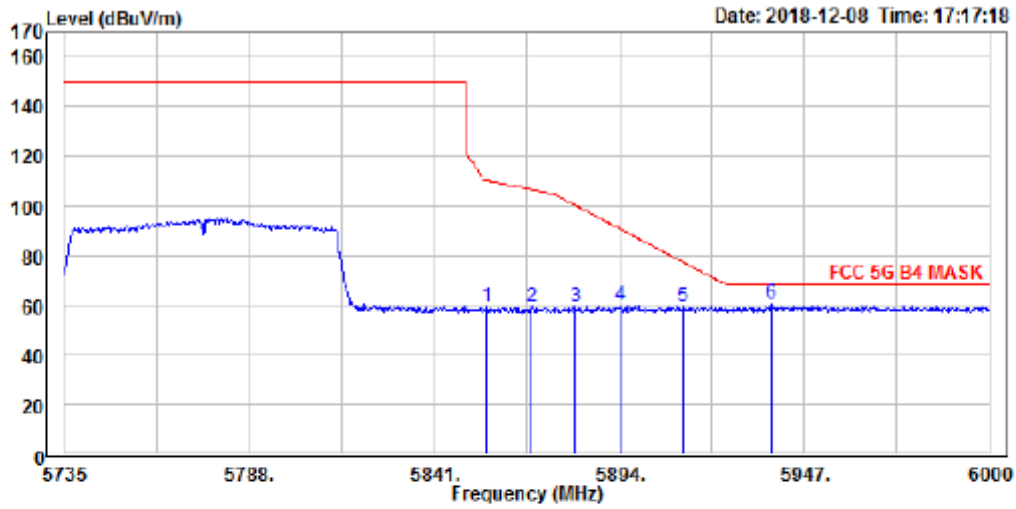

Condition: FCC 5G B4 MASK 3m Horizontal
 : RBW:1000kHz VBW:1000kHz SWT:Auto DET:Positive
 EUT : 5G n80 mode mask high ch
 Mode :
 Note :

	Read		Limit	Over		
Freq	Level	Factor	Level	Line	Limit	Pol/Phase
MHz	dBuV	dB/m	dBuV/m	dBuV/m	dB	
1	5856.105	59.23	0.00	59.23	110.49	-51.26 Horizontal
2	5869.090	59.78	0.00	59.78	106.85	-47.07 Horizontal
3	5881.545	59.34	0.00	59.34	100.34	-41.00 Horizontal
4	5894.265	59.94	0.00	59.94	90.91	-30.97 Horizontal
5	5912.285	59.33	0.00	59.33	77.58	-18.25 Horizontal
6 PP	5937.725	61.03	0.00	61.03	68.20	-7.17 Horizontal

10. Transmission in the Absence of Data

10.1. Standard Applicable

According to §15.407(c)

The device shall automatically discontinue transmission in case of either absence of information to transmit or operational failure. These provisions are not intended to preclude the transmission of control or signaling information or the use of repetitive codes used by certain digital technologies to complete frame or burst intervals. Applicants shall include in their application for equipment authorization a description of how this requirement is met.

10.2. Result:

Pass, the device is compliance with 802.11 a/ b/g/n ac standard, the short control signal is appear during no transmission period.

11. Frequency Stability

11.1. Standard Applicable

According to §15.407 (g) Manufacturers of U-NII devices are responsible for ensuring frequency stability such that an emission is maintained within the band of operation under all conditions of normal operation as specified in the user’s manual.

11.2. Result

Test frequency : 5260 MHz

Temperature test				
Power Supply	Environment	Frequency	Delta (MHz)	frequency drift (ppm)
Vdc	Temperature ()	(MHz)		
12	-20	5260.023200	0.023200	4.41
	-10	5260.038100	0.038100	7.24
	0	5260.034400	0.034400	6.54
	10	5260.040000	0.040000	7.60
	20	5260.042500	0.042500	8.08
	30	5260.036700	0.036700	6.98
	40	5260.041100	0.041100	7.81
	50	5260.042200	0.042200	8.02

Voltage test				
Power Supply	Environment	Frequency	Delta (kHz)	frequency drift (ppm)
Vdc	Temperature ()	(MHz)		
12	20	5260.029900	0.02990	5.68
13.2	20	5260.017800	0.01780	3.38
10.8	20	5260.030600	0.03060	5.82

12. Antenna Requirement

12.1. Standard Applicable

According to §15.203, Antenna requirement.

An intentional radiator shall be designed to ensure that no antenna other than that furnished by the responsible party shall be used with the device. The use of a permanently attached antenna or of an antenna that uses a unique coupling to the intentional radiator shall be considered sufficient to comply with the provisions of this Section. The manufacturer may design the unit so that a broken antenna can be replaced by the user, but the use of a standard antenna jack or electrical connector is prohibited. This requirement does not apply to carrier current devices or to devices operated under the provisions of Sections 15.211, 15.213, 15.217, 15.219, or 15.221. Further, this requirement does not apply to intentional radiators that must be professionally installed, such as perimeter protection systems and some field disturbance sensors, or to other intentional radiators which, in accordance with Section 15.31(d), must be measured at the installation site. However, the installer shall be responsible for ensuring that the proper antenna is employed so that the limits in this Part are not exceeded.

According to RSS-GEN 7.1.2, a transmitter can only be sold or operated with antennas with which it was certified. A transmitter may be certified with multiple antenna types. An antenna type comprises antennas having similar in-band and out-of-band radiation patterns. Testing shall be performed using the highest-gain antenna of each combination of transmitter and antenna type for which certification is being sought, with the transmitter output power set at the maximum level. Any antenna of the same type and having equal or lesser gain as an antenna that had been successfully tested for certification with the transmitter, will also be considered certified with the transmitter, and may be used and marketed with the transmitter. The manufacturer shall include with the application for certification a list of acceptable antenna types to be used with the transmitter.

When a measurement at the antenna connector is used to determine RF output power, the effective gain of the device's antenna shall be stated, based on measurement or on data from the antenna manufacturer. Any antenna gain in excess of 6 dBi (6 dB above isotropic gain) shall be added to the measured RF output power before using the power limits specified in RSS-247 or RSS-310 for devices of RF output powers of 10 milliwatts or less. For devices of output powers greater than 10 milliwatts, except devices subject to RSS-247 Annex 8 (Frequency Hopping and Digital Modulation Systems Operating in the 902-928 MHz, 2400-2483.5 MHz, and 5745-5850 MHz Bands) or RSS-247 Annex 9 (Local Area Network Devices), the total antenna gain shall be added to the measured RF output power before using the specified power limits. For devices subject to RSS-247 Annex 8 or Annex 9, the antenna gain shall not be added.

12.2. Antenna Connected Construction

The directional gains of antenna used for transmitting is 6.63dBi, which is revised PCB antenna and no consideration of replacement by user. Please see EUT photo and antenna spec. for details.

13. TPC and DFS Measurement

13.1. TPC: Standard Applicable

According to §15.407(h)(1), Transmit power control (TPC). U-NII devices operating in the 5.25-5.35 GHz band and the 5.47-5.725 GHz band shall employ a TPC mechanism. The U-NII device is required to have the capability to operate at least 6 dB below the mean EIRP value of 30 dBm. A TPC mechanism is not required for systems with an e.i.r.p. of less than 500 mW.

According to RSS 210 A9.2 (3), The maximum conducted output power shall not exceed 250mW or $11 + 10 \log_{10} B$, dBm, whichever power is less. The power spectral density shall not exceed 11dBm in any 1.0 MHz band. The maximum e.i.r.p. shall not exceed 1.0 W or $17 + 10 \log_{10} B$, dBm, whichever power is less. B is the 99% emission bandwidth in MHz. Note that devices with a maximum e.i.r.p. greater than 500mW shall implement TPC in order to have the capability to operate at least 6 dB below the maximum permitted e.i.r.p. of 1 W.

15.1.1. Result: N/A, The output power is less than 500mW (27dBm).

13.2. DFS: Standard Applicable

According to §15.407(h)(2), Radar Detection Function of Dynamic Frequency Selection (DFS). U-NII devices operating in the 5.25-5.35 GHz and 5.47-5.725 GHz bands shall employ a DFS radar detection.

According to RSS 210 A9.3), Note: For the band 5600-5650 MHz, no operation is permitted. Until further notice, devices subject to this annex shall not be capable of transmitting in the band 5600-5650 MHz. This restriction is for the protection of Environment Canada weather radars operating in this band.

Devices operating in the bands 5250-5350 MHz, 5470-5600 MHz and 5650-5725 MHz band shall comply with the following:

(a) Devices shall employ a DFS radar detection mechanism to detect the presence of radar systems and to avoid co-channel operation with radar systems (see Note below). The minimum DFS radar signal detection threshold is -62dBm for devices with a maximum e.i.r.p. less than 200mW, and -64dBm for devices with a maximum e.i.r.p. of 200mW to 1 W. The detection threshold power is the received power, averaged over a 1-microsecond reference to a 0dBi antenna. The DFS process shall provide a uniform spreading of the loading over all the available channels.

Note: Test procedures for demonstrating compliance with the DFS radar detection requirements set out in this section are being evaluated by Industry Canada. As an interim measure, the Department will, until further notice, accept utilization of the DFS test procedures published by the U.S. Federal Communications Commission (FCC) 3 to demonstrate compliance with the requirements of this section.

(b) Operational requirements: the requirement for channel availability check time applies in the master operational mode. The requirement for channel move time applies in both the master and slave operational modes.

(i) In-service monitoring: an LE-LAN device should be able to monitor the operating channel to check that a co-channel radar has not moved or started operation within range of the LE-LAN device. During in-service monitoring, the LE-LAN radar detection function continuously searches for radar signals between normal LE-LAN transmissions.

(ii) Channel availability check time: the device shall check if there is a radar system already operating on the channel before it initiates a transmission on a channel and when it moves to a channel. The device may start using the channel if no radar signals with a power level greater than the interference threshold value specified in A9.3 (a) above is detected within 60 seconds.

(iii) Channel move time: after a radar's signal is detected, the device shall cease all transmissions on the operating channel within 10 seconds. Transmission during this period shall consist of normal traffic for a maximum of 200 ms after detection of the radar signal. Intermittent management and control signals may also be sent during the remaining time to facilitate vacating the operating channel.

(iv) Channel closing time: the maximum channel closing time is 260 ms.

(v) Non-occupancy period: a channel that has been flagged as containing a radar signal, either by a channel availability check or in-service monitoring, is subject to a 30-minute non-occupancy period where the channel cannot be used by the LE-LAN device. The non-occupancy period starts from the time that the radar signal is detected.

13.2.1. Limit

Table 1: Applicability of DFS requirements prior to use of a channel

Requirement	Operational Mode		
	Slave	Client(without radar detection)	Client(with radar detection)
Non-occupancy Period	Yes	Not required	Yes
DFS Detection Threshold	Yes	Not required	Yes
Channel Availability Check Time	Yes	Not required	Not required
Uniform Spreading	Yes	Not required	Not required
U-NII Detection Bandwidth	Yes	Not required	Yes

Table 2: Applicability of DFS requirements during normal operation

Requirement	Operational Mode		
	Slave	Client(without radar detection)	Client(with radar detection)
DFS Detection Threshold	Yes	Not required	Yes
Channel Closing Transmission Time	Yes	Yes	Yes
Channel Move Time	Yes	Yes	Yes
U-NII Detection Bandwidth	Yes	Not required	Yes

Refer to KDB Number: 848637

Refer to KDB Number: 905462 APPENDIX B COMPLIANCE MEASUREMENT PROCEDURES FOR UNLICENSED-NATIONAL INFORMATION INFRASTRUCTURE DEVICES OPERATING IN THE 5.25-5.35 GHz AND 5.47-5.725 GHz BANDS INCORPORATING DYNAMIC FREQUENCY SELECTION.

Table 3: Interference Threshold values, Master or Client incorporating In-Service Monitoring

Maximum Transmit Power	Value (see note)
≥ 200 milliwatt	-64 dBm
< 200 milliwatt	-62 dBm
<p>Note 1: This is the level at the input of the receiver assuming a 0 dBi receive antenna Note 2: Throughout these test procedures an additional 1 dB has been added to the amplitude of the test transmission waveforms to account for variations in measurement equipment. This will ensure that the test signal is at or above the detection threshold level to trigger a DFS response.</p>	

Table 4: DFS Response requirement values

Parameter	Value
<i>Non-occupancy period</i>	Minimum 30 minutes
<i>Channel Availability Check Time</i>	60 seconds
<i>Channel Move Time</i>	10 seconds See Note 1.
<i>Channel Closing Transmission Time</i>	200 milliseconds + an aggregate of 60 milliseconds over remaining 10 second period. See Notes 1 and 2.
<i>U-NII Detection Bandwidth</i>	Minimum 80% of the U-NII 99% transmission power bandwidth. See Note 3.
<p>Note 1: The instant that the <i>Channel Move Time</i> and the <i>Channel Closing Transmission Time</i> begins is as follows:</p> <ul style="list-style-type: none"> • For the Short Pulse Radar Test Signals this instant is the end of the <i>Burst</i>. • For the Frequency Hopping radar Test Signal, this instant is the end of the last radar <i>Burst</i> generated. • For the Long Pulse Radar Test Signal this instant is the end of the 12 second period defining the <i>Radar Waveform</i>. <p>Note 2: The <i>Channel Closing Transmission Time</i> is comprised of 200 milliseconds starting at the beginning of the <i>Channel Move Time</i> plus any additional intermittent control signals required to facilitate a <i>Channel</i> move (an aggregate of 60 milliseconds) during the remainder of the 10 second period. The aggregate duration of control signals will not count quiet periods in between transmissions.</p> <p>Note 3: During the <i>U-NII Detection Bandwidth</i> detection test, radar type 1 is used and for each frequency step the minimum percentage of detection is 90 percent. Measurements are performed with no data traffic.</p>	

Table 5: Radar Test Waveforms

Short Pulse Radar

Radar Type	Pulse Width (µsec)	PRI (µsec)	Number of Pulses	Minimum Percentage of Successful Detection	Minimum Trials
1	1	1428	18	60%	30
2	1-5	150-230	23-29	60%	30
3	6-10	200-500	16-18	60%	30
4	11-20	200-500	12-16	60%	30
Aggregate (Radar Types 1-4)				80%	120

A minimum of 30 unique waveforms are required for each of the Short Pulse Radar Types 2 through 4. For Short Pulse Radar Type 1, the same waveform is used a minimum of 30 times. If more than 30 waveforms are used for Short Pulse Radar Types 2 through 4, then each additional waveform must also be unique and not repeated from the previous waveforms

Long Pulse Radar

Radar Type	Pulse Width (µsec)	Chirp Width (MHz)	PRI (µsec)	Number of Pulses per Burst	Number of Bursts	Minimum Percentage of Successful Detection	Minimum Trials
5	50-100	5-20	1000-2000	1-3	8-20	80%	30

The parameters for this waveform are randomly chosen. Thirty unique waveforms are required for the Long Pulse Radar Type waveforms. If more than 30 waveforms are used for the Long Pulse Radar Type waveforms, then each additional waveform must also be unique and not repeated from the previous waveforms.

Frequency Hopping Radar

Radar Type	Pulse Width (µsec)	PRI (µsec)	Pulses per Hop	Hopping Rate (kHz)	Hopping Sequence Length (msec)	Minimum Percentage of Successful Detection	Minimum Trials
6	1	333	9	.333	300	70%	30

For the Frequency Hopping Radar Type, the same *Burst* parameters are used for each waveform. The hopping sequence is different for each waveform and a 100-length segment is selected from the hopping sequence defined by the following algorithm: 3

The first frequency in a hopping sequence is selected randomly from the group of 475 integer frequencies from 5250 – 5724 MHz. Next, the frequency that was just chosen is removed from the group and a frequency is randomly selected from the remaining 474 frequencies in the group. This process continues until all 475 frequencies are chosen for the set. For selection of a random frequency, the frequencies remaining within the group are always treated as equally likely.

13.2.2. Test Setup

Setup for Master with injection at the Master

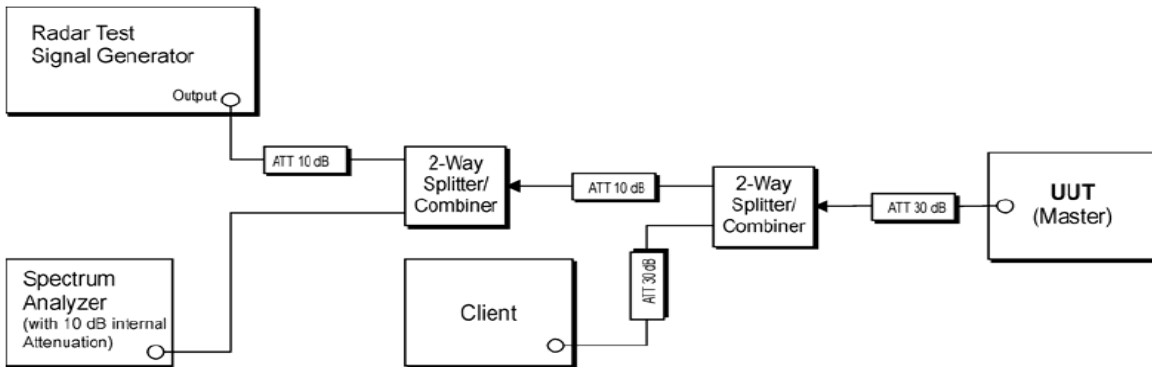

Setup for Client with injection at the Master

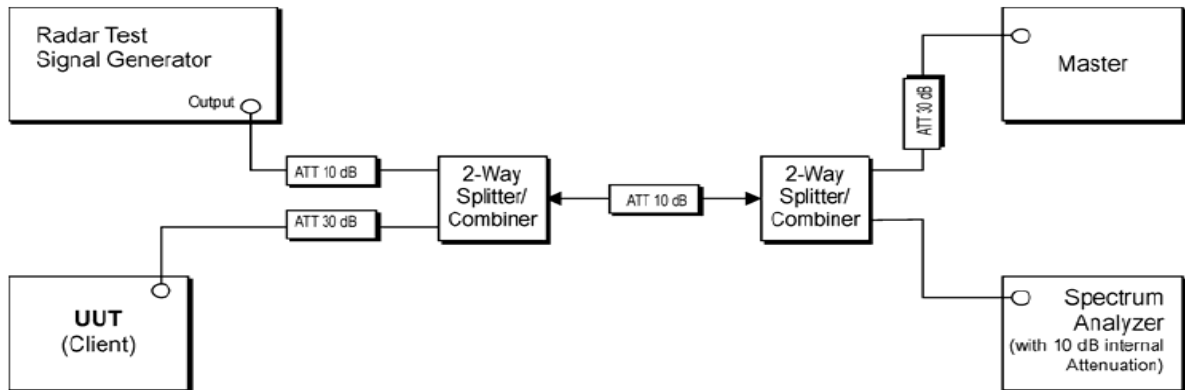

Setup for Client with injection at the Client

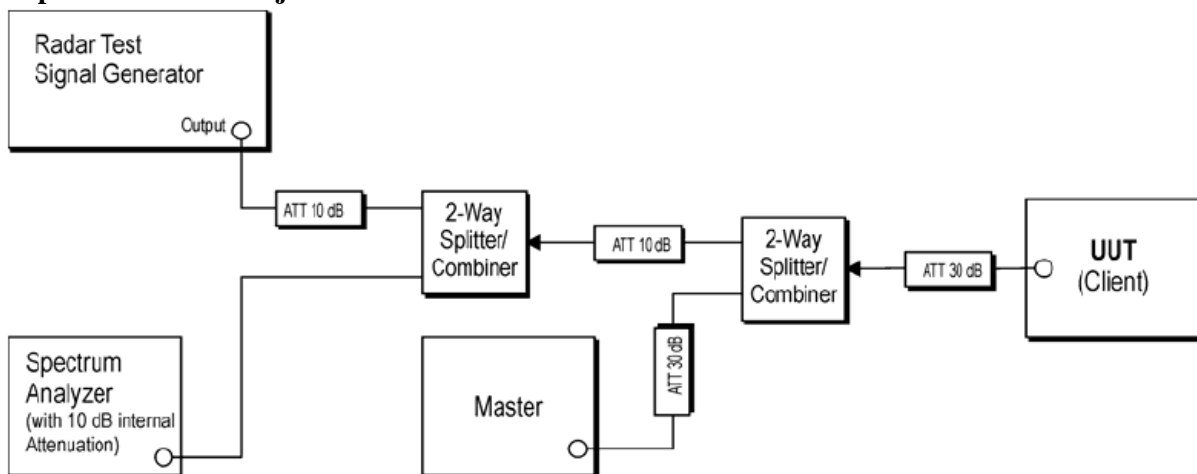

13.3. Test Equipment Used:

Conducted DFS Test Site					
Equipment Type	MFR	Model Number	Serial Number	Last Cal.	Cal Due.
Signal Generator	Agilent	E4438C	MY49071550	11/16/2018	11/15/2019
Signal Generator	keysight	N5182B	MY53052399	12/07/2018	12/06/2019
Spectrum analyzer	keysight	N9010A	MY56070257	10/15/2018	10/14/2019
AP Router	ASUS	RTAC66U	FTX1220905D	NA	NA
Usb Adapter	D-Link	DWA-182	QBYS1D8000 073	NA	NA
Test Box	keysight	AD211A	NA	NA	NA
Test Box	keysight	AD191A	NA	NA	NA
Direction Coupler	Krytar	1821S	1461	NA	NA
Splitter	Mini-Circuits	ZN2PD-63-S	UU97201111	NA	NA
Attenuator	Woken	Watt-65m3502	11051601	NA	NA
Software	Agilent	Adaptive TEST	NA	NA	NA
Cable	Draka	NA	NA	NA	NA
Test Software	Keysight	N9607B DFS Radar Profiles	NA	NA	NA
Test Software	Keysight	ETSI Standard test system	NA	NA	NA

13.3.1. Description of EUT :

EUT operates over the 5250-5350MHz and 5470-5725MHz ranges and EUT is a slave device (client equipment) w/o radar detection and DFS capability.

The EUT utilizes the 802.11ac architecture, with a nominal channel bandwidth of 80MHz WLAN traffic is generated by streaming the mpeg file from the master to slave in full monitor video mode using the media player.

The rated output power of the master unit is >23dBm(EIRP).therefore the required interference threshold level is -64dBm. The master device as employed for the applicable DFS test is ASUS router whose FCC ID= MSQ-RTAC66U

13.4. Test results

Applicability of DFS requirements prior to use of a channel

Requirement	Operational Mode: Client(without radar detection)	
	Test Result	Remark
Non-occupancy Period	N/A	Pass
DFS Detection Threshold	N/A	Pass
Channel Availability Check Time	N/A	Pass
Uniform Spreading	N/A	Pass
U-NII Detection Bandwidth	N/A	Pass

Applicability of DFS requirements during normal operation

Requirement	Operational Mode: Client(without radar detection)	
	Test Result	Remark
DFS Detection Threshold	N/A	Pass
Channel Closing Transmission Time	Less than 200ms, Refer to next page for plots.	Pass
Channel Move Time	Less than 10s, Refer to next page for plots.	Pass
U-NII Detection Bandwidth	N/A	Pass

Input Level to Master AP= -64dBm

5250MHz ~ 5350MHz

Radar Type 1 Channel Move & Closing Transmission Time

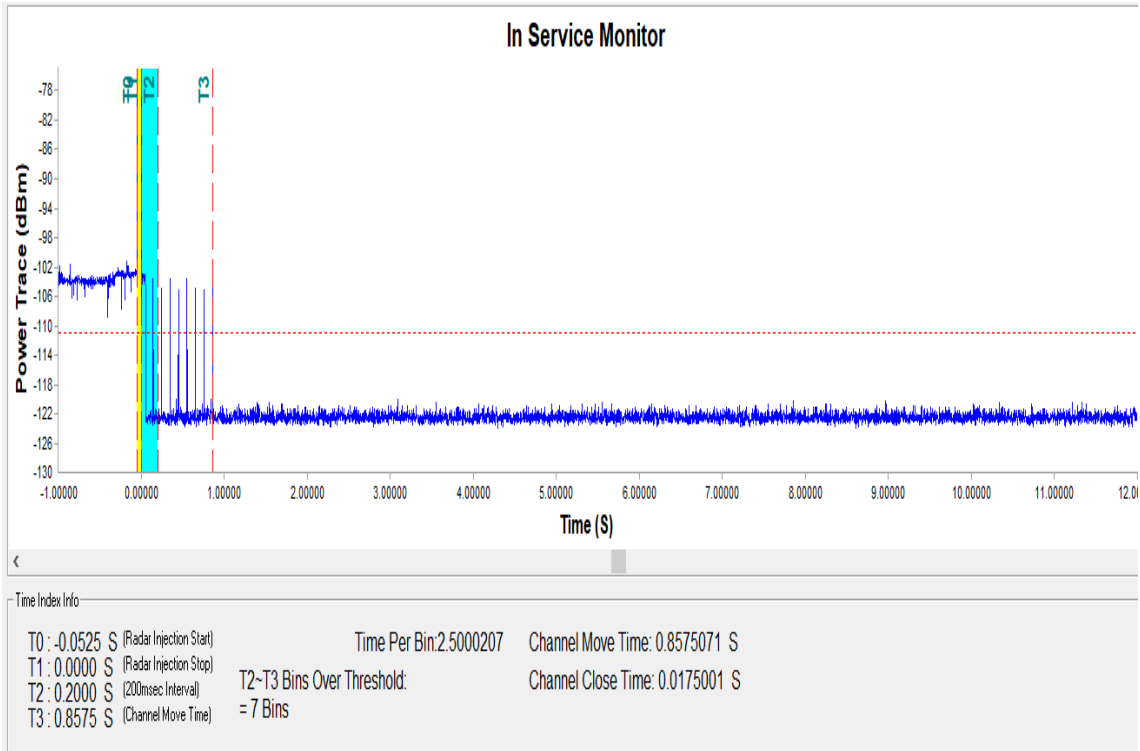

Non-occupancy Period

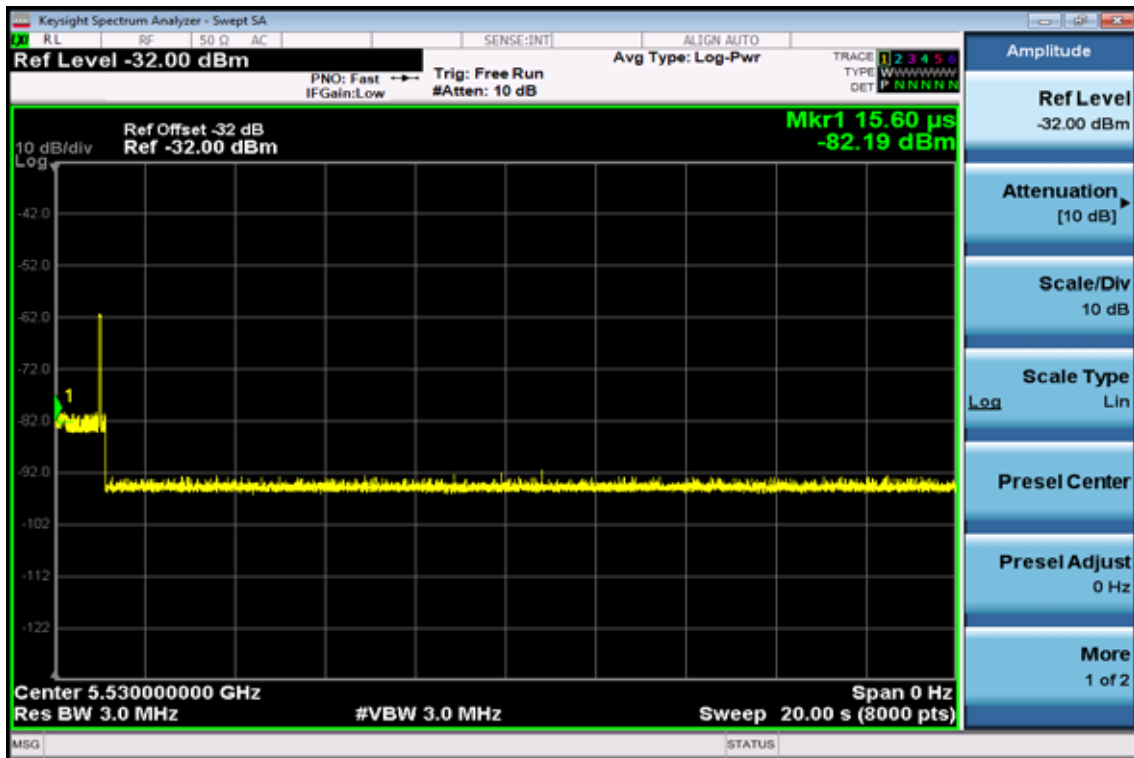

5500MHz ~ 5700MHz

Radar Type 1 Channel Move & Closing Transmission Time

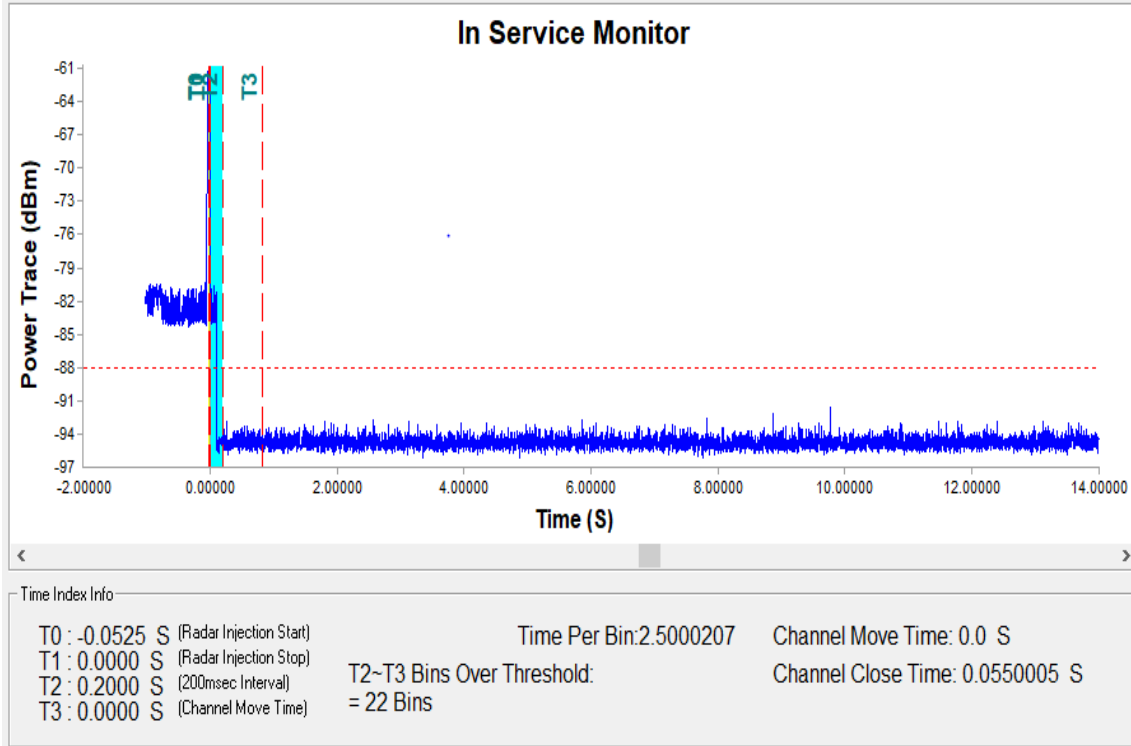

Non-occupancy Period

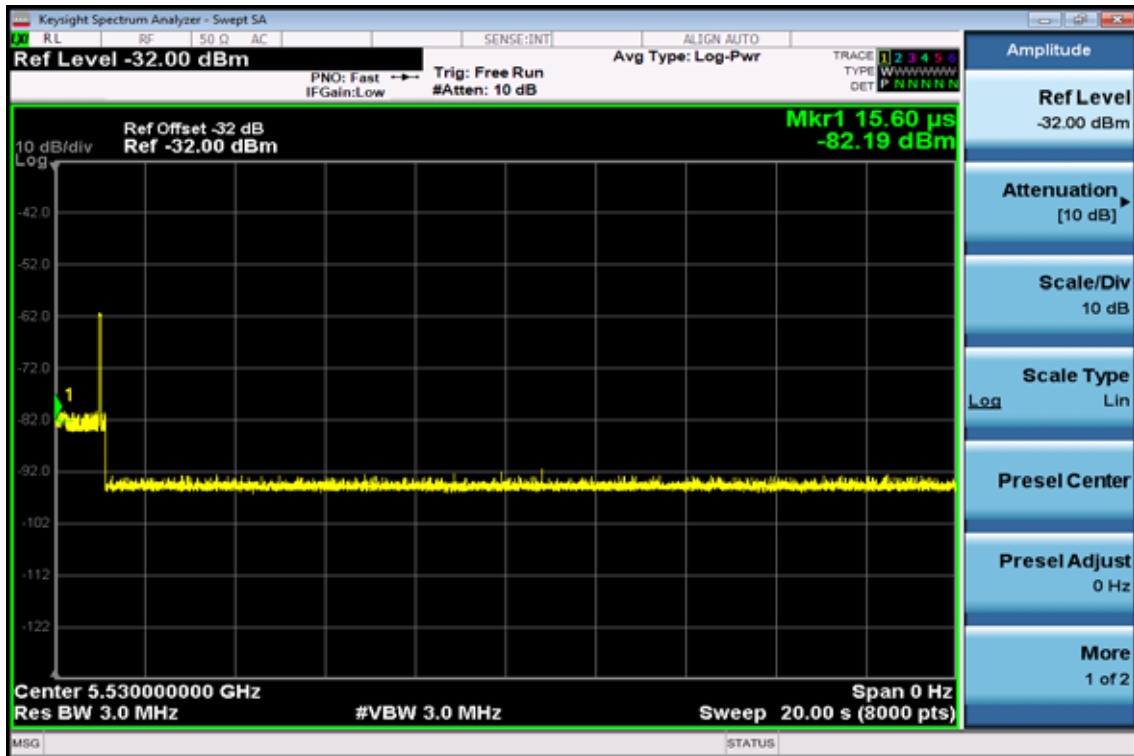

Radar type 3

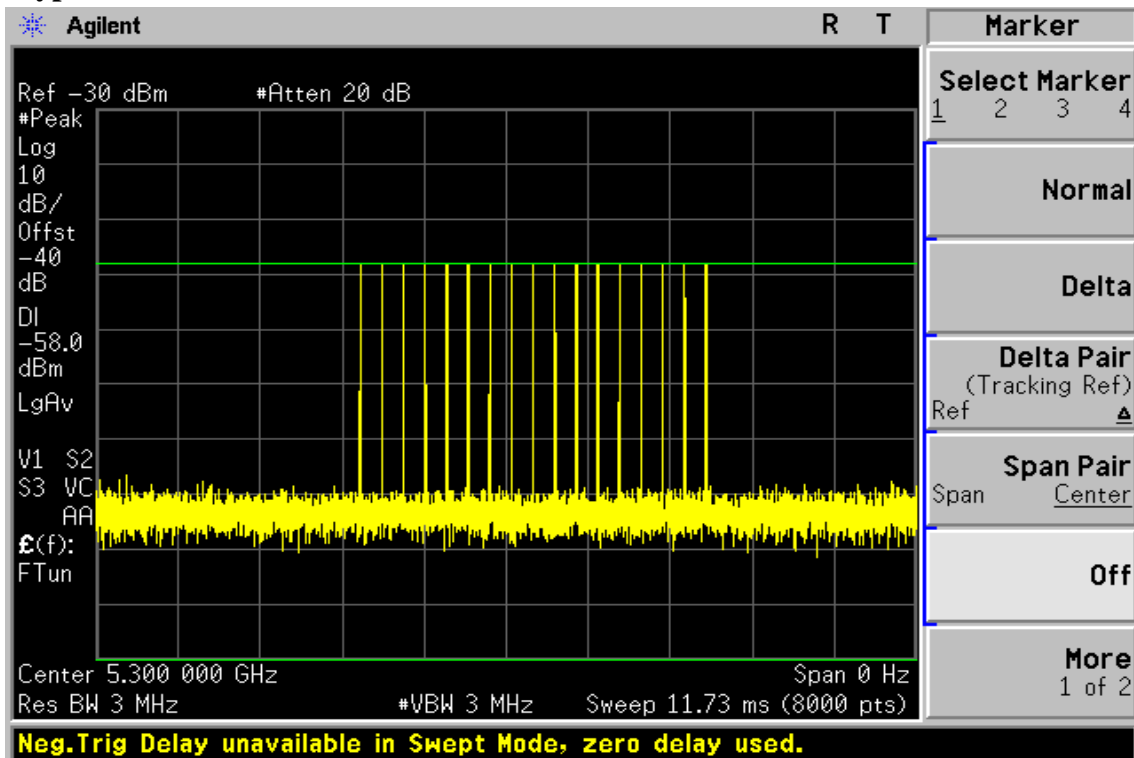

Radar type 4

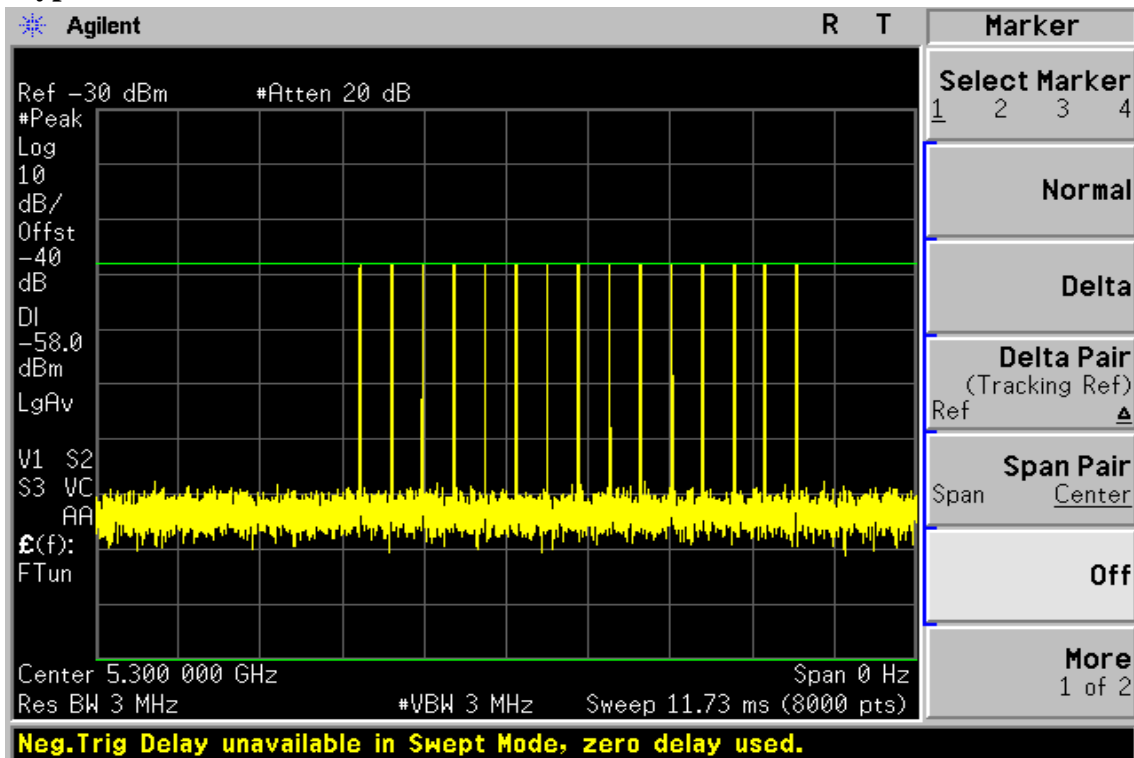

Radar type 5

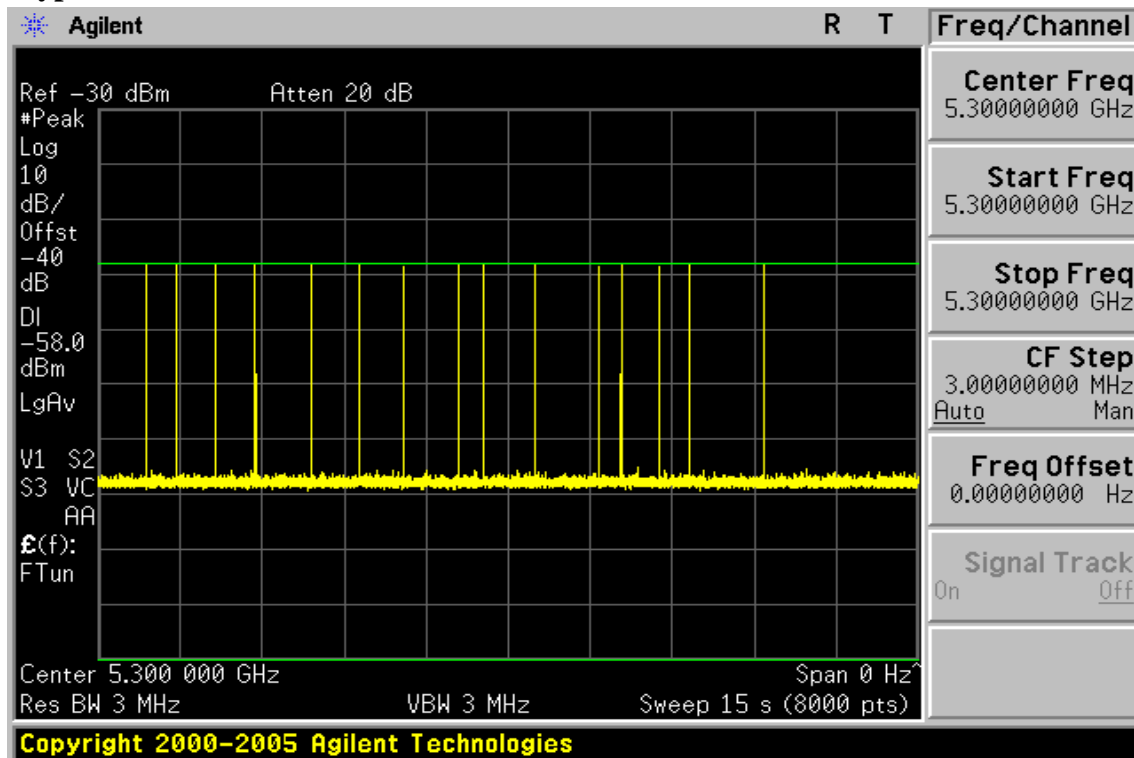

Radar type 6

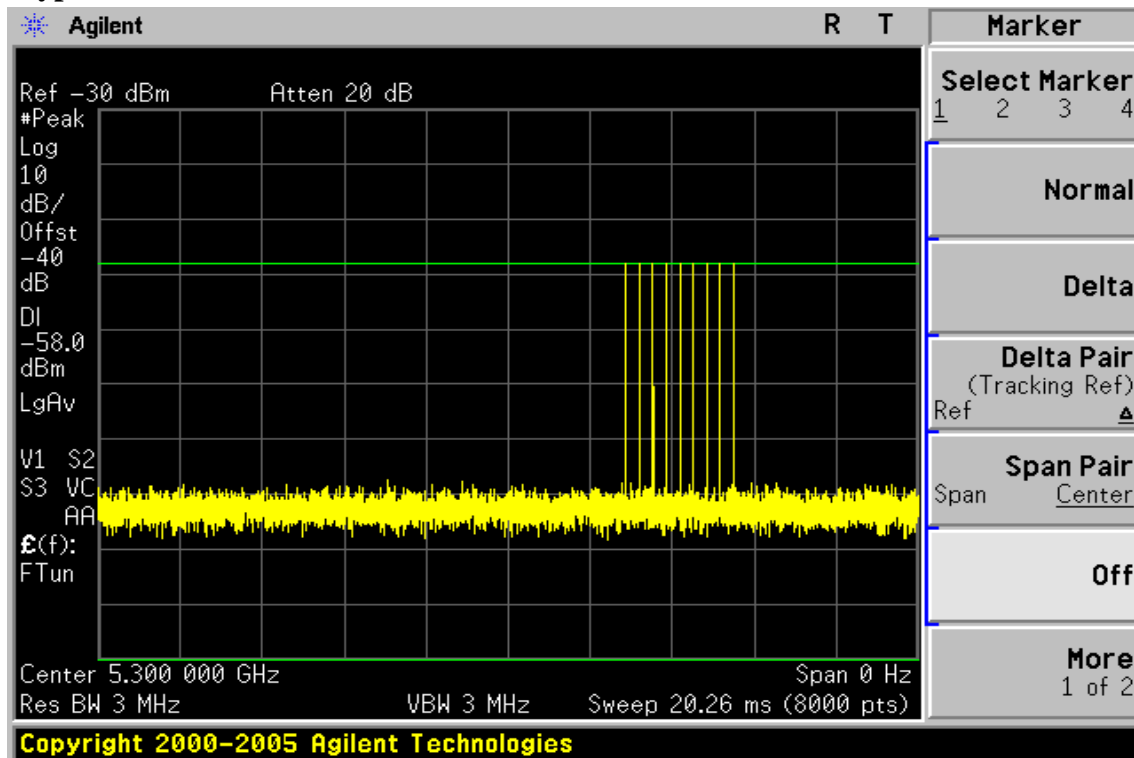

Band 2

WLAN traffic

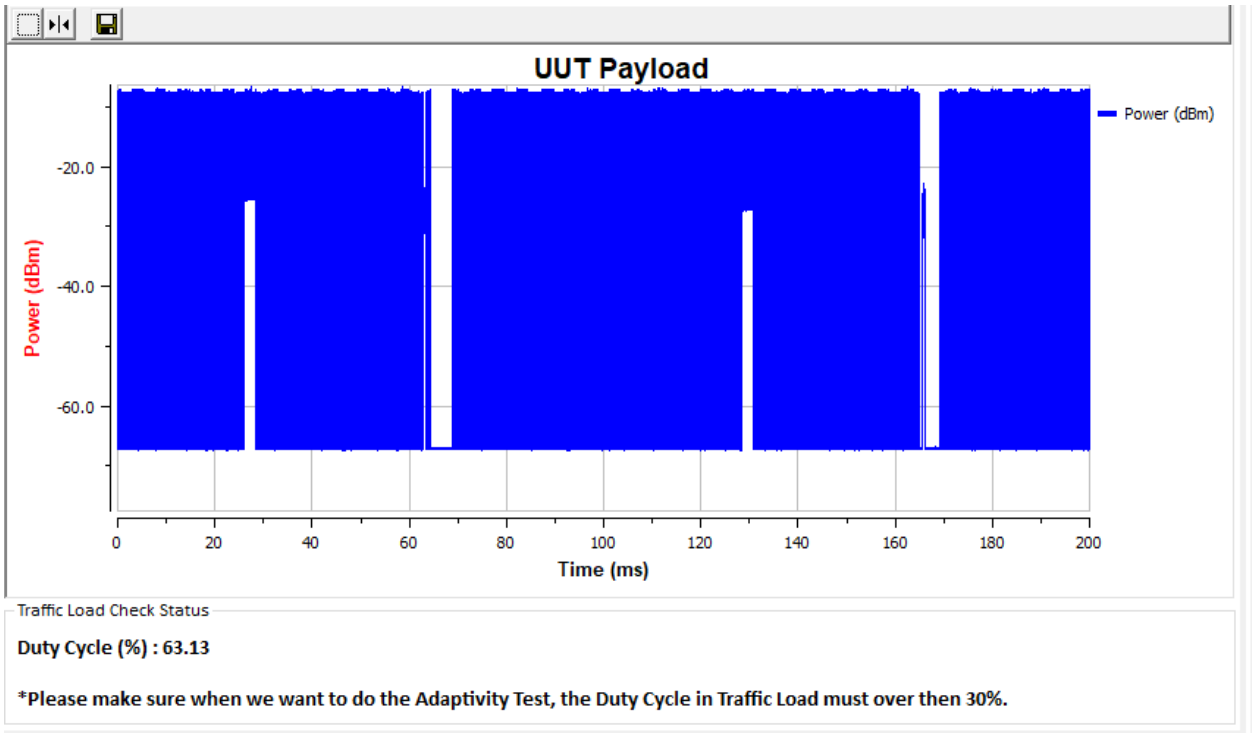

Band 3

WLAN traffic

