

FCC Part 15C Test Report

FCC ID:2AR3Y-BY-135-TX

Product Name: e-Drone
Trademark: N/A
Model Number: BRED-G-RD0
Prepared For: Roboworks Inc.
Address: 155-11, Robot land-ro, Seo-gu, Incheon 22851, South Korea
Manufacturer: Byrobot Co.,Ltd
Address: #1001, A-dong, U-TOWER, 767, Sinsu-ro, Suji-gu, Yongin-si, Gyeonggi-do, Republic of Korea (16827)
Prepared By: Shenzhen BCTC Testing Co., Ltd.
Address: BCTC Building & 1-2F, East of B Building, Pengzhou Industrial, Fuyuan 1st Road, Qiaotou Community, Fuyong Street, Bao'an District, Shenzhen, China
Sample tested Date: Nov. 13, 2018 – Dec. 18, 2018
Issue Date: Dec. 18, 2018
Report No.: BCTC-FY181106373E
Test Standards: FCC Part15.247
ANSI C63.10-2013

Prepared by(Engineer): Leke Xie



Reviewer(Supervisor): Eric Yang



Approved(Manager): Carson Zhang



This device described above has been tested by BCTC, and the test results show that the equipment under test (EUT) is in compliance with the FCC requirements. *The test report is effective only with both signature and specialized stamp. This result(s) shown in this report refer only to the sample(s) tested. Without written approval of Shenzhen BCTC Testing Co., Ltd, this report can't be reproduced except in full. The tested sample(s) and the sample information are provided by the client.*

Table of Contents		Page
1 . VERSION		4
2 . SUMMARY OF TEST RESULTS		4
2.1 TEST FACILITY		5
2.2 MEASUREMENT UNCERTAINTY		5
3 . GENERAL INFORMATION		6
3.1 GENERAL DESCRIPTION OF EUT		6
3.2 DESCRIPTION OF TEST MODES		7
3.3 BLOCK DIGRAM SHOWING THE CONFIGURATION OF SYSTEM TESTED		8
3.4 DESCRIPTION OF SUPPORT UNITS(CONDUCTED MODE)		8
3.5 EQUIPMENTS LIST FOR ALL TEST ITEMS		9
4 . EMC EMISSION TEST		10
4.1 CONDUCTED EMISSION MEASUREMENT		10
4.1.1 POWER LINE CONDUCTED EMISSION LIMITS		10
4.1.2 TEST PROCEDURE		10
4.1.3 DEVIATION FROM TEST STANDARD		10
4.1.4 TEST SETUP		11
4.1.5 EUT OPERATING CONDITIONS		11
4.1.6 TEST RESULTS		11
4.2 RADIATED EMISSION MEASUREMENT		14
4.2.1 RADIATED EMISSION LIMITS		14
4.2.2 TEST PROCEDURE		15
4.2.3 DEVIATION FROM TEST STANDARD		15
4.2.4 TEST SETUP		15
4.2.5 EUT OPERATING CONDITIONS		17
4.2.6 TEST RESULTS (BETWEEN 9KHZ – 30 MHZ)		18
4.2.7 TEST RESULTS (BETWEEN 30MHZ – 1GHZ)		19
3.3 RADIATED BAND EMISSION MEASUREMENT		22
3.3.1 TEST REQUIREMENT:		22
3.3.2 TEST PROCEDURE		22
3.3.3 DEVIATION FROM TEST STANDARD		23
3.3.4 TEST SETUP		23
3.3.5 EUT OPERATING CONDITIONS		23
5 . POWER SPECTRAL DENSITY TEST		25
5.1 APPLIED PROCEDURES / LIMIT		25



	Page
Table of Contents	
5.1.1 TEST PROCEDURE	25
5.1.2 DEVIATION FROM STANDARD	25
5.1.3 TEST SETUP	25
5.1.4 EUT OPERATION CONDITIONS	25
5.1.5 TEST RESULTS	26
6 . BANDWIDTH TEST	28
6.1 APPLIED PROCEDURES / LIMIT	28
6.1.1 TEST PROCEDURE	28
6.1.2 DEVIATION FROM STANDARD	28
6.1.3 TEST SETUP	28
6.1.4 EUT OPERATION CONDITIONS	28
6.1.5 TEST RESULTS	29
7 . PEAK OUTPUT POWER TEST	31
7.1 APPLIED PROCEDURES / LIMIT	31
7.1.1 TEST PROCEDURE	31
7.1.2 DEVIATION FROM STANDARD	31
7.1.3 TEST SETUP	31
7.1.4 EUT OPERATION CONDITIONS	31
7.1.5 TEST RESULTS	32
8 . 100 KHZ BANDWIDTH OF FREQUENCY BAND EDGE	33
7.1 APPLICABLE STANDARD	33
7.2 TEST PROCEDURE	33
7.3 DEVIATION FROM STANDARD	33
7.4 TEST SETUP	33
7.5 EUT OPERATION CONDITIONS	33
9 . ANTENNA REQUIREMENT	36
9.1 STANDARD REQUIREMENT	36
9.2 EUT ANTENNA	36
10 . EUT TEST PHOTO	37
11 . EUT PHOTO	39
APPENDIX-PHOTOGRAPHS OF EUT CONSTRUCTIONAL DETAILS	

1. VERSION

Report No.	Issue Date	Description	Approved
BCTC-FY181106373E	Dec. 18, 2018	Original	Valid

2. SUMMARY OF TEST RESULTS

Test procedures according to the technical standards:

RSS-247 Issue 2: February 2017 FCC Part15 (15.247) , Subpart C			
Standard Section	Test Item	Judgment	Remark
RSS-GEN 8.8 RSS-247 3.1 15.207	Conducted Emission	PASS	
RSS-247 5.2 (a) 15.247 (a)(2)	6dB Bandwidth	PASS	
RSS-247 5.4 (b) 15.247 (b)	Peak Output Power	PASS	
RSS-247 5.5 15.247 (c)	Radiated Spurious Emission	PASS	
RSS-247 5.2 (b) 15.247 (d)	Power Spectral Density	PASS	
RSS-247 5.5 15.205	Restricted Band of Operation	PASS	
RSS-Gen.6.7 15.203	Band Edge (Out of Band Emissions)	PASS	
RSS-GEN 8.8 RSS-247 3.1 15.207	Antenna Requirement	PASS	

NOTE:

(1) "N/A" denotes test is not applicable in this Test Report

2.1 TEST FACILITY

Shenzhen BCTC Testing Co., Ltd.

Add.: BCTC Building & 1-2F, East of B Building, Pengzhou Industrial, Fuyuan 1st Road, Qiaotou Community, Fuyong Street, Bao'an District, Shenzhen, China

FCC Test Firm Registration Number: 712850

IC Registered No.: 23583

2.2 MEASUREMENT UNCERTAINTY

The reported uncertainty of measurement $y \pm U$, where expanded uncertainty U is based on a standard uncertainty multiplied by a coverage factor of $k=2$, providing a level of confidence of approximately **95 %**.

No.	Item	Uncertainty
1	3m chamber Radiated spurious emission(30MHz-1GHz)	U=4.3dB
2	3m chamber Radiated spurious emission(1GHz-18GHz)	U=4.5dB
3	3m chamber Radiated spurious emission(18GHz-40GHz)	U=3.34dB
4	Conducted Adjacent channel power	U=1.38dB
5	Conducted output power uncertainty Above 1G	U=1.576dB
6	Conducted output power uncertainty below 1G	U=1.28dB
7	humidity uncertainty	U=5.3%
8	Temperature uncertainty	U=0.59℃
9	Radiated disturbance(30MHz-1000MHz)	U=4.8dB
10	Radiated disturbance(1GHz-6GHz)	U=4.9dB
11	Radiated disturbance(1GHz-18GHz)	U=5.0dB

3. GENERAL INFORMATION

3.1 GENERAL DESCRIPTION OF EUT

Equipment	e-Drone	
Trade Name	N/A	
Model Name	BRED-G-RD0	
Model Difference	N/A	
Product Description	The EUT is a e-Drone	
	Operation Frequency:	2410-2470MHz
	Modulation Type:	GFSK
	Number Of Channel	61CH
	Antenna Designation:	Please see Note 3.
Based on the application, features, or specification exhibited in User's Manual, the EUT is considered as an ITE/Computing Device. More details of EUT technical specification, please refer to the User's Manual.		
Channel List	Please refer to the Note 2.	
Power Source	Battery DC 3V or DC 5V USB from adapter	
Connecting I/O Port(s)	Please refer to the User's Manual	

Note:

1. For a more detailed features description, please refer to the manufacturer's specifications or the User's Manual.

2.

Channel List					
Channel	Frequency (MHz)	Channel	Frequency (MHz)	Channel	Frequency (MHz)
01	2410	22	2431	43	2452
02	2411	23	2432	44	2453
03	2412	24	2433	45	2454
04	2413	25	2434	46	2455
05	2414	26	2435	47	2456
06	2415	27	2436	48	2457
07	2416	28	2437	49	2458
08	2417	29	2438	50	2459
09	2418	30	2439	51	2460
10	2419	31	2440	52	2461
11	2420	32	2441	53	2462
12	2421	33	2442	54	2463
13	2422	34	2443	55	2464
14	2423	35	2444	56	2465
15	2424	36	2445	57	2466
16	2425	37	2446	58	2467
17	2426	38	2447	59	2468
18	2427	39	2448	60	2469
19	2428	40	2449	61	2470
20	2429	41	2450		
21	2430	42	2451		

3.

Table for Filed Antenna

Ant.	Brand	Model Name	Antenna Type	Gain (dBi)	NOTE
1	N/A	N/A	External ANT	0	

3.2 DESCRIPTION OF TEST MODES

To investigate the maximum EMI emission characteristics generates from EUT, the test system was pre-scanning tested base on the consideration of following EUT operation mode or test configuration mode which possible have effect on EMI emission level. Each of these EUT operation mode(s) or test configuration mode(s) mentioned above was evaluated respectively.

For All Mode	Description	Modulation Type
Mode 1	CH01	GFSK
Mode 2	CH31	
Mode 3	CH61	
Mode 4	Link mode(conducted emission and Radiated emission)	

Note:

- (1) The measurements are performed at the highest, middle, lowest available channels.
- (2) Fully-charged battery is used during the test

3.3 BLOCK DIGRAM SHOWING THE CONFIGURATION OF SYSTEM TESTED

Radiated Spurious Emission Test

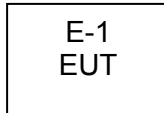

3.4 DESCRIPTION OF SUPPORT UNITS(CONDUCTED MODE)

The EUT has been tested as an independent unit together with other necessary accessories or support units. The following support units or accessories were used to form a representative test configuration during the tests.

Item	Equipment	Mfr/Brand	Model/Type No.	Series No.	Note
E-1	e-Drone	---	BRED-G-RD0	---	EUT

Note:

- (1) The support equipment was authorized by Declaration of Confirmation.
- (2) For detachable type I/O cable should be specified the length in cm in 『Length』 column.

3.5 EQUIPMENTS LIST FOR ALL TEST ITEMS

Radiation Test equipment

Item	Equipment	Manufacturer	Type No.	Serial No.	Last calibration	Calibrated until
1	Spectrum Analyzer (9kHz-26.5GHz)	Agilent	E4407B	MY45109572	2018.06.20	2019.06.20
2	Test Receiver (9kHz-7GHz)	R&S	ESR7	101154	2018.06.20	2019.06.20
3	Bilog Antenna (30MHz-3GHz)	SCHWARZBEC K	VULB9163	VULB9163-942	2018.06.23	2019.06.23
4	Horn Antenna (1GHz-18GHz)	SCHWARZBEC K	BBHA9120D	1541	2018.06.23	2019.06.22
5	Horn Antenna (18GHz-40GHz)	SCHWARZBEC K	BBHA9170	822	2018.08.06	2019.08.06
6	Amplifier (9kHz-6GHz)	SCHWARZBEC K	BBV9744	9744-0037	2018.06.20	2019.06.20
7	Amplifier (0.5GHz-18GHz)	SCHWARZBEC K	BBV9718	9718-309	2018.06.20	2019.06.20
8	Amplifier (18GHz-40GHz)	MITEQ	TTA1840-35-HG	2034381	2018.08.06	2019.08.06
9	Loop Antenna (9kHz-30MHz)	SCHWARZBEC K	FMZB1519B	014	2018.06.23	2019.06.23
10	RF cables1 (9kHz-30MHz)	Huber+Suhnar	9kHz-30MHz	B1702988-0008	2018.02.12	2019.02.12
11	RF cables2 (30MHz-1GHz)	Huber+Suhnar	30MHz-1GHz	1486150	2018.03.27	2019.03.27
12	RF cables3 (1GHz-40GHz)	Huber+Suhnar	1GHz-40GHz	1607106	2018.06.19	2019.06.19
13	Power Metter	Keysight	E4419	\	2018.04.15	2019.04.15
14	Power Sensor (AV)	Keysight	E9 300A	\	2018.04.15	2019.04.15
15	Signal Analyzer 20kHz-26.5GHz	KEYSIGHT	N9020A	MY49100060	2018.08.14	2019.08.13
16	Test Receiver 9kHz-40GHz	R&S	FSP40	100550	2018.06.13	2019.06.12
17	D.C. Power Supply	LongWei	TPR-6405D	\	\	\
18	Software	Frad	EZ-EMC	FA-03A2 RE	\	\

Conduction Test equipment

Item	Equipment	Manufacturer	Type No.	Serial No.	Last calibration	Calibrated until
1	Test Receiver	R&S	ESR3	102075	2018.06.20	2019.06.20
2	LISN	SCHWARZBEC K	NSLK8127	8127739	2018.06.19	2019.06.19
3	LISN	R&S	ENV216	101375	2018.06.20	2019.06.20
4	RF cables	Huber+Suhnar	9kHz-30MHz	B1702988-0008	2018.02.12	2019.02.12
5	Software	Frad	EZ-EMC	EMC-CON 3A1	\	\

4. EMC EMISSION TEST

4.1 CONDUCTED EMISSION MEASUREMENT

4.1.1 POWER LINE CONDUCTED EMISSION Limits (Frequency Range 150KHz-30MHz)

FREQUENCY (MHz)	Limit (dBuV)		Standard
	Quas -peak	Average	
0.15 -0.5	66 - 56 *	56 - 46 *	FCC
0.50 -5.0	56.00	46.00	FCC
5.0 -30.0	60.00	50.00	FCC

Note:

- (1) The tighter limit applies at the band edges.
- (2) The limit of " * " marked band means the limitation decreases linearly with the logarithm of the frequency in the range.

The following table is the setting of the receiver

Receiver Parameters	Setting
Attenuation	10 dB
Start Frequency	0.15 MHz
Stop Frequency	30 MHz
IF Bandwidth	9 kHz

4.1.2 TEST PROCEDURE

- a. The EUT was placed 0.8 meters from the horizontal ground plane with EUT being connected to the power mains through a line impedance stabilization network (LISN). All other support equipments powered from additional LISN(s). The LISN provide 50 Ohm/ 50uH of coupling impedance for the measuring instrument.
- b. Interconnecting cables that hang closer than 40 cm to the ground plane shall be folded back and forth in the center forming a bundle 30 to 40 cm long.
- c. I/O cables that are not connected to a peripheral shall be bundled in the center. The end of the cable may be terminated, if required, using the correct terminating impedance. The overall length shall not exceed 1 m.
- d. LISN at least 80 cm from nearest part of EUT chassis.
- e. For the actual test configuration, please refer to the related Item –EUT Test Photos.

4.1.3 DEVIATION FROM TEST STANDARD

No deviation

4.1.4 TEST SETUP

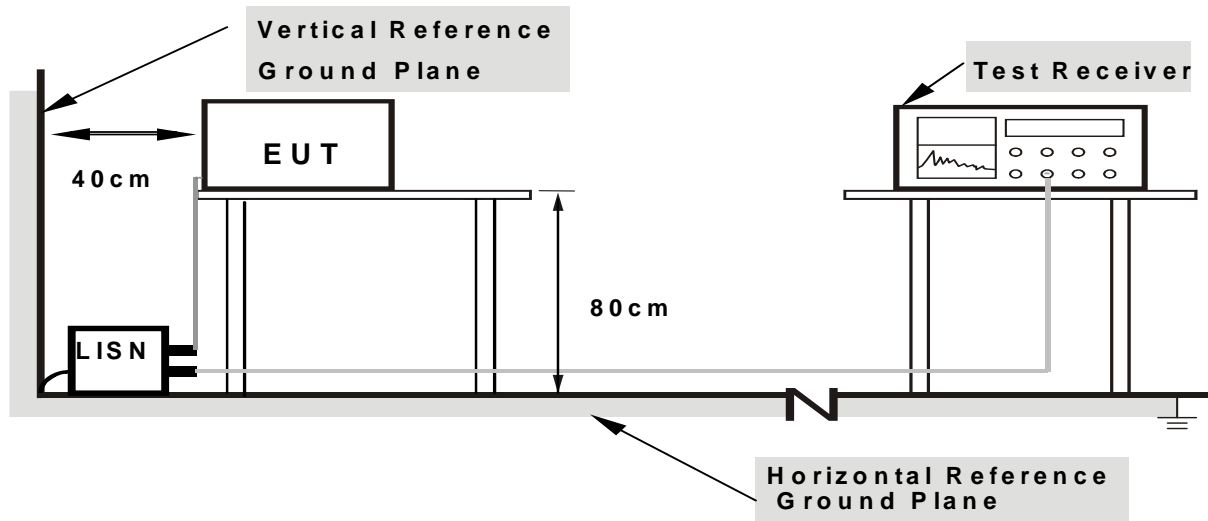

Note: 1.Support units were connected to second LISN.

2.Both of LISNs (AMN) are 80 cm from EUT and at least 80 cm from other units and other metal planes

4.1.5 EUT OPERATING CONDITIONS

The EUT was configured for testing in a typical fashion (as a customer would normally use it). The EUT has been programmed to continuously transmit during test. This operating condition was tested and used to collect the included data.

4.1.6 TEST RESULTS



Temperature :	26°C	Relative Humidity:	54%
Pressure :	101kPa	Phase :	L
Test Voltage :	AC 120V/60Hz	Test Mode :	Mode 4

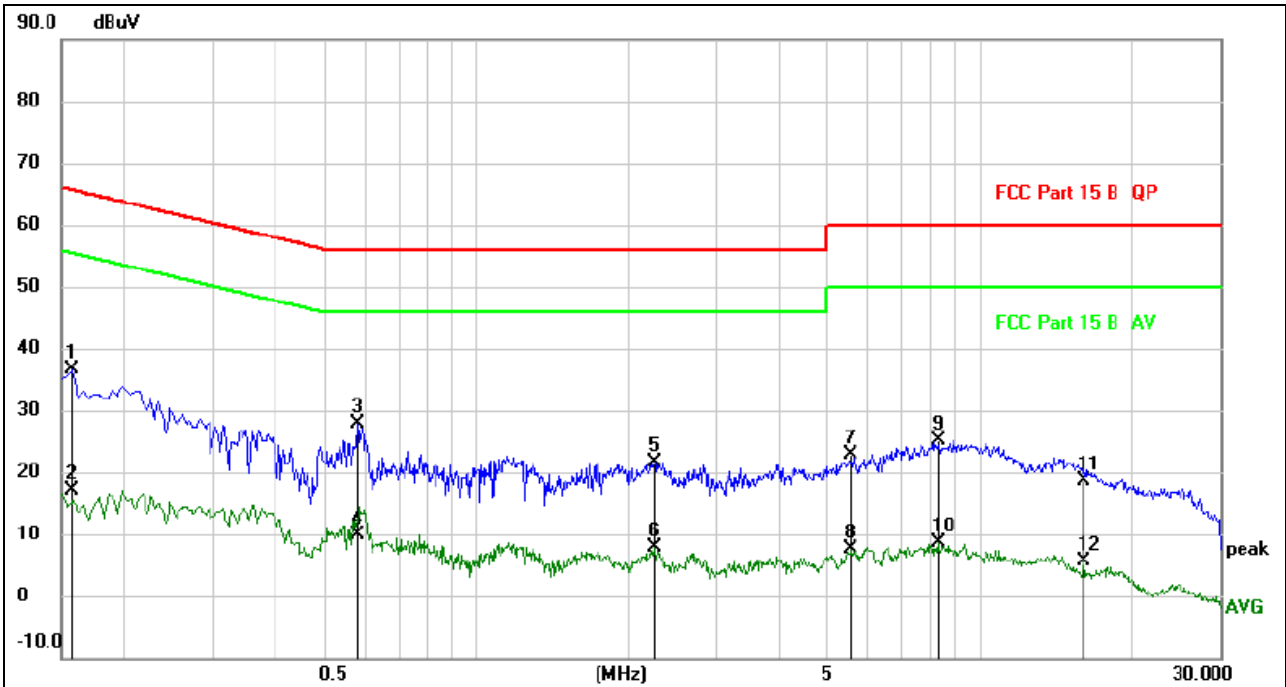

Remark:

1. All readings are Quasi-Peak and Average values.
2. Factor = Insertion Loss + Cable Loss.

No.	Mk.	Freq. MHz	Reading Level dBuV	Correct Factor	Measure- ment dBuV	Limit dBuV	Over dB	Detector	Comment
1		0.1580	27.07	9.51	36.58	65.57	-28.99	QP	
2		0.1580	7.54	9.51	17.05	55.57	-38.52	AVG	
3	*	0.5820	18.05	9.93	27.98	56.00	-28.02	QP	
4		0.5820	-0.12	9.93	9.81	46.00	-36.19	AVG	
5		2.2540	12.03	9.61	21.64	56.00	-34.36	QP	
6		2.2540	-1.82	9.61	7.79	46.00	-38.21	AVG	
7		5.5460	13.15	9.78	22.93	60.00	-37.07	QP	
8		5.5460	-2.06	9.78	7.72	50.00	-42.28	AVG	
9		8.2700	15.44	9.71	25.15	60.00	-34.85	QP	
10		8.2700	-1.01	9.71	8.70	50.00	-41.30	AVG	
11		16.0820	9.03	9.72	18.75	60.00	-41.25	QP	
12		16.0820	-4.13	9.72	5.59	50.00	-44.41	AVG	



Temperature :	26°C	Relative Humidity:	54%
Pressure :	101kPa	Phase :	N
Test Voltage :	AC 120V/60Hz	Test Mode :	Mode 4

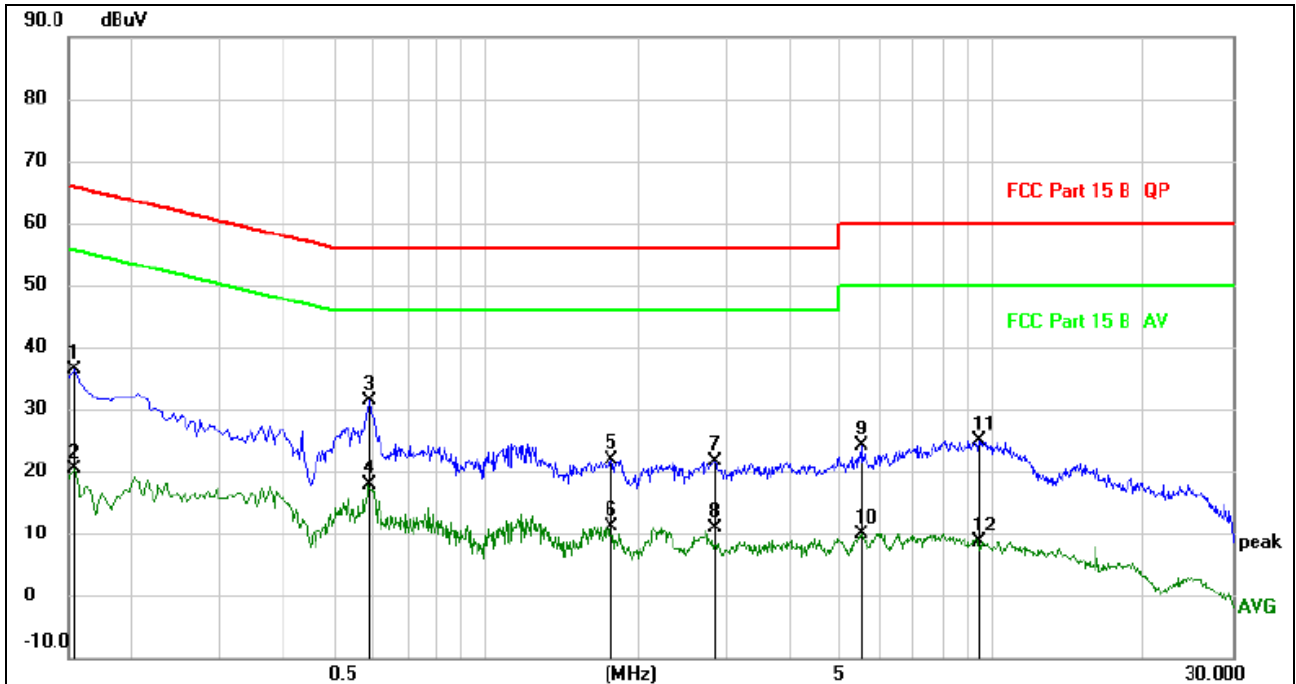

Remark:

1. All readings are Quasi-Peak and Average values.
2. Factor = Insertion Loss + Cable Loss.

No.	Mk.	Freq. MHz	Reading Level dBuV	Correct Factor	Measure- ment dBuV	Limit dBuV	Over dB	Detector	Comment
1		0.1539	26.76	9.52	36.28	65.79	-29.51	QP	
2		0.1539	10.90	9.52	20.42	55.79	-35.37	AVG	
3	*	0.5899	21.38	9.96	31.34	56.00	-24.66	QP	
4		0.5899	8.02	9.96	17.98	46.00	-28.02	AVG	
5		1.7740	12.26	9.59	21.85	56.00	-34.15	QP	
6		1.7740	1.49	9.59	11.08	46.00	-34.92	AVG	
7		2.8460	11.91	9.65	21.56	56.00	-34.44	QP	
8		2.8460	1.18	9.65	10.83	46.00	-35.17	AVG	
9		5.5300	14.46	9.78	24.24	60.00	-35.76	QP	
10		5.5300	0.15	9.78	9.93	50.00	-40.07	AVG	
11		9.4580	15.29	9.70	24.99	60.00	-35.01	QP	
12		9.4580	-0.98	9.70	8.72	50.00	-41.28	AVG	

4.2 RADIATED EMISSION MEASUREMENT

4.2.1 RADIATED EMISSION LIMITS (Frequency Range 9kHz-1000MHz)

20dBc in any 100 kHz bandwidth outside the operating frequency band. In case the emission fall within the restricted band specified on 15.205(a), then the 15.209(a) limit in the table below has to be followed.

Frequencies (MHz)	Field Strength (micorvolts/meter)	Measurement Distance (meters)
0.009~0.490	2400/F(KHz)	300
0.490~1.705	24000/F(KHz)	30
1.705~30.0	30	30
30~88	100	3
88~216	150	3
216~960	200	3
Above 960	500	3

LIMITS OF RADIATED EMISSION MEASUREMENT (Above 1000MHz)

FREQUENCY (MHz)	Limit (dBuV/m) (at 3M)	
	PEAK	AVERAGE
Above 1000	74	54

Notes:

- (1) The limit for radiated test was performed according to FCC PART 15C.
- (2) The tighter limit applies at the band edges.
- (3) Emission level (dBuV/m)=20log Emission level (uV/m).

FREQUENCY RANGE OF RADIATED MEASUREMENT (For unintentional radiators)

Highest frequency generated or Upper frequency of measurement used in the device or on which the device operates or tunes (MHz)	Range (MHz)
Below 1.705	30
1.705 – 108	1000
108 – 500	2000
500 – 1000	5000
Above 1000	5 th harmonic of the highest frequency or 40 GHz, whichever is lower

Spectrum Parameter	Setting
--------------------	---------

Attenuation	Auto
Start Frequency	1000 MHz
Stop Frequency	10th carrier harmonic
RB / VB (emission in restricted band)	1 MHz / 1 MHz for Peak, 1 MHz / 10Hz for Average

Receiver Parameter	Setting
Attenuation	Auto
Start ~ Stop Frequency	9kHz~150kHz / RB 200Hz for QP
Start ~ Stop Frequency	150kHz~30MHz / RB 9kHz for QP
Start ~ Stop Frequency	30MHz~1000MHz / RB 120kHz for QP

4.2.2 TEST PROCEDURE

- The measuring distance of at 3 m shall be used for measurements at frequency up to 25GHz. For frequencies above 1GHz, any suitable measuring distance may be used.
- The EUT was placed on the top of a rotating table 0.8 meters above the ground at a 3 meter semi-chamber test. The table was rotated 360 degrees to determine the position of the highest radiation.
- The height of the equipment or of the substitution antenna shall be 0.8m; above 1GHz, the height was 1.5m, the height of the test antenna shall vary between 1 m to 4 m. Both horizontal and vertical polarizations of the antenna are set to make the measurement.
- The initial step in collecting conducted emission data is a spectrum analyzer peak detector mode pre-scanning the measurement frequency range. Significant peaks are then marked and then Quasi Peak detector mode re-measured.
- If the Peak Mode measured value compliance with and lower than Quasi Peak Mode Limit, the EUT shall be deemed to meet QP Limits and then no additional QP Mode measurement performed.
- For the actual test configuration, please refer to the related Item –EUT Test Photos.
- For the radiated emission test above 1GHz:
Place the measurement antenna away from each area of the EUT determined to be a source of emissions at the specified measurement distance, while keeping the measurement antenna aimed at the source of emissions at each frequency of significant emissions, with polarization oriented for maximum response.

The measurement antenna may have to be higher or lower than the EUT, depending on the radiation pattern of the emission and staying aimed at the emission source for receiving the maximum signal. The final measurement antenna elevation shall be that which maximizes the emissions. The measurement antenna elevation for maximum emissions shall be restricted to a range of heights of from 1 m to 4 m above the ground or reference ground plane.

Note:

Both horizontal and vertical antenna polarities were tested and performed pretest to three orthogonal axis. The worst case emissions were reported

4.2.3 DEVIATION FROM TEST STANDARD

No deviation

4.2.4 TEST SETUP



(A) Radiated Emission Test-Up Frequency Below 30MHz

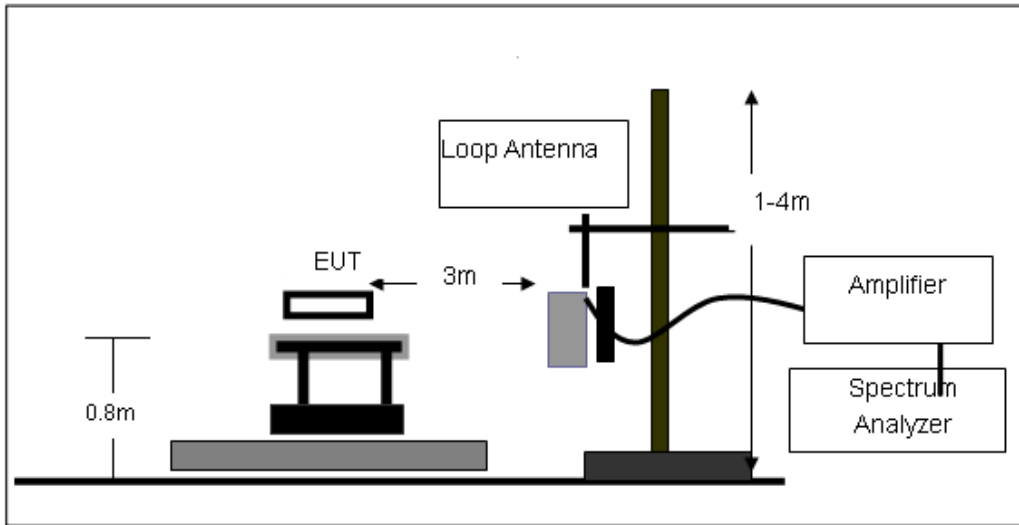

(B) Radiated Emission Test-Up Frequency 30MHz~1GHz

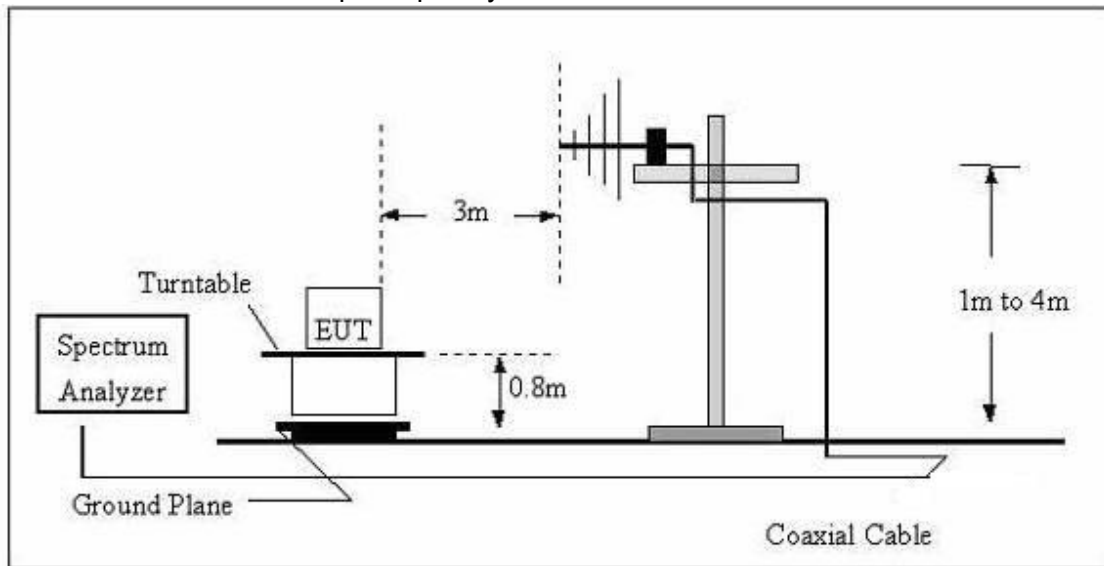

(C) Radiated Emission Test-Up Frequency Above 1GHz

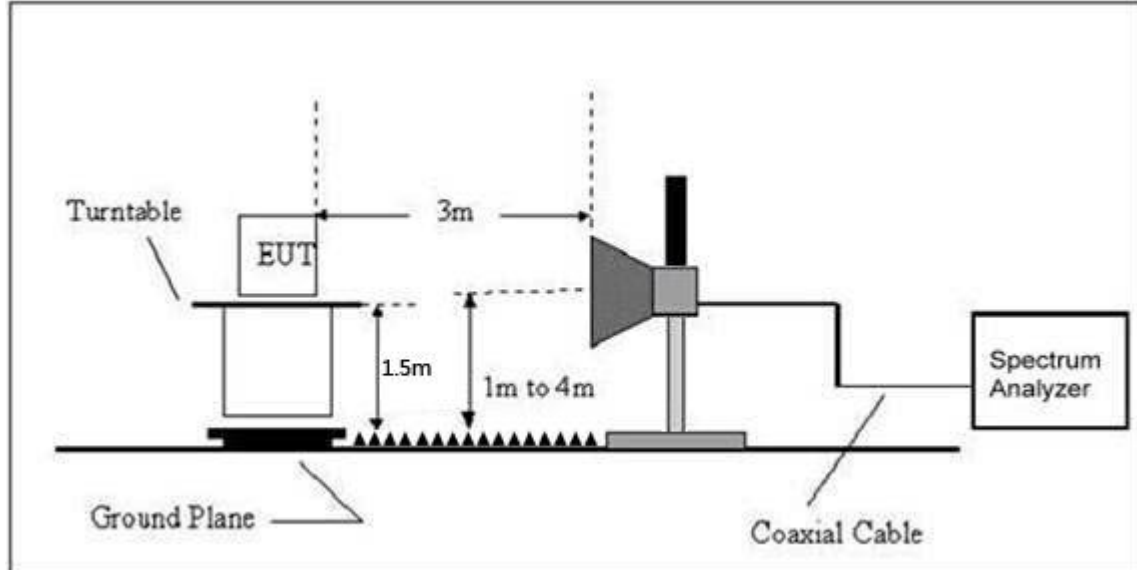

4.2.5 EUT OPERATING CONDITIONS

The EUT tested system was configured as the statements of 2.4 Unless otherwise a special operating condition is specified in the follows during the testing.



4.2.6 TEST RESULTS (BETWEEN 9KHZ – 30 MHZ)

Temperature:	26℃	Relative Humidity:	54%
Pressure:	101kPa	Test Voltage :	DC 3V
Test Mode :	Mode 4	Polarization :	--

Freq.	Reading	Limit	Margin	Detector Type	State
(KHz)	(dBuV/m)	(dBuV/m)	(dB)		P/F
51.6970	39.42	140.88	-81.31	PK	PASS
51.6970	36.17	120.88	-64.56	AV	PASS
125.0426	50.66	133.11	-62.12	PK	PASS
125.0426	46.38	113.11	-46.40	AV	PASS
320.3000	68.22	124.07	-35.30	PK	PASS
320.3000	63.68	104.07	-19.84	AV	PASS
1685.3600	31.33	70.89	-18.92	QP	PASS
1968.5500	35.18	67.88	-11.44	QP	PASS

NOTE:

The amplitude of spurious emissions which are attenuated by more than 20dB below the permissible value has no need to be reported.

Distance extrapolation factor = 40 log (specific distance/test distance)(dB);

Limit line = specific limits(dBuv) + distance extrapolation factor.

4.2.7 TEST RESULTS (BETWEEN 30MHZ – 1GHZ)

Temperature :	26°C	Relative Humidity :	54%
Test Voltage :	DC 3V	Polarization :	Horizontal
Test Mode :	Mode 4		

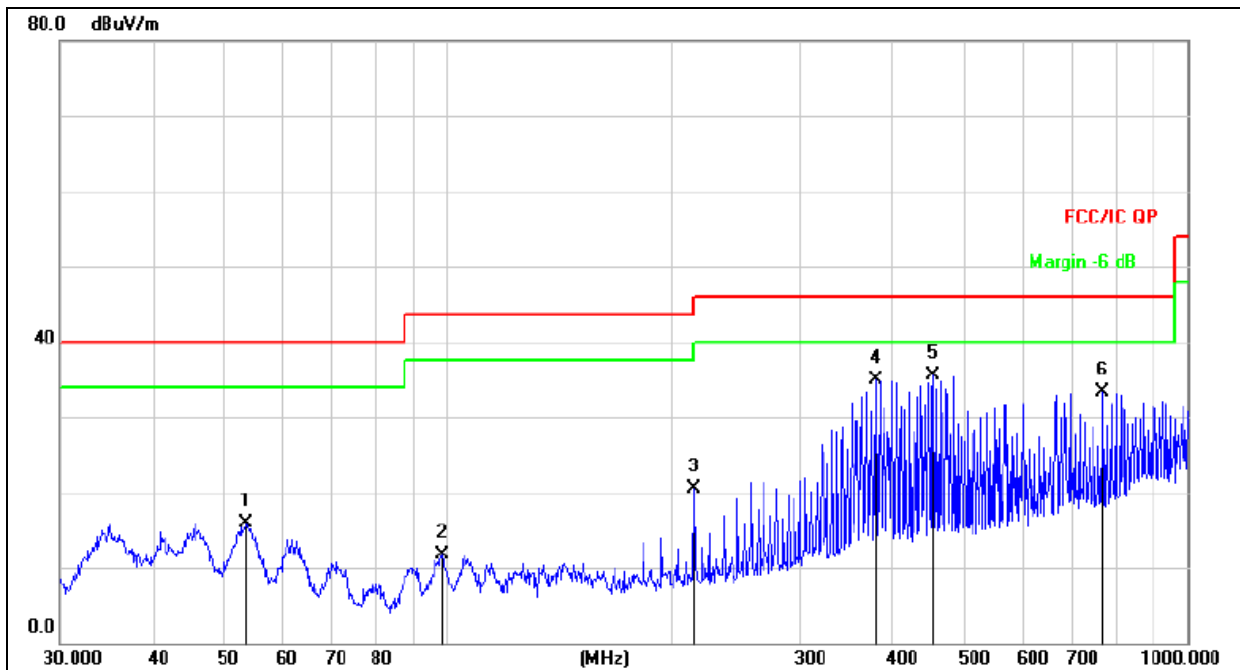

Remark:
Factor = Antenna Factor + Cable Loss – Pre-amplifier.

No.	Mk.	Freq. MHz	Reading Level dBuV	Correct Factor dB	Measure- ment dBuV/m	Limit dB/m	Over dB	Detector
1		53.5052	31.22	-15.22	16.00	40.00	-24.00	QP
2		98.4866	28.17	-16.56	11.61	43.50	-31.89	QP
3		215.2678	36.36	-15.95	20.41	43.50	-23.09	QP
4		378.5843	46.57	-11.58	34.99	46.00	-11.01	QP
5	*	452.7197	45.34	-9.91	35.43	46.00	-10.57	QP
6		768.7481	37.39	-4.08	33.31	46.00	-12.69	QP



Temperature :	26°C	Relative Humidity :	54%
Test Voltage :	DC 3V	Polarization :	Vertical
Test Mode :	Mode 4		

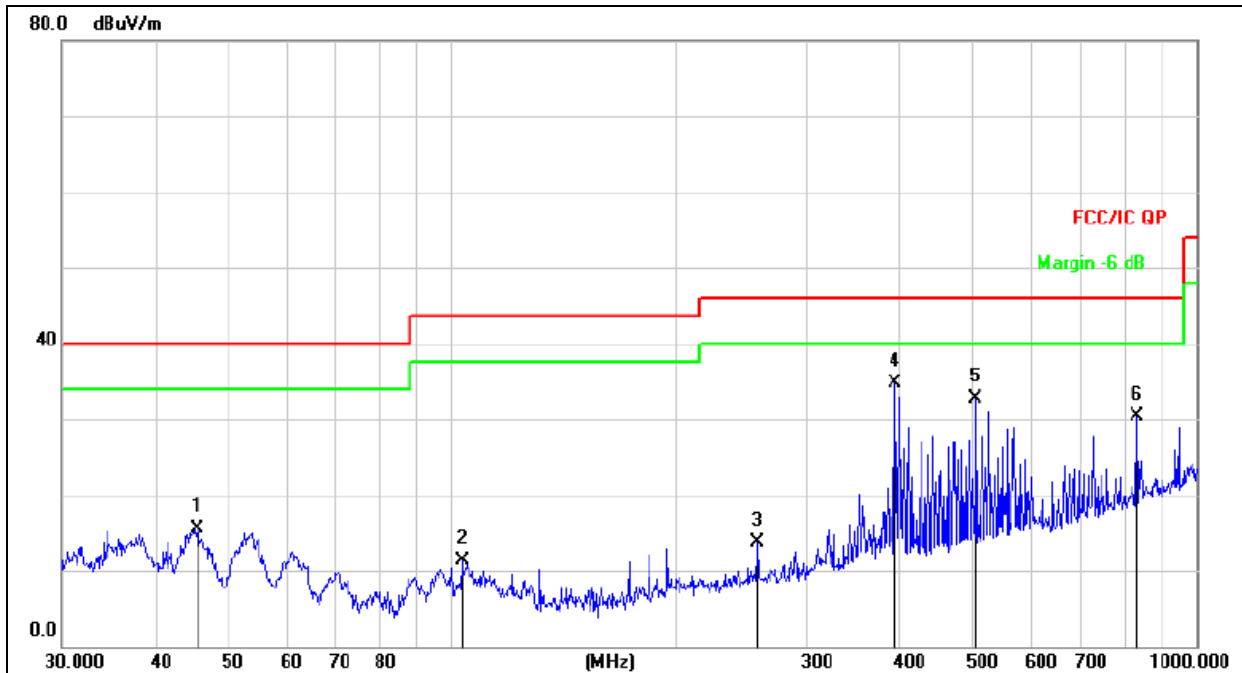

Remark:
Factor = Antenna Factor + Cable Loss – Pre-amplifier.

No.	Mk.	Freq. MHz	Reading Level dBuV	Correct Factor dB	Measure- ment dBuV/m	Limit dB/m	Over dB	Detector
1		45.5348	30.66	-15.10	15.56	40.00	-24.44	QP
2		103.0800	27.80	-16.48	11.32	43.50	-32.18	QP
3		257.4222	28.62	-14.92	13.70	46.00	-32.30	QP
4	*	393.4723	45.90	-11.24	34.66	46.00	-11.34	QP
5		504.7062	41.47	-8.82	32.65	46.00	-13.35	QP
6		830.4002	33.29	-2.96	30.33	46.00	-15.67	QP

4.2.8 TEST RESULTS (1ghz~25ghz)

GFSK

Polar (H/V)	Frequency	Meter Reading	Pre-amplifier	Cable Loss	Antenna Factor	Emission Level	Limits	Margin	Detector Type
	(MHz)	(dBuV)	(dB)	(dB)	(dB)	(dBuV/m)	(dBuV/m)	(dB)	
Low Channel:2410MHz									
V	4820.00	54.86	39.55	7.85	25.66	48.82	74.00	-25.18	PK
V	4820.00	43.99	39.55	7.85	25.66	37.95	54.00	-16.05	AV
V	7230.00	52.44	38.33	7.52	24.55	46.18	74.00	-27.82	PK
V	7230.00	43.72	38.33	7.52	24.55	37.46	54.00	-16.54	AV
V	15450.00	53.36	35.23	6.75	26.59	51.47	74.00	-22.53	PK
H	4820.00	52.36	39.55	7.85	25.66	46.32	74.00	-27.68	PK
H	4820.00	43.02	39.55	7.85	25.66	36.98	54.00	-17.02	AV
H	7230.00	50.92	38.33	7.52	23.55	43.66	74.00	-30.34	PK
H	7230.00	43.75	38.33	7.52	23.22	36.16	54.00	-17.84	AV
H	15450.00	54.78	35.45	6.75	27.88	53.96	74.00	-20.04	PK

Polar (H/V)	Frequency	Meter Reading	Pre-amplifier	Cable Loss	Antenna Factor	Emission Level	Limits	Margin	Detector Type
	(MHz)	(dBuV)	(dB)	(dB)	(dB)	(dBuV/m)	(dBuV/m)	(dB)	
Middle Channel:2440MHz									
V	4880.00	54.05	38.89	7.57	25.45	48.18	74.00	-25.82	PK
V	4880.00	43.54	38.89	7.57	25.45	37.67	54.00	-16.33	AV
V	7320.00	54.89	38.78	7.35	24.78	48.24	74.00	-25.76	PK
V	7320.00	43.25	38.78	7.35	24.78	36.60	54.00	-17.40	AV
V	15450.00	51.08	35.89	6.42	26.47	48.08	74.00	-25.92	PK
H	4880.00	51.66	38.89	7.57	25.45	45.79	74.00	-28.21	PK
H	4880.00	43.07	38.89	7.57	25.45	37.20	54.00	-16.80	AV
H	7320.00	51.10	38.78	7.35	24.78	44.45	74.00	-29.55	PK
H	7320.00	43.62	38.78	7.35	24.78	36.97	54.00	-17.03	AV
H	15450.00	51.24	36.68	6.42	26.65	47.63	74.00	-26.37	PK

Polar (H/V)	Frequency	Meter Reading	Pre-amplifier	Cable Loss	Antenna Factor	Emission Level	Limits	Margin	Detector Type
	(MHz)	(dBuV)	(dB)	(dB)	(dB)	(dBuV/m)	(dBuV/m)	(dB)	
High Channel: 2470MHz									
V	4940.00	53.00	38.75	7.46	25.45	47.16	74.00	-26.84	PK
V	4940.00	43.37	38.75	7.46	25.45	37.53	54.00	-16.47	AV
V	7410.00	50.48	38.65	7.22	24.78	43.83	74.00	-30.17	PK
V	7410.00	43.77	38.65	7.22	24.78	37.12	54.00	-16.88	AV
V	15450.00	50.54	35.58	6.35	26.47	47.78	74.00	-26.22	PK
H	4940.00	52.75	38.75	7.46	25.45	46.91	74.00	-27.09	PK
H	4940.00	43.20	38.75	7.46	25.45	37.36	54.00	-16.64	AV
H	7410.00	54.63	38.65	7.22	24.78	47.98	74.00	-26.02	PK
H	7410.00	43.64	38.65	7.22	24.78	36.99	54.00	-17.01	AV
H	15450.00	51.62	36.42	6.32	26.65	48.17	74.00	-25.83	PK

Remark:

1. Emission Level = Meter Reading + Antenna Factor + Cable Loss – Pre-amplifier,

Margin= Emission Level - Limit

2. If peak below the average limit, the average emission was no test.

3. The amplitude of spurious emissions which are attenuated by more than 20dB below the permissible value has no need to be reported.

3.3 RADIATED BAND EMISSION MEASUREMENT

3.3.1 TEST REQUIREMENT:

FCC Part15 C Section 15.209 and 15.205

LIMITS OF RADIATED EMISSION MEASUREMENT (Above 1000MHz)

FREQUENCY (MHz)	Limit (dBuV/m) (at 3M)	
	PEAK	AVERAGE
Above 1000	74	54

Notes:

- (1) The limit for radiated test was performed according to FCC PART 15C.
- (2) The tighter limit applies at the band edges.
- (3) Emission level (dBuV/m)=20log Emission level (uV/m).

Spectrum Parameter	Setting
Attenuation	Auto
Start Frequency	2300MHz
Stop Frequency	2520
RB / VB (emission in restricted band)	1 MHz / 1 MHz for Peak, 1 MHz / 10Hz for Average

3.3.2 TEST PROCEDURE

Above 1GHz test procedure as below:

- a. 1. The EUT was placed on the top of a rotating table 1.5 meters above the ground at a 3 meter camber. The table was rotated 360 degrees to determine the position of the highest radiation.
- b. The EUT was set 3 meters away from the interference-receiving antenna, which was mounted on the top of a variable-height antenna tower.
- c. The antenna height is varied from one meter to four meters above the ground to determine the maximum value of the field strength. Both horizontal and vertical polarizations of the antenna are set to make the measurement.
- d. For each suspected emission, the EUT was arranged to its worst case and then the antenna was tuned to heights from 1 meter to 4 meters and the rota table was turned from 0 degrees to 360 degrees to find the maximum reading.
- e. The test-receiver system was set to Peak Detect Function and Specified Bandwidth with Maximum Hold Mode.
- f. If the emission level of the EUT in peak mode was 10dB lower than the limit specified, then testing could be stopped and the peak values of the EUT would be reported. Otherwise the emissions that did not have 10dB margin would be re-tested one by one using peak, quasi-peak or average method as specified and then reported in a data sheet.
- g. Test the EUT in the lowest channel, the Highest channel

Note:

Both horizontal and vertical antenna polarities were tested and performed pretest to three orthogonal axis. The worst case emissions were reported

3.3.3 DEVIATION FROM TEST STANDARD

No deviation

3.3.4 TEST SETUP

Radiated Emission Test-Up Frequency Above 1GHz

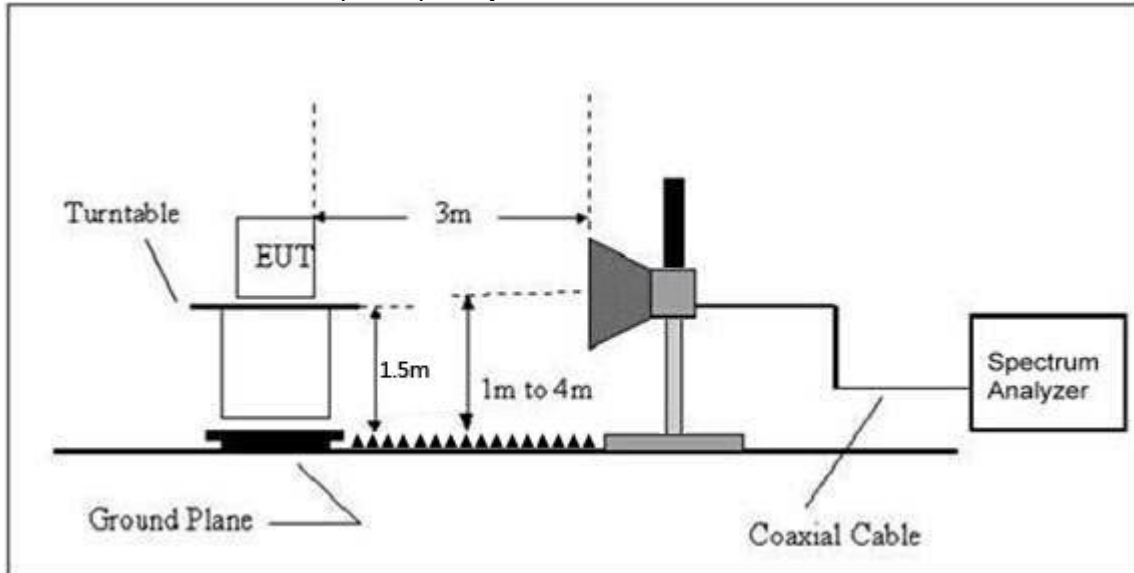

3.3.5 EUT OPERATING CONDITIONS

The EUT tested system was configured as the statements of 2.3 Unless otherwise a special operating condition is specified in the follows during the testing.



3.3.6 TEST RESULT

	Polar (H/V)	Frequency (MHz)	Meter Reading (dBuV)	Pre-amplifier (dB)	Cable Loss (dB)	Antenna Factor (dB/m)	Emission level (dBuV/m)	Limits (dBuV/m)		Result
							PK	PK	AV	
GFSK	Low Channel 2410MHz									
	H	2390.00	64.28	38.06	7.42	20.15	53.79	74.00	54.00	PASS
	H	2400.00	51.59	38.06	7.42	20.15	41.10	74.00	54.00	PASS
	V	2390.00	64.11	38.06	7.42	20.15	53.62	74.00	54.00	PASS
	V	2400.00	54.84	38.06	7.42	20.15	44.35	74.00	54.00	PASS
	High Channel 2470MHz									
	H	2483.50	61.24	38.17	7.45	20.54	51.06	74.00	54.00	PASS
	H	2485.50	51.37	38.17	7.45	20.54	41.19	74.00	54.00	PASS
	V	2483.50	63.48	38.2	7.45	20.54	53.27	74.00	54.00	PASS
	V	2485.50	53.52	38.2	7.45	20.54	43.31	74.00	54.00	PASS
Remark:										
1. Emission Level = Meter Reading + Antenna Factor + Cable Loss – Pre-amplifier, Margin= Emission Level - Limit										
2. If the PK measured levels comply with average limit, then the average level were deemed to comply with average limit.										

5. POWER SPECTRAL DENSITY TEST

5.1 APPLIED PROCEDURES / LIMIT

FCC Part15 (15.247) , Subpart C				
Section	Test Item	Limit	Frequency Range (MHz)	Result
15.247	Power Spectral Density	8 dBm (in any 3KHz)	2400-2483.5	PASS

5.1.1 TEST PROCEDURE

1. Set analyzer center frequency to DTS channel center frequency.
2. Set the span to 1.5 times the DTS bandwidth.
3. Set the RBW to: $3 \text{ kHz} \leq \text{RBW} \leq 100 \text{ kHz}$.
4. Set the VBW $\geq 3 \times \text{RBW}$.
5. Detector = peak.
6. Sweep time = auto couple.
7. Trace mode = max hold.
8. Allow trace to fully stabilize.
9. Use the peak marker function to determine the maximum amplitude level within the RBW.
10. If measured value exceeds limit, reduce RBW (no less than 3 kHz) and repeat.

5.1.2 DEVIATION FROM STANDARD

No deviation.

5.1.3 TEST SETUP



5.1.4 EUT OPERATION CONDITIONS

The EUT tested system was configured as the statements of 2.1 Unless otherwise a special operating condition is specified in the follows during the testing.

Note: Power Spectral Density(dBm)=Reading+Cable Loss

5.1.5 TEST RESULTS

Temperature :	26°C	Relative Humidity :	54%
Test Mode :	GFSK	Test Voltage :	DC 3V

Frequency	Power Spectral Density(dBm)	Limit (dBm)	Result
2410 MHz	-21.071	8	PASS
2440 MHz	-21.429	8	PASS
2470 MHz	-21.614	8	PASS

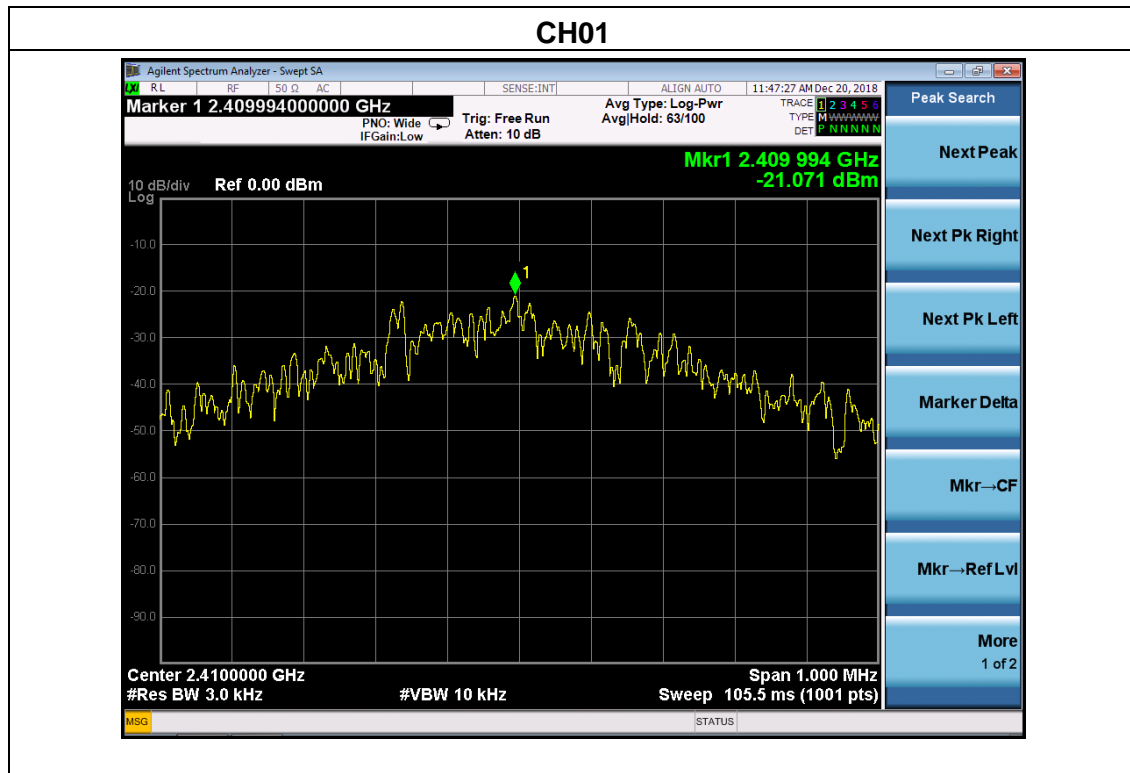



CH31



CH61

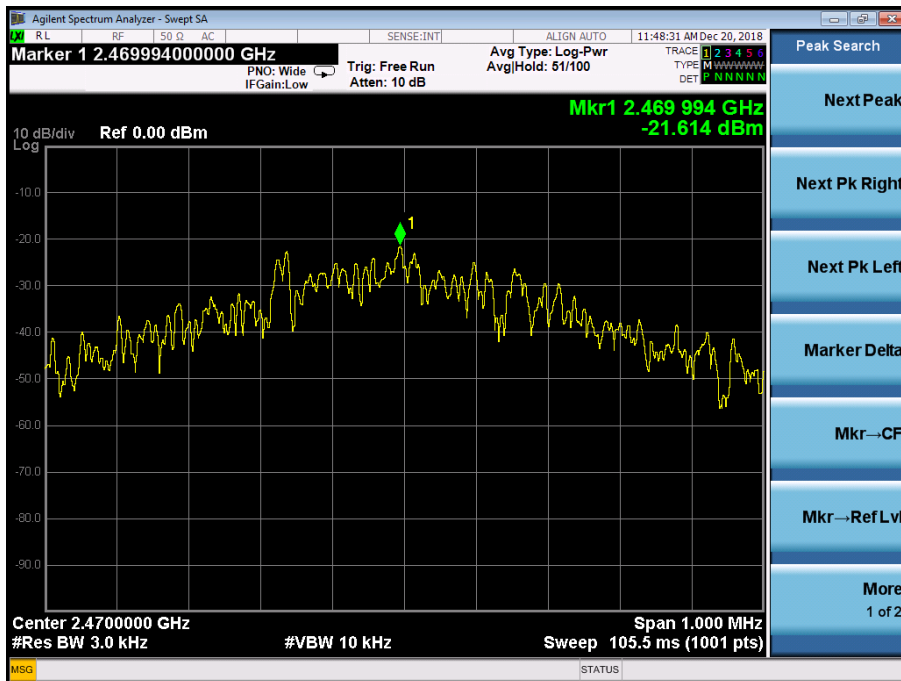

6. BANDWIDTH TEST

6.1 APPLIED PROCEDURES / LIMIT

FCC Part15 (15.247) , Subpart C				
Section	Test Item	Limit	Frequency Range (MHz)	Result
15.247(a)(2)	Bandwidth	$\geq 500\text{KHz}$ (6dB bandwidth)	2400-2483.5	PASS

6.1.1 TEST PROCEDURE

1. Set RBW = 100 kHz.
2. Set the video bandwidth (VBW) $\geq 3 \times$ RBW.
3. Detector = Peak.
4. Trace mode = max hold.
5. Sweep = auto couple.
6. Allow the trace to stabilize.
7. Measure the maximum width of the emission that is constrained by the frequencies associated with the two outermost amplitude points (upper and lower frequencies) that are attenuated by 6 dB relative to the maximum level measured in the fundamental emission.

6.1.2 DEVIATION FROM STANDARD

No deviation.

6.1.3 TEST SETUP

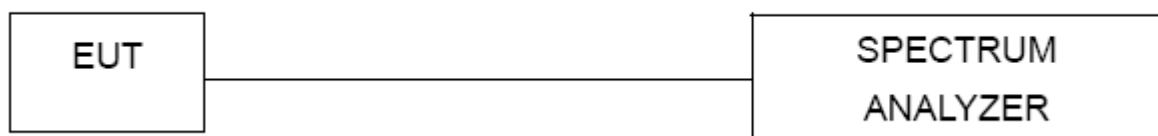

6.1.4 EUT OPERATION CONDITIONS

The EUT tested system was configured as the statements of 2.4 Unless otherwise a special operating condition is specified in the follows during the testing.

6.1.5 TEST RESULTS

Temperature :	26°C	Relative Humidity :	54%
Test Mode :	GFSK	Test Voltage :	DC 3V

Frequency (MHz)	6dB bandwidth (MHz)	Limit (kHz)	Result
2410	0.661	500	Pass
2440	0.667	500	Pass
2470	0.665	500	Pass

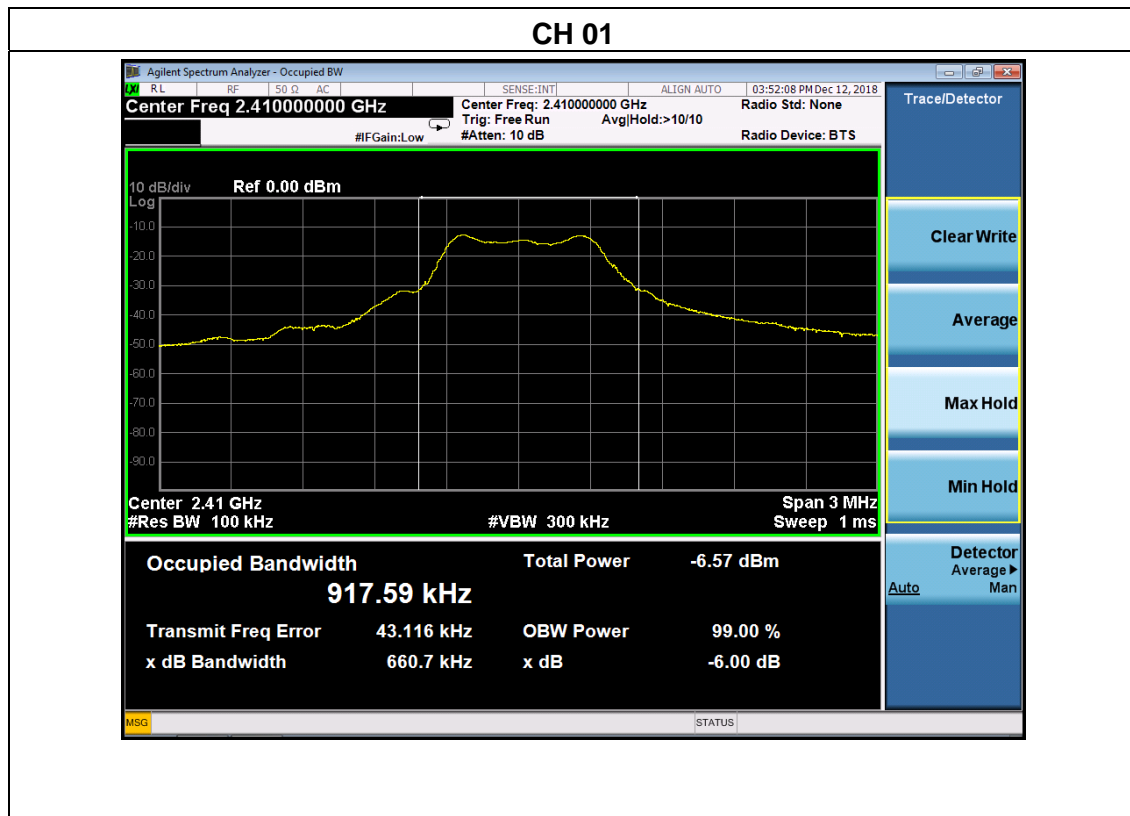



CH31

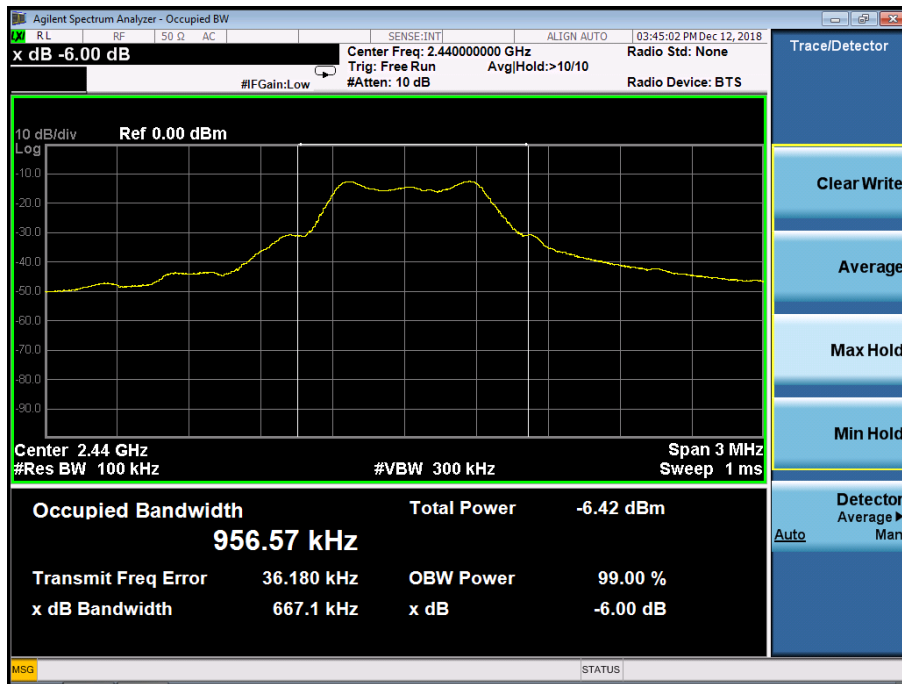

CH61

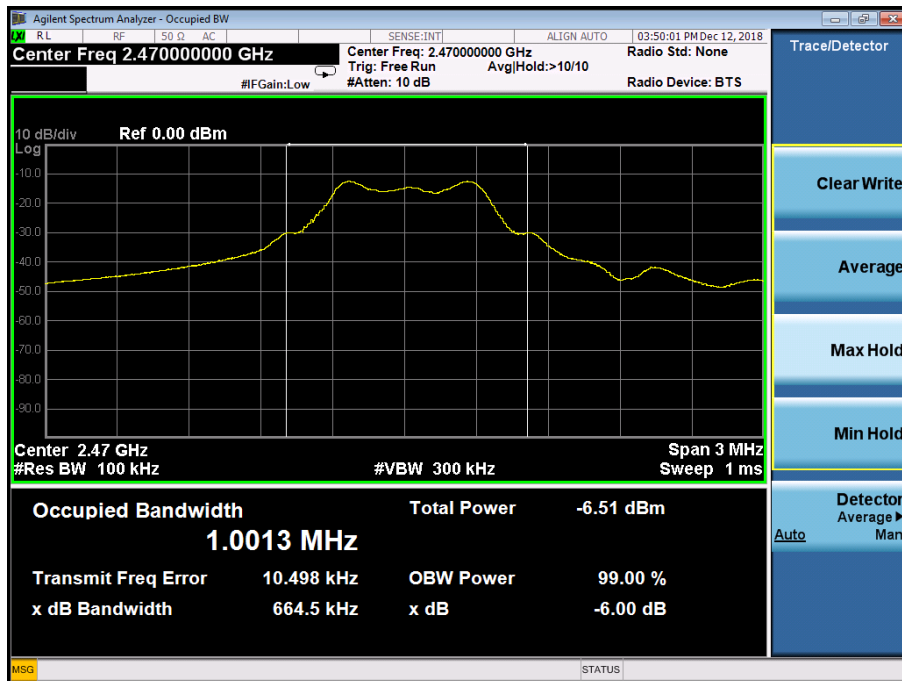

7. PEAK OUTPUT POWER TEST

7.1 APPLIED PROCEDURES / LIMIT

FCC Part15 (15.247) , Subpart C				
Section	Test Item	Limit	Frequency Range (MHz)	Result
15.247(b)(3)	Peak Output Power	1 watt or 30dBm	2400-2483.5	PASS

7.1.1 TEST PROCEDURE

- a. The EUT was directly connected to the Power meter

7.1.2 DEVIATION FROM STANDARD

No deviation.

7.1.3 TEST SETUP



7.1.4 EUT OPERATION CONDITIONS

The EUT tested system was configured as the statements of 2.4 Unless otherwise a special operating condition is specified in the follows during the testing.



7.1.5 TEST RESULTS

Temperature :	26°C	Relative Humidity :	54%
Test Voltage :	DC 3V		

	Frequency	Maximum Conducted Output Power(PK)	Conducted Output Power Limit
	(MHz)	(dBm)	dBm
GFSK	2410	-15.258	30
	2440	-14.062	30
	2470	-15.932	30



8. 100 KHZ BANDWIDTH OF FREQUENCY BAND EDGE

7.1 APPLICABLE STANDARD

In any 100 kHz bandwidth outside the frequency band in which the spread spectrum intentional radiator is operating, the radio frequency power that is produced by the intentional radiator shall be at least 20 dB below that in the 100 kHz bandwidth within the band that contains the highest level of the desired power, based on either an RF conducted or a radiated measurement.

7.2 TEST PROCEDURE

Using the following spectrum analyzer setting:

- a) Set the RBW = 100KHz.
- b) Set the VBW = 300KHz.
- c) Sweep time = auto couple.
- d) Detector function = peak.
- e) Trace mode = max hold.
- f) Allow trace to fully stabilize.

7.3 DEVIATION FROM STANDARD

No deviation.

7.4 TEST SETUP

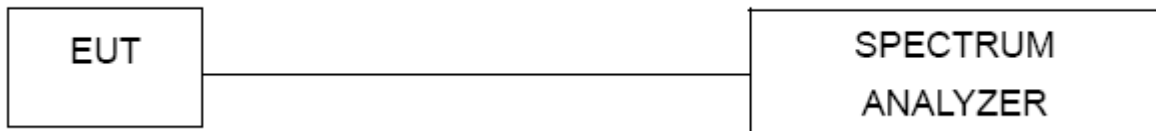

7.5 EUT OPERATION CONDITIONS

The EUT tested system was configured as the statements of 2.4 Unless otherwise a special operating condition is specified in the follows during the testing.

7.6 TEST RESULTS



GFSK: Band Edge, Left Side

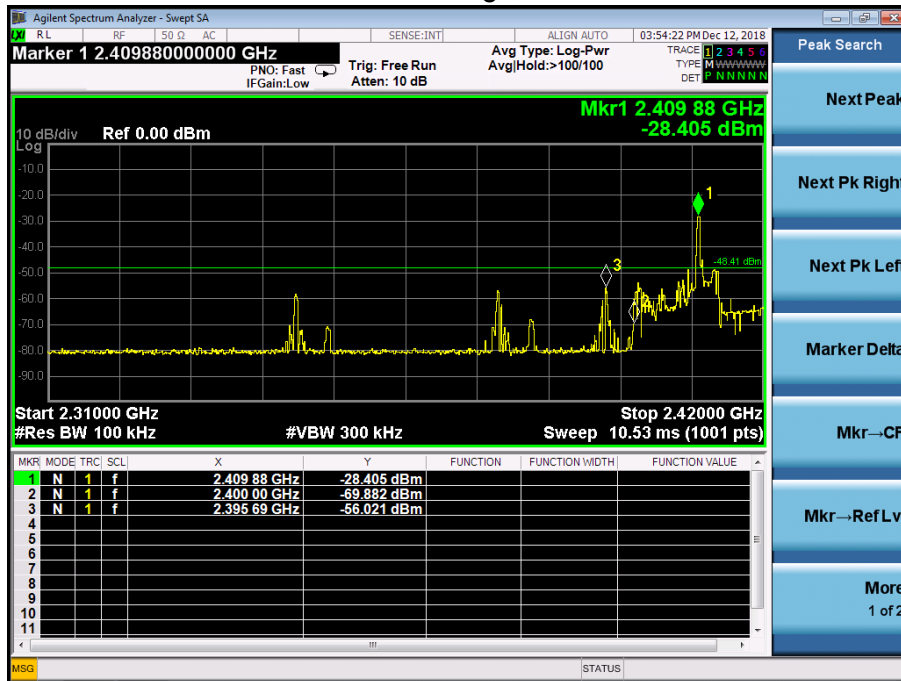

GFSK: Band Edge, Right Side





CONDUCTED EMISSION MEASUREMENT

GFSK

Low Channel 2410MHz

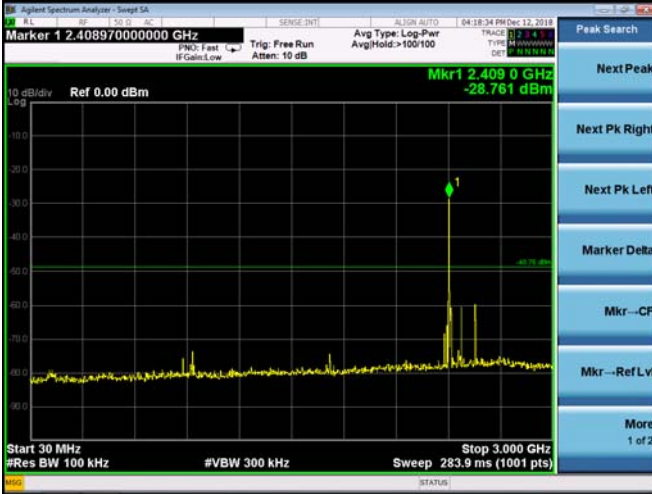

Middle Channel 2440MHz

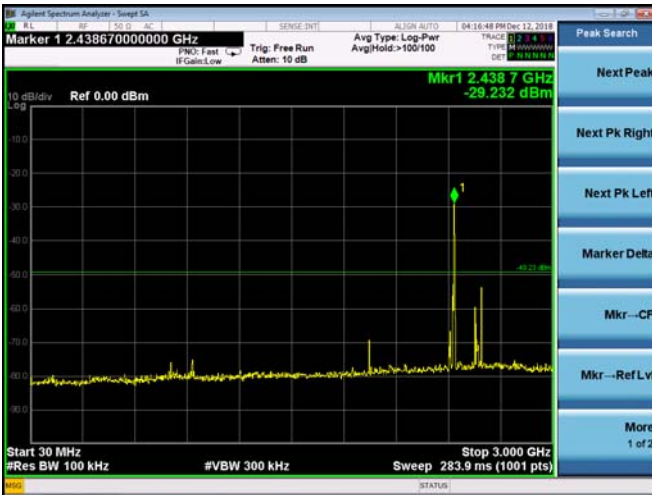

High Channel 2470MHz

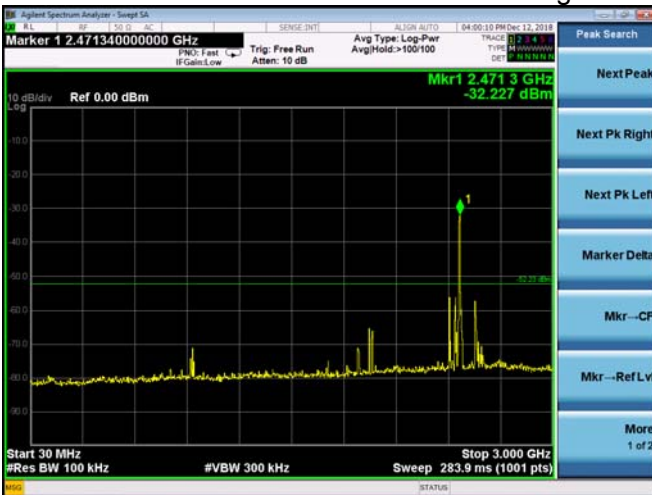



9. ANTENNA REQUIREMENT

9.1 STANDARD REQUIREMENT

15.203 requirement: For intentional device, according to 15.203: an intentional radiator shall be designed to ensure that no antenna other than that furnished by the responsible party shall be used with the device.

9.2 EUT ANTENNA

The EUT antenna is External Antenna, fulfill the requirement of this section.

10. EUT TEST PHOTO

Conducted Measurement Photos



Radiated Measurement Photos



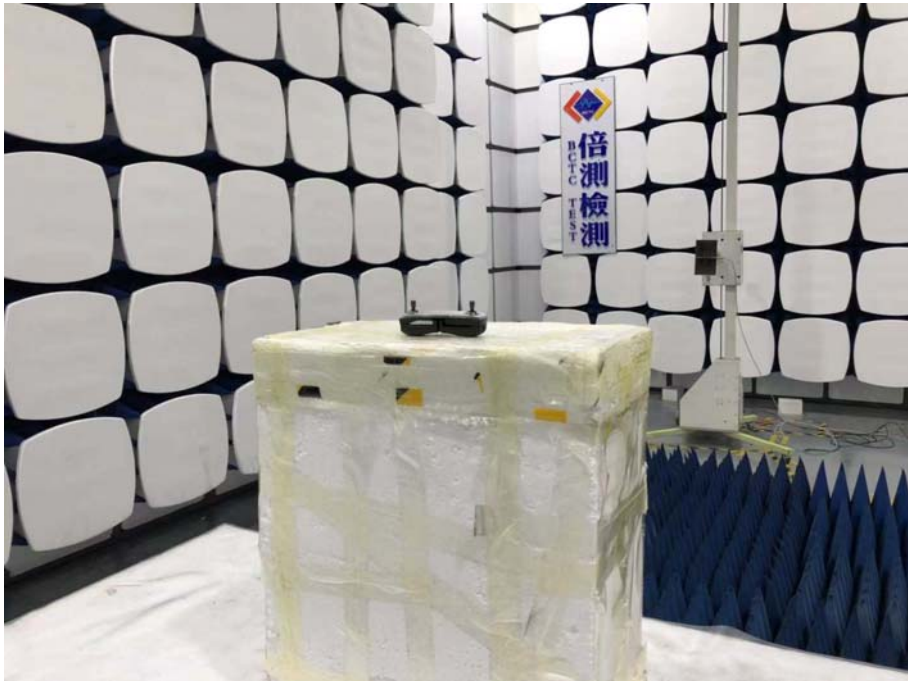



11. EUT PHOTO



***** END OF REPORT *****