



FCC TEST REPORT

**Test report
On Behalf of
Innova Ideas Limited
For
Bluetooth Smart Padlock
Model No.: LE-01-5.2**

FCC ID: 2AR3KPLBC00001

Prepared for : Innova Ideas Limited
Unit 502, 5/F, Hang Seng North Point Building, 341 King's Road, North Point,
Hong Kong

Prepared By : Shenzhen HUAKE Testing Technology Co., Ltd.
1-2/F, Building 19, Junfeng Industrial Park, Chongqing Road, Heping
Community, Fuhai Street, Bao'an District, Shenzhen, Guangdong, China

Date of Test: Jan. 21, 2019 ~ Jan. 29, 2019

Date of Report: Jan. 30, 2019

Report Number: HK1812171904E01



TEST RESULT CERTIFICATION

Applicant's name: Innova Ideas Limited
 Address.....: Unit 502, 5/F, Hang Seng North Point Building, 341 King's Road, North Point, Hong Kong
Manufacture's Name.....: Innova Ideas Limited
 Address.....: Unit 502, 5/F, Hang Seng North Point Building 341 King's Road, North Point, Hong Kong
Factory's Name: Dongguan Qingxi Kwong Wah Lock Mfy Co Ltd.
 Address: JinQiao Industrial Estate, 221 Qing Feng Rd, Qingxi, Dongguan, Guangdong, China 523653

Product description

Trade Mark:..... Mokoo
 ProductName.....: Bluetooth Smart Padlock
 Model and/or type reference...: LE-01-5.2

Standards.....: FCC Rules and Regulations Part 15 Subpart C Section 15.247
 ANSI C63.10: 2013

This publication may be reproduced in whole or in part for non-commercial purposes as long as the Shenzhen HUAK Testing Technology Co., Ltd. is acknowledged as copyright owner and source of the material. Shenzhen HUAK Testing Technology Co., Ltd. takes no responsibility for and will not assume liability for damages resulting from the reader's interpretation of the reproduced material due to its placement and context.

Date of Test:
 Date (s) of performance of tests.....: Jan. 21, 2019 ~ Jan. 29, 2019
 Date of Issue.....: Jan. 30, 2019
 Test Result.....: **Pass**

Testing Engineer : 
 (Gary Qian)

Technical Manager : 
 (Eden Hu)

Authorized Signatory : 
 (Jason Zhou)



Table of Contents	Page
1 . TEST SUMMARY	5
2 . GENERAL INFORMATION	6
2.1 . GENERAL DESCRIPTION OF EUT	6
2.2 . CARRIER FREQUENCY OF CHANNELS	7
2.3 . OPERATION OF EUT DURING TESTING	7
2.4 . DESCRIPTION OF TEST SETUP	8
2.5. EQUIPMENT USED IN EUT SYSTEM	8
2.6. MEASUREMENT INSTRUMENTS LIST	9
3. ANTENNA REQUIREMENT	10
4. RADIATED EMISSION	11
4.1 LIMITS	11
4.2 MEASUREMENT PROCEDURE	11
4.3 TEST SETUP	12
4.4 TEST RESULT (Worst Modulation: GFSK)	14
5. BAND EDGE EMISSION	23
5.1. MEASUREMENT PROCEDURE	23
5.2. TEST SET-UP	23
5.3. TEST RESULT	24
6. 6DB BANDWIDTH	28
6.1. TEST PROCEDURE	28
6.2. SUMMARY OF TEST RESULTS/PLOTS	28
7. CONDUCTED OUTPUT POWER	30
7.1. MEASUREMENT PROCEDURE	30
7.2. TEST SET-UP (BLOCK DIAGRAM OF CONFIGURATION)	30
7.3. LIMITS AND MEASUREMENT RESULT	31
8. CONDUCTED SPURIOUS EMISSION	33
8.1. MEASUREMENT PROCEDURE	33
8.2. TEST SET-UP (BLOCK DIAGRAM OF CONFIGURATION)	33
8.3. LIMITS AND MEASUREMENT RESULT	33
9. CONDUCTED OUTPUT POWER SPECTRAL DENSITY	37
9.1 MEASUREMENT PROCEDURE	37
9.2 TEST SET-UP (BLOCK DIAGRAM OF CONFIGURATION)	37
9.3 LIMITS AND MEASUREMENT RESULT	37
10. LINE CONDUCTED EMISSION TEST	40



Table of Contents	Page
10.1 LIMITS	40
10.2 TEST SETUP	40
10.3 PRELIMINARY PROCEDURE	41
10.4 FINAL TEST PROCEDURE	41
10.5 TEST RESULT OF POWER LINE	41
11. ANTENNA REQUIREMENT	42
12. PHOTOGRAPH OF TEST	43
13. PHOTOGRAPHS OF EUT	45



1. TEST SUMMARY

1.1. TEST PROCEDURES AND RESULTS

DESCRIPTION OF TEST	RESULT
Antenna Requirement	COMPLIANT
Radiated Emission	COMPLIANT
Band Edges	COMPLIANT
6 dB Bandwidth	COMPLIANT
Conducted Output Power	COMPLIANT
Conducted Spurious Emission	COMPLIANT
Conducted Power Spectral Density	COMPLIANT
Line Conduction Emission	N/A
Antenna Requirement	COMPLIANT

Note: N/A means it's not applicable to this item.

1.2. TEST FACILITY

Test Firm : Shenzhen HUAKE Testing Technology Co., Ltd.

Address : 1-2/F, Building 19, Junfeng Industrial Park, Chongqing Road, Heping Community, Fuhai Street, Bao'an District, Shenzhen, Guangdong, China

Designation Number: : CN1229

Test Firm Registration Number : 616276

1.3. MEASUREMENT UNCERTAINTY

Measurement Uncertainty

Conducted Emission Expanded Uncertainty = 2.23dB, k=2

Radiated emission expanded uncertainty(9kHz-30MHz) = 3.08dB, k=2

Radiated emission expanded uncertainty(30MHz-1000MHz) = 4.42dB, k=2

Radiated emission expanded uncertainty(Above 1GHz) = 4.06dB, k=2



2. GENERAL INFORMATION

2.1. GENERAL DESCRIPTION OF EUT

Operation Frequency	2.402 GHz to 2.480GHz
RF Output Power	2.490dBm(Max)
Bluetooth Version	V4.2
Modulation	BR <input type="checkbox"/> GFSK, EDR <input type="checkbox"/> π /4-DQPSK, <input type="checkbox"/> 8DPSK BLE <input checked="" type="checkbox"/> GFSK
Number of channels	40 for BLE
Hardware Version	5.2
Software Version	1.11
Antenna Designation	PCB Antenna
Antenna Gain	0dBi
Power Supply	DC 3V by Battery
Note: The USB port only used for charging and can't be used to transfer data with PC.	



2.2. CARRIER FREQUENCY OF CHANNELS

BLE Channel List

Frequency Band	Channel Number	Frequency
2400~2483.5MHz	0	2402MHz
	1	2404MHz
	:	:
	38	2478 MHz
	39	2480 MHz

2.3. OPERATION OF EUT DURING TESTING

NO.	TEST MODE DESCRIPTION
1	Low channel GFSK
2	Middle channel GFSK
3	High channel GFSK
4	BT Link(Hopping mode)

Note: 1. All the test modes can be supply by battery, only the result of the worst case was recorded in the report, if no other cases.
2. For Radiated Emission, 3axis were chosen for testing for each applicable mode.
3. The EUT used fully-charged battery when tested.



2.4. DESCRIPTION OF TEST SETUP

Configure 1: (Normal hopping)



Configure 2: (Control continuous TX)

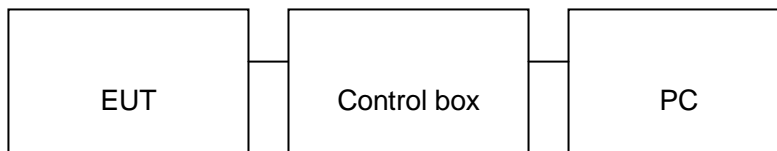

2.5. EQUIPMENT USED IN EUT SYSTEM

Item	Equipment	Mfr/Brand	Model/Type No.	Remark
1	Bluetooth Smart Padlock	Mokoo	LE-01-5.2	EUT
2	Battery	N/A	CR2032	Accessory
3	PC	APPLE	A1465	A.E
4	IPOD	APPLE	A1367	A.E
5	Control box	DOFLY	N/A	A.E
6	USB Cable	N/A	1m unshielded	A.E

**2.6.MEASUREMENT INSTRUMENTS LIST****TEST EQUIPMENT OF RADIATED EMISSION TEST**

Item	Equipment	Manufacturer	Model No.	Lab Equipment No.	Last Cal.	Cal. Interval
1.	Spectrum analyzer	Agilent	N9020A	HKE-048	Dec. 27, 2018	1 Year
2.	Preamplifier	Schwarzbeck	BBV 9743	HKE-006	Dec. 27, 2018	1 Year
3.	EMI Test Receiver	Rohde & Schwarz	ESCI 7	HKE-010	Dec. 27, 2018	1 Year
4.	Bilog Broadband Antenna	Schwarzbeck	VULB9163	HKE-012	Dec. 27, 2018	1 Year
5.	Loop Antenna	Schwarzbeck	FMZB 1519 B	HKE-014	Dec. 27, 2018	1 Year
6.	Horn Antenna	Schwarzbeck	9120D	HKE-013	Dec. 27, 2018	1 Year
7.	Broad-band Horn Antenna	A-INFOMW	LB-180400-K F	HKE-031	Dec. 27, 2018	1 Year
8.	Pre-amplifier	EMCI	EMC051845S E	HKE-015	Dec. 27, 2018	1 Year
9.	Pre-amplifier	Agilent	83051A	HKE-016	Dec. 27, 2018	1 Year
10.	Radiation Cable 1	MXT	HK1	R05	N/A	N/A
11.	Radiation Cable 2	MXT	HK1	R06	N/A	N/A



3. ANTENNA REQUIREMENT

3.1. STANDARD APPLICABLE

According to FCC 15.203, An intentional radiator shall be designed to ensure that no antenna other than that furnished by the responsible party shall be used with the device. The use of a permanently attached antenna or of an antenna that uses a unique coupling to the intentional radiator shall be considered sufficient to comply with the provisions of this Section. The manufacturer may design the unit so that a broken antenna can be replaced by the user, but the use of a standard antenna jack or electrical connector is prohibited. This requirement does not apply to carrier current devices or to devices operated under the provisions of Sections 15.211, 15.213, 15.217, 15.219, or 15.221. Further, this requirement does not apply to intentional radiators that must be professionally installed, such as perimeter protection systems and some field disturbance sensors, or to other intentional radiators which, in accordance with Section 15.31(d), must be measured at the installation site. However, the installer shall be responsible for ensuring that the proper antenna is employed so that the limits in this Part are not exceeded.

3.2. TEST RESULT

This product has a permanent antenna, fulfill the requirement of this section.



4. RADIATED EMISSION

4.1 LIMITS

Frequency (MHz)	Distance Meters	Field Strengths Limit	
		μ V/m	dB(μ V)/m
0.009 ~ 0.490	300	2400/F(kHz)	---
0.490 ~ 1.705	30	24000/F(kHz)	---
1.705 ~ 30	30	30	---
30 ~ 88	3	100	40.0
88 ~ 216	3	150	43.5
216 ~ 960	3	200	46.0
960 ~ 1000	3	500	54.0
Above 1000	3	Other:74.0 dB(μ V)/m (Peak) 54.0 dB(μ V)/m (Average)	

Remark : (1) Emission level dB μ V = 20 log Emission level μ V/m
(2) The smaller limit shall apply at the cross point between two frequency bands.
(3) Distance is the distance in meters between the measuring instrument, antenna and the closest point of any part of the device or system.

4.2 MEASUREMENT PROCEDURE

1. The measuring distance of 3m shall be used for measurements. The EUT was placed on the top of a rotating table 0.8 meter above the ground at a 3 meter semi-anechoic chamber. The table was rotated 360 degrees to determine the position of the highest radiation(Below 1GHz)
2. The measuring distance of 3m shall used for measurements. The EUT was placed on the top of a rotating table 1.5 meter above the ground at a 3 meter semi-anechoic chamber. The table was rotated 360 degrees to determine the position of the highest radiation(Above 1GHz)
3. The height of the test antenna shall vary between 1m to 4m.Both horizontal and vertical polarization Of the antenna are set to make the measurement.
4. The initial step in collecting radiated emission data is a receive peak detector mode. Pre-scanning the measurement frequency range. Significant peaks are then marked and then Quasi Peak detector mode re-measured.
5. All readings are peak unless otherwise stated QP in column of Note. Peak denoted that the Peak reading compliance with the QP limits and then QP Mode measurement didn't perform(Below 1GHz)
- 6.All readings are Peak mode value unless otherwise stated AVG in column of Note. If the Peak mode measured value compliance with the Peak limits and lower than AVG Limits, the EUT shall be deemed to meet Peak&AVG limits and then only Peak mode was measured, but AVG mode didn't perform.(Above 1GHz)



4.3 TEST SETUP

RADIATED EMISSION TEST SETUP BELOW 30MHz

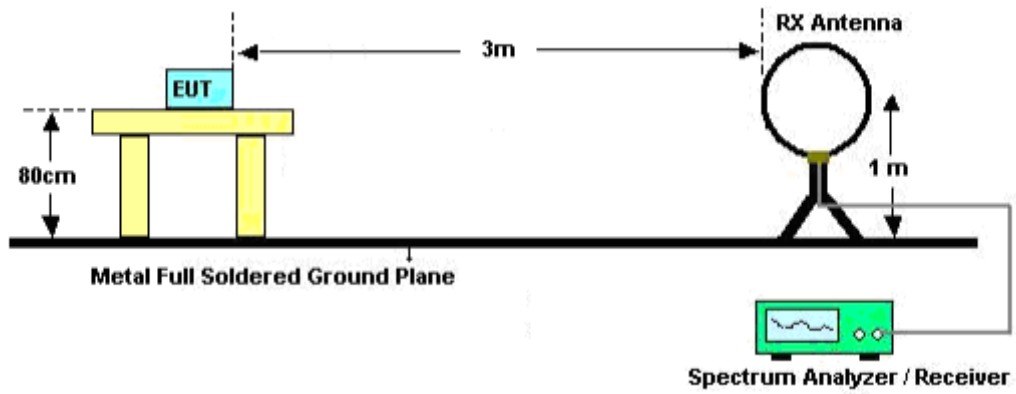

RADIATED EMISSION TEST SETUP 30MHz-1000MHz

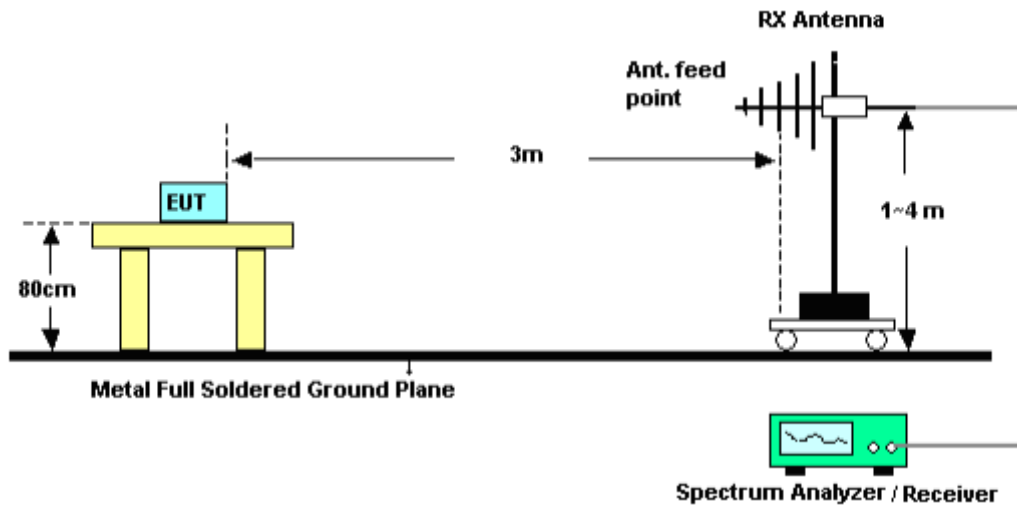



RADIATED EMISSION TEST SETUP ABOVE 1000MHz

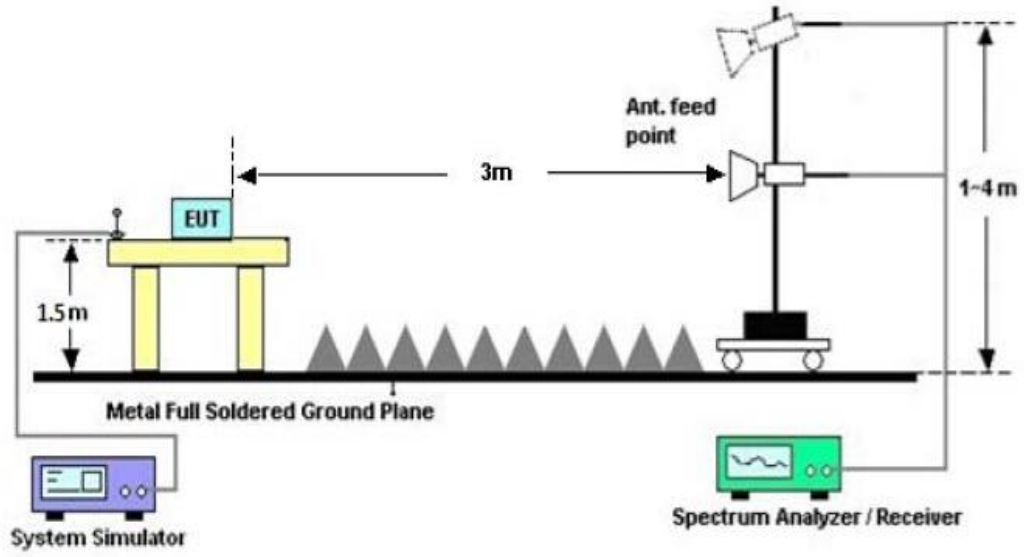



4.4 TEST RESULT

RADIATED EMISSION BELOW 30MHz

No emission found between lowest internal used/generated frequencies to 30MHz.

RADIATED EMISSION BELOW 1GHz

RADIATED EMISSION TEST- (30MHz-1GHz)-LOW CHANNEL-HORIZONTAL

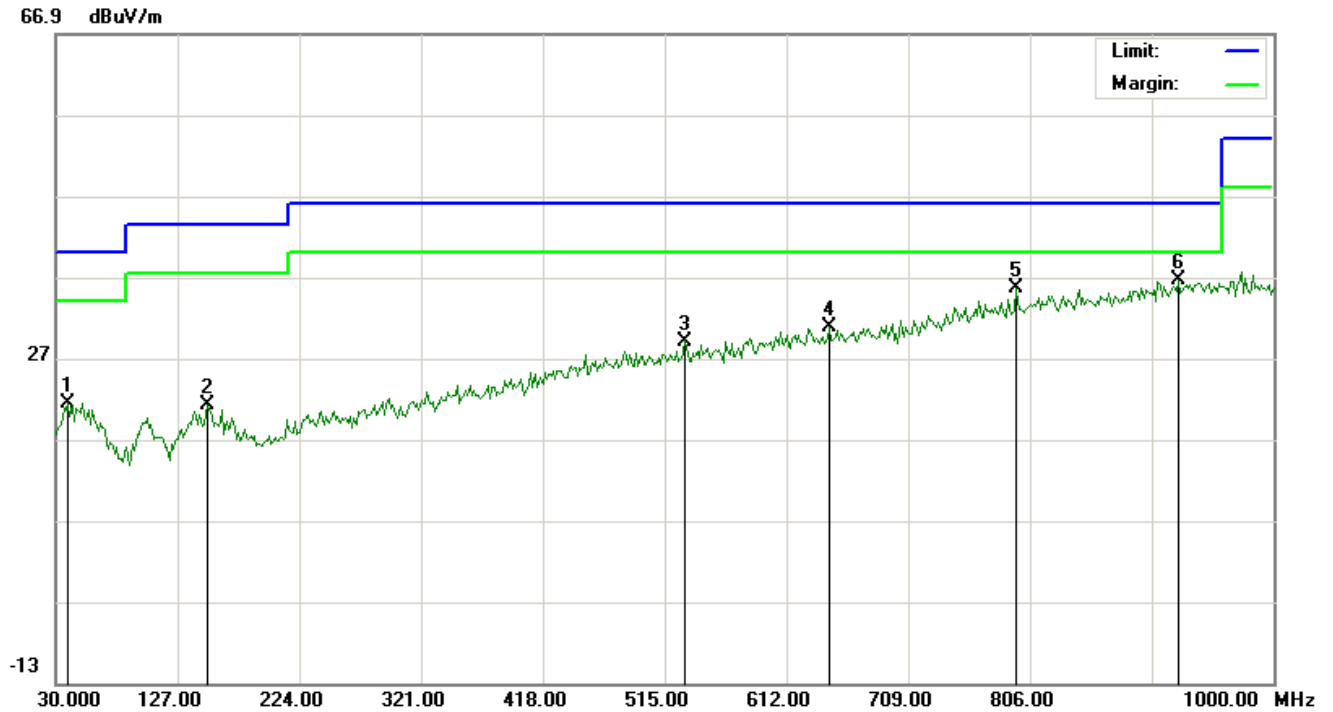

No.	Mk	Freq.	Reading	Factor	Measurement	Limit	Over	Detector	Antenna	Table	Comment
		MHz	dBuV	dB/m	dBuV/m	dBuV/m	dB		Height	Degree	
									cm	degree	
1		39.7000	-0.13	21.51	21.38	40.00	-18.62	peak			
2		151.2500	0.99	20.27	21.26	43.50	-22.24	peak			
3		531.1667	1.31	27.79	29.10	46.00	-16.90	peak			
4		645.9500	0.91	29.92	30.83	46.00	-15.17	peak			
5		794.6833	2.65	33.04	35.69	46.00	-10.31	peak			
6	*	924.0167	1.68	34.91	36.59	46.00	-9.41	peak			

RESULT: PASS



RADIATED EMISSION TEST- (30MHz-1GHz)-LOW CHANNEL -VERTICAL

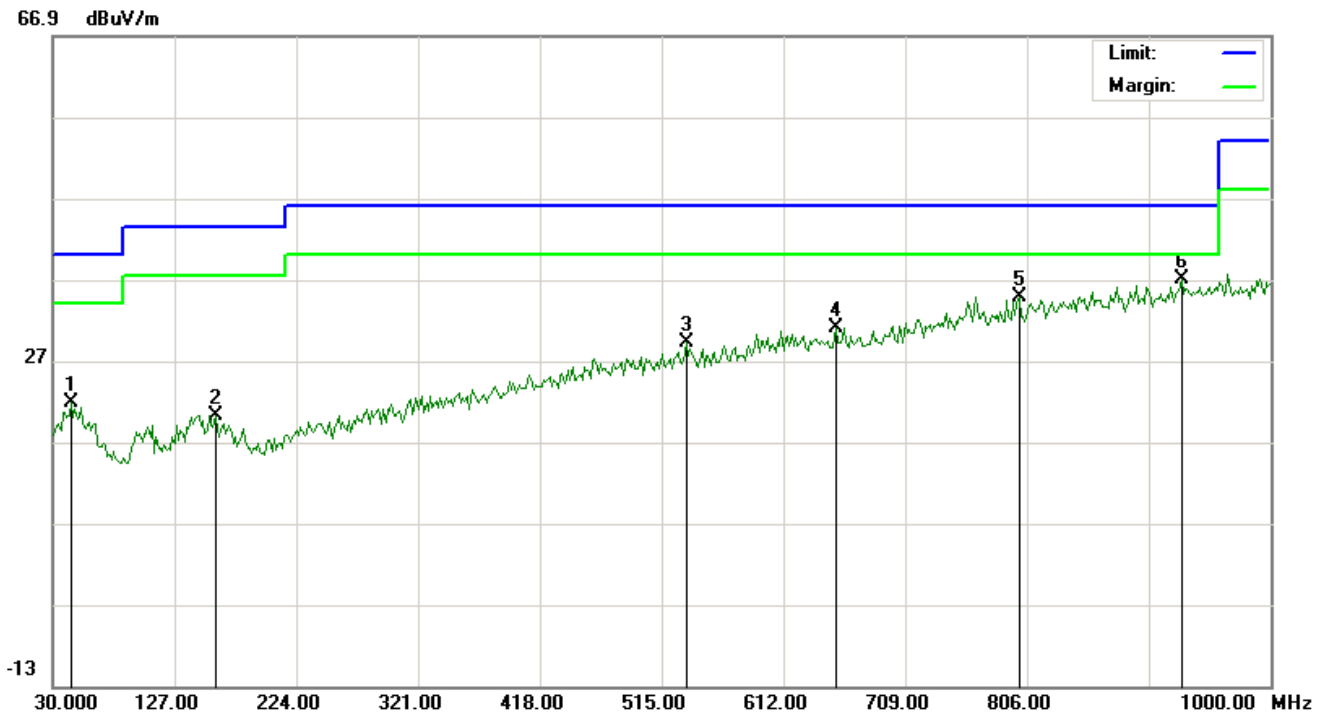

No.	Mk	Freq.	Reading	Factor	Measurement	Limit	Over	Detector	Antenna	Table	Comment
		MHz	dBuV	dB/m	dBuV/m	dBuV/m	dB		Height	Degree	
									cm	degree	
1		44.5500	0.36	21.51	21.87	40.00	-18.13	peak			
2		159.3333	-0.10	20.32	20.22	43.50	-23.28	peak			
3		534.4000	1.30	27.85	29.15	46.00	-16.85	peak			
4		654.0333	1.01	30.04	31.05	46.00	-14.95	peak			
5		799.5333	1.74	33.16	34.90	46.00	-11.10	peak			
6	*	928.8667	2.02	34.96	36.98	46.00	-9.02	peak			

RESULT: PASS

Note: 1. Factor=Antenna Factor+ Cable loss, Margin=Measurement-Limit.

2. The "Factor" value can be calculated automatically by software of measurement system.



RADIATED EMISSION TEST- (30MHz-1GHz)-MIDDLE CHANNEL-HORIZONTAL

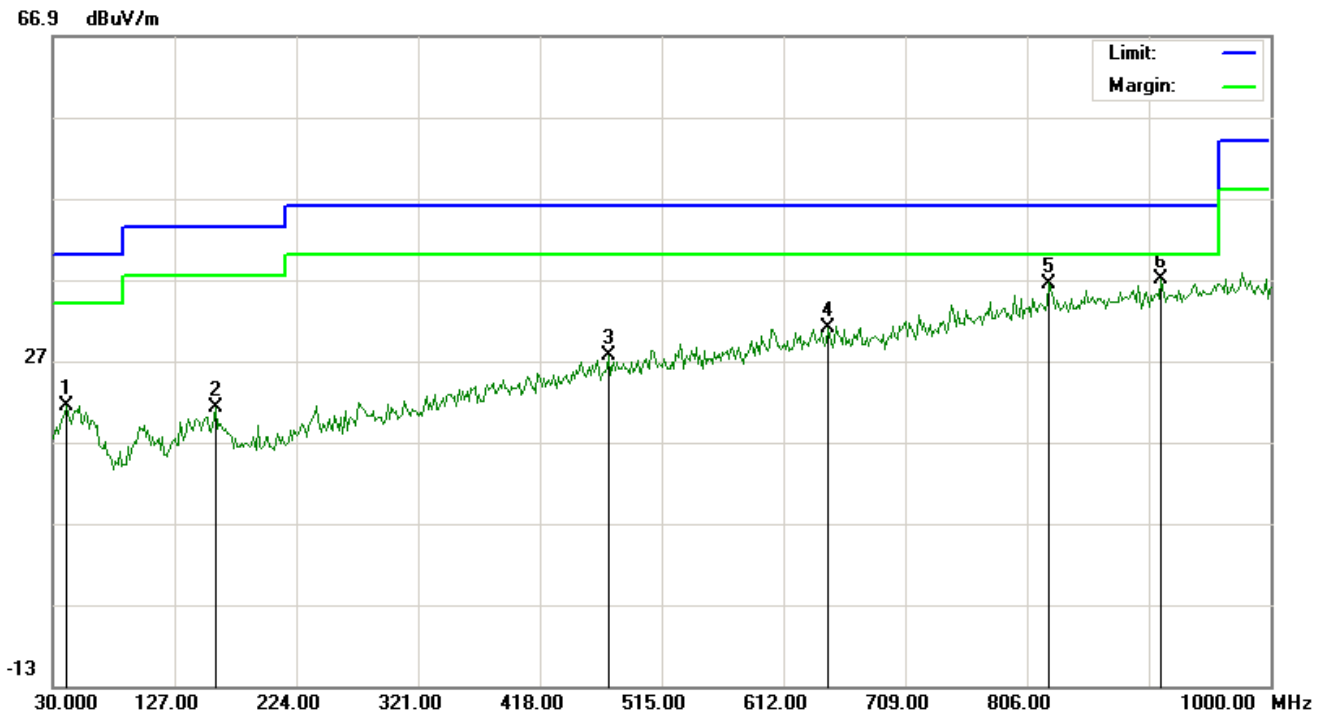

No.	Mk	Freq.	Reading	Factor	Measurement	Limit	Over	Detector	Antenna	Table	Comment
		MHz	dBuV	dB/m	dBuV/m	dBuV/m	dB		Height	Degree	
									cm	degree	
1		41.3167	-0.17	21.60	21.43	40.00	-18.57	peak			
2		159.3333	0.83	20.32	21.15	43.50	-22.35	peak			
3		472.9667	1.01	26.52	27.53	46.00	-18.47	peak			
4		647.5667	1.00	29.94	30.94	46.00	-15.06	peak			
5		823.7833	2.97	33.53	36.50	46.00	-9.50	peak			
6	*	912.7000	2.20	34.80	37.00	46.00	-9.00	peak			

RESULT: PASS



RADIATED EMISSION TEST- (30MHz-1GHz)- MIDDLE CHANNEL -VERTICAL

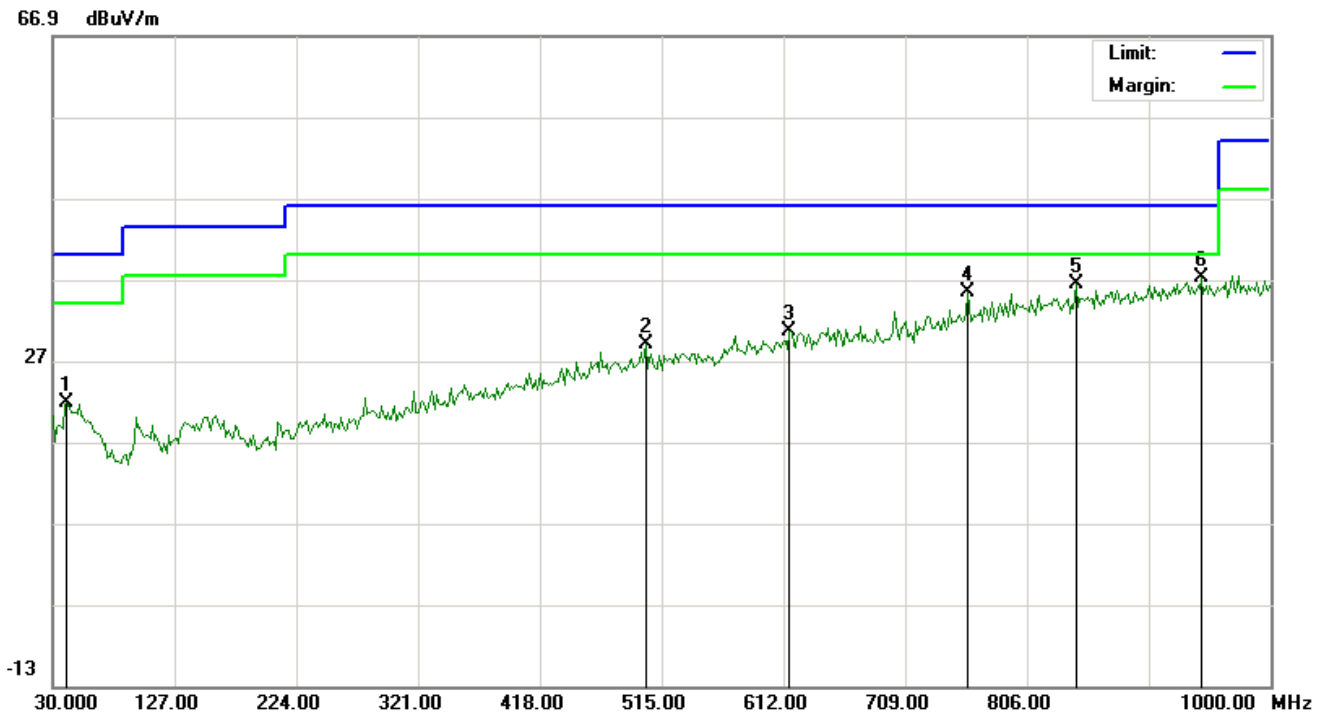

No.	Mk	Freq.	Reading	Factor	Measurement	Limit	Over	Detector	Antenna Height	Table Degree	Comment
		MHz	dBuV	dB/m	dBuV/m	dBuV/m	dB		cm	degree	
1		41.3167	0.27	21.60	21.87	40.00	-18.13	peak			
2		502.0667	1.87	27.18	29.05	46.00	-16.95	peak			
3		616.8500	1.14	29.47	30.61	46.00	-15.39	peak			
4		759.1167	3.23	32.18	35.41	46.00	-10.59	peak			
5		844.8000	2.60	33.84	36.44	46.00	-9.56	peak			
6	*	945.0333	1.99	35.12	37.11	46.00	-8.89	peak			

RESULT: PASS

Note: 1. Factor=Antenna Factor+ Cable loss, Margin=Measurement-Limit.

2. The "Factor" value can be calculated automatically by software of measurement system.



RADIATED EMISSION TEST- (30MHz-1GHz)-HIGH CHANNEL-HORIZONTAL

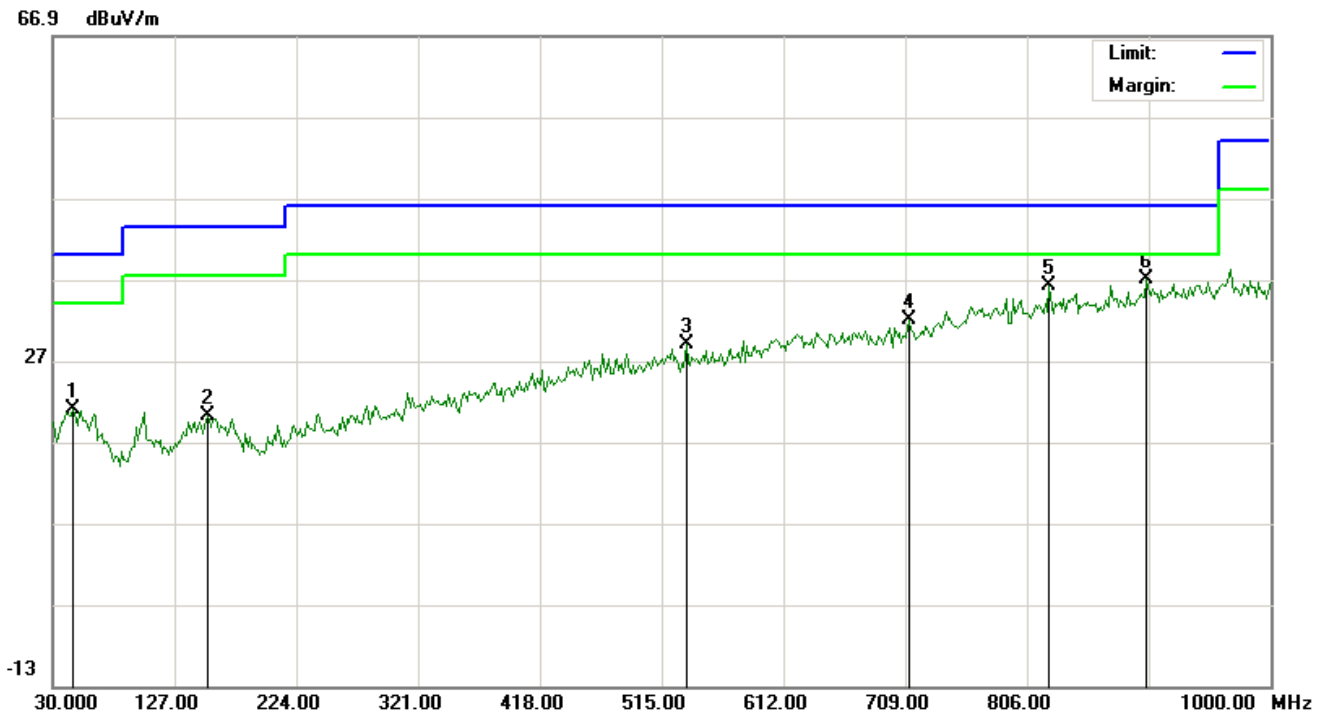

No.	Mk	Freq.	Reading	Factor	Measurement	Limit	Over	Detector	Antenna Height cm	Table Degree degree	Comment
		MHz	dBuV	dB/m	dBuV/m	dBuV/m	dB				
1		46.1667	-0.41	21.46	21.05	40.00	-18.95	peak			
2		152.8667	-0.13	20.28	20.15	43.50	-23.35	peak			
3		534.4000	1.15	27.85	29.00	46.00	-17.00	peak			
4		712.2333	0.96	31.05	32.01	46.00	-13.99	peak			
5		823.7833	2.58	33.53	36.11	46.00	-9.89	peak			
6	*	901.3833	2.34	34.68	37.02	46.00	-8.98	peak			

RESULT: PASS



RADIATED EMISSION TEST- (30MHz-1GHz)-HIGH CHANNEL -VERTICAL

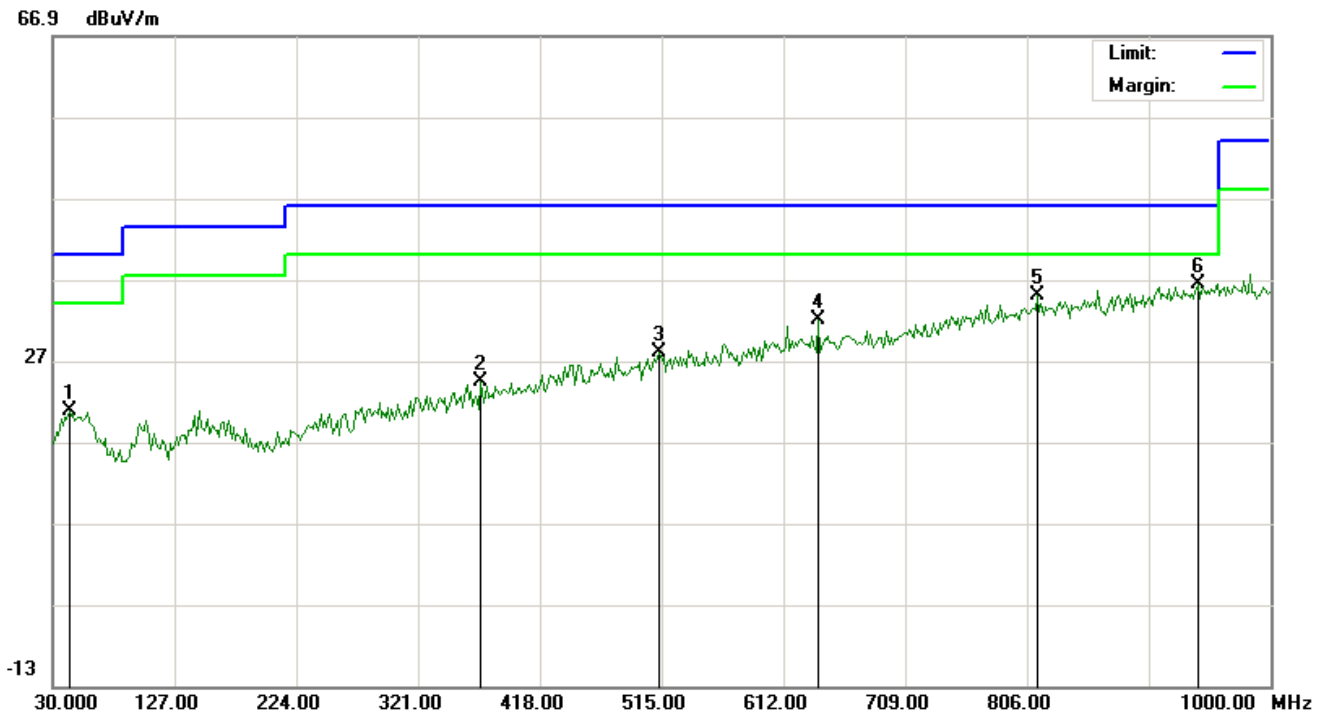

No.	Mk	Freq.	Reading	Factor	Measurement	Limit	Over	Detector	Antenna Height	Table Degree	Comment
		MHz	dBuV	dB/m	dBuV/m	dBuV/m	dB		cm	degree	
1		42.9333	-0.78	21.55	20.77	40.00	-19.23	peak			
2		371.1167	0.59	23.77	24.36	46.00	-21.64	peak			
3		513.3832	0.57	27.42	27.99	46.00	-18.01	peak			
4		639.4833	2.20	29.82	32.02	46.00	-13.98	peak			
5		814.0833	1.56	33.38	34.94	46.00	-11.06	peak			
6	*	941.8000	1.27	35.09	36.36	46.00	-9.64	peak			

RESULT: PASS

Note: 1. Factor=Antenna Factor+ Cable loss, Margin=Measurement-Limit.

2. The "Factor" value can be calculated automatically by software of measurement system.

**RADIATED EMISSION ABOVE 1GHz**

EUT :	Bluetooth Smart Padlock	Model Name. :	LE-01-5.2
Temperature :	20 °C	Relative Humidity :	48%
Pressure :	1010 hPa	Test Voltage :	DC 3V
Test Mode :	Mode 1	Polarization :	Horizontal

Frequency (MHz)	Meter Reading (dB μ V)	Factor (dB)	Emission Level (dB μ V/m)	Limits (dB μ V/m)	Margin (dB)	Value Type
4804.026	43.02	7.12	50.14	74	-23.86	peak
4804.026	38.92	7.12	46.04	54	-7.96	AVG
7206.039	37.27	9.84	47.11	74	-26.89	peak
7206.039	34.13	9.84	43.97	54	-10.03	AVG

Remark:

Factor = Antenna Factor + Cable Loss – Pre-amplifier.

EUT :	Bluetooth Smart Padlock	Model Name. :	LE-01-5.2
Temperature :	20 °C	Relative Humidity :	48%
Pressure :	1010 hPa	Test Voltage :	DC 3V
Test Mode :	Mode 1	Polarization :	Vertical

Frequency (MHz)	Meter Reading (dB μ V)	Factor (dB)	Emission Level (dB μ V/m)	Limits (dB μ V/m)	Margin (dB)	Value Type
4804.026	41.75	7.12	48.87	74	-25.13	peak
4804.026	38.15	7.12	45.27	54	-8.73	AVG
7206.039	36.63	9.84	46.47	74	-27.53	peak
7206.039	33.14	9.84	42.98	54	-11.02	AVG

Remark:

Factor = Antenna Factor + Cable Loss – Pre-amplifier.



EUT :	Bluetooth Smart Padlock	Model Name. :	LE-01-5.2
Temperature :	20 °C	Relative Humidity :	48%
Pressure :	1010 hPa	Test Voltage :	DC 3V
Test Mode :	Mode 2	Polarization :	Horizontal

Frequency (MHz)	Meter Reading (dB μ V)	Factor (dB)	Emission Level (dB μ V/m)	Limits (dB μ V/m)	Margin (dB)	Value Type
4880.032	42.28	7.12	49.4	74	-24.6	peak
4880.032	39.13	7.12	46.25	54	-7.75	AVG
7320.048	37.09	9.84	46.93	74	-27.07	peak
7320.048	33.92	9.84	43.76	54	-10.24	AVG

Remark:

Factor = Antenna Factor + Cable Loss – Pre-amplifier.

EUT :	Bluetooth Smart Padlock	Model Name. :	LE-01-5.2
Temperature :	20 °C	Relative Humidity :	48%
Pressure :	1010 hPa	Test Voltage :	DC 3V
Test Mode :	Mode 2	Polarization :	Vertical

Frequency (MHz)	Meter Reading (dB μ V)	Factor (dB)	Emission Level (dB μ V/m)	Limits (dB μ V/m)	Margin (dB)	Value Type
4880.032	41.79	7.12	48.91	74	-25.09	peak
4880.032	38.58	7.12	45.7	54	-8.3	AVG
7320.048	38.14	9.84	47.98	74	-26.02	peak
7320.048	34.92	9.84	44.76	54	-9.24	AVG

Remark:

Factor = Antenna Factor + Cable Loss – Pre-amplifier.



EUT :	Bluetooth Smart Padlock	Model Name. :	LE-01-5.2
Temperature :	20 °C	Relative Humidity:	48%
Pressure :	1010 hPa	Test Voltage:	DC 3V
Test Mode :	Mode 3	Polarization :	Horizontal

Frequency (MHz)	Meter Reading (dB μ V)	Factor (dB)	Emission Level (dB μ V/m)	Limits (dB μ V/m)	Margin (dB)	Value Type
4960.042	43.17	7.12	50.29	74	-23.71	peak
4960.042	39.89	7.12	47.01	54	-6.99	AVG
7440.063	38.34	9.84	48.18	74	-25.82	peak
7440.063	34.83	9.84	44.67	54	-9.33	AVG

Remark:

Factor = Antenna Factor + Cable Loss – Pre-amplifier.

EUT :	Bluetooth Smart Padlock	Model Name. :	LE-01-5.2
Temperature :	20 °C	Relative Humidity:	48%
Pressure :	1010 hPa	Test Voltage:	DC 3V
Test Mode :	Mode 3	Polarization :	Vertical

Frequency (MHz)	Meter Reading (dB μ V)	Factor (dB)	Emission Level (dB μ V/m)	Limits (dB μ V/m)	Margin (dB)	Value Type
4960.042	42.81	7.12	49.93	74	-24.07	peak
4960.042	38.58	7.12	45.7	54	-8.3	AVG
7440.063	37.46	9.84	47.3	74	-26.7	peak
7440.063	34.12	9.84	43.96	54	-10.04	AVG

Remark:

Factor = Antenna Factor + Cable Loss – Pre-amplifier.

Note: Other emissions from 8G to 25 GHz are considered as ambient noise. No recording in the test report.
Factor=Antenna Factor+ Cable loss-Amplifier gain, Margin=Measurement-Limit.

The “Factor” value can be calculated automatically by software of measurement system.

The GFSK modulation was the worst case and only the data of worst recorded in this report.



5. BAND EDGE EMISSION

5.1. MEASUREMENT PROCEDURE

1. Set the EUT Work on the top, the bottom operation frequency individually.
2. Set SPA Start or Stop Frequency=Operation Frequency,
For unrestricted band: RBW=100kHz, VBW=300kHz
For restricted band: RBW=1MHz, VBW=3*RBW
Center frequency =Operation frequency
3. The band edges was measured and recorded.

5.2. TEST SET-UP

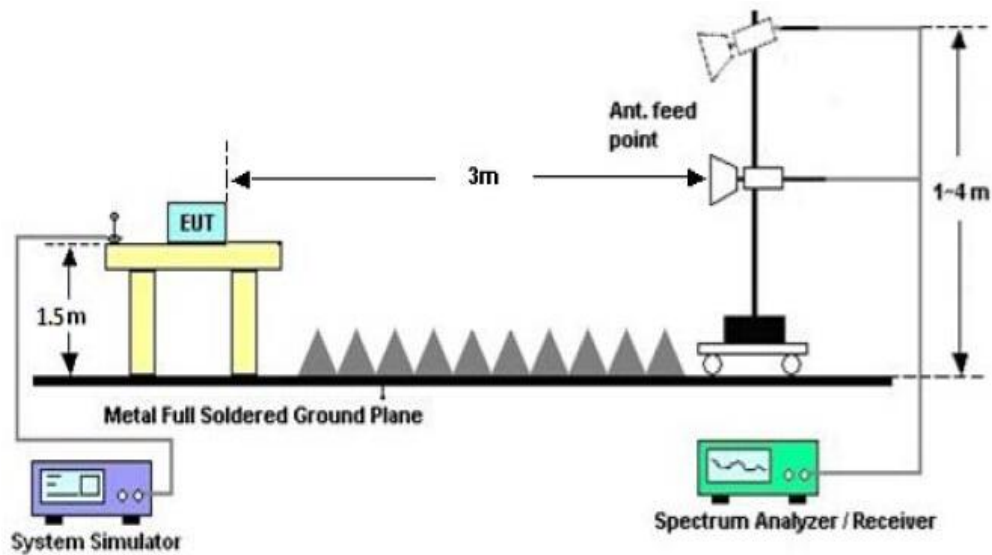



5.3. TEST RESULT

TEST PLOT OF BAND EDGE FOR LOW CHANNEL -Horizontal

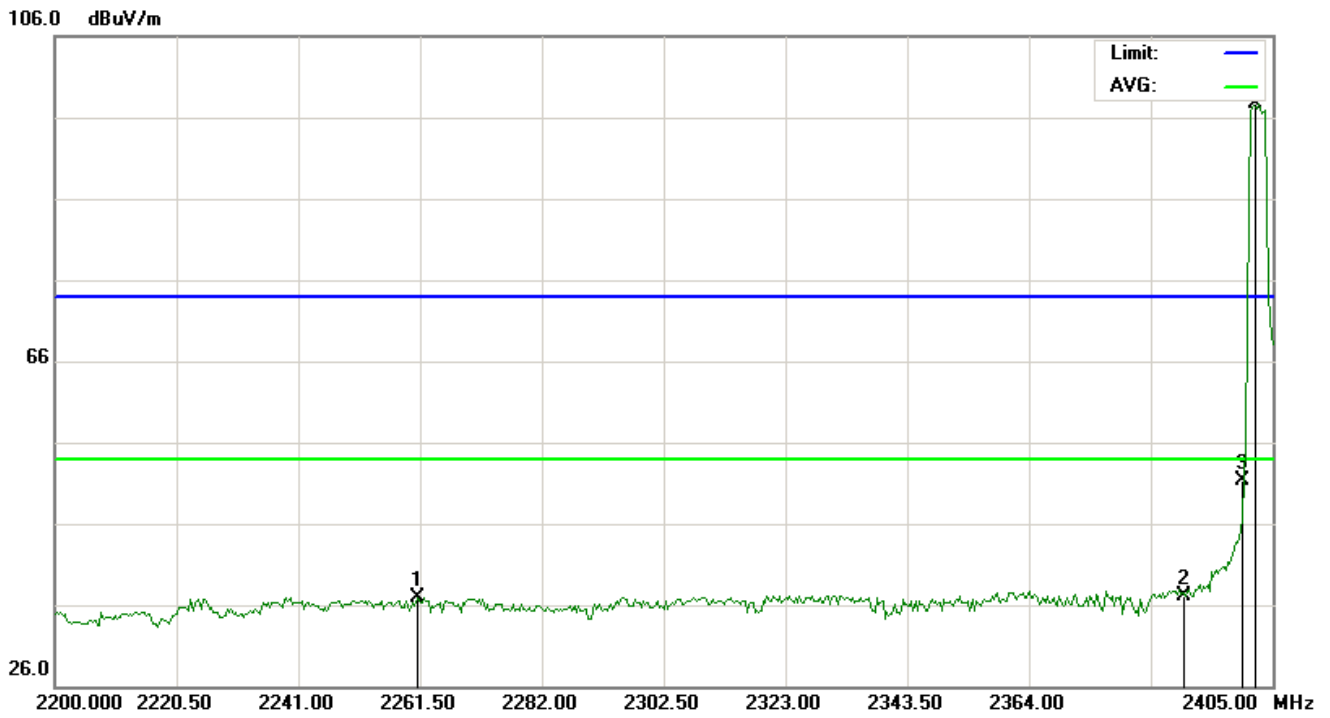

No.	Mk	Freq.	Reading	Factor	Measurement	Limit	Over	Detector	Antenna	Table	Comment
		MHz	dBuV	dB/m	dBuV/m	dBuV/m	dB		Height	Degree	
									cm	degree	
1		2261.158	23.48	13.45	36.93	74.00	-37.07	peak			
2		2390.000	23.67	13.46	37.13	74.00	-36.87	peak			
3		2400.000	37.94	13.46	51.40	74.00	-22.60	peak			
4	*	2402.000	84.20	13.46	97.66	74.00	23.66	peak			



TEST PLOT OF BAND EDGE FOR LOW CHANNEL - Vertical

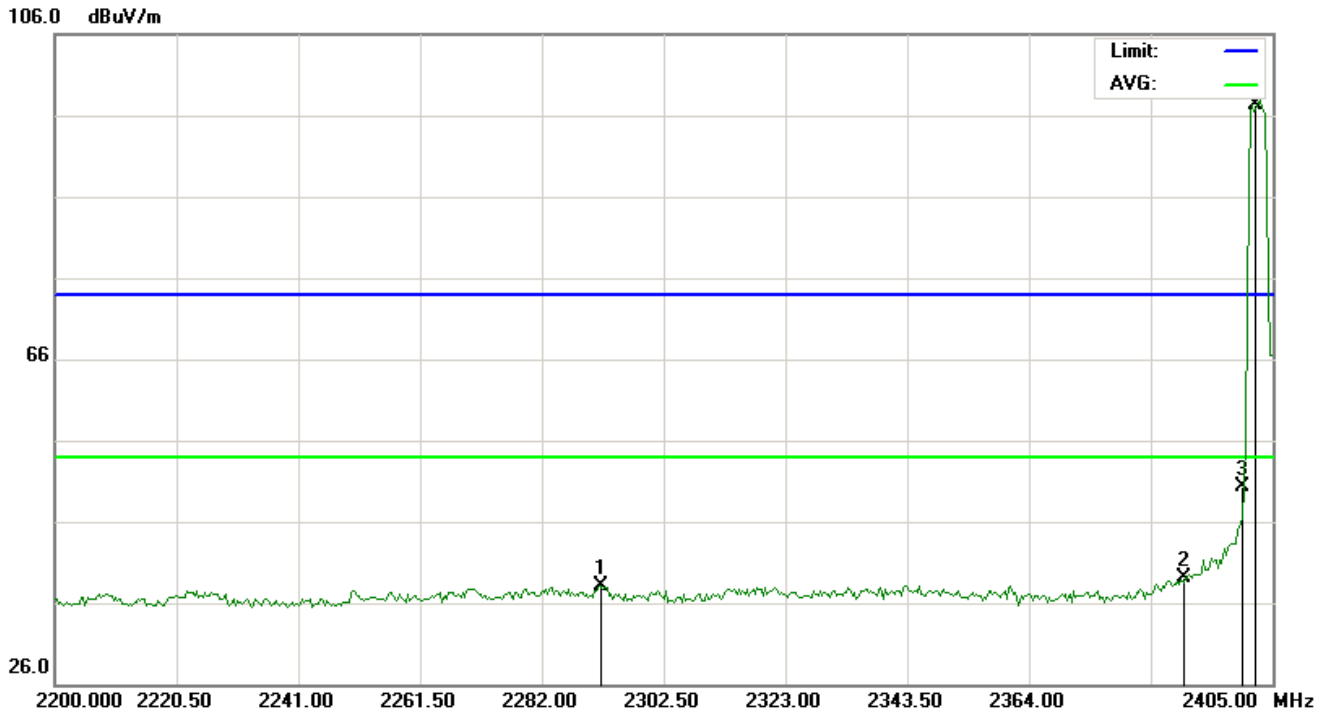

No.	Mk	Freq.	Reading	Factor	Measurement	Limit	Over	Detector	Antenna	Table	Comment
		MHz	dBuV	dB/m	dBuV/m	dBuV/m	dB		Height	Degree	
									cm	degree	
1		2291.908	24.61	13.45	38.06	74.00	-35.94	peak			
2		2390.000	25.67	13.46	39.13	74.00	-34.87	peak			
3		2400.000	36.94	13.46	50.40	74.00	-23.60	peak			
4	*	2402.000	83.77	13.46	97.23	74.00	23.23	peak			

RESULT: PASS



TEST PLOT OF BAND EDGE FOR HIGH CHANNEL –Horizontal



No.	Mk	Freq.	Reading	Factor	Measurement	Limit	Over	Detector	Antenna	Table	Comment
		MHz	dBuV	dB/m	dBuV/m	dBuV/m	dB		Height	Degree	
									cm	degree	
1	*	2480.000	82.60	14.11	96.71	74.00	22.71	peak			
2		2483.500	22.66	14.13	36.79	74.00	-37.21	peak			
3		2493.620	20.28	14.19	34.47	74.00	-39.53	peak			



TEST PLOT OF BAND EDGE FOR HIGH CHANNEL -Vertical

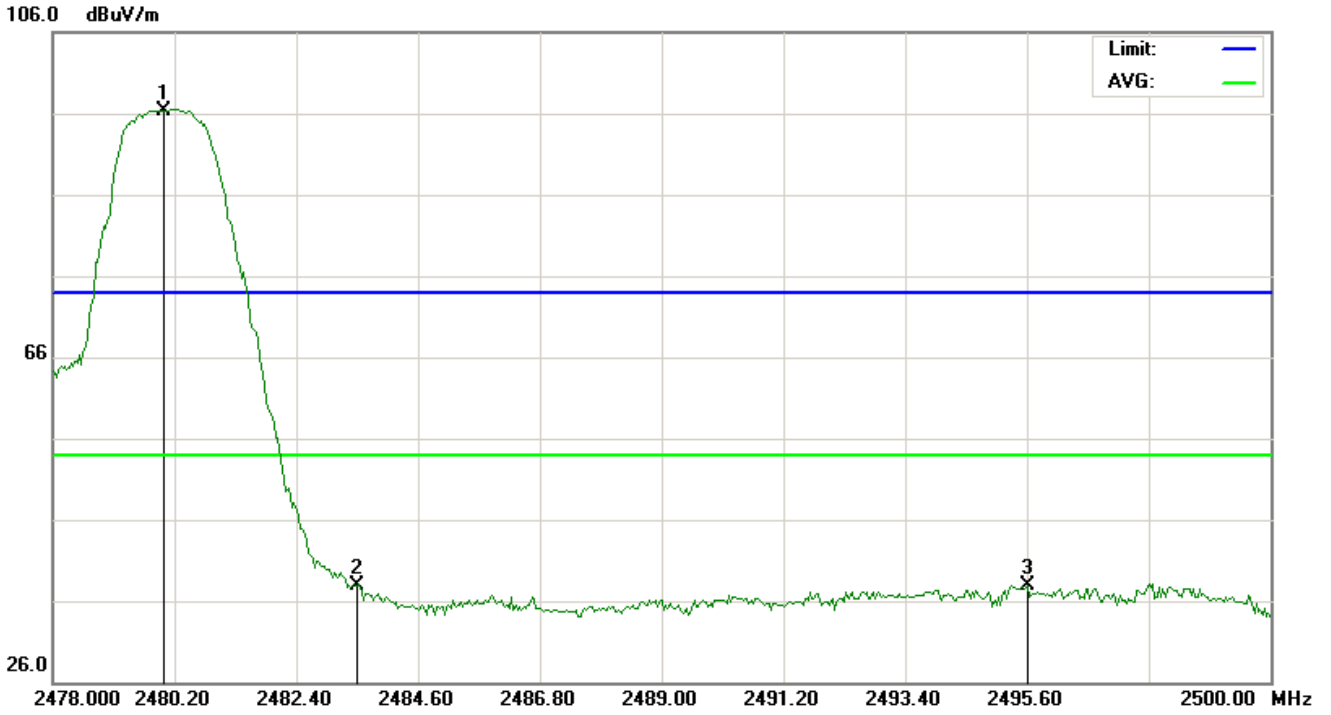

No.	Mk	Freq.	Reading	Factor	Measurement	Limit	Over	Detector	Antenna Height	Table Degree	Comment
		MHz	dBuV	dB/m	dBuV/m	dBuV/m	dB		cm	degree	
1	*	2480.000	82.11	14.11	96.22	74.00	22.22	peak			
2		2483.500	23.72	14.13	37.85	74.00	-36.15	peak			
3		2495.600	23.68	14.20	37.88	74.00	-36.12	peak			

RESULT: PASS



6. 6DB BANDWIDTH

6.1. TEST PROCEDURE

1. Connect EUT RF output port to the Spectrum Analyzer through an RF attenuator
2. Set the EUT Work on the top, the middle and the bottom operation frequency individually.
3. Set SPA Centre Frequency = Operation Frequency, RBW= 100 KHz, VBW ≥ 3 *RBW.
4. Set SPA Trace 1 Max hold, then View.

6.2. SUMMARY OF TEST RESULTS/PLOTS

Channel	6dB Bandwidth (KHz)	Minimum Limit (KHz)	Pass/Fail
Low	700	500KHz	Pass
Middle	705		Pass
High	713		Pass

TEST PLOT OF BANDWIDTH FOR LOW CHANNEL





TEST PLOT OF BANDWIDTH FOR MIDDLE CHANNEL

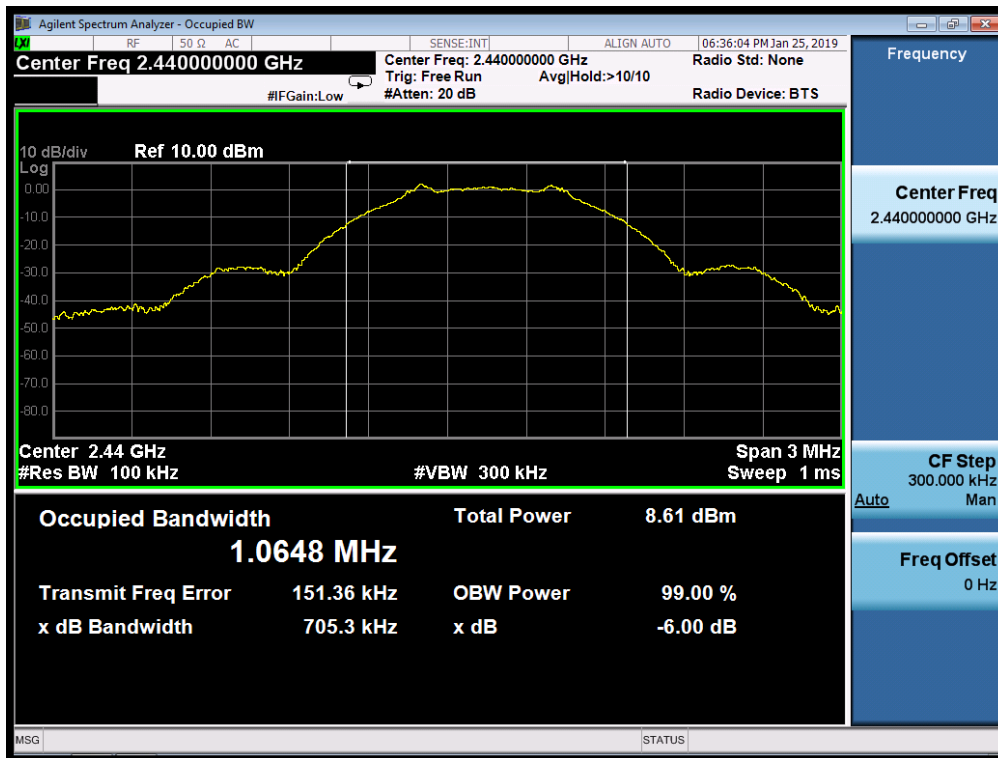

TEST PLOT OF BANDWIDTH FOR HIGH CHANNEL

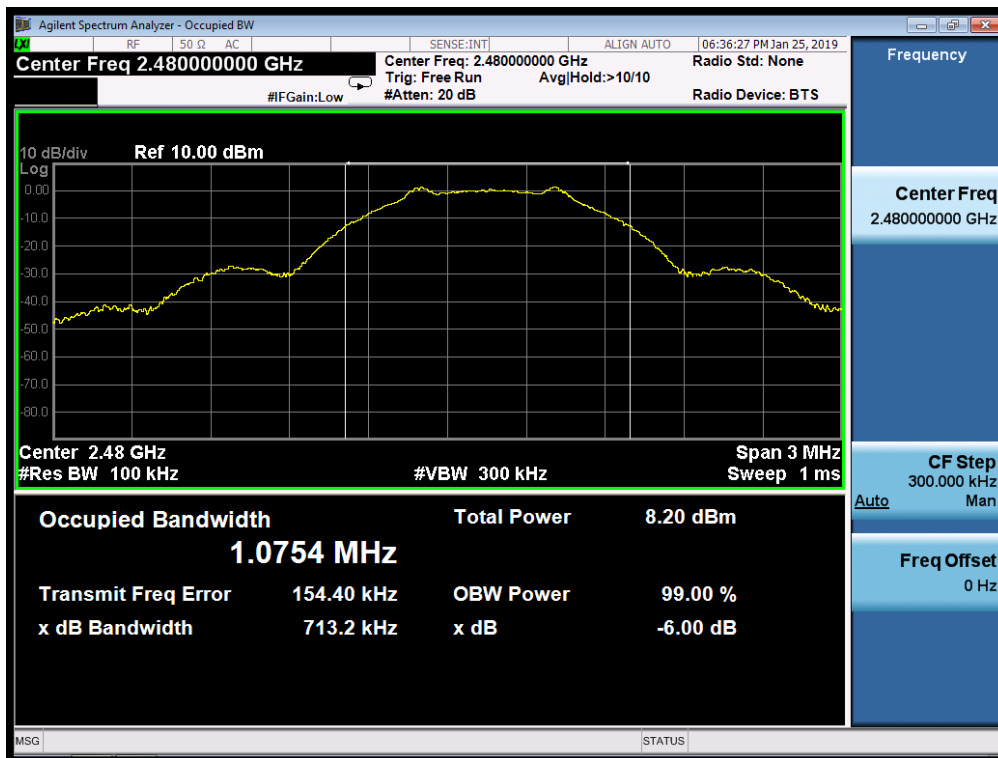



7. CONDUCTED OUTPUT POWER

7.1. MEASUREMENT PROCEDURE

1. Connect EUT RF output port to the Spectrum Analyzer through an RF attenuator
2. Set the EUT Work on the top, middle and the bottom operation frequency individually.
3. Use the following spectrum analyzer settings:
 - a) Set the RBW \geq DTS bandwidth.
 - b) Set VBW \geq 3 RBW.
 - c) Set span \geq 3 x RBW
 - d) Sweep time = auto couple.
 - e) Detector = peak.
 - f) Trace mode = max hold.
 - g) Allow trace to fully stabilize.
 - h) Use peak marker function to determine the peak amplitude level.
4. Allow the trace to stabilize.
5. Record the result form the Spectrum Analyzer.

7.2. TEST SET-UP (BLOCK DIAGRAM OF CONFIGURATION)

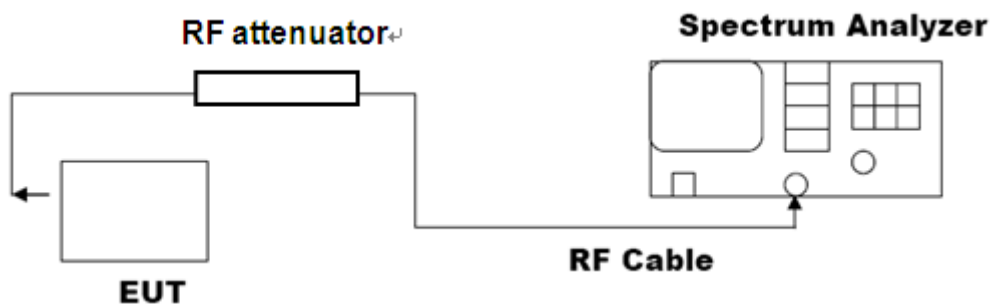



7.3. LIMITS AND MEASUREMENT RESULT

Channel	Peak Power (dBm)	Applicable Limits (dBm)	Pass/Fail
Low Channel	2.490	30	Pass
Middle Channel	2.019	30	Pass
High Channel	1.510	30	Pass

The Low Channel Result

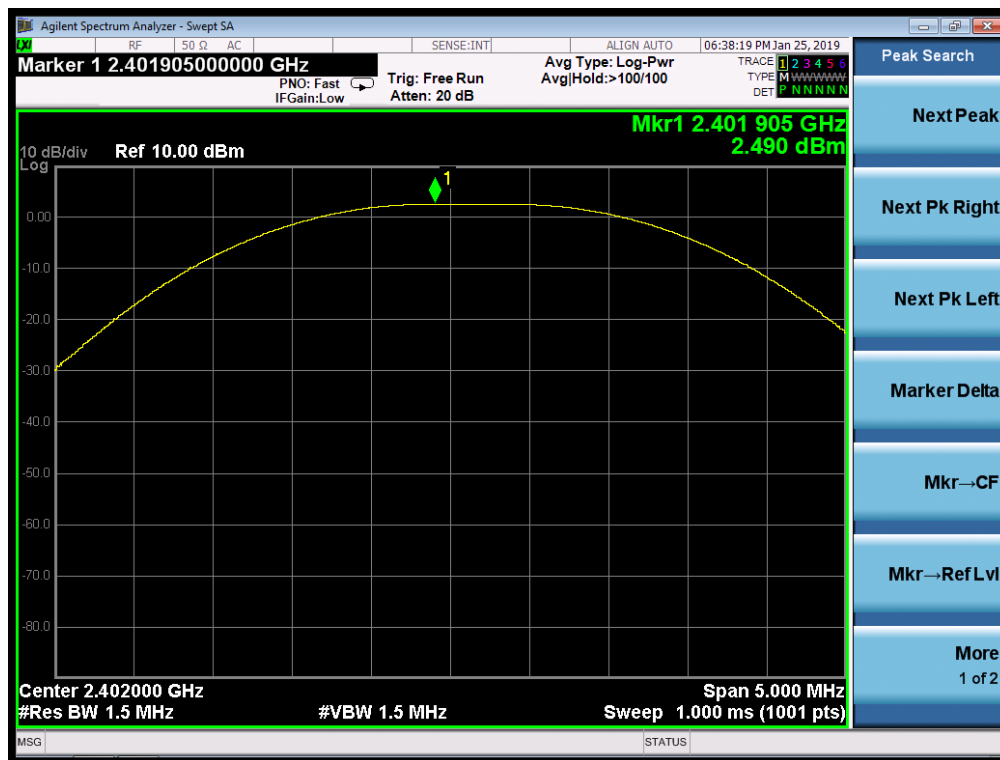



The Middle Channel Result

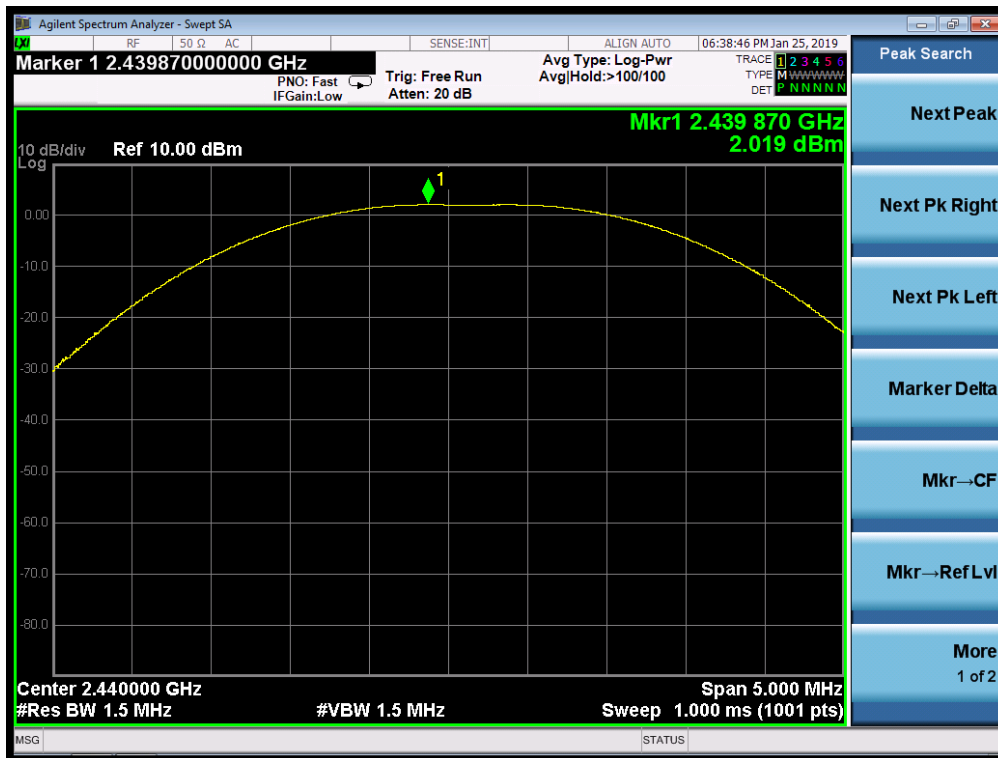

The High Channel Result

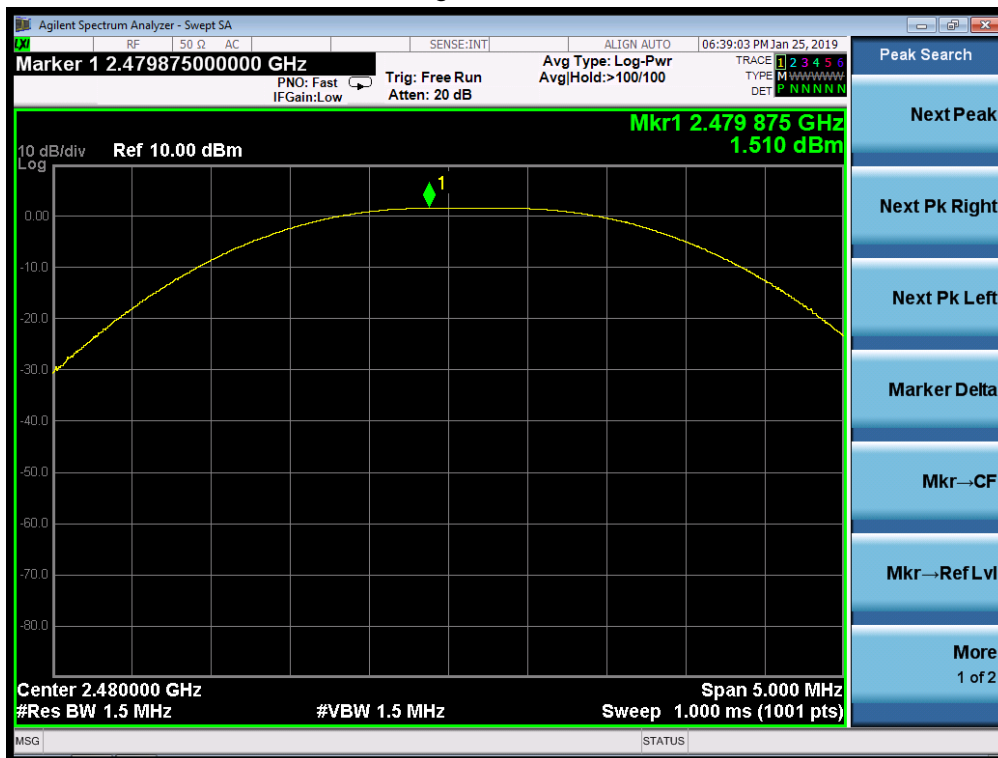



8. CONDUCTED SPURIOUS EMISSION

8.1. MEASUREMENT PROCEDURE

1. Connect EUT RF output port to the Spectrum Analyzer through an RF attenuator
2. Set the EUT Work on the top, the Middle and the bottom operation frequency individually.
3. Set the Span = wide enough to capture the peak level of the in-band emission and all spurious emissions from the lowest frequency generated in the EUT up through the 10th harmonic.
RBW = 100kHz; VBW \geq 3 RBW; Sweep = auto; Detector function = peak.
4. Set SPA Trace 1 Max hold, then View.

8.2. TEST SET-UP (BLOCK DIAGRAM OF CONFIGURATION)

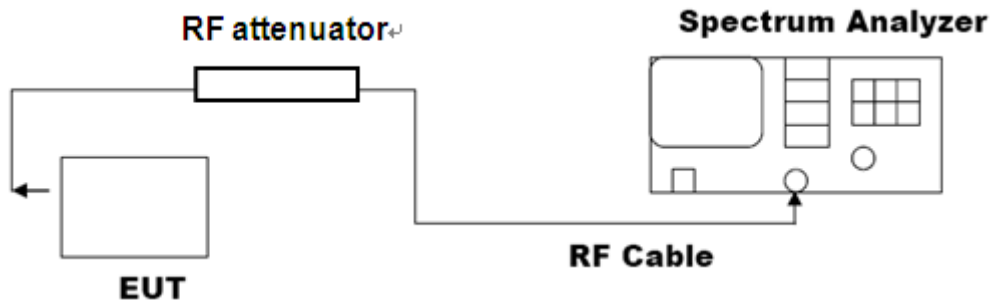

8.3. LIMITS AND MEASUREMENT RESULT

LIMITS AND MEASUREMENT RESULT		
Applicable Limits	Measurement Result	
	Test Data	Result
In any 100 KHz Bandwidth Outside the frequency band in which the spread spectrum intentional radiator is operating, the radio frequency power that is produce by the intentional radiator shall be at least 20 dB below that in 100KHz bandwidth within the band that contains the highest level of the desired power. In addition, radiation emissions which fall in the restricted bands, as defined in §15.205(a), must also comply with the radiated emission limits specified in§15.209(a)	At least -20dBc than the limit Specified on the BOTTOM Channel	PASS
	At least -20dBc than the limit Specified on the TOP Channel	PASS



TEST PLOT OF OUT OF BAND EMISSIONS
OF GFSK MODULATION IN HIGH CHANNEL

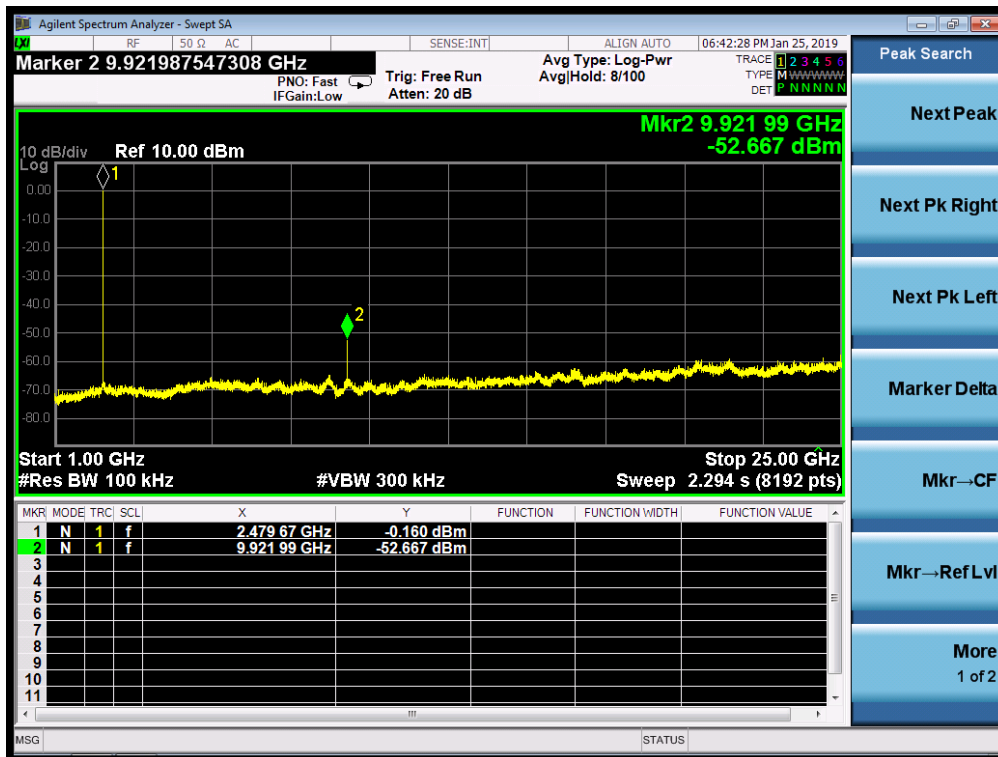
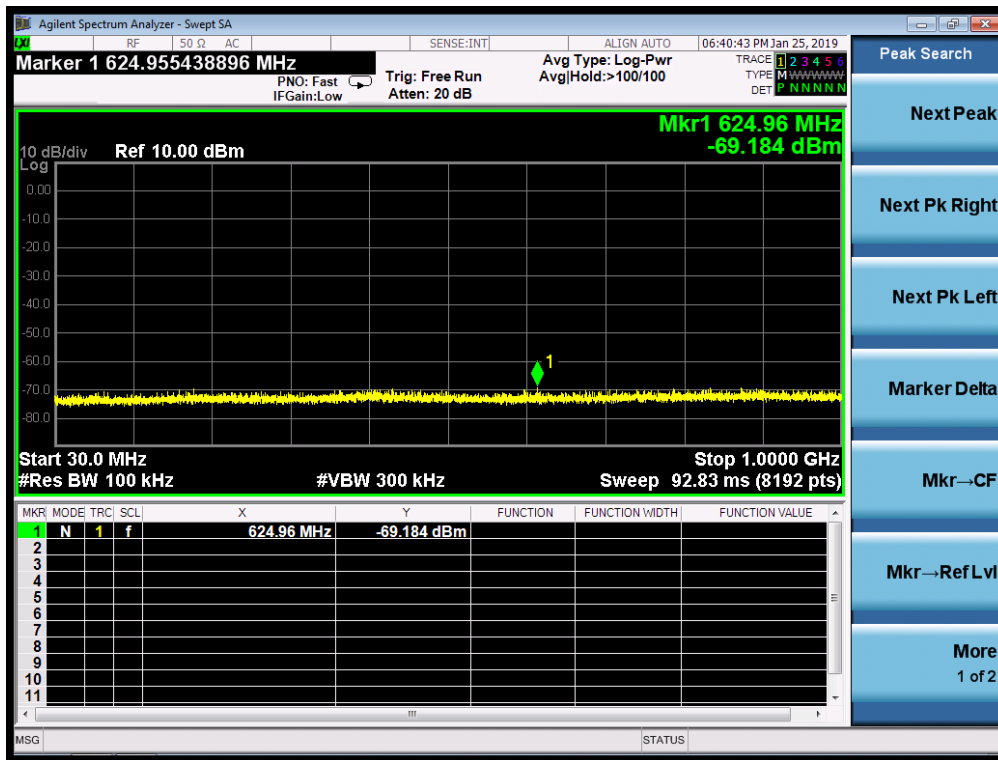



9. CONDUCTED OUTPUT POWER SPECTRAL DENSITY

9.1 MEASUREMENT PROCEDURE

- (1). Connect EUT RF output port to the Spectrum Analyzer through an RF attenuator
- (2). Set the EUT Work on the top, the middle and the bottom operation frequency individually.
- (3). Set the span to 1.5 times the DTS bandwidth, RBW: $3\text{kHz} \leq \text{RBW} \leq 100\text{kHz}$, VBW $\geq 3 * \text{RBW}$
- (4). Set SPA Trace 1 Max hold, then View.

Note: The EUT was tested according to KDB 558074 for compliance to FCC 47CFR 15.247 requirements.

9.2 TEST SET-UP (BLOCK DIAGRAM OF CONFIGURATION)

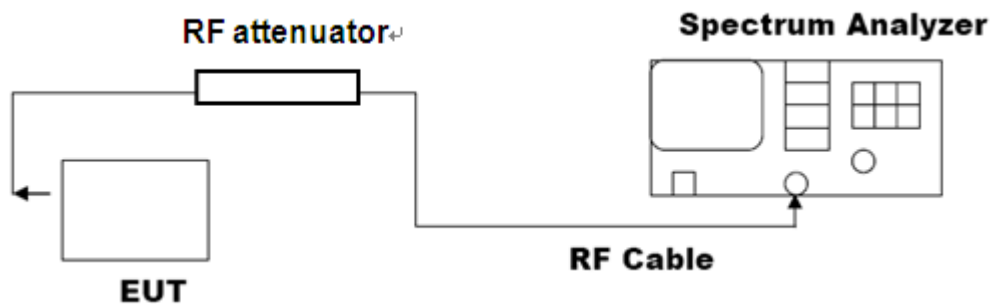

9.3 LIMITS AND MEASUREMENT RESULT

Channel No.	PSD (dBm/3KHz)	Limit (dBm/3KHz)	Result
Low Channel	-9.085	8	Pass
Middle Channel	-11.121	8	Pass
High Channel	-11.221	8	Pass



TEST PLOT OF SPECTRAL DENSITY FOR LOW CHANNEL

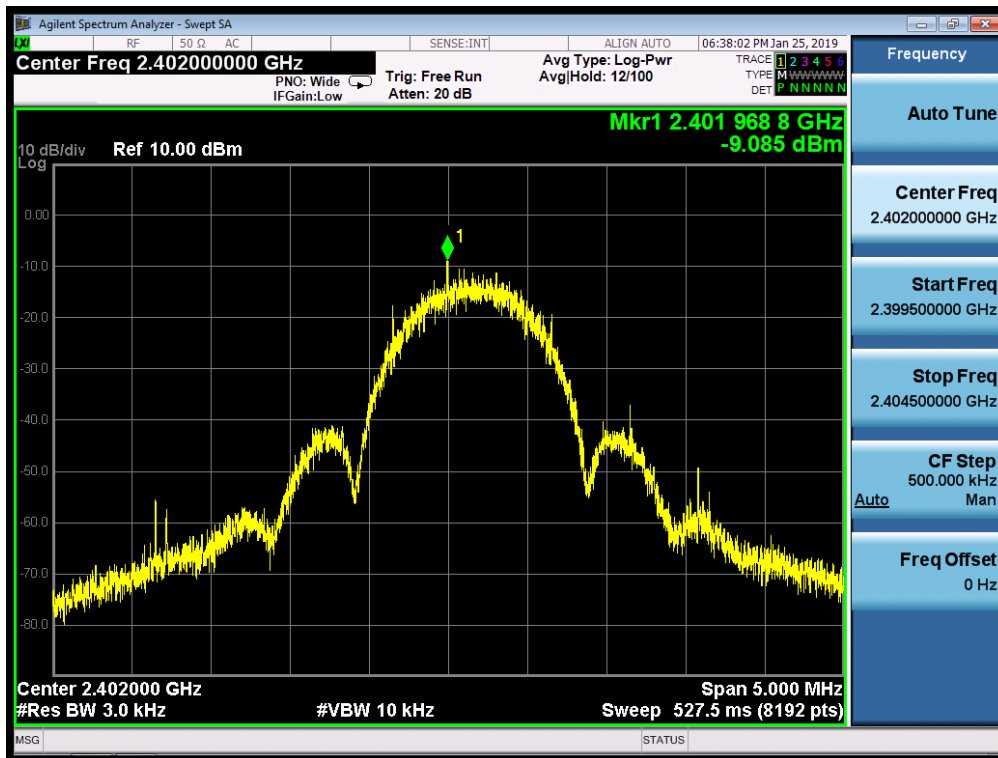

TEST PLOT OF SPECTRAL DENSITY FOR MIDDLE CHANNEL

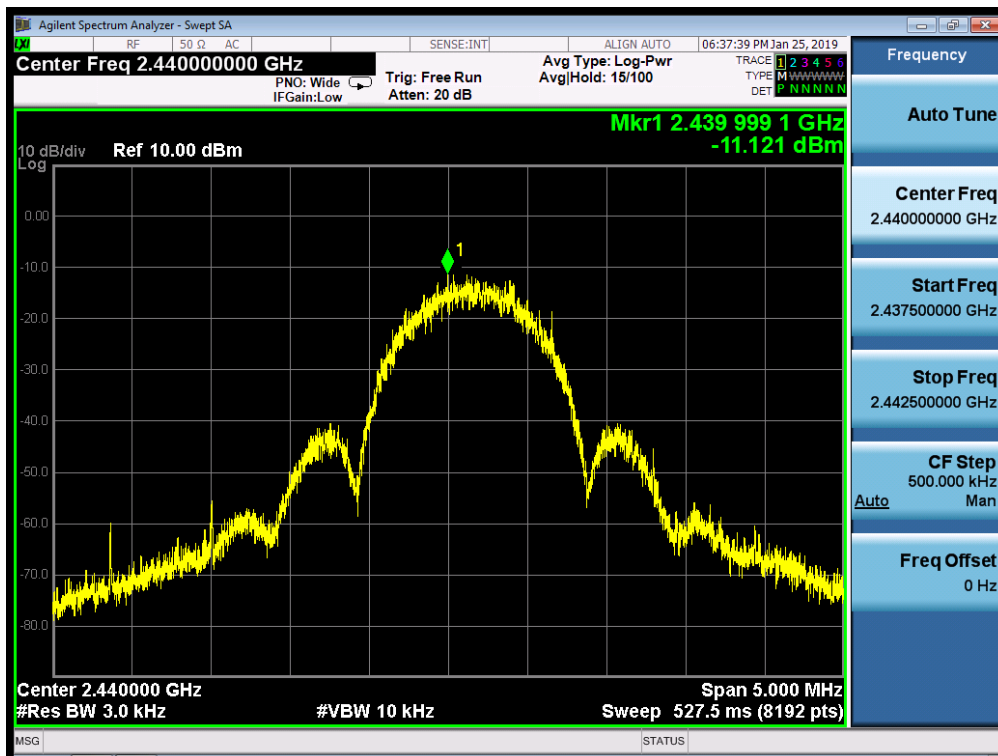



TEST PLOT OF SPECTRAL DENSITY FOR HIGH CHANNEL

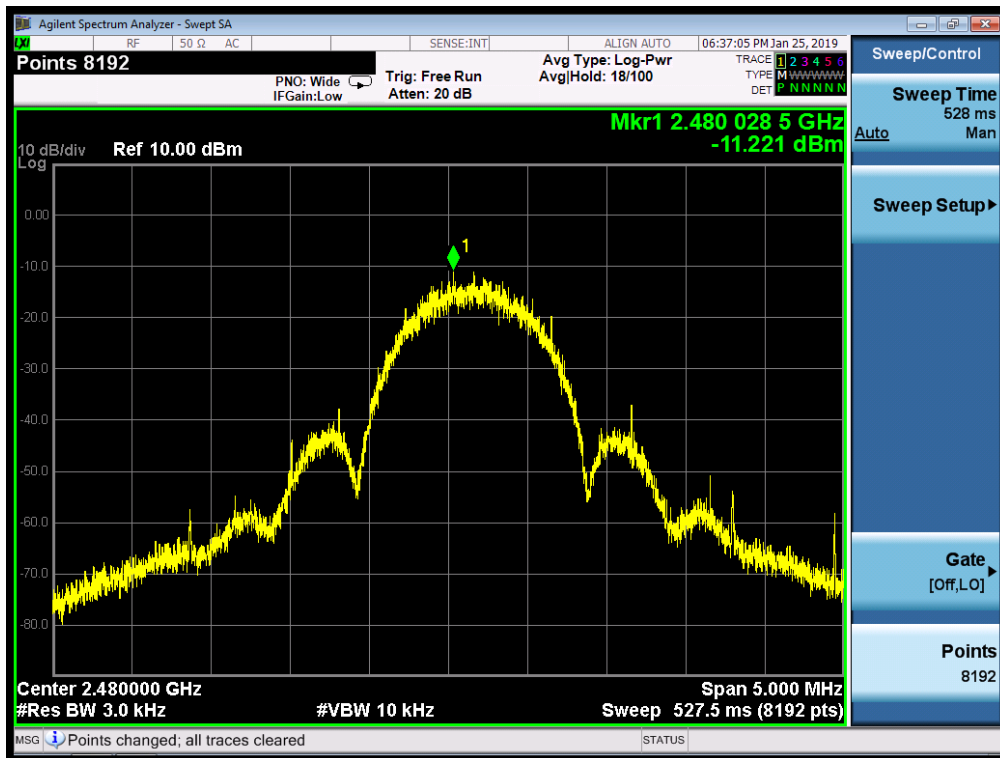



10. LINE CONDUCTED EMISSION TEST

10.1 LIMITS

Frequency	Maximum RF Line Voltage	
	Q.P.(dBuV)	Average(dBuV)
150kHz~500kHz	66-56	56-46
500kHz~5MHz	56	46
5MHz~30MHz	60	50

Note: 1. The lower limit shall apply at the transition frequency.

2. The limit decreases linearly with the logarithm of the frequency in the range 0.15 MHz to 0.50 MHz

10.2 TEST SETUP

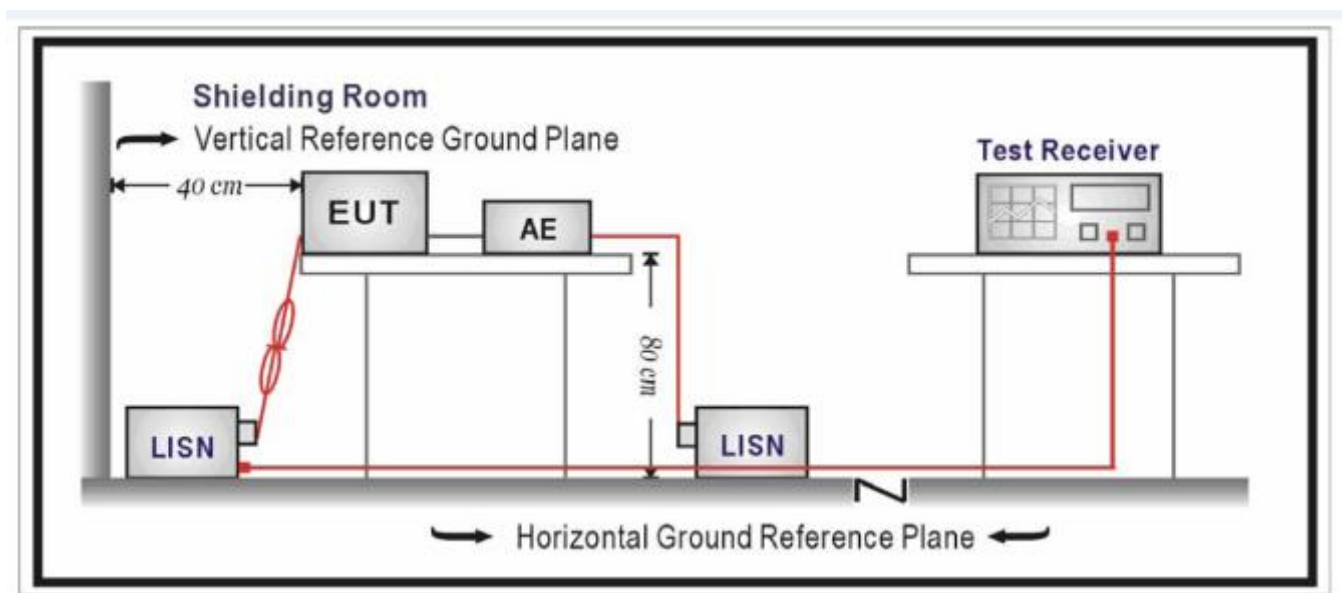



10.3 PRELIMINARY PROCEDURE

- 1) The equipment was set up as per the test configuration to simulate typical actual usage per the user's manual. When the EUT is a tabletop system, a wooden table with a height of 0.8 meters is used and is placed on the ground plane as per ANSI C63.10 (see Test Facility for the dimensions of the ground plane used). When the EUT is a floor-standing equipment, it is placed on the ground plane which has a 3-12 mm non-conductive covering to insulate the EUT from the ground plane.
- 2) Support equipment, if needed, was placed as per ANSI C63.10.
- 3) All I/O cables were positioned to simulate typical actual usage as per ANSI C63.10.
- 4) All support equipments received AC120V/60Hz power from a LISN, if any.
- 5) The EUT received DC charging voltage by adapter which received 120V/60Hz power by a LISN.
- 6) The test program was started. Emissions were measured on each current carrying line of the EUT using a spectrum Analyzer / Receiver connected to the LISN powering the EUT. The LISN has two monitoring points: Line 1 (Hot Side) and Line 2 (Neutral Side). Two scans were taken: one with Line 1 connected to Analyzer / Receiver and Line 2 connected to a 50 ohm load; the second scan had Line 1 connected to a 50 ohm load and Line 2 connected to the Analyzer / Receiver.
- 7) Analyzer / Receiver scanned from 150kHz to 30MHz for emissions in each of the test modes.
- 8) During the above scans, the emissions were maximized by cable manipulation.
- 9) The following test mode(s) were scanned during the preliminary test.
Then, the EUT configuration and cable configuration of the above highest emission level were recorded for reference of final testing.

10.4 FINAL TEST PROCEDURE

- 1) EUT and support equipment was set up on the test bench as per step 2 of the preliminary test.
- 2) A scan was taken on both power lines, Line 1 and Line 2, recording at least the six highest emissions. Emission frequency and amplitude were recorded into a computer in which correction factors were used to calculate the emission level and compare reading to the applicable limit. If EUT emission level was less -2dB to the A.V. limit in Peak mode, then the emission signal was re-checked using Q.P and Average detector.
- 3) The test data of the worst case condition(s) was reported on the Summary Data page.

10.5 TEST RESULT OF POWER LINE

N/A

Note: The BT function of EUT didn't work when charging.



11. ANTENNA REQUIREMENT

Standard Applicable

For intentional device, according to FCC 47 CFR Section 15.203, an intentional radiator shall be designed to ensure that no antenna other than that furnished by the responsible party shall be used with the device.

Refer to statement below for compliance.

The manufacturer may design the unit so that the user can replace a broken antenna, but the use of a standard antenna jack or electrical connector is prohibited. Further, this requirement does not apply to intentional radiators that must be professionally installed.

ANTENNA

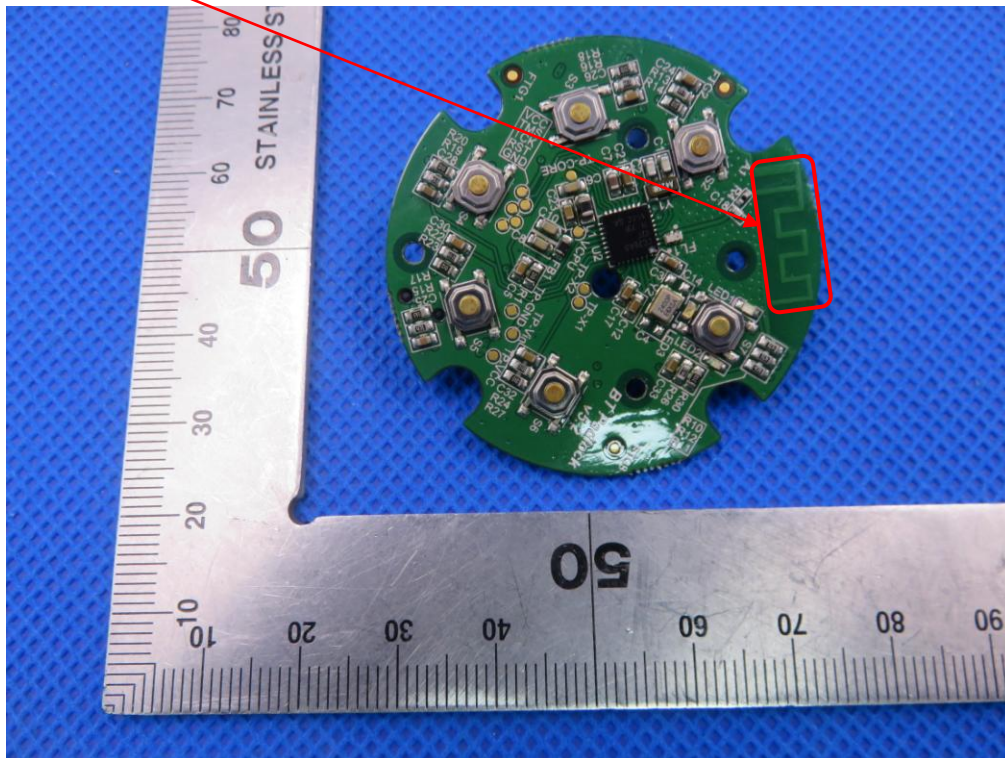



12. PHOTOGRAPH OF TEST

FCC RADIATED EMISSION TEST SETUP

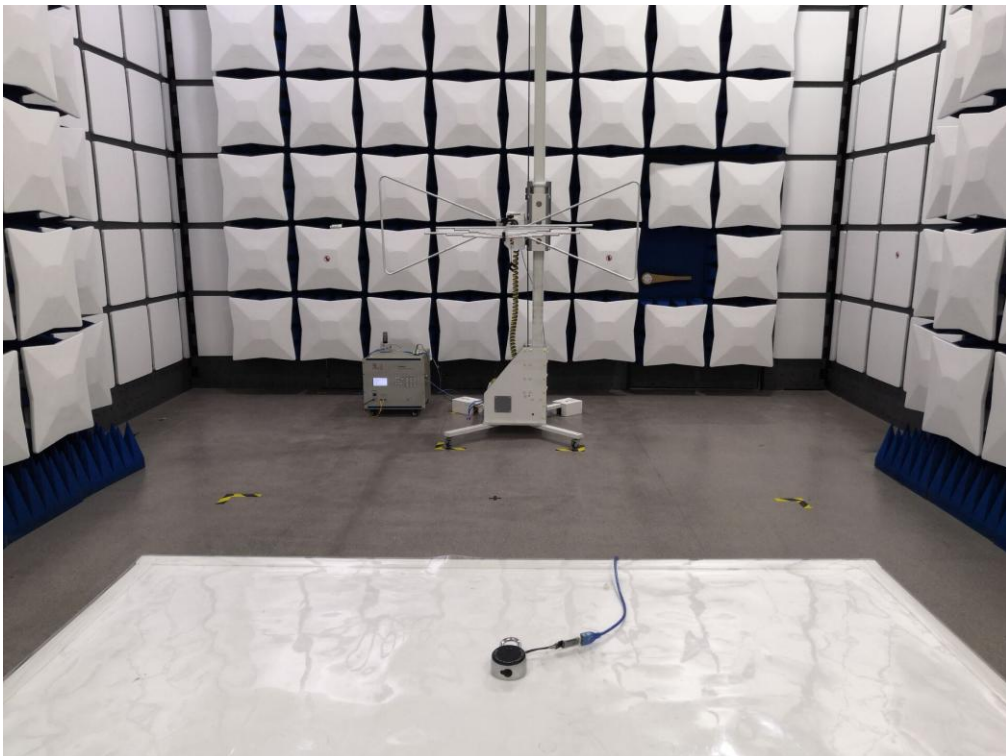
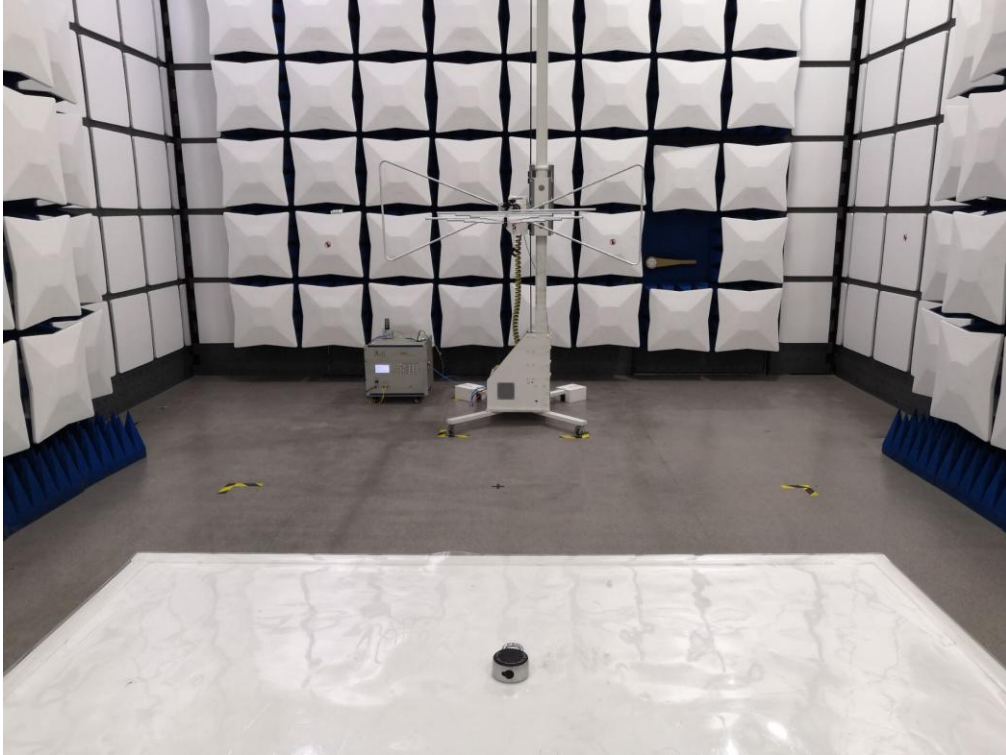





13. PHOTOGRAPHS OF EUT

TOP VIEW OF EUT



BOTTOM VIEW OF EUT





FRONT VIEW OF EUT

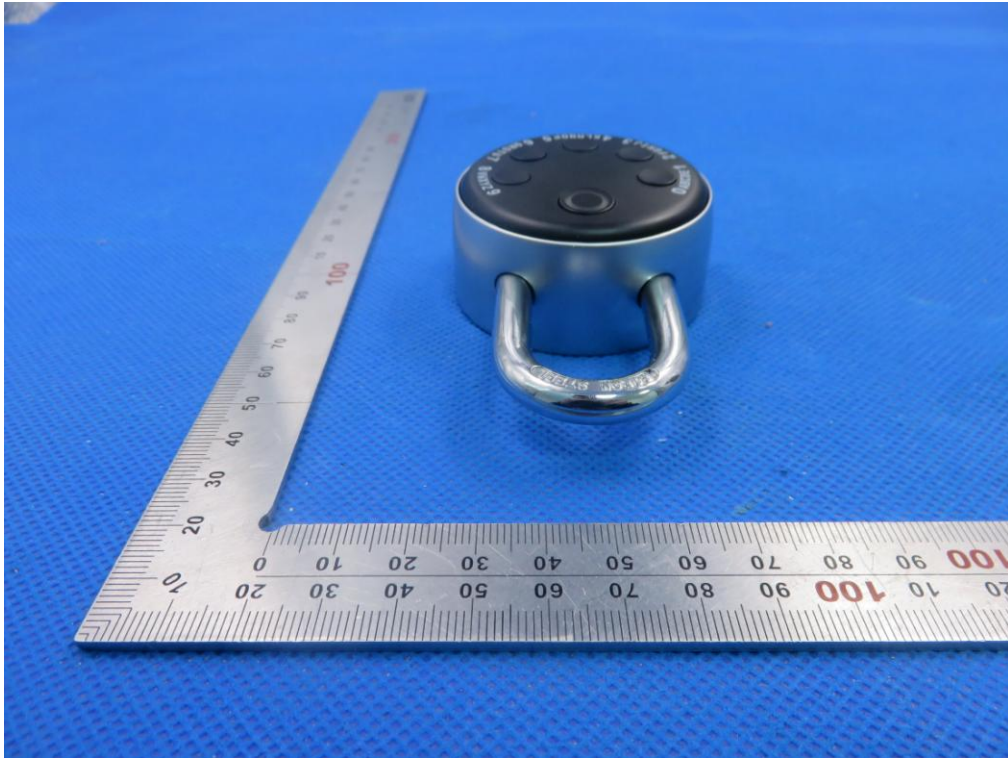

BACK VIEW OF EUT

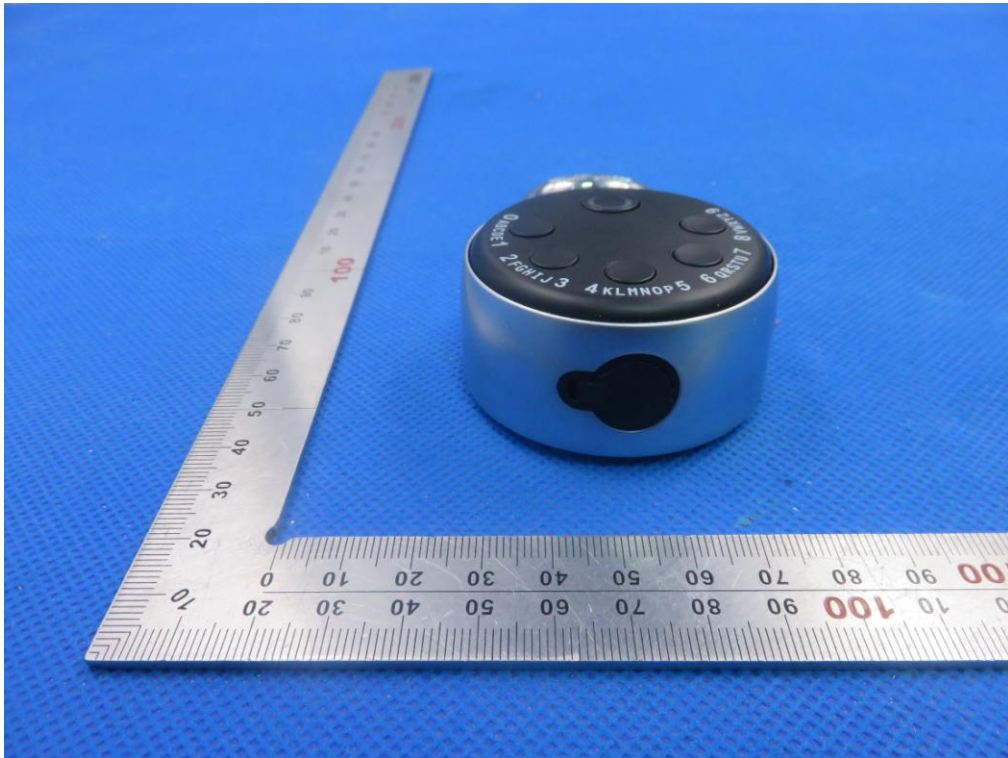



LEFT VIEW OF EUT



RIGHT VIEW OF EUT





VIEW OF EUT (PORT)



OPEN VIEW OF EUT





INTERNAL VIEW OF EUT-1

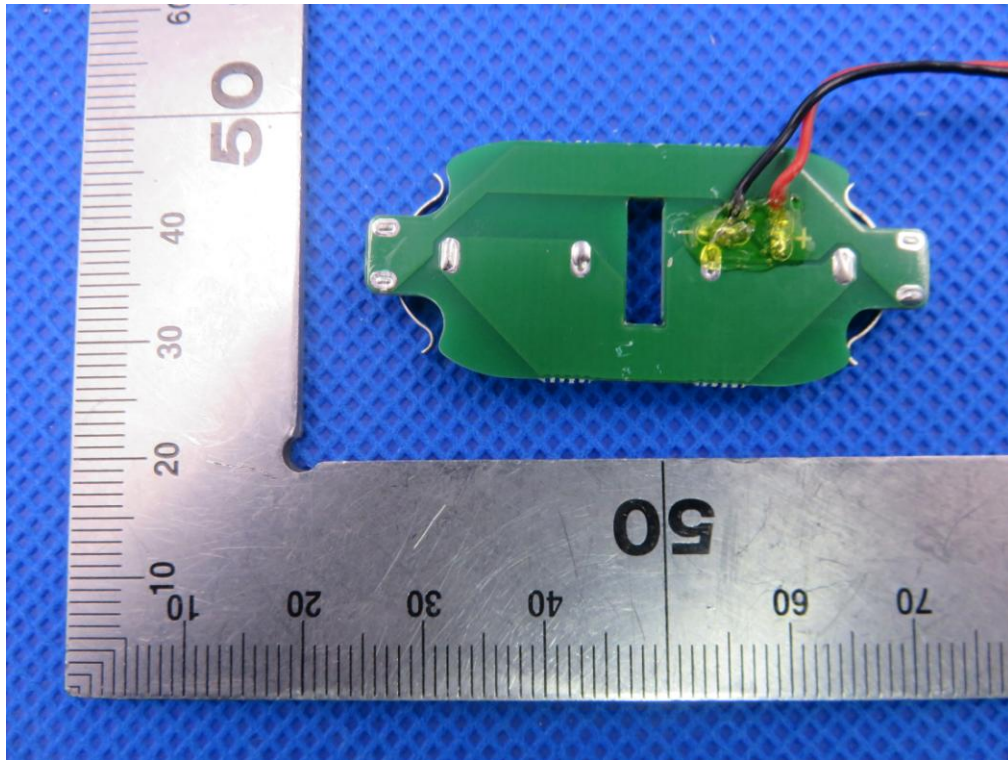

INTERNAL VIEW OF EUT-2

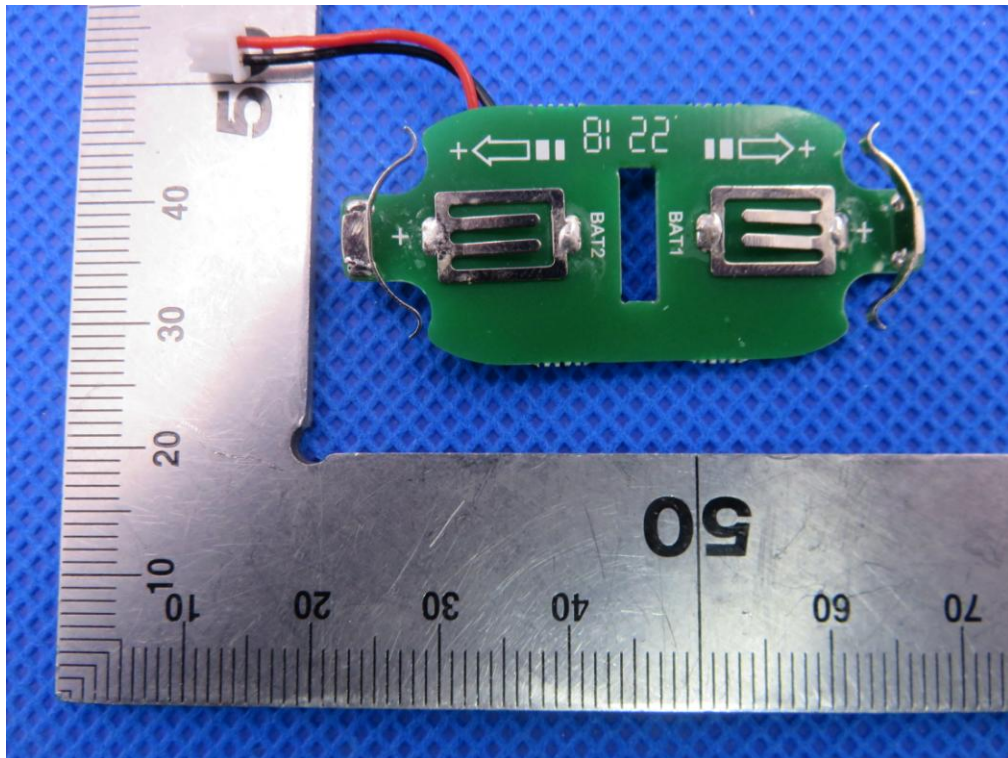



INTERNAL VIEW OF EUT-3

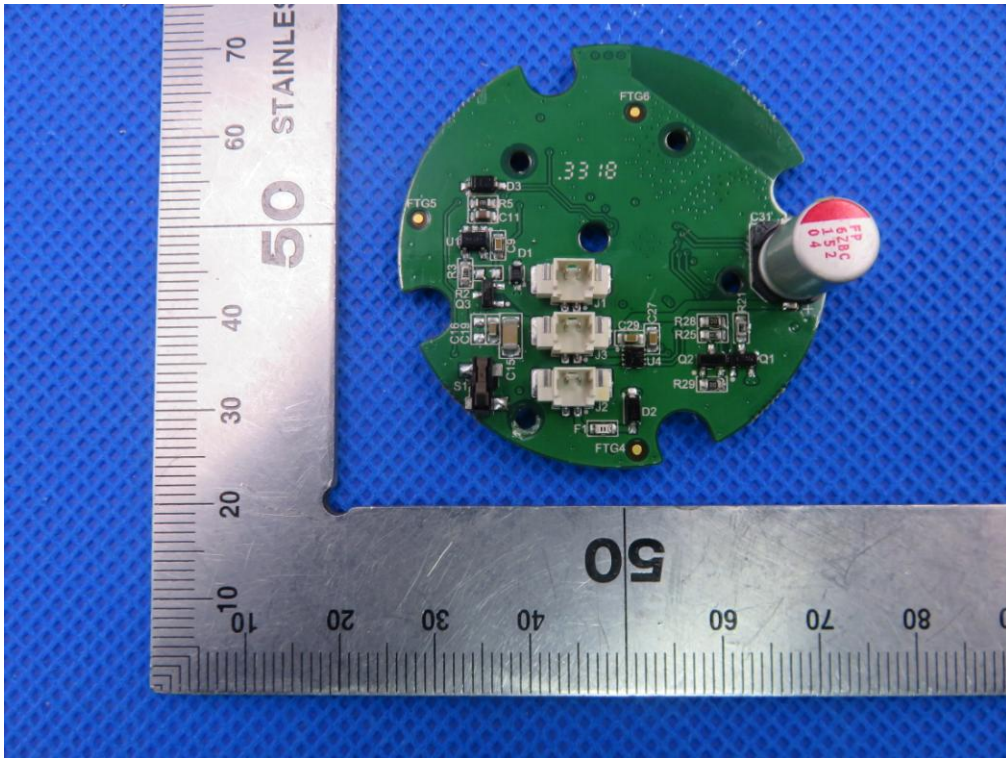

INTERNAL VIEW OF EUT-4

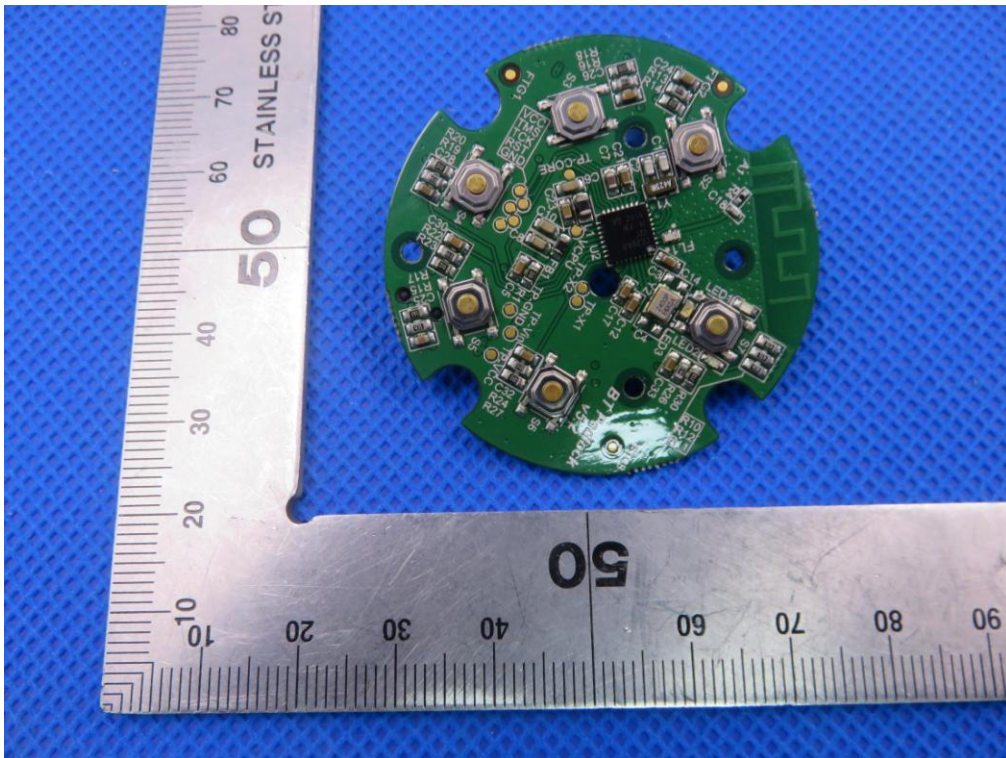



INTERNAL VIEW OF EUT-5

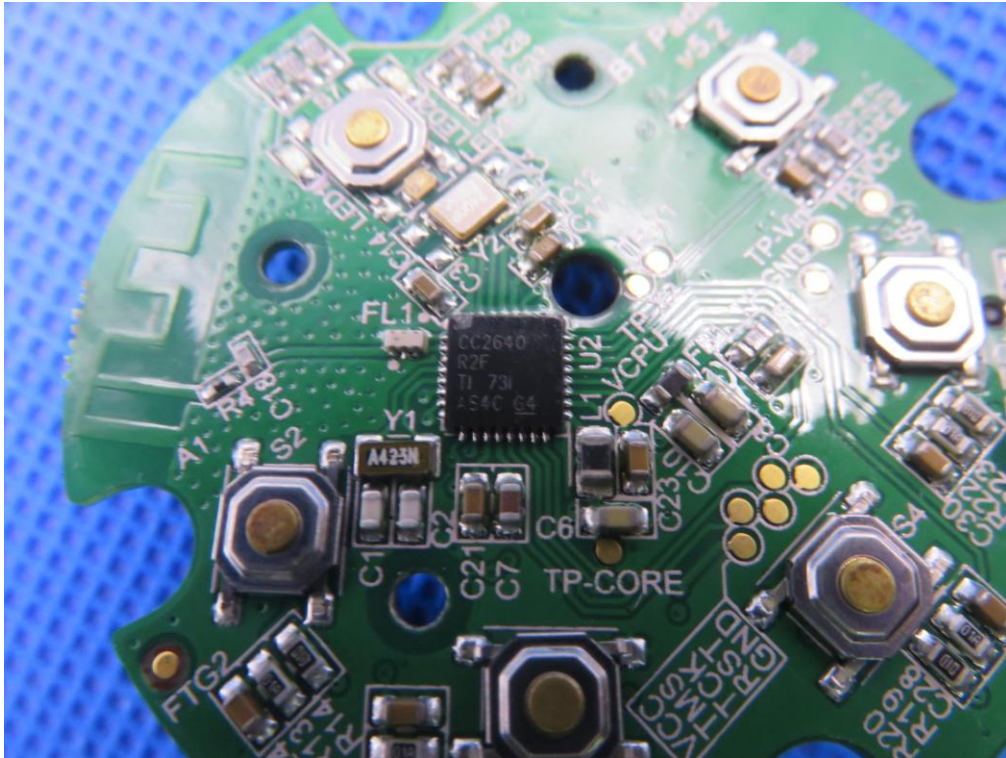

----END OF REPORT----