

TEST REPORT

Report No..... : KS2310S5495E02
FCC ID..... : 2AR37-TRRTC01
Applicant..... : Jiaxing TR-Technology Co., Ltd
Address..... : Building 2, No. 250 Lingfang Road, Youchegang Town, Xiuzhou District, Jiaxing, Zhejiang, China. 314019
Manufacturer..... : Jiaxing TR-Technology Co., Ltd
Address..... : Building 2, No. 250 Lingfang Road, Youchegang Town, Xiuzhou District, Jiaxing, Zhejiang, China. 314019
Product Name..... : Cooler box speaker
Model/Type reference..... : TR-RTC01
Standard..... : 47 CFR Part 15.247
Date of Receipt..... : October 31, 2023
Date of Test Date..... : October 31, 2023 to November 24, 2023
Date of issue..... : November 24, 2023
Test result..... : Pass

Conclusion..... : The submitted sample was found to COMPLY with the standards above.

Prepared by:
(Printed name + Signature) Pai Zheng



Approved by:
(Printed name + Signature) Sky Dong



Testing Laboratory Name...: KSIGN(Guangdong) Testing Co., Ltd.

Address..... : West Side of 1/F., Building C, Zone A, Fuyuan New Factory, Jiujiu Industrial Park, Minzhu, Shatou, Shajing, Bao'an District, Shenzhen, Guangdong, China

TABLE OF CONTENTS**Page**

1. TEST SUMMARY	3
1.1. Test Standards	3
1.2. Report Version	3
1.3. Test Description	4
1.4. Test Facility	5
1.5. Measurement Uncertainty	5
2. GENERAL INFORMATION	6
2.1. General Description Of EUT	6
2.2. Accessory Equipment Information	6
2.3. Description of Test Modes	6
2.4. Operation channel list	7
2.5. Measurement Instruments List	8
3. Evaluation Results (Evaluation)	10
3.1. Antenna requirement	10
4. Radio Spectrum Matter Test Results (RF)	11
4.1. Conducted Emission at AC power line	11
4.2. Occupied Bandwidth	14
4.3. Maximum Conducted Output Power	15
4.4. Power Spectral Density	16
4.5. Emissions in non-restricted frequency bands	17
4.6. Band edge emissions (Radiated)	18
4.7. Emissions in frequency bands (below 1GHz)	23
4.8. Emissions in frequency bands (above 1GHz)	26
5. EUT TEST PHOTOS	33
6. PHOTOGRAPHS OF EUT CONSTRUCTIONAL	35
Appendix	35
6.1. Appendix A: DTS Bandwidth	36
6.2. Appendix B: Occupied Channel Bandwidth	39
6.3. Appendix C: Maximum conducted output power	42
6.4. Appendix D: Maximum power spectral density	45
6.5. Appendix E: Reference level measurement	48
6.6. Appendix F: Band edge measurements	51
6.7. Appendix G: Conducted Spurious Emission	53
6.8. Appendix H: Duty Cycle	57

1. TEST SUMMARY

1.1. Test Standards

The tests were performed according to following standards:

47 CFR Part 15.247: Operation within the bands 902-928 MHz, 2400-2483.5 MHz, and 5725-5850 MHz

ANSI C63.10-2013: American National Standard of Procedures for Compliance Testing of Unlicensed Wireless Devices.

KDB 558074 D01 15.247 Meas Guidance v05r02: Guidance for compliance measurements on digital transmission system, frequency hopping spread spectrum system, and hybrid system devices operating under section 15.247 of the FCC rules.

1.2. Report Version

Revised No.	Date of issue	Description
01	November 24, 2023	Original

1.3. Test Description

Test Item	Standard	Requirement	Result
Antenna requirement	47 CFR Part 15.247	47 CFR 15.203	Pass
Conducted Emission at AC power line	47 CFR Part 15.247	47 CFR 15.207(a)	Pass
Occupied Bandwidth	47 CFR Part 15.247	47 CFR 15.247(a)(2)	Pass
Maximum Conducted Output Power	47 CFR Part 15.247	47 CFR 15.247(b)(3)	Pass
Power Spectral Density	47 CFR Part 15.247	47 CFR 15.247(e)	Pass
Emissions in non-restricted frequency bands	47 CFR Part 15.247	47 CFR 15.247(d), 15.209, 15.205	Pass
Band edge emissions (Radiated)	47 CFR Part 15.247	47 CFR 15.247(d), 15.209, 15.205	Pass
Emissions in frequency bands (below 1GHz)	47 CFR Part 15.247	47 CFR 15.247(d), 15.209, 15.205	Pass
Emissions in frequency bands (above 1GHz)	47 CFR Part 15.247	47 CFR 15.247(d), 15.209, 15.205	Pass

TRF RF_R1

Add: West Side of 1/F., Building C, Zone A, Fuyuan New Factory, Jiujiu Industrial Park, Minzhu, Shatou, Shajing, Bao'an District, Shenzhen, Guangdong, China

Tel: +(86) 0755-2985 2678 Fax: +(86) 0755-2985 2397 E-mail: info@gdkesign.cn Web: www.gdkesign.com

1.4. Test Facility

KSIGN(Guangdong) Testing Co., Ltd.

West Side of 1/F., Building C, Zone A, Fuyuan New Factory, Jiujiu Industrial Park, Minzhu, Shatou, Shajing, Bao'an District, Shenzhen, Guangdong, China

The test facility is recognized, certified, or accredited by the following organizations:

CNAS-Lab Code: L13261

KSIGN(Guangdong) Testing Co., Ltd. has been assessed and proved to be in Compliance with CNAS-CL01 Accreditation Criteria for Testing and Calibration Laboratories (identical to ISO/IEC17025: 2017 General Requirements) for the Competence of Testing and Calibration Laboratories.

A2LA-Lab Cert. No.: 5457.01

KSIGN(Guangdong) Testing Co., Ltd. EMC Laboratory has been accredited by A2LA for technical competence in the field of electrical testing, and proved to be in compliance with ISO/IEC 17025:2017 General Requirements for the Competence of Testing and Calibration Laboratories and any additional program requirements in the identified field of testing

ISED#: 25693 CAB identifier.: CN0096

KSIGN(Guangdong) Testing Co., Ltd. has been listed by Innovation, Science and Economic Development Canada to perform electromagnetic emission measurement.

FCC-Registration No.: 294912 Designation Number: CN1328

KSIGN(Guangdong) Testing Co., Ltd. EMC Laboratory has been listed on the US Federal Communications Commission list of test facilities recognized to perform electromagnetic emissions measurements.

1.5. Measurement Uncertainty

Test Items	Measurement Uncertainty
Conducted Emission (150k-30MHz)	± 3.34dB
Output Power, Conducted	± 1.4dB
PSD, Conducted	± 1.0dB
Spurious Emissions, Conducted	± 3.3dB
RSE (1-18GHz)	± 4.68dB
RSE (30-1000MHz)	± 5.7dB
RSE (18-40GHz)	± 5.18dB

The reported uncertainty of measurement $y \pm U$, where expanded uncertainty U is based on a standard uncertainty multiplied by a coverage factor of $k=2$, providing a level of confidence of approximately 95 %. Otherwise required by the applicant or Product Regulations. Decision Rule in this report did not consider the uncertainty.

2. GENERAL INFORMATION

2.1. General Description Of EUT

Test Sample Number:	1-1(Normal Sample), 1-2(Engineering Sample)
Product Name:	Cooler box speaker
Model / Type reference:	TR-RTC01
Power Supply:	Battery powered DC 3.7V
Power Adaptor:	DC 5V
Operation Frequency:	2402MHz to 2480MHz
Number of Channels:	40
Modulation Type:	GFSK
Antenna Type:	PCB Antenna
Antenna Gain:	1.7dBi
Max TX Power:	0.69dBm
Hardware Version:	V1.0
Software Version:	V1.0.0

Note:Antenna gain provided by the applicant Can affect the validity of results

2.2. Accessory Equipment Information

The EUT was tested as an independent device.

2.3. Description of Test Modes

No.	Title	Description of Mode
Test Mode1	TX mode	Keep the EUT connect to AC power line and works in continuously transmitting mode with GFSK modulation.

2.4. Operation channel list

Channel	Frequency (MHz)	Channel	Frequency (MHz)	Channel	Frequency (MHz)	Channel	Frequency (MHz)
0	2402	10	2422	20	2442	30	2462
1	2404	11	2424	21	2444	31	2464
2	2406	12	2426	22	2446	32	2466
3	2408	13	2428	23	2448	33	2468
4	2410	14	2430	24	2450	34	2470
5	2412	15	2432	25	2452	35	2472
6	2414	16	2434	26	2454	36	2474
7	2416	17	2436	27	2456	37	2476
8	2418	18	2438	28	2458	38	2478
9	2420	19	2440	29	2460	39	2480

TRF RF_R1

Add: West Side of 1/F., Building C, Zone A, Fuyuan New Factory, Jiujiu Industrial Park, Minzhu, Shatou, Shajing, Bao'an District, Shenzhen, Guangdong, China

Tel: +(86) 0755-2985 2678 Fax: +(86) 0755-2985 2397 E-mail: info@gdkesign.cn Web: www.gdkesign.com

2.5. Measurement Instruments List

Conducted Emission at AC power line				
Test Equipment	Manufacturer	Model No.	Serial No.	Cal. Until
LISN	R&S	ENV432	1326.6105.02	2024-02-17
EMI Test Receiver	R&S	ESR	102524	2024-02-17
Manual RF Switch	JS TOYO	/	MSW-01/002	2024-02-17
ISN CAT6	Schwarzbeck	CAT5 8158	227	2024-02-17
Color Signal Generator	Philips	PM5418	672926	2024-02-17
Power Absorbing Clamp	R&S	MDS-21	100925	2024-02-19

Occupied Bandwidth Maximum Conducted Output Power Power Spectral Density Emissions in non-restricted frequency bands				
Test Equipment	Manufacturer	Model No.	Serial No.	Cal. Until
Wideband Radio Communication Tester	R&S	CMU200	115297	2024-02-17
Audio Analyzer	R&S	UPL16	100001	2024-02-17
Shielding box	Gxiong	GX-5915A	2201113	2024-02-17
High Pass Filter	COM-MW Technology Co., Ltd	ZHPF-M1.2-9G-1 87	09203403	2024-02-17
Band Stop Filter	COM-MW Technology Co., Ltd	ZBSF6-C820-920 -188	09203401	2024-02-17
Splitter	COM-MW Technology Co., Ltd	ZPD-M1-8-2103	09203407	2024-02-17
Coaxial Cable	BEBES	A40-2.92M2.92F-4.5M	1907021	2024-02-17
Hygrothermograph	Anymetre	JB913	/	2024-02-17
Climate Chamber	Angul	AGNH80L	1903042120	2024-02-17
Spectrum Analyzer	HP	8593E	3831U02087	2024-02-17
Dual Output DC Power Supply	Agilent	E3646A	MY40009992	2024-02-17
RF Control Unit	Tonscend	JS0806-2	/	2024-02-17
Analog Signal Generator	HP	83752A	3344A00337	2024-02-17
Vector Signal Generator	Agilent	N5182A	MY50142520	2024-02-17
Wideband Radio Communication Tester	R&S	CMW500	157282	2024-02-17
Spectrum Analyzer	R&S	FSV40-N	101798	2024-02-17

TRF RF_R1

Add: West Side of 1/F., Building C, Zone A, Fuyuan New Factory, Jiujiu Industrial Park, Minzhu, Shatou, Shajing, Bao'an District, Shenzhen, Guangdong, China

Tel: +(86) 0755-2985 2678 Fax: +(86) 0755-2985 2397 E-mail: info@gdkesign.cn Web: www.gdkesign.com

Band edge emissions (Radiated)				
Emissions in frequency bands (below 1GHz)				
Emissions in frequency bands (above 1GHz)				
Test Equipment	Manufacturer	Model No.	Serial No.	Cal. Until
Color Signal Generator	Philips	PM5418	672926	2024-02-17
Ultra-Broadband logarithmic period Antenna	Schwarzbeck	VULB 9163	1230	2025-02-18
Pre-Amplifier	Schwarzbeck	BBV 9745	9745#129	2024-02-17
Broadcast Television Signal Generator	R&S	SFE100	141038	2024-02-17
Analog Signal Generator	Agilent	8648A	3847M00445	2024-02-17
EMI Test Receiver	R&S	ESR	102525	2024-02-17
Loop Antenna	Beijin ZHINAN	ZN30900C	18050	2024-02-19
Horn Antenna	Schwarzbeck	BBHA 9120 D	2023	2026-02-19
Pre-Amplifier	EMCI	EMC051835SE	980662	2024-02-17
Spectrum Analyzer	Keysight	N9020A	MY46471971	2024-02-17

TRF RF_R1

Add: West Side of 1/F., Building C, Zone A, Fuyuan New Factory, Jiujiu Industrial Park, Minzhu, Shatou, Shajing, Bao'an District, Shenzhen, Guangdong, China

Tel: +(86) 0755-2985 2678 Fax: +(86) 0755-2985 2397 E-mail: info@gdkesign.cn Web: www.gdkesign.com

3. Evaluation Results (Evaluation)

3.1. Antenna requirement

Test Requirement:	Refer to 47 CFR Part 15.203, an intentional radiator shall be designed to ensure that no antenna other than that furnished by the responsible party shall be used with the device. The use of a permanently attached antenna or of an antenna that uses a unique coupling to the intentional radiator shall be considered sufficient to comply with the provisions of this section.
-------------------	-------------------------------------------------------------------------------------------------------------------------------------------------------------------------------------------------------------------------------------------------------------------------------------------------------------------------------------------------------------------------------------

3.1.1. Conclusion:

The directional gain of the antenna less than 6dBi. It comply with the standard requirement. In case of replacement of broken antenna the same antenna type must be used. Antenna structure please refer to the EUT internal photographs antenna photo.

4. Radio Spectrum Matter Test Results (RF)

4.1. Conducted Emission at AC power line

Test Requirement:	Refer to 47 CFR 15.207(a), Except as shown in paragraphs (b) and (c) of this section, for an intentional radiator that is designed to be connected to the public utility (AC) power line, the radio frequency voltage that is conducted back onto the AC power line on any frequency or frequencies, within the band 150 kHz to 30 MHz, shall not exceed the limits in the following table, as measured using a 50 μ H/50 ohms line impedance stabilization network (LISN).		
Test Limit:	Frequency of emission (MHz)	Conducted limit (dB μ V)	
		Quasi-peak	Average
	0.15-0.5	66 to 56*	56 to 46*
	0.5-5	56	46
	5-30	60	50
	*Decreases with the logarithm of the frequency.		
Test Method:	ANSI C63.10-2013 section 6.2		
Procedure:	Refer to ANSI C63.10-2013 section 6.2, standard test method for ac power-line conducted emissions from unlicensed wireless devices		

4.1.1. E.U.T. Operation:

Operating Environment:	
Temperature:	24.2 °C
Humidity:	42.8 %
Atmospheric Pressure:	102 kPa
Final test mode:	Test Mode 1

4.1.2. Test Setup Diagram:

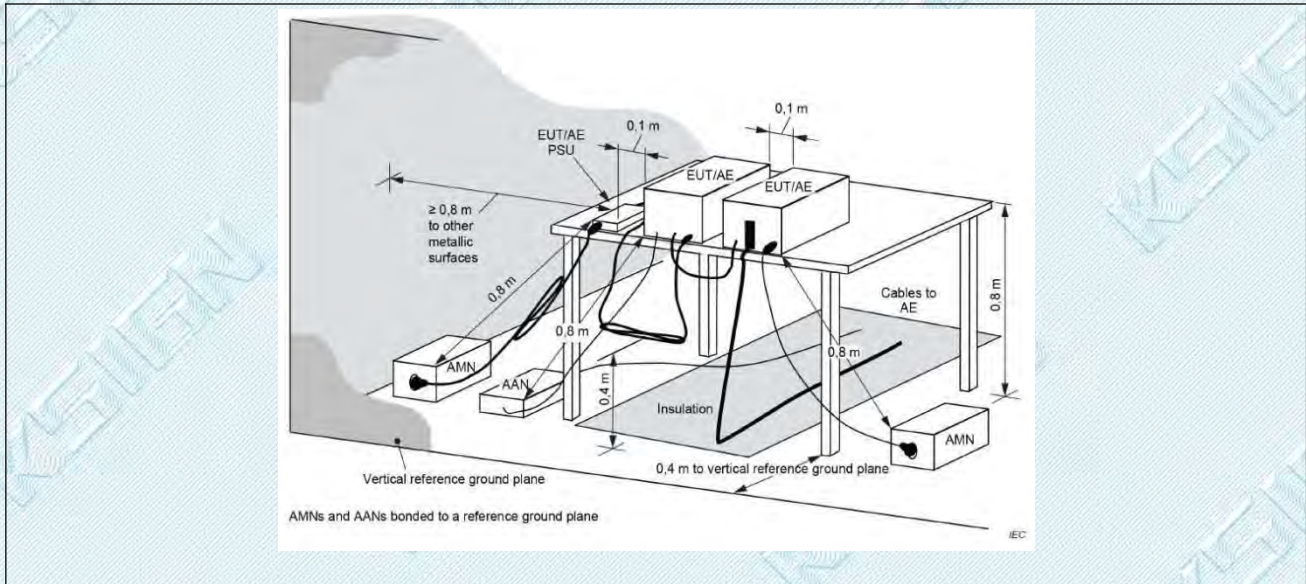

4.1.3. Test Data:

Test Mode1 / Line: Line / Band: 2400-2483.5 MHz / BW: 1 / CH: M

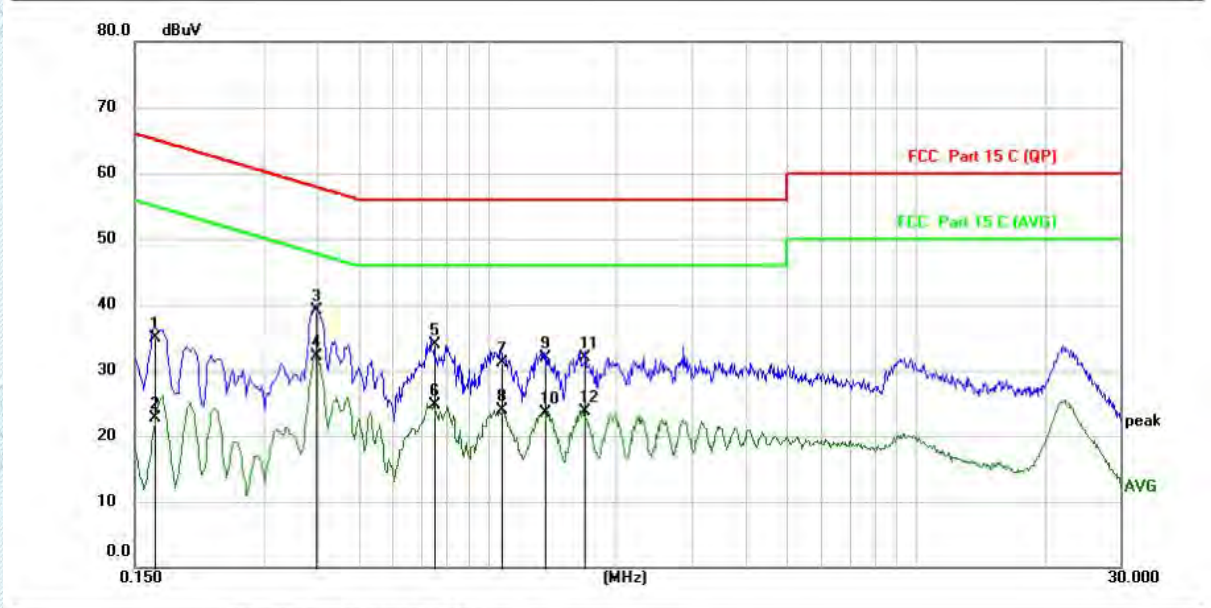

No. Mk.	Freq. MHz	Reading Level dBuV	Correct Factor dB	Measurement dBuV	Limit dBuV	Over dB	Detector	Comment
1	0.1675	23.83	11.09	34.92	65.08	-30.16	QP	
2	0.1675	11.67	11.09	22.76	55.08	-32.32	AVG	
3	0.3980	28.20	10.99	39.19	57.90	-18.71	QP	
4 *	0.3980	21.07	10.99	32.06	47.90	-15.84	AVG	
5	0.7500	22.84	11.04	33.88	56.00	-22.12	QP	
6	0.7500	13.67	11.04	24.71	46.00	-21.29	AVG	
7	1.0820	20.14	11.06	31.20	56.00	-24.80	QP	
8	1.0820	12.78	11.06	23.84	46.00	-22.16	AVG	
9	1.3580	20.77	11.11	31.88	56.00	-24.12	QP	
10	1.3580	12.31	11.11	23.42	46.00	-22.58	AVG	
11	1.6738	20.82	11.14	31.96	56.00	-24.04	QP	
12	1.6738	12.56	11.14	23.70	46.00	-22.30	AVG	

TRF RF_R1

Add: West Side of 1/F., Building C, Zone A, Fuyuan New Factory, Jiujiu Industrial Park, Minzhu, Shatou, Shajing, Bao'an District, Shenzhen, Guangdong, China

Tel: +(86) 0755-2985 2678 Fax: +(86) 0755-2985 2397 E-mail: info@gdkesign.cn Web: www.gdkesign.com

Test Mode1 / Line: Neutral / Band: 2400-2483.5 MHz / BW: 1 / CH: M

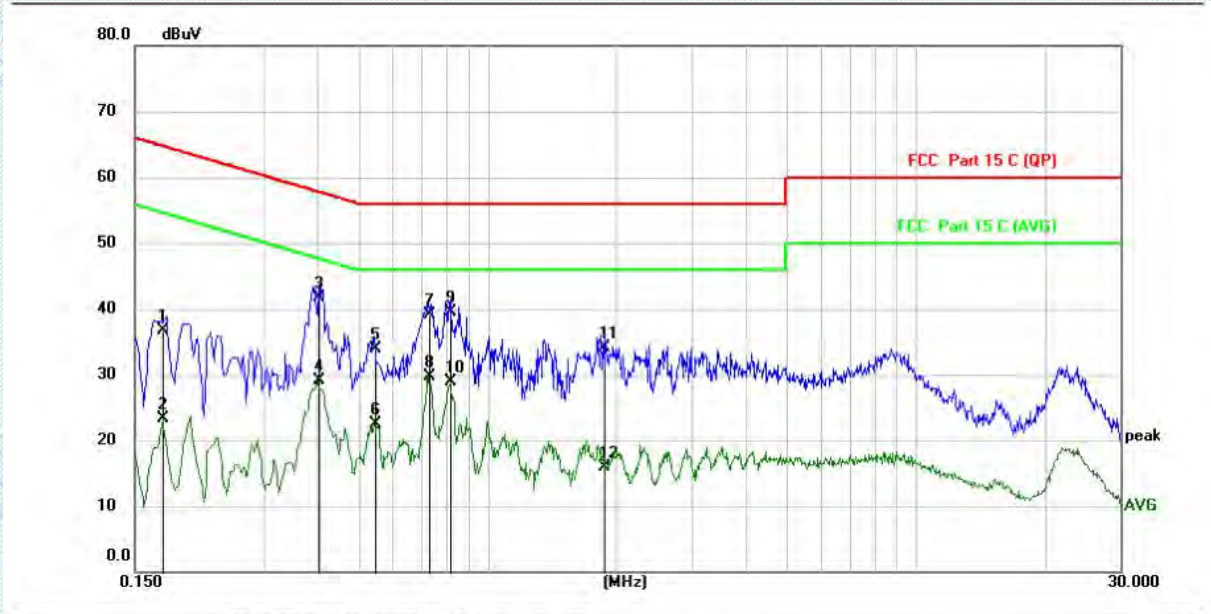

No. Mk.	Freq. MHz	Reading Level dBuV	Correct Factor dB	Measure- ment dBuV	Limit dBuV	Over dB	Detector	Comment
1	0.1737	25.72	11.08	36.80	64.78	-27.98	QP	
2	0.1737	12.20	11.08	23.28	54.78	-31.50	AVG	
3 *	0.4020	30.69	11.00	41.69	57.81	-16.12	QP	
4	0.4020	18.15	11.00	29.15	47.81	-18.66	AVG	
5	0.5460	22.97	11.01	33.98	56.00	-22.02	QP	
6	0.5460	11.49	11.01	22.50	46.00	-23.50	AVG	
7	0.7300	27.97	11.05	39.02	56.00	-16.98	QP	
8	0.7300	18.62	11.05	29.67	46.00	-16.33	AVG	
9	0.8178	28.52	11.05	39.57	56.00	-16.43	QP	
10	0.8178	17.84	11.05	28.89	46.00	-17.11	AVG	
11	1.8778	23.05	11.15	34.20	56.00	-21.80	QP	
12	1.8778	4.69	11.15	15.84	46.00	-30.16	AVG	

TRF RF_R1

Add: West Side of 1/F., Building C, Zone A, Fuyuan New Factory, Jiujiu Industrial Park, Minzhu, Shatou, Shajing, Bao'an District, Shenzhen, Guangdong, China

Tel: +(86) 0755-2985 2678 Fax: +(86) 0755-2985 2397 E-mail: info@gdkesign.cn Web: www.gdkesign.com

4.2. Occupied Bandwidth

Test Requirement:	47 CFR 15.247(a)(2)
Test Limit:	Refer to 47 CFR 15.247(a)(2), Systems using digital modulation techniques may operate in the 902-928 MHz, and 2400-2483.5 MHz bands. The minimum 6 dB bandwidth shall be at least 500 kHz.
Test Method:	ANSI C63.10-2013, section 11.8 KDB 558074 D01 15.247 Meas Guidance v05r02
Procedure:	<ul style="list-style-type: none"> a) Set RBW = 100 kHz. b) Set the VBW \geq [3 × RBW]. c) Detector = peak. d) Trace mode = max hold. e) Sweep = auto couple. f) Allow the trace to stabilize. g) Measure the maximum width of the emission that is constrained by the frequencies associated with the two outermost amplitude points (upper and lower frequencies) that are attenuated by 6 dB relative to the maximum level measured in the fundamental emission.

4.2.1. E.U.T. Operation:

Operating Environment:	
Temperature:	24.2 °C
Humidity:	42.8 %
Atmospheric Pressure:	102 kPa
Final test mode:	Test Mode1

4.2.2. Test Setup Diagram:

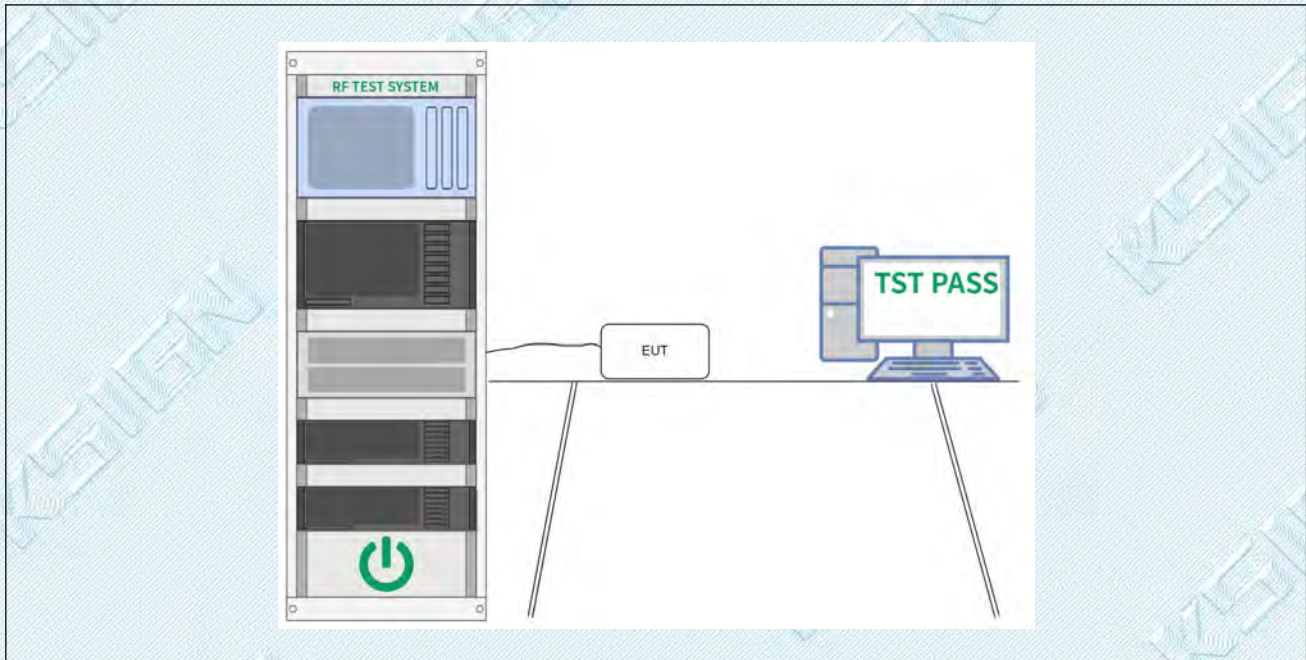

4.2.3. Test Data:

Please Refer to Appendix for Details.

4.3. Maximum Conducted Output Power

Test Requirement:	47 CFR 15.247(b)(3)
Test Limit:	Refer to 47 CFR 15.247(b)(3), For systems using digital modulation in the 902-928 MHz, 2400-2483.5 MHz, and 5725-5850 MHz bands: 1 Watt. As an alternative to a peak power measurement, compliance with the one Watt limit can be based on a measurement of the maximum conducted output power. Maximum Conducted Output Power is defined as the total transmit power delivered to all antennas and antenna elements averaged across all symbols in the signaling alphabet when the transmitter is operating at its maximum power control level. Power must be summed across all antennas and antenna elements. The average must not include any time intervals during which the transmitter is off or is transmitting at a reduced power level. If multiple modes of operation are possible (e.g., alternative modulation methods), the maximum conducted output power is the highest total transmit power occurring in any mode.
Test Method:	ANSI C63.10-2013, section 11.9.1 KDB 558074 D01 15.247 Meas Guidance v05r02
Procedure:	ANSI C63.10-2013, section 11.9.1 Maximum peak conducted output power

4.3.1. E.U.T. Operation:

Operating Environment:	
Temperature:	24.2 °C
Humidity:	42.8 %
Atmospheric Pressure:	102 kPa
Final test mode:	Test Mode1

4.3.2. Test Setup Diagram:

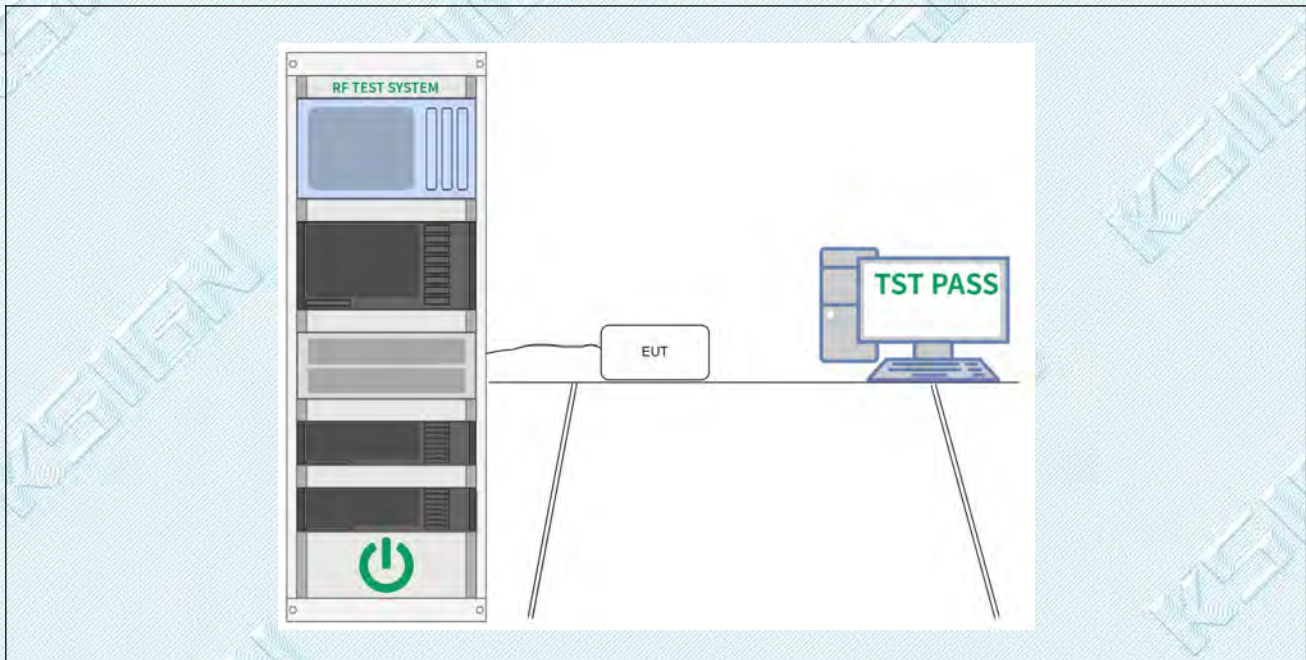

4.3.3. Test Data:

Please Refer to Appendix for Details.

4.4. Power Spectral Density

Test Requirement:	47 CFR 15.247(e)
Test Limit:	Refer to 47 CFR 15.247(e), For digitally modulated systems, the power spectral density conducted from the intentional radiator to the antenna shall not be greater than 8 dBm in any 3 kHz band during any time interval of continuous transmission. This power spectral density shall be determined in accordance with the provisions of paragraph (b) of this section. The same method of determining the conducted output power shall be used to determine the power spectral density.
Test Method:	ANSI C63.10-2013, section 11.10 KDB 558074 D01 15.247 Meas Guidance v05r02
Procedure:	ANSI C63.10-2013, section 11.10, Maximum power spectral density level in the fundamental emission

4.4.1. E.U.T. Operation:

Operating Environment:	
Temperature:	24.2 °C
Humidity:	42.8 %
Atmospheric Pressure:	102 kPa
Final test mode:	Test Mode 1

4.4.2. Test Setup Diagram:

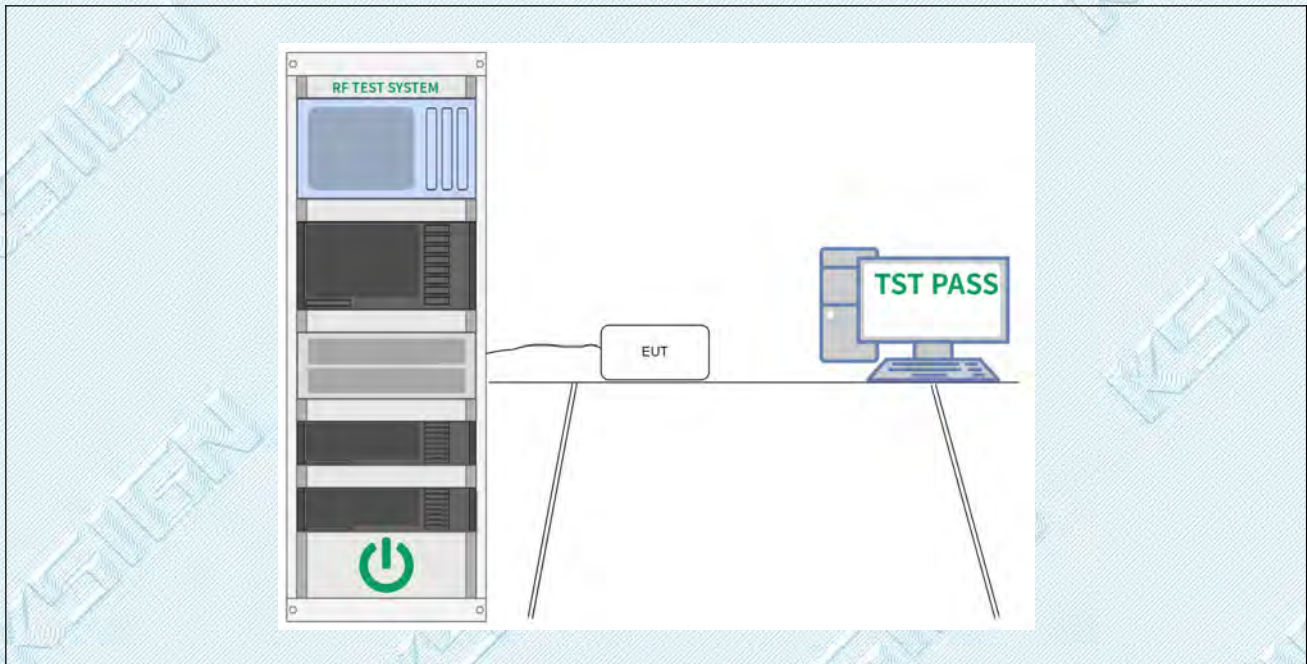

4.4.3. Test Data:

Please Refer to Appendix for Details.

4.5. Emissions in non-restricted frequency bands

Test Requirement:	47 CFR 15.247(d), 15.209, 15.205
Test Limit:	Refer to 47 CFR 15.247(d), In any 100 kHz bandwidth outside the frequency band in which the spread spectrum or digitally modulated intentional radiator is operating, the radio frequency power that is produced by the intentional radiator shall be at least 20 dB below that in the 100 kHz bandwidth within the band that contains the highest level of the desired power, based on either an RF conducted or a radiated measurement, provided the transmitter demonstrates compliance with the peak conducted power limits. If the transmitter complies with the conducted power limits based on the use of RMS averaging over a time interval, as permitted under paragraph (b)(3) of this section, the attenuation required under this paragraph shall be 30 dB instead of 20 dB. Attenuation below the general limits specified in § 15.209(a) is not required.
Test Method:	ANSI C63.10-2013 section 11.11 KDB 558074 D01 15.247 Meas Guidance v05r02
Procedure:	ANSI C63.10-2013 Section 11.11.1, Section 11.11.2, Section 11.11.3

4.5.1. E.U.T. Operation:

Operating Environment:	
Temperature:	24.2 °C
Humidity:	42.8 %
Atmospheric Pressure:	102 kPa
Final test mode:	Test Mode1

4.5.2. Test Setup Diagram:

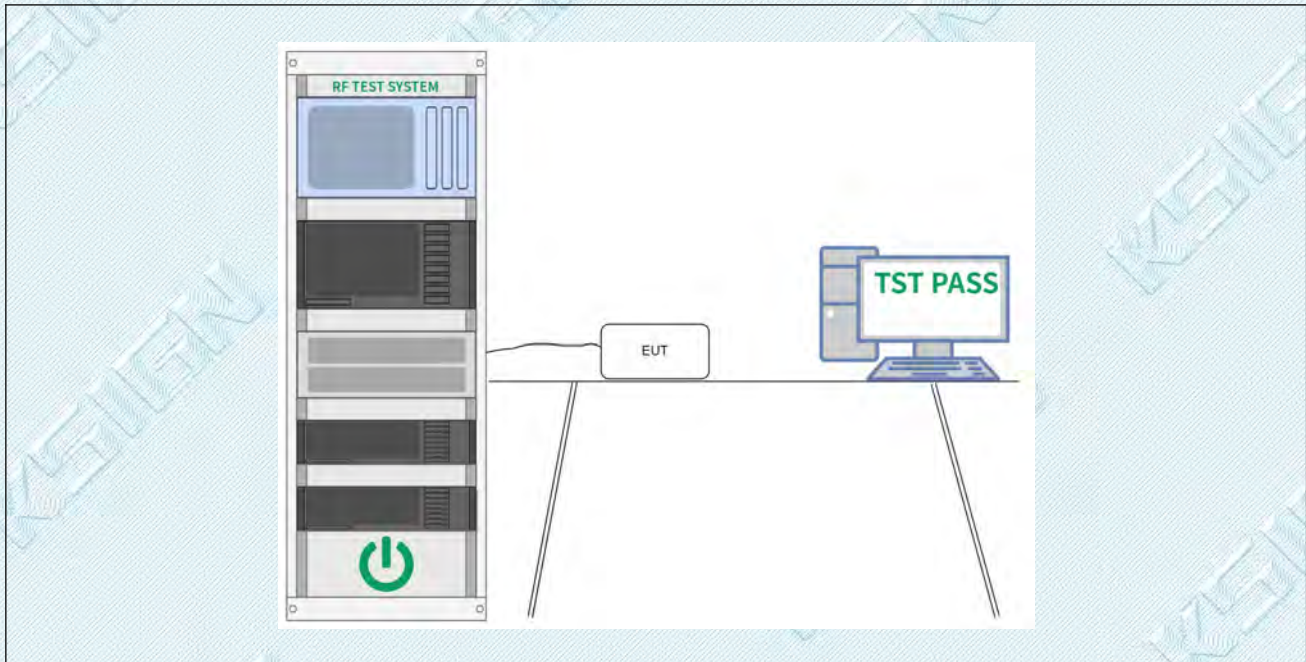

4.5.3. Test Data:

Please Refer to Appendix for Details.

4.6. Band edge emissions (Radiated)

Test Requirement:	Refer to 47 CFR 15.247(d), In addition, radiated emissions which fall in the restricted bands, as defined in § 15.205(a), must also comply with the radiated emission limits specified in § 15.209(a)(see § 15.205(c)).		
Test Limit:	Frequency (MHz)	Field strength (microvolts/meter)	Measurement distance (meters)
	0.009-0.490	2400/F(kHz)	300
	0.490-1.705	24000/F(kHz)	30
	1.705-30.0	30	30
	30-88	100 **	3
	88-216	150 **	3
	216-960	200 **	3
	Above 960	500	3
	** Except as provided in paragraph (g), fundamental emissions from intentional radiators operating under this section shall not be located in the frequency bands 54-72 MHz, 76-88 MHz, 174-216 MHz or 470-806 MHz. However, operation within these frequency bands is permitted under other sections of this part, e.g., §§ 15.231 and 15.241.		
Test Method:	ANSI C63.10-2013 section 6.10 KDB 558074 D01 15.247 Meas Guidance v05r02		
Procedure:	ANSI C63.10-2013 section 6.10.5.2		

4.6.1. E.U.T. Operation:

Operating Environment:	
Temperature:	24.2 °C
Humidity:	42.8 %
Atmospheric Pressure:	102 kPa
Final test mode:	Test Mode 1

4.6.2. Test Setup Diagram:

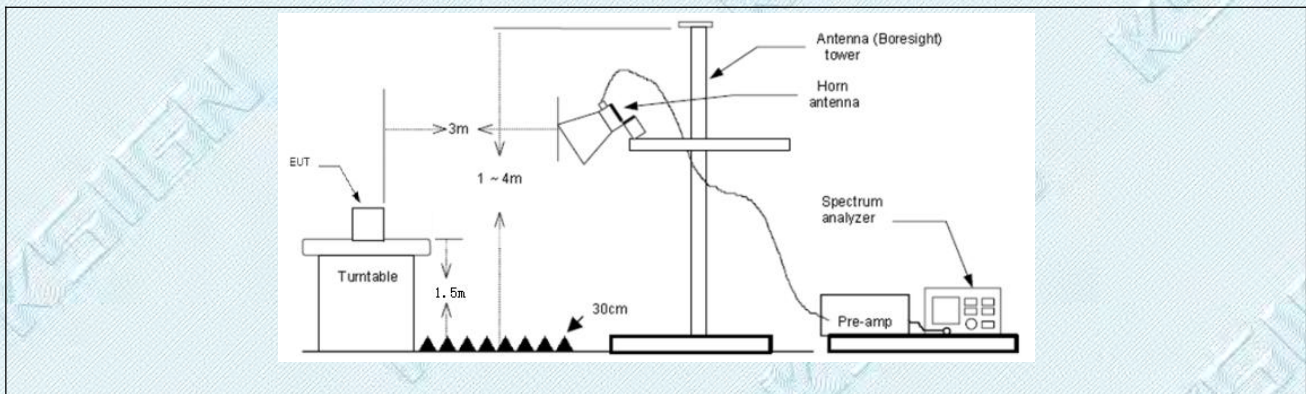

4.6.3. Test Data:

Test Mode1 / Polarization: Horizontal / Band: 2400-2483.5 MHz / BW: 1 / CH: L

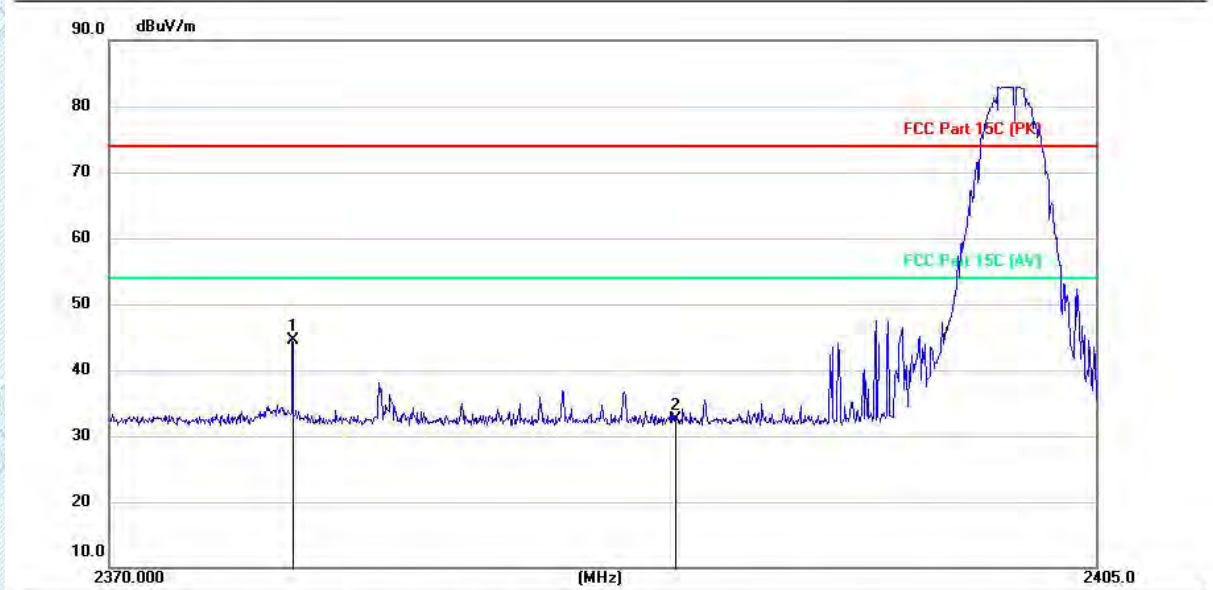

No.	Mk.	Freq. MHz	Reading Level (dBuV)	Correct Factor (dB/m)	Measurement (dBuV/m)	Limit (dBuV/m)	Over (dB)	Detector
1	*	2376.454	54.60	-10.14	44.46	74.00	-29.54	peak
2		2390.000	42.60	-10.12	32.48	74.00	-41.52	peak

TRF RF_R1

Add: West Side of 1/F., Building C, Zone A, Fuyuan New Factory, Jiujiu Industrial Park, Minzhu, Shatou, Shajing, Bao'an District, Shenzhen, Guangdong, China

Tel: +(86) 0755-2985 2678 Fax: +(86) 0755-2985 2397 E-mail: info@gdkesign.cn Web: www.gdkesign.com

Test Mode1 / Polarization: Vertical / Band: 2400-2483.5 MHz / BW: 1 / CH: L

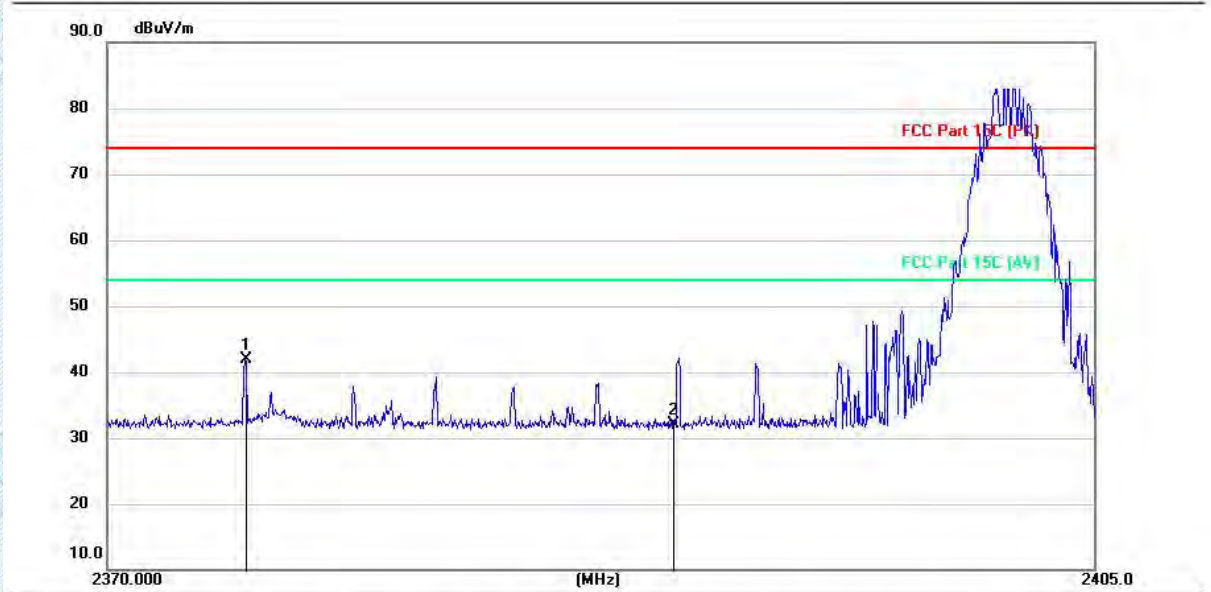

No.	Mk.	Freq. MHz	Reading Level (dBuV)	Correct Factor (dB/m)	Measurement (dBuV/m)	Limit (dBuV/m)	Over (dB)	Detector
1	*	2374.865	52.06	-10.14	41.92	74.00	-32.08	peak
2		2390.000	42.14	-10.12	32.02	74.00	-41.98	peak

TRF RF_R1

Add: West Side of 1/F., Building C, Zone A, Fuyuan New Factory, Jiujiu Industrial Park, Minzhu, Shatou, Shajing, Bao'an District, Shenzhen, Guangdong, China

Tel: +(86) 0755-2985 2678 Fax: +(86) 0755-2985 2397 E-mail: info@gdkesign.cn Web: www.gdkesign.com

Test Mode1 / Polarization: Horizontal / Band: 2400-2483.5 MHz / BW: 1 / CH: H



No.	Mk.	Freq. MHz	Reading Level (dBuV)	Correct Factor (dB/m)	Measurement (dBuV/m)	Limit (dBuV/m)	Over (dB)	Detector
1		2483.500	51.84	-10.09	41.75	74.00	-32.25	peak
2	*	2487.193	62.01	-10.08	51.93	74.00	-22.07	peak

TRF RF_R1

Add: West Side of 1/F., Building C, Zone A, Fuyuan New Factory, Jiujiu Industrial Park, Minzhu, Shatou, Shajing, Bao'an District, Shenzhen, Guangdong, China

Tel: +(86) 0755-2985 2678 Fax: +(86) 0755-2985 2397 E-mail: info@gdksign.cn Web: www.gdksign.com

Test Mode1 / Polarization: Vertical / Band: 2400-2483.5 MHz / BW: 1 / CH: H

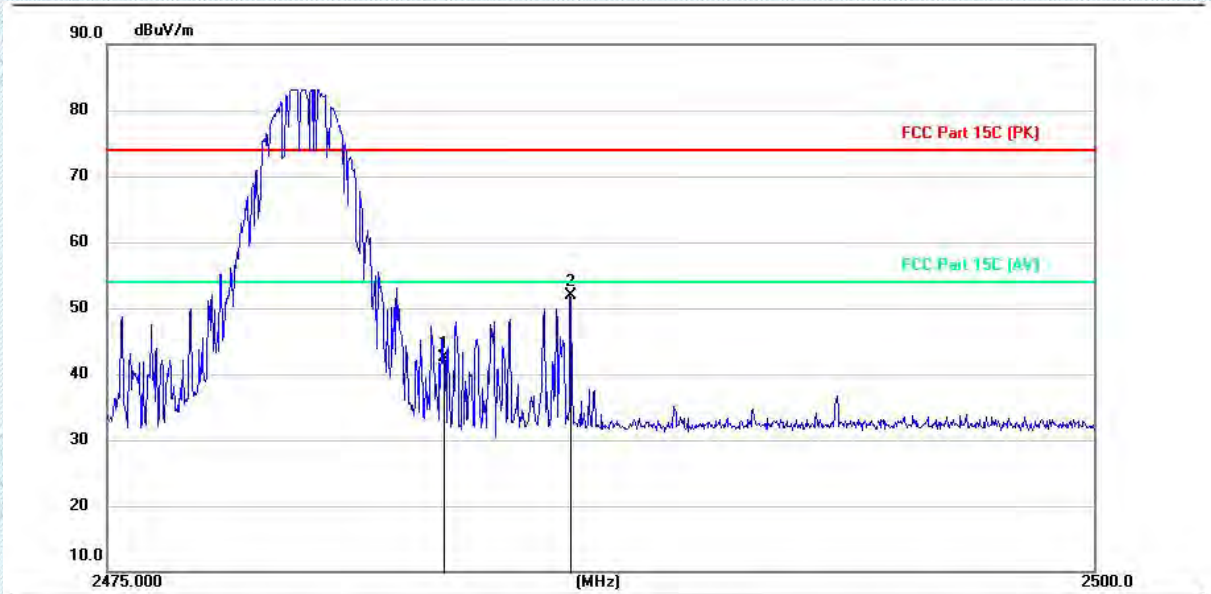

No.	Mk.	Freq. MHz	Reading Level (dBuV)	Correct Factor (dB/m)	Measurement (dBuV/m)	Limit (dBuV/m)	Over (dB)	Detector
1		2483.500	52.64	-10.09	42.55	74.00	-31.45	peak
2	*	2486.705	61.90	-10.08	51.82	74.00	-22.18	peak

Note:

- 1.Measurement = Reading level + Correct Factor
- 2.Correct Factor=Antenna Factor + Cable Loss -Preamplifier Factor
- 3.The worst mode of BLE 1Mbps is recorded

4.7. Emissions in frequency bands (below 1GHz)

Test Requirement:	Refer to 47 CFR 15.247(d), In addition, radiated emissions which fall in the restricted bands, as defined in § 15.205(a), must also comply with the radiated emission limits specified in § 15.209(a)(see § 15.205(c)).		
Test Limit:	Frequency (MHz)	Field strength (microvolts/meter)	Measurement distance (meters)
	0.009-0.490	2400/F(kHz)	300
	0.490-1.705	24000/F(kHz)	30
	1.705-30.0	30	30
	30-88	100 **	3
	88-216	150 **	3
	216-960	200 **	3
	Above 960	500	3
	** Except as provided in paragraph (g), fundamental emissions from intentional radiators operating under this section shall not be located in the frequency bands 54-72 MHz, 76-88 MHz, 174-216 MHz or 470-806 MHz. However, operation within these frequency bands is permitted under other sections of this part, e.g., §§ 15.231 and 15.241.		
Test Method:	ANSI C63.10-2013 section 6.6.4 KDB 558074 D01 15.247 Meas Guidance v05r02		
Procedure:	ANSI C63.10-2013 section 6.6.4		

4.7.1. E.U.T. Operation:

Operating Environment:	
Temperature:	24.2 °C
Humidity:	42.8 %
Atmospheric Pressure:	102 kPa
Final test mode:	Test Mode 1

4.7.2. Test Setup Diagram:

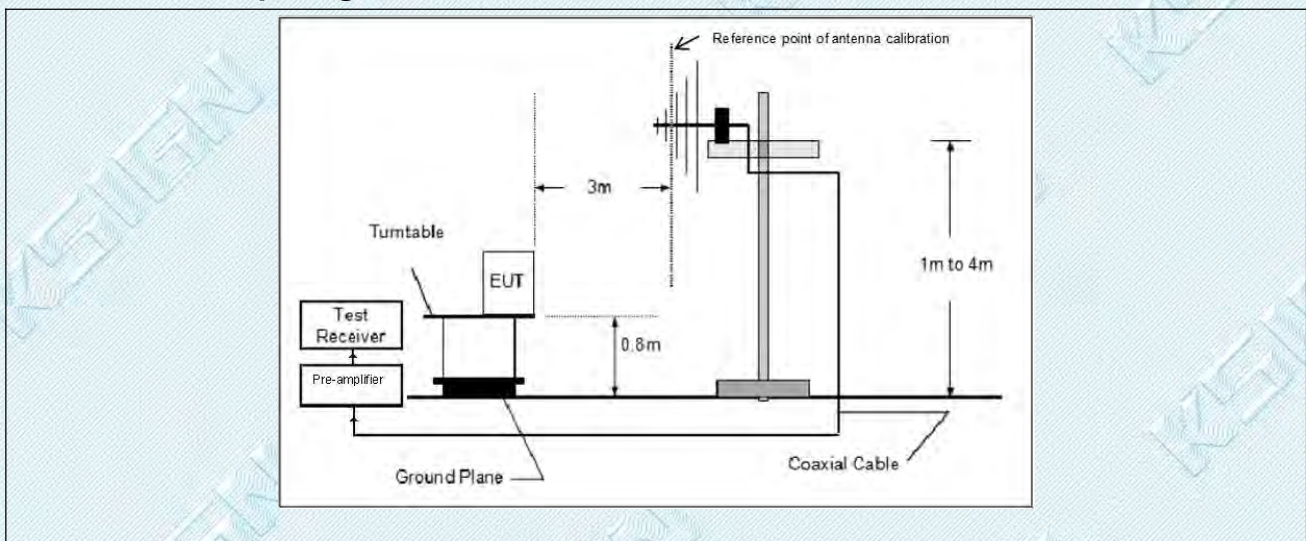

4.7.3. Test Data:

9 KHz - 30 MHz:

The amplitude of spurious emissions which are attenuated by more than 20dB below the permissible value has no need to be reported.

30MHz - 1GHz

Test Mode1 / Polarization: Horizontal / Band: 2400-2483.5 MHz / BW: 1 / CH: L



No.	Mk.	Freq. MHz	Reading Level (dBuV)	Correct Factor (dB/m)	Measurement (dBuV/m)	Limit (dBuV/m)	Over (dB)	Detector
1	*	64.6141	35.27	-16.88	18.39	40.00	-21.61	QP
2		74.0572	38.41	-20.16	18.25	40.00	-21.75	QP
3		142.5741	37.14	-21.00	16.14	43.50	-27.36	QP
4		168.7685	40.70	-20.59	20.11	43.50	-23.39	QP
5		400.0108	28.46	-10.26	18.20	46.00	-27.80	QP
6		600.1624	28.16	-7.12	21.04	46.00	-24.96	QP

TRF RF_R1

Add: West Side of 1/F., Building C, Zone A, Fuyuan New Factory, Jiujiu Industrial Park, Minzhu, Shatou, Shajing, Bao'an District, Shenzhen, Guangdong, China

Tel: +(86) 0755-2985 2678 Fax: +(86) 0755-2985 2397 E-mail: info@gdkesign.cn Web: www.gdkesign.com

Test Mode1 / Polarization: Vertical / Band: 2400-2483.5 MHz / BW: 1 / CH: L



No.	Mk.	Freq. MHz	Reading Level (dBuV)	Correct Factor (dB/m)	Measurement (dBuV/m)	Limit (dBuV/m)	Over (dB)	Detector
1		69.8450	27.24	-18.83	8.41	40.00	-31.59	QP
2		165.0810	27.21	-20.52	6.69	43.50	-36.81	QP
3		271.3245	28.37	-16.73	11.64	46.00	-34.36	QP
4		349.9854	28.30	-12.61	15.69	46.00	-30.31	QP
5		400.0109	25.96	-10.26	15.70	46.00	-30.30	QP
6	*	749.8452	27.89	-6.20	21.69	46.00	-24.31	QP

Note:

1. Pre-scan GFSK modulation, and found the GFSK modulation which it is 2402MHz channel which it is worse case for below 1GHz, so only show the test data for worse case.
2. Measurement = Reading level + Correct Factor
 Correct Factor = Antenna Factor + Cable Loss - Preamplifier Factor
 Over = Measurement - Limit

TRF RF_R1

Add: West Side of 1/F., Building C, Zone A, Fuyuan New Factory, Jiujiu Industrial Park, Minzhu, Shatou, Shajing, Bao'an District, Shenzhen, Guangdong, China

Tel: +(86) 0755-2985 2678 Fax: +(86) 0755-2985 2397 E-mail: info@gdkesign.cn Web: www.gdkesign.com

4.8. Emissions in frequency bands (above 1GHz)

Test Requirement:	In addition, radiated emissions which fall in the restricted bands, as defined in § 15.205(a), must also comply with the radiated emission limits specified in § 15.209(a)(see § 15.205(c)).		
Test Limit:	Frequency (MHz)	Field strength (microvolts/meter)	Measurement distance (meters)
	0.009-0.490	2400/F(kHz)	300
	0.490-1.705	24000/F(kHz)	30
	1.705-30.0	30	30
	30-88	100 **	3
	88-216	150 **	3
	216-960	200 **	3
	Above 960	500	3
	** Except as provided in paragraph (g), fundamental emissions from intentional radiators operating under this section shall not be located in the frequency bands 54-72 MHz, 76-88 MHz, 174-216 MHz or 470-806 MHz. However, operation within these frequency bands is permitted under other sections of this part, e.g., §§ 15.231 and 15.241.		
Test Method:	ANSI C63.10-2013 section 6.6.4 KDB 558074 D01 15.247 Meas Guidance v05r02		
Procedure:	ANSI C63.10-2013 section 6.6.4		

4.8.1. E.U.T. Operation:

Operating Environment:	
Temperature:	24.2 °C
Humidity:	42.8 %
Atmospheric Pressure:	102 kPa
Final test mode:	Test Mode 1

4.8.2. Test Setup Diagram:

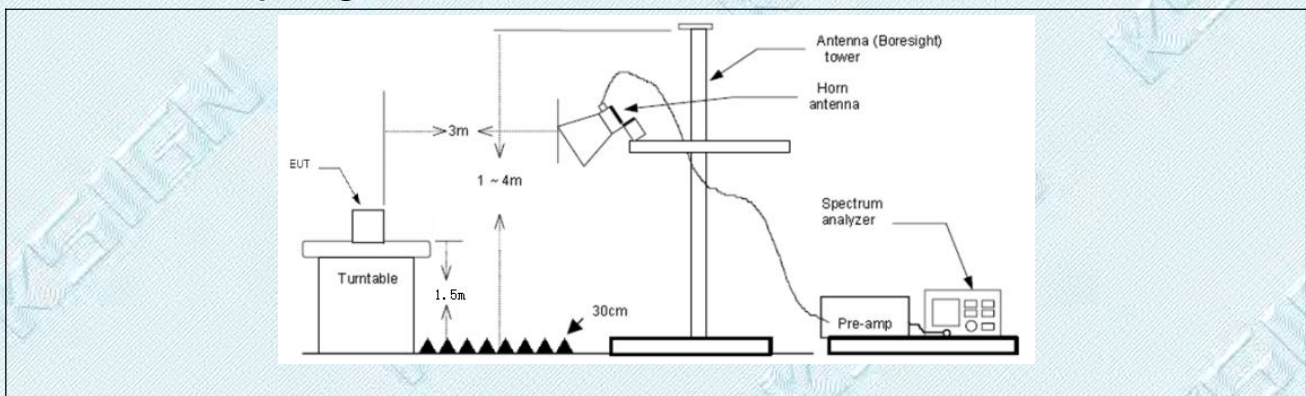

4.8.3. Test Data:

Test Mode1 / Polarization: Horizontal / Band: 2400-2483.5 MHz / BW: 1 / CH: L

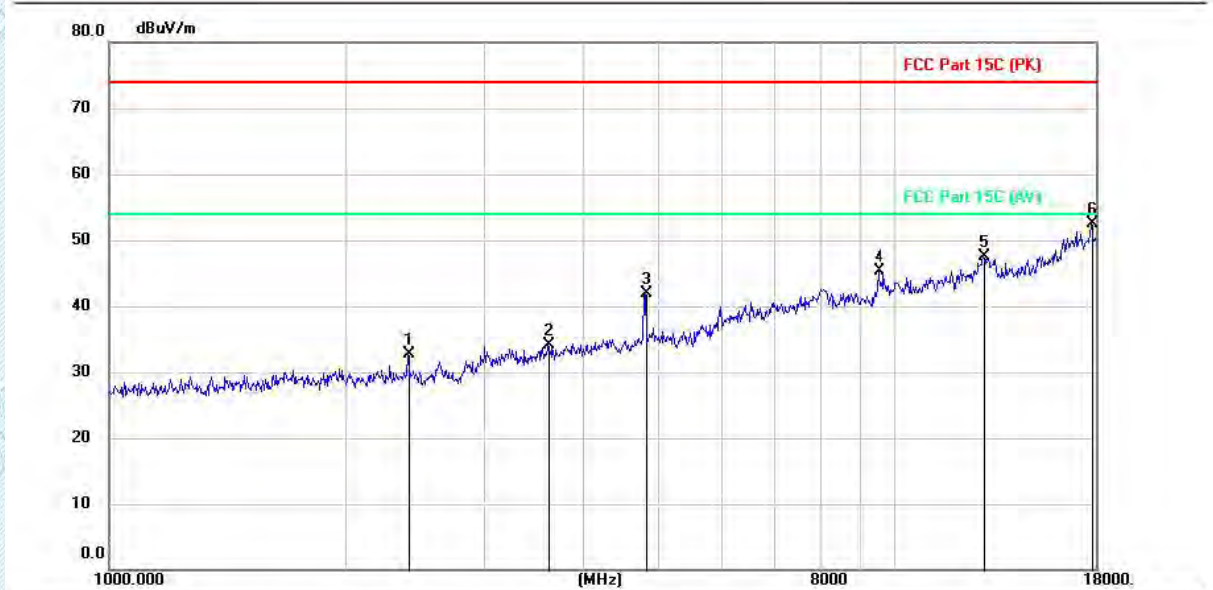

No.	Mk.	Freq. MHz	Reading Level (dBuV)	Correct Factor (dB/m)	Measurement (dBuV/m)	Limit (dBuV/m)	Over (dB)	Detector
1		2400.800	42.91	-10.12	32.79	74.00	-41.21	peak
2		3624.800	42.50	-8.43	34.07	74.00	-39.93	peak
3		4804.600	47.93	-6.04	41.89	74.00	-32.11	peak
4		9520.400	41.37	3.95	45.32	74.00	-28.68	peak
5		12961.200	36.50	11.03	47.53	74.00	-26.47	peak
6	*	17775.600	37.49	14.92	52.41	74.00	-21.59	peak

TRF RF_R1

Add: West Side of 1/F., Building C, Zone A, Fuyuan New Factory, Jiujiu Industrial Park, Minzhu, Shatou, Shajing, Bao'an District, Shenzhen, Guangdong, China

Tel: +(86) 0755-2985 2678 Fax: +(86) 0755-2985 2397 E-mail: info@gdkesign.cn Web: www.gdkesign.com

Test Mode1 / Polarization: Vertical / Band: 2400-2483.5 MHz / BW: 1 / CH: L

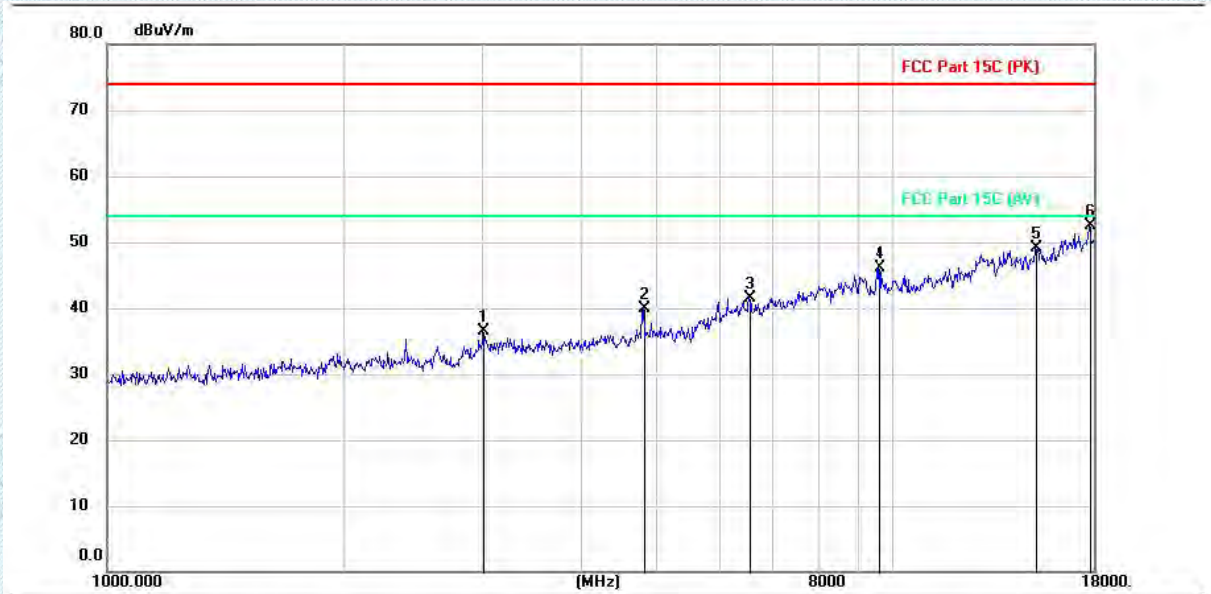

No.	Mk.	Freq. MHz	Reading Level (dBuV)	Correct Factor (dB/m)	Measurement (dBuV/m)	Limit (dBuV/m)	Over (dB)	Detector
1		3016.200	45.83	-9.38	36.45	74.00	-37.55	peak
2		4804.600	45.93	-6.04	39.89	74.00	-34.11	peak
3		6548.800	42.66	-1.06	41.60	74.00	-32.40	peak
4		9607.100	41.98	4.12	46.10	74.00	-27.90	peak
5		15181.400	37.52	11.53	49.05	74.00	-24.95	peak
6	*	17775.600	37.49	14.92	52.41	74.00	-21.59	peak

TRF RF_R1

Add: West Side of 1/F., Building C, Zone A, Fuyuan New Factory, Jiujiu Industrial Park, Minzhu, Shatou, Shajing, Bao'an District, Shenzhen, Guangdong, China

Tel: +(86) 0755-2985 2678 Fax: +(86) 0755-2985 2397 E-mail: info@gdkesign.cn Web: www.gdkesign.com

Test Mode1 / Polarization: Horizontal / Band: 2400-2483.5 MHz / BW: 1 / CH: M

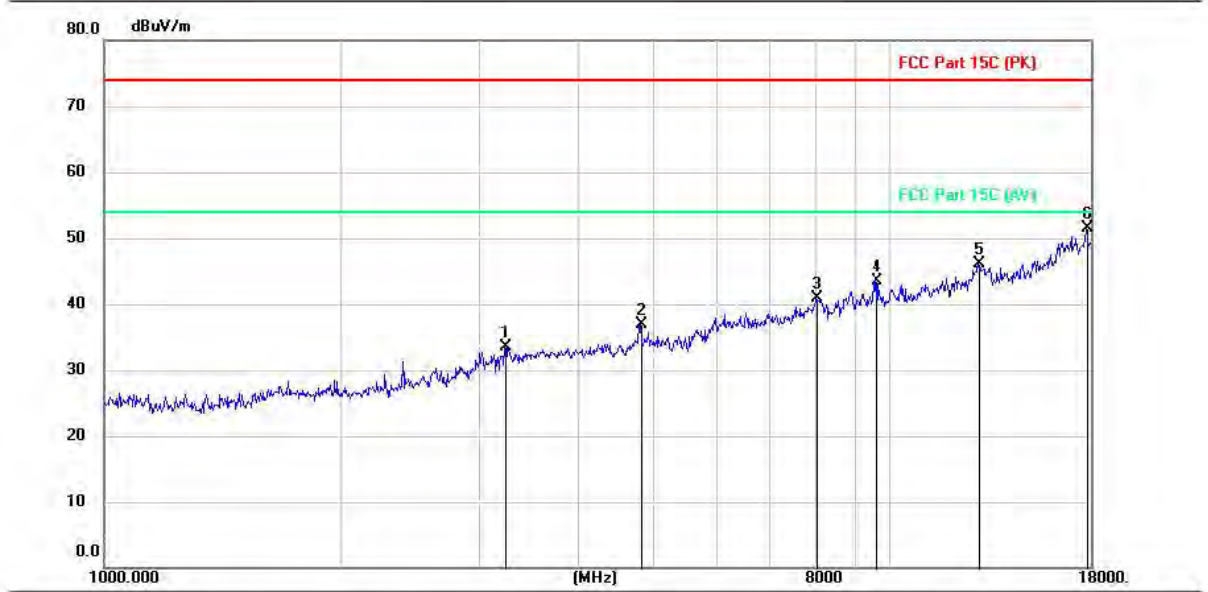

No.	Mk.	Freq. MHz	Reading Level (dBuV)	Correct Factor (dB/m)	Measurement (dBuV/m)	Limit (dBuV/m)	Over (dB)	Detector
1		3235.500	42.81	-9.22	33.59	74.00	-40.41	peak
2		4804.600	42.93	-6.04	36.89	74.00	-37.11	peak
3		8046.500	37.89	2.94	40.83	74.00	-33.17	peak
4		9607.100	39.48	4.12	43.60	74.00	-30.40	peak
5		12961.200	35.00	11.03	46.03	74.00	-27.97	peak
6	*	17775.600	36.49	14.92	51.41	74.00	-22.59	peak

TRF RF_R1

Add: West Side of 1/F., Building C, Zone A, Fuyuan New Factory, Jiujiu Industrial Park, Minzhu, Shatou, Shajing, Bao'an District, Shenzhen, Guangdong, China

Tel: +(86) 0755-2985 2678 Fax: +(86) 0755-2985 2397 E-mail: info@gdkesign.cn Web: www.gdkesign.com

Test Mode1 / Polarization: Vertical / Band: 2400-2483.5 MHz / BW: 1 / CH: M

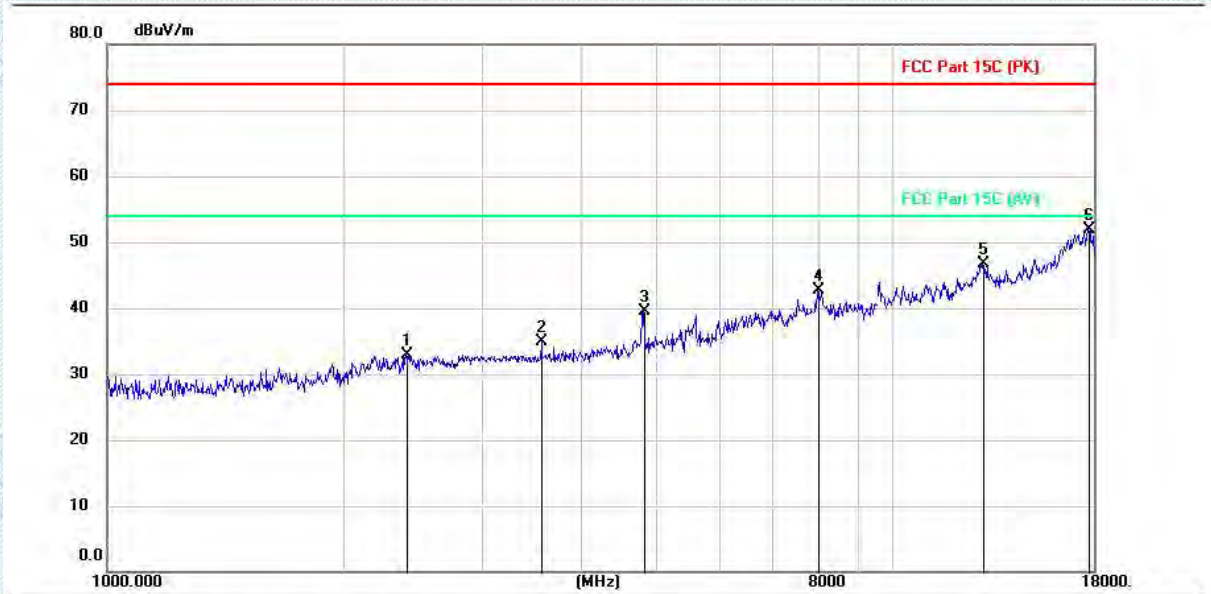

No.	Mk.	Freq. MHz	Reading Level (dBuV)	Correct Factor (dB/m)	Measurement (dBuV/m)	Limit (dBuV/m)	Over (dB)	Detector
1		2400.800	42.94	-10.12	32.82	74.00	-41.18	peak
2		3570.400	43.39	-8.56	34.83	74.00	-39.17	peak
3		4804.600	45.60	-6.04	39.56	74.00	-34.44	peak
4		7992.100	39.75	2.94	42.69	74.00	-31.31	peak
5		12988.400	35.60	11.17	46.77	74.00	-27.23	peak
6	*	17712.700	36.96	14.89	51.85	74.00	-22.15	peak

TRF RF_R1

Add: West Side of 1/F., Building C, Zone A, Fuyuan New Factory, Jiujiu Industrial Park, Minzhu, Shatou, Shajing, Bao'an District, Shenzhen, Guangdong, China

Tel: +(86) 0755-2985 2678 Fax: +(86) 0755-2985 2397 E-mail: info@gdkesign.cn Web: www.gdkesign.com

Test Mode1 / Polarization: Horizontal / Band: 2400-2483.5 MHz / BW: 1 / CH: H

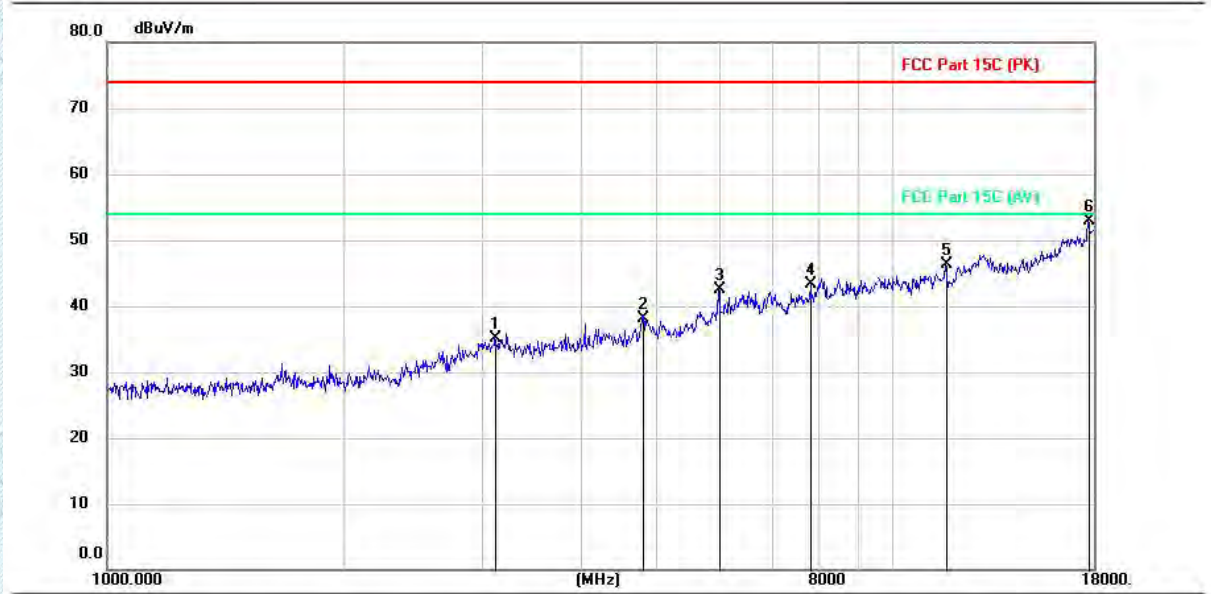

No.	Mk.	Freq. MHz	Reading Level (dBuV)	Correct Factor (dB/m)	Measurement (dBuV/m)	Limit (dBuV/m)	Over (dB)	Detector
1		3119.900	44.28	-9.26	35.02	74.00	-38.98	peak
2		4802.900	44.13	-6.04	38.09	74.00	-35.91	peak
3		5994.600	44.86	-2.45	42.41	74.00	-31.59	peak
4		7847.600	41.06	2.34	43.40	74.00	-30.60	peak
5		11674.300	39.12	7.25	46.37	74.00	-27.63	peak
6	*	17704.200	37.93	14.89	52.82	74.00	-21.18	peak

TRF RF_R1

Add: West Side of 1/F., Building C, Zone A, Fuyuan New Factory, Jiujiu Industrial Park, Minzhu, Shatou, Shajing, Bao'an District, Shenzhen, Guangdong, China

Tel: +(86) 0755-2985 2678 Fax: +(86) 0755-2985 2397 E-mail: info@gdkesign.cn Web: www.gdkesign.com

Test Mode1 / Polarization: Vertical / Band: 2400-2483.5 MHz / BW: 1 / CH: H

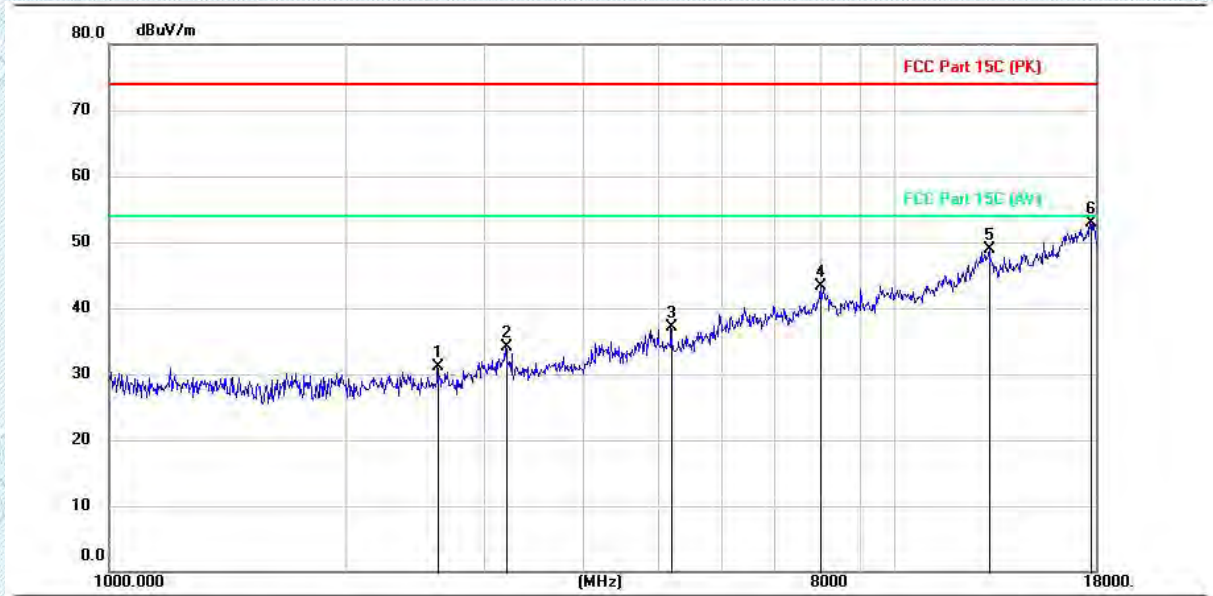

No.	Mk.	Freq. MHz	Reading Level (dBuV)	Correct Factor (dB/m)	Measurement (dBuV/m)	Limit (dBuV/m)	Over (dB)	Detector
1		2618.400	41.15	-10.06	31.09	74.00	-42.91	peak
2		3201.500	43.38	-9.19	34.19	74.00	-39.81	peak
3		5188.800	42.65	-5.51	37.14	74.00	-36.86	peak
4		8032.900	40.33	2.94	43.27	74.00	-30.73	peak
5		13182.200	38.29	10.62	48.91	74.00	-25.09	peak
6	*	17712.700	38.04	14.89	52.93	74.00	-21.07	peak

Note:

1. From 18GHz to 26.5GHz, the amplitude of spurious emissions which are attenuated by more than 20dB below the permissible value has no need to be reported.
2. Since the peak value is less than the limit of the AVG value, there is no AVG data.

5. EUT TEST PHOTOS

RF test photo



Conducted Emission at AC power line

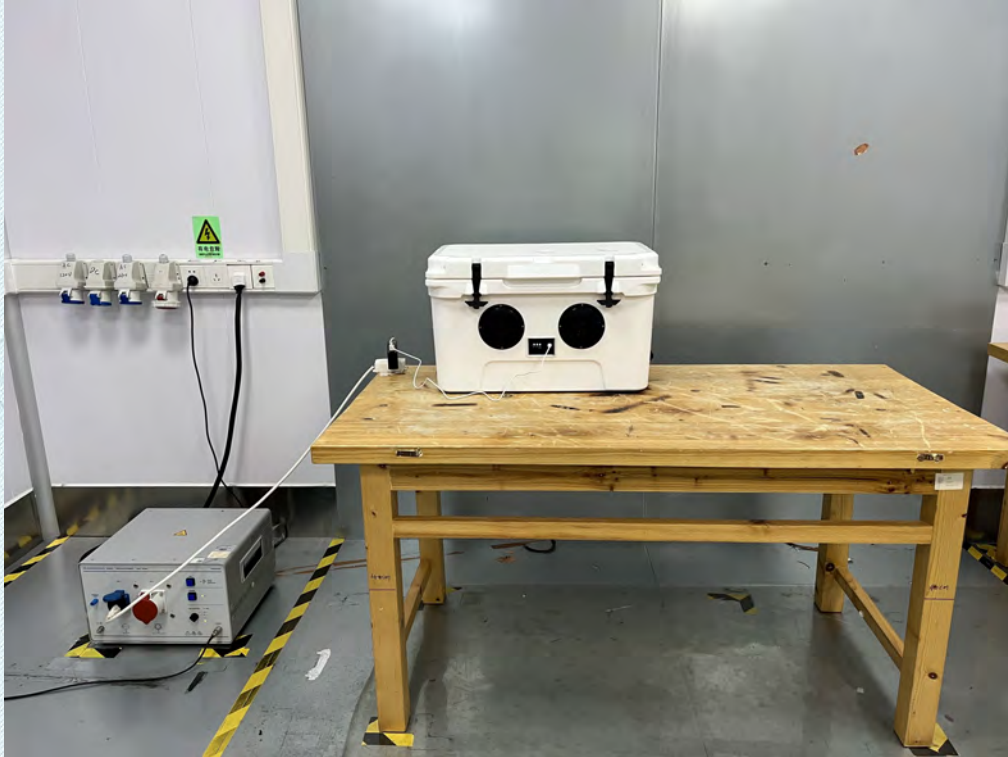

TRF RF_R1

Add: West Side of 1/F., Building C, Zone A, Fuyuan New Factory, Jiujiu Industrial Park, Minzhu, Shatou, Shajing, Bao'an District, Shenzhen, Guangdong, China

Tel: +(86) 0755-2985 2678 Fax: +(86) 0755-2985 2397 E-mail: info@gdkesign.cn Web: www.gdkesign.com

Emissions in frequency bands (below 1GHz)



Emissions in frequency bands (above 1GHz)



6. PHOTOGRAPHS OF EUT CONSTRUCTIONAL

Please refer to the report:KS2310S5495E01.

Appendix

6.1. Appendix A: DTS Bandwidth

6.1.1. Test Result

TestMode	Antenna	Freq[MHz]	DTS BW [MHz]	FL[MHz]	FH[MHz]	Limit[MHz]	Verdict
BLE_1M	Ant1	2402	0.70	2401.65	2402.35	0.5	PASS
		2440	0.70	2439.65	2440.35	0.5	PASS
		2480	0.70	2479.65	2480.35	0.5	PASS

6.1.2. Test Graphs

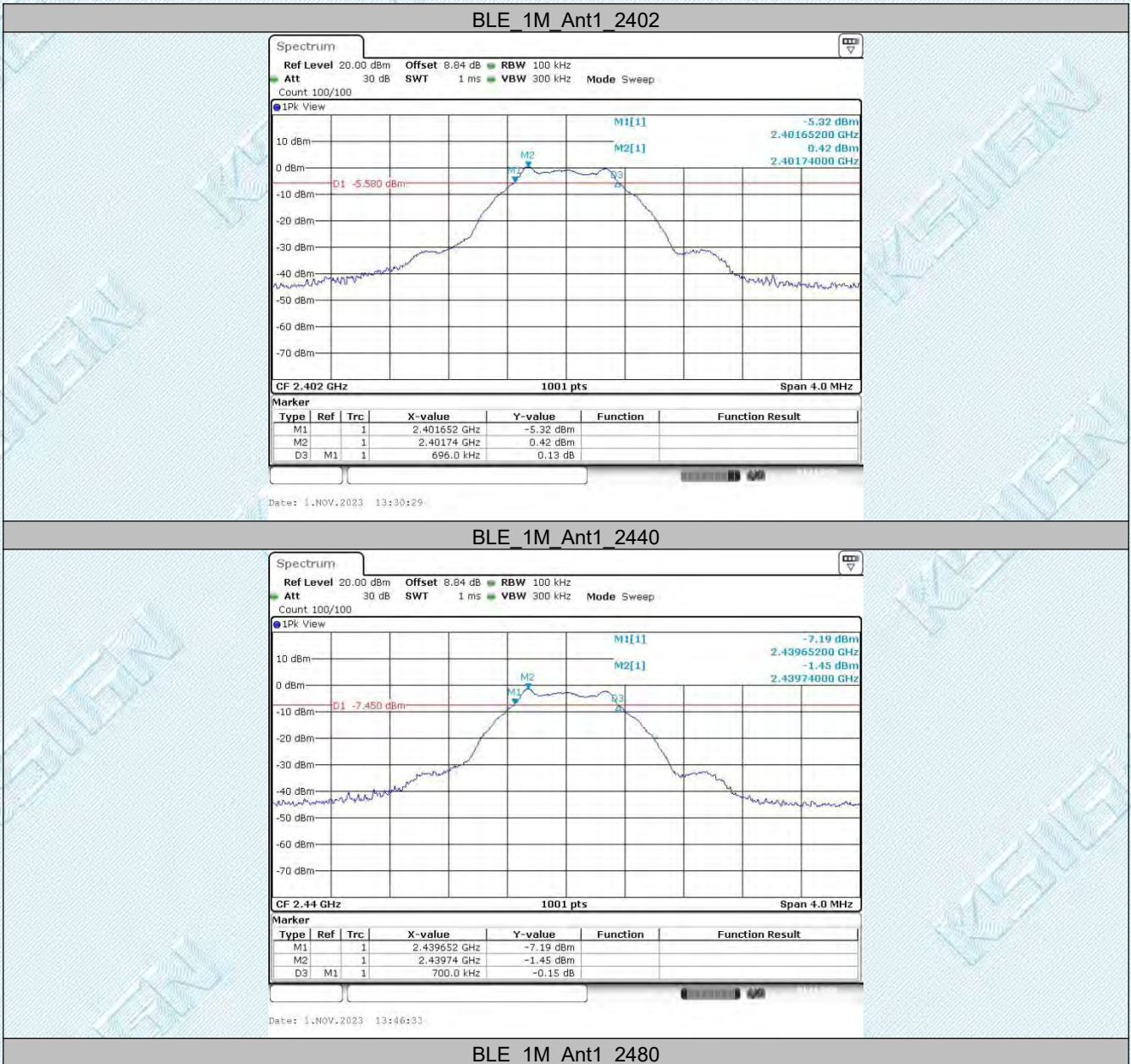

TRF RF_R1

Add: West Side of 1/F., Building C, Zone A, Fuyuan New Factory, Jiujiu Industrial Park, Minzhu, Shatou, Shajing, Bao'an District, Shenzhen, Guangdong, China

Tel: +(86) 0755-2985 2678 Fax: +(86) 0755-2985 2397 E-mail: info@gdkesign.cn Web: www.gdkesign.com

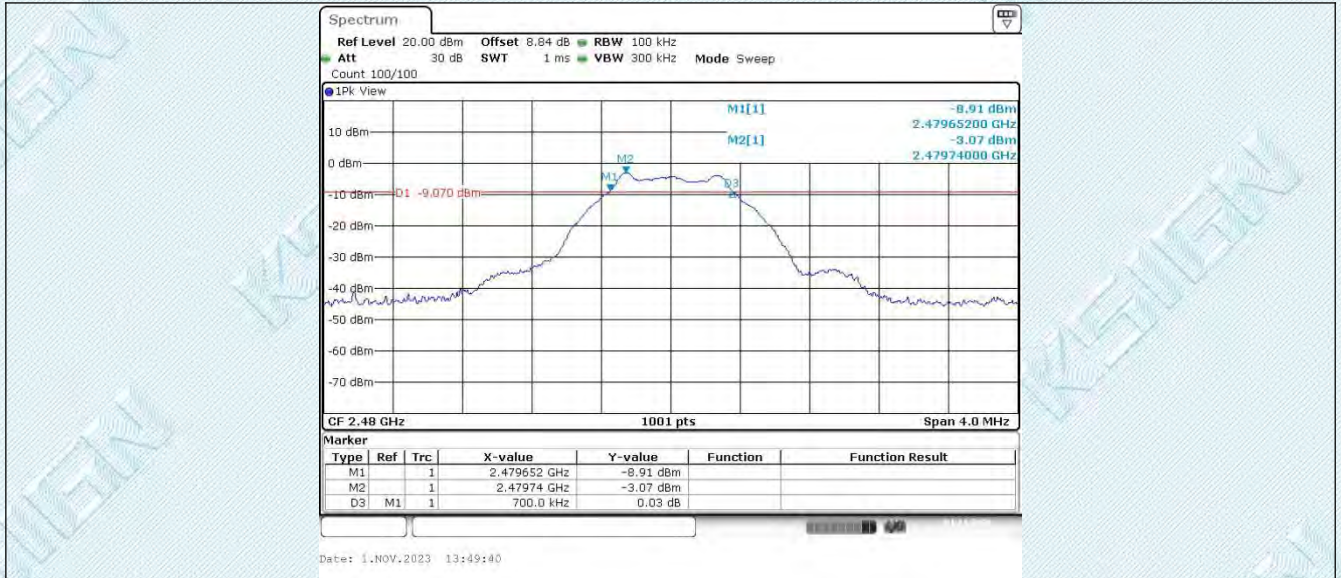

TRF RF_R1

Add: West Side of 1/F., Building C, Zone A, Fuyuan New Factory, Jiujiu Industrial Park, Minzhu, Shatou, Shajing, Bao'an District, Shenzhen, Guangdong, China

Tel: +(86) 0755-2985 2678 Fax: +(86) 0755-2985 2397 E-mail: info@gdkesign.cn Web: www.gdkesign.com

6.2. Appendix B: Occupied Channel Bandwidth

6.2.1. Test Result

TestMode	Antenna	Freq[MHz]	OCB [MHz]	FL[MHz]	FH[MHz]	Limit[MHz]	Verdict
BLE_1M	Ant1	2402	1.023	2401.497	2402.519	---	PASS
		2440	1.023	2439.497	2440.519	---	PASS
		2480	1.023	2479.497	2480.519	---	PASS

6.2.2. Test Graphs



TRF RF_R1

Add: West Side of 1/F., Building C, Zone A, Fuyuan New Factory, Jiujiu Industrial Park, Minzhu, Shatou, Shajing, Bao'an District, Shenzhen, Guangdong, China

Tel: +(86) 0755-2985 2678 Fax: +(86) 0755-2985 2397 E-mail: info@gdksign.cn Web: www.gdksign.com

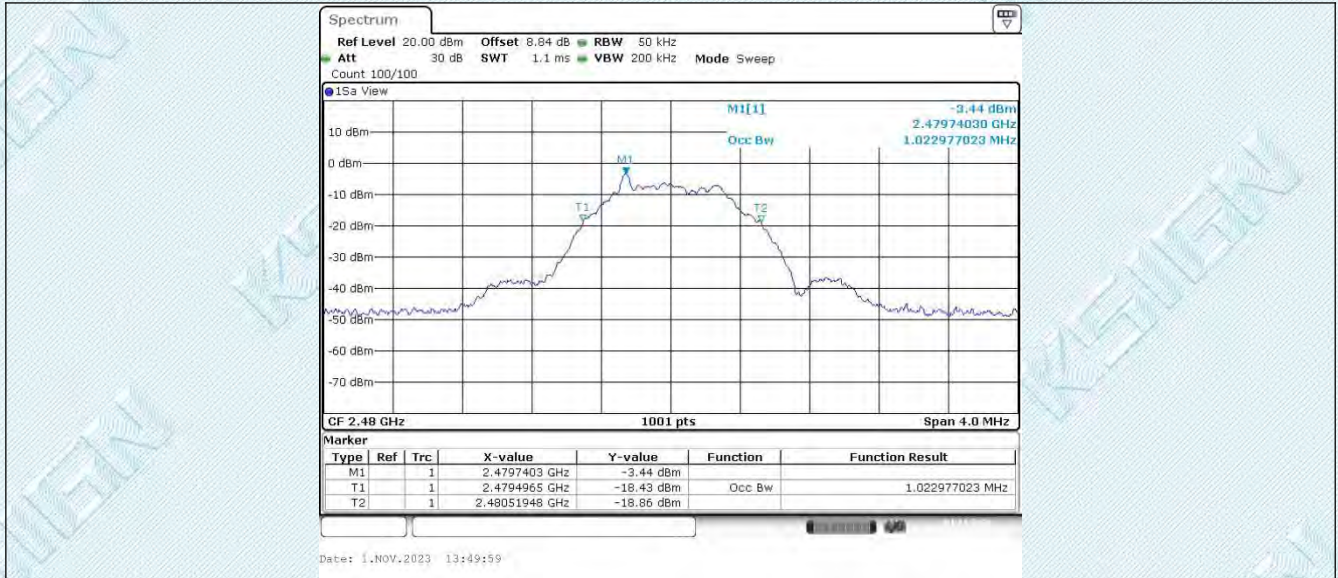

TRF RF_R1

Add: West Side of 1/F., Building C, Zone A, Fuyuan New Factory, Jiujiu Industrial Park, Minzhu, Shatou, Shajing, Bao'an District, Shenzhen, Guangdong, China

Tel: +(86) 0755-2985 2678 Fax: +(86) 0755-2985 2397 E-mail: info@gdkesign.cn Web: www.gdkesign.com

6.3. Appendix C: Maximum conducted output power

6.3.1. Test Result Peak

TestMode	Antenna	Freq[MHz]	Conducted Peak Power[dBm]	Conducted Limit[dBm]	EIRP[dBm]	EIRP Limit[dBm]	Verdict
BLE_1M	Ant1	2402	0.69	≤30	2.39	≤36	PASS
		2440	-1.17	≤30	0.53	≤36	PASS
		2480	-2.73	≤30	-1.03	≤36	PASS

Note:

Antenna Gain:1.7dBi

EIRP=Conducted Power+Antenna Gain

6.3.2. Test Graphs Peak

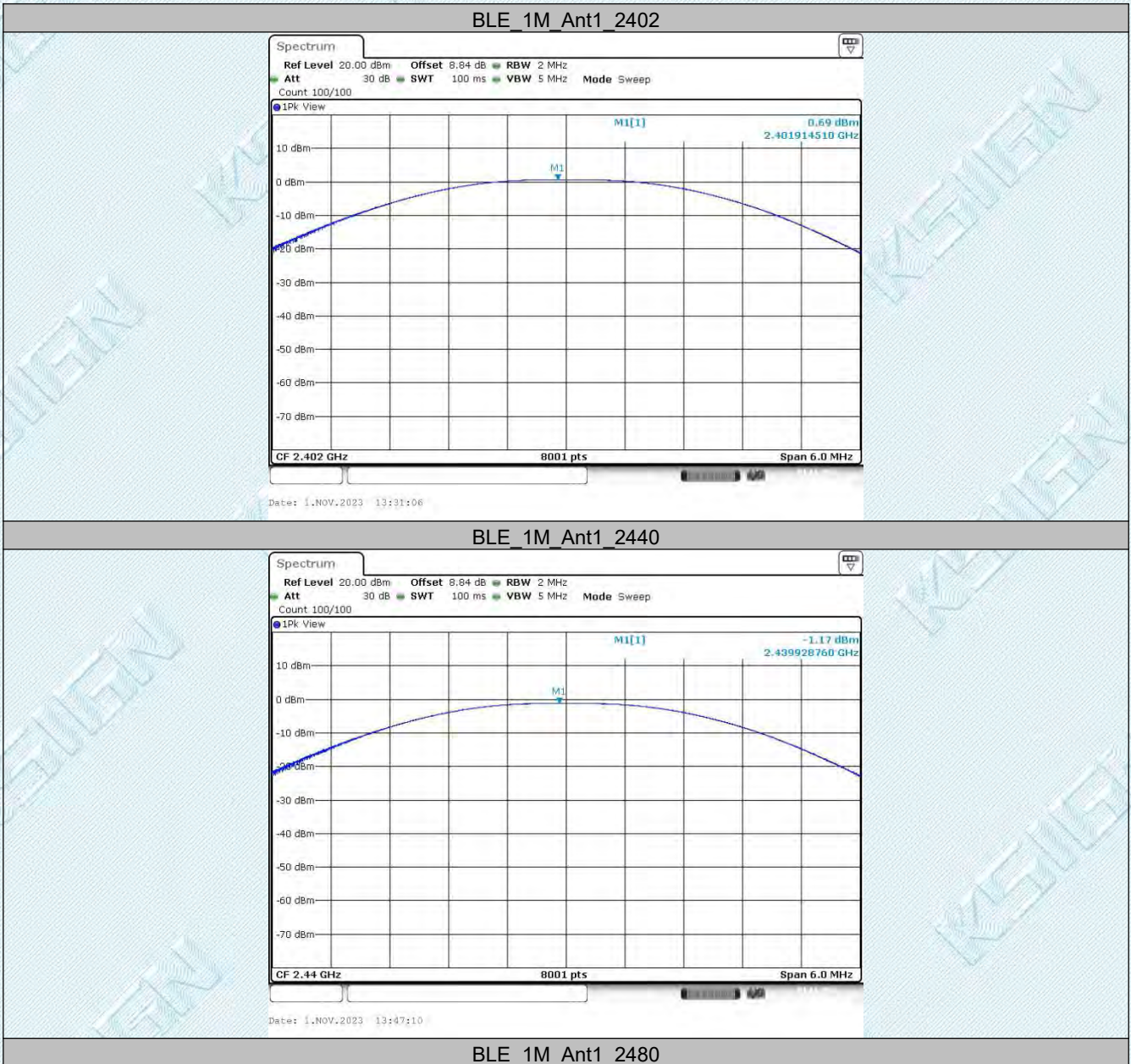

TRF RF_R1

Add: West Side of 1/F., Building C, Zone A, Fuyuan New Factory, Jiujiu Industrial Park, Minzhu, Shatou, Shajing, Bao'an District, Shenzhen, Guangdong, China

Tel: +(86) 0755-2985 2678 Fax: +(86) 0755-2985 2397 E-mail: info@gdkesign.cn Web: www.gdkesign.com

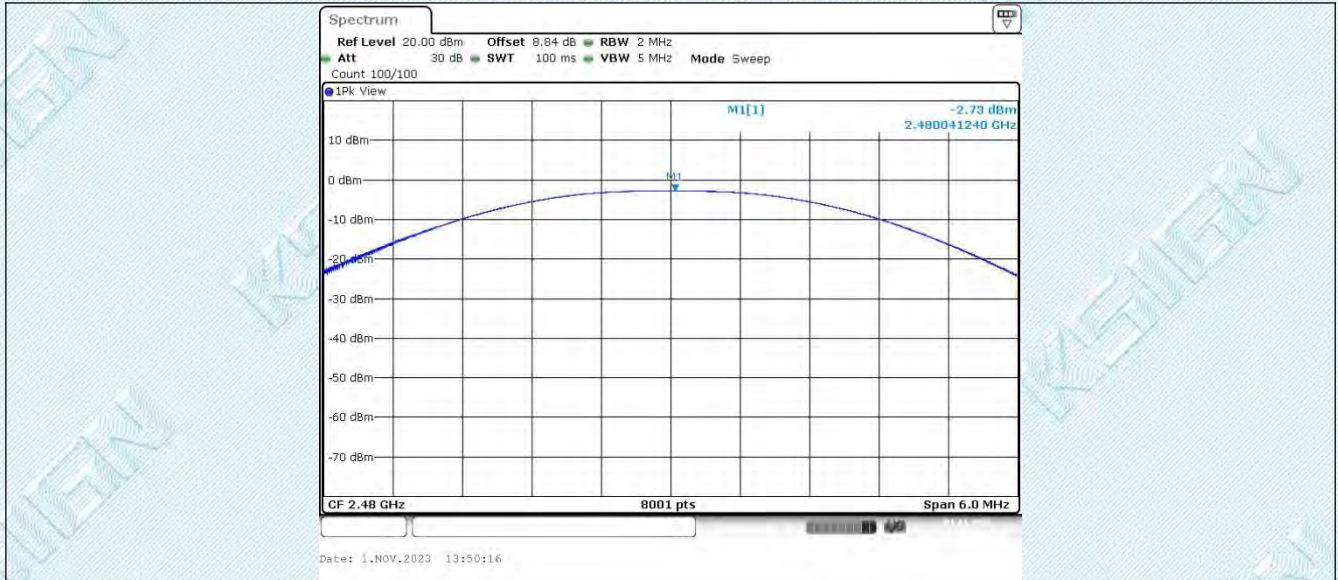

TRF RF_R1

Add: West Side of 1/F., Building C, Zone A, Fuyuan New Factory, Jiujiu Industrial Park, Minzhu, Shatou, Shajing, Bao'an District, Shenzhen, Guangdong, China

Tel: +(86) 0755-2985 2678 Fax: +(86) 0755-2985 2397 E-mail: info@gdkesign.cn Web: www.gdkesign.com

6.4. Appendix D: Maximum power spectral density

6.4.1. Test Result

TestMode	Antenna	Freq[MHz]	Result[dBm/3kHz]	Limit[dBm/3kHz]	Verdict
BLE_1M	Ant1	2402	-14.8	≤8.00	PASS
		2440	-16.62	≤8.00	PASS
		2480	-18.23	≤8.00	PASS

6.4.2. Test Graphs



TRF RF_R1

Add: West Side of 1/F., Building C, Zone A, Fuyuan New Factory, Jiujiu Industrial Park, Minzhu, Shatou, Shajing, Bao'an District, Shenzhen, Guangdong, China

Tel: +(86) 0755-2985 2678 Fax: +(86) 0755-2985 2397 E-mail: info@gdkesign.cn Web: www.gdkesign.com

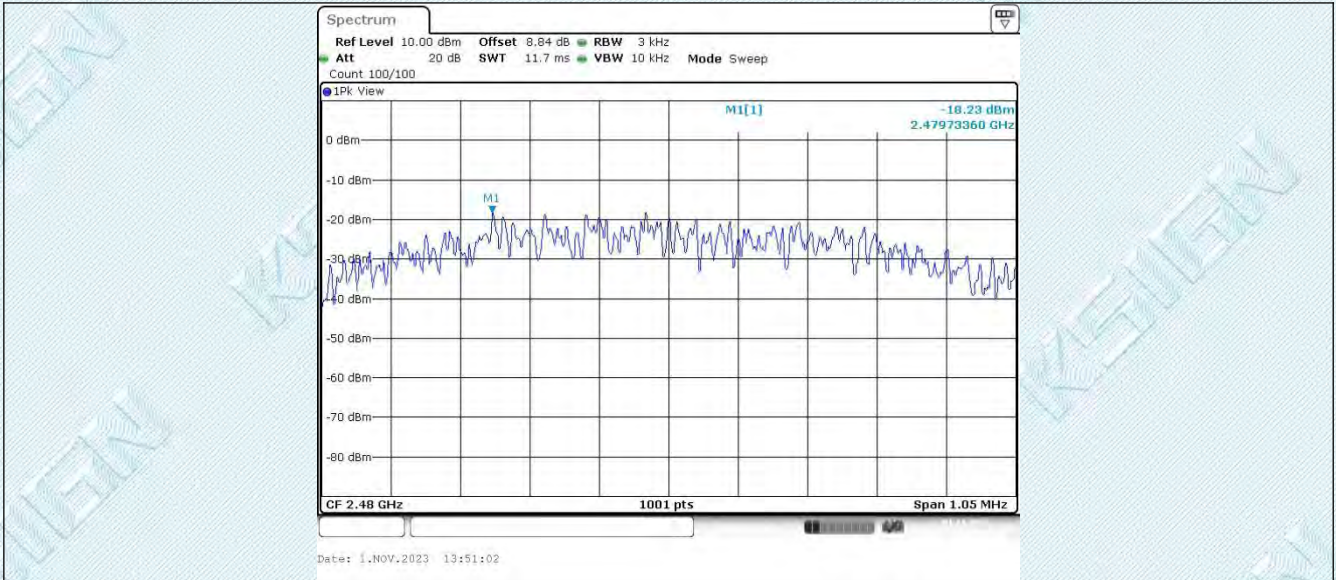

TRF RF_R1

Add: West Side of 1/F., Building C, Zone A, Fuyuan New Factory, Jiujiu Industrial Park, Minzhu, Shatou, Shajing, Bao'an District, Shenzhen, Guangdong, China

Tel: +(86) 0755-2985 2678 Fax: +(86) 0755-2985 2397 E-mail: info@gdkesign.cn Web: www.gdkesign.com

6.5. Appendix E: Reference level measurement

6.5.1. Test Result

TestMode	Antenna	Freq[MHz]	Max.Point[MHz]	Result[dBm]
BLE_1M	Ant1	2402	2401.74	0.42
		2440	2439.74	-1.43
		2480	2479.74	-3.03

6.5.2. Test Graphs

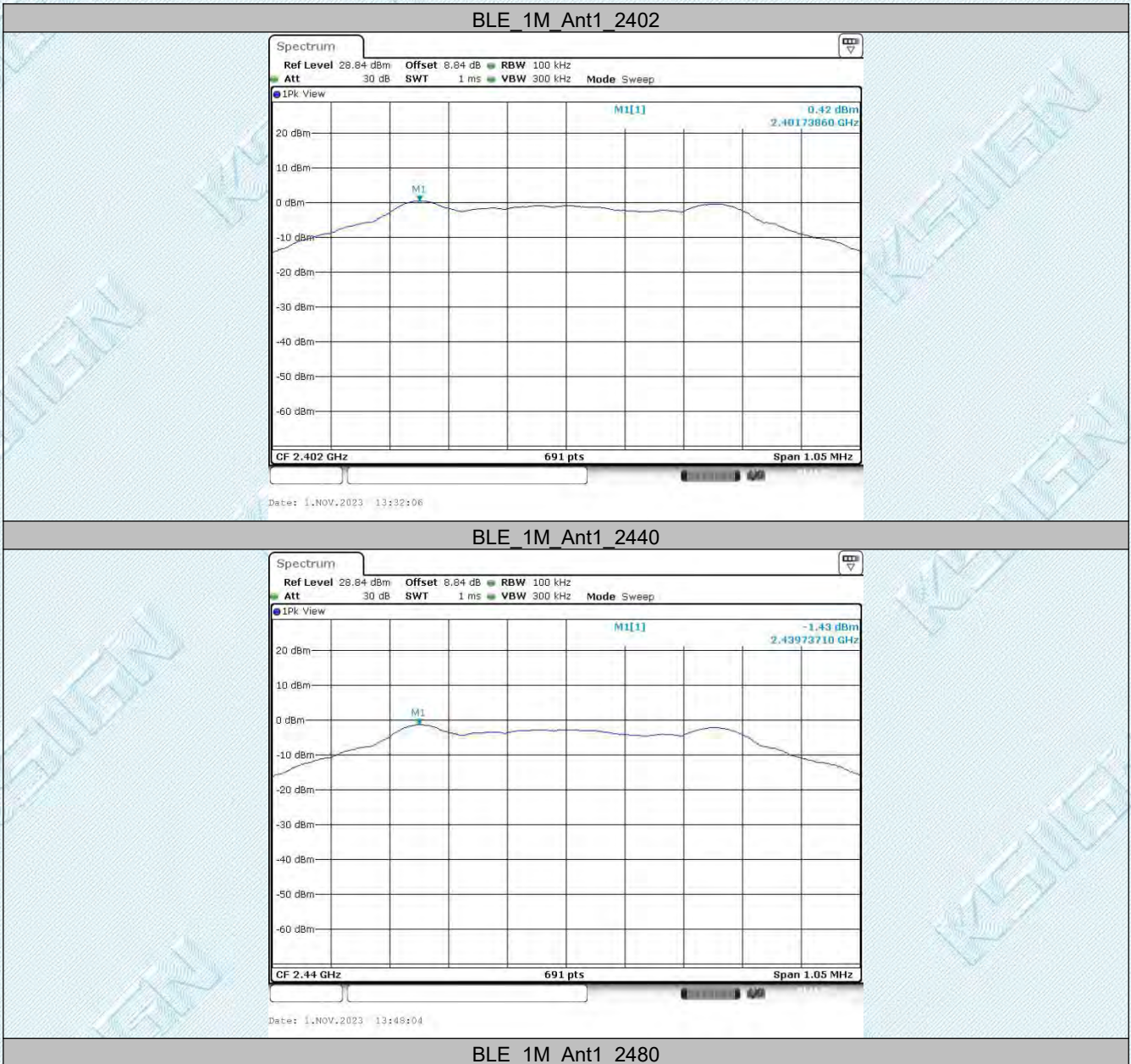

TRF RF_R1

Add: West Side of 1/F., Building C, Zone A, Fuyuan New Factory, Jiujiu Industrial Park, Minzhu, Shatou, Shajing, Bao'an District, Shenzhen, Guangdong, China

Tel: +(86) 0755-2985 2678 Fax: +(86) 0755-2985 2397 E-mail: info@gdkesign.cn Web: www.gdkesign.com

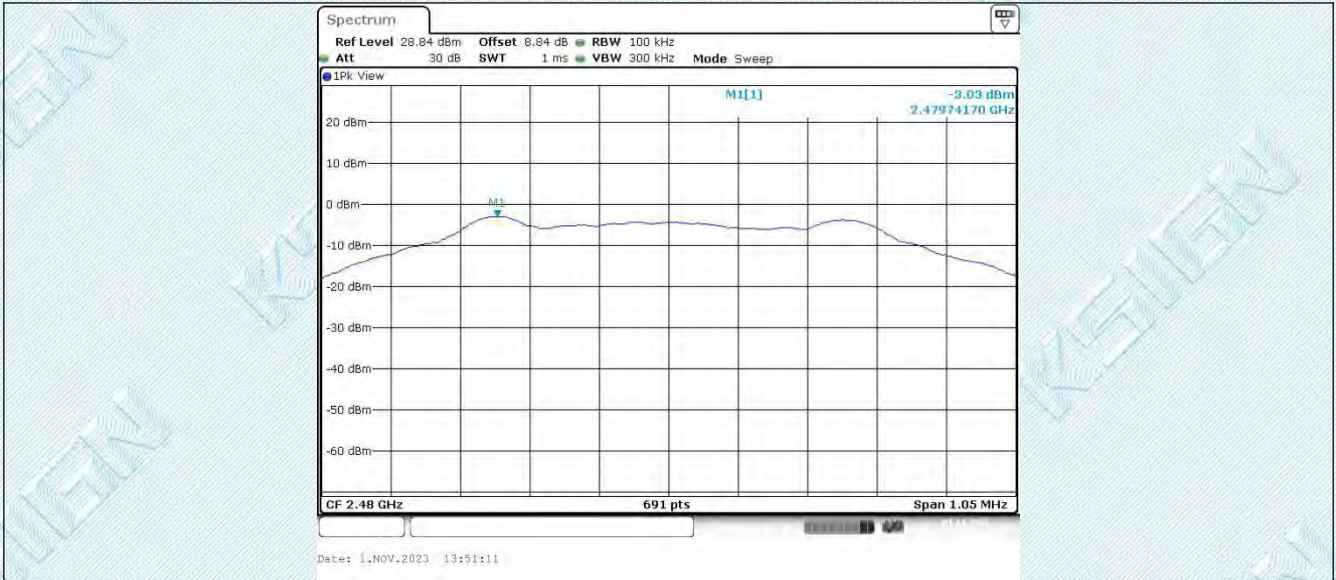

TRF RF_R1

Add: West Side of 1/F., Building C, Zone A, Fuyuan New Factory, Jiujiu Industrial Park, Minzhu, Shatou, Shajing, Bao'an District, Shenzhen, Guangdong, China

Tel: +(86) 0755-2985 2678 Fax: +(86) 0755-2985 2397 E-mail: info@gdkesign.cn Web: www.gdkesign.com

6.6. Appendix F: Band edge measurements

6.6.1. Test Result

TestMode	Antenna	ChName	Freq[MHz]	RefLevel[dBm]	Result[dBm]	Limit[dBm]	Verdict
BLE_1M	Ant1	Low	2402	0.42	-40.66	≤ -19.58	PASS
		High	2480	-3.03	-40.59	≤ -23.03	PASS

6.6.2. Test Graphs



TRF_RF_R1

Add: West Side of 1/F., Building C, Zone A, Fuyuan New Factory, Jiujiu Industrial Park, Minzhu, Shatou, Shajing, Bao'an District, Shenzhen, Guangdong, China

Tel: +(86) 0755-2985 2678 Fax: +(86) 0755-2985 2397 E-mail: info@gdkesign.cn Web: www.gdkesign.com

6.7. Appendix G: Conducted Spurious Emission

6.7.1. Test Result

TestMode	Antenna	Freq[MHz]	FreqRange [MHz]	RefLevel [dBm]	Result[dBm]	Limit[dBm]	Verdict
BLE_1M	Ant1	2402	30~1000	0.42	-52.18	≤-19.58	PASS
			1000~26500	0.42	-43.17	≤-19.58	PASS
		2440	30~1000	-1.43	-52.24	≤-21.43	PASS
			1000~26500	-1.43	-46.96	≤-21.43	PASS
		2480	30~1000	-3.03	-51.57	≤-23.03	PASS
			1000~26500	-3.03	-46.7	≤-23.03	PASS

6.7.2. Test Graphs

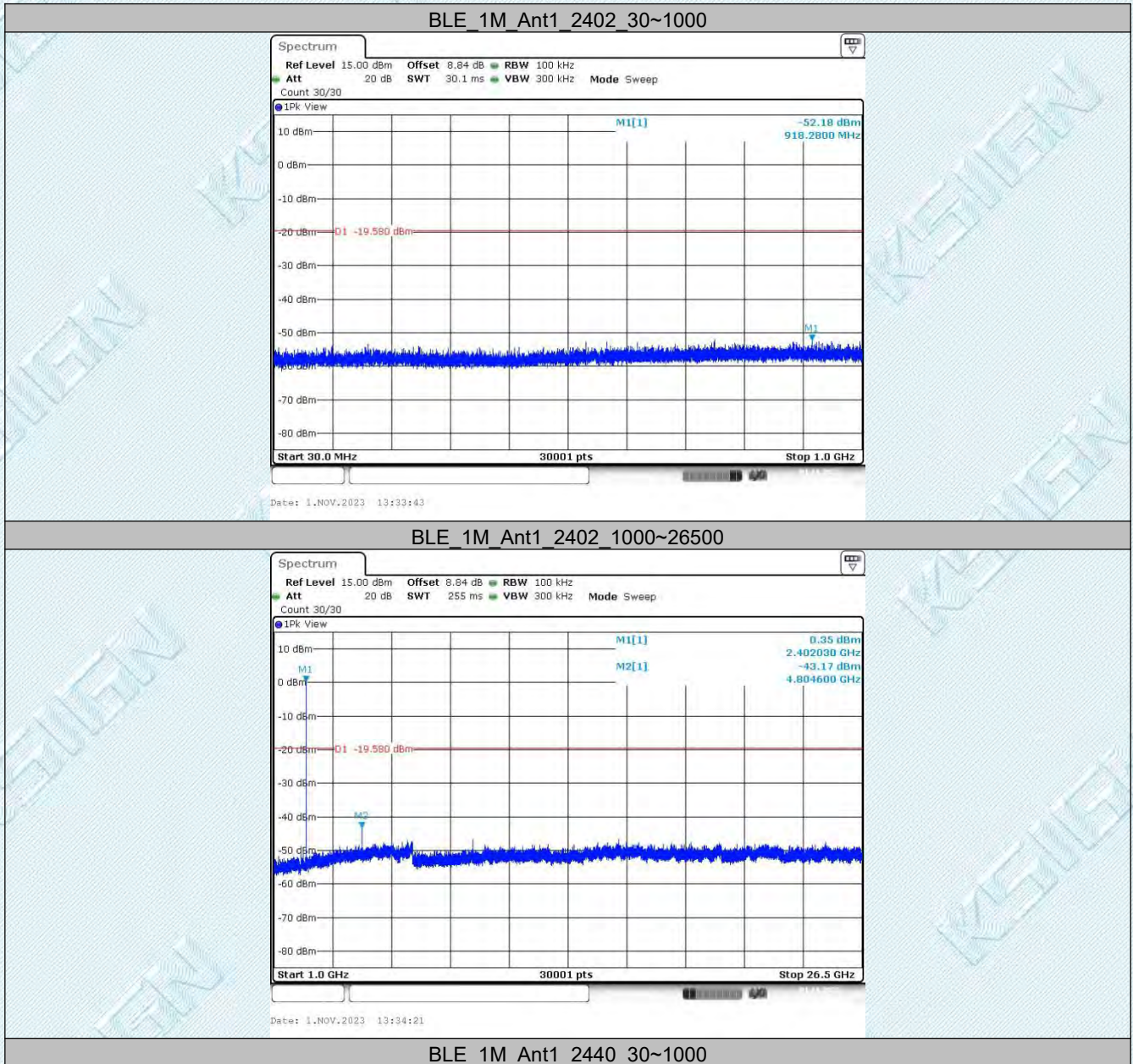

TRF RF_R1

Add: West Side of 1/F., Building C, Zone A, Fuyuan New Factory, Jiujiu Industrial Park, Minzhu, Shatou, Shajing, Bao'an District, Shenzhen, Guangdong, China

Tel: +(86) 0755-2985 2678 Fax: +(86) 0755-2985 2397 E-mail: info@gdkesign.cn Web: www.gdkesign.com

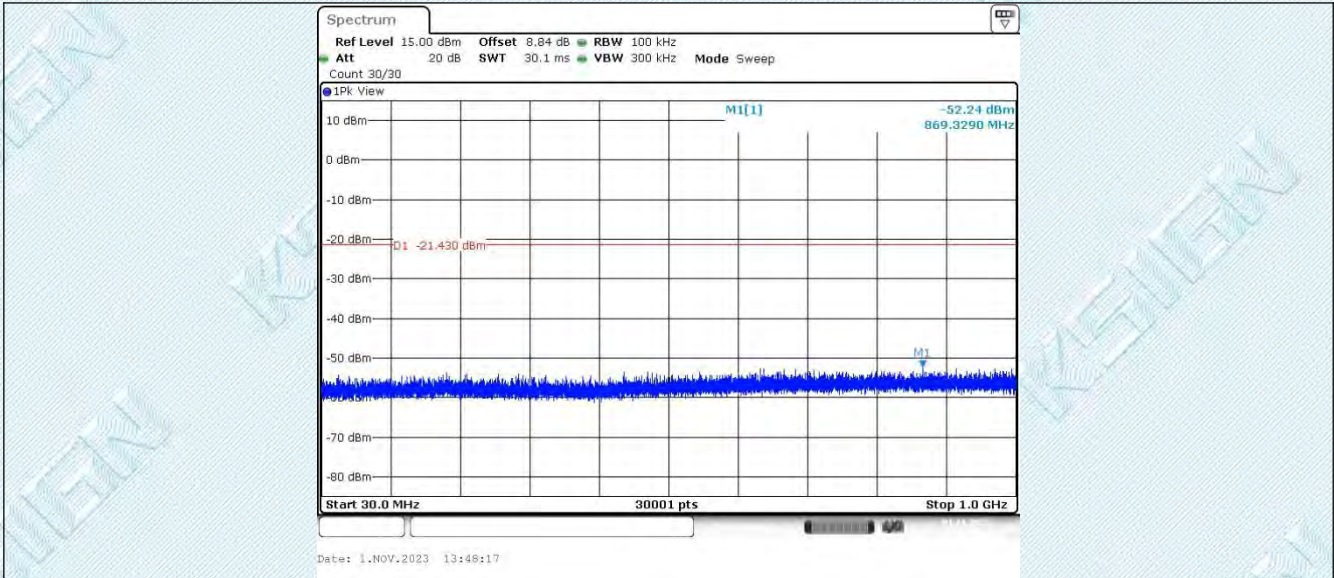

BLE_1M_Ant1_2440_1000~26500

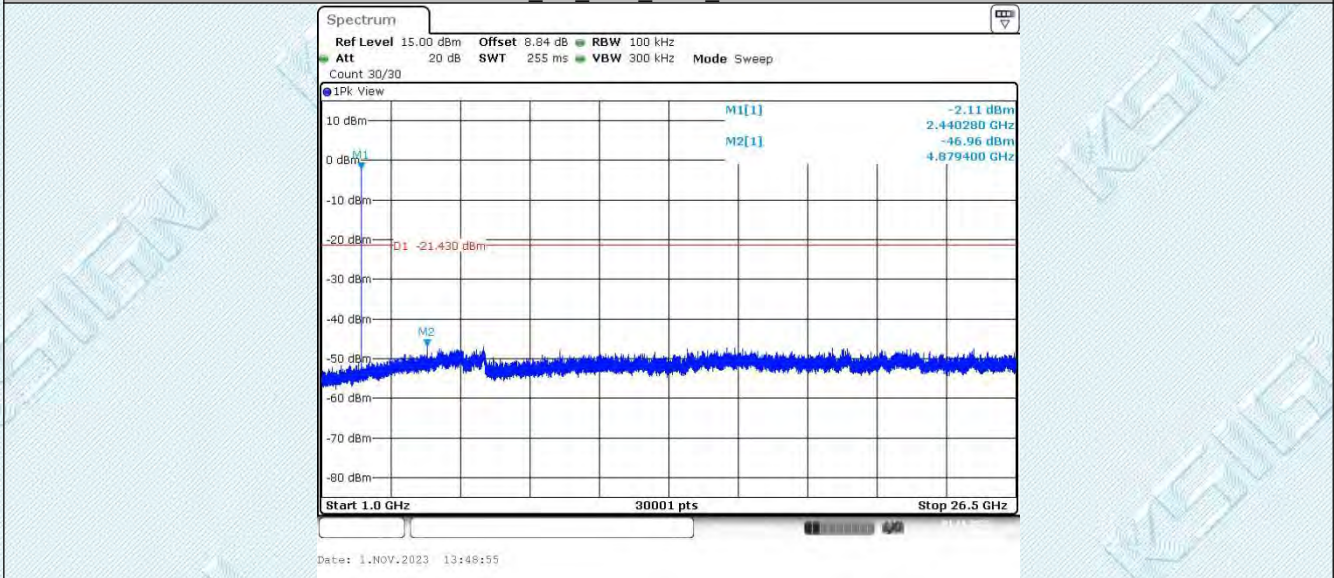

BLE_1M_Ant1_2480_30~1000

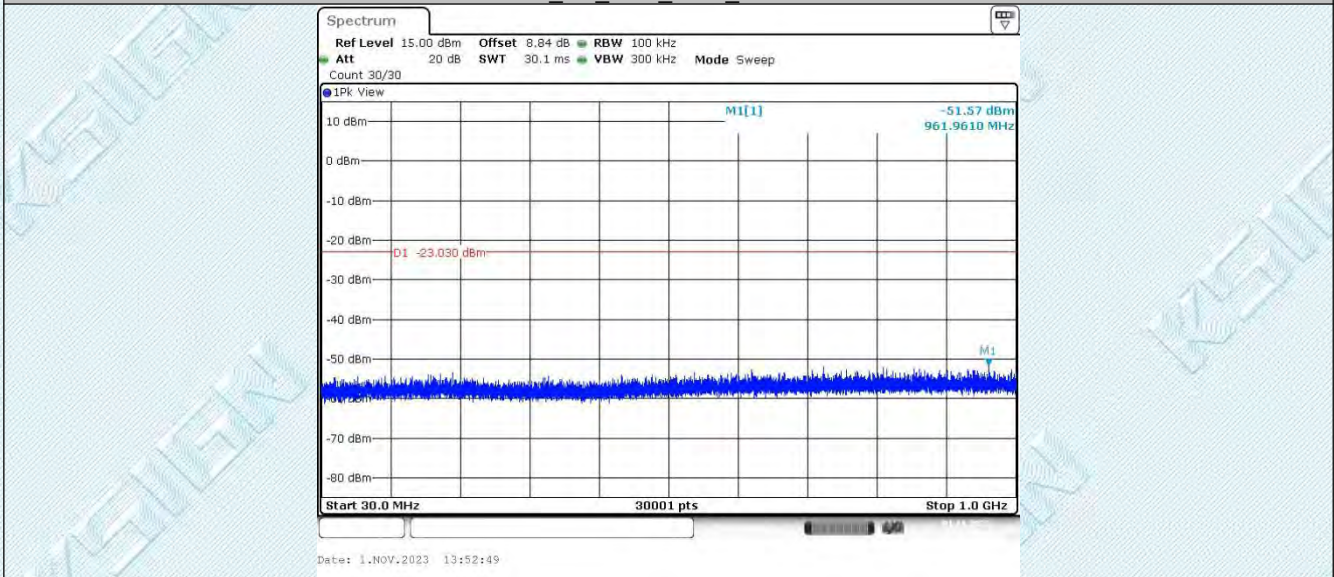

BLE_1M_Ant1_2480_1000~26500

TRF RF_R1

Add: West Side of 1/F., Building C, Zone A, Fuyuan New Factory, Jiujiu Industrial Park, Minzhu, Shatou, Shajing, Bao'an District, Shenzhen, Guangdong, China

Tel: +(86) 0755-2985 2678 Fax: +(86) 0755-2985 2397 E-mail: info@gdkesign.cn Web: www.gdkesign.com

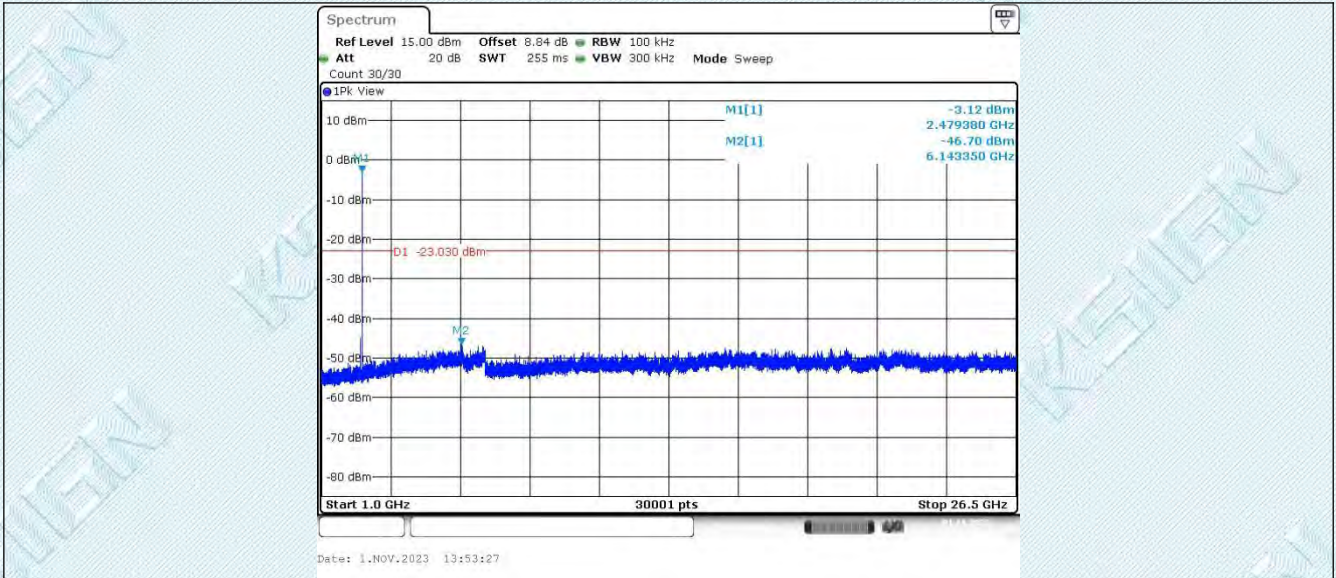

TRF RF_R1

Add: West Side of 1/F., Building C, Zone A, Fuyuan New Factory, Jiujiu Industrial Park, Minzhu, Shatou, Shajing, Bao'an District, Shenzhen, Guangdong, China

Tel: +(86) 0755-2985 2678 Fax: +(86) 0755-2985 2397 E-mail: info@gdkesign.cn Web: www.gdkesign.com

6.8. Appendix H: Duty Cycle

6.8.1. Test Result

TestMode	Antenna	Freq[MHz]	ON Time [ms]	Period [ms]	DC [%]	Limit	Verdict
BLE_1M	Ant1	2402	0.41	0.63	65.08	---	PASS
		2440	0.41	0.63	65.08	---	PASS
		2480	0.41	0.63	65.08	---	PASS

DC=ON Time/Period*100%

6.8.2. Test Graphs



TRF RF_R1

Add: West Side of 1/F., Building C, Zone A, Fuyuan New Factory, Jiujiu Industrial Park, Minzhu, Shatou, Shajing, Bao'an District, Shenzhen, Guangdong, China

Tel: +(86) 0755-2985 2678 Fax: +(86) 0755-2985 2397 E-mail: info@gdksign.cn Web: www.gdksign.com

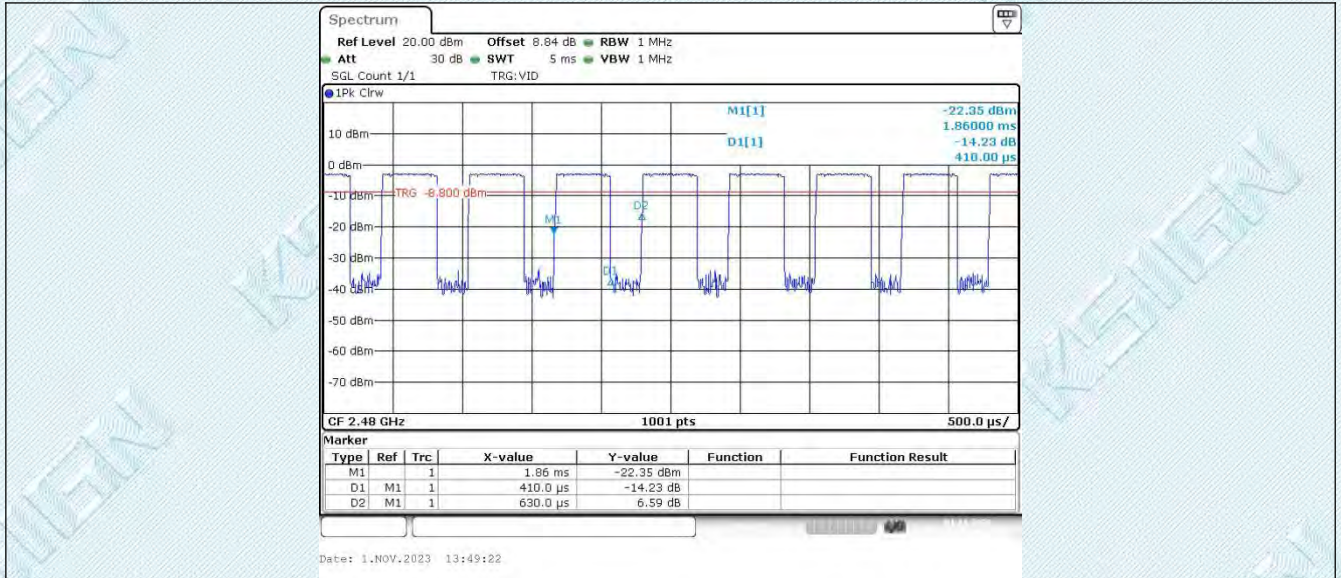

--THE END--

Important Notice

1.	The results are valid only for the samples submitted.
2.	The report is invalid without the "APPROVED" and the "seal for riding".
3.	The test report is invalid without the signatures of Approver, Reviewer and Testing engineer.
4.	The test report can not be partially copied unless prior written approval is issued from our lab.
5.	If the report is not stamped with the CMA seal, it indicates that the report does not have the role of proof for society.
6.	Product information, customer information and sample sources are provided by the client, and we are not responsible for their authenticity;
7.	The test basis or test items marked ★ are not within the scope of CNAS accreditation and CMA accreditation of our laboratory.
8.	The report is invalid when anything of following happens – illegal transfer, reproduce, embezzlement, imposture, modification or tampering in any media form.
9.	If there is any objection to report, the client should inform issuing laboratory within 15 days from the date of.
10.	For cases where compliance is determined based on test values, when relevant specifications, standards, documents, and customers have no relevant requirements and no other special instructions, the test report issued by this laboratory is carried out in full value and adopts ILAC-G8:09 /2019 "Simple Acceptance Rule" for judgment.