

PHILIPS

Wireless Speaker

1000 Series

TAS1209



User manual

Register your product and get support at:
www.philips.com/support

Contents

1 Important	2
Safety	2
Care for your product	2
<hr/>	
2 Your wireless speaker	3
What's in the box	3
Overview of the speaker	3
<hr/>	
3 Get started	4
Charge the built-in battery	4
Turn on/off	4
<hr/>	
4 Play from Bluetooth devices	5
Connect the speaker to your Bluetooth device	5
Bluetooth indicator	5
Control playback	5
Control phone call	5
Pair for stereo mode	5
<hr/>	
5 Product information	6
<hr/>	
6 Troubleshooting	6
General	6
Bluetooth	7
<hr/>	
7 Notice	7
Compliance	7
Care of the environment	7
FCC and IC statement	8
Trademark notice	9

1 Important

Safety

Important safety instructions

- Make sure that the power supply voltage corresponds to the voltage on the back or the underside of the unit.
- The speaker shall not be exposed to dripping or splashing.
- Do not place any source of danger on the speaker (e.g. liquid filled objects, lit candles).
- Make sure that there is enough free space around the speaker for ventilation.
- Please use the speaker safely in an environment with temperature between 0 °C and 40 °C.
- Only use attachments and accessories specified by the manufacturer.

Battery safety precautions

- Danger of explosion if a battery is incorrectly replaced. Replace only with the same or equivalent type.
- A battery (battery pack or battery installed) shall not be exposed to excessive heat such as sunshine, fire or the like.
- A battery in extreme high or low temperatures during use, storage or transportation, and low air pressure at high altitude can pose safety hazards.
- Do not replace a battery with an incorrect type that can defeat a safeguard (for example, some lithium battery types).

- Disposing a battery into fire or a hot oven, mechanically crushing or cutting a battery can result in an explosion.
- Leaving a battery in an extremely high temperature surrounding, or an extremely low air pressure environment may result in an explosion or leakage of flammable liquid or gas.

Care for your product

- Use only microfiber cloth to clean the product.
- Please note that your device contains built-in lithium batteries. The charging capacity of lithium batteries will decrease over time due to their self-discharge characteristics. To ensure the longevity of your device's battery, we recommend charging the built-in lithium battery to around 50% every 6 months when the device is not in use.



Warning

- Never remove the casing of this speaker.
- Never lubricate any part of this speaker.
- Place this speaker on a flat, hard and stable surface.
- Never place this speaker on other electrical equipment.
- Only use this speaker indoors. Keep this speaker away from water, moisture and liquid-filled objects.
- Keep this speaker away from direct sunlight, naked flames or heat.
- Risk of explosion if a battery is replaced by an incorrect type.

2 Your wireless speaker

Congratulations on your purchase, and welcome to Philips! To fully benefit from the support that Philips offers, register your product at www.philips.com/support.

What's in the box

Check and identify the contents of your package:

- Speaker
- USB cable
- Quick start guide / safety sheet / warranty

Overview of the speaker

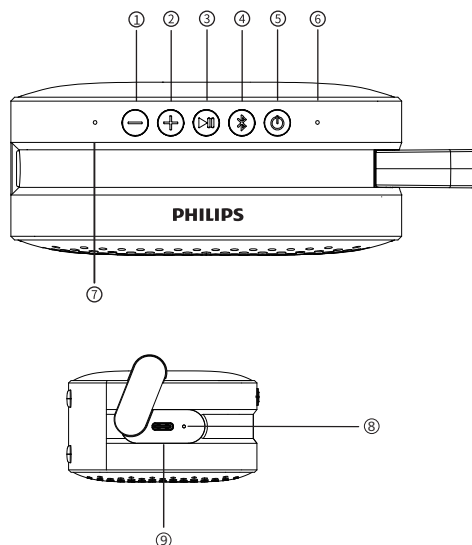

- ① **—**
Adjust the volume down
- ② **+**
Adjust the volume up
- ③ **▶||**
Play or pause the audio playback /
Answer or reject a call
- ④ **📶**
Bluetooth / Stereo connection
- ⑤ **⏻**
Turn the speaker on or off
- ⑥ **LED Light**
Power / Bluetooth / Stereo status
indication
- ⑦ **Microphone**
- ⑧ **LED Light**
Battery low / charging indication
- ⑨ **DC IN**
Charge the build-in battery

3 Get started

Always follow the instructions in this chapter in sequence.

Charge the built-in battery

The speaker is powered by a built-in rechargeable battery.

Note

- Fully charge the built-in battery before using.

Connect the USB-C socket on the speaker to an outlet (5V=1A) by using the provided USB cable.

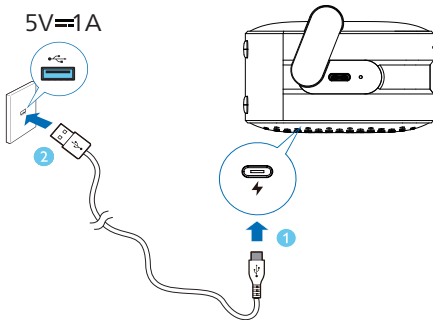

- ↳ When the speaker is being charged, the LED indicator turns red.
- ↳ When the speaker is fully charged, the LED indicator goes off.
- ↳ When battery level less than 10%, you will hear voice prompt once every 60 second.
- ↳ When battery level less than 2%, the speaker will power off.

Caution

- Risk of speaker damage! Make sure the power supply voltage corresponds to the voltage printed on the back or the underside of the speaker.
- Risk of electric shock! When unplug the USB cable, always pull the plug from the socket. Never pull the cable.
- Use only a USB cable specified by the manufacturer or sold with this speaker.

Turn on/off

Press  to turn the speaker on.

↳ You will hear the prompt sound.

To turn the speaker off, press  again.

↳ You will hear the prompt sound.

Note

- The speaker will turn off automatically if there is no audio signal from Bluetooth for 3 minutes.



4 Play from Bluetooth devices

Connect the speaker to your Bluetooth device

With this speaker, you can enjoy audio from your Bluetooth device.

Note

- Make sure that the Bluetooth function is enabled on your device.
- The maximum distance for pairing the speaker and your Bluetooth device is 30 meters (99 feet).
- Keep away from any other electronic device that may cause interference.





1. Press  to turn the speaker on. It will enter Bluetooth pairing mode automatically with white light blinking slow. You can also press  to enter Bluetooth pairing mode.
2. Enable Bluetooth and select "Philips S1209" in the Bluetooth list on your device for pairing.
3. Play audio on your Bluetooth device to start streaming music.

Bluetooth status' LED indication



LED indication	Bluetooth status
Blink white quickly	Ready for pairing
Blink white slowly	Reconnecting the last connected device
Solid blue	Connected

Control playback

During playing the music







-  Press to pause or resume play
-  Press twice to play the next track
-  Press three times to play the previous track
-  Short press to decrease/increase one level of volume
-  Long press to decrease/increase continuously the volume

Control phone call

-  Press to answer or end a call
-  Press and hold to reject a call
-  Adjust the volume

Pairing for stereo mode

Two identical wireless speakers (Philips S1209) can pair with each other for stereo sound.

1. Press  to power on both speakers, they will enter Bluetooth pairing mode automatically. Either one speaker long press  disconnect from Bluetooth device. The other speaker connected to your Bluetooth device will be used as the primary speaker.
2. Press  twice on both speakers to enter stereo pairing mode and the LED indicator blinks white and blue alternately. Once connected successfully, you will hear a prompt sound, and the primary speaker's LED indicate solid blue while the secondary speaker's indicate solid white.
3. Press  /  /  on either speakers will play / pause / adjust volume through both speakers.
4. To exit the stereo mode, press  twice on either speaker.

Note

To clear the pairing information, you can press and hold  for 3 seconds until the LED blinks white quickly.

5 Product information

Note

- Product information is subject to change without prior notice.

General information

USB port	5V= 1A
Built-in Lithium battery	1500 mAh
Dimensions (W x H x D)	123.4x79x46mm
Weight (main unit)	195g
Operation Ambient	0°C~40°C

Amplifier

Output power(RMS)	5W
Frequency response	110HZ~18KHZ
Signal to noise ratio	>70dB

Speaker

Impedance	4Ω
Maximum input power	5W
Driver	Diameter 40mm
Passive radiators	1

Bluetooth

Bluetooth version	5.3
Frequency range	2402 - 2480 MHz
Maximum transmission power	<10dBm
Compatible Bluetooth profiles	Supports a2dp/avctp/avrcp/hfp
Bluetooth range	open area BT up to 30m TWS up to 10m

6 Troubleshooting

Warning

- Never remove the casing of the speaker.

To keep the warranty valid, never try to repair the speaker yourself. If you encounter problems when using this speaker, check the following points before requesting service. If the problem remains unsolved, go to the Philips website (www.philips.com/support). When you contact Philips, ensure that the speaker is nearby and the model number and serial number are available.

General

No power

- Make sure the speaker is fully charged.
- Make sure the USB socket of the speaker is properly connected.
- As a power-saving feature, the speaker turns off automatically 15 minutes after no audio signal is received.

No sound

- Adjust the volume on this speaker.
- Adjust the volume on the connected device.
- Make sure that your Bluetooth device is within the operational range.

No response from the speaker

- Restart the speaker.

Bluetooth

The audio quality is poor after connection with a Bluetooth-enabled device

- The Bluetooth reception is poor. Move the device closer to this speaker or remove any obstacle between them.

Fail to find [Philips S1209] on your Bluetooth device for pairing

- Press  to enter Bluetooth pairing mode, and then try again.

Cannot connect with your Bluetooth device

- The Bluetooth function of your device is not enabled. Refer to the user manual of your device to find out how to enable the function.
- This speaker is not in pairing mode.
- This speaker is already connected to another Bluetooth-enabled device. Disconnect and try again.

7 Notice

Any changes or modifications made to this device that are not expressly approved by MMD Hong Kong Holding Limited may void the user's authority to operate the equipment.

Compliance



Hereby, TP Vision Europe B.V. declares that this product is in compliance with the essential requirements and other relevant provisions of Directive 2014/53/EU. You can find the Declaration of Conformity on www.philips.com/support.

Care of the environment

Disposal of your old product and battery



Your product is designed and manufactured with high quality materials and components, which can be recycled and reused.



This symbol on a product means that the product is covered by European Directive 2012/19/EU.



This symbol means that the product contains batteries covered by European Regulation (EU) 2023/1542 which cannot be disposed of with normal household waste.

Inform yourself about the local separate collection system for electrical and electronic products and batteries. Follow local rules and never dispose of the product and batteries with normal household waste. Correct disposal of old products and batteries helps prevent negative consequences for the environment and human health.

Removing the integrated batteries.

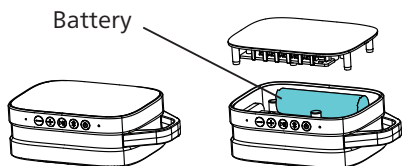

FCC and IC statement

FCC information

The device complies with the FCC rules, Part 15. Operation is subject to the following two conditions:

- ① This device may not cause harmful interference, and.
- ② This device must accept any interference received, including interference that may cause undesired operation.

Warning: Changes or modifications not expressly approved by the party responsible for compliance could void the user's authority to operate the equipment.

Note: This equipment has been tested and found to comply with the limits for a Class B digital device, pursuant to Part 15 of the FCC Rules.

These limits are designed to provide reasonable protection against harmful interference in a residential installation.

This equipment generates, uses and can radiate radio frequency energy and, if not installed and used in accordance with the instructions, may cause harmful interference to radio communications. However, there is no guarantee that interference will not occur in a particular installation. If this equipment does cause harmful interference to radio or television reception, which can be determined by turning the equipment off and on, the user is encouraged to try to correct the interference by one or more of the following measures:

- (1) Reorient or relocate the receiving antenna.
- (2) Increase the separation between the equipment and receiver.
- (3) Connect the equipment into an outlet on a circuit different from that to which the receiver is connected.

(4) Consult the dealer or an experienced radio/TV technician for help.

RF Warning Statement

The device has been evaluated to meet general RF exposure requirements. The device can be used in portable exposure conditions without restriction.

IC-Canada: CAN ICES-003(B)/NMB-003(B)

This device contains licence-exempt transmitter(s)/receiver(s) that comply with Innovation, Science and Economic Development Canada's licence-exempt RSS(s). Operation is subject to the following two conditions:

1. This device may not cause interference.
2. This device must accept any interference, including interference that may cause undesired operation of the device.

Avis d'Industrie Canada: CAN ICES-003 (B)/NMB-003(B)

L'émetteur/récepteur exempt de licence contenu dans le présent appareil est conforme aux CNR d'Innovation, Sciences et Développement économique Canada applicables aux appareils radio exempts de licence. L'exploitation est autorisée aux deux conditions suivantes :

1. L'appareil ne doit pas produire de brouillage;
2. L'appareil doit accepter tout brouillage radioélectrique subi, même si le brouillage est susceptible d'en compromettre le fonctionnement.

Radiation Exposure Statement: The product comply with the Canada portable RF exposure limit set forth for an uncontrolled environment and are safe for intended operation as described in this manual. **Déclaration d'exposition aux radiations:** Le produit est conforme aux limites d'exposition pour les appareils portables RF pour les Etats-Unis et le Canada établies pour un environnement non contrôlé.

Trademark notice



The Bluetooth® word mark and logos are registered trademarks owned by the Bluetooth SIG, Inc. and any use of such marks by MMD Hong Kong Holding Limited is under license.

Other trademarks and trade names are those of their respective owners.



Specifications are subject to change without notice.

Philips and the Philips Shield Emblem are registered trademarks of Koninklijke Philips N.V. and are used under license.

This product has been manufactured by and is sold under the responsibility of MMD Hong Kong Holding Limited or one of its affiliates, and MMD Hong Kong Holding Limited is the warrantor in relation to this product.

TAS1209_00_UM_V1.0

