

SPECIFICATION

Shenzhen Strongpower Communication Co., Ltd

Model: RQ-HD2-BT-V3

Type: FPC Ant

Address: 502-A, Building W2-A, High-tech Industrial Village, No. 025, South 4th Road,
Gaoxin, High-tech Zone Community, Yuehai Street, Nanshan District, Shenzhen

1. Testing Environment

1).Test system

chamber

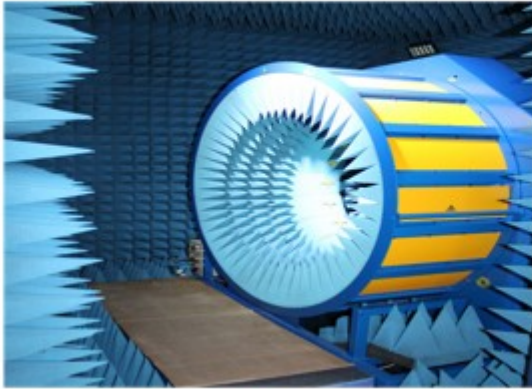

Satimo

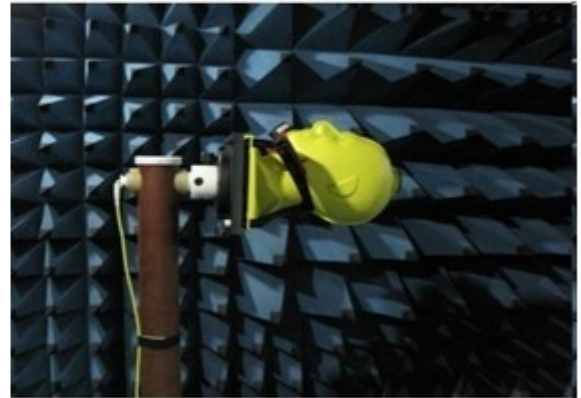

Airlink

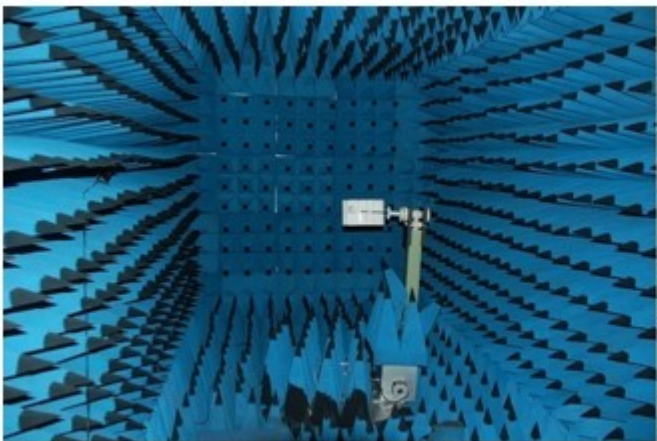

Guang Ping

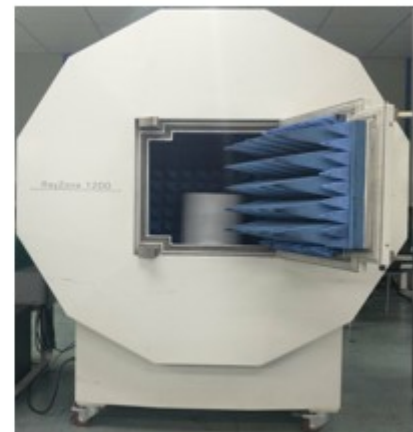

GTS

2).Testing instrument

equipment

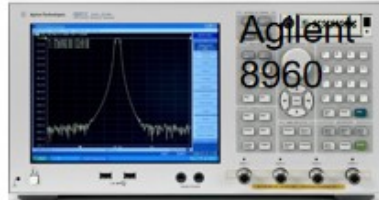

2. Passive test data

1).S11 Parameters

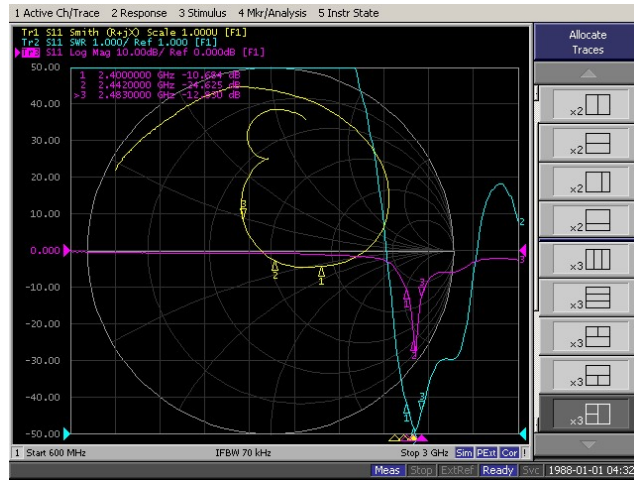

2).Efficiency&Gain

Freq. (MHz)	Eff. %	Gain dBi
2400	29.14%	0.33
2410	28.27%	0.25
2420	29.71%	0.34
2430	29.86%	0.45
2440	27.86%	0.23
2450	26.74%	0.15
2460	26.31%	0.15
2470	26.13%	0.28
2480	26.41%	0.11
2490	25.18%	0.06
2500	25.75%	0.02

3). Passive direction diagram

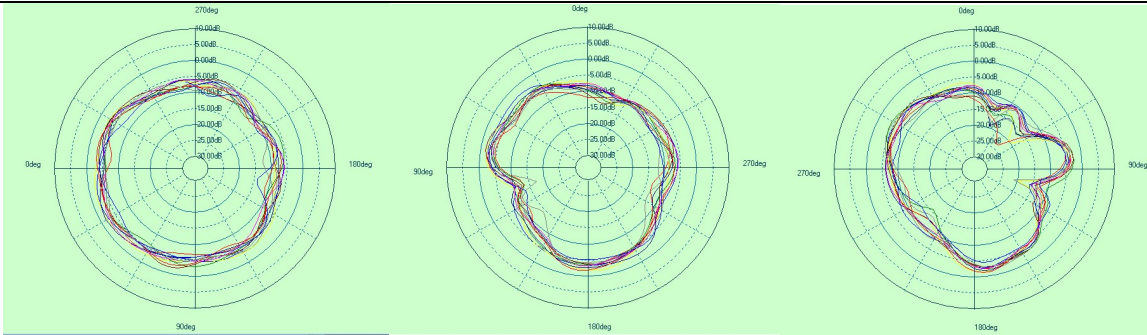

Theta=90°

Phi=0°

Phi=90°

3. Matching circuit

Element	E1	E2	E3
Value	2PF	0 Ω	NC

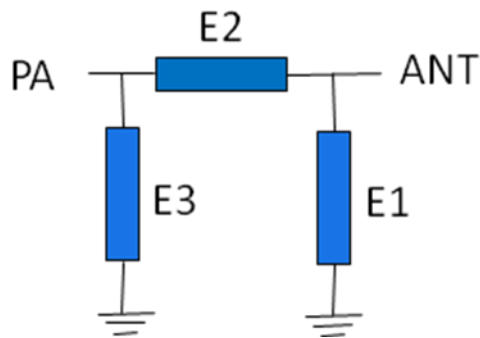

4. Engineering drawing

