

PHILIPS

Headphones

7000 Series

TAN7506



User manual

Register your product and get support at
www.philips.com/support

Contents

1	Important safety instructions	2
	Hearing Safety	2
	General information	2

2	Your Bluetooth wireless headphones	3
	What's in the box	3
	Other devices	3
	Overview of your Bluetooth wireless headphones	4

3	Get started	5
	Charge the battery	5
	Pair the headphones with your mobile phone	5

4	Use your headphones	6
	Connect the headphones to your Bluetooth device	6
	Connect the headphone with your computer	6
	Manage your calls and music	6
	ANC (active noise cancelation)	7
	Voice Assistant	7
	Busy mode	7
	Philips Headphones App	7

5	Technical data	8
---	----------------	---

6	Notice	9
	Declaration of conformity	9
	Disposal of your old product and battery	9
	Remove the integrated battery	9
	Compliance with EMF	9
	Environmental information	10
	Notice of compliance	10

7	Trademarks	11
---	------------	----

8	Frequently asked questions	12
---	----------------------------	----

1 Important safety instructions

Hearing Safety



Danger

- To avoid hearing damage, limit the time you use headphones at high volume and set the volume to a safe level. The louder the volume, the shorter the safe listening time is.

Be sure to observe the following guidelines when using your headphones.

- Listen at reasonable volumes for reasonable periods of time.
- Be careful not to adjust the volume continuously upwards as your hearing adapts.
- Do not turn up the volume so high that you can't hear what's around you.
- You should use caution or temporarily discontinue use in potentially hazardous situations.
- Excessive sound pressure from headphones and headphones can cause hearing loss.
- Using headphones with both ears covered while driving is not recommended and may be illegal in some areas while driving.
- For your safety, avoid distractions from music or phone calls while in traffic or other potentially dangerous environments.

General information

To avoid damage or malfunction:

Caution

- Do not expose headphones to excessive heat
- Do not drop your headphones.
- Headphones shall not be exposed to dripping or splashing.
- Do not allow your headphones to be submerged in water.
- Do not use any cleaning agents containing alcohol, ammonia, benzene, or abrasives.
- If cleaning is required use a soft cloth, if necessary dampened with a minimum amount of water or diluted mild soap, to clean the product.
- The integrated battery shall not be exposed to excessive heat such as sunshine, fire or the like.
- Replacement of a battery with an incorrect type that can defeat a safeguard;
- Disposal of a battery into fire or a hot oven, or mechanically crushing or cutting of a battery, that can result in an explosion;
- Leaving a battery in an extremely high temperature surrounding environment that can result in an explosion or the leakage of flammable liquid or gas;
- A battery subjected to extremely low air pressure that may result in an explosion or the leakage of flammable liquid or gas.
- Never use your headphones when you are operating a motor vehicle, riding a bicycle, running or walking in traffic areas. It is dangerous and illegal in many places.

About operating and storage temperatures and humidity

- Operating temperature: 0°C (32°F) to 40°C (104°F)
- Storage temperature: -10°C (14°F) to 45°C (113°F)
- Operating humidity: 8% - 90% RH (No condensation)
- Storage humidity: 5% - 90% RH (No condensation)
- Maximum operating altitude: 3000m
- Battery life may be shorter in high or low temperature conditions.

2 Your Bluetooth wireless headphones

Congratulations on your purchase, and welcome to Philips! To fully benefit from the support that Philips offers, register your product at www.philips.com/support. With this Philips wireless headphones, you can:

- enjoy convenient wireless handsfree calls;
- enjoy and control wireless music;
- switch between calls and music.

What's in the box

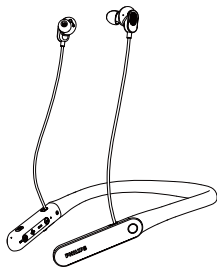

Philips active noise canceling wireless headphones Philips TAN7506



Replaceable rubber ear caps x 3 pairs



USB dongle



USB-C to USB-A convertor

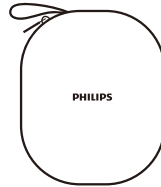

Pouch



USB-C charging cable (for charging only)



Quick start guide



Global Warranty





Safety leaflet

Other devices

A mobile phone or device (e.g. notebook, tablet, Bluetooth adapters, MP3 players etc) which supports Bluetooth and is compatible to the headphones (see 'Technical data' on page 8).

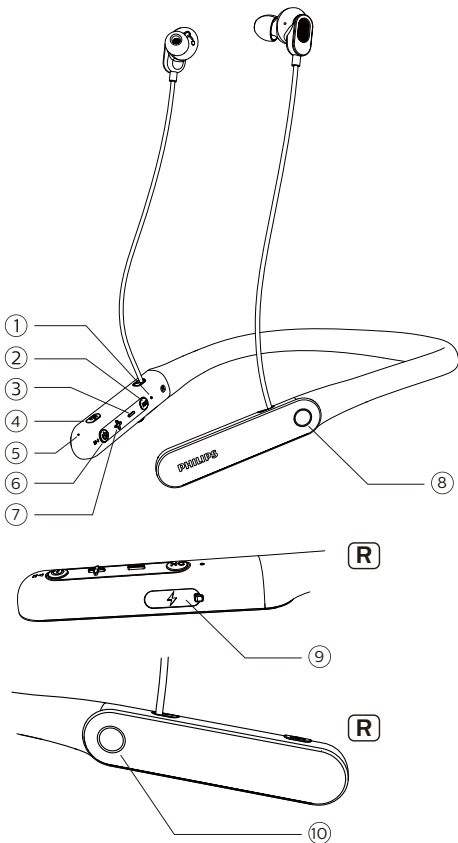
Overview of your Bluetooth wireless headphones



- ① LED indicator
- ② ANC On/Off/Ambient sound button
- ③ Volume -
- ④ Microphone On/Off button
- ⑤ Microphone
- ⑥  (Power On / Off / Pairing)
- ⑦ Volume +
- ⑧ Voice Assistant touch panel
- ⑨ USB-C charging slot
- ⑩ Quick awareness touch panel

3 Get started

Charge the battery

Note

- Before you use your headphone for the first time, place charge the battery for 2 hours for optimum battery capacity and lifetime.
- Use only the original USB-C charging cable to avoid any damage.
- Finish your call before charging the headphone, as connecting the headphone for charging will power the headphone off.

Connect the supplied USB-C charging cable to:

- The USB-C charging slot on the headphones and;
 - The charger/USB port of a computer.
- ↳ LED turns white during charging and turns off when the headphones in fully charged.

Tip

- Normally, a full charge takes 2 hours.

Pair the headphones with your mobile phone

Before you use the headphones with your mobile phone for the first time, pair it with a mobile phone. A successful pairing establishes a unique encrypted link between the headphones and mobile phone. The headphones store the last 4 devices in the memory. If you try to pair more than 4 devices, the earliest paired device is replaced by the new one.

- 1 Make sure that the headphones are fully charged and turned off.
- 2 Press and hold  for 5 seconds until the white and blue LED flash alternately.
 - ↳ The headphones remain in pairing mode for 2 minutes.
- 3 Make sure that the mobile phone is turned on and its Bluetooth feature is activated.
- 4 Pair the headphones with the mobile phone. For detailed information, refer to the user manual of your mobile phone.

The following example shows you how to pair the headphones with your mobile phone.

- 1 Activate the Bluetooth feature of your mobile phone, select **Philips TAN7506**
- 2 Enter the headphone password "0000" (4 zeros) if prompted. For those mobile phones featuring Bluetooth 3.0 or higher, no need to enter a password.



Philips TAN7506

4 Use your headphones

Connect the headphone to your Bluetooth device

- 1 Turn on your mobile phone/ Bluetooth device.
- 2 Press and hold the on/off button to turn the headphones on.
 - ↳ The blue LED is on 3s.
 - ↳ The headphones are reconnected to the last connected mobile phone/ Bluetooth device automatically.

Tip

- If you turn on the mobile phone/Bluetooth device or activate the Bluetooth feature after turning on the headphones, you have to reconnect the headphones and mobile phone/Bluetooth device manually.

Note

- If the headphones fail to connect to any Bluetooth device within range in 5 minutes, it will switch off automatically to save the battery life when ANC off or in idle mode.

Connect the headphone with your computer

- 1 Plug the dongle into your computer with USBC or USBA with converter .

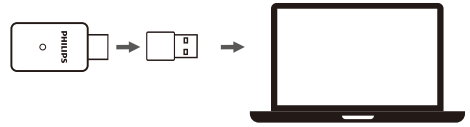

- 2 Turn on the headphone, your computer and headphone will be connected automatically

Tip

- Dongle will have solid blue led when connected.

Note

To reconnect:



- a) Plug out and plug in your dongle from the computer and wait for it to auto connect.

Or

- b) With the dongle in the computer USB port, press the button on the dongle once to initiate a connection with your device.

Manage your calls and music



On/off

Task	Button	Operation
Turn the headphones on		Press and hold for 2 seconds
Turn the headphones off		Press and hold for 2 seconds <ul style="list-style-type: none">↳ The blue LED flashes 1s and fades out

Music control

Task	Button	Operation
Play or pause music		Press once
Adjust volume	+/-	Press once
Next track	+	Long press 1s
Previous track	-	Long press 1s

Call control

Task	Button	Operation
Pick up		Press once
Hang up a call		Press twice
Switch caller during a call		Press once

ANC (active noise cancelation)

Task	Button	Operation
ANC ON	ANC button	Press once
ANC OFF	ANC button	Press once
Ambient sound	ANC button	Press once

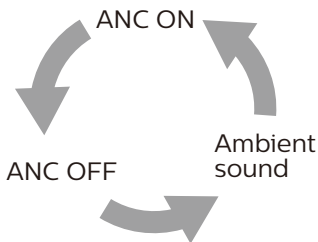

Voice Assistant

Task	Button	Operation
Trigger voice assistant	Voice assistant	Touch and hold

Busy mode

Task	Button	Operation
Busy mode on/off	Volume + and Volume -	Press both simultaneously for 3s to turn the Red LEDs on/off



Tip

- Red LED flashes when you are on a call.

Philips Headphones App

Download and connect to Philips Headphones App to enjoy more function



Other headphones indicator status

Headphones status	Indicator
The headphones are connected to a Bluetooth device, while the headphones in standby mode or while you are listening to music.	The blue LED will flash once every 5s.
The headphones are ready for pairing.	The LED flashes blue and white alternately.
The headphones are on but not connected to a Bluetooth device.	The blue LED flashes slowly If no connection can be made, the headphones will turn itself off within 5 minutes.
Low battery level.	The white LED flashes until it is out of power
Battery is fully charged.	White LED is off.

5 Technical data

- Music time — ANC enabled with Bluetooth: 15 hours | ANC disabled with Bluetooth: 20 hours
- Talk time — 20 hours
- Standby time — ANC disabled with Bluetooth: 150 hours
- Charging time: 2 hours
- Rechargeable lithium polymer battery (200 mAh)
- Bluetooth version: 5.0
- Compatible Bluetooth profiles:
 - HFP (Hands-Free Profile-HFP)
 - A2DP (Advanced Audio Distribution Profile)
 - AVRCP (Audio Video Remote Control Profile)
- Supported audio codec: SBC
- Frequency range: 20-20,000 Hz (Bluetooth)
- Transmitter power: < 10 dBm
- Operating range: Up to 10 meters (33 feet)
- Digital echo & noise reduction
- Auto power off
- USB-C port for charging
- Supports SBC
- Low battery warning: available
- Water resistance: IP54

Note

- Specifications are subject to change without notice.

6 Notice

Declaration of conformity

Hereby, MMD Hong Kong Holding Limited declares that this product is in compliance with the essential requirements and other relevant provisions of Directive 2014/53/EU. You can find the Declaration of Conformity on www.p4c.philips.com.

Disposal of your old product and battery



Your product is designed and manufactured with high quality materials and components, which can be recycled and reused.



This symbol on a product means that the product is covered by European Directive 2012/19/EU.



This symbol means that the product contains a built-in rechargeable battery covered by European Directive 2013/56/EU which cannot be disposed of with normal household waste. We strongly advise you to take your product to an official collection point or a Philips service centre to have a professional remove the rechargeable battery. Inform yourself about the local separate collection system for electrical and electronic products and rechargeable batteries. Follow local rules and never dispose of the product and rechargeable batteries with normal household waste. Correct disposal of old products and rechargeable batteries helps prevent negative consequences for the environment and human health.

Remove the integrated battery

If there is no collection/recycling system for electronic products in your country, you can protect the environment by removing and recycling the battery before disposing the headphones.

- Make sure the headphone is disconnected from the charging case before removing the battery.

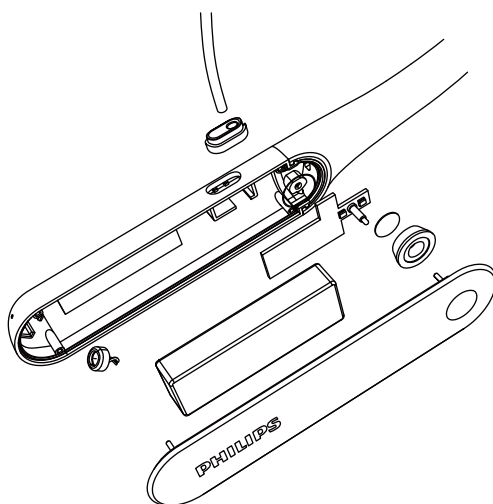

Compliance with EMF

This product complies with all applicable standards and regulations regarding exposure to electromagnetic fields.

Environmental information

All unnecessary packaging has been omitted. We have tried to make the packaging easy to separate into three materials: cardboard (box), polystyrene foam (buffer) and polyethylene (bags, protective foam sheet.)

Your system consists of materials which can be recycled and reused if disassembled by a specialized company. Please observe the local regulations regarding the disposal of packaging materials, exhausted batteries and old equipment.

Notice of compliance

The device complies with the FCC rules, Part 15. Operation is subject to the following two conditions:

1. This device may not cause harmful interference, and
2. This device must accept any interference received, including interference that may cause undesired operation.

FCC rules

This equipment has been tested and found to comply with the limits for a Class B digital device, pursuant to part 15 of the FCC Rules. These limits are designed to provide reasonable protection against harmful interference in a residential installation. This equipment generates, uses and can radiate radio frequency energy and, if not installed and used in accordance with the instruction manual, may cause harmful interference to radio communications. However, there is no guarantee that interference will not occur in a particular installation. If this equipment does cause harmful interference to radio or

television reception, which can be determined by turning the equipment off and on, the user is encouraged to try to correct the interference by one or more of the following measures:

- Reorient or relocate the receiving antenna.
- Increase the separation between equipment and receiver
- Connect the equipment into an outlet on a circuit different from that to which the receiver is connected.
- Consult the dealer or an experienced radio/TV technician for help.

FCC Radiation Exposure Statement:

This equipment complies with FCC radiation exposure limits set forth for an uncontrolled environment.

This transmitter must not be co-located or operating in conjunction with any other antenna or transmitter.

Caution: The user is cautioned that changes or modifications not expressly approved by the party responsible for compliance could void the user's authority to operate the equipment.

Canada:

This device contains licence-exempt transmitter(s)/receiver(s) that comply with Innovation, Science and Economic Development Canada's licence-exempt RSS(s). Operation is subject to the following two conditions: (1) this device may not cause harmful interference, and (2) This device must accept any interference received, including interference that may cause undesired operation of the device.

CAN ICES-3(B)/NMB-3(B)

IC Radiation Exposure Statement:

This equipment complies with Canada radiation exposure limits set forth for uncontrolled environments.

This transmitter must not be co-located or operating in conjunction with any other antenna or transmitter.

7 Trademarks

Bluetooth

The Bluetooth® word mark and logos are registered trademarks owned by Bluetooth SIG, Inc. and any use of such marks by MMD Hong Kong Holding Limited is under license. Other trademarks and trade names are those of their respective owners.

Siri

Siri is a trademark of Apple Inc., registered in the U.S. and other countries.

Google

Google and the Google Logo are registered trademarks of Google Inc.

8 Frequently asked questions

My Bluetooth headphone does not turn on.

The battery level is low. Charge the headphone.

I cannot pair my Bluetooth headphone with my Bluetooth device.

The Bluetooth is disabled. Enable the Bluetooth feature on your Bluetooth device and turn on the Bluetooth device before you turn on the headphone.

The Bluetooth device cannot find the headphone.

- The headphone may be connected to a previously paired device. Turn off the connected device or move it out of range.
- Pairing may have been reset or the headphone has been previously paired with another device. Pair the headphone with the Bluetooth device again as described in the user manual. (see 'Pair the headphone with your Bluetooth device at the first time' on page 5).

The call quality is poor in call.

Make sure you put both earbuds into both ears. They are responsible for sound pick up and environment noise cancellation.

My Bluetooth headphone is connected to a Bluetooth stereo enabled mobile phone, but music only plays on the mobile phone speaker.

Refer to the user manual of your mobile phone. Select to listen to music through the headphone.

The audio quality is poor and crackling noise can be heard.

- The Bluetooth device is out of range. Reduce the distance between your headphone and Bluetooth device, or remove obstacles between them.
- Charge your headphone.

The audio quality is poor when streaming from the mobile phone is very slow, or audio streaming does not work at all.

Make sure your mobile phone not only supports (mono) HSP/HFP but also supports A2DP and is BT4.0x (or higher) compatible (see 'Technical data' on page 8).



Philips and the Philips Shield Emblem are registered trademarks of Koninklijke Philips N.V. and are used under license. This product has been manufactured by and is sold under the responsibility of MMD Hong Kong Holding Limited or one of its affiliates, and MMD Hong Kong Holding Limited is the warrantor in relation to this product.



