

FCC Radio Test Report

FCC ID: 2AR2STAFW1RE

This report concerns: Original Grant

Project No. : 2112C090
Equipment : Wireless subwoofer
Brand Name : 
Test Model : PHILIPS or TAFW1/37
Series Model : TAFW1, TAFW1RE, TAFW1RE/10, TAFW1/10, TAFW1RE/37, TAFW1/98, TAFW1RE/98, TAFW1xx/yy(x=A-Z or blank, yy=00-99 or blank for country code)
Applicant : MMD Hong Kong Holding Limited
Address : Unit 1006, 10th Floor, C-Bons International Center, 108 Wai Yip Street, Kwun Tong, Kowloon, Hong Kong
Manufacturer : MMD Hong Kong Holding Limited
Address : Unit 1006, 10th Floor, C-Bons International Center, 108 Wai Yip Street, Kwun Tong, Kowloon, Hong Kong
Factory : Zhong Shan City Richsound Electronic Industrial Ltd.
Address : No.16, East Shagang Road, Gangkou, Zhongshan, Guangdong, China
Date of Receipt : Dec. 16, 2021
Date of Test : Dec. 17, 2021 ~ Mar. 02, 2022
Issued Date : Mar. 19, 2022
Report Version : R00
Test Sample : Engineering Sample No.: DG202112168 for Conducted, DG202112167 for radiated and AC Power Line Conducted Emissions.
Standard(s) : FCC CFR Title 47, Part 15, Subpart E
 FCC KDB 789033 D02 General UNII Test Procedures New Rules v02r01
 ANSI C63.10-2013

The above equipment has been tested and found compliance with the requirement of the relative standards by BTL Inc.

Prepared by : Evan Yang

Approved by : Chay Cai



TESTING CERT #5123.02

Add: No. 3 Jinshagang 1st Rd. Shixia, Dalang Town Dongguan City, Guangdong 523792

People's Republic of China

Tel: +86-769-8318-3000

Web: www.newbtl.com

Declaration

BTL represents to the client that testing is done in accordance with standard procedures as applicable and that test instruments used has been calibrated with standards traceable to international standard(s) and/or national standard(s).

BTL's reports apply only to the specific samples tested under conditions. It is manufacture's responsibility to ensure that additional production units of this model are manufactured with the identical electrical and mechanical components. **BTL** shall have no liability for any declarations, inferences or generalizations drawn by the client or others from **BTL** issued reports.

The report must not be used by the client to claim product certification, approval, or endorsement by NVLAP, NIST, A2LA, or any agency of the U.S. Government.

This report is the confidential property of the client. As a mutual protection to the clients, the public and ourselves, the test report shall not be reproduced, except in full, without our written approval.

BTL's laboratory quality assurance procedures are in compliance with the **ISO/IEC 17025** requirements, and accredited by the conformity assessment authorities listed in this test report.

BTL is not responsible for the sampling stage, so the results only apply to the sample as received.

The information, data and test plan are provided by manufacturer which may affect the validity of results, so it is manufacturer's responsibility to ensure that the apparatus meets the essential requirements of applied standards and in all the possible configurations as representative of its intended use.

Limitation

For the use of the authority's logo is limited unless the Test Standard(s)/Scope(s)/Item(s) mentioned in this test report is (are) included in the conformity assessment authorities acceptance respective.

Please note that the measurement uncertainty is provided for informational purpose only and are not use in determining the Pass/Fail results.

Table of Contents	Page
REPORT ISSUED HISTORY	6
1 . SUMMARY OF TEST RESULTS	7
1.1 TEST FACILITY	8
1.2 MEASUREMENT UNCERTAINTY	8
1.3 TEST ENVIRONMENT CONDITIONS	9
2 . GENERAL INFORMATION	10
2.1 GENERAL DESCRIPTION OF EUT	10
2.2 TEST MODES	13
2.3 PARAMETERS OF TEST SOFTWARE	16
2.4 DUTY CYCLE	18
2.5 BLOCK DIAGRAM SHOWING THE CONFIGURATION OF SYSTEM TESTED	20
2.6 SUPPORT UNITS	20
3 . AC POWER LINE CONDUCTED EMISSIONS	21
3.1 LIMIT	21
3.2 TEST PROCEDURE	21
3.3 DEVIATION FROM TEST STANDARD	21
3.4 TEST SETUP	22
3.5 EUT OPERATION CONDITIONS	22
3.6 TEST RESULTS	22
4 . RADIATED EMISSIONS	23
4.1 LIMIT	23
4.2 TEST PROCEDURE	24
4.3 DEVIATION FROM TEST STANDARD	25
4.4 TEST SETUP	25
4.5 EUT OPERATION CONDITIONS	26
4.6 TEST RESULTS - 9 KHZ TO 30 MHZ	26
4.7 TEST RESULTS - 30 MHZ TO 1000 MHZ	26
4.8 TEST RESULTS - ABOVE 1000 MHZ	26
5 . BANDWIDTH	27
5.1 LIMIT	27
5.2 TEST PROCEDURE	27
5.3 DEVIATION FROM STANDARD	27

Table of Contents	Page
5.4 TEST SETUP	28
5.5 EUT OPERATION CONDITIONS	28
5.6 TEST RESULTS	28
6 . MAXIMUM OUTPUT POWER	29
6.1 LIMIT	29
6.2 TEST PROCEDURE	29
6.3 DEVIATION FROM STANDARD	29
6.4 TEST SETUP	29
6.5 EUT OPERATION CONDITIONS	29
6.6 TEST RESULTS	29
7 . POWER SPECTRAL DENSITY	30
7.1 LIMIT	30
7.2 TEST PROCEDURE	30
7.3 DEVIATION FROM STANDARD	30
7.4 TEST SETUP	31
7.5 EUT OPERATION CONDITIONS	31
7.6 TEST RESULTS	31
8 . FREQUENCY STABILITY	32
8.1 LIMIT	32
8.2 TEST PROCEDURE	32
8.3 DEVIATION FROM STANDARD	32
8.4 TEST SETUP	32
8.5 EUT OPERATION CONDITIONS	32
8.6 TEST RESULTS	32
9 . MEASUREMENT INSTRUMENTS LIST	33
10 . EUT TEST PHOTOS	35
APPENDIX A - AC POWER LINE CONDUCTED EMISSIONS	40
APPENDIX B - RADIATED EMISSION - 9 KHZ TO 30 MHZ	43
APPENDIX C - RADIATED EMISSION - 30 MHZ TO 1000 MHZ	48
APPENDIX D - RADIATED EMISSION - ABOVE 1000 MHZ	51
APPENDIX E - BANDWIDTH	288
APPENDIX F - MAXIMUM OUTPUT POWER	313

Table of Contents	Page
APPENDIX G - POWER SPECTRAL DENSITY	318
APPENDIX H - FREQUENCY STABILITY	331

REPORT ISSUED HISTORY

Report Version	Description	Issued Date
R00	Original Issue.	Mar. 19, 2022

1. SUMMARY OF TEST RESULTS

Test procedures according to the technical standard(s):

FCC CFR Title 47, Part 15, Subpart E				
Standard(s) Section	Test Item	Test Result	Judgment	Remark
15.207 15.407(b)	AC Power Line Conducted Emissions	APPENDIX A	PASS	-----
15.407(b) 15.205(a) 15.209(a)	Radiated Emissions	APPENDIX B APPENDIX C APPENDIX D	PASS	-----
15.407(a) 15.407(e)	Bandwidth	APPENDIX E	PASS	-----
15.407(a)	Maximum Output Power	APPENDIX F	PASS	-----
15.407(a)	Power Spectral Density	APPENDIX G	PASS	-----
15.407(g)	Frequency Stability	APPENDIX H	PASS	-----
15.203	Antenna Requirements	-----	PASS	NOTE (2)
15.407(c)	Automatically Discontinue Transmission	-----	PASS	NOTE (3)

Note:

- (1) "N/A" denotes test is not applicable in this test report.
- (2) The device what use a permanently attached antenna were considered sufficient to comply with the provisions of 15.203.
- (3) During no any information transmission, the EUT can automatically discontinue transmission and become standby mode for power saving. the EUT can detect the controlling signal of ACK message transmitting from remote device and verify whether it shall resend or discontinue transmission.
- (4) For UNII-1 this device was functioned as a
 - Outdoor access point device
 - Indoor access point device
 - Fixed point-to-point access points device
 - Client device

1.1 TEST FACILITY

The test facilities used to collect the test data in this report is at the location of No. 3 Jinshagang 1st Rd. Shixia, Dalang Town Dongguan City, Guangdong 523792 People's Republic of China.

BTL's Registration Number for FCC: 357015

BTL's Designation Number for FCC: CN1240

1.2 MEASUREMENT UNCERTAINTY

ISO/IEC 17025 requires that an estimate of the measurement uncertainties associated with the emissions test results be included in the report. The measurement uncertainties given below are based on a 95% confidence level (based on a coverage factor (k=2))

The BTL measurement uncertainty as below table:

A. AC power line conducted emissions test:

Test Site	Method	Measurement Frequency Range	U,(dB)
DG-C02	CISPR	150kHz ~ 30MHz	2.60

B. Radiated emissions test:

Test Site	Method	Measurement Frequency Range	U,(dB)
DG-CB01	CISPR	9kHz ~ 30MHz	2.36

Test Site	Method	Measurement Frequency Range	Ant. H / V	U,(dB)
DG-CB03 (3m)	CISPR	30MHz ~ 200MHz	V	4.36
		30MHz ~ 200MHz	H	3.32
		200MHz ~ 1,000MHz	V	4.08
		200MHz ~ 1,000MHz	H	3.96

Test Site	Method	Measurement Frequency Range	U,(dB)
DG-CB03 (3m)	CISPR	1GHz ~ 6GHz	3.80
		6GHz ~ 18GHz	4.82

Test Site	Method	Measurement Frequency Range	U,(dB)
DG-CB03 (1m)	CISPR	18 ~ 26.5 GHz	3.62
		26.5 ~ 40 GHz	4.00

C. Other Measurement:

Test Item	Uncertainty
Bandwidth	±3.8 %
Maximum Output Power	±0.95 dB
Power Spectral Density	±0.86 dB
Frequency Stability	±0.16 dB
Temperature	±0.08 °C
Humidity	±1.5%

Note: Unless specifically mentioned, the uncertainty of measurement has not been taken into account to declare the compliance or non-compliance to the specification.

1.3 TEST ENVIRONMENT CONDITIONS

Test Item	Temperature	Humidity	Test Voltage	Tested By
AC Power Line Conducted Emissions	21°C	50%	AC 120V/60Hz	Aries Tang
Radiated Emissions-9kHz to 30MHz	20°C	53%	AC 120V/60Hz	Torocat Yuan
Radiated Emissions-30MHz to 1000MHz	20°C	51%	AC 120V/60Hz	Jakyri Wen
Radiated Emissions-Above 1000 MHz	19°C	50%	AC 120V/60Hz	Jakyri Wen
Bandwidth	22°C	51%	AC 120V/60Hz	Nicole Chen
Maximum Output Power	23.2°C	52.4%	AC 120V/60Hz	Ansel Yang
Power Spectral Density	22°C	51%	AC 120V/60Hz	Nicole Chen
Frequency Stability	Normal & Extreme	51%	Normal & Extreme	Nicole Chen

2. GENERAL INFORMATION

2.1 GENERAL DESCRIPTION OF EUT

Equipment	Wireless subwoofer
Brand Name	 PHILIPS or
Test Model	TAFW1/37
Series Model	TAFW1, TAFW1RE, TAFW1RE/10, TAFW1/10, TAFW1RE/37, TAFW1/98, TAFW1RE/98, TAFW1xx/yy(x=A-Z or blank, yy=00-99 or blank for country code)
Model Difference(s)	Only differ in model name.
Power Source	AC Mains.
Power Rating	AC 100-240V~ 50/60Hz 50W
Operation Frequency Band(s)	UNII-1: 5150 MHz ~ 5250 MHz UNII-2A: 5250 MHz ~ 5350 MHz UNII-2C: 5470 MHz ~ 5725 MHz UNII-3: 5725 MHz ~ 5850 MHz
Modulation Type	IEEE 802.11a/n/ac: OFDM
Bit Rate of Transmitter	IEEE 802.11a: 54/48/36/24/18/12/9/6 Mbps IEEE 802.11n: up to 150 Mbps IEEE 802.11ac: up to 433.3 Mbps
Maximum Output Power _UNII-1	IEEE 802.11ac(VHT80): 12.50 dBm (0.0178 W)
Maximum Output Power _UNII-2A	IEEE 802.11ac(VHT40): 12.81 dBm (0.0191 W)
Maximum Output Power _UNII-2C	IEEE 802.11ac(VHT40): 12.84 dBm (0.0192 W)
Maximum Output Power _UNII-3	IEEE 802.11ac(VHT80): 7.65 dBm (0.0058 W)

Note:

1. For a more detailed features description, please refer to the manufacturer's specifications or the user's manual.

2. Channel List:

IEEE 802.11a IEEE 802.11n(HT20) IEEE 802.11ac(VHT20)		IEEE 802.11n(HT40) IEEE 802.11ac(VHT40)		IEEE 802.11ac(VHT80)	
UNII-1		UNII-1		UNII-1	
Channel	Frequency (MHz)	Channel	Frequency (MHz)	Channel	Frequency (MHz)
36	5180	38	5190	42	5210
40	5200	46	5230		
44	5220				
48	5240				

IEEE 802.11a IEEE 802.11n(HT20) IEEE 802.11ac(VHT20)		IEEE 802.11n(HT40) IEEE 802.11ac(VHT40)		IEEE 802.11ac(VHT80)	
UNII-2A		UNII-2A		UNII-2A	
Channel	Frequency (MHz)	Channel	Frequency (MHz)	Channel	Frequency (MHz)
52	5260	54	5270	58	5290
56	5280	62	5310		
60	5300				
64	5320				

IEEE 802.11a IEEE 802.11n(HT20) IEEE 802.11ac(VHT20)		IEEE 802.11n(HT40) IEEE 802.11ac(VHT40)		IEEE 802.11ac(VHT80)	
UNII-2C		UNII-2C		UNII-2C	
Channel	Frequency (MHz)	Channel	Frequency (MHz)	Channel	Frequency (MHz)
100	5500	102	5510	106	5530
104	5520	110	5550	122	5610
108	5540	118	5590		
112	5560	126	5630		
116	5580	134	5670		
120	5600				
124	5620				
128	5640				
132	5660				
136	5680				
140	5700				

IEEE 802.11a IEEE 802.11n(HT20) IEEE 802.11ac(VHT20)		IEEE 802.11n(HT40) IEEE 802.11ac(VHT40)		IEEE 802.11ac(VHT80)	
UNII-3		UNII-3		UNII-3	
Channel	Frequency (MHz)	Channel	Frequency (MHz)	Channel	Frequency (MHz)
149	5745	151	5755	155	5775
153	5765	159	5795		
157	5785				
161	5805				
165	5825				

3. Table for Filed Antenna:

Ant.	Manufacturer	P/N	Antenna Type	Connector	Gain (dBi)
1	Yuan de Electronics (ShenZhen) Co. LTD	136-B8506-20B	FPC	N/A	4.80

Note: The antenna gain is provided by the manufacturer.

2.2 TEST MODES

The test system was pre-tested based on the consideration of all possible combinations of EUT operation mode.

Pretest Mode	Description
Mode 1	TX A Mode Channel 36/40/48 (UNII-1)
Mode 2	TX N(HT20) Mode Channel 36/40/48 (UNII-1)
Mode 3	TX N(HT40) Mode Channel 38/46 (UNII-1)
Mode 4	TX AC(VHT20) Mode Channel 36/40/48 (UNII-1)
Mode 5	TX AC(VHT40) Mode Channel 38/46 (UNII-1)
Mode 6	TX AC(VHT80) Mode Channel 42 (UNII-1)
Mode 7	TX A Mode Channel 52/60/64 (UNII-2A)
Mode 8	TX N(HT20) Mode Channel 52/60/64 (UNII-2A)
Mode 9	TX N(HT40) Mode Channel 54/62 (UNII-2A)
Mode 10	TX AC(VHT20) Mode Channel 52/60/64 (UNII-2A)
Mode 11	TX AC(VHT40) Mode Channel 54/62 (UNII-2A)
Mode 12	TX AC(VHT80) Mode Channel 58 (UNII-2A)
Mode 13	TX A Mode Channel 100/116/140 (UNII-2C)
Mode 14	TX N(HT20) Mode Channel 100/116/140 (UNII-2C)
Mode 15	TX N(HT40) Mode Channel 102/110/134 (UNII-2C)
Mode 16	TX AC(VHT20) Mode Channel 100/116/140 (UNII-2C)
Mode 17	TX AC(VHT40) Mode Channel 102/110/134 (UNII-2C)
Mode 18	TX AC(VHT80) Mode Channel 106/122 (UNII-2C)
Mode 19	TX A Mode Channel 149/157/165 (UNII-3)
Mode 20	TX N(HT20) Mode Channel 149/157/165 (UNII-3)
Mode 21	TX N(HT40) Mode Channel 151/159 (UNII-3)
Mode 22	TX AC(VHT20) Mode Channel 149/157/165 (UNII-3)
Mode 23	TX AC(VHT40) Mode Channel 151/159 (UNII-3)
Mode 24	TX AC(VHT80) Mode Channel 155 (UNII-3)
Mode 25	TX AC(VHT40) Mode Channel 102 (UNII-2C)

Following mode(s) was (were) found to be the worst case(s) and selected for the final test.

AC power line conducted emissions test	
Final Test Mode	Description
Mode 25	TX AC(VHT40) Mode Channel 102 (UNII-2C)

Radiated Emissions Test - Below 1GHz	
Final Test Mode	Description
Mode 25	TX AC(VHT40) Mode Channel 102 (UNII-2C)

Radiated Emissions Test - Above 1GHz	
Final Test Mode	Description
Mode 1	TX A Mode Channel 36/40/48 (UNII-1)
Mode 2	TX N(HT20) Mode Channel 36/40/48 (UNII-1)
Mode 3	TX N(HT40) Mode Channel 38/46 (UNII-1)
Mode 4	TX AC(VHT20) Mode Channel 36/40/48 (UNII-1)
Mode 5	TX AC(VHT40) Mode Channel 38/46 (UNII-1)
Mode 6	TX AC(VHT80) Mode Channel 42 (UNII-1)
Mode 7	TX A Mode Channel 52/60/64 (UNII-2A)
Mode 8	TX N(HT20) Mode Channel 52/60/64 (UNII-2A)
Mode 9	TX N(HT40) Mode Channel 54/62 (UNII-2A)
Mode 10	TX AC(VHT20) Mode Channel 52/60/64 (UNII-2A)
Mode 11	TX AC(VHT40) Mode Channel 54/62 (UNII-2A)
Mode 12	TX AC(VHT80) Mode Channel 58 (UNII-2A)
Mode 13	TX A Mode Channel 100/116/140 (UNII-2C)
Mode 14	TX N(HT20) Mode Channel 100/116/140 (UNII-2C)
Mode 15	TX N(HT40) Mode Channel 102/110/134 (UNII-2C)
Mode 16	TX AC(VHT20) Mode Channel 100/116/140 (UNII-2C)
Mode 17	TX AC(VHT40) Mode Channel 102/110/134 (UNII-2C)
Mode 18	TX AC(VHT80) Mode Channel 106/122 (UNII-2C)
Mode 19	TX A Mode Channel 149/157/165 (UNII-3)
Mode 20	TX N(HT20) Mode Channel 149/157/165 (UNII-3)
Mode 21	TX N(HT40) Mode Channel 151/159 (UNII-3)
Mode 22	TX AC(VHT20) Mode Channel 149/157/165 (UNII-3)
Mode 23	TX AC(VHT40) Mode Channel 151/159 (UNII-3)
Mode 24	TX AC(VHT80) Mode Channel 155 (UNII-3)

Conducted Test	
Final Test Mode	Description
Mode 1	TX A Mode Channel 36/40/48 (UNII-1)
Mode 2	TX N(HT20) Mode Channel 36/40/48 (UNII-1)
Mode 3	TX N(HT40) Mode Channel 38/46 (UNII-1)
Mode 4	TX AC(VHT20) Mode Channel 36/40/48 (UNII-1)
Mode 5	TX AC(VHT40) Mode Channel 38/46 (UNII-1)
Mode 6	TX AC(VHT80) Mode Channel 42 (UNII-1)
Mode 7	TX A Mode Channel 52/60/64 (UNII-2A)
Mode 8	TX N(HT20) Mode Channel 52/60/64 (UNII-2A)
Mode 9	TX N(HT40) Mode Channel 54/62 (UNII-2A)
Mode 10	TX AC(VHT20) Mode Channel 52/60/64 (UNII-2A)
Mode 11	TX AC(VHT40) Mode Channel 54/62 (UNII-2A)
Mode 12	TX AC(VHT80) Mode Channel 58 (UNII-2A)
Mode 13	TX A Mode Channel 100/116/140 (UNII-2C)
Mode 14	TX N(HT20) Mode Channel 100/116/140 (UNII-2C)
Mode 15	TX N(HT40) Mode Channel 102/110/134 (UNII-2C)
Mode 16	TX AC(VHT20) Mode Channel 100/116/140 (UNII-2C)
Mode 17	TX AC(VHT40) Mode Channel 102/110/134 (UNII-2C)
Mode 18	TX AC(VHT80) Mode Channel 106/122 (UNII-2C)
Mode 19	TX A Mode Channel 149/157/165 (UNII-3)
Mode 20	TX N(HT20) Mode Channel 149/157/165 (UNII-3)
Mode 21	TX N(HT40) Mode Channel 151/159 (UNII-3)
Mode 22	TX AC(VHT20) Mode Channel 149/157/165 (UNII-3)
Mode 23	TX AC(VHT40) Mode Channel 151/159 (UNII-3)
Mode 24	TX AC(VHT80) Mode Channel 155 (UNII-3)

Note:

- (1) For AC power line conducted emissions and radiated emission below 1 GHz test, the TX AC(VHT40) Mode Channel 102 (UNII-2C) is found to be the worst case and recorded.
- (2) For radiated emission above 1 GHz test, the spurious points of 1GHz~26.5GHz and 26.5GHz~40GHz have been pre-tested and in this report only recorded the worst case. The remaining spurious points are all below the limit value of 20dB.
- (3) All the bit rate of transmitter have been tested and found the lowest rate is found to be the worst case and recorded.

2.3 PARAMETERS OF TEST SOFTWARE

UNII-1			
Test Software Version	RF_Tool_V1.0		
Frequency (MHz)	5180	5200	5240
IEEE 802.11a	39	39	38
IEEE 802.11n(HT20)	39	39	38
IEEE 802.11ac(VHT20)	39	39	38
Frequency (MHz)	5190	5230	
IEEE 802.11n(HT40)	39	38	
IEEE 802.11ac(VHT40)	39	39	
Frequency (MHz)	5210		
IEEE 802.11ac(VHT80)	39		

UNII-2A			
Test Software Version	RF_Tool_V1.0		
Frequency (MHz)	5260	5300	5320
IEEE 802.11a	38	39	40
IEEE 802.11n(HT20)	38	40	41
IEEE 802.11ac(VHT20)	38	40	40
Frequency (MHz)	5270	5310	
IEEE 802.11n(HT40)	38	40	
IEEE 802.11ac(VHT40)	41	43	
Frequency (MHz)	5290		
IEEE 802.11ac(VHT80)	41		

UNII-2C			
Test Software Version	RF_Tool_V1.0		
Frequency (MHz)	5500	5580	5700
IEEE 802.11a	39	39	37
IEEE 802.11n(HT20)	39	40	37
IEEE 802.11ac(VHT20)	39	40	37
Frequency (MHz)	5510	5550	5670
IEEE 802.11n(HT40)	39	39	38
IEEE 802.11ac(VHT40)	42	42	40
Frequency (MHz)	5530	5610	
IEEE 802.11ac(VHT80)	41	40	

UNII-3			
Test Software Version	RF_Tool_V1.0		
Frequency (MHz)	5745	5785	5825
IEEE 802.11a	28	29	29
IEEE 802.11n(HT20)	28	29	29
IEEE 802.11ac(VHT20)	29	30	30
Frequency (MHz)	5755	5795	
IEEE 802.11n(HT40)	29	29	
IEEE 802.11ac(VHT40)	28	30	
Frequency (MHz)	5775		
IEEE 802.11ac(VHT80)	30		

2.4 DUTY CYCLE

If duty cycle is $\geq 98\%$, duty factor is not required.

If duty cycle is $< 98\%$, duty factor shall be considered.

The output power = measured power + duty factor.

The power spectral density = measured power spectral density + duty factor.

IEEE 802.11a

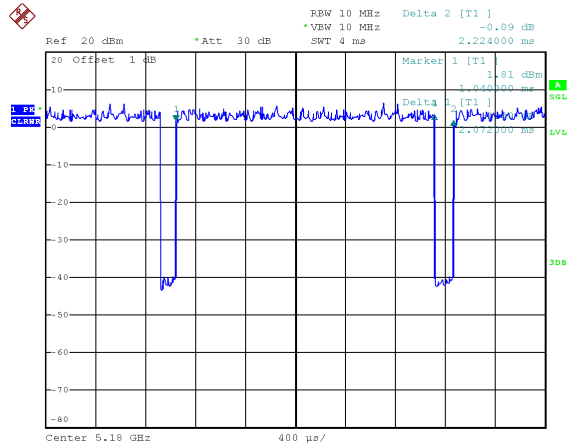

Date: 25.DEC.2021 16:35:35

Duty cycle = 2.072 ms / 2.224 ms = 93.17%
 Duty Factor = 10 log(1 / Duty cycle) = 0.31

IEEE 802.11n(HT20)

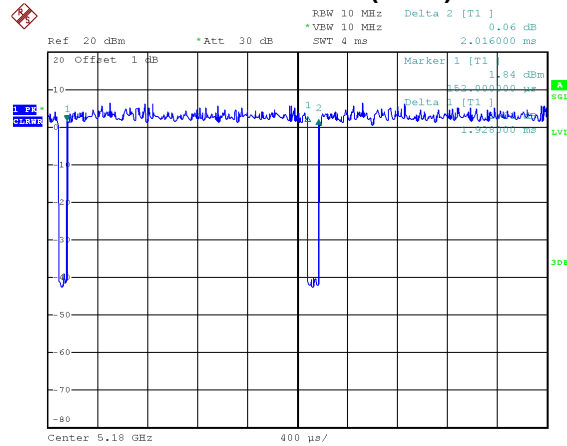

Date: 25.DEC.2021 16:36:34

Duty cycle = 1.928 ms / 2.016 ms = 95.63%
 Duty Factor = 10 log(1 / Duty cycle) = 0.19

IEEE 802.11n(HT40)

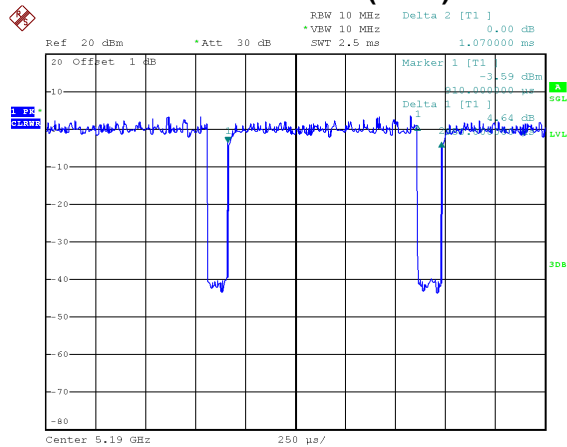

Date: 25.DEC.2021 16:37:08

Duty cycle = 0.950 ms / 1.070 ms = 88.79%
 Duty Factor = 10 log(1 / Duty cycle) = 0.52

IEEE 802.11ac(VHT20)

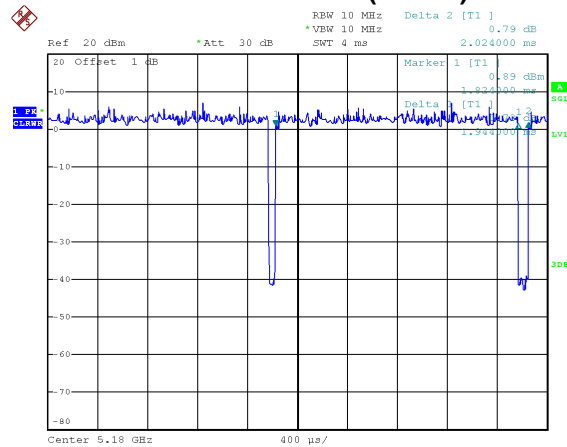

Date: 25.DEC.2021 16:39:26

Duty cycle = 1.944 ms / 2.024 ms = 96.05%
 Duty Factor = 10 log(1 / Duty cycle) = 0.18

IEEE 802.11ac(VHT40)

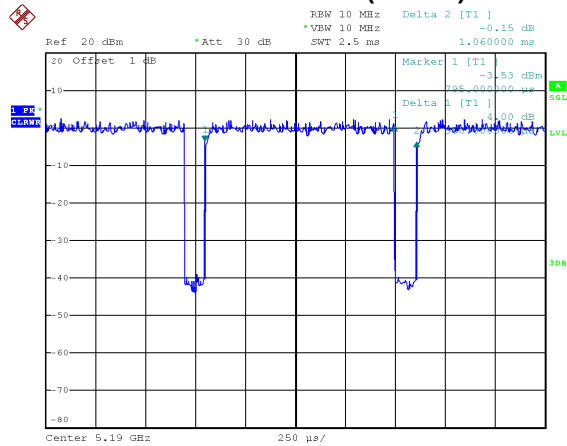

IEEE 802.11ac(VHT80)

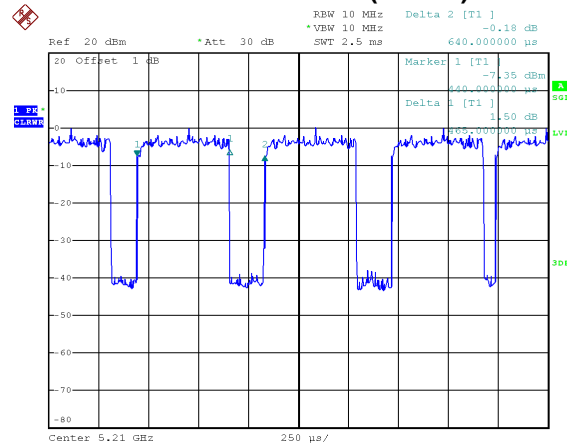

Date: 25.DEC.2021 16:40:54

Duty cycle = 0.950 ms / 1.060 ms = 89.62%
 Duty Factor = 10 log(1 / Duty cycle) = 0.48

Date: 25.DEC.2021 16:42:03

Duty cycle = 0.465 ms / 0.640 ms = 72.66%
 Duty Factor = 10 log(1 / Duty cycle) = 1.39

NOTE:

For IEEE 802.11a:

For radiated emissions frequency above 1 GHz, the resolution bandwidth of test receiver/spectrum analyzer is 1 MHz and the video bandwidth is 483 Hz (Duty cycle < 98%).

For IEEE 802.11n(HT20):

For radiated emissions frequency above 1 GHz, the resolution bandwidth of test receiver/spectrum analyzer is 1 MHz and the video bandwidth is 519 Hz (Duty cycle < 98%).

For IEEE 802.11n(HT40):

For radiated emissions frequency above 1 GHz, the resolution bandwidth of test receiver/spectrum analyzer is 1 MHz and the video bandwidth is 1053 Hz (Duty cycle < 98%).

For IEEE 802.11ac(VHT20):

For radiated emissions frequency above 1 GHz, the resolution bandwidth of test receiver/spectrum analyzer is 1 MHz and the video bandwidth is 514 Hz (Duty cycle < 98%).

For IEEE 802.11ac(VHT40):

For radiated emissions frequency above 1 GHz, the resolution bandwidth of test receiver/spectrum analyzer is 1 MHz and the video bandwidth is 1053 Hz (Duty cycle < 98%).

For IEEE 802.11ac(VHT80):

For radiated emissions frequency above 1 GHz, the resolution bandwidth of test receiver/spectrum analyzer is 1 MHz and the video bandwidth is 2151 Hz (Duty cycle < 98%).

2.5 BLOCK DIAGRAM SHOWING THE CONFIGURATION OF SYSTEM TESTED

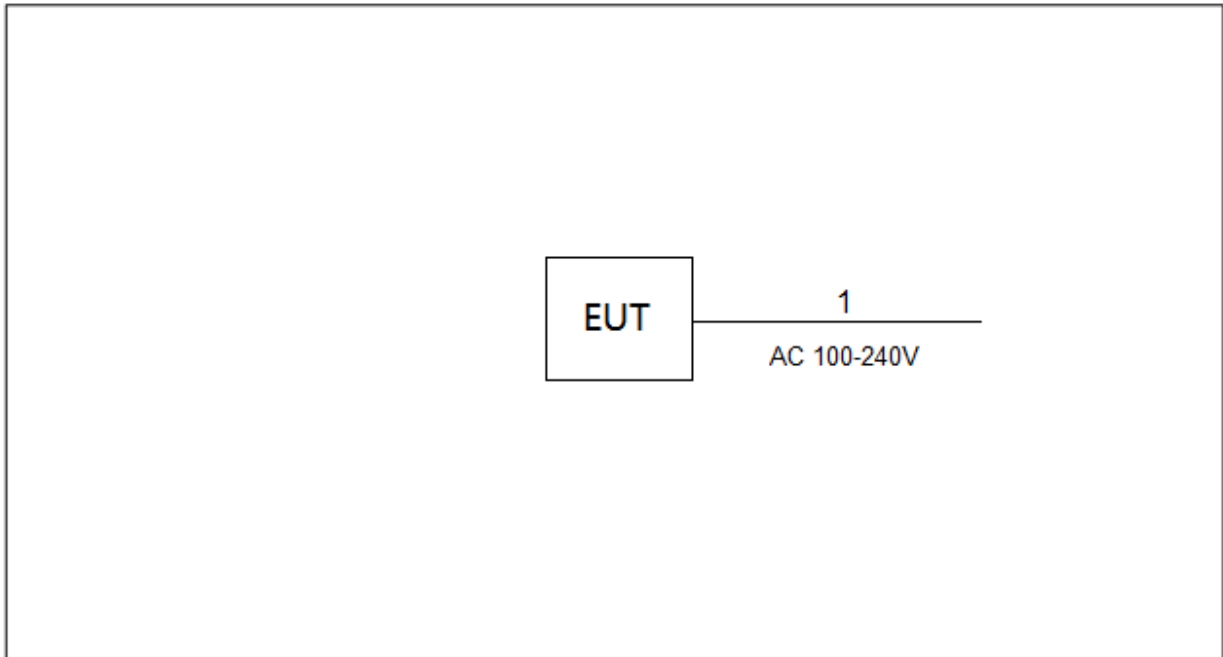

2.6 SUPPORT UNITS

Item	Equipment	Brand	Model No.	Series No.
-	-	-	-	-

Item	Cable Type	Shielded Type	Ferrite Core	Length
1	AC Cable	NO	NO	1.2m

3. AC POWER LINE CONDUCTED EMISSIONS

3.1 LIMIT

Frequency (MHz)	Limit (dB μ V)	
	Quasi-peak	Average
0.15 - 0.5	66 to 56*	56 to 46*
0.5 - 5.0	56	46
5.0 - 30.0	60	50

NOTE:

- (1) The tighter limit applies at the band edges.
- (2) The limit of " * " marked band means the limitation decreases linearly with the logarithm of the frequency in the range.

3.2 TEST PROCEDURE

- a. The EUT was placed 0.8 meters from the horizontal ground plane with EUT being connected to the power mains through a line impedance stabilization network (LISN). All other support equipment powered from additional LISN(s). The LISN provide 50 Ohm/ 50uH of coupling impedance for the measuring instrument.
- b. Interconnecting cables that hang closer than 40 cm to the ground plane shall be folded back and forth in the center forming a bundle 30 to 40 cm long.
- c. I/O cables that are not connected to a peripheral shall be bundled in the center. The end of the cable may be terminated, if required, using the correct terminating impedance. The overall length shall not exceed 1 m.
- d. LISN at least 80 cm from nearest part of EUT chassis.
- e. For the actual test configuration, please refer to the related Item -EUT Test Photos.

The following table is the setting of the receiver:

Receiver Parameter	Setting
Start Frequency	0.15 MHz
Stop Frequency	30 MHz
IF Bandwidth	9 kHz

3.3 DEVIATION FROM TEST STANDARD

No deviation

3.4 TEST SETUP

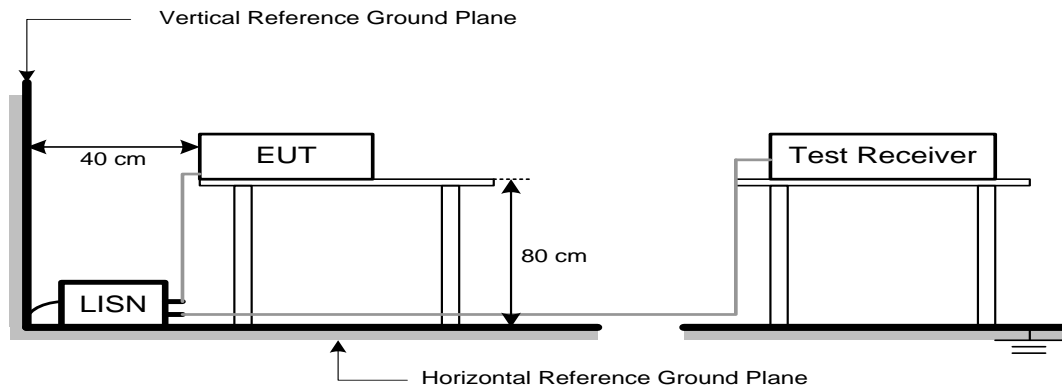

3.5 EUT OPERATION CONDITIONS

The EUT was configured for testing in a typical fashion (as a customer would normally use it). The EUT has been programmed to continuously transmit during test. This operating condition was tested and used to collect the included data.

The EUT was programmed to be in continuously transmitting/TX mode.

3.6 TEST RESULTS

Please refer to the APPENDIX A.

4. RADIATED EMISSIONS

4.1 LIMIT

In case the emission fall within the restricted band specified on 15.205(a), then the 15.209(a) limit in the table below has to be followed.

LIMITS OF RADIATED EMISSIONS MEASUREMENT (9 kHz to 1000 MHz)

Frequency (MHz)	Field Strength (microvolts/meter)	Measurement Distance (meters)
0.009-0.490	2400/F(kHz)	300
0.490-1.705	24000/F(kHz)	30
1.705-30.0	30	30
30-88	100	3
88-216	150	3
216-960	200	3
Above 960	500	3

LIMITS OF UNWANTED EMISSION OUT OF THE RESTRICTED BANDS (Above 1000 MHz)

Frequency (MHz)	EIRP Limit (dBm/MHz)	Band edge at 3m (dBμV/m)	Harmonic at 1.5m (dBμV/m)
5150-5250	-27	68.2	74.2 (Note 3)
5250-5350	-27	68.2	74.2 (Note 3)
5470-5725	-27	68.2	74.2 (Note 3)
5725-5850 NOTE (2)	-27	68.2	74.2 (Note 3)
	10	105.2	111.2 (Note 3)
	15.6	110.8	116.8 (Note 3)
	27	122.2	128.2 (Note 3)

NOTE:

- (1) The following formula is used to convert the equipment isotropic radiated power (eirp) to field strength:

$$E = \frac{1000000\sqrt{30P}}{3} \mu\text{V/m, where P is the eirp (Watts)}$$

- (2) According to 15.407(b)(4)(i), all emissions shall be limited to a level of -27 dBm/MHz at 75 MHz or more above or below the band edge increasing linearly to 10 dBm/MHz at 25 MHz above or below the band edge, and from 25 MHz above or below the band edge increasing linearly to a level of 15.6 dBm/MHz at 5 MHz above or below the band edge, and from 5 MHz above or below the band edge increasing linearly to a level of 27 dBm/MHz at the band edge.

4.2 TEST PROCEDURE

- a. The measuring distance of 3 m shall be used for measurements. The EUT was placed on the top of a rotating table 0.8 meter above the ground at a 3 meter semi-anechoic chamber. The table was rotated 360 degrees to determine the position of the highest radiation.(below 1GHz)
- b. The measuring distance of 3 m or 1.5m shall be used for measurements. The EUT was placed on the top of a rotating table 1.5 meter above the ground at a 3 meter semi-anechoic chamber. The table was rotated 360 degrees to determine the position of the highest radiation.(above 1GHz)
- c. The height of the equipment or of the substitution antenna shall be 0.8m or 1.5m; the height of the test antenna shall vary between 1 m to 4 m. Both horizontal and vertical polarizations of the antenna are set to make the measurement.
- d. For each suspected emission, the EUT was arranged to its worst case and then the antenna was tuned to heights find the maximum reading (used Bore sight function).
- e. The receiver system was set to peak and average detect function and specified bandwidth with maximum hold mode when the test frequency is above 1 GHz.
- f. The initial step in collecting radiated emission data is a receiver peak detector mode pre-scanning the measurement frequency range. Significant peaks are then marked and then Quasi Peak detector mode re-measured.
- g. All readings are Peak unless otherwise stated QP in column of Note. Peak denotes that the Peak reading compliance with the QP Limits and then QP Mode measurement didn't perform. (below 1 GHz)
- h. All readings are Peak Mode value unless otherwise stated AVG in column of Note. If the Peak Mode Measured value compliance with the Peak Limits and lower than AVG Limits, the EUT shall be deemed to meet both Peak & AVG Limits and then only Peak Mode was measured, but AVG Mode didn't perform. (above 1 GHz)
- i. For the actual test configuration, please refer to the related Item –EUT Test Photos.

The following table is the setting of the receiver:

Spectrum Parameters	Setting
Start ~ Stop Frequency	9 kHz~150 kHz for RBW 200 Hz
Start ~ Stop Frequency	0.15 MHz~30 MHz for RBW 9 kHz
Start ~ Stop Frequency	30 MHz~1000 MHz for RBW 100 kHz

Spectrum Parameters	Setting
Start Frequency	1000 MHz
Stop Frequency	10th carrier harmonic or 40 GHz, whichever is lower
RBW / VBW (Emission in restricted band)	1 MHz / 3 MHz for PK value 1 MHz / 1/T Hz for AVG value

Receiver Parameters	Setting
Start ~ Stop Frequency	9 kHz~90 kHz for PK/AVG detector
Start ~ Stop Frequency	90 kHz~110 kHz for QP detector
Start ~ Stop Frequency	110 kHz~490 kHz for PK/AVG detector
Start ~ Stop Frequency	490 kHz~30 MHz for QP detector
Start ~ Stop Frequency	30 MHz~1000 MHz for QP detector
Start ~ Stop Frequency	1 GHz~40 GHz for PK/AVG detector

4.3 DEVIATION FROM TEST STANDARD

No deviation.

4.4 TEST SETUP

9 kHz to 30 MHz

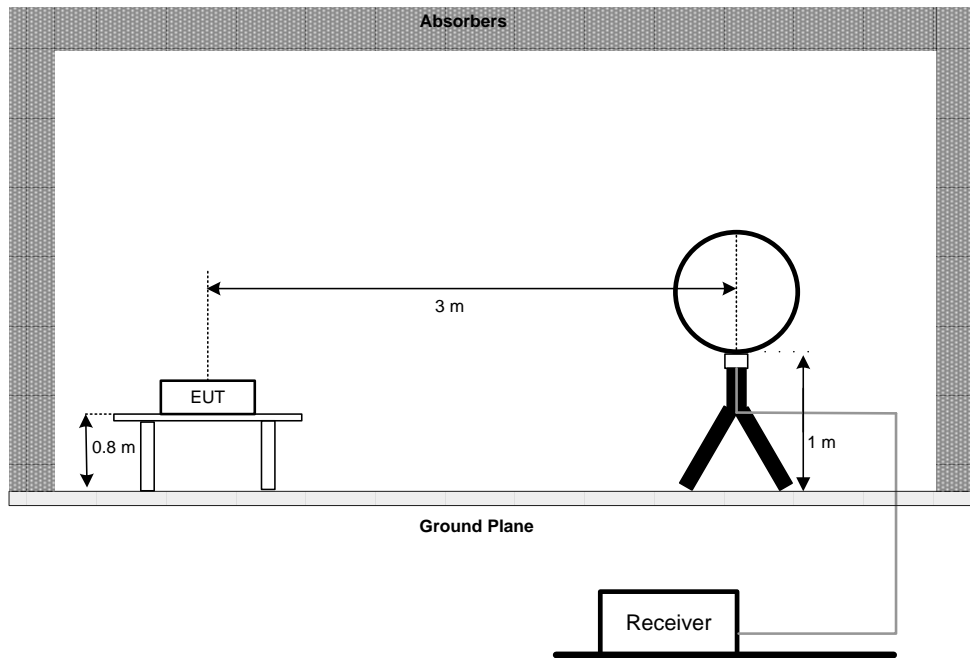

30 MHz to 1 GHz

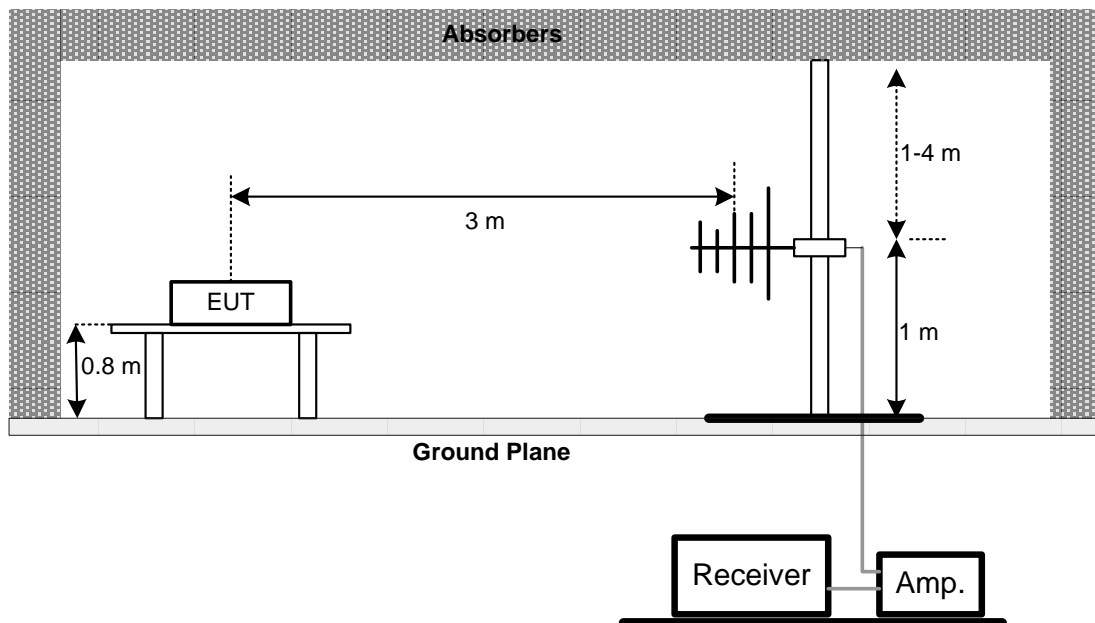

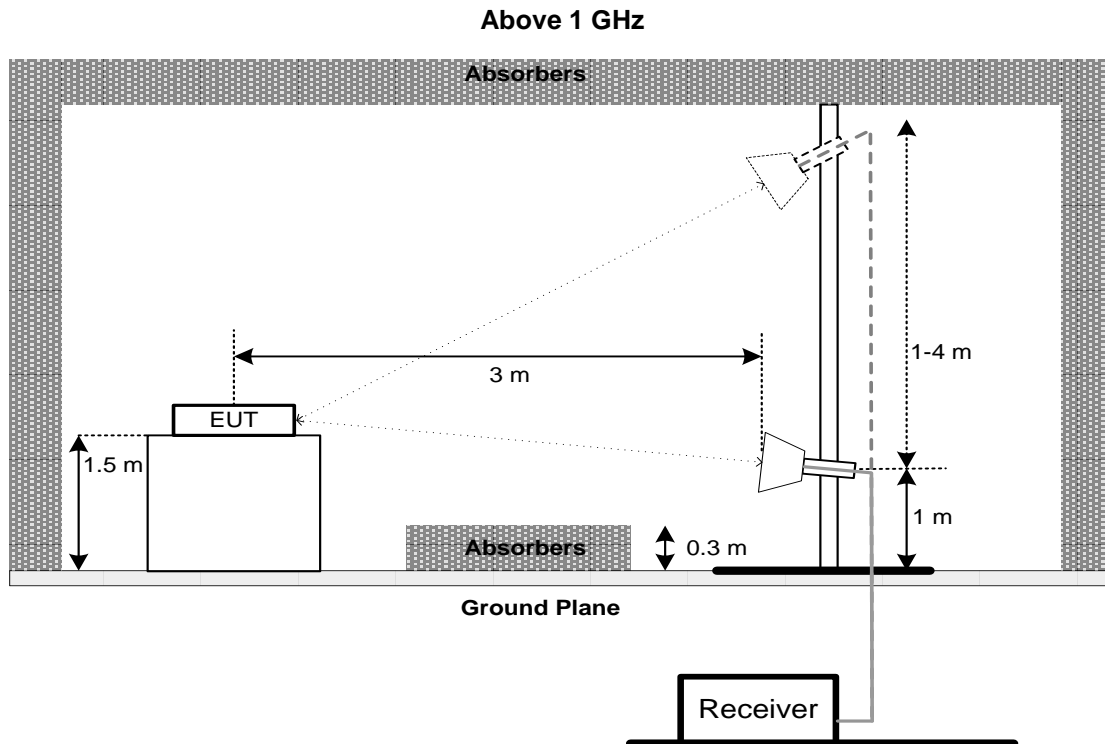

4.5 EUT OPERATION CONDITIONS

The EUT tested system was configured as the statements of 3.5 unless otherwise a special operating condition is specified in the follows during the testing.

4.6 TEST RESULTS - 9 KHZ TO 30 MHZ

Please refer to the APPENDIX B.

Remark:

- (1) Distance extrapolation factor = $40 \log (\text{specific distance} / \text{test distance})$ (dB).
- (2) Limit line = specific limits (dBuV) + distance extrapolation factor.

4.7 TEST RESULTS - 30 MHZ TO 1000 MHZ

Please refer to the APPENDIX C.

4.8 TEST RESULTS - ABOVE 1000 MHZ

Please refer to the APPENDIX D.

Remark:

- (1) No limit: This is fundamental signal, the judgment is not applicable.
For fundamental signal judgment was referred to Peak output test.

5. BANDWIDTH

5.1 LIMIT

Section	Test Item	Limit	Frequency Range (MHz)
FCC 15.407(a) FCC 15.407(e)	26 dB Bandwidth	-	5150-5250
	26 dB Bandwidth	-	5250-5350
	26 dB Bandwidth	-	5470-5725
	6 dB Bandwidth	Minimum 500 kHz	5725-5850

5.2 TEST PROCEDURE

- a. The EUT was directly connected to the spectrum analyzer and antenna output port as show in the block diagram below
- b. Spectrum Setting:
For UNII-1, UNII-2A, UNII-2C:

Spectrum Parameter	Setting
Span Frequency	> 26 dB Bandwidth
RBW	Appromiximately 1% of the emission bandwidth
VBW	> RBW
Detector	Peak
Trace	Max Hold
Sweep Time	Auto

For UNII-3:

Spectrum Parameter	Setting
Span Frequency	> 6 dB Bandwidth
RBW	100 kHz
VBW	300 kHz
Detector	Peak
Trace	Max Hold
Sweep Time	Auto

For 99% Occupied Bandwidth:

Spectrum Parameter	Setting
Span Frequency	1.5 times to 5 times the OBW
RBW	1% to 5% of the OBW
VBW	$\geq 3 \cdot \text{RBW}$
Detector	Peak
Trace	Max Hold
Sweep Time	Auto

- c. Measured the spectrum width with power higher than 26 dB / 6 dB below carrier.

5.3 DEVIATION FROM STANDARD

No deviation.

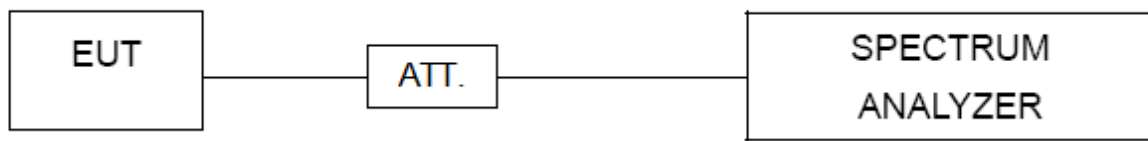
5.4 TEST SETUP**5.5 EUT OPERATION CONDITIONS**

The EUT was programmed to be in continuously transmitting mode.

5.6 TEST RESULTS

Please refer to the APPENDIX E.

6. MAXIMUM OUTPUT POWER

6.1 LIMIT

Section	Test Item	Limit	Frequency Range (MHz)
FCC 15.407(a)	Maximum Output Power	AP device: 1 Watt (30 dBm) Client device: 250 mW (23.98 dBm)	5150-5250
		250 mW (23.98 dBm)	5250-5350
		250 mW (23.98 dBm)	5470-5725
		1 Watt (30dBm)	5725-5850

Note:

- a. For an indoor access point operating in the band 5.15-5.25 GHz, the maximum conducted output power over the frequency band of operation shall not exceed 1 W provided the maximum antenna gain does not exceed 6 dBi. In addition, the maximum power spectral density shall not exceed 17 dBm in any 1 megahertz band. If transmitting antennas of directional gain greater than 6 dBi are used, both the maximum conducted output power and the maximum power spectral density shall be reduced by the amount in dB that the directional gain of the antenna exceeds 6 dBi.
- b. For the 5.25-5.35 GHz and 5.47-5.725 GHz bands, the maximum conducted output power over the frequency bands of operation shall not exceed the lesser of 250 mW or $11 \text{ dBm} + 10 \log B$, where B is the 26dB Bandwidth in megahertz.

6.2 TEST PROCEDURE

- a. The EUT was directly connected to the power meter and antenna output port as show in the block diagram below.
- b. Test test was performed in accordance with method of FCC KDB 789033 D02 General UNII Test Procedures New Rules v02r01.

6.3 DEVIATION FROM STANDARD

No deviation.

6.4 TEST SETUP

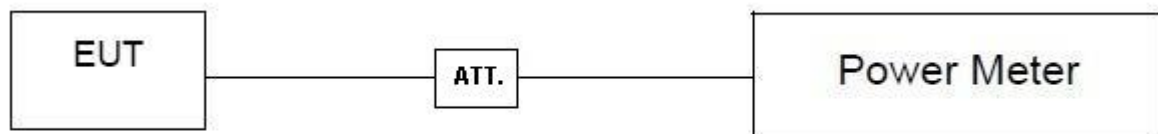

6.5 EUT OPERATION CONDITIONS

The EUT was programmed to be in continuously transmitting mode.

6.6 TEST RESULTS

Please refer to the APPENDIX F.

7. POWER SPECTRAL DENSITY

7.1 LIMIT

Section	Test Item	Limit	Frequency Range (MHz)
FCC 15.407(a)	Power Spectral Density	AP device: 17 dBm/MHz Client device: 11 dBm/MHz	5150-5250
		11 dBm/MHz	5250-5350
		11 dBm/MHz	5470-5725
		30 dBm/500 kHz	5725-5850

7.2 TEST PROCEDURE

- a. The EUT was directly connected to the spectrum analyzer and antenna output port as show in the block diagram below.
- b. Spectrum Setting:

For UNII-1, UNII-2A, UNII-2C:

Spectrum Parameter	Setting
Span Frequency	Encompass the entire emissions bandwidth (EBW) of the signal
RBW	1 MHz.
VBW	3 MHz.
Detector	RMS
Trace average	100 trace
Sweep Time	Auto

For UNII-3:

Spectrum Parameter	Setting
Span Frequency	Encompass the entire emissions bandwidth (EBW) of the signal
RBW	100 kHz.
VBW	300 kHz.
Detector	RMS
Trace average	100 trace
Sweep Time	Auto

Note:

- For UNII-3, according to KDB publication 789033 D02 General UNII Test Procedures New Rules v02r01, section II.F.5., it is acceptable to set RBW at 100kHz and VBW at 300kHz if the spectrum analyzer does not have 500 kHz RBW. Then, add $10 \log (500 \text{ kHz}/100 \text{ kHz})$ to the measured result, i.e. 7 dB.
- During the test of U-NII 3 PSD, the measurement result with RBW=100kHz has been added 7 dB by compensating offset. For example, the cable loss is 13 dB, and the final offset is $13 + 7 = 20$ dB when RBW=100kHz is used.

7.3 DEVIATION FROM STANDARD

No deviation.

7.4 TEST SETUP



7.5 EUT OPERATION CONDITIONS

The EUT was programmed to be in continuously transmitting mode.

7.6 TEST RESULTS

Please refer to the APPENDIX G.

8. FREQUENCY STABILITY

8.1 LIMIT

Section	Test Item	Limit	Frequency Range (MHz)
FCC 15.407(g)	Frequency Stability	An emission is maintained within the band of operation under all conditions of normal operation as specified in the users manual.	5150-5250
			5250-5350
			5470-5725
			5725-5850

8.2 TEST PROCEDURE

- a. The EUT was directly connected to the spectrum analyzer and antenna output port as show in the block diagram below.
- b. Spectrum Setting:

Spectrum Parameter	Setting
Span Frequency	Entire absence of modulation emissions bandwidth
RBW	10 kHz
VBW	10 kHz
Detector	Peak
Trace	Max Hold
Sweep Time	Auto

- c. The test extreme voltage is to change the primary supply voltage from 85 to 115 percent of the nominal value.
- d. User manual temperature is 0°C~45°C.

8.3 DEVIATION FROM STANDARD

No deviation.

8.4 TEST SETUP

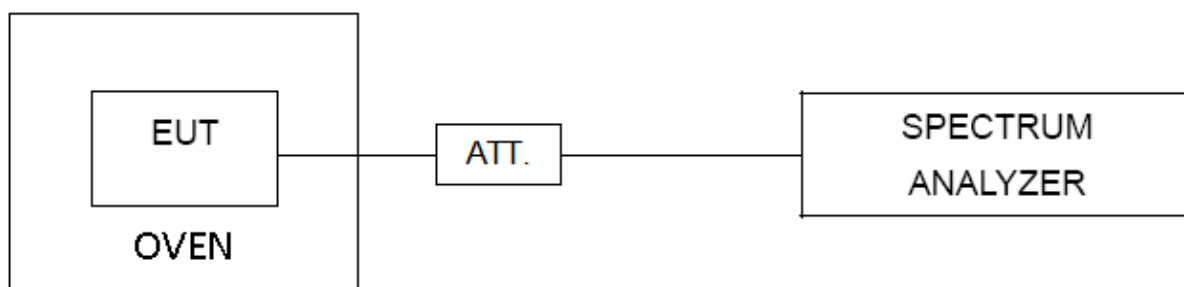

8.5 EUT OPERATION CONDITIONS

The EUT was programmed to be in continuously transmitting mode.

8.6 TEST RESULTS

Please refer to the APPENDIX H.

9. MEASUREMENT INSTRUMENTS LIST

AC Power Line Conducted Emissions					
Item	Kind of Equipment	Manufacturer	Type No.	Serial No.	Calibrated until
1	EMI Test Receiver	R&S	ESCI	100382	Jan. 22, 2022 Jan. 22, 2023
2	LISN	EMCO	3816/2	52765	Jan. 22, 2022 Jan. 22, 2023
3	TWO-LINE V-NETWORK	R&S	ENV216	101447	Jan. 22, 2022 Jan. 22, 2023
4	50Ω Terminator	SHX	TF5-3	15041305	N/A
5	Measurement Software	Farad	EZ-EMC Ver.NB-03A1-01	N/A	N/A
6	Cable	N/A	RG223	12m	Mar. 09, 2022
7	643 Shield Room	ETS	6*4*3	N/A	N/A

Radiated Emissions - 9 kHz to 30 MHz					
Item	Kind of Equipment	Manufacturer	Type No.	Serial No.	Calibrated until
1	MXE EMI Receiver	Keysight	N9038A	MY56400091	Jan. 22, 2022 Jan. 22, 2023
2*	Active Loop Antenna	R&S	HFH2-Z2	830749/020	Aug. 23, 2024
3	Cable	N/A	RG 213/U(9kHz~1GHz)	N/A	May 27, 2022
4	Measurement Software	Farad	EZ-EMC Ver.NB-03A1-01	N/A	N/A
5	966 Chamber Room	ETS	9*6*6	N/A	Jul. 17, 2022

Radiated Emissions - 30 MHz to 1 GHz					
Item	Kind of Equipment	Manufacturer	Type No.	Serial No.	Calibrated until
1	Antenna	Schwarzbeck	VULB9160	9160-3232	Mar. 15, 2022
2	Amplifier	HP	8447D	2944A08742	Jan. 22, 2022 Jan. 22, 2023
3	Cable	emci	LMR-400	N/A	Nov. 30, 2022
4	Controller	CT	SC100	N/A	N/A
5	Controller	MF	MF-7802	MF780208416	N/A
6	Measurement Software	Farad	EZ-EMC Ver.NB-03A1-01	N/A	N/A
7	Receiver	Agilent	N9038A	MY52130039	Jan. 22, 2022 Jan. 22, 2023
8	966 Chamber Room	RM	9*6*6	N/A	Jul. 24, 2022

Radiated Emissions - Above 1 GHz					
Item	Kind of Equipment	Manufacturer	Type No.	Serial No.	Calibrated until
1	Double Ridged Horn Antenna	ARA	DRG-118A	16554	Apr. 21, 2022
2	Broad-Band Horn Antenna	Schwarzbeck	BBHA 9170	9170319	Jun. 30, 2022
3	Amplifier	Agilent	8449B	3008A02584	Jul. 10, 2022
4	Controller	CT	SC100	N/A	N/A
5	Controller	MF	MF-7802	MF780208416	N/A
6	Receiver	Agilent	N9038A	MY52130039	Jan. 22, 2022 Jan. 22, 2023
7	EXA Spectrum Analyzer	Keysight	N9010A	MY56480488	Jan. 22, 2022 Jan. 22, 2023
8	Low Noise Amplifier	CONNPHY	CLN-18G40G-4330-K	619413	Jul. 16, 2022
9	Cable	N/A	A81-SMAMSMAM-12.5M	N/A	Oct. 15, 2022
10	Cable	Talent microwave	A40-2.92M2.92M-2.5M	N/A	Nov. 30, 2022
11*	Band Reject Filter	Micro-Tronics	BRC50703-01	7	Feb. 27, 2024
12*	Band Reject Filter	Micro-Tronics	BRC50704-01	8	Feb. 27, 2024
13*	Band Reject Filter	Micro-Tronics	BRC50705-01	10	Feb. 27, 2024
14	Measurement Software	Farad	EZ-EMC Ver.NB-03A1-01	N/A	N/A
15	966 Chamber Room	RM	9*6*6	N/A	Jul. 24, 2022

Bandwidth & Power Spectral Density					
Item	Kind of Equipment	Manufacturer	Type No.	Serial No.	Calibrated until
1	Spectrum Analyzer	R&S	FSP40	100185	Jul. 10, 2022
2	Attenuator	WOKEN	6SM3502	VAS1214NL	N/A
3	RF Cable	Tongkaichuan	N/A	N/A	N/A
4	DC Block	Mini	N/A	N/A	N/A

Maximum Output Power					
Item	Kind of Equipment	Manufacturer	Type No.	Serial No.	Calibrated until
1	Peak Power Analyzer	Keysight	8990B	MY51000506	Jul. 10, 2022
2	Wideband power sensor	Keysight	N1923A	MY58310004	Jul. 10, 2022
3	Attenuator	WOKEN	6SM3502	VAS1214NL	N/A
4	RF Cable	Tongkaichuan	N/A	N/A	N/A

Frequency Stability					
Item	Kind of Equipment	Manufacturer	Type No.	Serial No.	Calibrated until
1	Spectrum Analyzer	R&S	FSP40	100185	Jul. 10, 2022
2	Precision Oven Tester	CEPREI	CEEC-M64T-40	15-008	Jan. 22, 2022 Jan. 22, 2023
3	Attenuator	WOKEN	6SM3502	VAS1214NL	N/A
4	RF Cable	Tongkaichuan	N/A	N/A	N/A
5	DC Block	Mini	N/A	N/A	N/A

Remark: "N/A" denotes no model name, serial no. or calibration specified.

"*" calibration period of equipment list is three year.

Except * item, all calibration period of equipment list is one year.

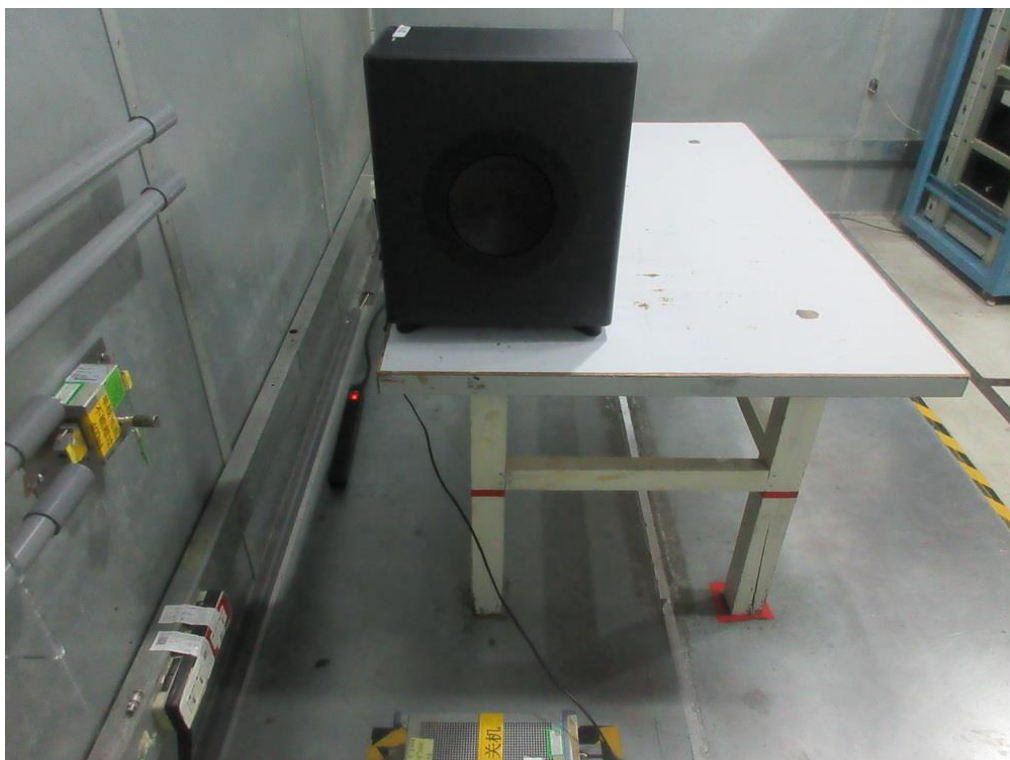
10. EUT TEST PHOTOS**AC Power Line Conducted Emissions Test Photos**

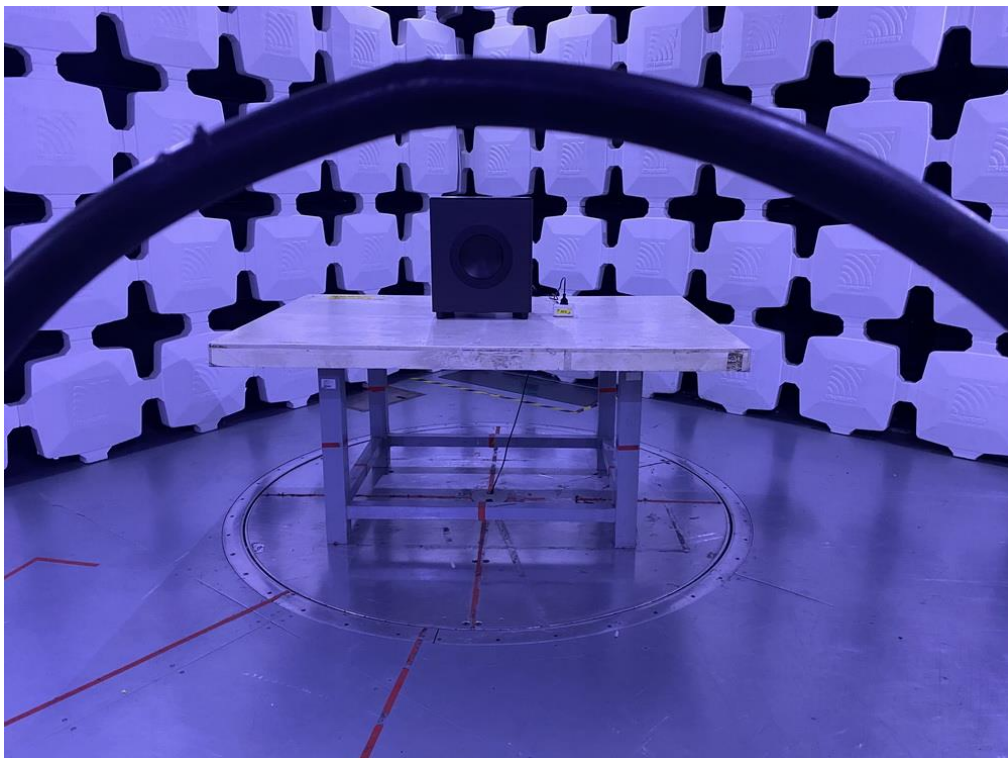
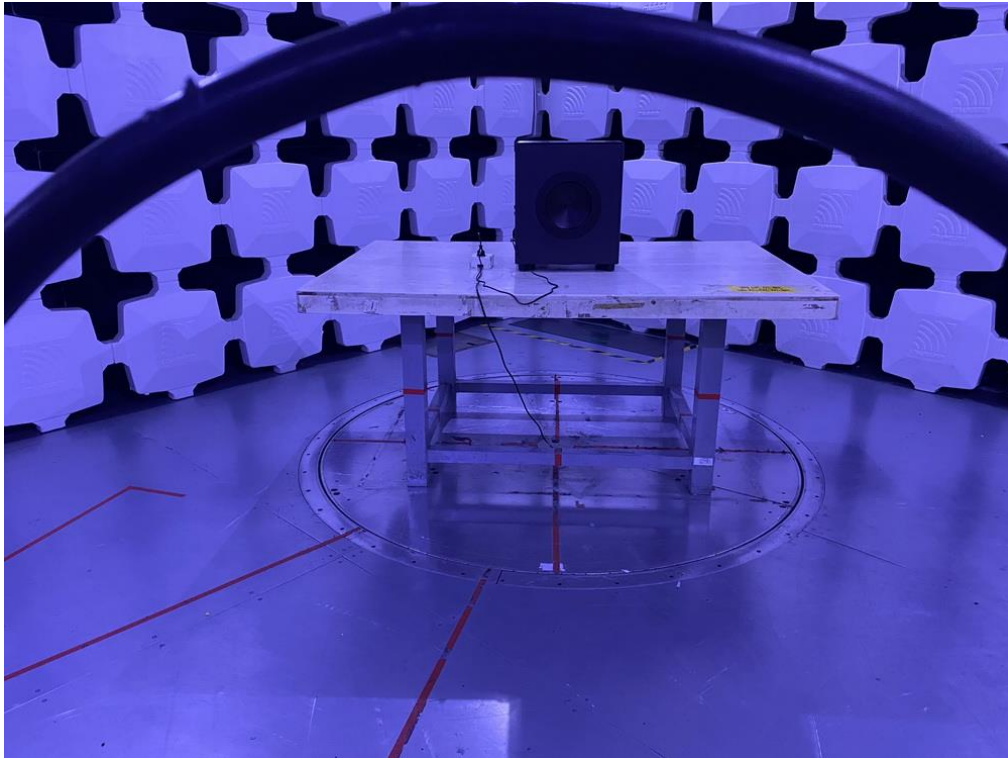
Radiated Emissions Test Photos**9 kHz to 30 MHz**

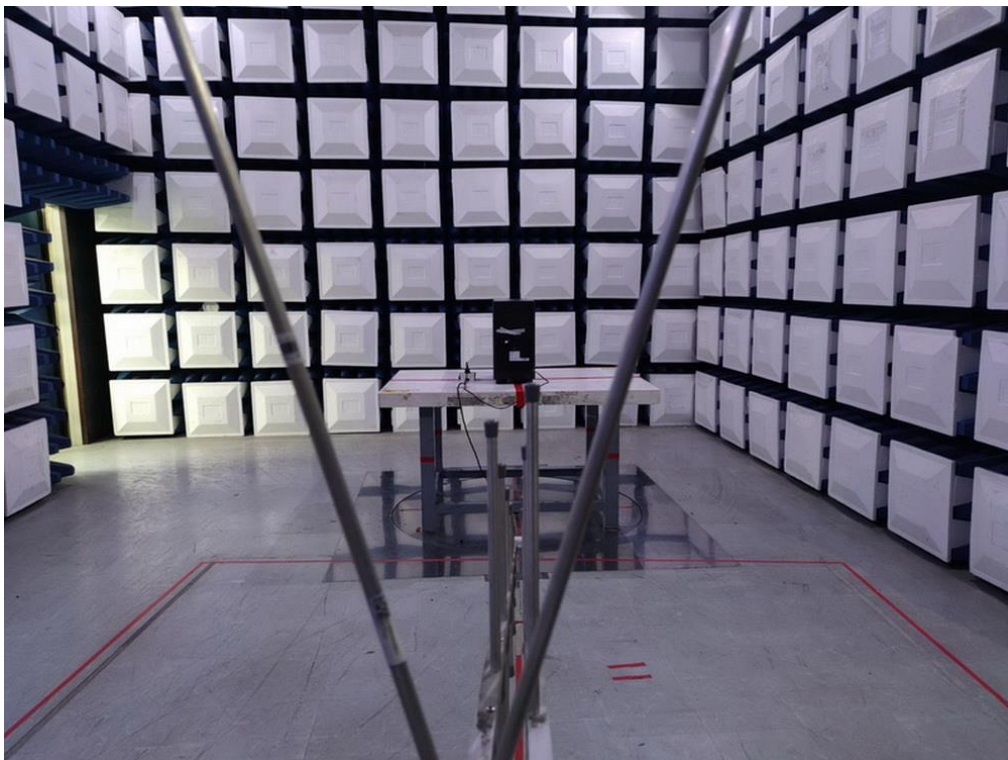
Radiated Emissions Test Photos**30 MHz to 1 GHz**

Radiated Emissions Test Photos**Above 1 GHz**

Conducted Test Photos

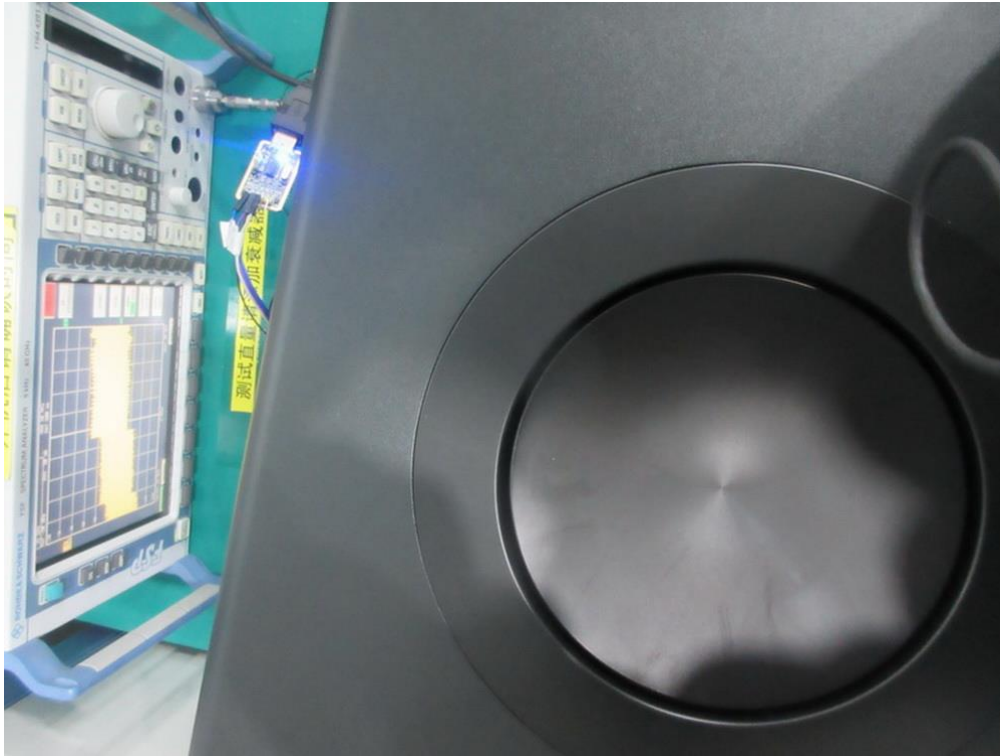

APPENDIX A - AC POWER LINE CONDUCTED EMISSIONS

Test Mode	TX AC(VHT40) Mode Channel 102 (UNII-2C)	Phase	Line
-----------	---	-------	------

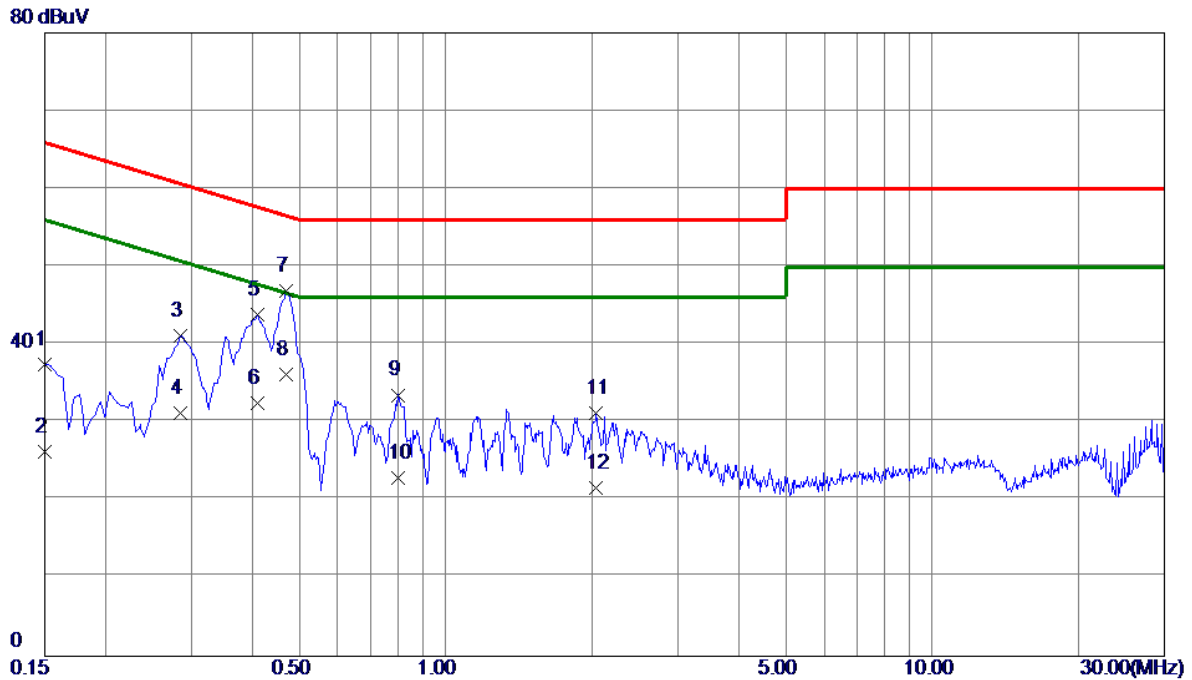

No.	Freq. MHz	Reading Level dBuV	Correct Factor dB	Measure ment dBuV	Limit dBuV	Margin dB	Detector	Comment
1	0.1500	27.64	9.78	37.42	66.00	-28.58	QP	
2	0.1500	16.40	9.78	26.18	56.00	-29.82	AVG	
3	0.2850	31.33	9.83	41.16	60.67	-19.51	QP	
4	0.2850	21.40	9.83	31.23	50.67	-19.44	AVG	
5	0.4110	33.91	9.86	43.77	57.63	-13.86	QP	
6	0.4110	22.60	9.86	32.46	47.63	-15.17	AVG	
7 *	0.4695	37.09	9.86	46.95	56.52	-9.57	QP	
8	0.4695	26.30	9.86	36.16	46.52	-10.36	AVG	
9	0.7980	23.56	9.96	33.52	56.00	-22.48	QP	
10	0.7980	13.00	9.96	22.96	46.00	-23.04	AVG	
11	2.0355	21.08	10.13	31.21	56.00	-24.79	QP	
12	2.0355	11.50	10.13	21.63	46.00	-24.37	AVG	

REMARKS:

- (1) Measurement Value = Reading Level + Correct Factor.
- (2) Margin Level = Measurement Value - Limit Value.
- (3) The test result has included the cable loss.

Test Mode	TX AC(VHT40) Mode Channel 102 (UNII-2C)	Phase	Neutral
-----------	---	-------	---------

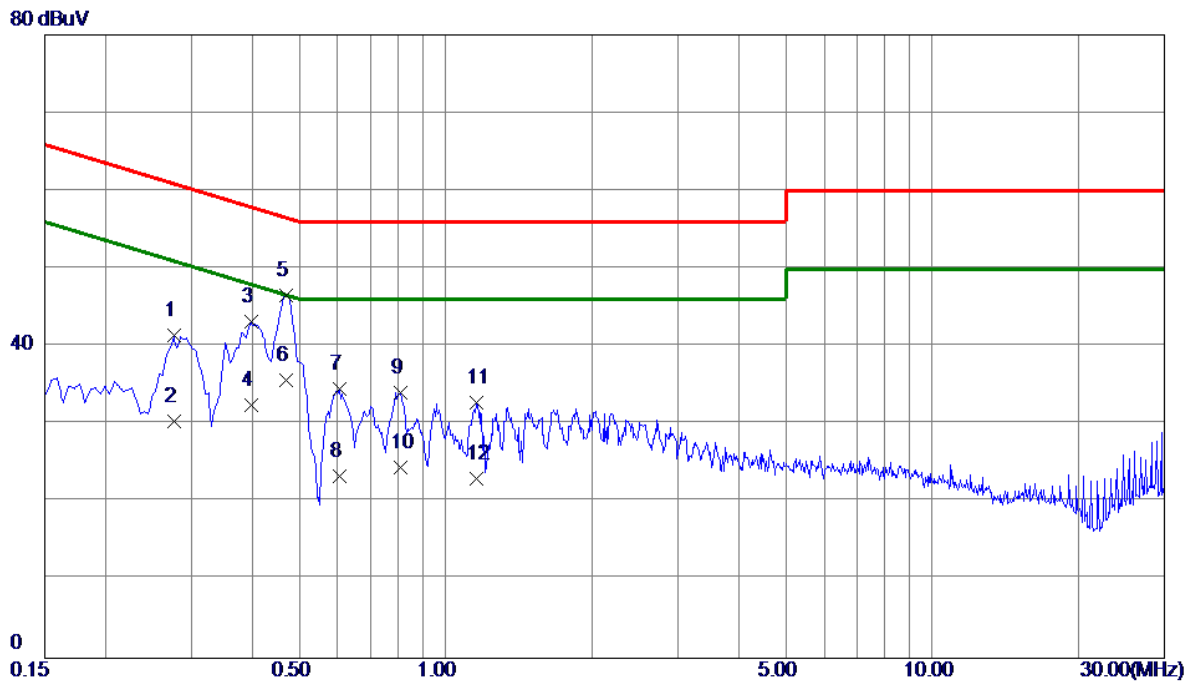

No.	Freq. MHz	Reading Level dBuV	Correct Factor dB	Measure ment dBuV	Limit dBuV	Margin dB	Detector	Comment
1	0.2760	31.51	9.87	41.38	60.94	-19.56	QP	
2	0.2760	20.50	9.87	30.37	50.94	-20.57	AVG	
3	0.3975	33.27	9.92	43.19	57.91	-14.72	QP	
4	0.3975	22.60	9.92	32.52	47.91	-15.39	AVG	
5 *	0.4695	36.60	9.93	46.53	56.52	-9.99	QP	
6	0.4695	25.71	9.93	35.64	46.52	-10.88	AVG	
7	0.6045	24.55	9.98	34.53	56.00	-21.47	QP	
8	0.6045	13.40	9.98	23.38	46.00	-22.62	AVG	
9	0.8070	24.05	10.04	34.09	56.00	-21.91	QP	
10	0.8070	14.50	10.04	24.54	46.00	-21.46	AVG	
11	1.1580	22.68	10.15	32.83	56.00	-23.17	QP	
12	1.1580	12.90	10.15	23.05	46.00	-22.95	AVG	

REMARKS:

- (1) Measurement Value = Reading Level + Correct Factor.
- (2) Margin Level = Measurement Value - Limit Value.
- (3) The test result has included the cable loss.

APPENDIX B - RADIATED EMISSION - 9 KHZ TO 30 MHZ

Test Mode	TX AC(VHT40) Mode Channel 102 (UNII-2C)	Polarization	Ant 0°
-----------	---	--------------	--------

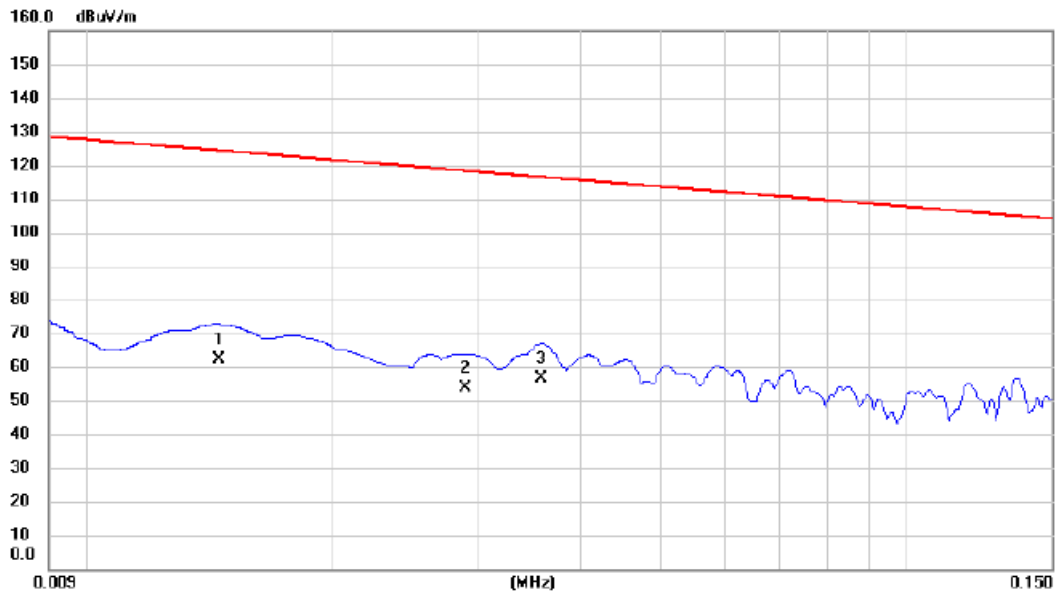

No. Mk.	Freq. MHz	Reading Level dBuV	Correct Factor dB	Measurement dBuV/m	Limit dBuV/m	Margin dB	Detector	Antenna Height cm	Table Degree	Comment
1	0.0145	46.32	16.02	62.34	124.38	-62.04	AVG			
2	0.0290	39.63	14.08	53.71	118.36	-64.65	AVG			
3 *	0.0358	42.82	13.93	56.75	116.53	-59.78	AVG			

REMARKS:

- (1) Measurement Value = Reading Level + Correct Factor.
- (2) Margin Level = Measurement Value - Limit Value.

Test Mode	TX AC(VHT40) Mode Channel 102 (UNII-2C)	Polarization	Ant 0°
-----------	---	--------------	--------

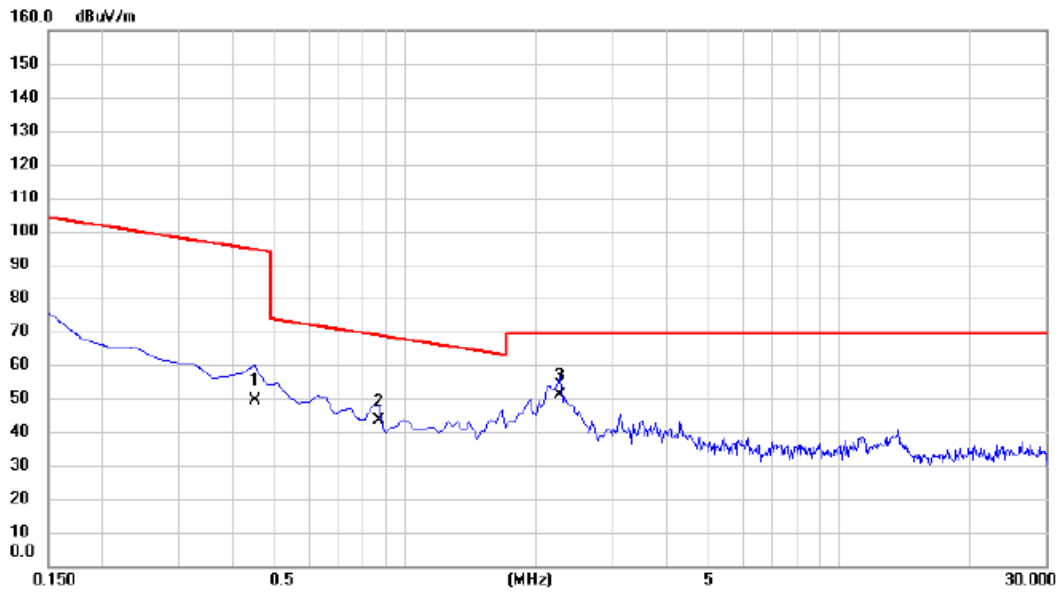

No. Mk.	Freq. MHz	Reading Level dBuV	Correct Factor dB	Measure- ment dBuV/m	Limit dBuV/m	Margin dB	Detector	Antenna Height cm	Table Degree	Comment
1	0.4485	36.18	13.40	49.58	94.57	-44.99	AVG			
2	0.8664	30.62	12.96	43.58	68.85	-25.27	QP			
3 *	2.2694	39.22	11.98	51.20	69.54	-18.34	QP			

REMARKS:

- (1) Measurement Value = Reading Level + Correct Factor.
- (2) Margin Level = Measurement Value - Limit Value.

Test Mode	TX AC(VHT40) Mode Channel 102 (UNII-2C)	Polarization	Ant 90°
-----------	---	--------------	---------

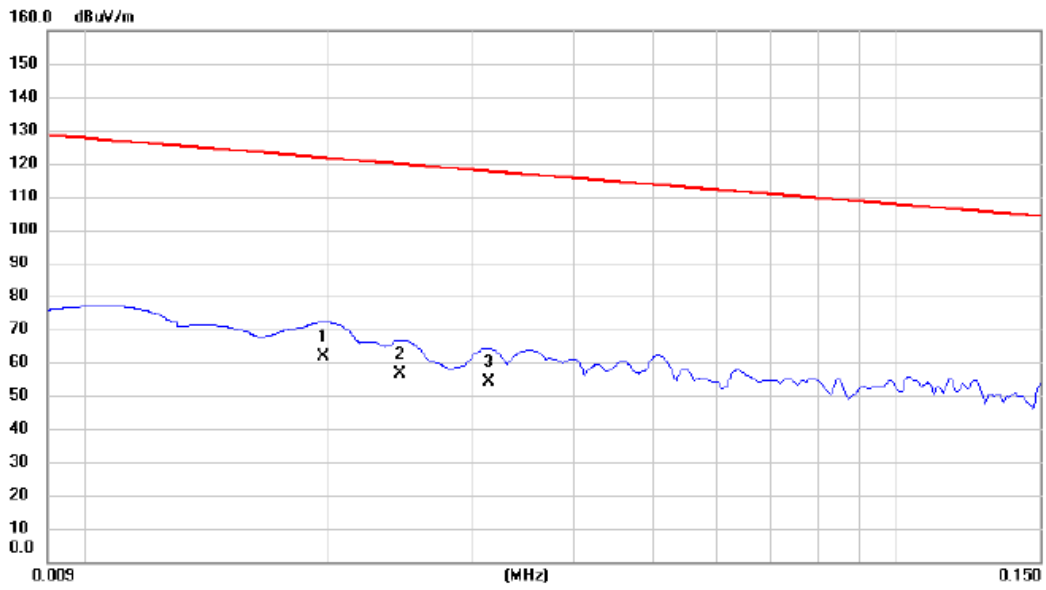

No. Mk.	Freq. MHz	Reading Level dBuV	Correct Factor dB	Measure- ment dBuV/m	Limit dBuV/m	Margin dB	Detector	Antenna Height cm	Table Degree	Comment
1 *	0.0197	47.26	14.38	61.64	121.72	-60.08	AVG			
2	0.0245	42.39	14.19	56.58	119.82	-63.24	AVG			
3	0.0314	40.12	14.03	54.15	117.67	-63.52	AVG			

REMARKS:

- (1) Measurement Value = Reading Level + Correct Factor.
- (2) Margin Level = Measurement Value - Limit Value.

Test Mode	TX AC(VHT40) Mode Channel 102 (UNII-2C)	Polarization	Ant 90°
-----------	---	--------------	---------

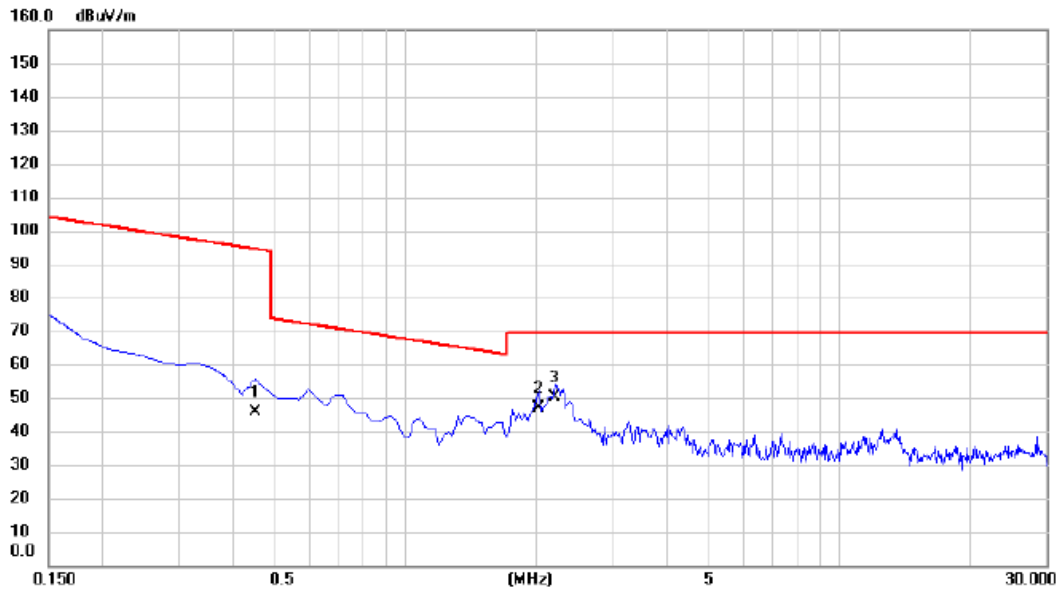

No. Mk.	Freq. MHz	Reading Level dBuV	Correct Factor dB	Measurement dBuV/m	Limit dBuV/m	Margin dB	Detector	Antenna Height cm	Table Degree	Comment
1	0.4485	32.41	13.40	45.81	94.57	-48.76	AVG			
2	2.0305	35.11	12.08	47.19	69.54	-22.35	QP			
3 *	2.2096	38.39	12.01	50.40	69.54	-19.14	QP			

REMARKS:

- (1) Measurement Value = Reading Level + Correct Factor.
- (2) Margin Level = Measurement Value - Limit Value.

APPENDIX C - RADIATED EMISSION - 30 MHZ TO 1000 MHZ

Test Mode	TX AC(VHT40) Mode Channel 102 (UNII-2C)	Polarization	Vertical
-----------	---	--------------	----------

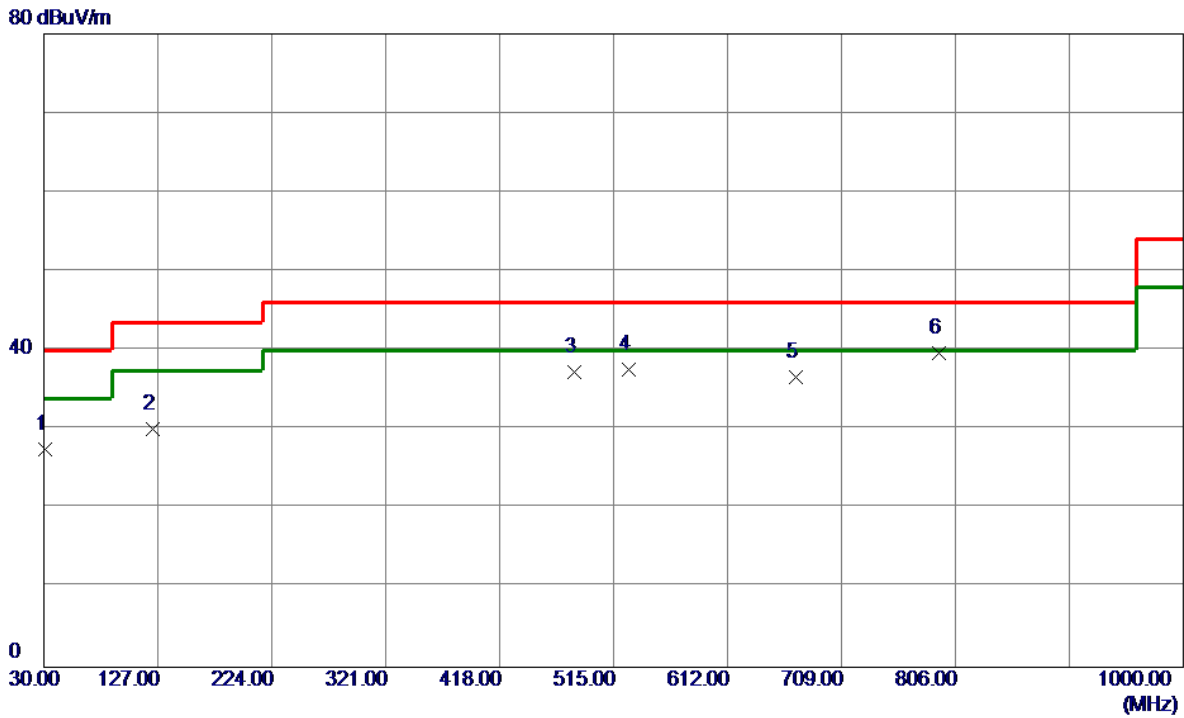

No.	Freq. MHz	Reading Level dBuV/m	Correct Factor dB	Measure ment dBuV/m	Limit dBuV/m	Margin dB	Detector	Comment
1	30.9700	43.00	-15.41	27.59	40.00	-12.41	Peak	
2	123.1200	43.98	-13.92	30.06	43.50	-13.44	Peak	
3	482.0200	44.09	-6.85	37.24	46.00	-8.76	Peak	
4	527.6100	43.73	-6.19	37.54	46.00	-8.46	Peak	
5	670.2000	40.17	-3.47	36.70	46.00	-9.30	Peak	
6 *	792.4200	40.58	-0.87	39.71	46.00	-6.29	Peak	

REMARKS:

- (1) Measurement Value = Reading Level + Correct Factor.
- (2) Margin Level = Measurement Value - Limit Value.

Test Mode	TX AC(VHT40) Mode Channel 102 (UNII-2C)	Polarization	Horizontal
-----------	---	--------------	------------

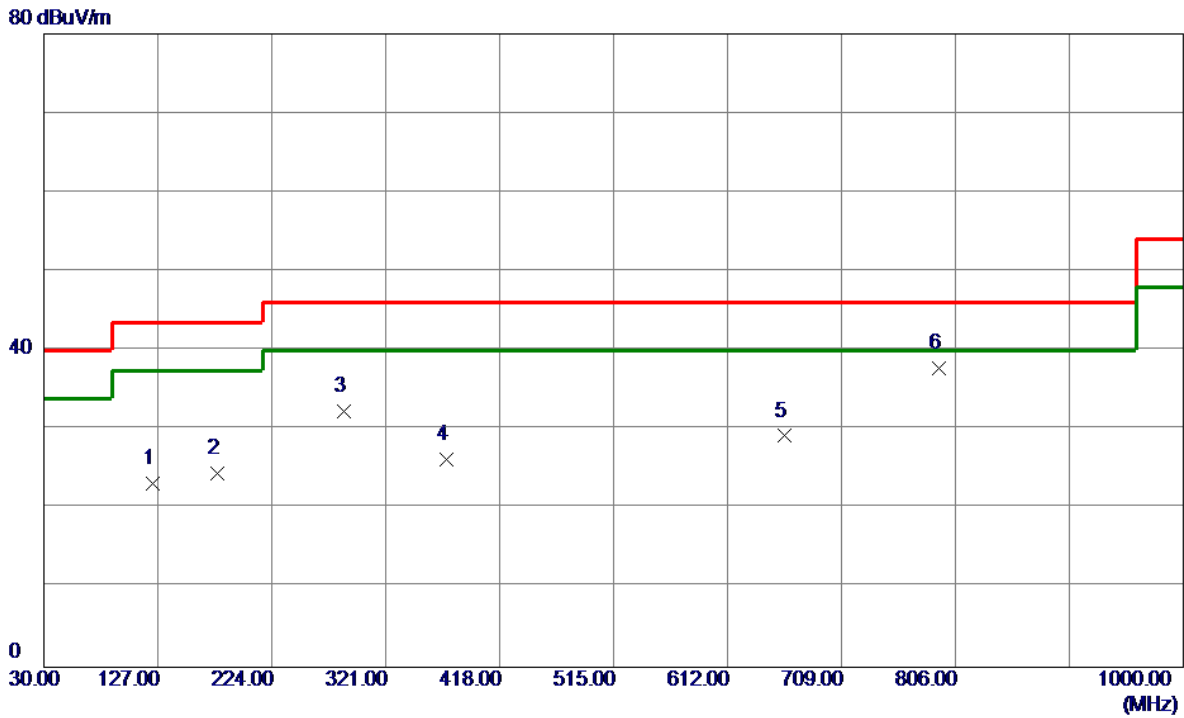

No.	Freq. MHz	Reading Level dBuV/m	Correct Factor dB	Measure ment dBuV/m	Limit dBuV/m	Margin dB	Detector	Comment
1	123.1200	37.13	-13.92	23.21	43.50	-20.29	Peak	
2	177.4400	37.89	-13.37	24.52	43.50	-18.98	Peak	
3	285.1099	43.65	-11.39	32.26	46.00	-13.74	Peak	
4	372.4100	35.74	-9.43	26.31	46.00	-19.69	Peak	
5	660.5000	32.80	-3.60	29.20	46.00	-16.80	Peak	
6 *	792.4200	38.64	-0.87	37.77	46.00	-8.23	Peak	

REMARKS:

- (1) Measurement Value = Reading Level + Correct Factor.
- (2) Margin Level = Measurement Value - Limit Value.

APPENDIX D - RADIATED EMISSION - ABOVE 1000 MHZ

Test Mode	UNII-1_TX A Mode 5180 MHz	Polarization	Vertical
-----------	---------------------------	--------------	----------

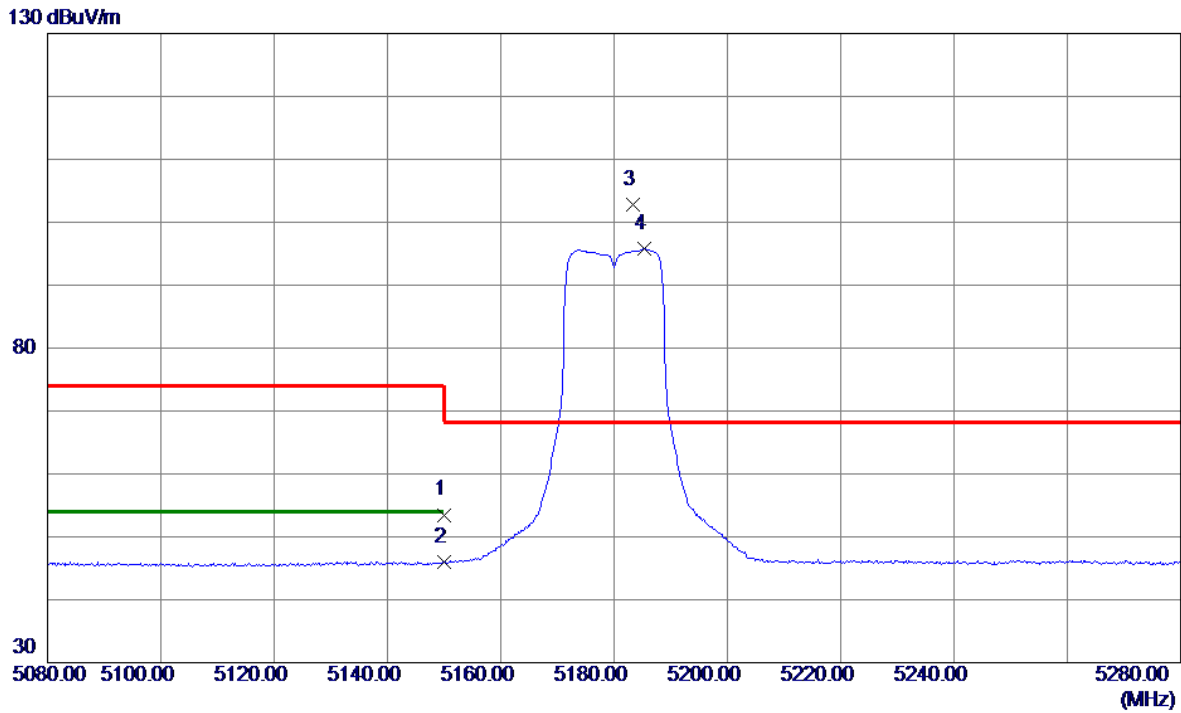

No.	Freq. MHz	Reading Level dBuV/m	Correct Factor dB	Measure ment dBuV/m	Limit dBuV/m	Margin dB	Detector	Comment
1	5150.0000	37.22	16.28	53.50	74.00	-20.50	Peak	
2	5150.0000	29.65	16.28	45.93	54.00	-8.07	AVG	
3 *	5183.4000	86.45	16.32	102.77	68.20	34.57	Peak	No Limit
4	5185.4000	79.52	16.32	95.84	999.00	-903.16	AVG	No Limit

REMARKS:

- (1) Measurement Value = Reading Level + Correct Factor.
- (2) Margin Level = Measurement Value - Limit Value.

Test Mode	UNII-1_TX A Mode 5180 MHz	Polarization	Vertical
-----------	---------------------------	--------------	----------

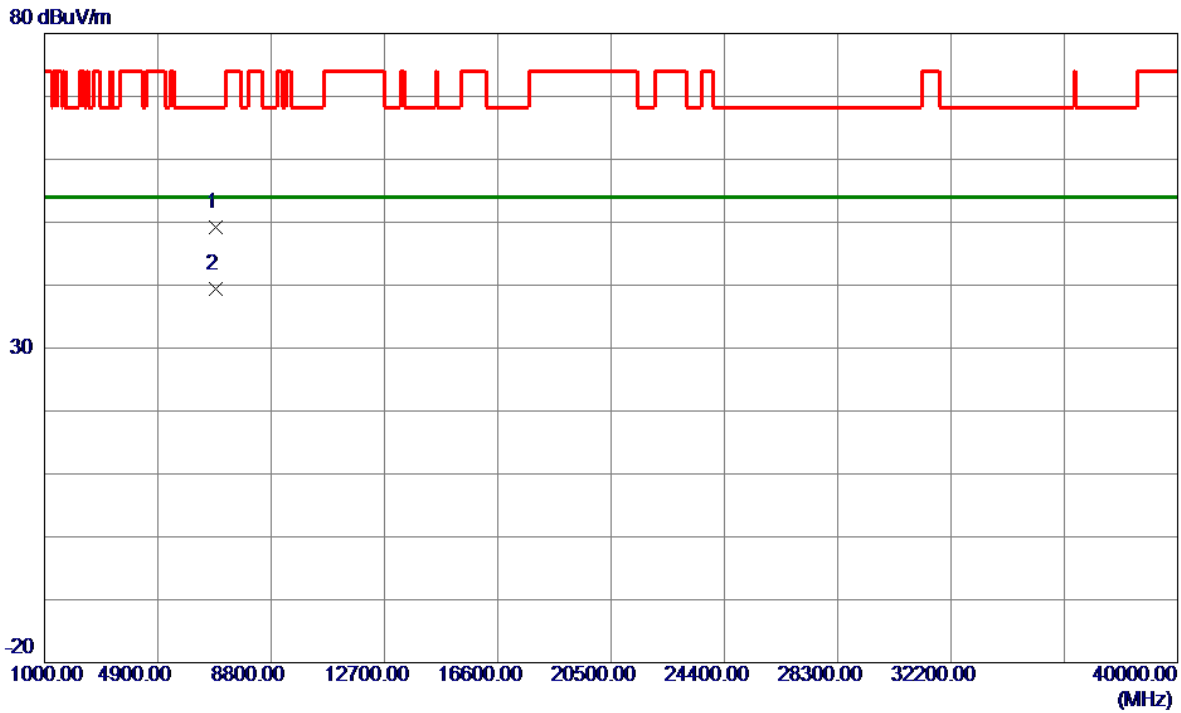

No.	Freq. MHz	Reading Level dBuV/m	Correct Factor dB	Measure ment dBuV/m	Limit dBuV/m	Margin dB	Detector	Comment
1	6906.1650	39.29	9.84	49.13	68.20	-19.07	Peak	
2 *	6906.6050	29.50	9.84	39.34	54.00	-14.66	AVG	

REMARKS:

- (1) Measurement Value = Reading Level + Correct Factor.
- (2) Margin Level = Measurement Value - Limit Value.

Test Mode	UNII-1_TX A Mode 5180 MHz	Polarization	Horizontal
-----------	---------------------------	--------------	------------

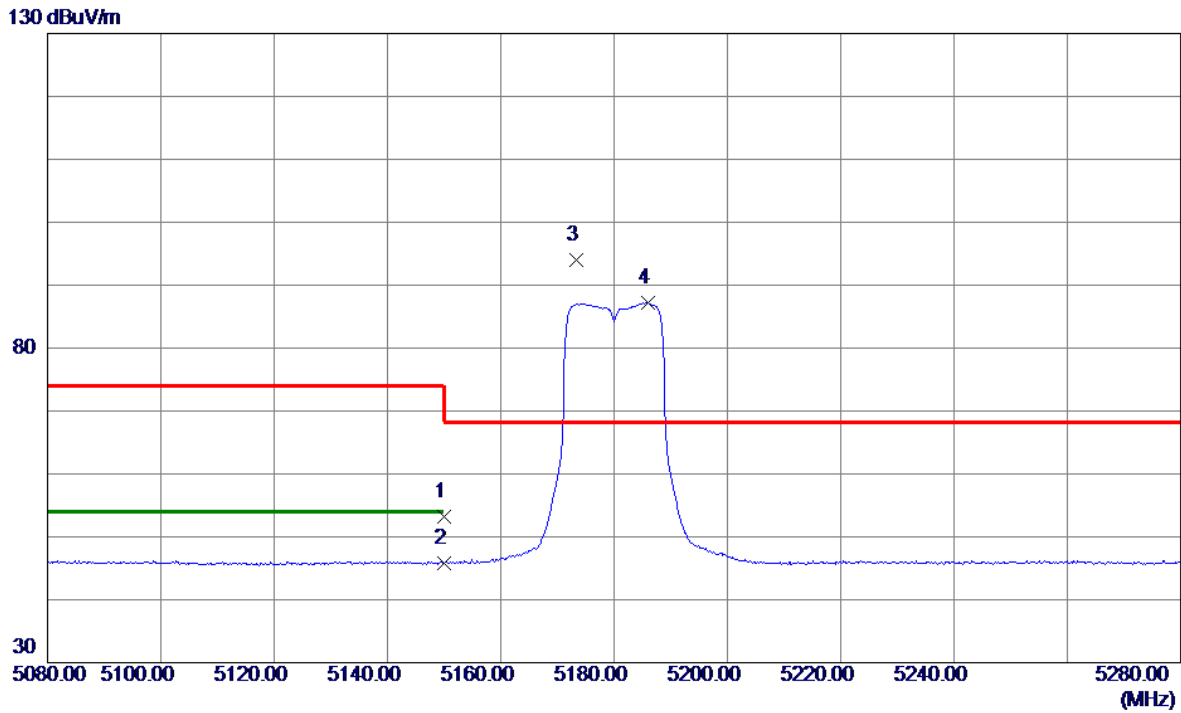

No.	Freq. MHz	Reading Level dBuV/m	Correct Factor dB	Measure ment dBuV/m	Limit dBuV/m	Margin dB	Detector	Comment
1	5150.0000	36.94	16.28	53.22	74.00	-20.78	Peak	
2	5150.0000	29.57	16.28	45.85	54.00	-8.15	AVG	
3 *	5173.4000	77.78	16.31	94.09	68.20	25.89	Peak	No Limit
4	5186.0000	70.83	16.32	87.15	999.00	-911.85	AVG	No Limit

REMARKS:

- (1) Measurement Value = Reading Level + Correct Factor.
- (2) Margin Level = Measurement Value - Limit Value.

Test Mode	UNII-1_TX A Mode 5180 MHz	Polarization	Horizontal
-----------	---------------------------	--------------	------------

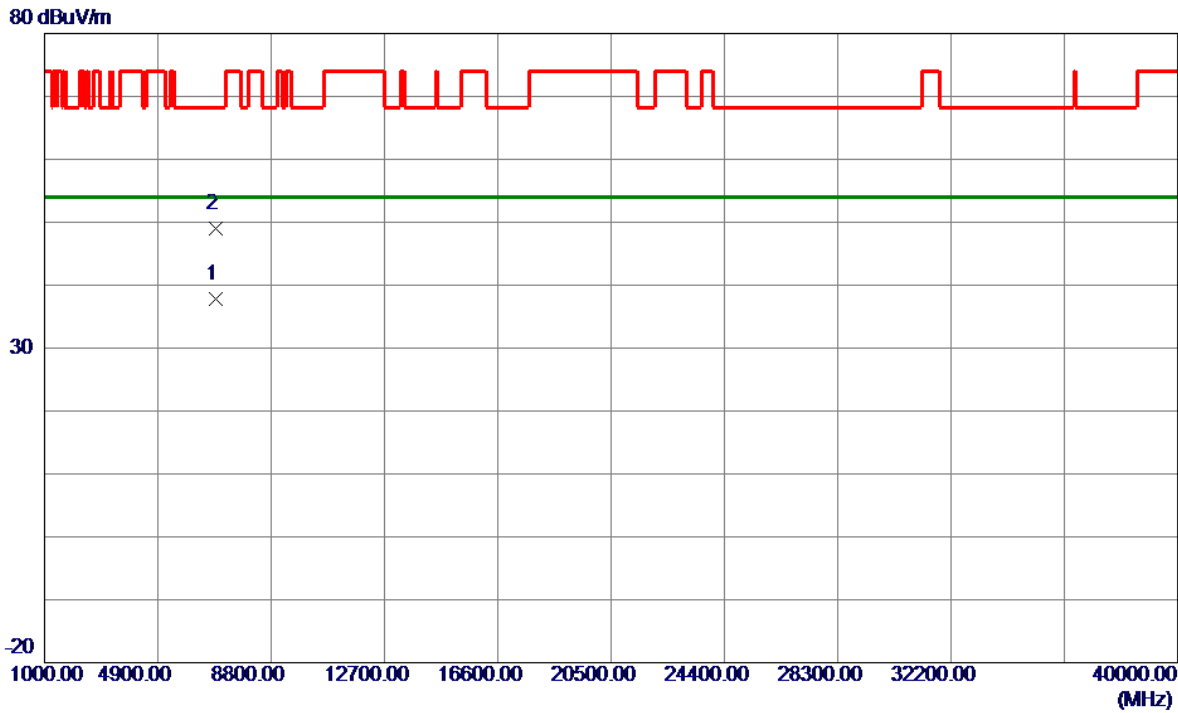

No.	Freq. MHz	Reading Level dBuV/m	Correct Factor dB	Measure ment dBuV/m	Limit dBuV/m	Margin dB	Detector	Comment
1 *	6904.4500	27.96	9.83	37.79	54.00	-16.21	AVG	
2	6905.9550	39.24	9.84	49.08	68.20	-19.12	Peak	

REMARKS:

- (1) Measurement Value = Reading Level + Correct Factor.
- (2) Margin Level = Measurement Value - Limit Value.

Test Mode	UNII-1_TX A Mode 5200 MHz	Polarization	Vertical
-----------	---------------------------	--------------	----------

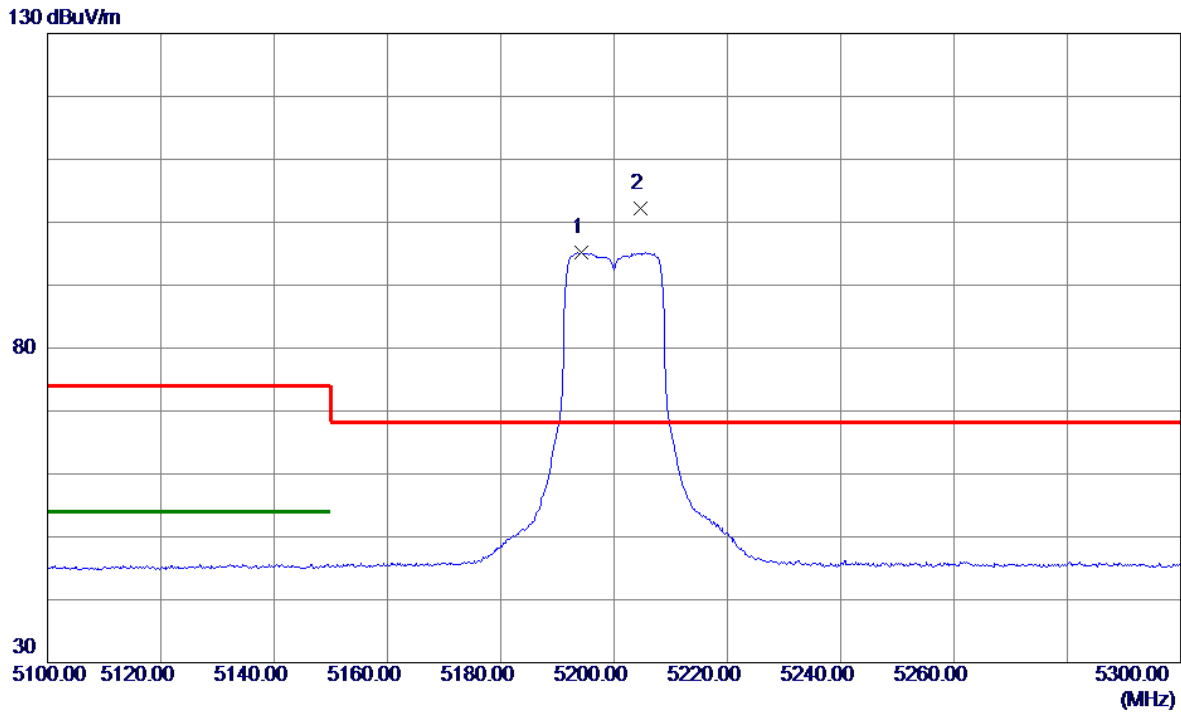

No.	Freq. MHz	Reading Level dBuV/m	Correct Factor dB	Measure ment dBuV/m	Limit dBuV/m	Margin dB	Detector	Comment
1	5194.2000	78.87	16.33	95.20	999.00	-903.80	AVG	No Limit
2 *	5204.6000	85.87	16.34	102.21	68.20	34.01	Peak	No Limit

REMARKS:

- (1) Measurement Value = Reading Level + Correct Factor.
- (2) Margin Level = Measurement Value - Limit Value.

Test Mode	UNII-1_TX A Mode 5200 MHz	Polarization	Vertical
-----------	---------------------------	--------------	----------

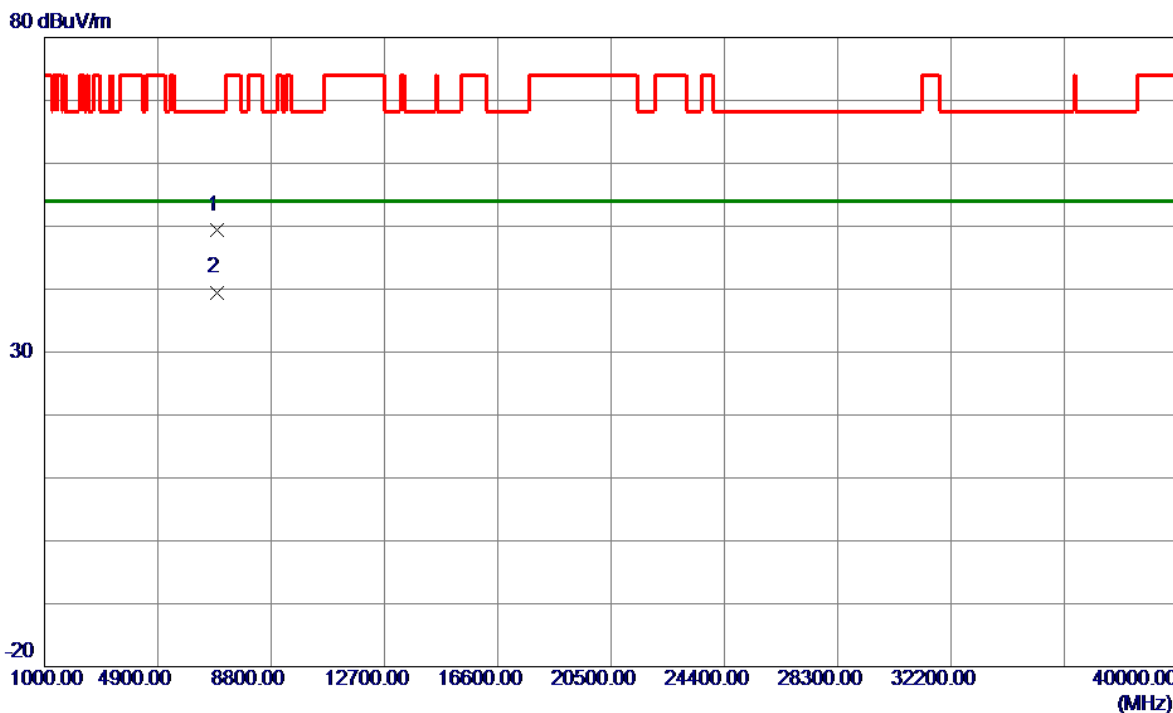

No.	Freq. MHz	Reading Level dBuV/m	Correct Factor dB	Measure ment dBuV/m	Limit dBuV/m	Margin dB	Detector	Comment
1	6932.5750	39.49	9.97	49.46	68.20	-18.74	Peak	
2 *	6933.4150	29.53	9.97	39.50	54.00	-14.50	AVG	

REMARKS:

- (1) Measurement Value = Reading Level + Correct Factor.
- (2) Margin Level = Measurement Value - Limit Value.

Test Mode	UNII-1_TX A Mode 5200 MHz	Polarization	Horizontal
-----------	---------------------------	--------------	------------

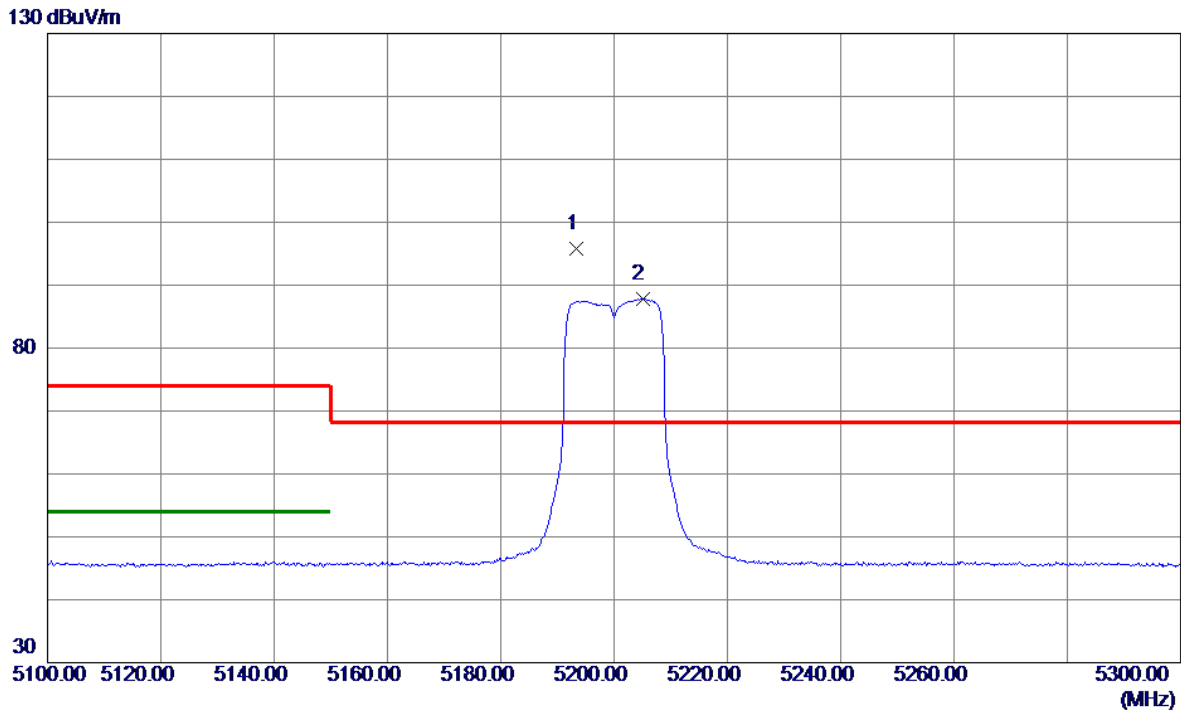

No.	Freq. MHz	Reading Level dBuV/m	Correct Factor dB	Measure ment dBuV/m	Limit dBuV/m	Margin dB	Detector	Comment
1 *	5193.4000	79.56	16.33	95.89	68.20	27.69	Peak	No Limit
2	5205.0000	71.53	16.34	87.87	999.00	-911.13	AVG	No Limit

REMARKS:

- (1) Measurement Value = Reading Level + Correct Factor.
- (2) Margin Level = Measurement Value - Limit Value.

Test Mode	UNII-1_TX A Mode 5200 MHz	Polarization	Horizontal
-----------	---------------------------	--------------	------------

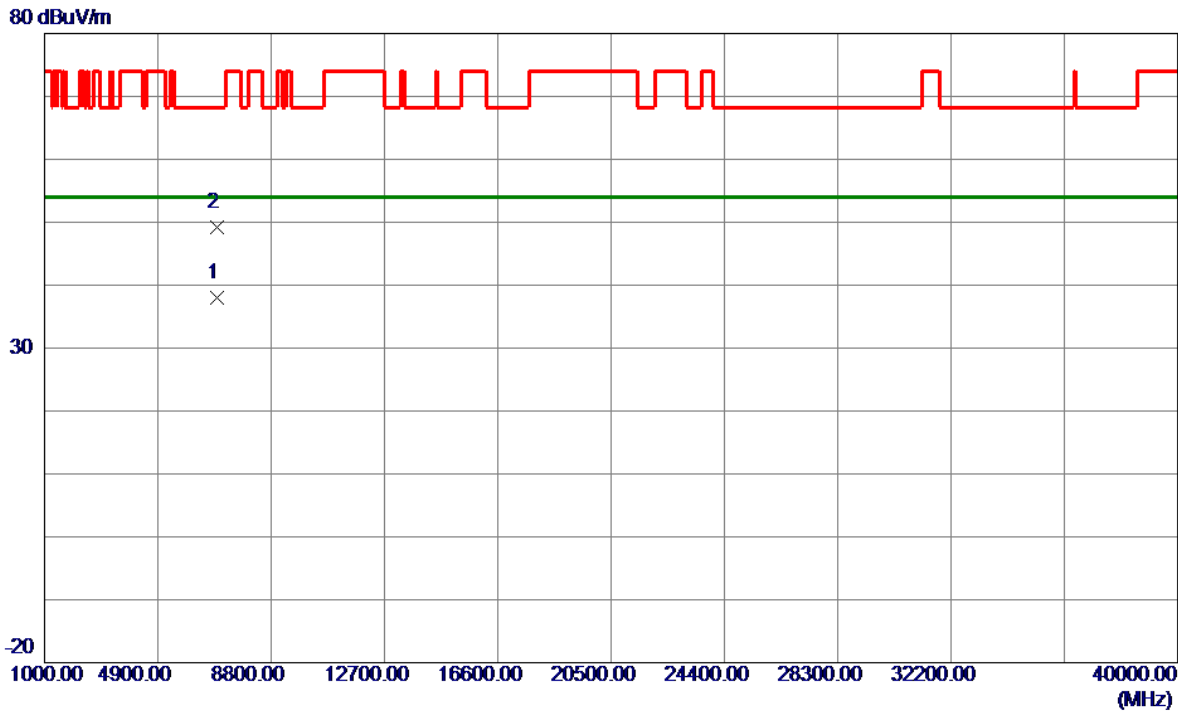

No.	Freq. MHz	Reading Level dBuV/m	Correct Factor dB	Measure ment dBuV/m	Limit dBuV/m	Margin dB	Detector	Comment
1 *	6933.9850	28.07	9.97	38.04	54.00	-15.96	AVG	
2	6934.9300	39.31	9.98	49.29	68.20	-18.91	Peak	

REMARKS:

- (1) Measurement Value = Reading Level + Correct Factor.
- (2) Margin Level = Measurement Value - Limit Value.

Test Mode	UNII-1_TX A Mode 5240 MHz	Polarization	Vertical
-----------	---------------------------	--------------	----------

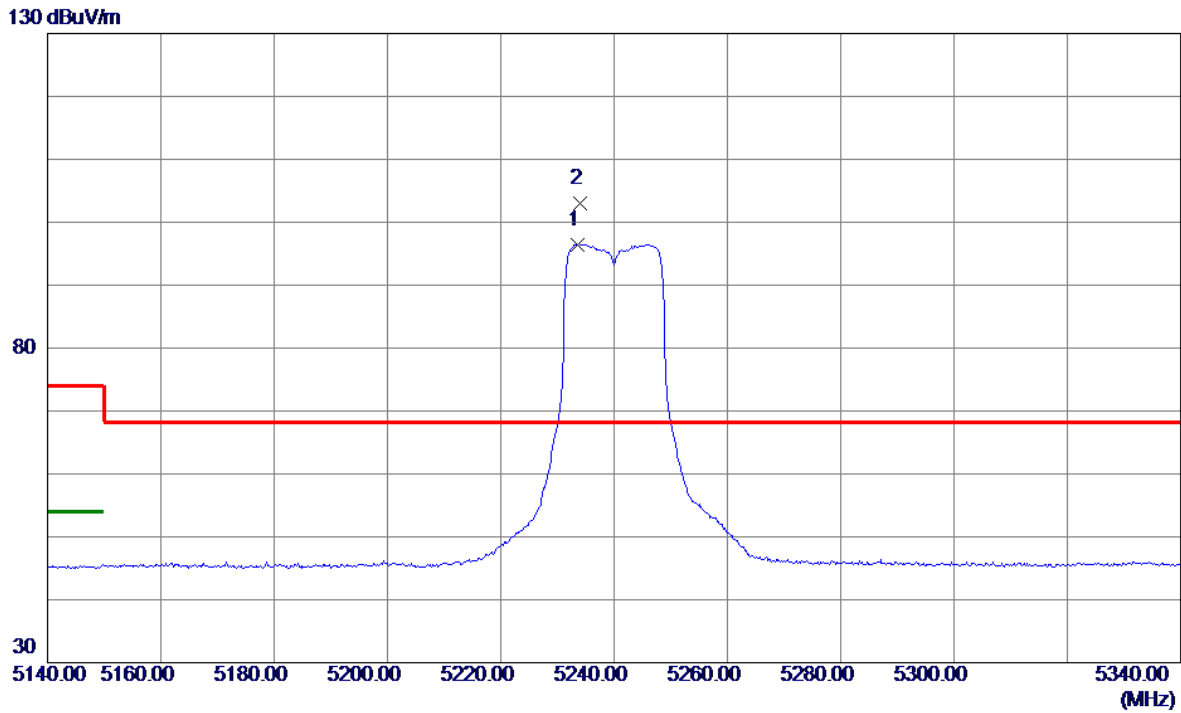

No.	Freq. MHz	Reading Level dBuV/m	Correct Factor dB	Measure ment dBuV/m	Limit dBuV/m	Margin dB	Detector	Comment
1	5233.6000	80.09	16.37	96.46	999.00	-902.54	AVG	No Limit
2 *	5234.0000	86.66	16.38	103.04	68.20	34.84	Peak	No Limit

REMARKS:

- (1) Measurement Value = Reading Level + Correct Factor.
- (2) Margin Level = Measurement Value - Limit Value.

Test Mode	UNII-1_TX A Mode 5240 MHz	Polarization	Vertical
-----------	---------------------------	--------------	----------

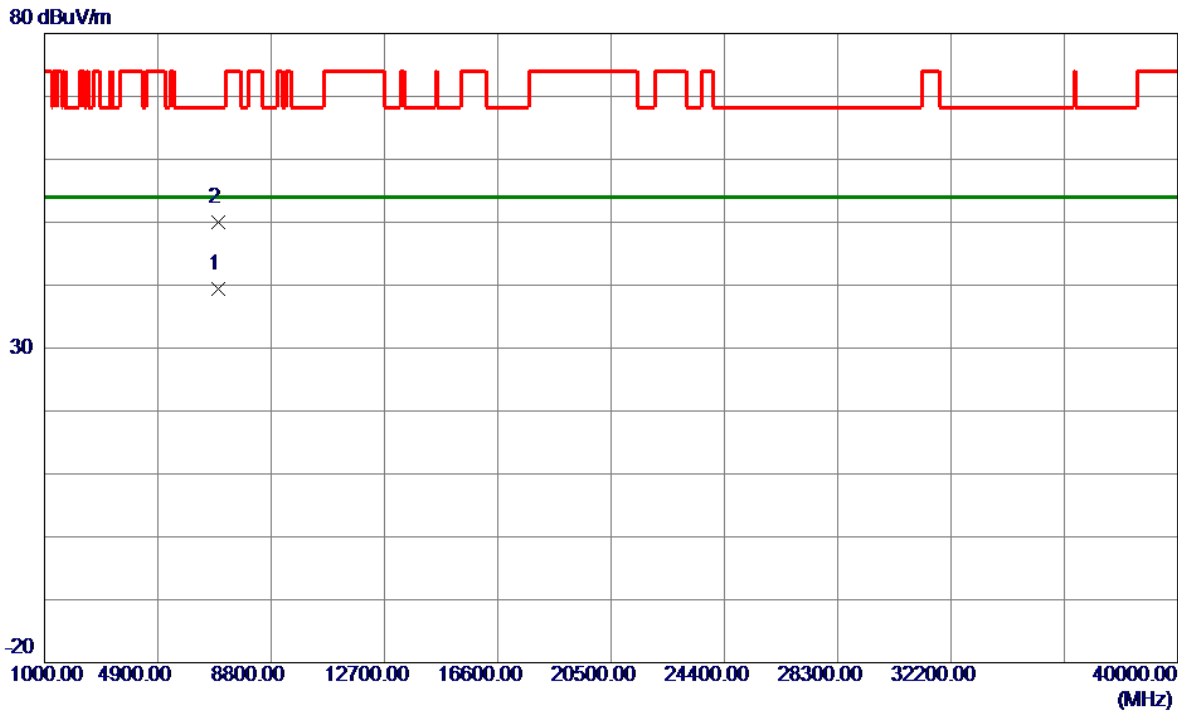

No.	Freq. MHz	Reading Level dBuV/m	Correct Factor dB	Measure ment dBuV/m	Limit dBuV/m	Margin dB	Detector	Comment
1 *	6986.7300	29.08	10.23	39.31	54.00	-14.69	AVG	
2	6986.7550	39.78	10.23	50.01	68.20	-18.19	Peak	

REMARKS:

- (1) Measurement Value = Reading Level + Correct Factor.
- (2) Margin Level = Measurement Value - Limit Value.

Test Mode	UNII-1_TX A Mode 5240 MHz	Polarization	Horizontal
-----------	---------------------------	--------------	------------

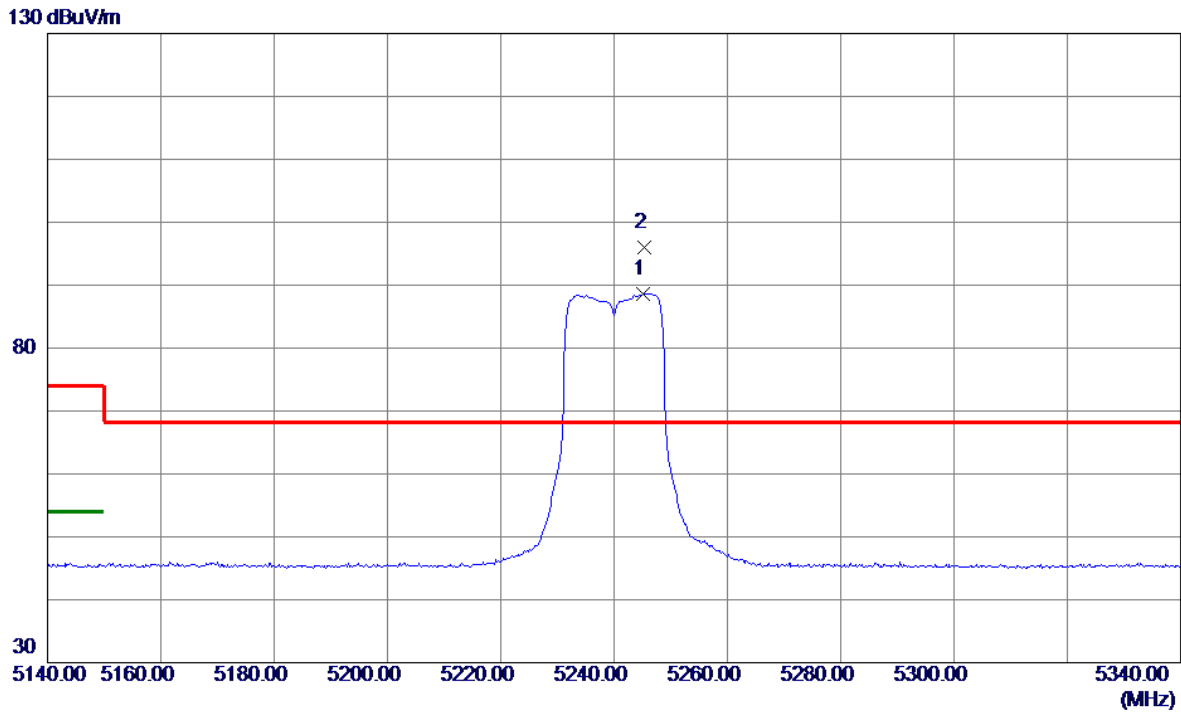

No.	Freq. MHz	Reading Level dBuV/m	Correct Factor dB	Measure ment dBuV/m	Limit dBuV/m	Margin dB	Detector	Comment
1	5245.2000	72.29	16.39	88.68	999.00	-910.32	AVG	No Limit
2 *	5245.4000	79.56	16.39	95.95	68.20	27.75	Peak	No Limit

REMARKS:

- (1) Measurement Value = Reading Level + Correct Factor.
- (2) Margin Level = Measurement Value - Limit Value.

Test Mode	UNII-1_TX A Mode 5240 MHz	Polarization	Horizontal
-----------	---------------------------	--------------	------------

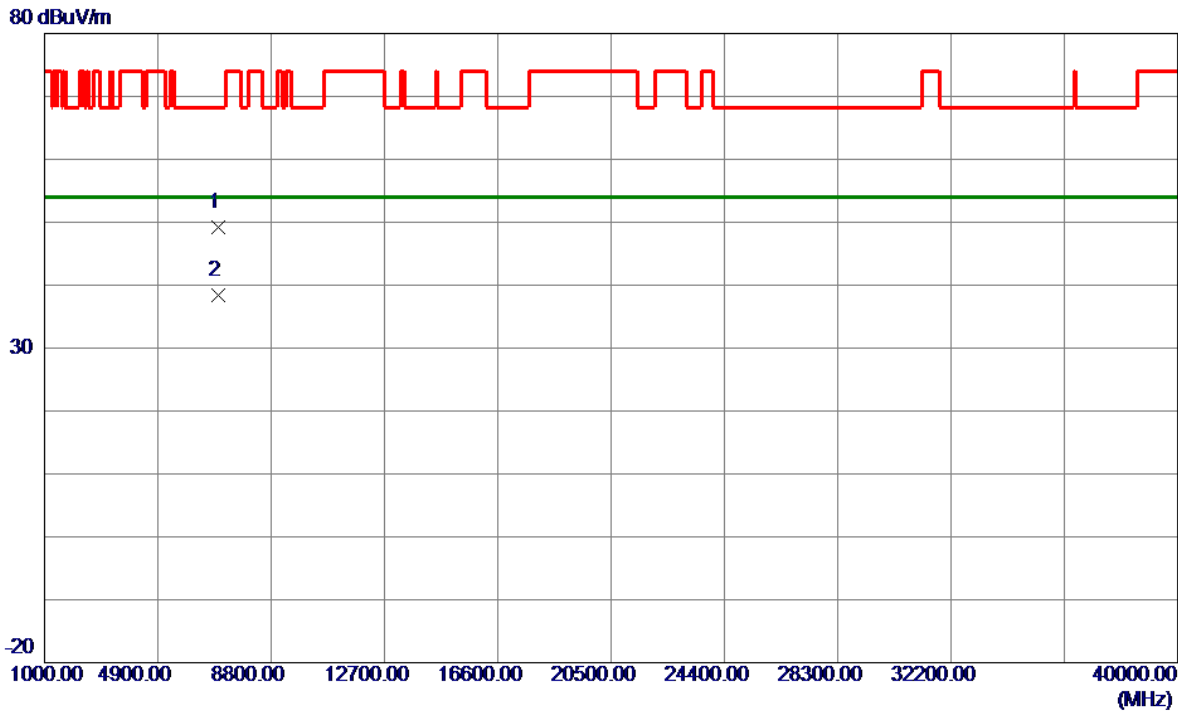

No.	Freq. MHz	Reading Level dBuV/m	Correct Factor dB	Measure ment dBuV/m	Limit dBuV/m	Margin dB	Detector	Comment
1	6984.1800	38.96	10.21	49.17	68.20	-19.03	Peak	
2 *	6984.7700	28.15	10.22	38.37	54.00	-15.63	AVG	

REMARKS:

- (1) Measurement Value = Reading Level + Correct Factor.
- (2) Margin Level = Measurement Value - Limit Value.

Test Mode	UNII-1_TX N(HT20) Mode 5180 MHz	Polarization	Vertical
-----------	---------------------------------	--------------	----------

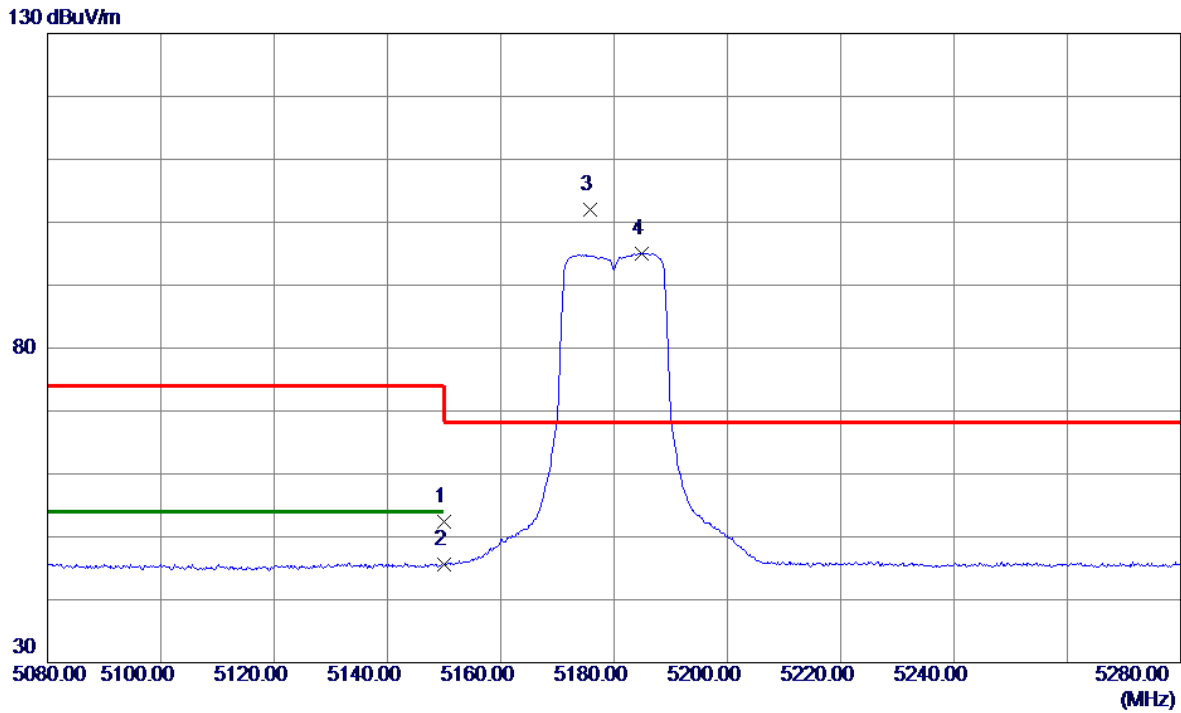

No.	Freq. MHz	Reading Level dBuV/m	Correct Factor dB	Measure ment dBuV/m	Limit dBuV/m	Margin dB	Detector	Comment
1	5150.0000	36.21	16.28	52.49	74.00	-21.51	Peak	
2	5150.0000	29.37	16.28	45.65	54.00	-8.35	AVG	
3 *	5175.8000	85.59	16.31	101.90	68.20	33.70	Peak	No Limit
4	5184.8000	78.72	16.32	95.04	999.00	-903.96	AVG	No Limit

REMARKS:

- (1) Measurement Value = Reading Level + Correct Factor.
- (2) Margin Level = Measurement Value - Limit Value.

Test Mode	UNII-1_TX N(HT20) Mode 5180 MHz	Polarization	Vertical
-----------	---------------------------------	--------------	----------

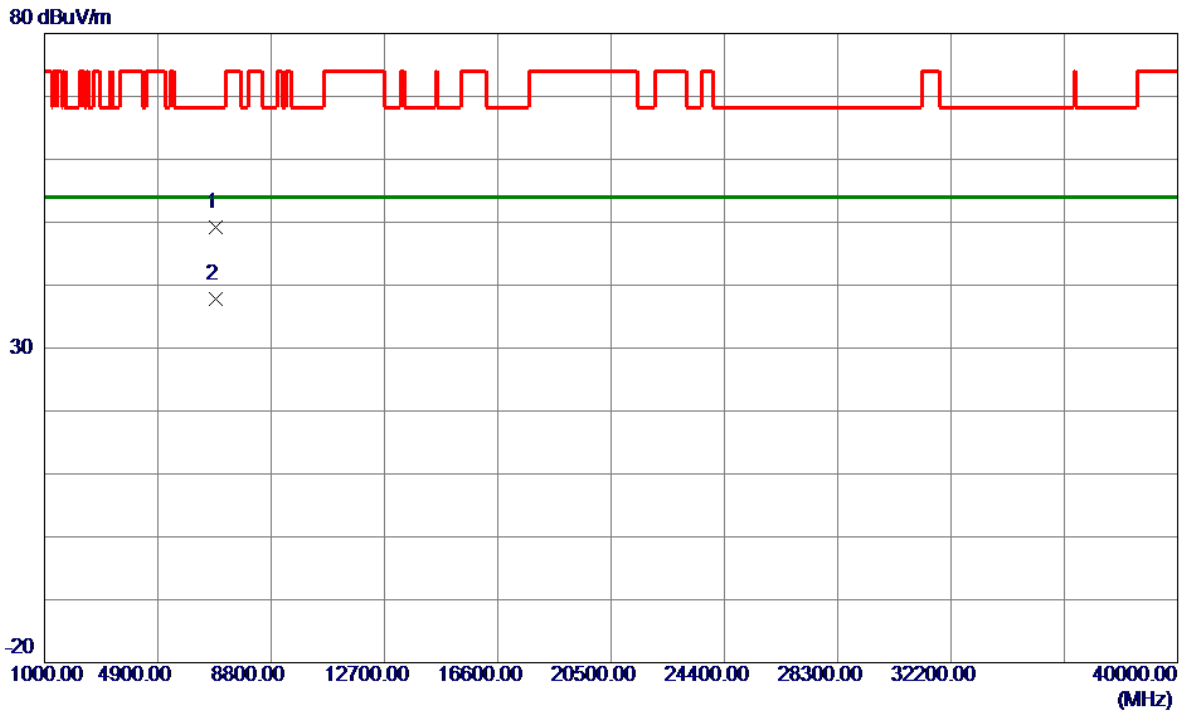

No.	Freq. MHz	Reading Level dBuV/m	Correct Factor dB	Measure ment dBuV/m	Limit dBuV/m	Margin dB	Detector	Comment
1	6904.4850	39.41	9.83	49.24	68.20	-18.96	Peak	
2 *	6906.7750	27.98	9.84	37.82	54.00	-16.18	AVG	

REMARKS:

- (1) Measurement Value = Reading Level + Correct Factor.
- (2) Margin Level = Measurement Value - Limit Value.

Test Mode	UNII-1_TX N(HT20) Mode 5180 MHz	Polarization	Horizontal
-----------	---------------------------------	--------------	------------

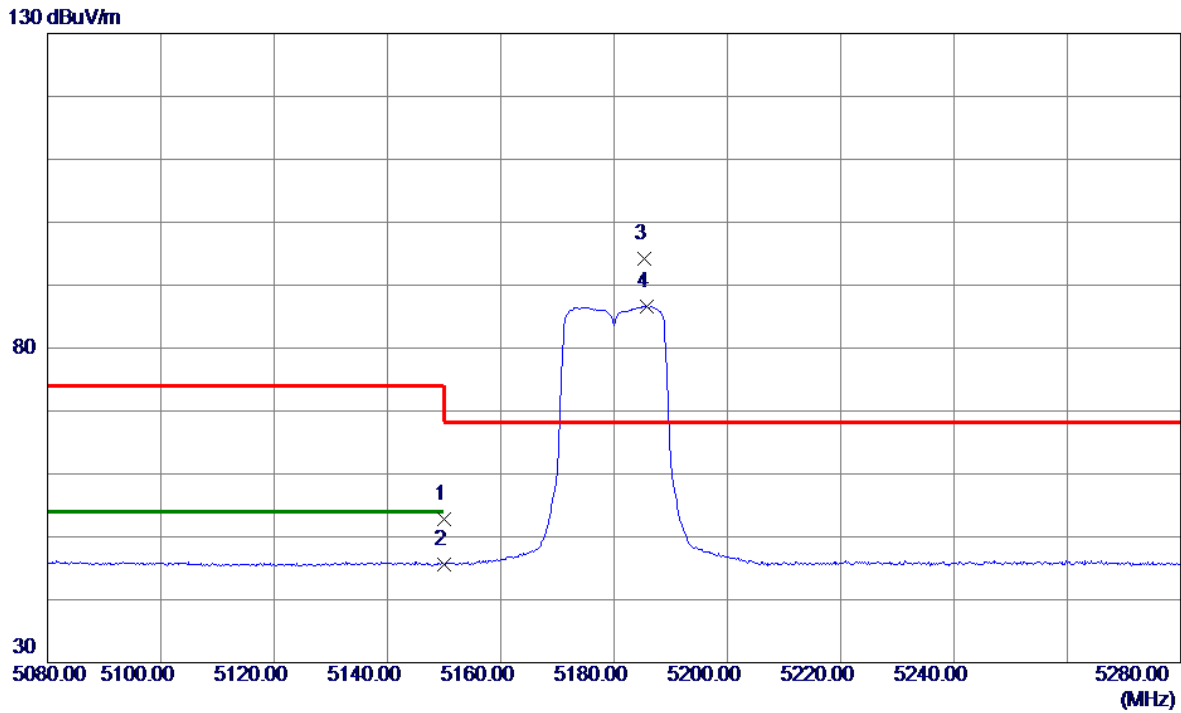

No.	Freq. MHz	Reading Level dBuV/m	Correct Factor dB	Measure ment dBuV/m	Limit dBuV/m	Margin dB	Detector	Comment
1	5150.0000	36.61	16.28	52.89	74.00	-21.11	Peak	
2	5150.0000	29.35	16.28	45.63	54.00	-8.37	AVG	
3 *	5185.4000	77.81	16.32	94.13	68.20	25.93	Peak	No Limit
4	5185.8000	70.31	16.32	86.63	999.00	-912.37	AVG	No Limit

REMARKS:

- (1) Measurement Value = Reading Level + Correct Factor.
- (2) Margin Level = Measurement Value - Limit Value.

Test Mode	UNII-1_TX N(HT20) Mode 5180 MHz	Polarization	Horizontal
-----------	---------------------------------	--------------	------------

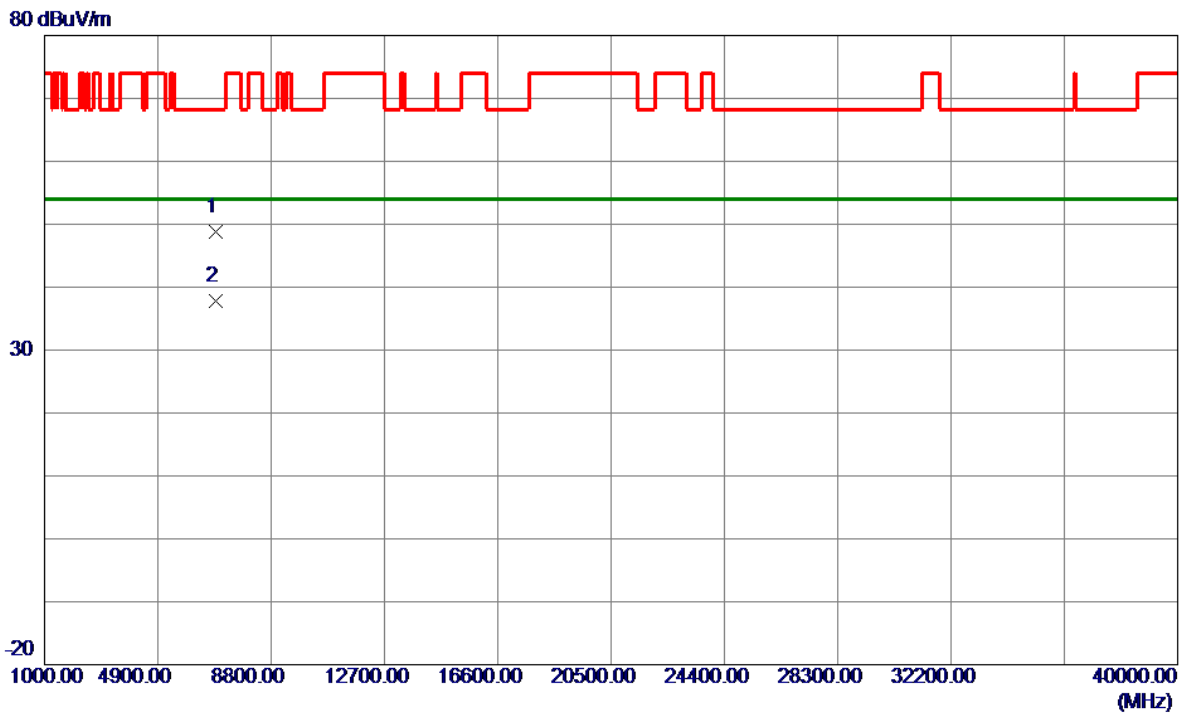

No.	Freq. MHz	Reading Level dBuV/m	Correct Factor dB	Measure ment dBuV/m	Limit dBuV/m	Margin dB	Detector	Comment
1	6904.3150	39.05	9.83	48.88	68.20	-19.32	Peak	
2 *	6905.2750	27.95	9.84	37.79	54.00	-16.21	AVG	

REMARKS:

- (1) Measurement Value = Reading Level + Correct Factor.
- (2) Margin Level = Measurement Value - Limit Value.

Test Mode	UNII-1_TX N(HT20) Mode 5200 MHz	Polarization	Vertical
-----------	---------------------------------	--------------	----------

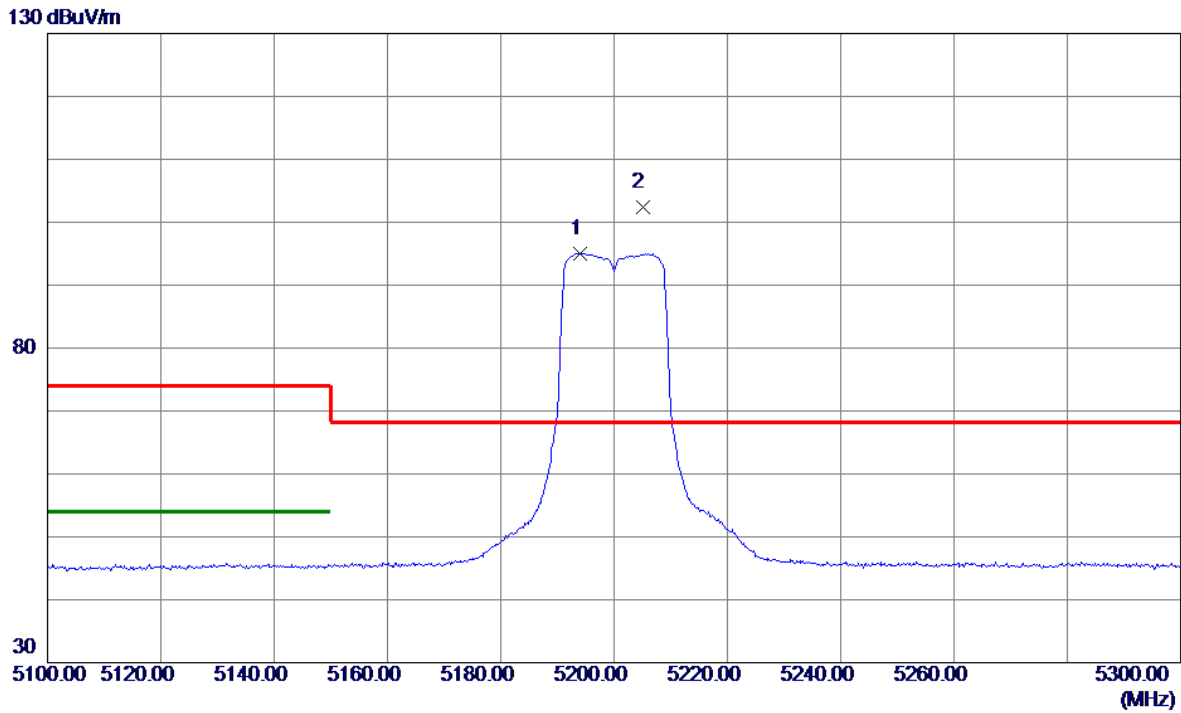

No.	Freq. MHz	Reading Level dBuV/m	Correct Factor dB	Measure ment dBuV/m	Limit dBuV/m	Margin dB	Detector	Comment
1	5194.0000	78.71	16.33	95.04	999.00	-903.96	AVG	No Limit
2 *	5205.0000	86.08	16.34	102.42	68.20	34.22	Peak	No Limit

REMARKS:

- (1) Measurement Value = Reading Level + Correct Factor.
- (2) Margin Level = Measurement Value - Limit Value.

Test Mode	UNII-1_TX N(HT20) Mode 5200 MHz	Polarization	Vertical
-----------	---------------------------------	--------------	----------

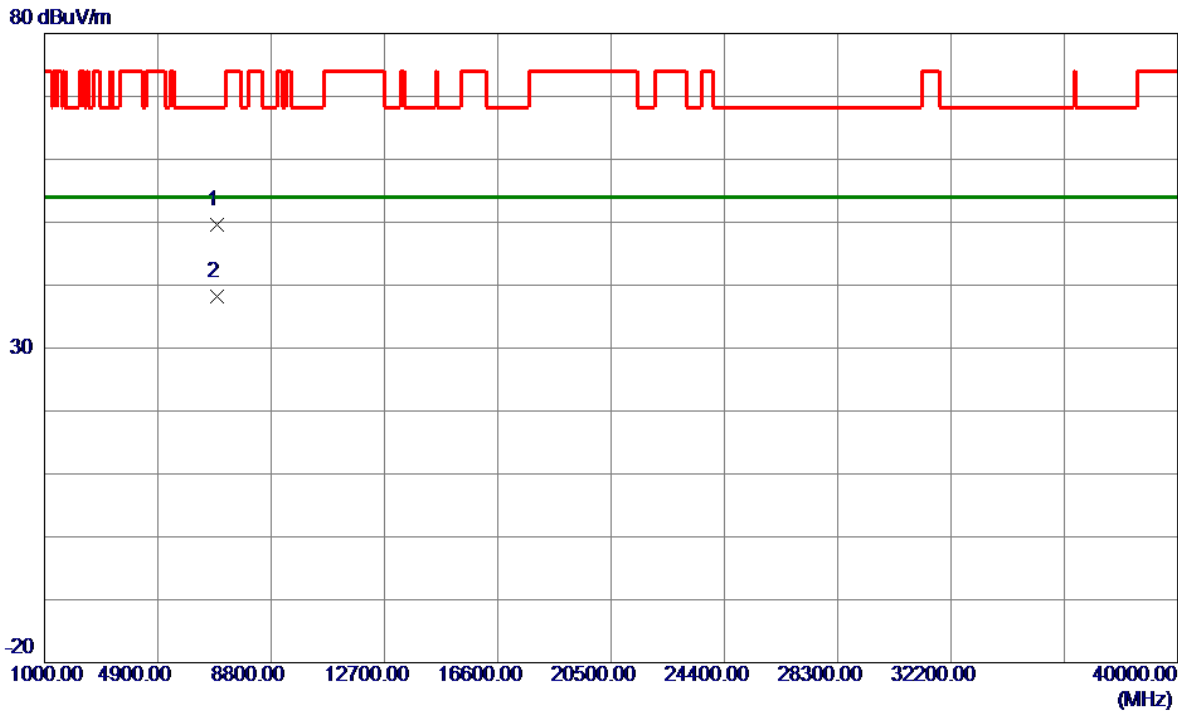

No.	Freq. MHz	Reading Level dBuV/m	Correct Factor dB	Measure ment dBuV/m	Limit dBuV/m	Margin dB	Detector	Comment
1	6932.0000	39.62	9.96	49.58	68.20	-18.62	Peak	
2 *	6935.7050	28.17	9.98	38.15	54.00	-15.85	AVG	

REMARKS:

- (1) Measurement Value = Reading Level + Correct Factor.
- (2) Margin Level = Measurement Value - Limit Value.

Test Mode	UNII-1_TX N(HT20) Mode 5200 MHz	Polarization	Horizontal
-----------	---------------------------------	--------------	------------

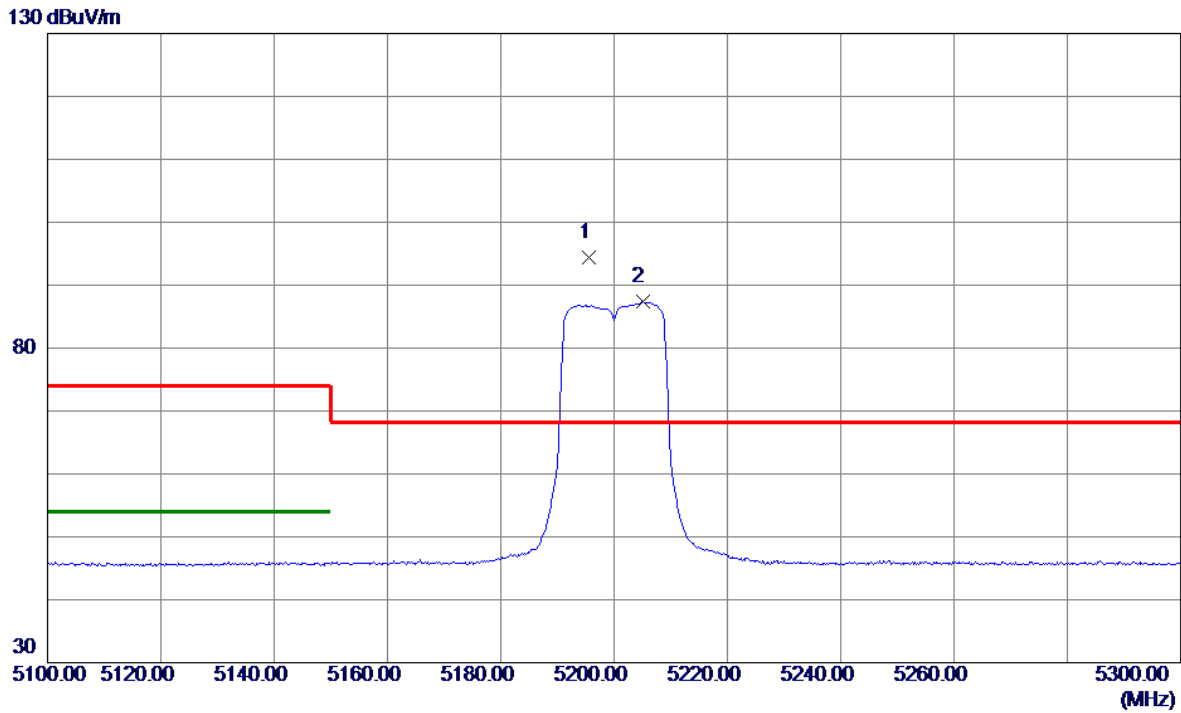

No.	Freq. MHz	Reading Level dBuV/m	Correct Factor dB	Measure ment dBuV/m	Limit dBuV/m	Margin dB	Detector	Comment
1 *	5195.6000	78.04	16.33	94.37	68.20	26.17	Peak	No Limit
2	5205.0000	70.99	16.34	87.33	999.00	-911.67	AVG	No Limit

REMARKS:

- (1) Measurement Value = Reading Level + Correct Factor.
- (2) Margin Level = Measurement Value - Limit Value.

Test Mode	UNII-1_TX N(HT20) Mode 5200 MHz	Polarization	Horizontal
-----------	---------------------------------	--------------	------------

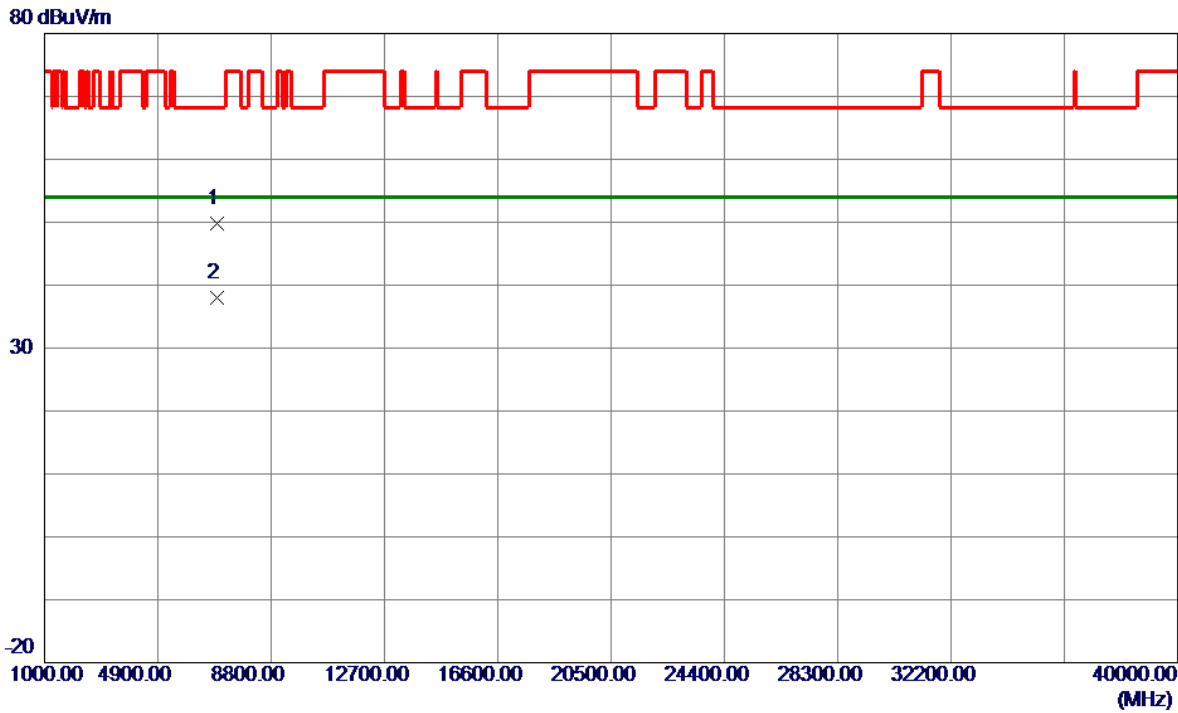

No.	Freq. MHz	Reading Level dBuV/m	Correct Factor dB	Measure ment dBuV/m	Limit dBuV/m	Margin dB	Detector	Comment
1	6933.2400	39.85	9.97	49.82	68.20	-18.38	Peak	
2 *	6934.7650	28.11	9.98	38.09	54.00	-15.91	AVG	

REMARKS:

- (1) Measurement Value = Reading Level + Correct Factor.
- (2) Margin Level = Measurement Value - Limit Value.

Test Mode	UNII-1_TX N(HT20) Mode 5240 MHz	Polarization	Vertical
-----------	---------------------------------	--------------	----------

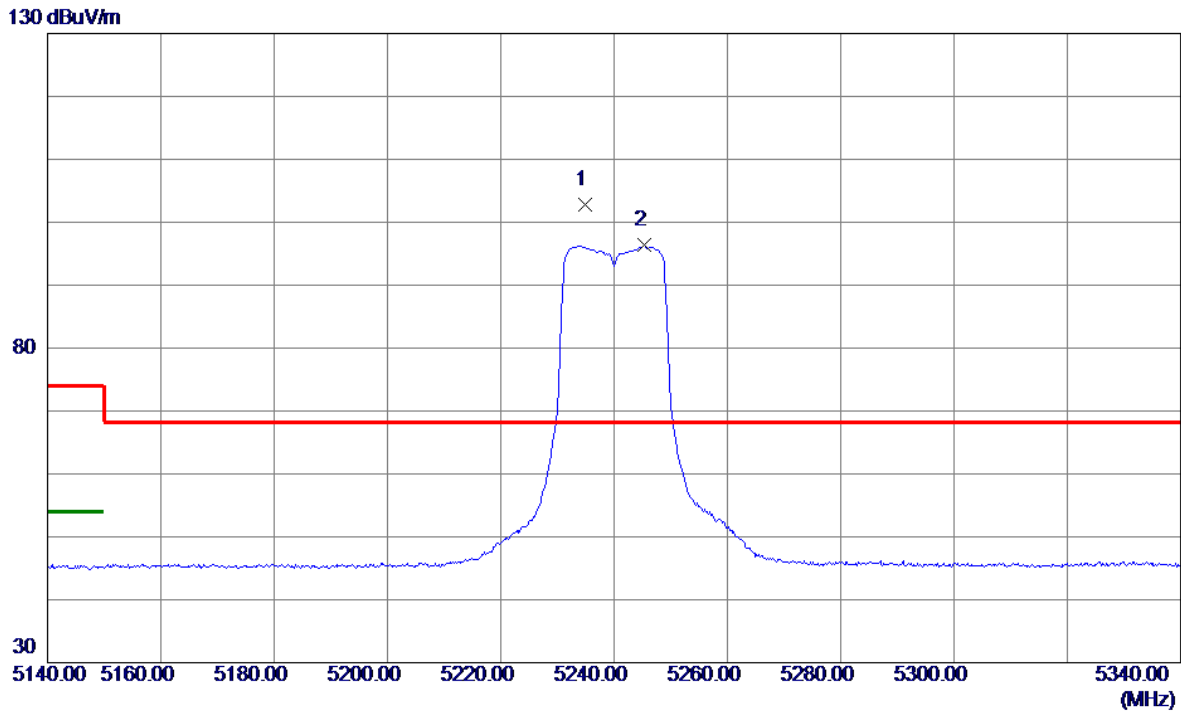

No.	Freq. MHz	Reading Level dBuV/m	Correct Factor dB	Measure ment dBuV/m	Limit dBuV/m	Margin dB	Detector	Comment
1 *	5234.8000	86.45	16.38	102.83	68.20	34.63	Peak	No Limit
2	5245.4000	79.92	16.39	96.31	999.00	-902.69	AVG	No Limit

REMARKS:

- (1) Measurement Value = Reading Level + Correct Factor.
- (2) Margin Level = Measurement Value - Limit Value.

Test Mode	UNII-1_TX N(HT20) Mode 5240 MHz	Polarization	Vertical
-----------	---------------------------------	--------------	----------

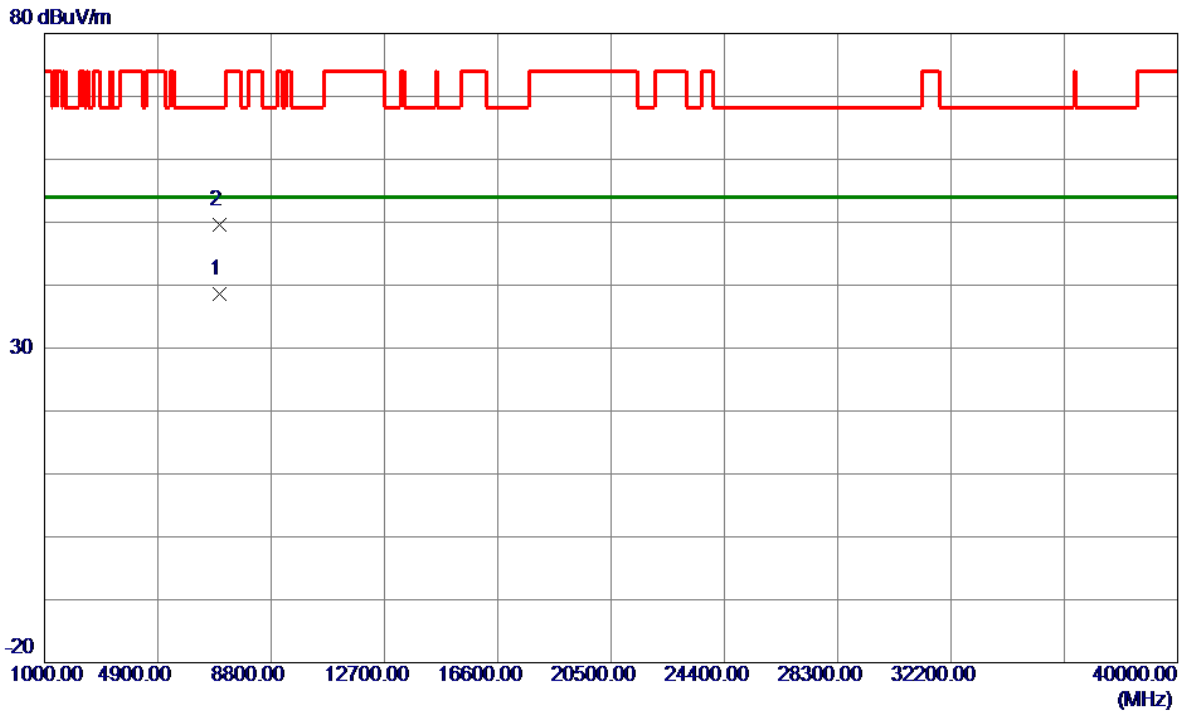

No.	Freq. MHz	Reading Level dBuV/m	Correct Factor dB	Measure ment dBuV/m	Limit dBuV/m	Margin dB	Detector	Comment
1 *	7014.6250	28.21	10.31	38.52	54.00	-15.48	AVG	
2	7015.4300	39.34	10.31	49.65	68.20	-18.55	Peak	

REMARKS:

- (1) Measurement Value = Reading Level + Correct Factor.
- (2) Margin Level = Measurement Value - Limit Value.

Test Mode	UNII-1_TX N(HT20) Mode 5240 MHz	Polarization	Horizontal
-----------	---------------------------------	--------------	------------

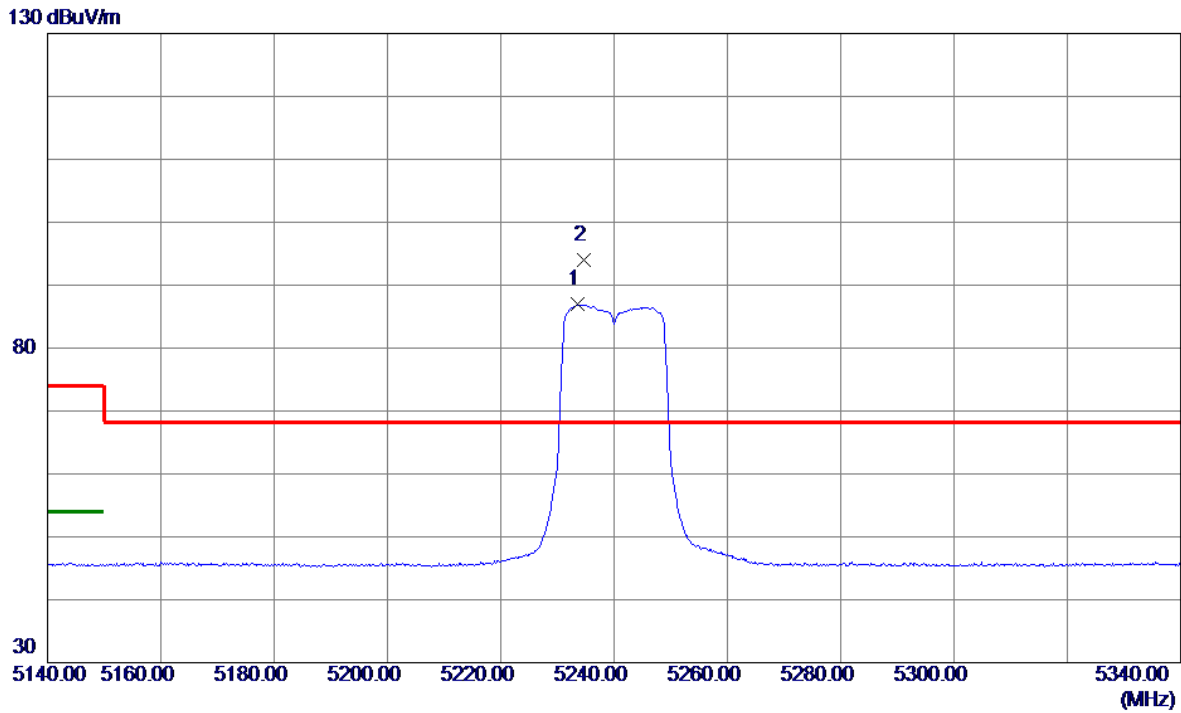

No.	Freq. MHz	Reading Level dBuV/m	Correct Factor dB	Measure ment dBuV/m	Limit dBuV/m	Margin dB	Detector	Comment
1	5233.6000	70.53	16.37	86.90	999.00	-912.10	AVG	No Limit
2 *	5234.6000	77.68	16.38	94.06	68.20	25.86	Peak	No Limit

REMARKS:

- (1) Measurement Value = Reading Level + Correct Factor.
- (2) Margin Level = Measurement Value - Limit Value.

Test Mode	UNII-1_TX N(HT20) Mode 5240 MHz	Polarization	Horizontal
-----------	---------------------------------	--------------	------------

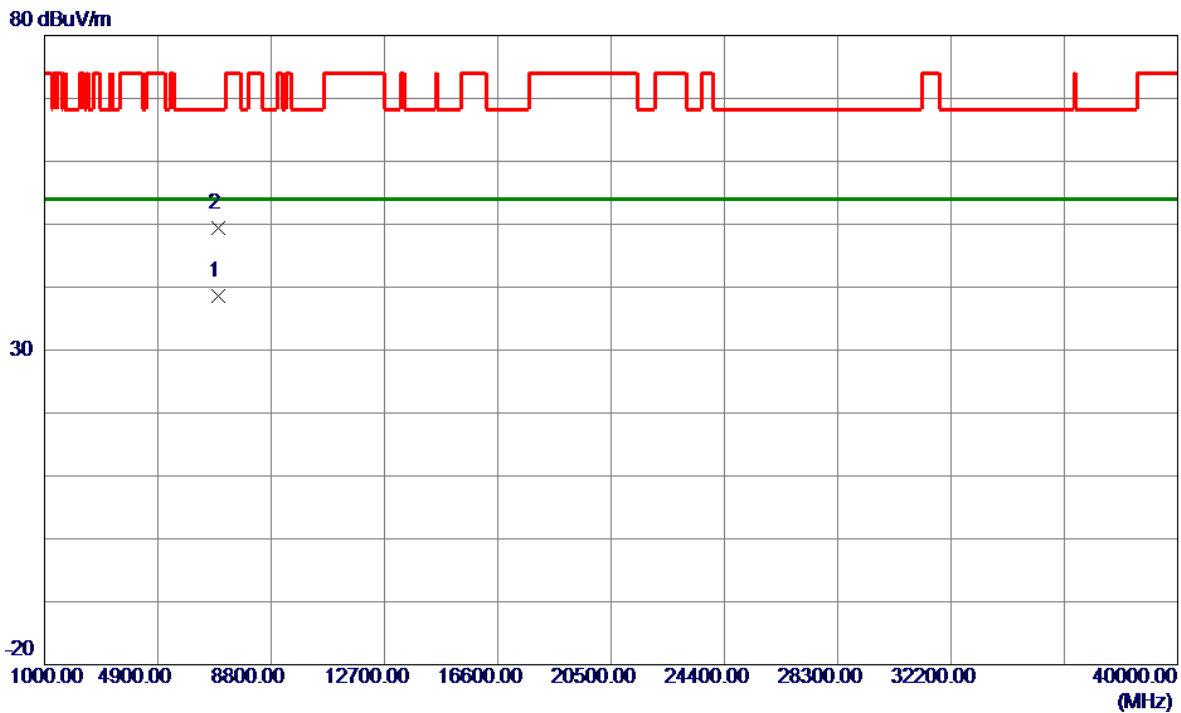

No.	Freq. MHz	Reading Level dBuV/m	Correct Factor dB	Measure ment dBuV/m	Limit dBuV/m	Margin dB	Detector	Comment
1 *	6986.1800	28.32	10.22	38.54	54.00	-15.46	AVG	
2	6986.3300	39.16	10.22	49.38	68.20	-18.82	Peak	

REMARKS:

- (1) Measurement Value = Reading Level + Correct Factor.
- (2) Margin Level = Measurement Value - Limit Value.

Test Mode	UNII-1_TX N(HT40) Mode 5190 MHz	Polarization	Vertical
-----------	---------------------------------	--------------	----------

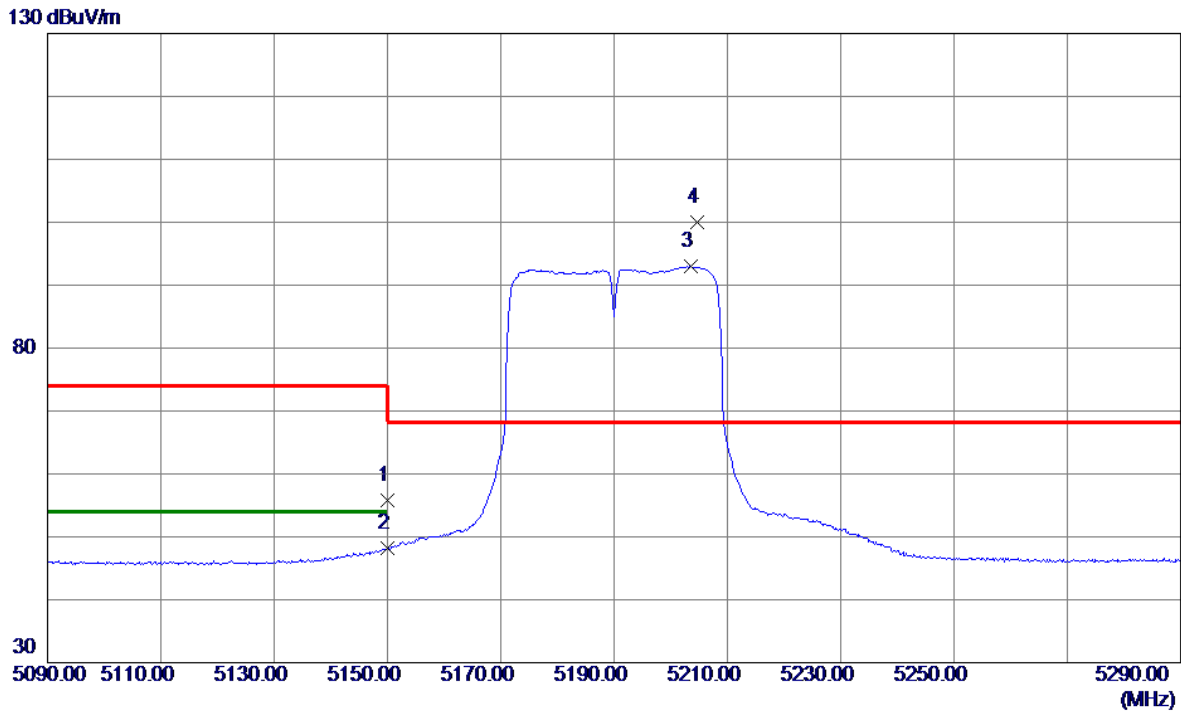

No.	Freq. MHz	Reading Level dBuV/m	Correct Factor dB	Measure ment dBuV/m	Limit dBuV/m	Margin dB	Detector	Comment
1	5150.0000	39.48	16.28	55.76	74.00	-18.24	Peak	
2	5150.0000	31.98	16.28	48.26	54.00	-5.74	AVG	
3	5203.6000	76.60	16.34	92.94	999.00	-906.06	AVG	No Limit
4 *	5204.6000	83.61	16.34	99.95	68.20	31.75	Peak	No Limit

REMARKS:

- (1) Measurement Value = Reading Level + Correct Factor.
- (2) Margin Level = Measurement Value - Limit Value.

Test Mode	UNII-1_TX N(HT40) Mode 5190 MHz	Polarization	Vertical
-----------	---------------------------------	--------------	----------

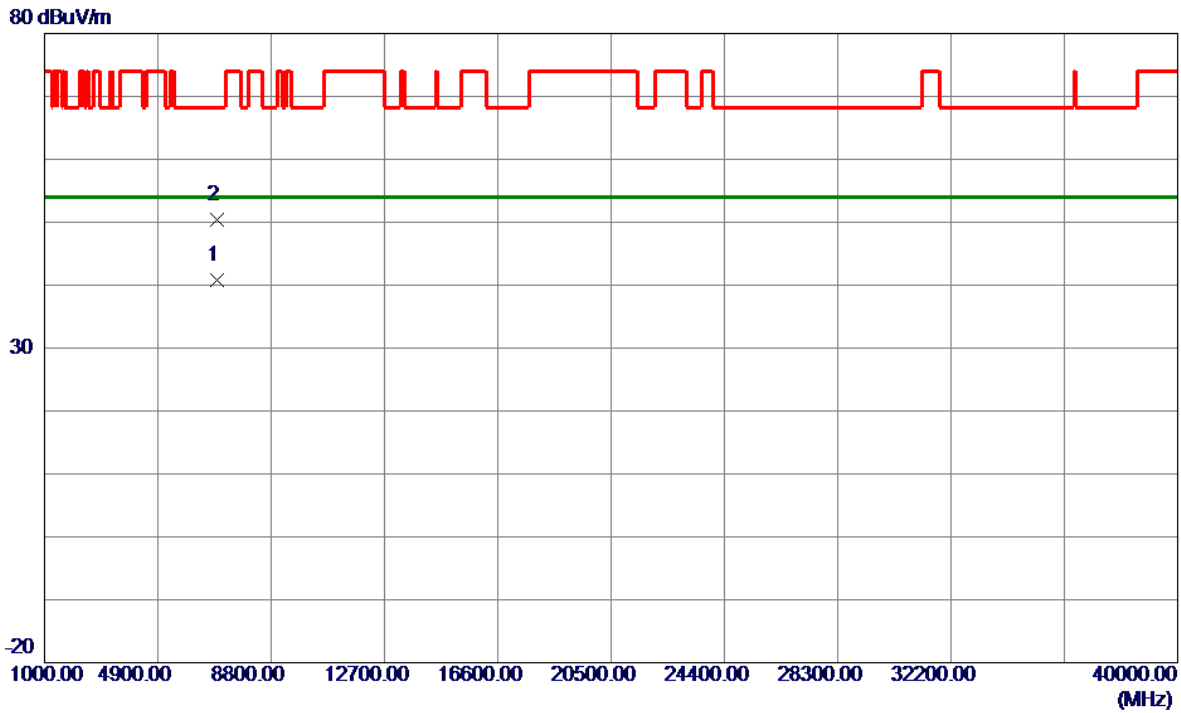

No.	Freq. MHz	Reading Level dBuV/m	Correct Factor dB	Measure ment dBuV/m	Limit dBuV/m	Margin dB	Detector	Comment
1 *	6919.8900	30.90	9.91	40.81	54.00	-13.19	AVG	
2	6921.3200	40.47	9.91	50.38	68.20	-17.82	Peak	

REMARKS:

- (1) Measurement Value = Reading Level + Correct Factor.
- (2) Margin Level = Measurement Value - Limit Value.

Test Mode	UNII-1_TX N(HT40) Mode 5190 MHz	Polarization	Horizontal
-----------	---------------------------------	--------------	------------

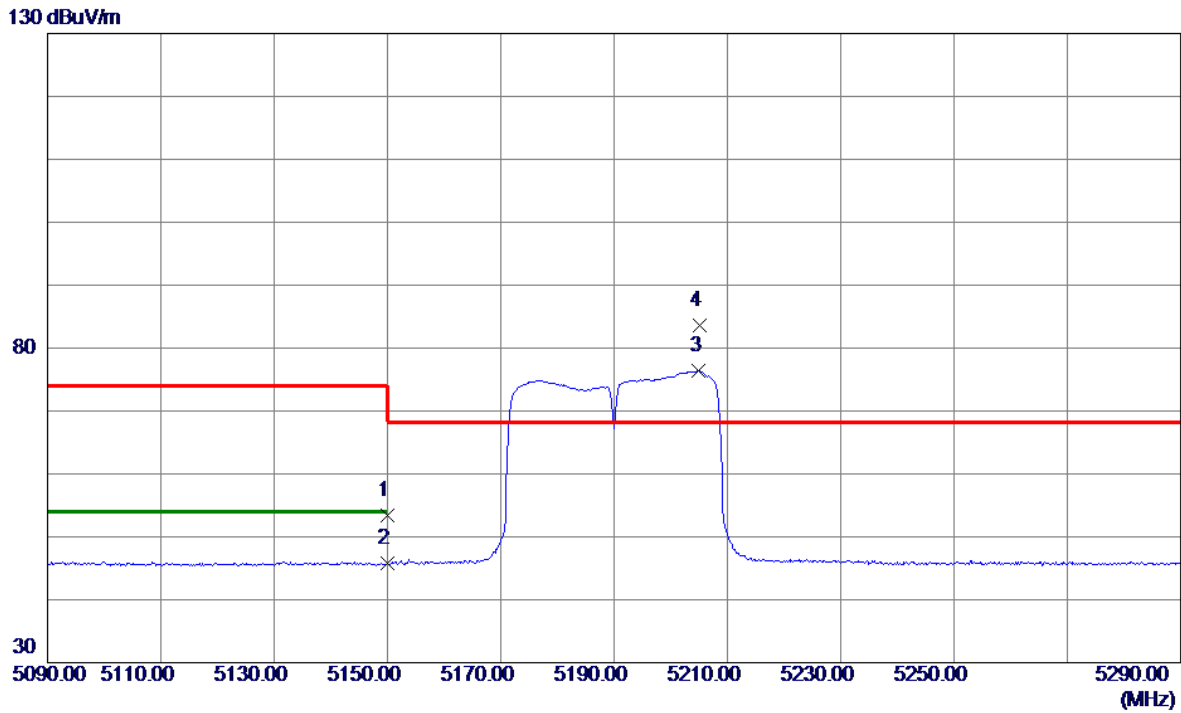

No.	Freq. MHz	Reading Level dBuV/m	Correct Factor dB	Measure ment dBuV/m	Limit dBuV/m	Margin dB	Detector	Comment
1	5150.0000	37.11	16.28	53.39	74.00	-20.61	Peak	
2	5150.0000	29.48	16.28	45.76	54.00	-8.24	AVG	
3	5205.0000	60.00	16.34	76.34	999.00	-922.66	AVG	No Limit
4 *	5205.2000	67.33	16.34	83.67	68.20	15.47	Peak	No Limit

REMARKS:

- (1) Measurement Value = Reading Level + Correct Factor.
- (2) Margin Level = Measurement Value - Limit Value.

Test Mode	UNII-1_TX N(HT40) Mode 5190 MHz	Polarization	Horizontal
-----------	---------------------------------	--------------	------------

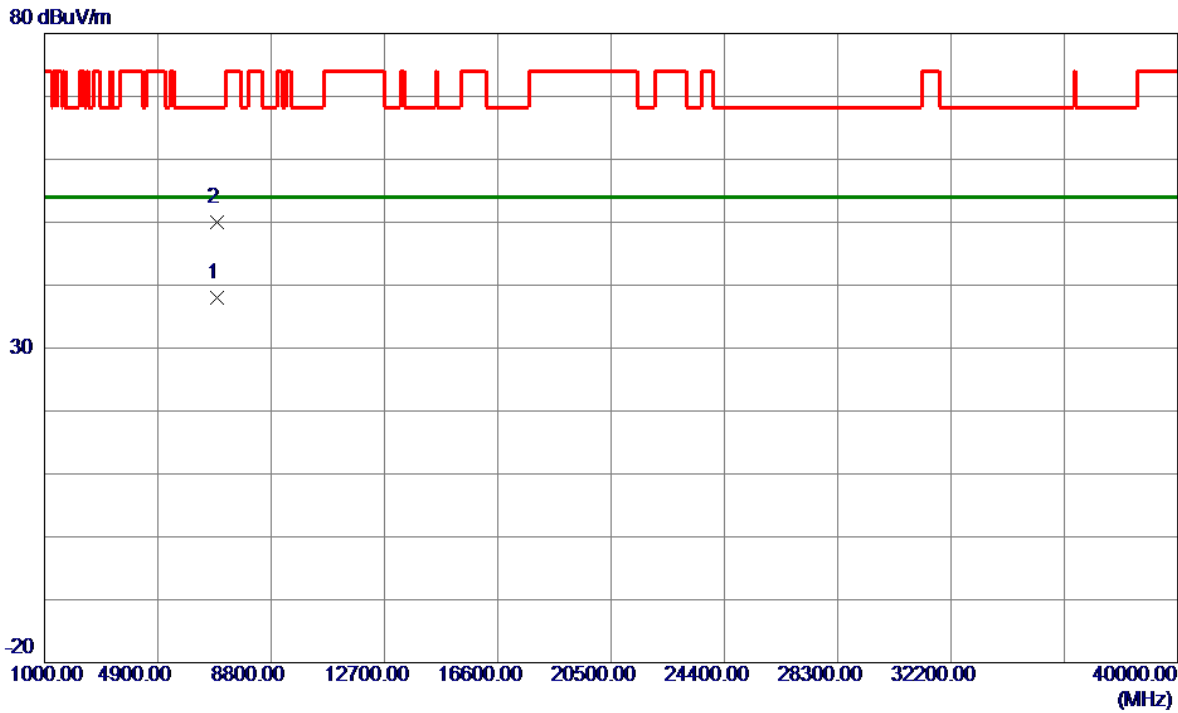

No.	Freq. MHz	Reading Level dBuV/m	Correct Factor dB	Measure ment dBuV/m	Limit dBuV/m	Margin dB	Detector	Comment
1 *	6920.3250	28.14	9.91	38.05	54.00	-15.95	AVG	
2	6922.0850	40.12	9.92	50.04	68.20	-18.16	Peak	

REMARKS:

- (1) Measurement Value = Reading Level + Correct Factor.
- (2) Margin Level = Measurement Value - Limit Value.

Test Mode	UNII-1_TX N(HT40) Mode 5230 MHz	Polarization	Vertical
-----------	---------------------------------	--------------	----------

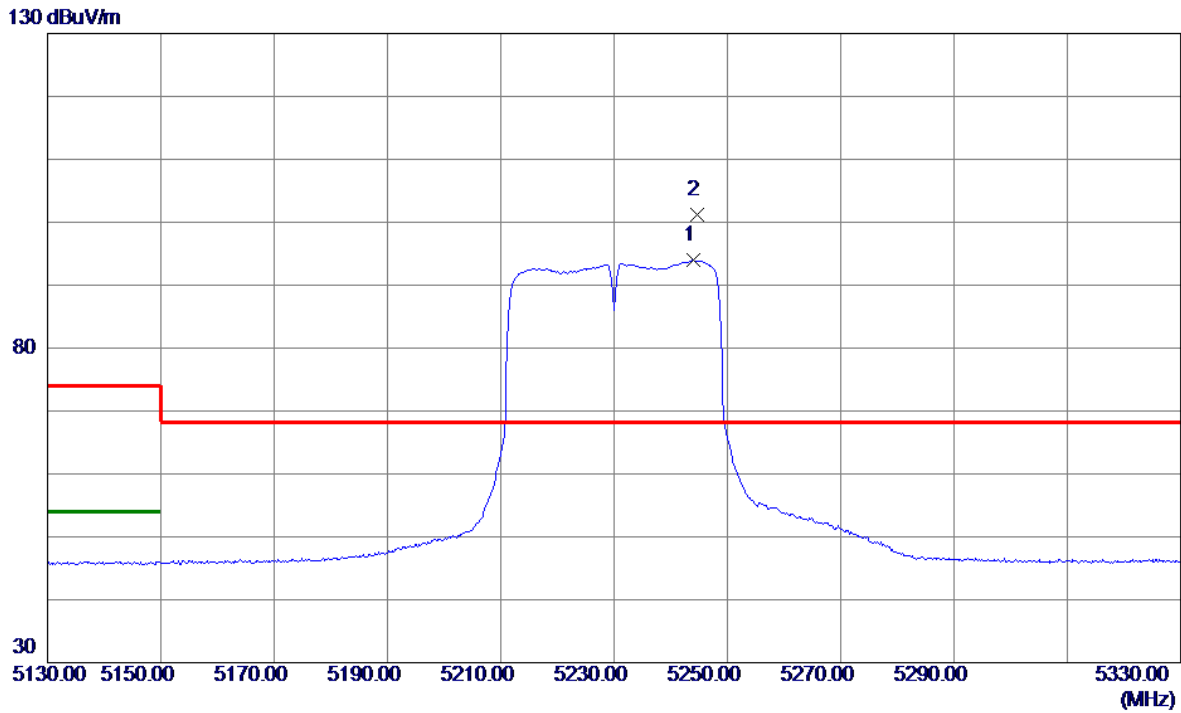

No.	Freq. MHz	Reading Level dBuV/m	Correct Factor dB	Measure ment dBuV/m	Limit dBuV/m	Margin dB	Detector	Comment
1	5244.0000	77.54	16.39	93.93	999.00	-905.07	AVG	No Limit
2 *	5244.6000	84.86	16.39	101.25	68.20	33.05	Peak	No Limit

REMARKS:

- (1) Measurement Value = Reading Level + Correct Factor.
- (2) Margin Level = Measurement Value - Limit Value.

Test Mode	UNII-1_TX N(HT40) Mode 5230 MHz	Polarization	Vertical
-----------	---------------------------------	--------------	----------

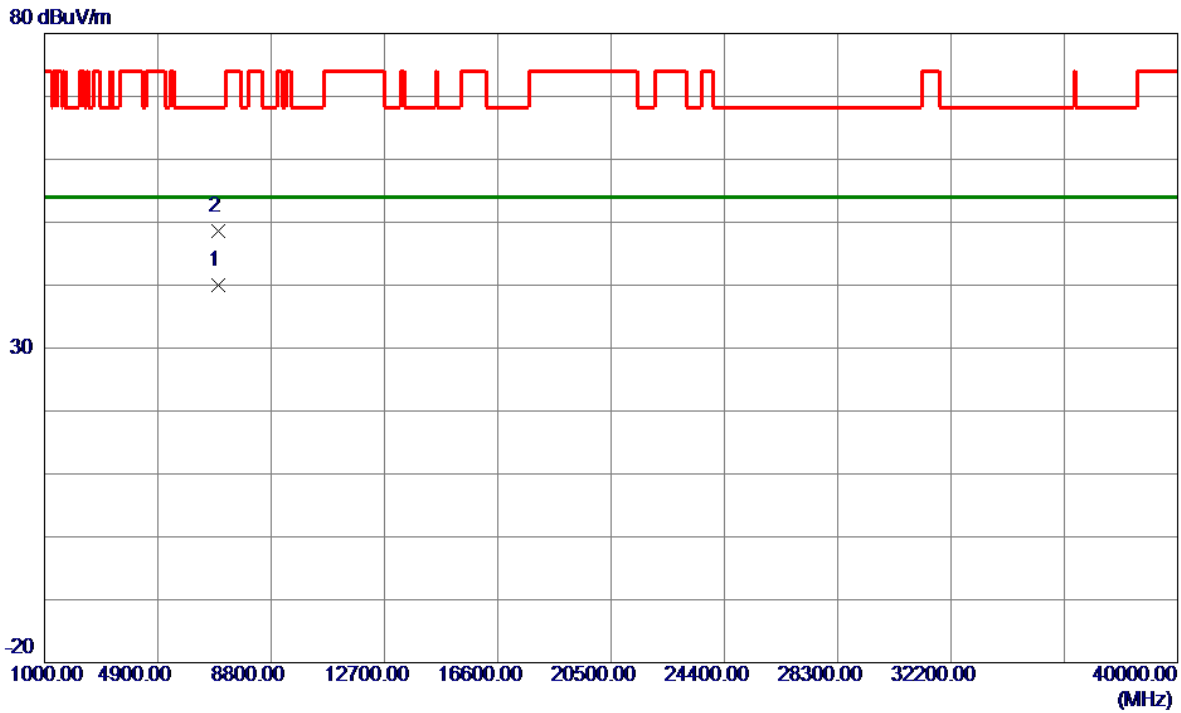

No.	Freq. MHz	Reading Level dBuV/m	Correct Factor dB	Measure ment dBuV/m	Limit dBuV/m	Margin dB	Detector	Comment
1 *	6971.2950	29.85	10.15	40.00	54.00	-14.00	AVG	
2	6971.3400	38.46	10.15	48.61	68.20	-19.59	Peak	

REMARKS:

- (1) Measurement Value = Reading Level + Correct Factor.
- (2) Margin Level = Measurement Value - Limit Value.

Test Mode	UNII-1_TX N(HT40) Mode 5230 MHz	Polarization	Horizontal
-----------	---------------------------------	--------------	------------

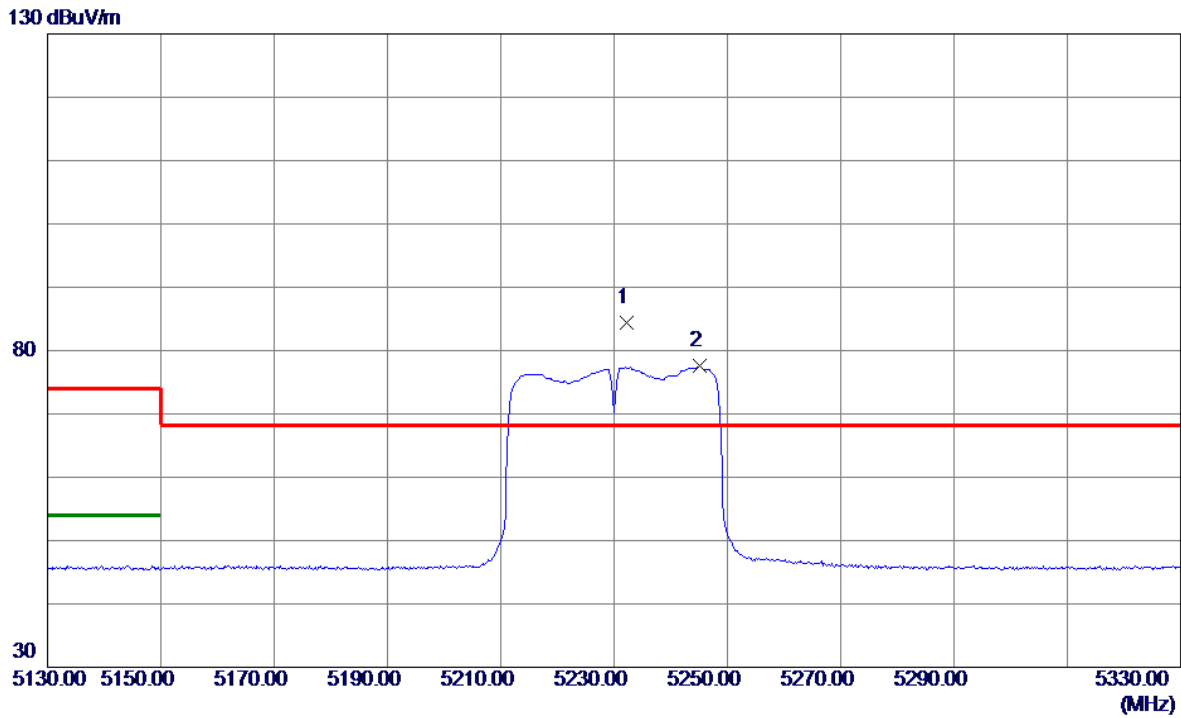

No.	Freq. MHz	Reading Level dBuV/m	Correct Factor dB	Measure ment dBuV/m	Limit dBuV/m	Margin dB	Detector	Comment
1 *	5232.2000	68.10	16.37	84.47	68.20	16.27	Peak	No Limit
2	5245.2000	61.19	16.39	77.58	999.00	-921.42	AVG	No Limit

REMARKS:

- (1) Measurement Value = Reading Level + Correct Factor.
- (2) Margin Level = Measurement Value - Limit Value.

Test Mode	UNII-1_TX N(HT40) Mode 5230 MHz	Polarization	Horizontal
-----------	---------------------------------	--------------	------------

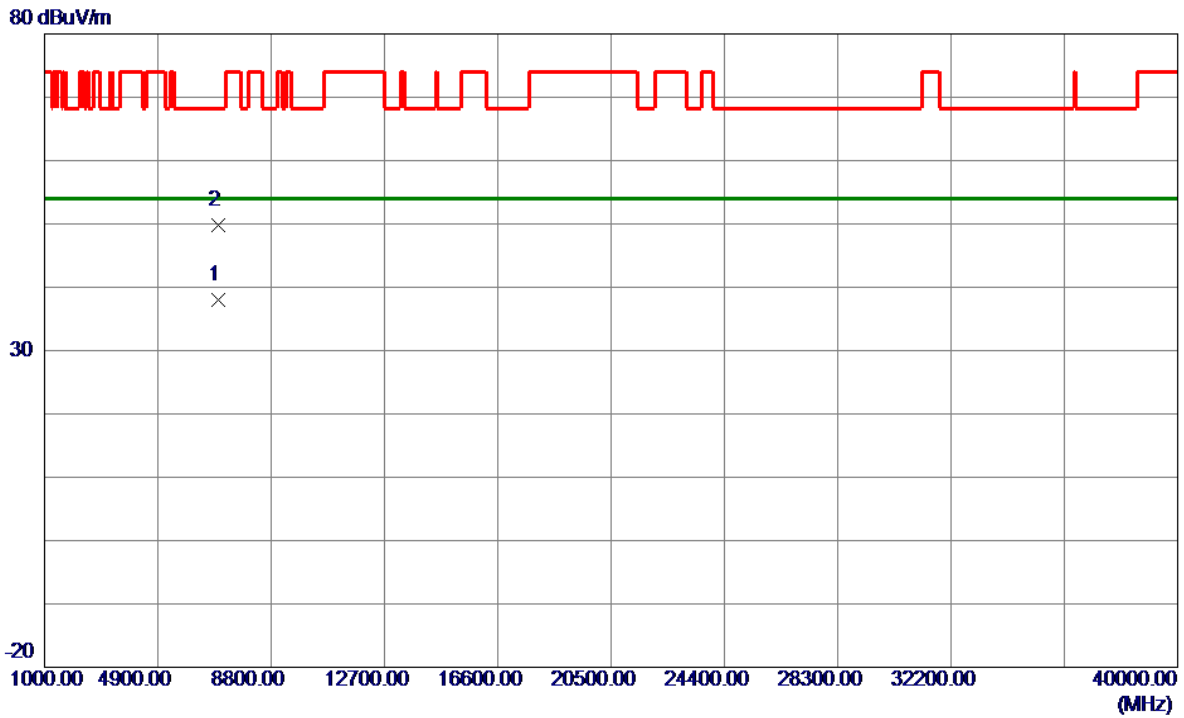

No.	Freq. MHz	Reading Level dBuV/m	Correct Factor dB	Measure ment dBuV/m	Limit dBuV/m	Margin dB	Detector	Comment
1 *	6972.2950	27.75	10.16	37.91	54.00	-16.09	AVG	
2	6973.1550	39.63	10.16	49.79	68.20	-18.41	Peak	

REMARKS:

- (1) Measurement Value = Reading Level + Correct Factor.
- (2) Margin Level = Measurement Value - Limit Value.

Test Mode	UNII-1_TX AC(VHT20) Mode 5180 MHz	Polarization	Vertical
-----------	-----------------------------------	--------------	----------

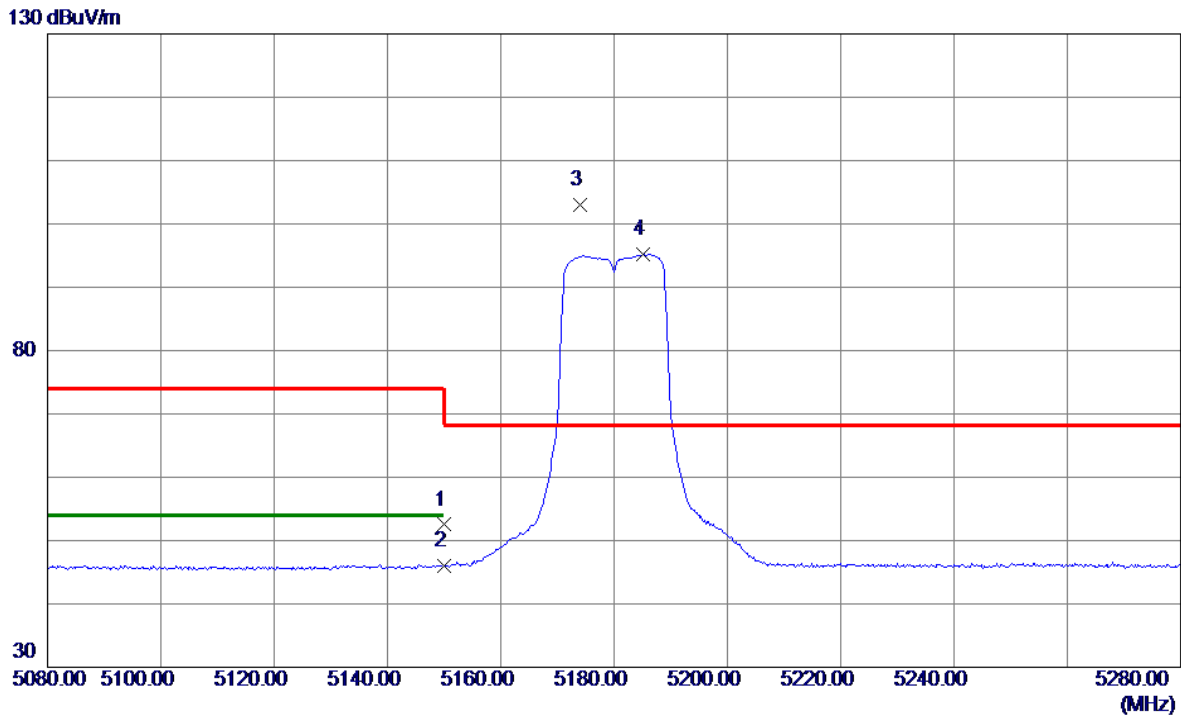

No.	Freq. MHz	Reading Level dBuV/m	Correct Factor dB	Measure ment dBuV/m	Limit dBuV/m	Margin dB	Detector	Comment
1	5150.0000	36.22	16.28	52.50	74.00	-21.50	Peak	
2	5150.0000	29.79	16.28	46.07	54.00	-7.93	AVG	
3 *	5174.0000	86.60	16.31	102.91	68.20	34.71	Peak	No Limit
4	5185.2000	78.87	16.32	95.19	999.00	-903.81	AVG	No Limit

REMARKS:

- (1) Measurement Value = Reading Level + Correct Factor.
- (2) Margin Level = Measurement Value - Limit Value.

Test Mode	UNII-1_TX AC(VHT20) Mode 5180 MHz	Polarization	Vertical
-----------	-----------------------------------	--------------	----------

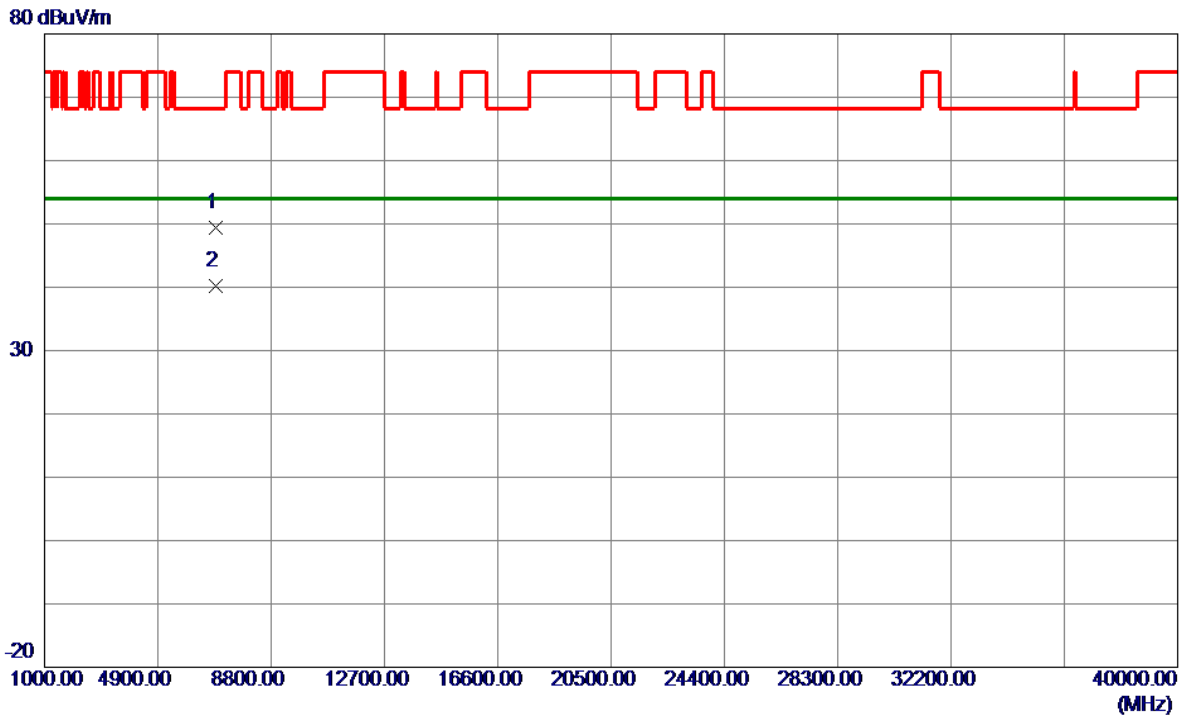

No.	Freq. MHz	Reading Level dBuV/m	Correct Factor dB	Measure ment dBuV/m	Limit dBuV/m	Margin dB	Detector	Comment
1	6906.6900	39.64	9.84	49.48	68.20	-18.72	Peak	
2 *	6906.7000	30.39	9.84	40.23	54.00	-13.77	AVG	

REMARKS:

- (1) Measurement Value = Reading Level + Correct Factor.
- (2) Margin Level = Measurement Value - Limit Value.

Test Mode	UNII-1_TX AC(VHT20) Mode 5180 MHz	Polarization	Horizontal
-----------	-----------------------------------	--------------	------------

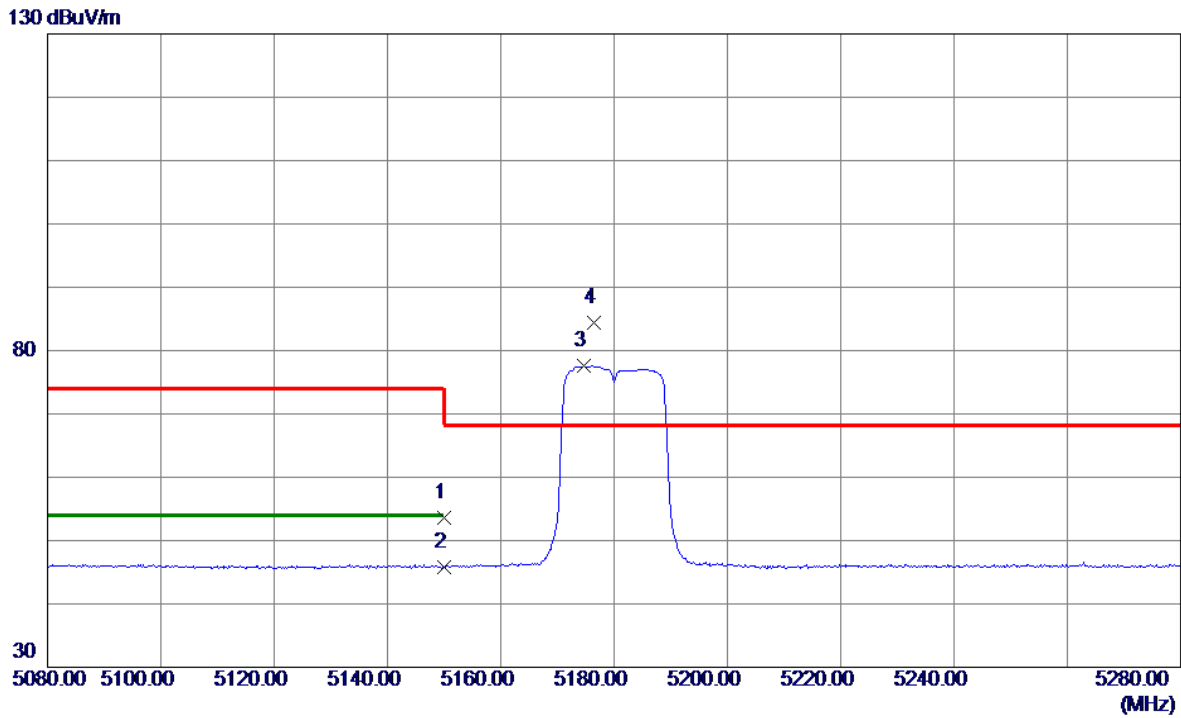

No.	Freq. MHz	Reading Level dBuV/m	Correct Factor dB	Measure ment dBuV/m	Limit dBuV/m	Margin dB	Detector	Comment
1	5150.0000	37.38	16.28	53.66	74.00	-20.34	Peak	
2	5150.0000	29.50	16.28	45.78	54.00	-8.22	AVG	
3	5174.6000	61.22	16.31	77.53	999.00	-921.47	AVG	No Limit
4 *	5176.4000	68.10	16.31	84.41	68.20	16.21	Peak	No Limit

REMARKS:

- (1) Measurement Value = Reading Level + Correct Factor.
- (2) Margin Level = Measurement Value - Limit Value.

Test Mode	UNII-1_TX AC(VHT20) Mode 5180 MHz	Polarization	Horizontal
-----------	-----------------------------------	--------------	------------

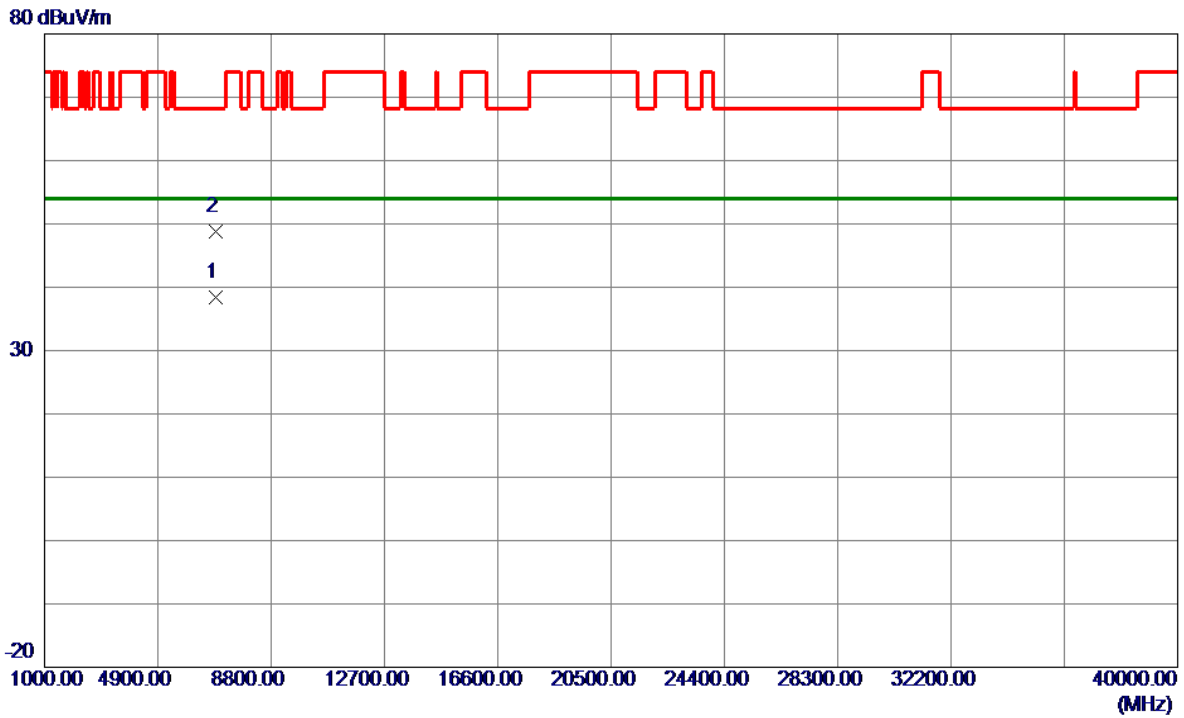

No.	Freq. MHz	Reading Level dBuV/m	Correct Factor dB	Measure ment dBuV/m	Limit dBuV/m	Margin dB	Detector	Comment
1 *	6906.7250	28.53	9.84	38.37	54.00	-15.63	AVG	
2	6906.7350	38.89	9.84	48.73	68.20	-19.47	Peak	

REMARKS:

- (1) Measurement Value = Reading Level + Correct Factor.
- (2) Margin Level = Measurement Value - Limit Value.

Test Mode	UNII-1_TX AC(VHT20) Mode 5200 MHz	Polarization	Vertical
-----------	-----------------------------------	--------------	----------

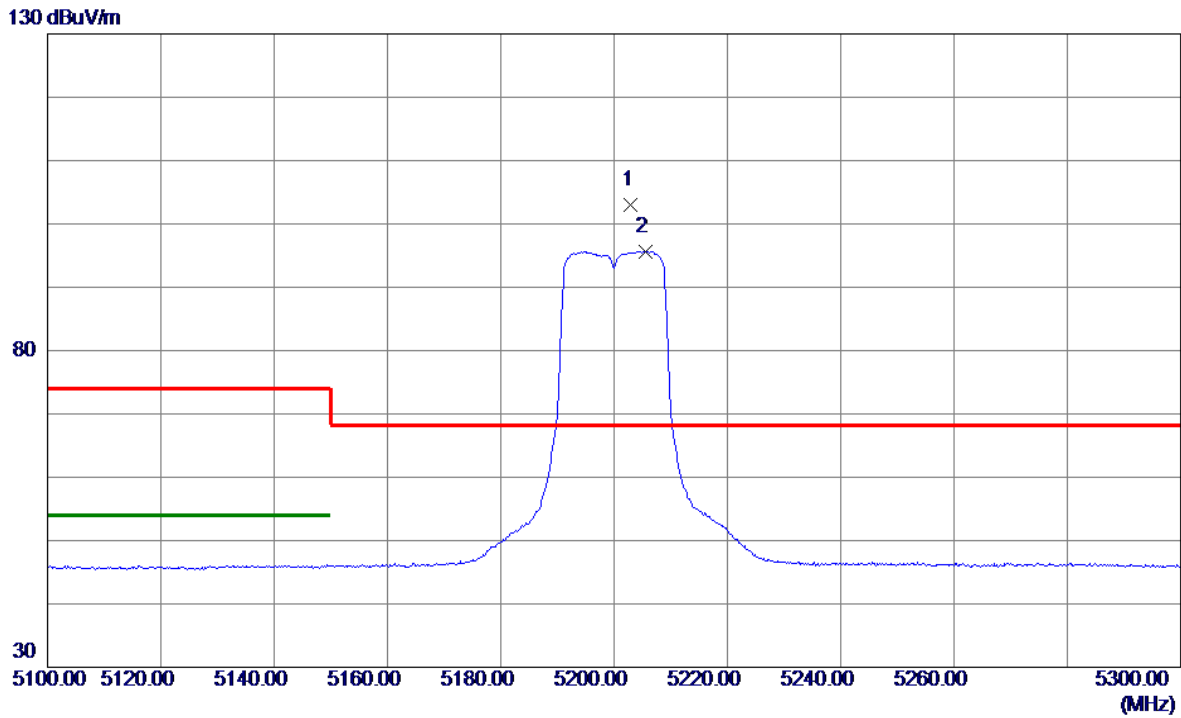

No.	Freq. MHz	Reading Level dBuV/m	Correct Factor dB	Measure ment dBuV/m	Limit dBuV/m	Margin dB	Detector	Comment
1 *	5203.0000	86.64	16.34	102.98	68.20	34.78	Peak	No Limit
2	5205.6000	79.32	16.34	95.66	999.00	-903.34	AVG	No Limit

REMARKS:

- (1) Measurement Value = Reading Level + Correct Factor.
- (2) Margin Level = Measurement Value - Limit Value.

Test Mode	UNII-1_TX AC(VHT20) Mode 5200 MHz	Polarization	Vertical
-----------	-----------------------------------	--------------	----------

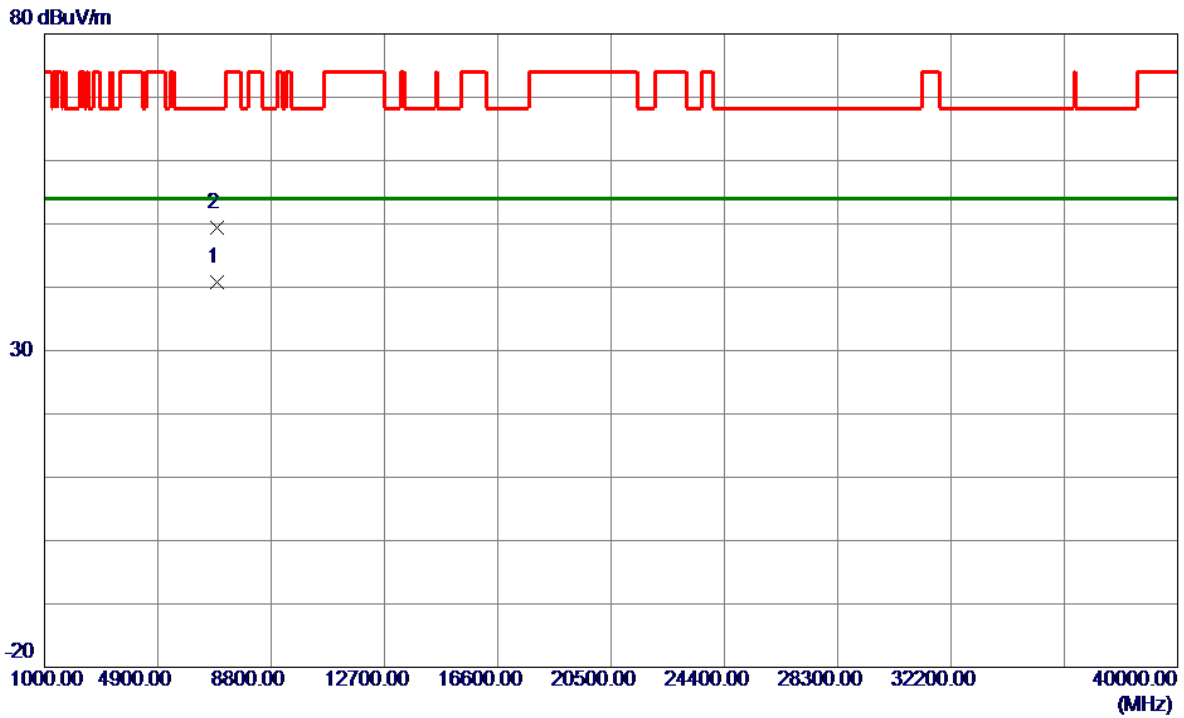

No.	Freq. MHz	Reading Level dBuV/m	Correct Factor dB	Measure ment dBuV/m	Limit dBuV/m	Margin dB	Detector	Comment
1 *	6931.5450	30.83	9.96	40.79	54.00	-13.21	AVG	
2	6933.5200	39.46	9.97	49.43	68.20	-18.77	Peak	

REMARKS:

- (1) Measurement Value = Reading Level + Correct Factor.
- (2) Margin Level = Measurement Value - Limit Value.

Test Mode	UNII-1_TX AC(VHT20) Mode 5200 MHz	Polarization	Horizontal
-----------	-----------------------------------	--------------	------------

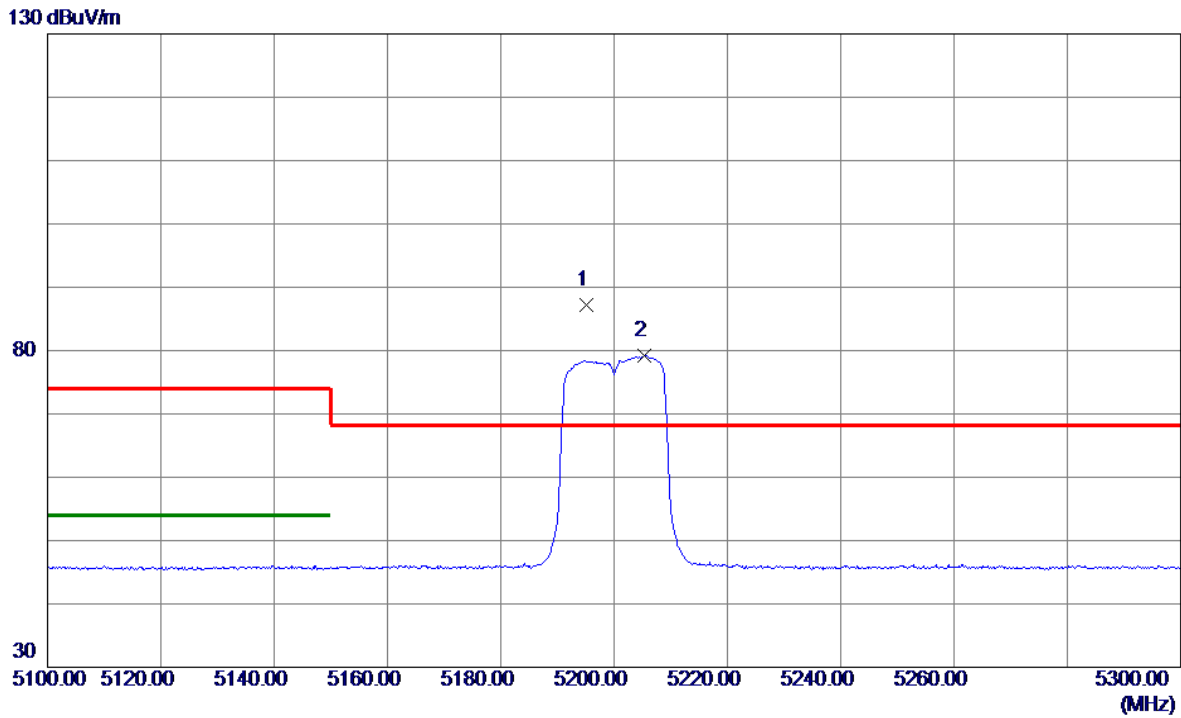

No.	Freq. MHz	Reading Level dBuV/m	Correct Factor dB	Measure ment dBuV/m	Limit dBuV/m	Margin dB	Detector	Comment
1 *	5195.2000	70.94	16.33	87.27	68.20	19.07	Peak	No Limit
2	5205.4000	62.81	16.34	79.15	999.00	-919.85	AVG	No Limit

REMARKS:

- (1) Measurement Value = Reading Level + Correct Factor.
- (2) Margin Level = Measurement Value - Limit Value.

Test Mode	UNII-1_TX AC(VHT20) Mode 5200 MHz	Polarization	Horizontal
-----------	-----------------------------------	--------------	------------

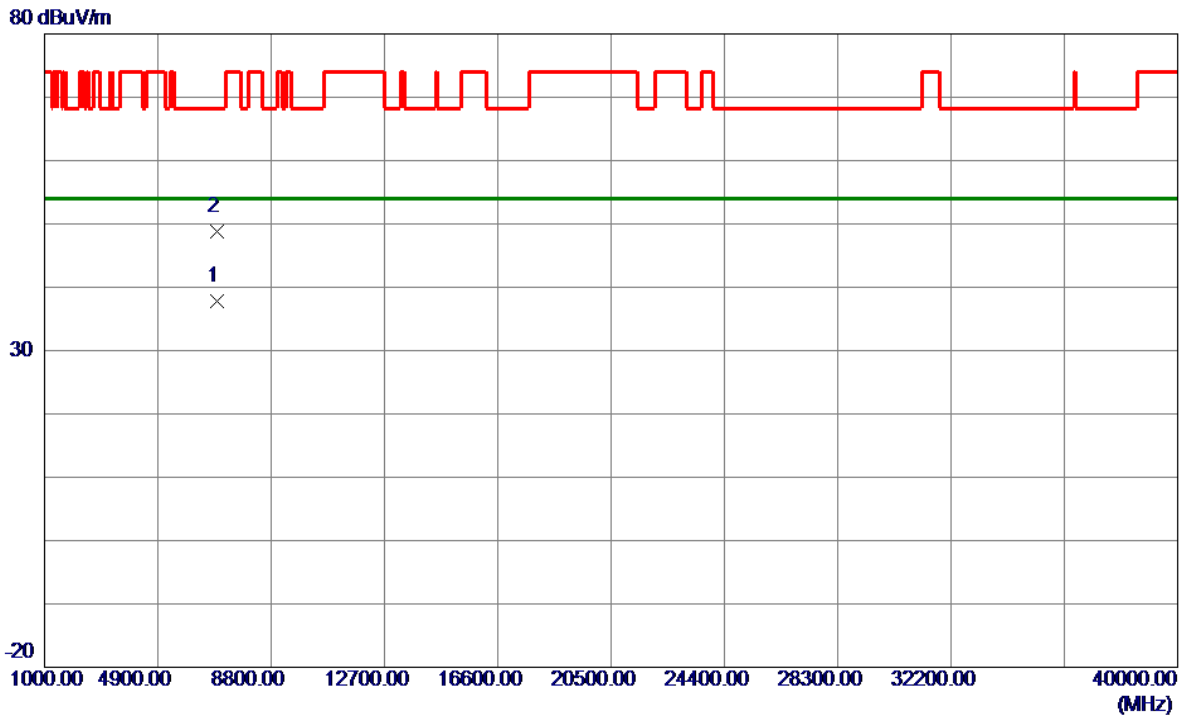

No.	Freq. MHz	Reading Level dBuV/m	Correct Factor dB	Measure ment dBuV/m	Limit dBuV/m	Margin dB	Detector	Comment
1 *	6932.6200	27.92	9.97	37.89	54.00	-16.11	AVG	
2	6932.8150	38.83	9.97	48.80	68.20	-19.40	Peak	

REMARKS:

- (1) Measurement Value = Reading Level + Correct Factor.
- (2) Margin Level = Measurement Value - Limit Value.

Test Mode	UNII-1_TX AC(VHT20) Mode 5240 MHz	Polarization	Vertical
-----------	-----------------------------------	--------------	----------

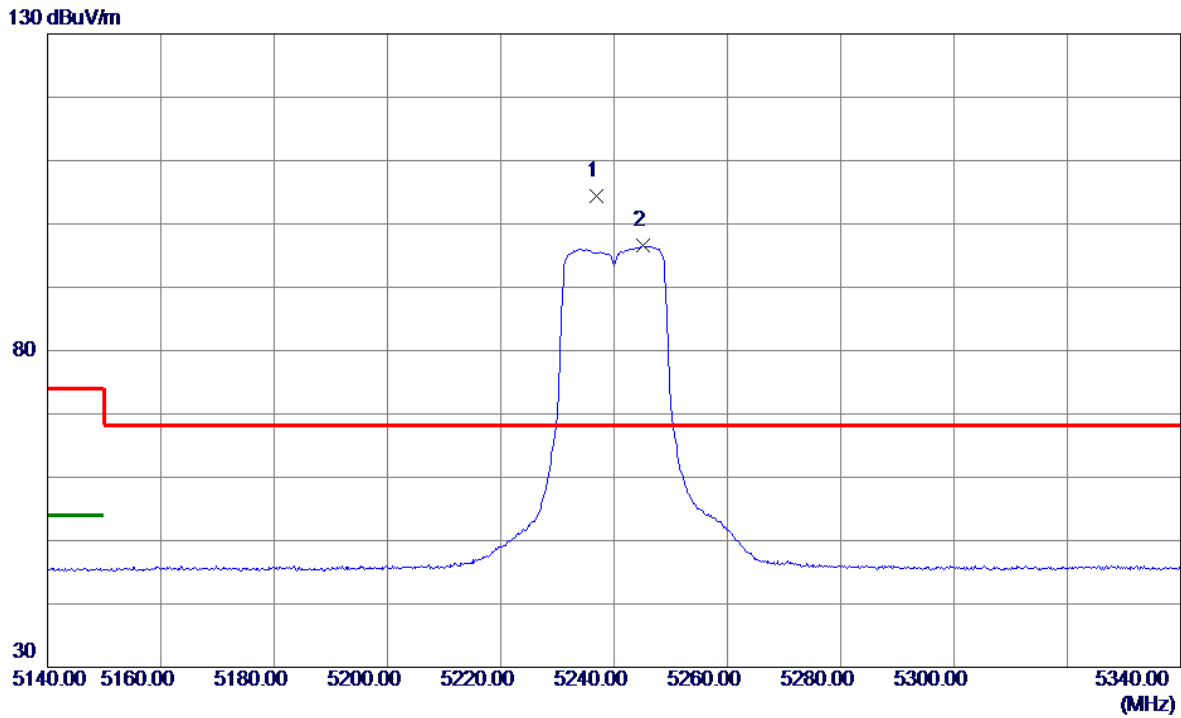

No.	Freq. MHz	Reading Level dBuV/m	Correct Factor dB	Measure ment dBuV/m	Limit dBuV/m	Margin dB	Detector	Comment
1 *	5236.8000	87.94	16.38	104.32	68.20	36.12	Peak	No Limit
2	5245.2000	80.12	16.39	96.51	999.00	-902.49	AVG	No Limit

REMARKS:

- (1) Measurement Value = Reading Level + Correct Factor.
- (2) Margin Level = Measurement Value - Limit Value.

Test Mode	UNII-1_TX AC(VHT20) Mode 5240 MHz	Polarization	Vertical
-----------	-----------------------------------	--------------	----------

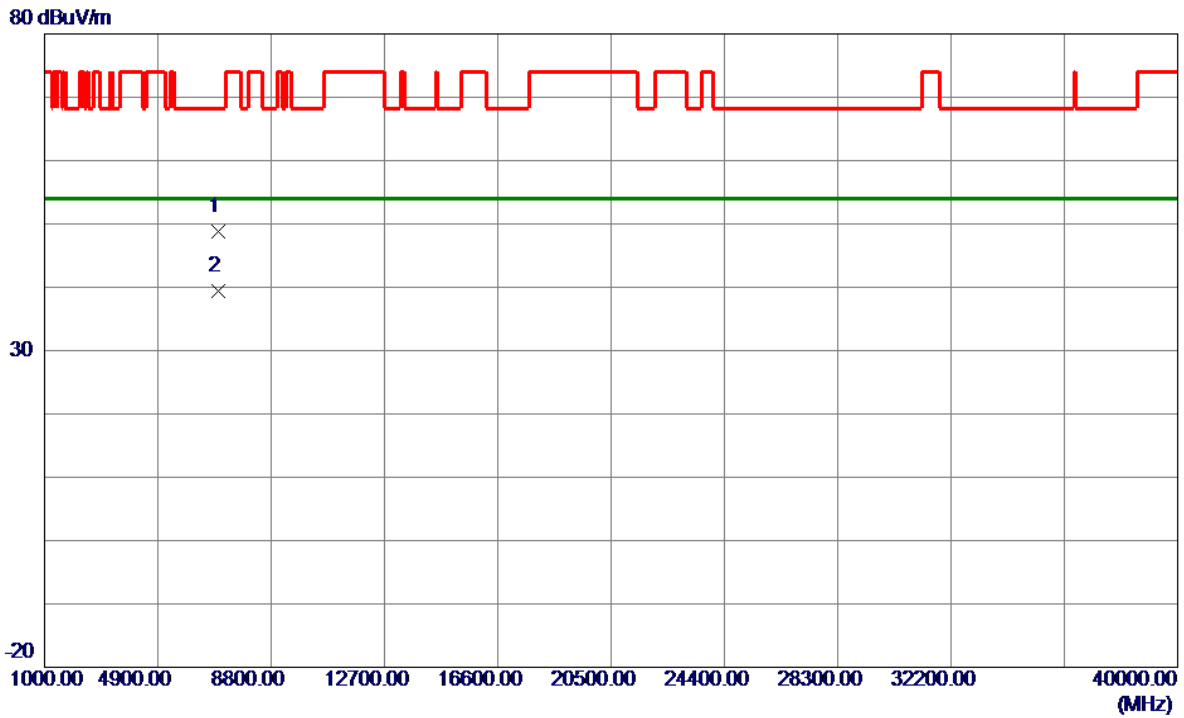

No.	Freq. MHz	Reading Level dBuV/m	Correct Factor dB	Measure ment dBuV/m	Limit dBuV/m	Margin dB	Detector	Comment
1	6984.9950	38.59	10.22	48.81	68.20	-19.39	Peak	
2 *	6986.5100	29.17	10.23	39.40	54.00	-14.60	AVG	

REMARKS:

- (1) Measurement Value = Reading Level + Correct Factor.
- (2) Margin Level = Measurement Value - Limit Value.

Test Mode	UNII-1_TX AC(VHT20) Mode 5240 MHz	Polarization	Horizontal
-----------	-----------------------------------	--------------	------------

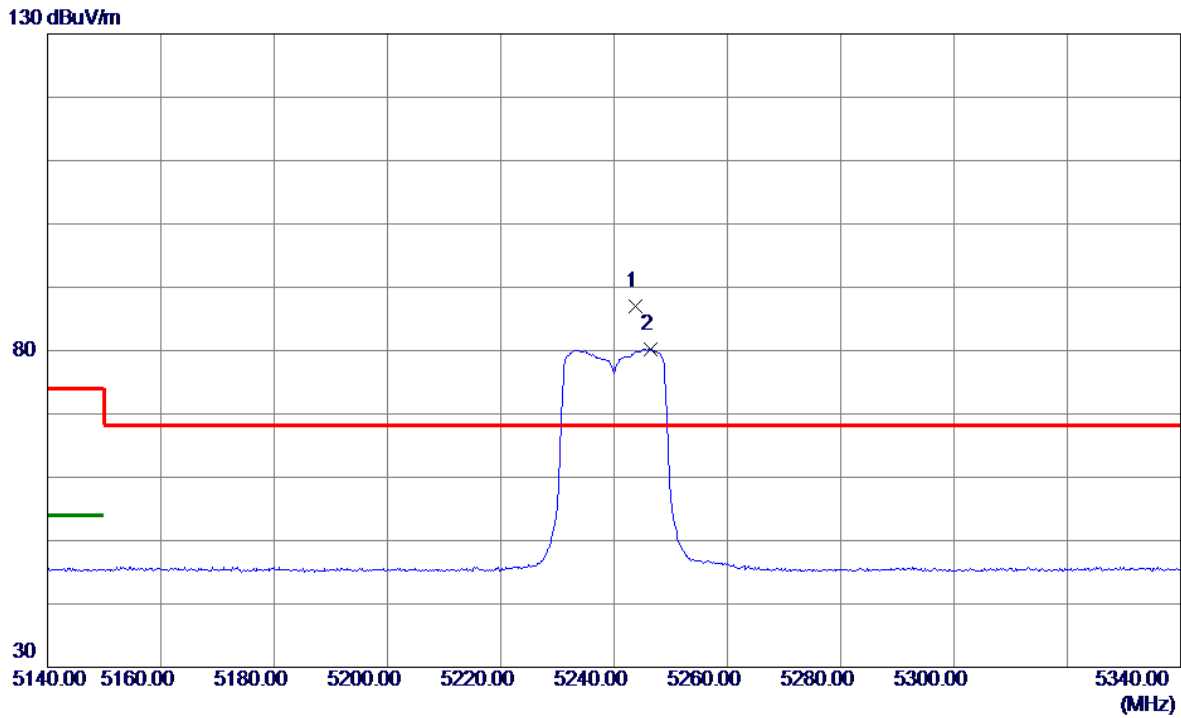

No.	Freq. MHz	Reading Level dBuV/m	Correct Factor dB	Measure ment dBuV/m	Limit dBuV/m	Margin dB	Detector	Comment
1 *	5243.8000	70.68	16.39	87.07	68.20	18.87	Peak	No Limit
2	5246.4000	63.81	16.39	80.20	999.00	-918.80	AVG	No Limit

REMARKS:

- (1) Measurement Value = Reading Level + Correct Factor.
- (2) Margin Level = Measurement Value - Limit Value.

Test Mode	UNII-1_TX AC(VHT20) Mode 5240 MHz	Polarization	Horizontal
-----------	-----------------------------------	--------------	------------

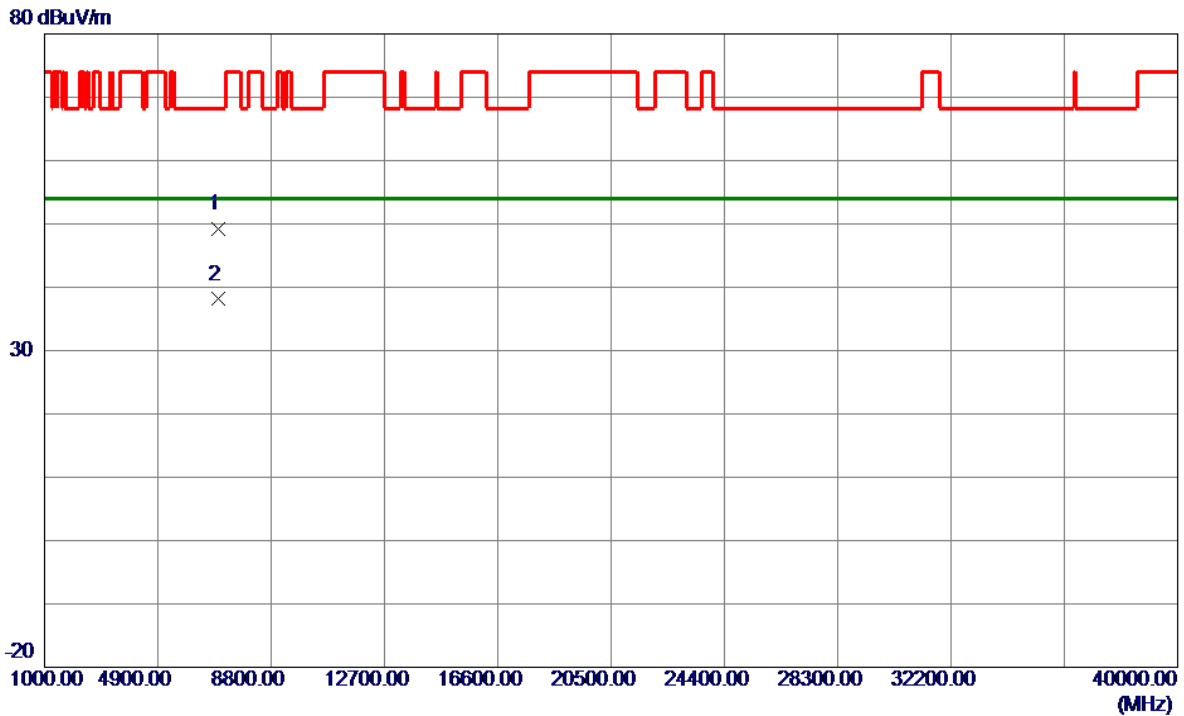

No.	Freq. MHz	Reading Level dBuV/m	Correct Factor dB	Measure ment dBuV/m	Limit dBuV/m	Margin dB	Detector	Comment
1	6984.5500	38.89	10.22	49.11	68.20	-19.09	Peak	
2 *	6985.9800	27.88	10.22	38.10	54.00	-15.90	AVG	

REMARKS:

- (1) Measurement Value = Reading Level + Correct Factor.
- (2) Margin Level = Measurement Value - Limit Value.

Test Mode	UNII-1_TX AC(VHT40) Mode 5190 MHz	Polarization	Vertical
-----------	-----------------------------------	--------------	----------

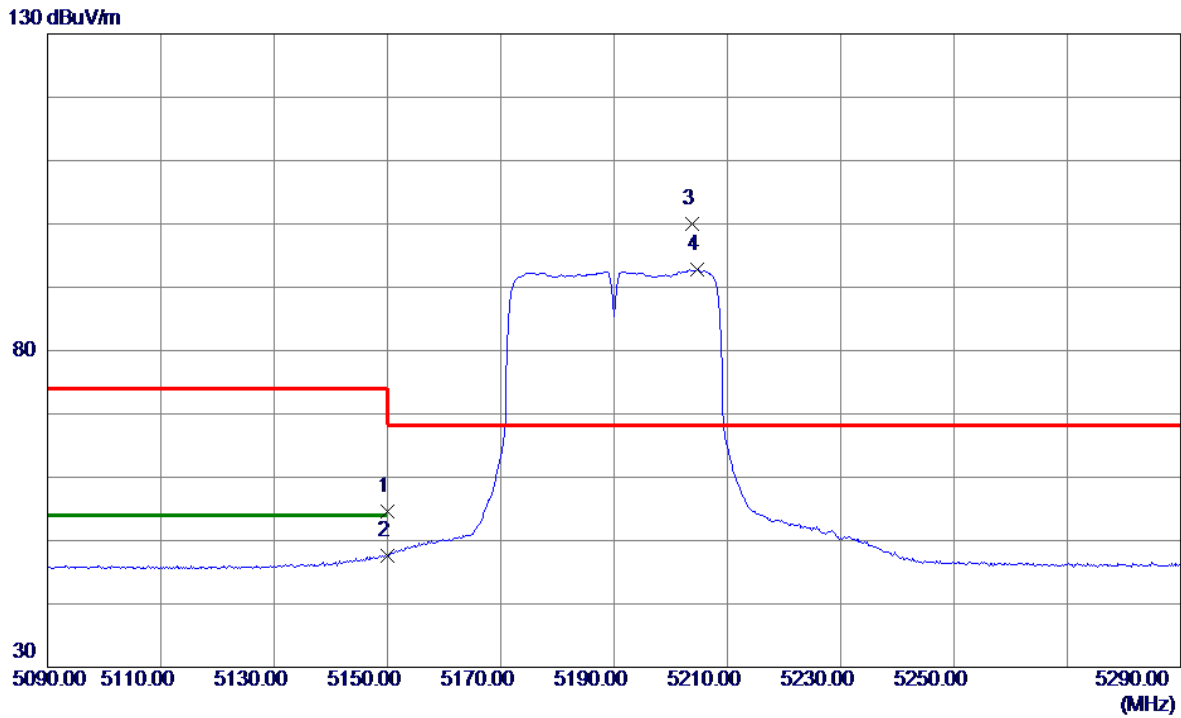

No.	Freq. MHz	Reading Level dBuV/m	Correct Factor dB	Measure ment dBuV/m	Limit dBuV/m	Margin dB	Detector	Comment
1	5150.0000	38.36	16.28	54.64	74.00	-19.36	Peak	
2	5150.0000	31.39	16.28	47.67	54.00	-6.33	AVG	
3 *	5203.8000	83.72	16.34	100.06	68.20	31.86	Peak	No Limit
4	5204.6000	76.40	16.34	92.74	999.00	-906.26	AVG	No Limit

REMARKS:

- (1) Measurement Value = Reading Level + Correct Factor.
- (2) Margin Level = Measurement Value - Limit Value.

Test Mode	UNII-1_TX AC(VHT40) Mode 5190 MHz	Polarization	Vertical
-----------	-----------------------------------	--------------	----------

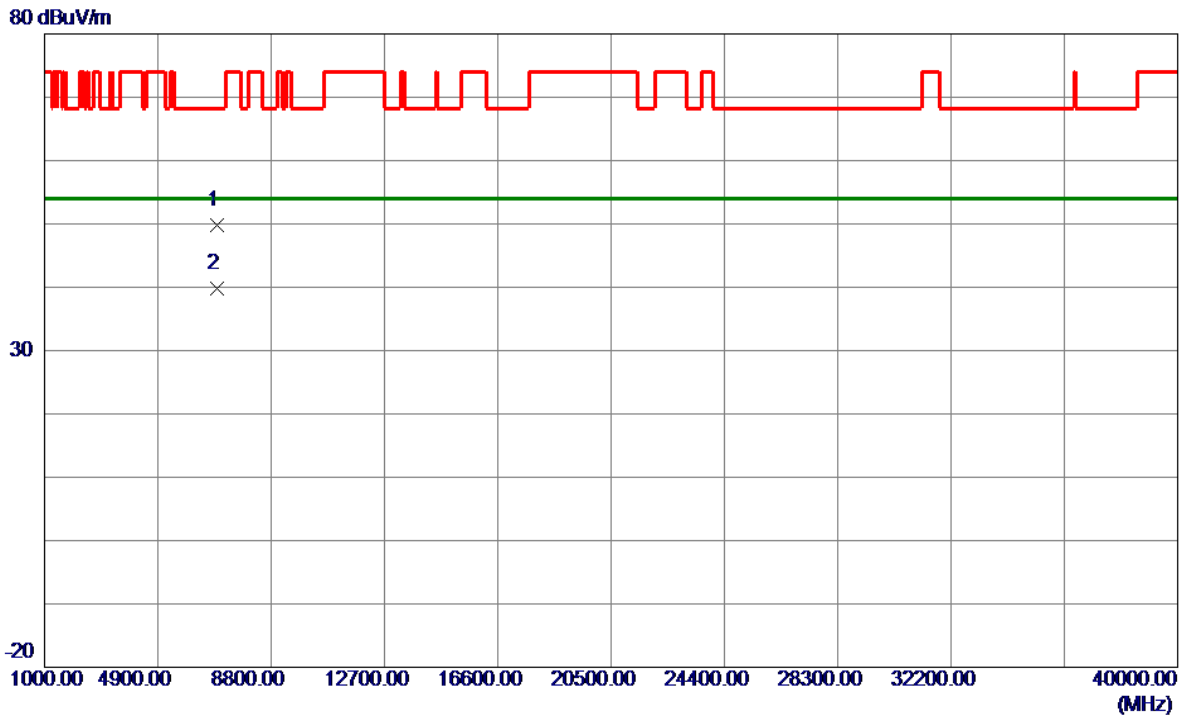

No.	Freq. MHz	Reading Level dBuV/m	Correct Factor dB	Measure ment dBuV/m	Limit dBuV/m	Margin dB	Detector	Comment
1	6917.5400	39.94	9.90	49.84	68.20	-18.36	Peak	
2 *	6922.1050	29.92	9.92	39.84	54.00	-14.16	AVG	

REMARKS:

- (1) Measurement Value = Reading Level + Correct Factor.
- (2) Margin Level = Measurement Value - Limit Value.

Test Mode	UNII-1_TX AC(VHT40) Mode 5190 MHz	Polarization	Horizontal
-----------	-----------------------------------	--------------	------------

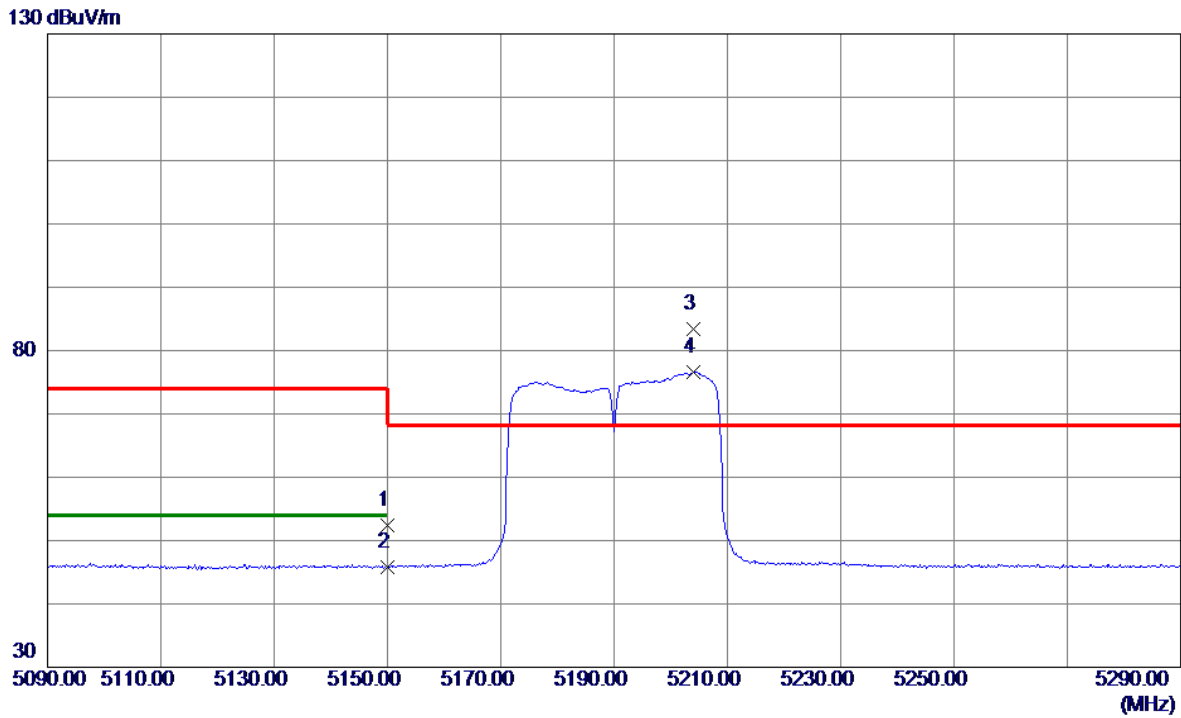

No.	Freq. MHz	Reading Level dBuV/m	Correct Factor dB	Measure ment dBuV/m	Limit dBuV/m	Margin dB	Detector	Comment
1	5150.0000	36.06	16.28	52.34	74.00	-21.66	Peak	
2	5150.0000	29.60	16.28	45.88	54.00	-8.12	AVG	
3 *	5204.0000	67.02	16.34	83.36	68.20	15.16	Peak	No Limit
4	5204.0000	60.30	16.34	76.64	999.00	-922.36	AVG	No Limit

REMARKS:

- (1) Measurement Value = Reading Level + Correct Factor.
- (2) Margin Level = Measurement Value - Limit Value.

Test Mode	UNII-1_TX AC(VHT40) Mode 5190 MHz	Polarization	Horizontal
-----------	-----------------------------------	--------------	------------

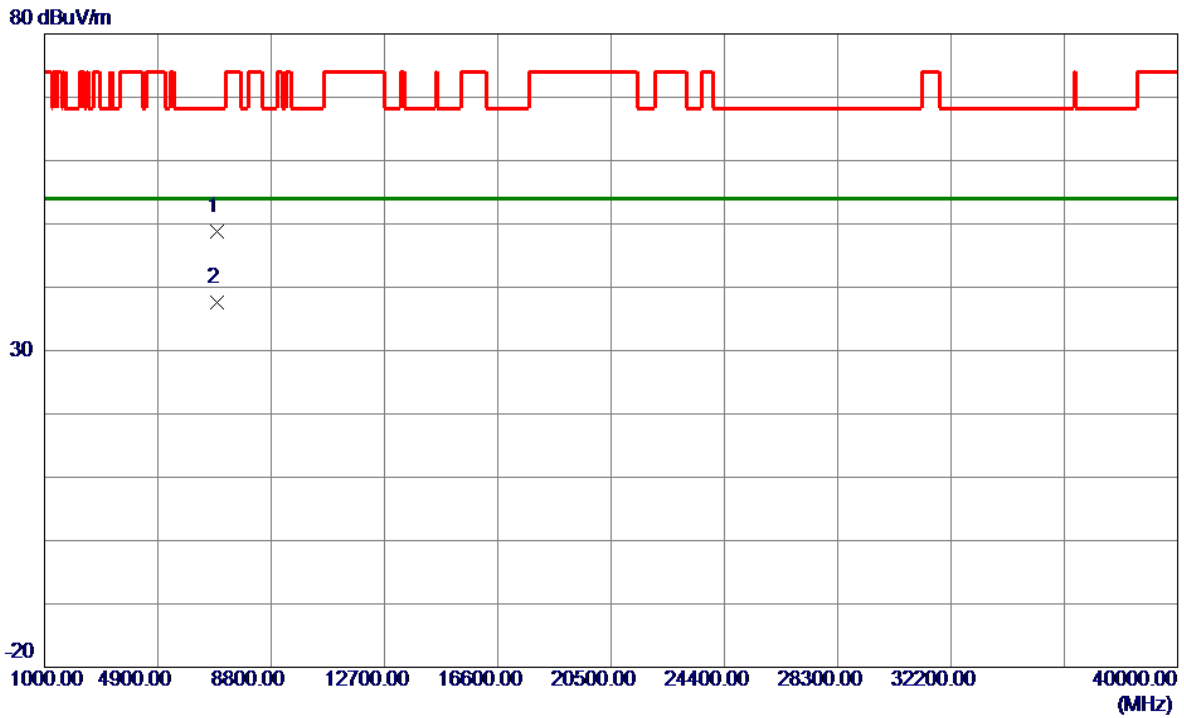

No.	Freq. MHz	Reading Level dBuV/m	Correct Factor dB	Measure ment dBuV/m	Limit dBuV/m	Margin dB	Detector	Comment
1	6918.2150	38.81	9.90	48.71	68.20	-19.49	Peak	
2 *	6920.9050	27.76	9.91	37.67	54.00	-16.33	AVG	

REMARKS:

- (1) Measurement Value = Reading Level + Correct Factor.
- (2) Margin Level = Measurement Value - Limit Value.

Test Mode	UNII-1_TX AC(VHT40) Mode 5230 MHz	Polarization	Vertical
-----------	-----------------------------------	--------------	----------

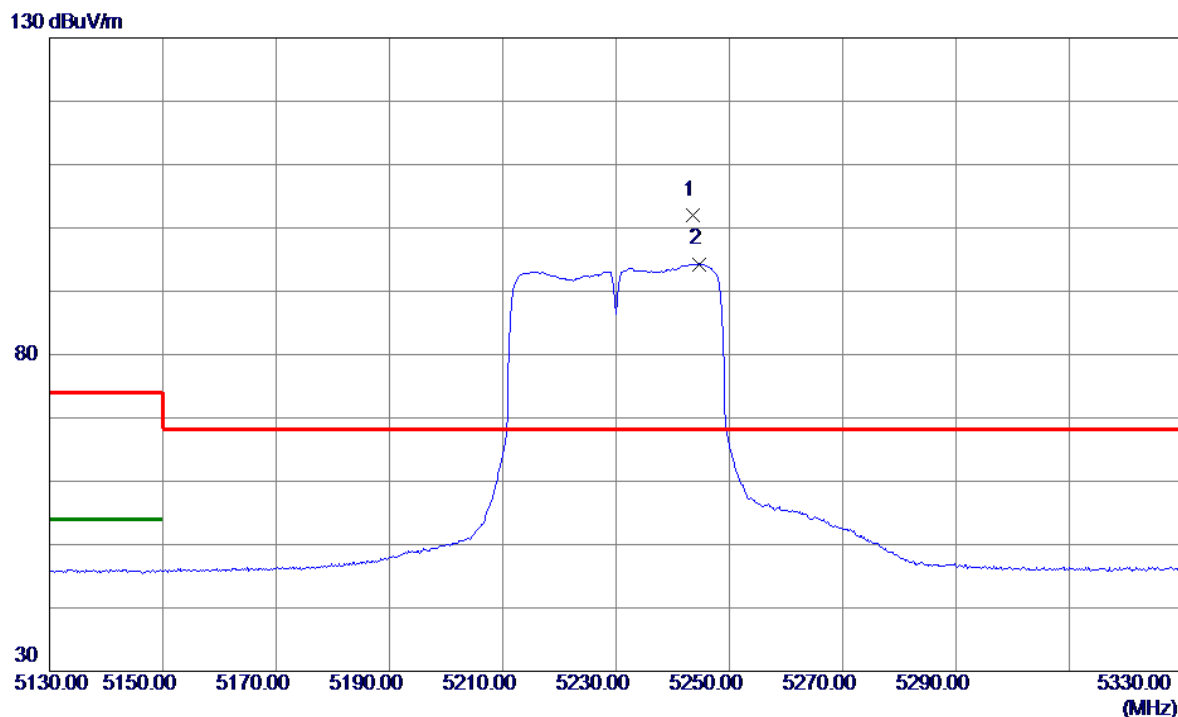

No.	Freq. MHz	Reading Level dBuV/m	Correct Factor dB	Measure ment dBuV/m	Limit dBuV/m	Margin dB	Detector	Comment
1 *	5243.6000	85.62	16.39	102.01	68.20	33.81	Peak	No Limit
2	5244.6000	77.91	16.39	94.30	999.00	-904.70	AVG	No Limit

REMARKS:

- (1) Measurement Value = Reading Level + Correct Factor.
- (2) Margin Level = Measurement Value - Limit Value.

Test Mode	UNII-1_TX AC(VHT40) Mode 5230 MHz	Polarization	Vertical
-----------	-----------------------------------	--------------	----------

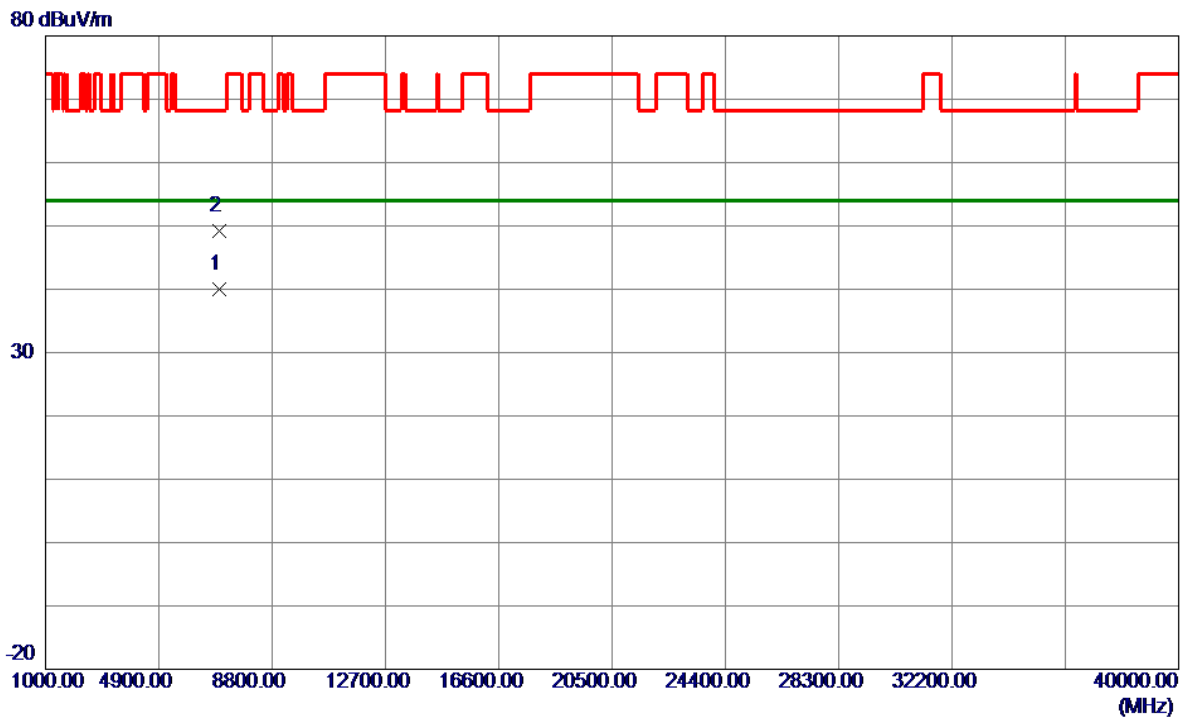

No.	Freq. MHz	Reading Level dBuV/m	Correct Factor dB	Measure ment dBuV/m	Limit dBuV/m	Margin dB	Detector	Comment
1 *	6972.3300	29.89	10.16	40.05	54.00	-13.95	AVG	
2	6972.6700	39.12	10.16	49.28	68.20	-18.92	Peak	

REMARKS:

- (1) Measurement Value = Reading Level + Correct Factor.
- (2) Margin Level = Measurement Value - Limit Value.

Test Mode	UNII-1_TX AC(VHT40) Mode 5230 MHz	Polarization	Horizontal
-----------	-----------------------------------	--------------	------------

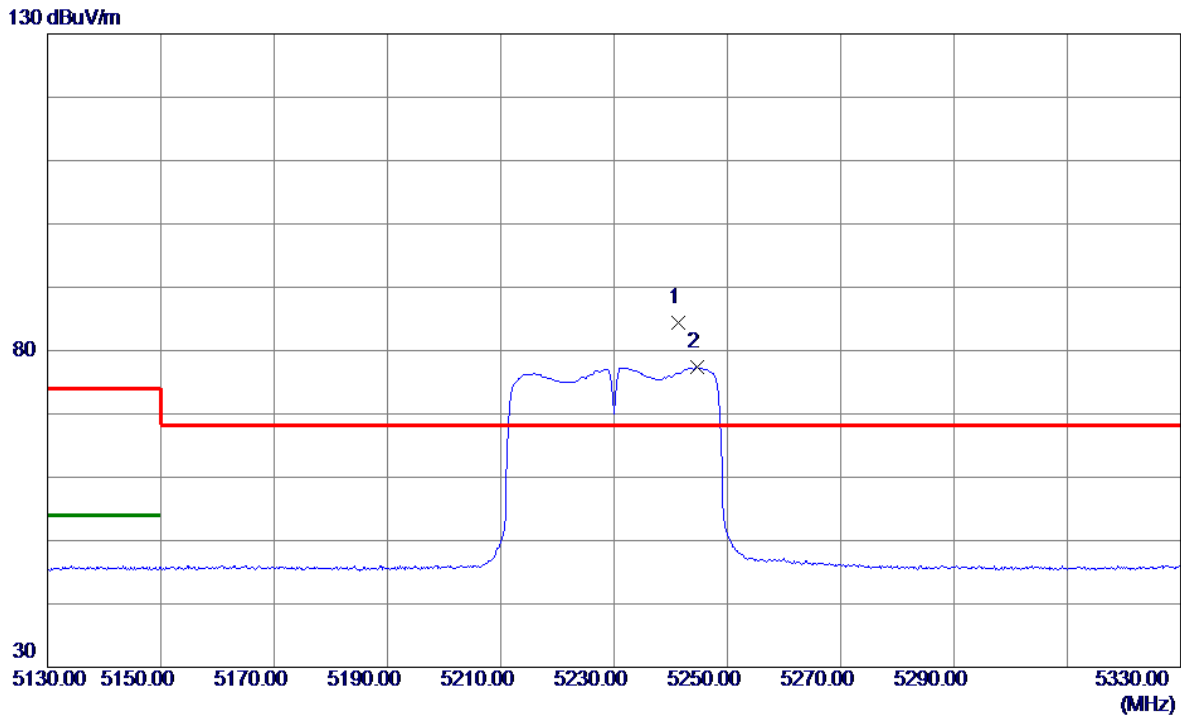

No.	Freq. MHz	Reading Level dBuV/m	Correct Factor dB	Measure ment dBuV/m	Limit dBuV/m	Margin dB	Detector	Comment
1 *	5241.4000	68.00	16.38	84.38	68.20	16.18	Peak	No Limit
2	5244.6000	60.93	16.39	77.32	999.00	-921.68	AVG	No Limit

REMARKS:

- (1) Measurement Value = Reading Level + Correct Factor.
- (2) Margin Level = Measurement Value - Limit Value.

Test Mode	UNII-1_TX AC(VHT40) Mode 5230 MHz	Polarization	Horizontal
-----------	-----------------------------------	--------------	------------

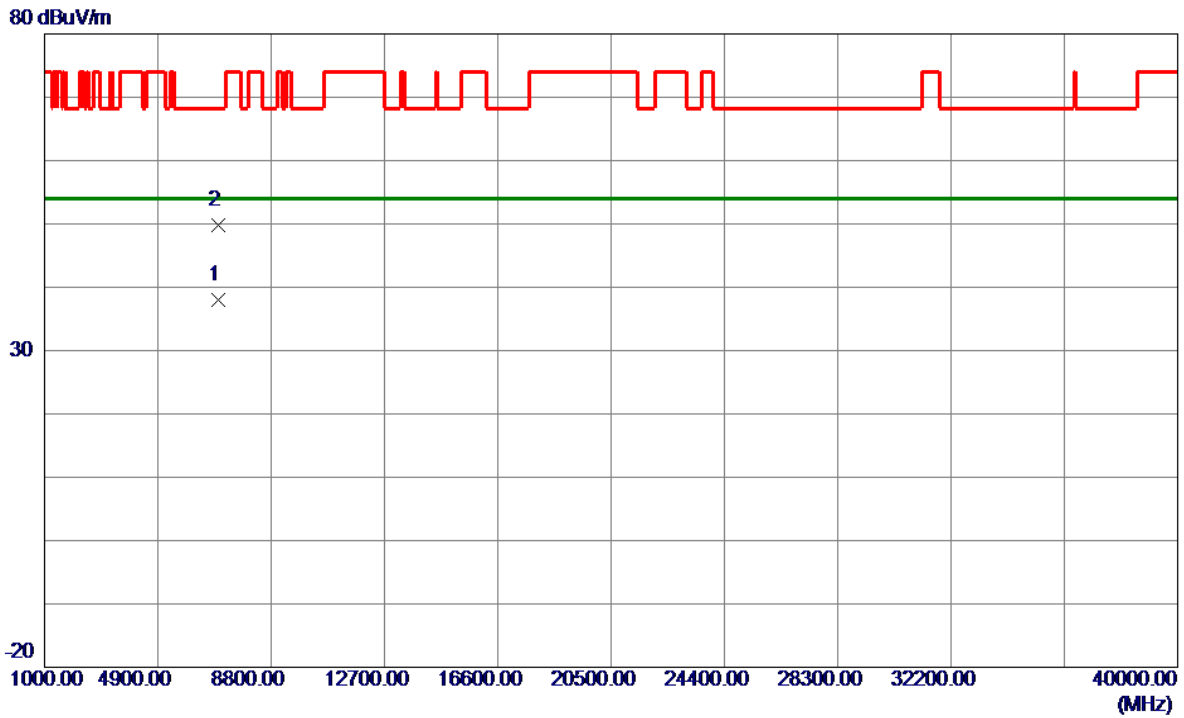

No.	Freq. MHz	Reading Level dBuV/m	Correct Factor dB	Measure ment dBuV/m	Limit dBuV/m	Margin dB	Detector	Comment
1 *	6972.5100	27.86	10.16	38.02	54.00	-15.98	AVG	
2	6974.0100	39.54	10.17	49.71	68.20	-18.49	Peak	

REMARKS:

- (1) Measurement Value = Reading Level + Correct Factor.
- (2) Margin Level = Measurement Value - Limit Value.