

# PHILIPS

## Soundbar

8000 Series

TAB8507

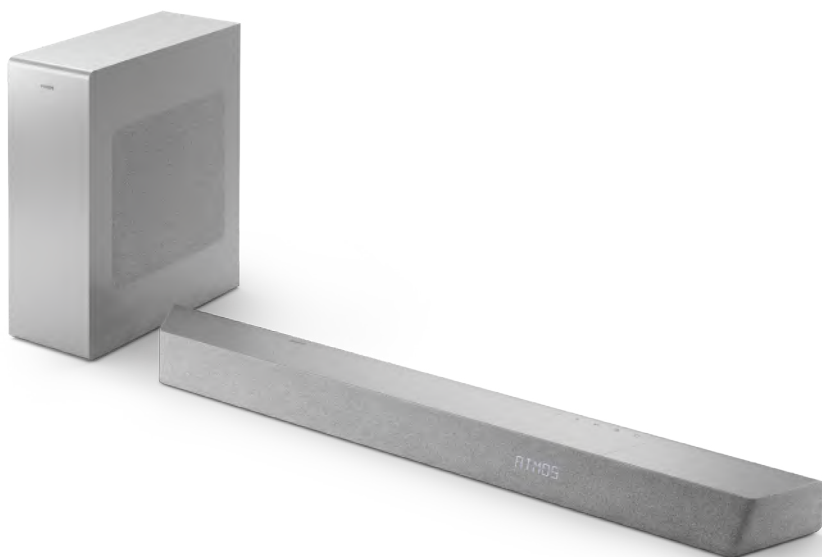

# User manual

Register your product and get support at  
[www.philips.com/support](http://www.philips.com/support)

# Contents

---

<b>1</b>	<b>Important safety instructions</b>	<b>3</b>
	Safety	3
	Care for your product	4
	Care of the environment	4
	Declaration of conformity	5
	Help and support	5
	FCC information	6

---

<b>2</b>	<b>Your Soundbar</b>	<b>7</b>
	What's in the box	7
	Soundbar	7
	Connectors	8
	Wireless subwoofer	9
	Remote control	9
	Prepare the remote control	10
	Placement	11
	Wall mount	11

---

<b>3</b>	<b>Connect</b>	<b>12</b>
	Dolby Atmos®	12
	Connect to HDMI socket	13
	Connect to Optical socket	14
	Connect to Audio in socket	14
	Connect to power	14
	Pair up with the subwoofer	14
	Connect to Wi-Fi	
	(Wireless operation)	15
	Connect the soundbar to Philips	
	Play-fi enabled TV	18

---

<b>4</b>	<b>Use your soundbar</b>	<b>19</b>
	Turn ON and OFF	19
	Select modes	19
	Adjust the volume	19
	Enjoy Dolby Atmos sound	20
	Setup menu	20
	Play from Bluetooth devices	22
	Listen to an external device	23
	Play audio through USB	24
	Factory reset	24

---

<b>5</b>	<b>Product specifications</b>	<b>25</b>
----------	-------------------------------	-----------

---

<b>6</b>	<b>Troubleshooting</b>	<b>27</b>
	Trademarks:	29

# 1 Important safety instructions

Read and understand all instructions before you use your product. If damage is caused by failure to follow instructions, the warranty does not apply.

## Safety

### Know these safety symbols



This is **CLASS II** apparatus with **double insulation**, and **no protective earth** provided.



AC voltage



Follow the instructions in the user manual!



**WARNING!**  
Warning: Risk of electric shock!



The exclamation mark is intended to alert the user to the presence of important operating instructions.

### Risk of electric shock or fire!

- Before you make or change any connections, make sure that all devices are disconnected from the power outlet.
- Never expose the product and accessories to rain or water. Never place liquid containers, such as vases, near the product. If liquids are spilt on

or into the product, disconnect it from the power outlet immediately. Contact Consumer Care to have the product checked before use.

- Never place the product and accessories near naked flames or other heat sources, including direct sunlight.
- Never insert objects into the ventilation slots or other openings on the product.
- Where the mains plug or an appliance coupler is used as the disconnect device, the disconnect device shall remain readily operable.
- Battery (battery pack or batteries installed) shall not be exposed to excessive heat such as sunshine, fire or the like.
- Disconnect the product from the power outlet before lightning storms.
- When you disconnect the power cord, always pull the plug, never the cable.
- Use the product in tropical and/or moderate climates.

### Risk of short circuit or fire!

- For identification and supply ratings, see the type plate at the back or bottom of the product.
- Before you connect the product to the power outlet, ensure that the power voltage matches the value printed on the back or bottom of the product. Never connect the product to the power outlet if the voltage is different.

### Risk of injury or damage to this product!

- For wall mounting, this product must be securely attached to the wall in accordance with the installation instructions. Use only the supplied wall mount bracket (if available). Improper wall mounting may result in accident, injury or damage. If you have any query, contact Consumer Care in your country.

- Never place the product or any objects on power cords or on other electrical equipment.
- If the product is transported in temperatures below 5°C, unpack the product and wait until its temperature matches room temperature before connecting it to the power outlet.
- Parts of this product can be made of glass. Handle with care to avoid injury and damage.

### Risk of overheating!

- Never install this product in a confined space. Always leave a space of at least four inches around the product for ventilation. Ensure curtains or other objects never cover the ventilation slots on the product.

### Risk of contamination!

- Do not mix batteries (old and new or carbon and alkaline, etc.).
- Replace only with the same or equivalent type.
- Remove batteries if they are exhausted or if the remote control is not to be used for a long time.
- Batteries contain chemical substances, they should be disposed of properly.



**CAUTION:** Risk of explosion if the battery is replaced by an incorrect type.

**Mise en garde:** risque d'explosion si la batterie est déplacée par un mauvais type.



### Note

- The rating label is pasted on the bottom or back of the equipment.

## Care for your product

Use only microfiber cloth to clean the product.

## Care of the environment

### Disposal of your old product and battery



Your product is designed and manufactured with high quality materials and components, which can be recycled and reused.



This symbol on a product means that the product is covered by European Directive 2012/19/EU.



This symbol means that the product contains batteries covered by European Directive 2013/56/EU which cannot be disposed of with normal household waste.

Inform yourself about the local separate collection system for electrical and electronic products and batteries. Follow local rules and never dispose of the product and batteries with normal household waste. Correct disposal of old products and batteries helps prevent negative consequences for the environment and human health.

### Removing the disposable batteries

To remove the disposable batteries, see battery installation section.

	AT	BE	BG	HR	CY	CZ	DK
	EE	FI	FR	DE	EL	HU	IE
	IT	LV	LT	LU	MT	NL	PL
	PT	RO	SK	SI	ES	SE	UK(NI)
UK							

### EN For 5G Wi-Fi Device

The device for operation in the band 5150–5350 MHz is only for indoor use to reduce the potential for harmful interference to co-channel mobile satellite systems.

### FR Pour un appareil Wi-Fi 5G

les dispositifs fonctionnant dans la bande 5150-5250 MHz sont réservés uniquement pour une utilisation à l'intérieur afin de réduire les risques de brouillage préjudiciable aux systèmes de satellites mobiles utilisant les mêmes canaux.

## Declaration of conformity

This product complies with the radio interference requirements of the European community.

Hereby, MMD Hong Kong Holding Limited declares that the product is in compliance with the essential requirements and other relevant provisions of RED Directive 2014/53/EU and UK Radio Equipment Regulations SI 2017 No 1206. You can find the Declaration of Conformity on [www.philips.com/support](http://www.philips.com/support).

## Help and support

For extensive online support, visit [www.philips.com/support](http://www.philips.com/support) to:

- download the user manual and the quick start guide
- watch video tutorials (available only for selected models)
- find answers to frequently answered questions (FAQs)
- email us a question
- chat with our support representative.

Follow the instructions on the website to select your language, and then enter your product model number.

Alternatively, you can contact Consumer Care in your country. Before you contact, note down the model number and serial number of your product. You can find this information on the back or bottom of your product.

---

## FCC information

**NOTE:** This equipment has been tested and found to comply with the limits for a Class B digital device, pursuant to Part 15 of the FCC Rules. These limits are designed to provide reasonable protection against harmful interference in a residential installation. This equipment generates, uses and can radiate radio frequency energy and, if not installed and used in accordance with the instructions, may cause harmful interference to radio communications.

However, there is no guarantee that interference will not occur in a particular installation. If this equipment does cause harmful interference to radio or television reception, which can be determined by turning the equipment off and on, the user is encouraged to try to correct the interference by one or more of the following measures:

- Reorient or relocate the receiving antenna.
- Increase the separation between the equipment and receiver.
- Connect the equipment into an outlet on a circuit different from that to which the receiver is connected.
- Consult the dealer or an experienced radio / TV technician for help.

---

### FCC&IC Warning:

- This equipment should be installed and operated with minimum distance 20cm between the radiator & your body.
- Changes or modifications to this unit not expressly approved by the party responsible for compliance could void the user's authority to operate the equipment.

---

## FCC & IC Attention

- Cet appareil est conforme à FCC et IC l'exposition aux rayonnements limites fixées pour un environnement non contrôlé. Cet appareil doit être installé et utilisé avec une distance minimale de 20 cm entre le radiateur et votre corps. Cet transmetteur ne doit pas être co-situé ou opérant en liaison avec toute autre antenne ou transmetteur.
- Des câbles blindés doivent être utilisés avec cet appareil I pour assurer la conformité avec les limites de la classe B de la FCC. fonctionnement de l'appareil.

---

### IC-Canada: CAN ICES-003(B)/NMB-003(B)

This device contains licence-exempt transmitter(s) / receiver(s) that comply with Innovation, Science and Economic Development Canada's licence-exempt RSS(s). Operation is subject to the following two conditions:

1. This device may not cause interference.
2. This device must accept any interference, including interference that may cause undesired operation of the device.

---

### Avis d'Industrie Canada: CAN ICES-003(B)/NMB-003(B)

L'émetteur/récepteur exempt de licence contenu dans le présent appareil est conforme aux CNR d'Innovation, Sciences et Développement économique Canada applicables aux appareils radio exempts de licence. L'exploitation est autorisée aux deux conditions suivantes :

1. L'appareil ne doit pas produire de brouillage;
2. L'appareil doit accepter tout brouillage radioélectrique subi, même si le brouillage est susceptible d'en compromettre le fonctionnement.

# 2 Your Soundbar

Congratulations on your purchase, and welcome to Philips! To fully benefit from the support that Philips offers, register your soundbar at [www.philips.com/support](http://www.philips.com/support).

## What's in the box

Check and identify the items in the package:

- Soundbar x 1
- Remote control x 1  
(AAA batteries x 2)
- Wireless subwoofer x 1
- Wall mount kit x 1  
(Brackets x2 / Bracket screws x2 / Wall mounting screws x2 / Wall anchors x2)
- Quick start guide / Warranty card / Safety sheet x 1
- Wall mount template x 1
- Power cord\*

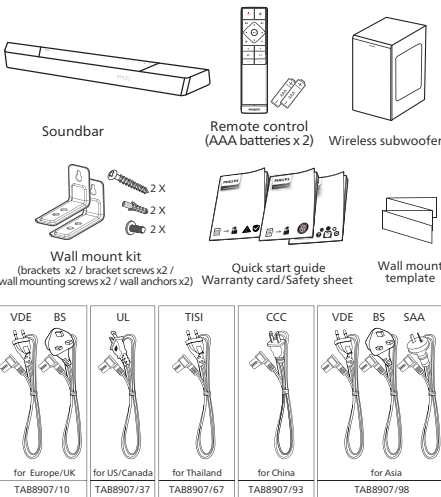

- Power cord quantity and plug type vary by regions.
- Images, illustrations and drawings shown on this User Manual are for reference only, actual product may vary in appearance.

## Soundbar

This section includes an overview of the soundbar.

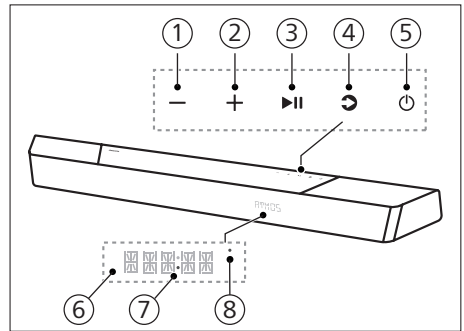

- ① - **(Volume) button**  
Decrease the volume.
- ② **+ (Volume) button**  
Increase the volume.
- ③ **▶|| (Play/Pause) button**  
Toggle play/pause in USB/BT/Play-Fi.
- ④ **⌂ (Source)/Bluetooth pairing button**
  - Press to select an input source for soundbar.
  - Press and hold for 3 seconds to enter the Bluetooth pairing mode.

## ⑤ ⏻ (Standby-On) button

Power state	Action	Function
On		Follow source state
Semi standby	Press the ⏻ button once	<ul style="list-style-type: none"> <li>• Wi-Fi is connected.</li> <li>• It supports Play-fi and Airplay2 Chromecast, Spotify connect, work with Alexa.</li> </ul>
Eco standby	Press and hold ⏻ 3 seconds	<ul style="list-style-type: none"> <li>• Wi-Fi is off.</li> <li>• The product enters the lower power consumption mode.</li> <li>• Restarting the system will take a relatively longer time.</li> </ul>

## ⑥ Remote control sensor / Display panel

### ⑦ Power LED

- Turns white when in Eco standby (network disconnected).

### ⑧ Wi-Fi LED

Wi-Fi LED indicator (Orange)

LED State	Status
Blink	Wi-Fi Access Point (AP) mode
Double blink	Wi-Fi Protected Setup (WPS) mode
Constant on	Connected / Pairing successful

## Connectors

This section includes an overview of the connectors available on your soundbar.

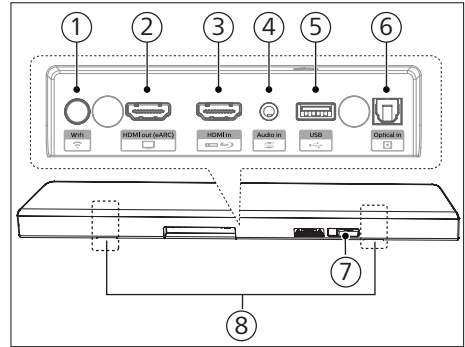

### ① 📶 (Wi-Fi Setup) button

- Trigger Wi-Fi setup for Play-fi.
- Press and hold the button for 4 seconds to active the Wps mode.
- Press and hold the button for 8 seconds to active the AP mode.

### ② HDMI out (eARC) socket

The port supports the eARC/ARC HDMI feature, connect to the HDMI (eARC) input on the TV.

### ③ HDMI in socket

Connect to an HDMI source device, such as a DVD player, Blu-ray Disc™ player, or gaming console.

### ④ Audio in

Audio input from, for example, an MP3 player (3.5mm jack).

### ⑤ USB

- Connect to a USB storage device for audio media play.
- Upgrade software of this product.

### ⑥ Optical in socket

Connect to an optical audio output on the TV or a digital device.

### ⑦ AC in ~ socket

Connect to the power supply.

### ⑧ Wall bracket slot



## Wireless subwoofer

This section includes an overview of the wireless subwoofer.

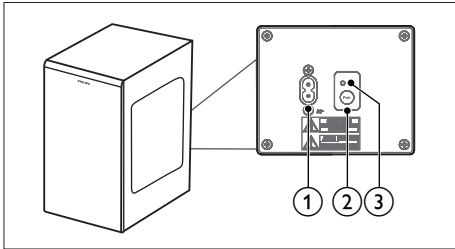

- ① **AC~ socket**  
Connect to the power supply.
- ② **Pair button**  
Press and hold to enter the pairing mode for the subwoofer.
- ③ **Subwoofer indicator**  
Determine the status based on the wireless subwoofer indicator.

LED state	Status
Fast blink	Subwoofer in pairing mode
Constant on	Connected / Pairing successful
Slow blink	Connection / Pairing failed

## Remote control

This section includes an overview of the remote control.

- ① **⏻ (Standby-On) button**

Power state	Action	Function
On		Follow source state
Semi standby	Press the ⏻ button once	<ul style="list-style-type: none"> <li>• Wi-Fi is connected.</li> <li>• It supports Play-fi and Airplay2 Chromecast, Spotify connect, work with Alexa.</li> </ul>
Eco standby	Press and hold ⏻ 3 seconds	<ul style="list-style-type: none"> <li>• Wi-Fi is off.</li> <li>• The product enters the lower power consumption mode.</li> <li>• Restarting the system will take a relatively longer time.</li> </ul>

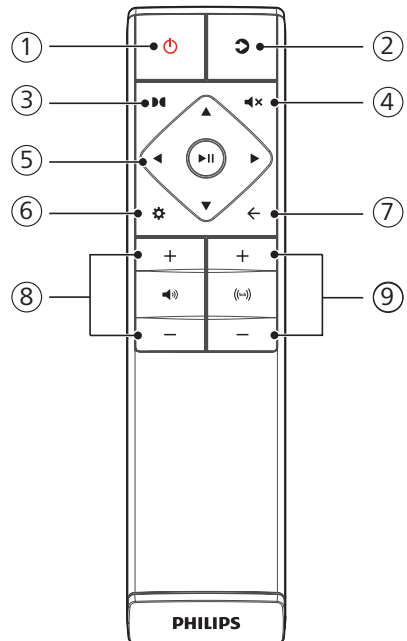

- ② **Source**
  - Press to select an input source for soundbar.
  - Press and hold for 3 seconds to enter the Bluetooth pairing mode.
- ③ **Dolby Atmos**  
Select a height effect level for Dolby Atmos.
- ④ **Mute**  
Mute or restore volume.
- ⑤ **Navigation buttons**
  - Left/Right**
    - Skip to the previous or next track in USB/BT mode.
    - Navigate Left/Right in menu structure.
  - Up/Down**
    - Navigate up/down in menu structure.
  - Center**
    - Start, pause or resume play in USB/BT mode.
- ⑥ **MENU**  
Enter setup menu.
- ⑦ **Exit**
  - Exit menu.
  - Press and hold the button for 10 seconds to reset the Wi-Fi module of soundbar to factory settings.
- ⑧ **Soundbar's volume**  
Increase / decrease the soundbar's volume.
- ⑨ **Subwoofer's volume**  
Increase / decrease the subwoofer's volume.

- Even if the remote control is operated within the effective range 19.7 feet (6m), remote control operation may be impossible if there are any obstacles between the unit and the remote control.
- If the remote control is operated near other products which generate infrared rays, or if other remote control devices using infra-red rays are used near the unit, it may operate incorrectly. Conversely, the other products may operate incorrectly.

---

### Replace the remote control battery

Slide to remove the battery compartment cover, insert 2 AAA batteries (1.5V) with correct polarity, then slide the battery compartment cover back into position.

- Make sure the (+) and (-) ends of the batteries match the (+) and (-) ends indicated in the battery compartment.

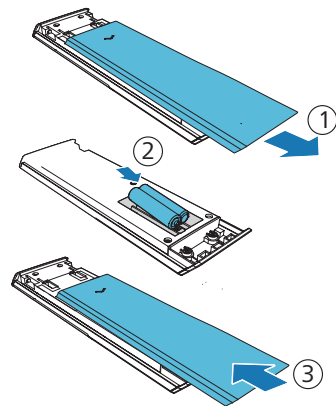

---

### Prepare the remote control

- The provided remote control allows the unit to be operated from a distance.

---

### Precautions concerning batteries

- Be sure to insert the batteries with correct positive "⊕" and negative "⊖" polarities.

- Use batteries of the same type. Never use different types of batteries together.
- Either rechargeable or non-rechargeable batteries can be used. Refer to the precautions on their labels.
- Be aware of your fingernails when removing the battery cover and the battery.
- Do not drop the remote control.
- Do not allow anything to impact the remote control.
- Do not spill water or any liquid on the remote control.
- Do not place the remote control on a wet object.
- Do not place the remote control under direct sunlight or near sources of excessive heat.
- Remove the battery from the remote control when not in use for a long period of time, as corrosion or battery leakage may occur and result in physical injury, and/or property damage, and/or fire.
- Do not use any batteries other than those specified.
- Do not mix new batteries with old ones.
- Never recharge a battery unless it is confirmed to be a rechargeable type.

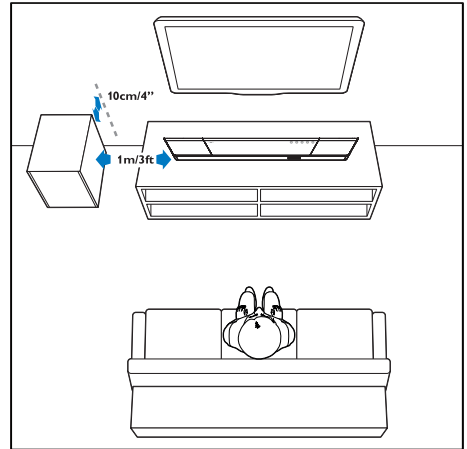

## Placement

Place the subwoofer at least 1 meter (3 feet) away from your soundbar, and 10 centimeters away from the wall.

For best results, place your subwoofer as shown below.

## Wall mount

### Note

- Improper wall mounting may result in accident, injury or damage. If you have any query, contact Consumer Care in your country.
- Before wall mounting, make sure the wall can support the weight of your soundbar.
- Before wall mounting, you need not remove the rubber feet at the bottom of the soundbar, otherwise the rubber feet cannot be fixed back.
- Depending on the type of wall mounting, make sure that you use screws of a suitable length and diameter.
- Please check whether the USB port on the back of the soundbar is connected to a USB device. If it is found that the connected USB device affects the wall-mount, you need to use another USB device of the appropriate size.

### Screw length/diameter

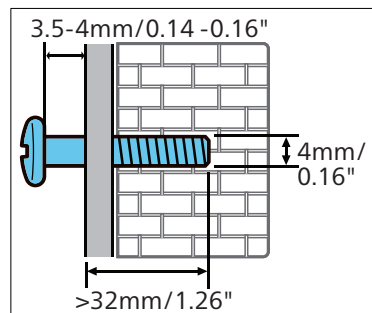

## Suggested wall mounting height

You are recommended to install the TV first before wall mounting the soundbar. With a TV preinstalled, wall mount the soundbar 50mm/2.0" in distance from the bottom of the TV.



### WARNING!

- To prevent injury, this apparatus must be securely attached to the floor/wall in accordance with the installation instructions.
- Suggested wall mounting height:  $\leq 1.5$  meters.

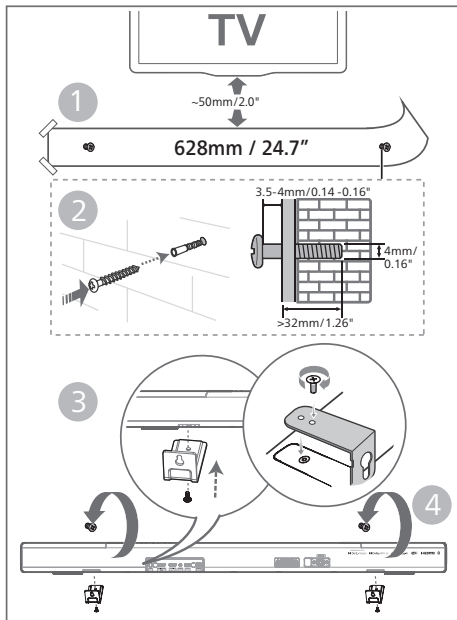

- 1 Drill 2 parallel holes (Diameter 3-8mm each according to wall type) on the wall.
  - ↳ The distance between the holes are: **628 mm / 24.7"**
  - ↳ You can use the wall mount template provided for helping the drilling holes position on the wall.
- 2 Secure the dowels and screws in the holes.

↳ Be sure to leave a **3.5-4mm** gap between the wall and the screw's head.

- 3 Attach the wall brackets (x2) into the back of the unit.
- 4 Hang the soundbar on the fastening screws.

## 3 Connect

This section helps you connect your soundbar to a TV and other devices, and then set it up.

For information about the basic connections of your soundbar and accessories, see the quick start guide.



### Note

- For identification and supply ratings, see the type plate at the back or bottom of the product.
- Before you make or change any connections, make sure that all devices are disconnected from the power outlet.

## Dolby Atmos®

Dolby Atmos gives you immersive listening experience by delivering sound in three dimensional space, and all the richness, clarity, and power of Dolby sound.

For more information, please visit [dolby.com/technologies/dolby-atmos](http://dolby.com/technologies/dolby-atmos).

### Use Dolby Atmos®

Dolby Atmos® is available in HDMI mode. For the details of the connection, please refer to "HDMI Connection".

- 1 To use Dolby Atmos® in HDMI in/HDMI eARC/ARC mode, your TV has to support Dolby Atmos®.
- 2 Make sure that "No Encoding" is selected for bitstream in the digital

audio output of the connected external device (e.g. Blu-ray DVD player, TV etc.).

- 3 While entering Dolby Atmos / Dolby Digital / PCM format, the soundbar will show DOLBY ATMOS / DOLBY AUDIO / PCM.

### Note

- The full Dolby Atmos experience is only available when the soundbar is connected to the source via a HDMI 2.0 cable.
- The soundbar will still function when connected via other methods (such as a Digital Optical cable) but they are unable to support all of the Dolby features. Given this, our recommendation is to connect via HDMI, in order to ensure full Dolby support.

## Connect to HDMI socket

Some 4K HDR TVs require the HDMI input or picture settings to be set for HDR content reception. For further setup details on HDR display, please refer to the instruction manual of your TV.

### Option 1:

#### HDMI eARC (Enhance Audio Return Channel)

Your soundbar supports HDMI with eARC/ARC (Enhance Audio Return Channel). If your TV is HDMI eARC/ARC compliant, you can hear the TV audio through your soundbar by using a single HDMI cable.

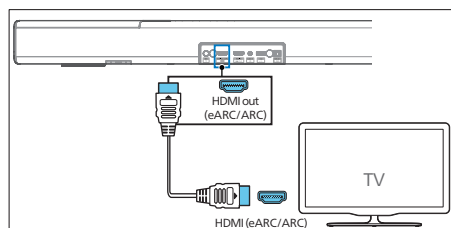

- 1 On your TV, turn on HDMI-CEC operations. For details, see the TV user manual.
  - The **HDMI ARC** connector on the TV might be labeled differently. For details, see the TV user manual.
- 2 Using a High Speed HDMI cable, connect the **HDMI out (eARC/ARC)** connector on your soundbar to the **HDMI ARC** connector on the TV.

### Note

- Your TV must support the HDMI-CEC and ARC function. HDMI-CEC and ARC must be set to On.
- The setting method of HDMI-CEC and ARC may differ depending on the TV. For details about ARC function, please refer to your TV user manual.
- Make sure to use the HDMI cables can support the ARC function.

### Option 2: Standard HDMI

If your TV is not HDMI ARC-compliant, connect your soundbar to the TV through a standard HDMI connection.

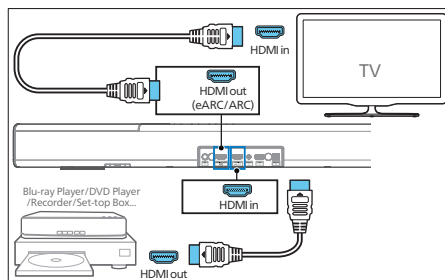

- 1 Use an HDMI cable to connect the soundbar's **HDMI in** socket to your external devices (e.g. games consoles, DVD players and Blu-ray).
- 2 Use an HDMI cable to connect the soundbar's **HDMI out (eARC)** socket to the TV's **HDMI in** socket.

## Connect to Optical socket

- 1 Using an optical cable, connect the **Optical** connector on your soundbar to the **Optical out** connector on the TV or other device.

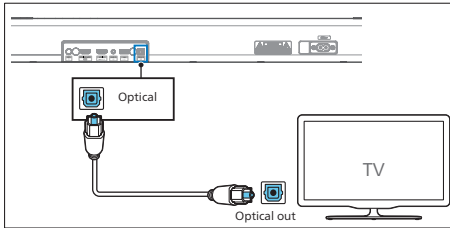

- The digital optical connector might be labeled **Spdif** or **Spdif out**.

## Connect to Audio in socket

- Use a 3.5mm to 3.5mm audio cable to connect the TV's headphone socket to the **Audio in** socket on the soundbar.

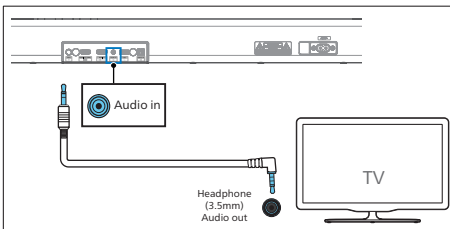

- Use a RCA to 3.5mm audio cable to connect the TV's audio output sockets to the **Audio in** socket on the soundbar.

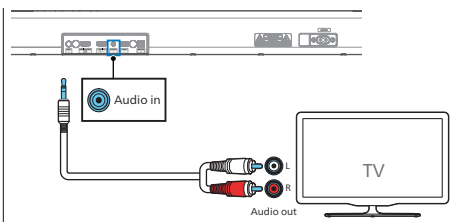

## Connect to power

- Before connecting the AC power cord, ensure you have completed all other connections.
- Risk of product damage! Ensure that the power supply voltage corresponds to the voltage printed on the back or the underside of the unit.

- 1 Connect the mains cable to the **AC~** socket of the unit and then into a mains socket.
- 2 Connect the mains cable to the **AC~** socket of the subwoofer and then into a mains socket.

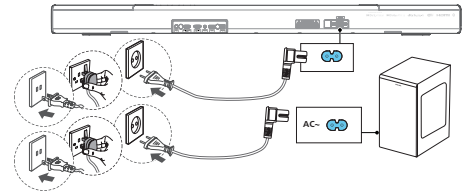

- \* Power cord quantity and plug type vary by regions.

## Pair up with the subwoofer

### Automatic pairing

Plug the soundbar and the subwoofer into the mains sockets and then press on the unit or remote control to switch the unit to **ON** mode. The subwoofer and soundbar will automatically pair.

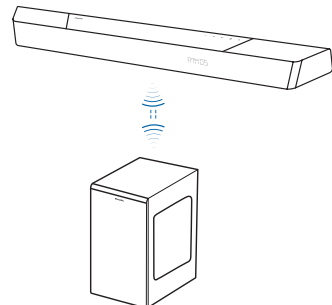

- ↳ Determine the status based on the wireless subwoofer indicator.

LED state	Status
Fast blink	Subwoofer in pairing mode
Constant on	Connected / Pairing successful
Slow blink	Connection / Pairing failed

### Tips

- Do not press **Pair** button on the rear of the subwoofer, except for manual pairing.

## Manual pairing

If no audio from the wireless subwoofer can be heard, manually pair up the subwoofer.

- 1 Unplug both the unit and the subwoofer from the mains sockets again, then plug them in again after 3 minutes.
- 2 Press and hold the **Pair** button on the rear of the subwoofer for 5 seconds.
  - ↳ The indicator on the subwoofer will rapidly blink.
- 3 Then press  on the unit or remote control to switch the unit ON.
  - ↳ The indicator on the subwoofer will become solid when successful.
- 4 If the indicator still keeps blinking, repeat step 1-3.

### Tips

- The subwoofer should be within 6 m of the soundbar in an open area (the closer the better).
- Remove any objects between the subwoofer and the soundbar.
- If the wireless connection fails again, check if there is a conflict or strong interference (e. g. interference from an electronic device) around the location. Remove these conflicts or strong interferences and repeat the above procedures.

## Connect to Wi-Fi (Wireless operation)

### (For iOS and Android version)

By connecting this unit and mobile phones, tablets (such as iPad, iPhone, iPod touch, Android phones, etc.) to the same Wi-Fi network, you can then use the Philips Sound app powered by DTS Play-fi to control the soundbar to listen to audio files.

- 1 Download and install the Philips Sound app powered by DTS Play-fi on a phone or tablet.



- Make sure your router is turned on and working properly.

### Note

- Depending on the device version, the operation screen and the way to perform operations may vary.
- 2 Connect your phone or tablet to the same Wi-Fi network that you want to connect your soundbar.



- 3 Press and hold  (Wi-Fi) button located at the back cabinet for 8 seconds to trigger the Wi-Fi connection

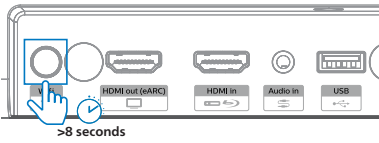

- ↳ Until the speaker make a second tone and then release the button

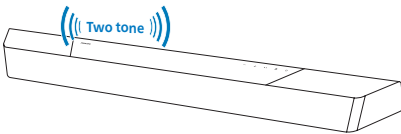

- 4 Wait until the Wi-Fi light indicator on the front cabinet goes from a fast blink to a slow pulse. When it begins pulsing slowly, it indicates that the speaker is entering the Wi-Fi setup mode.

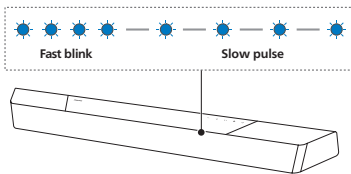

- 5 Launch the Philips Sound app powered by DTS Play-Fi. Follow the instructions in the app to connect this product to your Wi-Fi network.

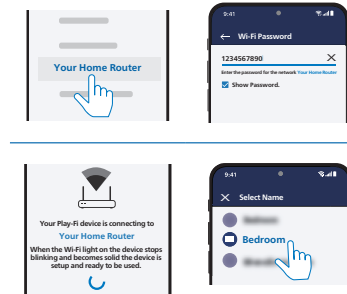
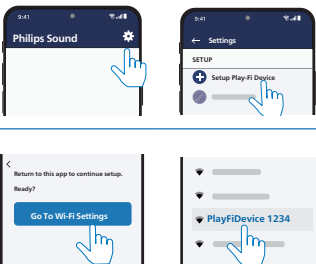

- 6 After successful Wi-Fi connection, the Wi-Fi light indicator will stop pulsing and turn solid. Once you set up this product on your Wi-Fi network, you can control it from any smartphone or tablet on the same network.
- 7 After connection, you can change the device name. There are several names to choose from or create your own by choosing Custom Name at the end of the name list. Otherwise, it follows the default name.
- 8 After connection, this product may perform a software update. Upgrade to the latest software when it is your first time set up. The software upgrade may take several minutes. Do not unplug your speaker, turn off your device, or leave the network during the update.

### Note

- After connection, the product may perform a software update. Upgrade is required after initial set up. Without the upgrade, not all product features can be available.
- When the first time set up is not successful, hold down the Wi-Fi button on the soundbar for 8 seconds until the second tone can be heard and the Wi-Fi light is changed to a slow pulse. Reset the Wi-Fi connection, restart the app and start the set up again.
- If you want to change from one network to another, you need to set up the connection again. Press hold down the  (Wi-Fi) button on the soundbar for 8 seconds to reset the Wi-Fi connection.



## AirPlay setup

Use AirPlay to set up the Wi-Fi connection of iOS device (iOS7 or later) and soundbar.

- 1 iOS device: Settings > Wi-Fi > select home network [Play-Fi device (xxxxxx)]
  - ↳ Go to the Wi-Fi set up. The Play-Fi device name displays around in 5 seconds.



- ↳ Select the Play-Fi device in the Airplay set up.
- ↳ Press **“Done”** when set up complete

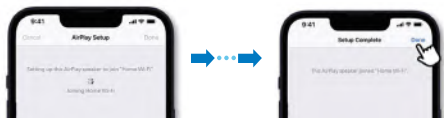

- ↳ After successful Wi-Fi connection, the Wi-Fi light indicator will stop pulsing and turn solid.

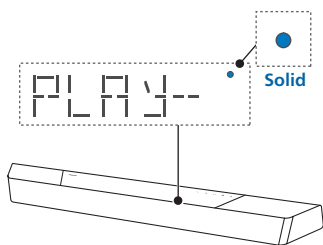

- 2 Return to Philips Sound App to name the device.



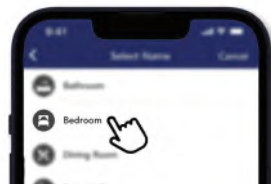

- 3 After connection, you can change the device name. There are several names to choose from or create your own by choosing Custom Name at the end of the name list. Otherwise, it follows the default name.



## WPS mode

If your router has Wi-Fi Protected Setup (WPS), you can set up the connection without entering a password.

- 1 Press and hold the  (Wi-Fi) button for 4 seconds. You will hear a tone and the Wi-Fi light will begin double blink.
- 2 Press the WPS button on your router. The button is normally marked with this WPS logo.   

- 3 After successful Wi-Fi connection, the Wi-Fi light indicator will stop pulsing and turn solid.

### Note

- WPS is not a standard feature on all routers. If your router does not have WPS then use Standard Wi-Fi Setup.
- Press the  (Wi-Fi) button once if you want to exit the WPS mode or it will automatically exit after 2 minutes.

# Connect the soundbar to Philips Play-fi enabled TV

- 1 Power up your DTS Play-fi TV connected to the internet.  
↳ TV sound is muted.
- 2 Enter the Settings menu on TV.  
↳ Settings > Sound > DTS Play-fi

## Surround sound Setup

Follow the on-screen setup.

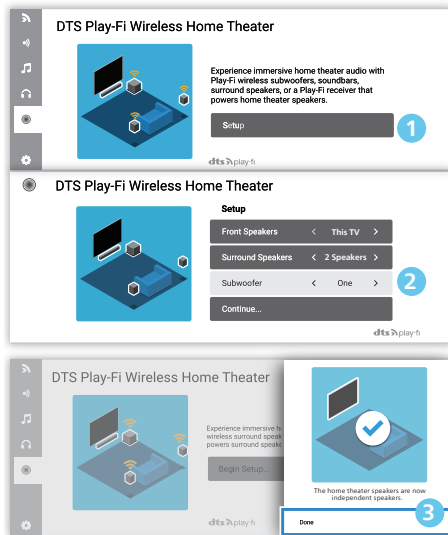

## TV Audio Setup

You can also stream the TV's audio to your home speakers wirelessly. Follow the on-screen setup.

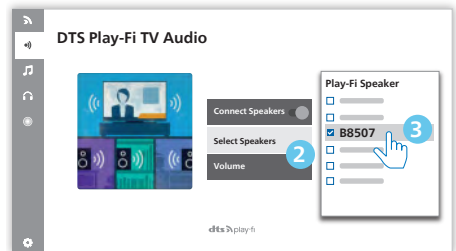
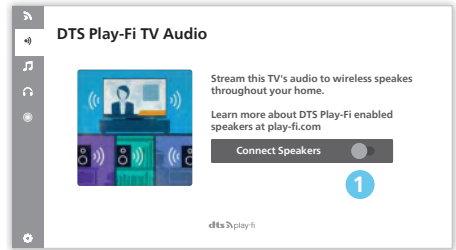

# 4 Use your soundbar



This section helps you use the soundbar to play audio from connected devices.

## Before you start

- Make the necessary connections described in the quick start guide and the user manual.
- Switch the soundbar to the correct source for other devices.

## Turn ON and OFF

- When you first connect the unit to the main socket, the unit will be in STANDBY mode. The STANDBY indicator will light up white.

Power state	Action	Function
On		Follow source state
Semi standby	Press the  button once	<ul style="list-style-type: none"><li>• Wi-Fi is connected.</li><li>• It supports Play-fi and Airplay2 Chromecast, Spotify connect, work with Alexa.</li></ul>
Eco standby	Press and hold  3 seconds	<ul style="list-style-type: none"><li>• Wi-Fi is off.</li><li>• The product enters the lower power consumption mode.</li><li>• Restarting the system will take a relatively longer time.</li></ul>

## Select modes

Press the  button repeatedly on the unit or on the remote control to select the **OPTICAL, Audio in, USB, BT**(Bluetooth), **HDMI in, HDMI eARC/ARC** mode.

- ↳ The selected mode will show on the display.

Display	Status
OPT	Optical
AUX	Audio in
USB	USB
BT	Bluetooth
HDMI	HDMI IN
E-ARC	HDMI eARC
ARC	HDMI ARC







### Tips

- Play-fi is not an optional source. Play-fi needs to be directly controlled by APP.

## Adjust the volume

### Adjust the soundbar's volume

- 1 Press the +/- buttons on the soundbar or press  +/- (Volume) buttons on the remote control to increase or decrease the soundbar's volume level.
  - To mute sound, press  (Mute) button on the remote control.
  - To restore the sound, press  (Mute) again or press  +/- (Volume).

## Adjust the subwoofer's volume

- 1 Press **(<sup>SW</sup>) +/-** (subwoofer) buttons on the remote control to increase or decrease the subwoofer's volume level.

## Enjoy Dolby Atmos sound

Press **⏮** button to select a height surround effects level to best suit your personal taste according to your environment.

- **UPMIX:** Make sure that all speakers are utilized for contents less than 5.1.2 or 7.1.2 speaker configuration.
  - **STANDARD:** Original sound.
  - **AI:** The media intelligence function of Dolby Atmos for home audio is utilized to drive the vocal enhancement or surround effects.
- ↳ By default, the audio upmix is set to **7.1.2**.



### Tips

- The audio upmix 7.1.2 display will change accordingly with different combinations. E.g:  
7.1.2: Soundbar  
7.1.4: Soundbar + Surround  
7.1.4: Soundbar + Surround + Subwoofer  
7.2.2: Soundbar + 2x Subwoofer  
7.2.4: Soundbar + Surround + 2x Subwoofer

## Setup menu

The unit allows you to configure advanced settings to provide you with an even better experience.

Button	Function
	Enter settings menu
	Previous/next selection
	Last/next sub menu
	Exit setting menu

Display	Description
EQ	Select equalizer (EQ) effect
BAS X X	Adjust the bass level
TRE X X	Adjust the treble level
B T PAIR	Start Bluetooth pairing
FL X X	Front Left Speaker
FR X X	Front Right Speaker
CT X X	Center Speaker
DRC	Dynamic range control
SYNC	Set the Audio Delay
DIM X X	Set display brightness
DISP	Display off setting
STNBY	Auto-standby ON/OFF
UPGRADE	Update firmware via USB

## EQ

Select predefined sound modes to suit your video and music: MOVIE, MUSIC, VOICE, STADIUM, CUSTOM.

- **MOVIE:** Create a surround listening experience. Ideal for watching movies.

- **MUSIC:** Create two-channel or multi-channel stereo sound. Ideal for listening to music.
- **VOICE:** Create sound effect which makes human voice more clear and outstanding for listening.
- **STADIUM:** Create an atmosphere as if watching a sports game in a stadium.
- **CUSTOM:** Customize the sound based on your preferences. Need to be set via the Fine Tune App.
- By default, the EQ is set to MOVIE.



## Bass/Treble

Change the low frequency (bass) and high frequency (treble) settings of this product.

- **BAS -5 ~ BAS +5**
- **TRE -5 ~ TRE +5**
- ↳ By default, the Bass/Treble is set to 0.

## BT PAIR

Enter the Bluetooth pairing mode.

- If you want to connect your soundbar with another Bluetooth device, you can activation the pairing in the menu (**BT PAIR**) to disconnect all devices and enter the Bluetooth pairing mode.
  - ↳ Press  > select "**BT PAIR**" > Then press  (Enter) to confirm the Bluetooth pairing mode.
- Follow step 2-3 in "**Play from Bluetooth devices**" above to pair your Bluetooth device.

### Note

- The "**BT PAIR**" menu will only be displayed when the current signal source is in "**BT**" mode

## Adjust speaker level

- Front Left: **FL -5 ~ FL +5**
- Front Right: **FR -5 ~ FR +5**
- Center: **CT -5 ~ CT +5**
  - ↳ By default, the speaker level is set to 00.

## Dynamic range control (DRC)

You can apply dynamic range control to Dolby Digital tracks.

- **ON** : Optimize the dynamic range
- **OFF** : Turn off dynamic range adjustment
  - ↳ **AUTO** : Dynamic range is automatically adjusted
  - ↳ By default, the DRC mode is set to AUTO.

### Note

- DRC is not available in USB/BT mode.

## AV SYNC

Set the Audio Delay.

Video image processing, sometimes longer than the time required to process the audio signal. This is called "delayed." Audio Delay feature is designed to remedy this delay.

- **S 00 ~ S 200**
  - ↳ By default, the audio delay is set to 00.

### Tips

- The audio delay setting applies only to the current playback mode. (For example, in HDMI ARC mode, the audio delay is only valid for HDMI ARC.)

---

## DIM

Set display brightness.

- **HIGH, MID, LOW**
- ↳ By default, the dimmer is set to MID.

---

## DISPLAY

Set to turn off the display automatically (except the Wi-Fi LED indicator) after 10 seconds of idle when no user operation.

- **ON:** Set to display on
- **OFF:** Set to display off
- ↳ By default, the display is set to ON.

---

## Auto Standby

The unit automatically turns to Standby mode after about **15** minutes if the TV or the external unit is disconnected (or USB, BT function bit playback pause), switched off.

- **STBY IN 15M:** Turn on the Auto-Standby.
- **STBY OFF:** Turn off the Auto-Standby.
- ↳ By default, the key tone is set to ON.

### Note

- To switch the unit off completely, remove the mains plug from the mains socket.
- Please turn the unit off completely to save energy when not in use.

---



## Update firmware via USB

Check if there is the latest firmware version on [www.philips.com/support](http://www.philips.com/support).

Search for your model and click on "Software and drivers".

Copy the software update files into USB





flash drive, insert USB flash drive on the unit.

- ↳ Press  > select "**UPGRADE**" > Then press the  (Enter) button 2 times to confirm.
- ↳ Upgrade finished and restart.

---

## Play from Bluetooth devices

Through Bluetooth, connect the soundbar with your Bluetooth device (such as an iPad, iPhone, iPod touch, Android phone, or laptop), and then you can listen to the audio files stored on the device through your soundbar speakers.

- 1 Press the  button repeatedly on the unit or on the remote control to switch the soundbar to Bluetooth mode.
  - ↳ **BT** is displayed on the display panel.
- 2 On the Bluetooth device, switch on Bluetooth, search for and select "**Philips B8907**" to start connection (see the user manual of the Bluetooth device on how to enable Bluetooth).
- 3 Wait until you hear the voice prompt from the soundbar.
  - ↳ If successfully connected, **BT** is displayed on the display panel.
- 4 Select and play audio files or music on your Bluetooth device.
  - During play, if a call comes in, music play pauses. Play resumes when the call ends.
  - If your Bluetooth device supports AVRCP profile, on the remote control you can press  /  to skip to a track, or press  to pause/resume play.

## To disconnect and pair a new Bluetooth device

- 1 In Bluetooth mode, Press  > select “**BT PAIR**” > Then press  (Enter) to disconnect all devices and enter the Bluetooth pairing mode.
  - Alternatively directly press and hold  button on the soundbar to disconnect all devices and enter the Bluetooth pairing mode.
    - ↳ The display will flashing “**PAIR**”.
- 2 Follow step 2-3 in “**Play from Bluetooth devices**” above to pair your Bluetooth device.

### Note

- In an open space without obstructions. The maximum operational range between the soundbar and a Bluetooth device is approximately 10 meters (30 feet).
- Compatibility with all Bluetooth devices is not guaranteed.
- The music streaming may be interrupted by obstacles between the device and soundbar, such as wall, metallic casing that covers the device, or other devices nearby that operate in the same frequency.

↳ When selecting a different audio format, the soundbar will display the following as follows:

Audio (abbreviation)	Display
LPCM 2ch	PCM
LPCM 5.1ch	PCM
LPCM 7.1ch	PCM
Dolby Digital	Dolby AUDIO
Dolby TrueHD	Dolby AUDIO
Dolby Digital Plus	Dolby AUDIO
Dolby Atmos - Dolby TrueHD	Dolby Atmos
Dolby Atmos - Dolby Digital Plus	Dolby Atmos

### Note

- The unit may not be able to decode all digital audio formats from the input source. In this case, the unit will mute. This is NOT a defect. Ensure that the audio setting of the input source (e.g. TV, game console, DVD player, etc.) is set to **PCM** or **Dolby Digital** (Refer to the user manual of the input source device for its audio setting details) with HDMI in / HDMI ARC / Optical input.

## Listen to an external device

Ensure that the unit is connected to the TV or audio device.

- 1 Press the  button repeatedly on the unit or on the remote control to select the **Audio in, Optical, HDMI ARC, HDMI in** mode.
- 2 Operate your audio device directly for playback features.
- 3 Press the **VOL +/-** buttons to adjust the volume to your desired level.



## Play audio through USB

Enjoy audio on a USB storage device, such as an MP3 player and USB flash memory, etc.

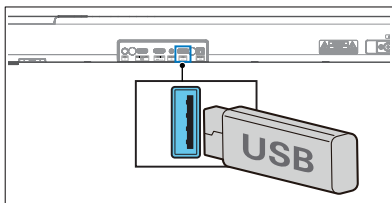
- 1 Insert the USB device.



- 2 Press the  button repeatedly on the unit or on the remote control to select the **USB** mode.
- 3 During playback:

Button	Action
	Start, pause or resume play.
	Skip to the previous or next track.



### Tips

- The unit may not be compatible with certain types of USB storage devices.
- If you use a USB extension cable, USB hub, or USB multifunctional card reader, the USB storage device may not be recognized.
- Do not remove the USB storage device during file reading.
- The unit can support USB devices with up to 128 GB of memory.
- This unit can play MP3 / WAV / FLAC.
- Support a USB port: 5V === 500mA.

## Factory reset

Reset device to default setting.

- Turn on the soundbar, press and hold the **+** and **-** buttons at the same time for 8 seconds.
  - ↳ Display shows **"RESET"** for 5 seconds.
  - ↳ While system reboots, display shows **"REBOOT"**.



# 5 Product specifications

## Note

- Specifications and design are subject to change without notice.

## Bluetooth / Wireless

Bluetooth profiles	A2DP, AVRCP
Bluetooth version	V 5.3
Bluetooth frequency band	2402 ~ 2480MHz
Transmitter power	≤ 10dBm
5.8G Wireless frequency range / Transmitter power (EIRP)	5742~5852 MHz / ≤ 10dBm

## Network supported

WiFi IEEE 802.11a/b/g/n/ac Wireless frequency band (Wi-Fi) /Radio frequency power transmitted (EIRP)	
2.4G Wi-Fi	2400 ~ 2483.5 MHz / ≤ 20dBm
	5150 ~ 5350 MHz / ≤ 20dBm
5G Wi-Fi	5470 ~ 5725 MHz / ≤ 27dBm
	5725 ~ 5850 MHz / ≤ 14dBm

## Soundbar

Power supply	100-240V~50/60Hz
MAX output power by speaker	200W RMS @10% THD
Power consumption	35 W
Standby consumption	< 0.5 W
Frequency response	150Hz~20KHz
Speakers impedance	8Ω
Dimension (WxHxD)	940 x 65 x 106 mm
Weight	2.7 kg
Operating temperature	0°C - 45°C

## Subwoofer

Power Supply	100-240 V~50-60 Hz
Output Power	120 W
Power Consumption	25 W
Standby Power Consumption	< 0.5 W
Frequency Response	35Hz - 150Hz
Impedance	3 Ω
Dimensions (W x H x D)	170 x 342 x 313 mm
Weight	5.6 kg
Operating Temperature	0°C - 45°C

## USB

USB direct version	2.0 Full Speed		
USB	5V --- 500mA		
Extension	Codec	Sample Rate	Bitrate
	MPEG 1 Layer 1	16 ~ 48 kHz	32 ~ 448 kbps
	MPEG 1 Layer 2	16 ~ 48 kHz	8 ~ 384 kbps
	MPEG 1 Layer 3	16 ~ 48 kHz	8 ~ 320 kbps
.mp3	MPEG 2 / MPEG 2.5 Layer 1	16 ~ 48 kHz	8 ~ 256 kbps
	MPEG 2 / MPEG 2.5 Layer 2	16 ~ 48 kHz	8 ~ 160 kbps
	MPEG 2 / MPEG 2.5 Layer 3	16 ~ 48 kHz	8 ~ 160 kbps
.wav	WAV	16 ~ 48 kHz	Up to 1536 kbps
.flac	FLAC	Up to 48 kHz / 16 bit	

## Remote control

Distance/Angle	6m/30°
Battery type	AAA (1.5V X 2)

## Supported audio formats

Format	Function			
	HDMI Input	HDMI eARC	HDMI ARC	OPTICAL
LPCM 2ch	√	√	√	√
LPCM 5.1ch	√	√	√	√
LPCM 7.1ch	√	√	--	--
Dolby Digital	√	√	√	√
Dolby Digital Plus	√	√	√	--
Dolby TrueHD	√	√	--	--
Dolby MAT	√	√	--	--
Dolby Atmos - Dolby Digital Plus	√	√	√	--
Dolby Atmos - Dolby TrueHD	√	√	--	--
Dolby Atmos - Dolby MAT	√	√	--	--

√ : Supported format.

-- : Unsupported format.

## The product shall comply with Dolby indication mandatory requirements marked below

Input Signal	Audio format	Dolby Virtualizer	Format Indication		
			Dolby Atmos <sup>1</sup>	Dolby Surround <sup>1</sup>	Dolby Audio
Dolby Digital	Channel-based	Off			√
		On		√	
Dolby Digital Plus	Object-based	-	√		
	Channel-based	Off			√
		On		√	
Dolby TrueHD	Object-based	-	√		
	Channel-based	Off			√
		On		√	
Dolby MAT	Object-based	-	√		
	Channel-based	Off			√
		On		√	

# 6 Troubleshooting



## Warning

- Risk of electric shock. Never remove the casing of the product.

To keep the warranty valid, never try to repair the product yourself.

If you have problems using this product, check the following points before you request service. If you still have a problem, get support at [www.philips.com/support](http://www.philips.com/support).

---

## Main unit

### The buttons on the main unit do not work.

- Disconnect from the power supply for a few minutes, and then connect again.

### No power

- Ensure that the AC cord is properly connected.
- Ensure that there is power at the AC outlet.
- Press the  button on the remote control or soundbar to turn the soundbar on.

---

## Sound

### No sound from the soundbar speaker.

- Connect the audio cable from your soundbar to your TV or other devices. However, you do not need a separate audio connection when:
  - the soundbar and TV are connected through HDMI ARC connection, or
  - a device is connected to the HDMI in connector on your soundbar.
- On the remote control, select the correct audio input.
- Make sure that the soundbar is not muted.

- Reset this product to its factory settings (see "Factory reset").

### Distorted sound or echo.

- If you play audio from TV through this product, make sure that the TV is muted.

### Audio and video are not synchronized.

- Press to synchronize the audio with the video.

### No sound from the wireless subwoofer.

- Manually connect the subwoofer to the main unit.
- Increase the volume. Press the  +/- (Volume) on the remote control or on the soundbar.
- When using either of the Digital input, if there is no audio:
  - Try setting the TV output to PCM or
  - Connect directly to your Blu-ray/ other sources. Some TVs do not pass through digital audio.
- Your TV may be set to variable audio output. Confirm that the audio output setting is set to FIXED or STANDARD, not VARIABLE. Refer to your TV's user manual for more detailed information.
- If using Bluetooth, ensure that the volume on your source device is turned up and that the device is not muted.
- When the playback freezes and there is no sound in Wi-Fi mode, please check whether your home network is normal.

---

## Bluetooth

### A device cannot connect with the soundbar.

- The device does not support the compatible profiles required for the soundbar.
- You have not enabled the Bluetooth function of the device. See the user

manual of the device on how to enable the function.

- The device is not correctly connected. Connect the device correctly.
- The soundbar is already connected with another Bluetooth device. Disconnect the connected device, and then try again.

#### **Quality of audio play from a connected Bluetooth device is poor.**

- The Bluetooth reception is poor. Move the device closer to the soundbar, or remove any obstacle between the device and the soundbar.

#### **I can't find the Bluetooth name of this unit on my Bluetooth device.**

- Ensure the Bluetooth function is activated on your Bluetooth device.
- Re-pair the unit with your Bluetooth device.

---

## **Wi-Fi**

#### **Wi-Fi Connection cannot be established.**

- Check the availability of WLAN network on the router.
- Place the Wi-Fi router closer to the unit.
- Make sure the password is correct.
- Check the WLAN function or reboot the modem and Wi-Fi router.

---

## **Dolby Atmos**

#### **Cannot achieve outstanding Dolby Atmos effects.**

- For non-HDMI connections (such as use of USB, Bluetooth, Optical or AUDIO IN), limited height surround effects are generated. See the section of 'Dolby Atmos' about how to achieve best Dolby Atmos effects.

---

## **Play-fi**

#### **Cannot discover the Play-fi supported devices from the app.**

- Make sure the device is connected to the Wi-Fi.

#### **Cannot play Play-fi music.**

- Certain network service or contents available through the device may not be accessible in case the service provider terminates its service.
- When the first time set up is not successful, close the Philips Sound app powered by DTS Play-fi. Restart the app.
- When the speaker was set as Stereo Pairs or Surround Sound, the speaker need to be disconnected in the App before use separately.

---

## **Remote control does not work**

- Before you press any playback control button, first select the correct source.
- Reduce the distance between the remote control and the unit.
- Insert the battery with its polarities (+/-) aligned as indicated.
- Replace the battery.
- Aim the remote control directly at the sensor on the front of the unit.

---

## **The soundbar turns off**

- When the unit's external input signal level is too low, the unit will be turned off automatically in 15 minutes. Please increase the volume level of your external device.

---

## **The subwoofer is idle or the indicator of subwoofer do not light up**

- Please unplug power cord from the mains socket, and plug it in again after 3 minutes to reset the subwoofer.

## Trademarks:



For DTS patents, see <http://patents.dts.com>. Manufactured under license from DTS, Inc. (for companies headquartered in the U.S./Japan/Taiwan) or under license from DTS Licensing Limited (for all other companies). DTS, DTS Play-Fi, Play-Fi and the DTS Play-Fi and Play-Fi logos are registered trademarks or trademarks of DTS, Inc. in the United States and other countries. © 2021 DTS, Inc. ALL RIGHTS RESERVED.



The Wi-Fi CERTIFIED™ Logo is a registered trademark of Wi-Fi Alliance®.



Google, Google Play and Chromecast built-in are trademark of Google LLC. Google Assistant is not available in certain languages and countries.



To control this AirPlay 2-enabled speaker, iOS 11.4 or later is required. Use of the Works with Apple badge means that an accessory has been designed to work specifically with technology identified in the badge and has been certified by trademarks of Apple Inc., registered in the U.S. and other countries. Apple® and AirPlay® are trademarks of Apple Inc., registered in the U.S. and other countries.



The Spotify Software is subject to third party licenses found here: [www.spotify.com/connect/third-party-licenses](http://www.spotify.com/connect/third-party-licenses)



The terms HDMI, HDMI High-Definition Multimedia Interface, and the HDMI Logo are trademarks or registered trademarks of HDMI Licensing Administrator, Inc.

COMPATIBLE WITH



Dolby, Dolby Vision, Dolby Atmos, and the double-D symbol are registered trademarks of Dolby Laboratories Licensing Corporation. Manufactured under license from Dolby Laboratories. Confidential unpublished works. Copyright © 2012-2021 Dolby Laboratories. All rights reserved.



The Bluetooth® word mark and logos are registered trademarks owned by Bluetooth SIG, Inc. and any use of such marks by MMD Hong Kong Holding Limited is under license. Other trademarks and trade names are those of their respective owners.



Roku, the Roku logo, Roku TV, Roku TV Ready, and the Roku TV Ready logo are trademarks and/or registered trademarks of Roku, Inc. This product is Roku TV Ready-supported in the United States, Canada, United Kingdom, Mexico and Brazil. Countries are subject to change. For the most current list of countries in which this product is Roku TV Ready-supported, please email [rokutvready@roku.com](mailto:rokutvready@roku.com).



Specifications are subject to change without notice. Please visit [www.Philips.com/support](http://www.Philips.com/support) for the latest updates and documents.

Philips and the Philips Shield Emblem are registered trademarks of Koninklijke Philips N.V. and are used under license.

This product has been manufactured by and is sold under the responsibility of MMD Hong Kong Holding Limited, or one of its affiliates, and MMD Hong Kong Holding Limited, is the warrantor in relation to this product.