

Test Report No.: 24012105-RF-US-01

FCC Part 15, Subpart C Test Report

FCC ID: 2AR2STAB5309

Applicant: MMD Hong Kong Holding Limited

Address: Units 1208-11, 12th Floor, C-Bons International Center, 108 Wai Yip Street,
Kwun Tong, Kowloon, Hong Kong

Manufacturer: MMD Hong Kong Holding Limited

Address: Units 1208-11, 12th Floor, C-Bons International Center, 108 Wai Yip Street,
Kwun Tong, Kowloon, Hong Kong

Product(s): Soundbar speaker

Brand(s): PHILIPS or 

Test Model(s): TAB5309/37

Series Model(s): See Section 2.1

Test Date: Jan. 16, 2023 ~ Mar. 08, 2024

Issued Date: Mar. 25, 2024

Issued By: Hwa-Hsing (Dongguan) Testing Co., Ltd.

Address: No.101, Building N1, Yuyuan 2 Road, Yuyuan Industrial Park, HuangJiang
Town, Dongguan City, People's Republic of China

Test Firm Registration No.: 915896

Designation No.: CN1255

Standards: 47 CFR FCC Part 15, Subpart C (Section 15.247)
ANSI C63.10:2013

The above equipment has been tested by **Hwa-Hsing (Dongguan) Testing Co., Ltd.**, and found compliance with the requirement of the above standards. The test record, data evaluation & Equipment Under Test (EUT) configurations represented herein are true and accurate accounts of the measurements of the sample's EMC characteristics under the conditions specified in this report.

Prepared by :

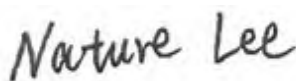

Nature Lee

Reviewed by :

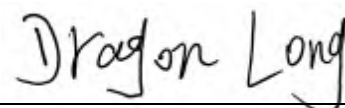

Dragon Long

Approved by :



Scott He

"This report is for your exclusive use. Any copying or replication of this report to or for any other person or entity, or use of our name or trademark, is permitted only with our prior written permission. This report sets forth our findings solely with respect to the test samples identified herein. Our report includes all the tests requested by you and the results thereof based upon the information that you provided to us. The report would be invalid without specific stamp of test institute and the signatures of tester and approver."

Lab: [Hwa-Hsing \(Dongguan\) Testing Co., Ltd.](#)Address: [No.101, Building N1, Yuyuan 2 Road, Yuyuan Industrial Park, HuangJiang Town, Dongguan City, People's Republic of China](#)Tel: [0769-83078199](tel:0769-83078199)Web.: www.hwa-hsing.comE-Mail: customerservice.dg@hwa-hsing.com

Release

[Ver. 1.5](#)

Table of Contents

Release Control Record	4
1 Summary of Test Results	5
1.1 Measurement Uncertainty.....	5
1.2 Modification Record.....	5
2 General Information	6
2.1 General Description of EUT.....	6
2.2 Description of Test Modes.....	7
2.3 Test Mode Applicability and Tested Channel Detail.....	8
2.4 Description of Support Units.....	10
2.5 Configuration of System under Test.....	11
2.6 Duty Cycle of Test Signal.....	12
3 Test Types and Results	13
3.1 Radiated Emission and Band-edge Measurement.....	13
3.1.1 Limits of Radiated Emission and Band-edge Measurement.....	13
3.1.2 Test Instruments.....	14
3.1.3 Test Procedures.....	15
3.1.4 Deviation from Test Standard.....	16
3.1.5 Test Setup.....	17
3.1.6 EUT Operating Conditions.....	18
3.1.7 Test Results.....	19
3.2 Conducted Emission Measurement.....	35
3.2.1 Limits of Conducted Emission Measurement.....	35
3.2.2 Test Instruments.....	35
3.2.3 Test Procedures.....	36
3.2.4 Test Setup.....	36
3.2.5 EUT Operating Condition.....	36
3.2.6 Deviation from Test Standard.....	36
3.2.7 Test Results.....	37
3.3 Number of Hopping Frequency Used.....	39
3.3.1 Limits of Hopping Frequency Used Measurement.....	39
3.3.2 Test Setup.....	39
3.3.3 Test Instruments.....	39
3.3.4 Test Procedure.....	39
3.3.5 Deviation from Test Standard.....	39
3.3.6 Test Results.....	40
3.4 Dwell Time on Each Channel.....	41
3.4.1 Limits of Dwell Time on Each Channel Measurement.....	41
3.4.2 Test Setup.....	41
3.4.3 Test Instruments.....	41
3.4.4 Test Procedures.....	41
3.4.5 Deviation from Test Standard.....	41
3.4.6 Test Results.....	42
3.5 Channel Bandwidth.....	45
3.5.1 Limits of Channel Bandwidth Measurement.....	45
3.5.2 Test Setup.....	45
3.5.3 Test Instruments.....	45
3.5.4 Test Procedure.....	45
3.5.5 Deviation from Test Standard.....	45

Lab: [Hwa-Hsing \(Dongguan\) Testing Co., Ltd.](#)Address: [No.101, Building N1, Yuyuan 2 Road, Yuyuan Industrial Park, HuangJiang Town, Dongguan City, People's Republic of China](#)Tel: [0769-83078199](#)Web.: [www.hwa-hsing.com](#)E-Mail: [customerservice.dg@hwa-hsing.com](#)

Release

[Ver. 1.5](#)

Test Report No.: 24012105-RF-US-01

3.5.6 EUT Operating Condition	45
3.5.7 Test Results	46
3.6 Occupied Bandwidth Measurement.....	48
3.6.1 Test Setup.....	48
3.6.2 Test Instruments	48
3.6.3 Test Procedure	48
3.6.4 Deviation from Test Standard	48
3.6.5 EUT Operating Conditions.....	48
3.6.6 Test Results	49
3.7 Hopping Channel Separation.....	51
3.7.1 Limits of Hopping Channel Separation Measurement.....	51
3.7.2 Test Setup.....	51
3.7.3 Test Instruments	51
3.7.4 Test Procedure	51
3.7.5 Deviation from Test Standard	51
3.7.6 Test Results	52
3.8 Maximum Output Power	54
3.8.1 Limits of Maximum Output Power Measurement	54
3.8.2 Test Setup.....	54
3.8.3 Test Instruments	54
3.8.4 Test Procedure	54
3.8.5 Deviation from Test Standard	56
3.8.6 EUT Operating Condition	56
3.8.7 Test Results	57
3.9 Conducted Out of Band Emission Measurement	60
3.9.1 Limits of Conducted Out of Band Emission Measurement.....	60
3.9.2 Test Setup.....	60
3.9.3 Test Instruments	60
3.9.4 Test Procedure	61
3.9.5 Deviation from Test Standard	61
3.9.6 EUT Operating Condition	61
3.9.7 Test Results	62
4 Pictures of Test Arrangements.....	67
5 Test Instruments.....	68
Appendix – Information on the Testing Laboratories	69

Lab: [Hwa-Hsing \(Dongguan\) Testing Co., Ltd.](#)Address: [No.101, Building N1, Yuyuan 2 Road, Yuyuan Industrial Park, HuangJiang Town, Dongguan City, People's Republic of China](#)Tel: [0769-83078199](tel:0769-83078199)Web.: www.hwa-hsing.comE-Mail: customerservice.dg@hwa-hsing.com

Release

[Ver. 1.5](#)

Test Report No.: 24012105-RF-US-01

Release Control Record

Issue No.	Description	Date Issued
24012105-RF-US-01	Original Release	Mar. 25, 2024

Lab: [Hwa-Hsing \(Dongguan\) Testing Co., Ltd.](#)Address: [No.101, Building N1, Yuyuan 2 Road, Yuyuan Industrial Park, HuangJiang Town, Dongguan City, People's Republic of China](#)Tel: [0769-83078199](tel:0769-83078199)Web.: www.hwa-hsing.comE-Mail: customerservice.dg@hwa-hsing.comRelease
Ver. 1.5

1 Summary of Test Results

47 CFR FCC Part 15, Subpart C (Section 15.247) KDB 558074 D01 15.247 Meas Guidance v05r02 ANSI C63.10:2013;			
FCC Clause	Test Item	Result	Remarks
15.247(a)(1) (iii)	Number of Hopping Frequency Used	Pass	Meet the requirement of limit.
15.247(a)(1) (iii)	Dwell Time on Each Channel	Pass	Meet the requirement of limit.
15.247(a)(1)	1. Hopping Channel Separation 2. Spectrum Bandwidth of a Frequency Hopping Sequence Spread Spectrum System	Pass	Meet the requirement of limit.
15.247(b)	Maximum Peak Output Power	Pass	Meet the requirement of limit.
---	Occupied Bandwidth Measurement	Pass	Reference only
15.205 & 209	Radiated Emissions	Pass	Meet the requirement of limit.
15.247(d)	Band Edge Measurement	Pass	Meet the requirement of limit.
15.247(d)	Antenna Port Emission	Pass	Meet the requirement of limit.
15.203	Antenna Requirement	Pass	No antenna connector is used.

Note1: If the Frequency Hopping System operating in 2400-2483.5MHz band and the output power less than 125mW. The hopping channel carrier frequencies separated by a minimum of 25kHz or two-thirds of the 20dB bandwidth of hopping channel whichever is greater.

Note2: The EUT has been verified to comply with the requirements of FCC Part 15, Subpart B, Class B (sDoC). The test report has been issued separately.

1.1 Measurement Uncertainty

Where relevant, the following measurement uncertainty levels have been estimated for tests performed on the EUTas specified in CISPR 16-4-2:

The listed uncertainties are the worst-case uncertainty for the entire range of measurement. Please note that the uncertainty values are provided for informational purposes only and are not used in determining the PASS/FAIL results.

Measurement	Frequency	Expanded Uncertainty (k=2) (±)
Radiated Emissions up to 1 GHz	9KHz ~ 30MHz	2.16 dB
	30MHz ~ 1000MHz	3.47 dB
Radiated Emissions above 1 GHz	1GHz ~ 18GHz	4.84 dB
	18GHz ~ 40GHz	4.67 dB

Note: This uncertainty represents an expanded uncertainty expressed at approximately the 95% confidence level using a coverage factor of k = 2.

1.2 Modification Record

There were no modifications required for compliance.

2 General Information**2.1 General Description of EUT**

Product(s)	Soundbar speaker
Test Model(s)	TAB5309/37
Sample No.	HS2401090012
Series Model(s)	TAB5309, TAB5309/61, TAB5309/98, TAB5309/10, TAB5309/yy (yy=00-99 or blank, for country code)
Status of EUT	Engineering Prototype
Power Supply Rating	AC 100-240V 50/60Hz 25W
Modulation Type	GFSK, $\pi/4$ DQPSK, 8DPSK for FHSS
Transfer Rate	1Mbps, 2Mbps, 3Mbps
Operating Frequency	2402 ~ 2480MHz
Number of Channel	79
Output Power (Peak)	-0.03dBm
Antenna Type and Antenna Gain	FPC Antenna; 4.02dBi Gain
Antenna Connector	N/A
Accessory Device	Remote Control
Cable Supplied	AC Line: 150cm Non-shielded, Detachable

Note:

1. Please refer to the EUT photo document (Reference No.: 24012105-01-01&02) for detailed product photo.
2. The above EUT information is declared by manufacturer and for more detailed features description, please refer to the manufacturer's specifications or User's Manual.
3. For the test results, the EUT had been tested with all conditions, and only the worst case was shown in the test report.
4. Model differences: These models are only different for model name and trademark for trade purpose.

2.2 Description of Test Modes

79 channels are provided to this EUT:

Channel	Freq. (MHz)	Channel	Freq. (MHz)	Channel	Freq. (MHz)	Channel	Freq. (MHz)
0	2402	20	2422	40	2442	60	2462
1	2403	21	2423	41	2443	61	2463
2	2404	22	2424	42	2444	62	2464
3	2405	23	2425	43	2445	63	2465
4	2406	24	2426	44	2446	64	2466
5	2407	25	2427	45	2447	65	2467
6	2408	26	2428	46	2448	66	2468
7	2409	27	2429	47	2449	67	2469
8	2410	28	2430	48	2450	68	2470
9	2411	29	2431	49	2451	69	2471
10	2412	30	2432	50	2452	70	2472
11	2413	31	2433	51	2453	71	2473
12	2414	32	2434	52	2454	72	2474
13	2415	33	2435	53	2455	73	2475
14	2416	34	2436	54	2456	74	2476
15	2417	35	2437	55	2457	75	2477
16	2418	36	2438	56	2458	76	2478
17	2419	37	2439	57	2459	77	2479
18	2420	38	2440	58	2460	78	2480
19	2421	39	2441	59	2461	-	-

2.3 Test Mode Applicability and Tested Channel Detail

EUT Configure Mode	Applicable test items	X-Axis	Y-Axis	Z-Axis	Voltage Supply
Conducted	AC Power Conducted Emission	N/A	N/A	N/A	AC 120V
Radiated	Radiated Emissions	√	√	√	
Antenna Port Conducted Measurement	Number of Hopping Frequency Used	N/A	N/A	N/A	
	Dwell Time on Each Channel	N/A	N/A	N/A	
	Band Edge Measurement	N/A	N/A	N/A	
	Antenna Port Emission	N/A	N/A	N/A	
	Conducted power	N/A	N/A	N/A	
	Hopping Channel Separation	N/A	N/A	N/A	
	Spectrum Bandwidth of a Frequency Hopping Sequence Spread Spectrum System	N/A	N/A	N/A	

- *: The EUT had been pre-tested on the positioned of each 3 Axis. The worst case was found when positioned on **X-plane**.
- "N/A" means no effect.

Evaluation of difference data rate:

Applicable test items	Modulation Type			The Worst-case modes recording in report
	GFSK	$\pi/4$ DQPSK	8DPSK	
Radiated Emissions	√	√	√	GFSK& 8DPSK
Antenna Port Conducted Measurement	√	√	√	GFSK& 8DPSK

Test Condition:

Applicable test items	Environmental Conditions	Test Date	Tested by
Radiated Emissions	24.1deg. C, 56%RH	Mar. 05, 2024	Hua
Antenna Port Conducted Measurement	25.1deg. C, 52.3%RH	Jan. 16, 2023	Dragon

- Pre-Scan has been conducted to determine the worst-case mode from all possible combinations between available modulations, data rates and antenna ports (if EUT with antenna diversity architecture). Following channel(s) was (were) selected for the final test as listed below.

Radiated Emission Test (Above 1 GHz):

EUT Configure Mode	Available Channel	Tested Channel	Modulation Technology	Modulation Type	Packet Type
-	0 to 78	0, 39, 78	FHSS	GFSK	DH5
-	0 to 78	0, 39, 78	FHSS	8DPSK	3DH5

Radiated Emission Test (Below 1 GHz):

EUT Configure Mode	Available Channel	Tested Channel	Modulation Technology	Modulation Type	Packet Type
-	0 to 78	0	FHSS	GFSK	DH5
-	0 to 78	0	FHSS	8DPSK	3DH5

Power Line Conducted Emission Test:

EUT Configure Mode	Available Channel	Tested Channel	Modulation Technology	Modulation Type	Packet Type
-	0 to 78	39	FHSS	GFSK	DH5

Antenna Port Conducted Measurement:

- This item includes all test value of each mode, but only includes spectrum plot of worst value of each mode.

EUT Configure Mode	Available Channel	Tested Channel	Modulation Technology	Modulation Type	Packet Type
-	0 to 78	0, 39, 78	FHSS	GFSK	DH5
-	0 to 78	0, 39, 78	FHSS	8DPSK	3DH5

Test Report No.: 24012105-RF-US-01

2.4 Description of Support Units

The EUT has been tested as an independent unit together with other necessary accessories or support units. The following support units or accessories were used to form a representative test configuration during the tests.

No.	Product	Brand	Model No.	Serial No.	FCC ID
1	Notebook	HUAWEI	NbD-WFH9	EUEPM21725002655	N/A
2	Notebook	DELL	Inspiron 14R Aluminum Edition	6WPG9-63PV4-RBPF2-T6RHW-W9GBP	N/A

No.	Signal Cable Description of The Above Support Units
1	USB extension cord: Unshielded, Detachable 1.2m;

Lab: [Hwa-Hsing \(Dongguan\) Testing Co., Ltd.](#)Address: [No.101, Building N1, Yuyuan 2 Road, Yuyuan Industrial Park, HuangJiang Town, Dongguan City, People's Republic of China](#)Tel: [0769-83078199](#)Web.: [www.hwa-hsing.com](#)E-Mail: [customerservice.dg@hwa-hsing.com](#)

Release

[Ver. 1.5](#)

2.5 Configuration of System under Test

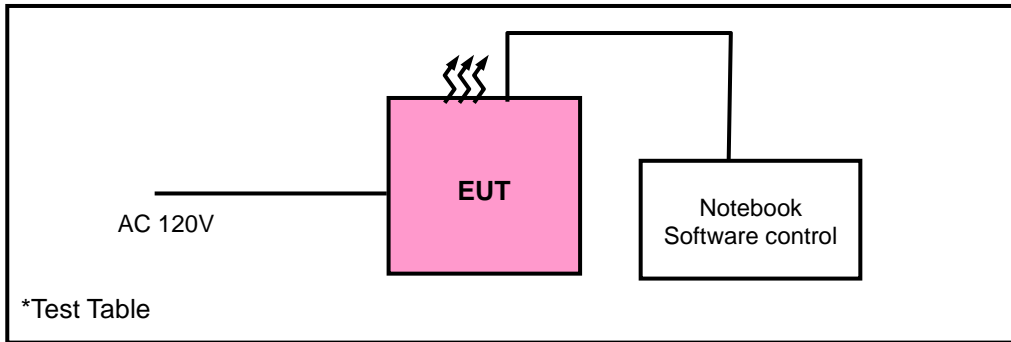

2.6 Duty Cycle of Test Signal

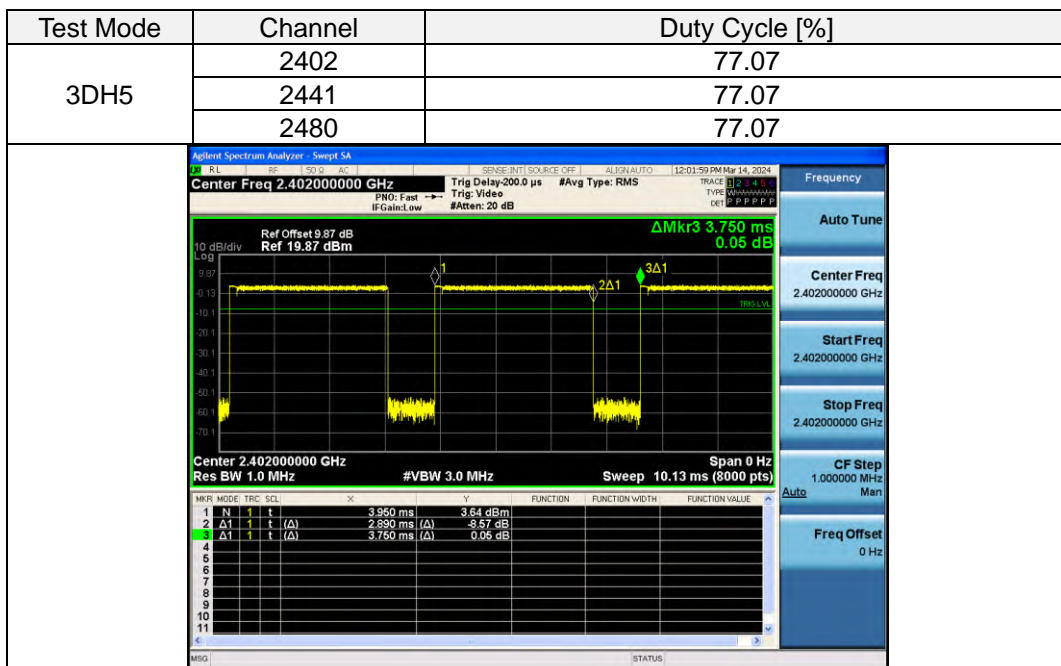
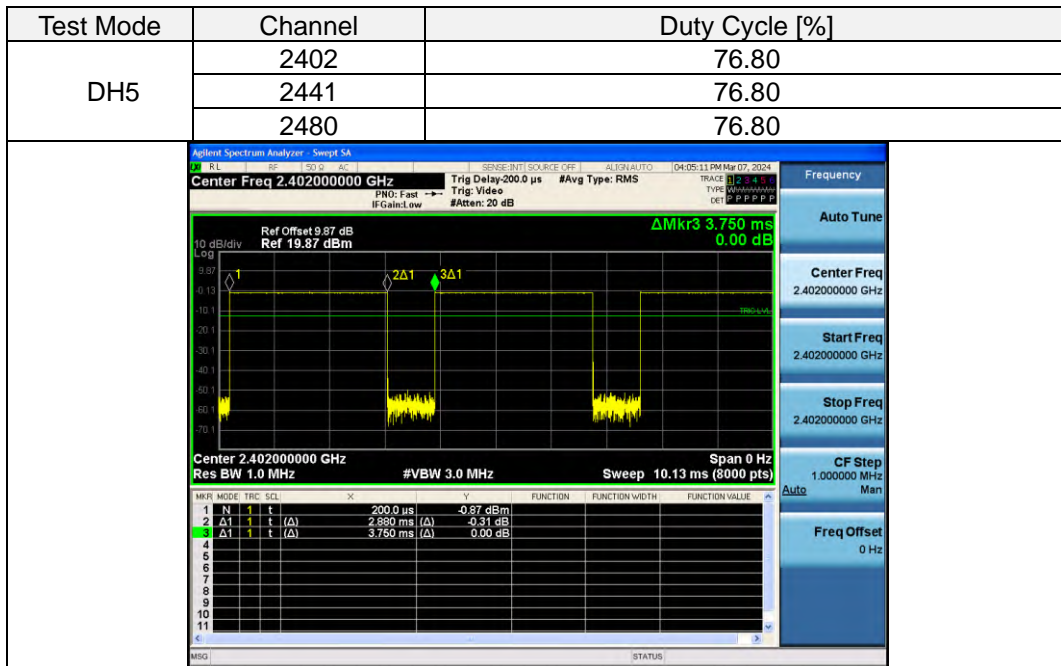

3 Test Types and Results**3.1 Radiated Emission and Band-edge Measurement****3.1.1 Limits of Radiated Emission and Band-edge Measurement**

Radiated emissions which fall in the restricted bands must comply with the radiated emission limits specified as below table. Other emissions shall be at least 20 dB below the highest level of the desired power:

Frequencies (MHz)	Field Strength (microvolts/meter)	Measurement Distance (meters)
0.009 ~ 0.490	2400/F(kHz)	300
0.490 ~ 1.705	24000/F(kHz)	30
1.705 ~ 30.0	30	30
30 ~ 88	100	3
88 ~ 216	150	3
216 ~ 960	200	3
Above 960	500	3

* DTS emissions in non-restricted frequency bands Subclause 11.11 of ANSI C63.10 is applicable.

* DTS emissions in restricted frequency bands Subclause 11.12 of ANSI C63.10 is applicable.

Note:

1. The lower limit shall apply at the transition frequencies.
2. Emission level (dBuV/m) = 20 log Emission level (uV/m).
3. For frequencies above 1000 MHz, the field strength limits are based on average detector, however, the peak field strength of any emission shall not exceed the maximum permitted average limits, specified above by more than 20 dB under any condition of modulation.

3.1.2 Test Instruments

Radiated emission below 30MHz:

Equipment	Manufacturer	Model No.	Serial No.	Next Cal.
EMI Test Receiver	Rohde&Schwarz	ESR7	100962	2024-12-17
3m Semi-anechoic Chamber	MAORUI	9m*6m*6m	NSEMC003	2026-03-12**
Test software	FARAD	FARAD	EZ_EMCV1.1.4.2	N/A
Loop Antenna	EMCI	HLA 6121	56735	2024-05-04*
Antenna Tower	MF	MFA-440H	NA	NA
Turn Table	MF	MFT-201SS	NA	NA
Antenna Tower&Turn Table Controller	MF	MF-7802	NA	NA

Frequency Range below 1GHz:

Equipment	Manufacturer	Model No.	Serial No.	Next Cal.
3m Semi-anechoic Chamber	MAORUI	9m*6m*6m	NSEMC003	2026-03-12**
EMI Test Receiver	Rohde&Schwarz	ESPI 7	101978	2024-12-17
Broadband antenna	Schwarzbeck	VULB 9168	00937	2024-08-18
Signal Amplifier	Com-power	PAM-103	18020051	2024-08-06
Attenuator	Rohde&Schwarz	TS2GA-6dB	18101101	N/A
Test software	FARAD	FARAD	EZ_EMCV1.1.4.2	N/A

Frequency Range above 1GHz:

Equipment	Manufacturer	Model No.	Serial No.	Next Cal.
3m Semi-anechoic Chamber	MAORUI	9m*6m*6m	NSEMC003	2026-03-12**
Horn Antenna	Schwarzbeck	BBHA 9120D	02202	2024-08-27*
Broadband Coaxial Pre-amplifier	Schwarzbeck	BBV 9718	25	2024-08-06
Spectrum	Keysight	N9020A	MY51240612	2024-08-06
Pre-Amplifier	EMCI	EMC 184045SE	9870709	2024-12-17
Antenna Tower	MF	MFA-440H	NA	NA
Turn Table	MF	MFT-201SS	NA	NA
Antenna Tower&Turn Table Controller	MF	MF-7802	NA	NA

Note:

1. The calibration interval of the above test instruments is 12 months or 24 months (*) or 36 months (**).
2. The test was performed in 966.

3.1.3 Test Procedures

a. Peak emission levels are measured by setting the instrument as follow:

- 1) RBW&VBWsetting as a function of frequency:

Frequency	RBW	VBW
9kHz~150kHz	200Hz	600Hz
0.15MHz~30MHz	9kHz	30kHz
30MHz~1000MHz	120kHz	300kHz
>1000MHz	1MHz	3MHz

- 2) Detector = peak.
 3) Sweep time = auto.
 4) Trace mode = max hold.
 5) Allow sweeps to continue until the trace stabilizes. (Note that the required measurement time may be lengthened for low-duty-cycle applications.)

Note: If the peak-detected amplitude can be shown to comply with the average limit, then it is not necessary to perform a separate average measurement.

b. Average emission levels are measured by setting the instrument as follow:

- **Trace averaging with continuous EUT transmission at full power**

If the EUT can be configured or modified to transmit continuously ($D \geq 98\%$), then the average emission levels shall be measured using the following method (with EUT transmitting continuously):

- 1) RBW=1 MHz (unless otherwise specified).
- 2) $VBW \geq 3 * RBW$.
- 3) Detector =RMS
- 4) Sweep time = auto.
- 5) Perform a trace average of at least 100 traces.

- **Trace averaging across ON and OFF times of the EUT transmissions followed by duty cycle correction**

If continuous transmission of the EUT ($D \geq 98\%$) cannot be achieved and the duty cycle is constant (duty cycle variations are less than $\pm 2\%$), then the following procedure shall be used

- 1) The EUT shall be configured to operate at the maximum achievable duty cycle.
- 2) Measure the duty cycle D of the transmitter output signal as described in 11.6.
- 3) RBW=1 MHz (unless otherwise specified).
- 4) $VBW \geq 3 * RBW$.
- 5) Detector =RMS
- 6) Sweep time = auto.
- 7) Perform a trace average of at least 100 traces.

A correction factor shall be added to the measurement results prior to comparing with the emission limit to compute the emission level that would have been measured had the test been performed at 100% duty cycle. The correction factor is computed as follows:

*If power averaging (rms) mode was used in step 5), then the applicable correction factor is $[10 \log(1/D)]$, where D is the duty cycle.

**If linear voltage averaging mode was used in step f), then the applicable correction factor is $[20 \log(1/D)]$, where D is the duty cycle.

***If a specific emission is demonstrated to be continuous ($D > 98\%$) rather than turning ON and OFF with the transmit cycle, then no duty cycle correction is required for that.

Test Report No.: 24012105-RF-US-01

● Reduced VBW Averaging across ON and OFF times of the EUT transmissions with max hold

If continuous transmission of the EUT ($D > 98\%$) cannot be achieved and the duty cycle is not constant (duty cycle variations exceed $\pm 2\%$), then the following procedure shall be used:

- 1) RBW = 1 MHz.
 - 2) $VBW \geq 1/T$.
 - 3) Detector = peak
 - 4) Sweep time = auto.
 - 5) Trace mode = max hold.
 - 6) Allow max hold to run for at least $[50 \times (1/D)]$ traces
- c. The EUT was placed on the top of a rotating table 0.8 meters (below 1GHz) / 1.5 meters (Above 1GHz) above the reference ground. The table was rotated 360 degrees to determine the position of the highest radiation.
- d. The EUT was set 3 meters away from the interference-receiving antenna (Below 1GHz) & (Above 1GHz), which was mounted on the top of a variable-height antenna tower.
- e. The height of antenna is varied from one meter to four meters above the ground to determine the maximum value of the field strength. Both horizontal and vertical polarizations of the antenna are set to make the measurement.
- f. For each suspected emission, the EUT was arranged to its worst case and then the antenna was tuned to heights from 1 meter to 4 meters and the rotatable table was turned from 0 degrees to 360 degrees to find the maximum reading.
- g. The test-receiver system was set to quasi-peak detect function and specified bandwidth with maximum hold mode when the test frequency is below 1 GHz.
- h. The test-receiver system was set to peak and average detected function and specified bandwidth with maximum hold mode when the test frequency is above 1 GHz. If the peak reading value also meets average limit, measurement with the average detector is unnecessary.

Note:

1. Test procedures for measuring FHSS device: The use of a duty cycle correction factor (DCCF) is permitted for calculating average radiated field strength emission levels for an FHSS device in 15.247. This DCCF can be applied when the unwanted emission limit is subject to an average field strength limit (e.g., within a Government Restricted band) and the conditions specified in Section 15.35(c) can be satisfied. The average radiated field strength is calculated by subtracting the DCCF from the maximum radiated field strength level as determined through measurement. The maximum radiated field strength level represents the worst-case (maximum amplitude) RMS measurement of the emission(s) during continuous transmission (i.e., not including any time intervals during which the transmitter is off or is transmitting at a reduced power level). It is also acceptable to apply the DCCF to a measurement performed with a peak detector instead of the specified RMS power averaging detector. Note that Section 15.35(c) specifies that the DCCF shall represent the worst-case (greatest duty cycle) over any 100 msec transmission period. Subclause 7.5 of ANSI C63.10 provides additional measurement guidance applicable to determination of the DCCF.
2. All modes of operation were investigated and the worst-case emissions are reported.

3.1.4 Deviation from Test Standard

No deviation.

Lab: [Hwa-Hsing \(Dongguan\) Testing Co., Ltd.](#)Address: [No.101, Building N1, Yuyuan 2 Road, Yuyuan Industrial Park, HuangJiang Town, Dongguan City, People's Republic of China](#)Tel: [0769-83078199](tel:0769-83078199)Web.: www.hwa-hsing.comE-Mail: customerservice.dg@hwa-hsing.com

Release

[Ver. 1.5](#)

3.1.5 Test Setup

Radiated emission below 30MHz:

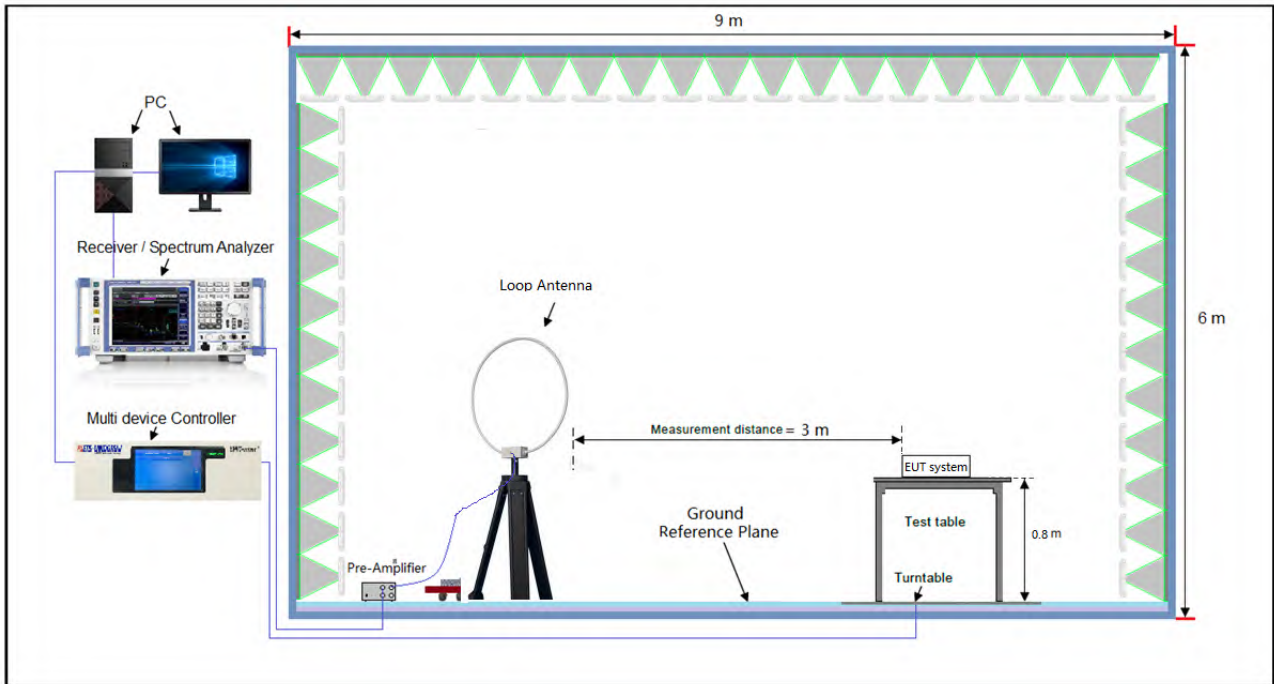

Frequency Range below 1GHz:

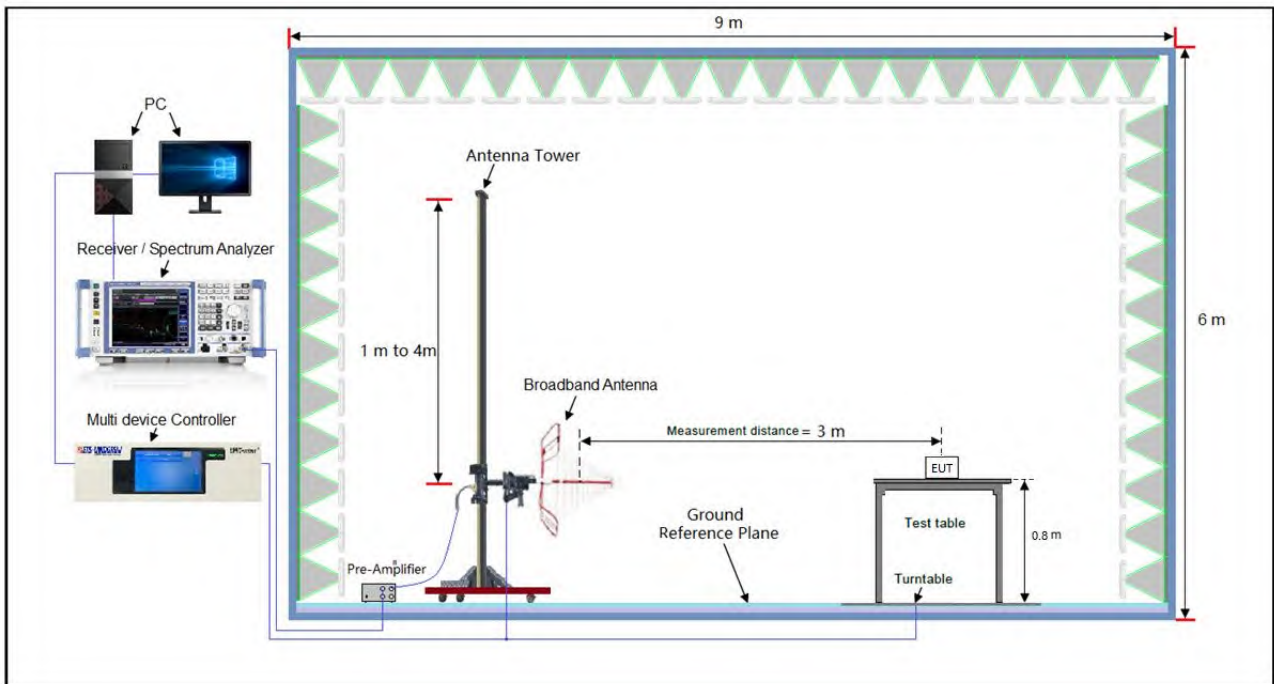

Frequency Range above 1GHz:

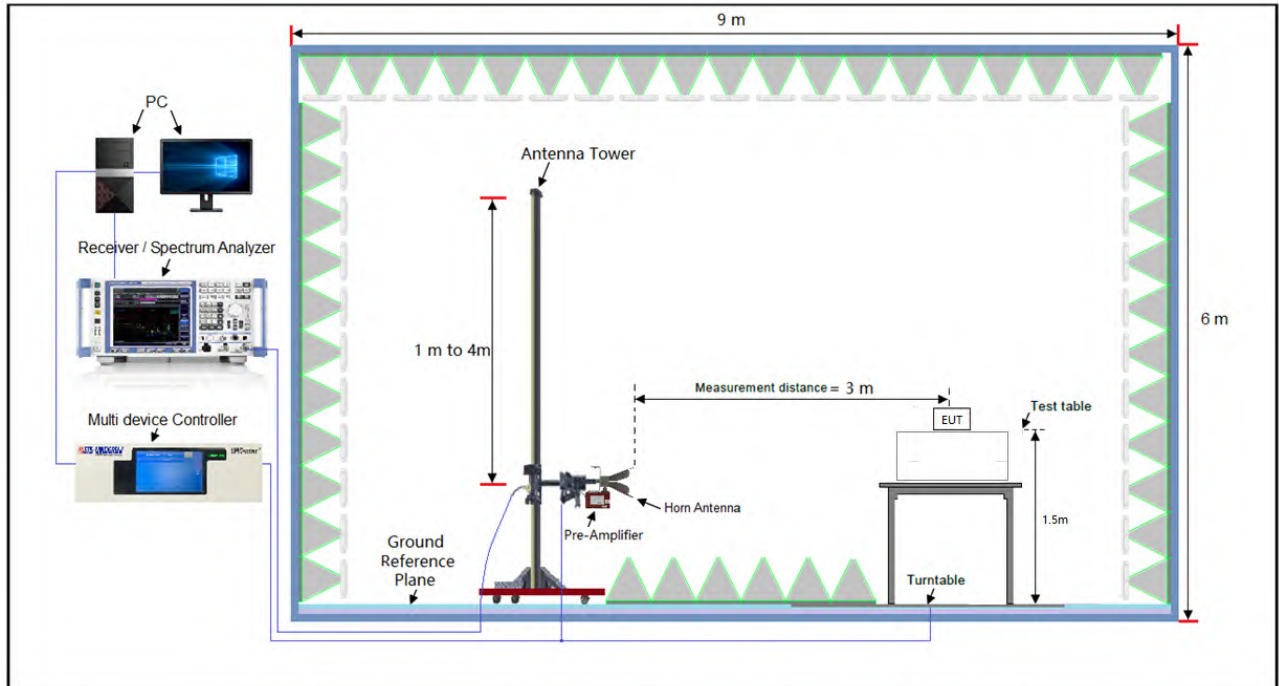

*For the actual test configuration, please refer to the attached file (Test Setup Photo).

3.1.6 EUT Operating Conditions

Set the EUT under transmission condition continuously at specific channel frequency.

Test Report No.: 24012105-RF-US-01

3.1.7 Test Results

9 kHz ~ 30 MHz Data:

The amplitude of spurious emissions attenuated more than 20 dB below the permissible value is not required to be report.

30 MHz ~ 1GHz Worst-Case Data:

Frequency Range	30MHz ~ 1GHz	Detector Function	Peak (PK) Quasi-peak (QP)
Test Channel	Channel 0		

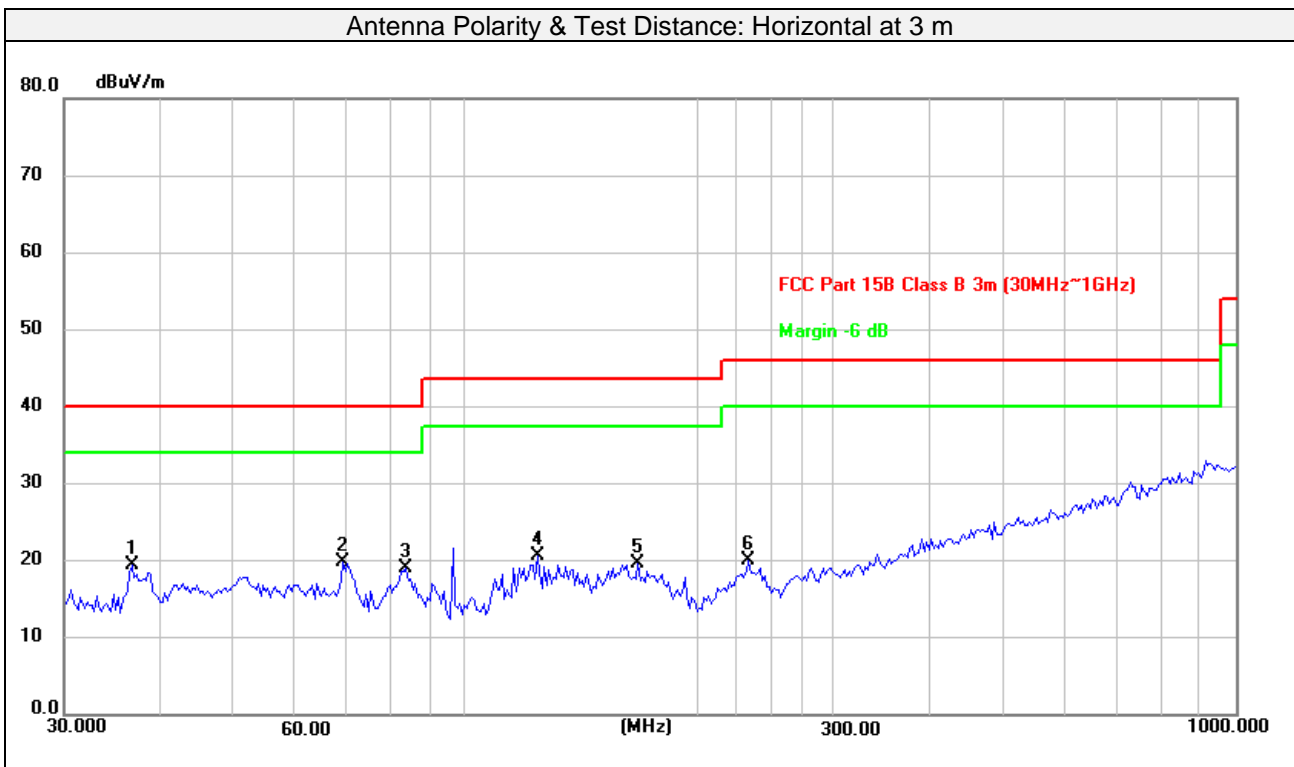

No.	Frequency (MHz)	Reading (dBuV)	Factor (dB)	Emission Level (dBuV/m)	Limit (dBuV/m)	Margin (dB)	Detector	Antenna Height (cm)	Table Angle (Degree)
1	36.7662	36.34	-16.84	19.50	40.00	-20.50	peak	104	33
2	69.1141	36.17	-16.37	19.80	40.00	-20.20	peak	183	207
3	83.5222	38.37	-19.27	19.10	40.00	-20.90	peak	273	185
4	123.6985	35.98	-15.35	20.63	43.50	-22.87	peak	204	263
5	167.2368	33.33	-13.76	19.57	43.50	-23.93	peak	183	188
6	232.5318	35.26	-15.22	20.04	46.00	-25.96	peak	225	253

Remarks:

- 1.Emission Level = Read Level + Factor (Antenna Factor + Cable Loss - Preamp Factor)
- 2.Margin value = Emission level – Limit value

Lab: [Hwa-Hsing \(Dongguan\) Testing Co., Ltd.](#)

Address: [No.101, Building N1, Yuyuan 2 Road, Yuyuan Industrial Park, HuangJiang Town, Dongguan City, People's Republic of China](#)

Tel: [0769-83078199](tel:0769-83078199)

Web.: www.hwa-hsing.com

E-Mail: customerservice.dg@hwa-hsing.com

Release

[Ver. 1.5](#)

Frequency Range	30MHz ~ 1GHz	Detector Function	Peak (PK) Quasi-peak (QP)
Test Channel	Channel 0		

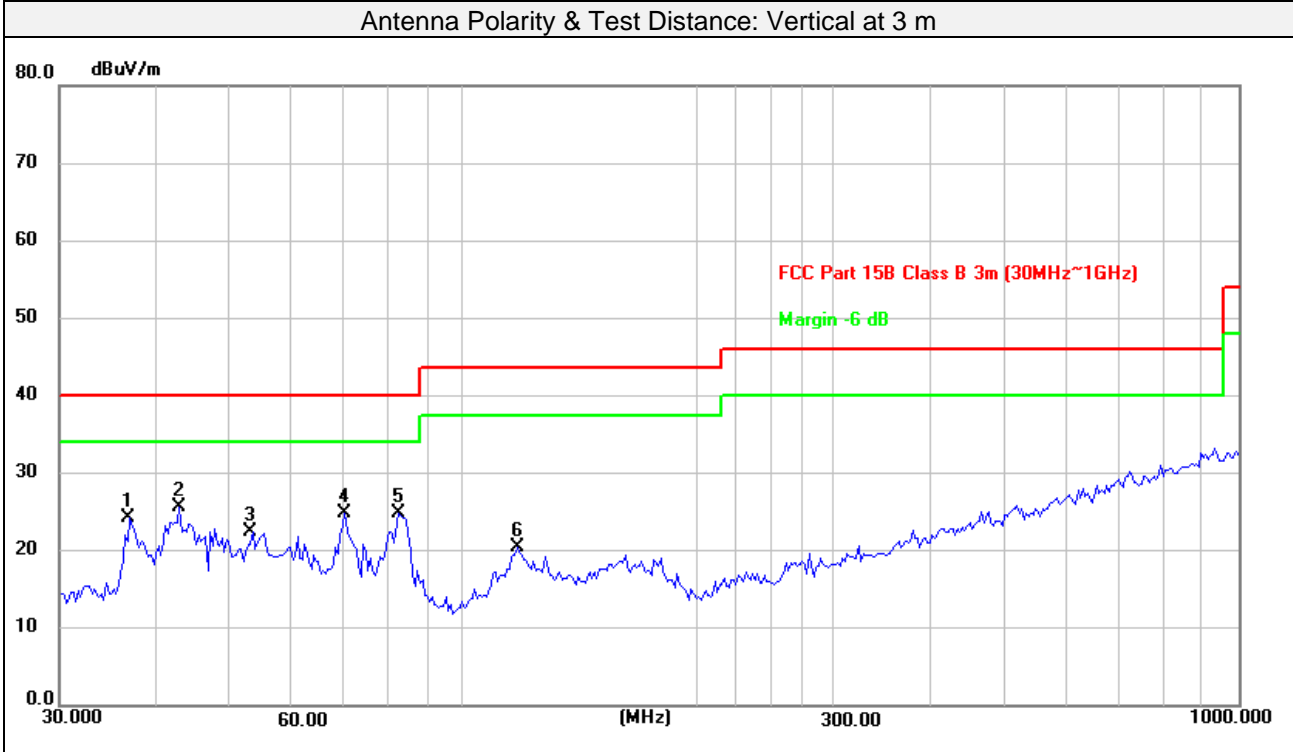

No.	Frequency (MHz)	Reading (dBuV)	Factor (dB)	Emission Level (dBuV/m)	Limit (dBuV/m)	Margin (dB)	Detector	Antenna Height (cm)	Table Angle (Degree)
1	37.0248	40.98	-16.78	24.20	40.00	-15.80	peak	127	21
2	42.8998	41.06	-15.34	25.72	40.00	-14.28	peak	134	234
3	53.3179	37.73	-15.20	22.53	40.00	-17.47	peak	152	108
4	70.0903	41.40	-16.54	24.86	40.00	-15.14	peak	112	205
5	82.3588	43.80	-18.97	24.83	40.00	-15.17	peak	105	227
6	116.9495	36.15	-15.73	20.42	43.50	-23.08	peak	116	326

Remarks:

1. Emission Level = Read Level + Factor (Antenna Factor + Cable Loss - Preamp Factor)
2. Margin value = Emission level – Limit value

Test Report No.: 24012105-RF-US-01

Frequency Range	30MHz ~ 1GHz	Detector Function	Peak (PK) Quasi-peak (QP)
Test Channel	JL7012 8DPSK 2480+JL7016 8DPSK 2441		

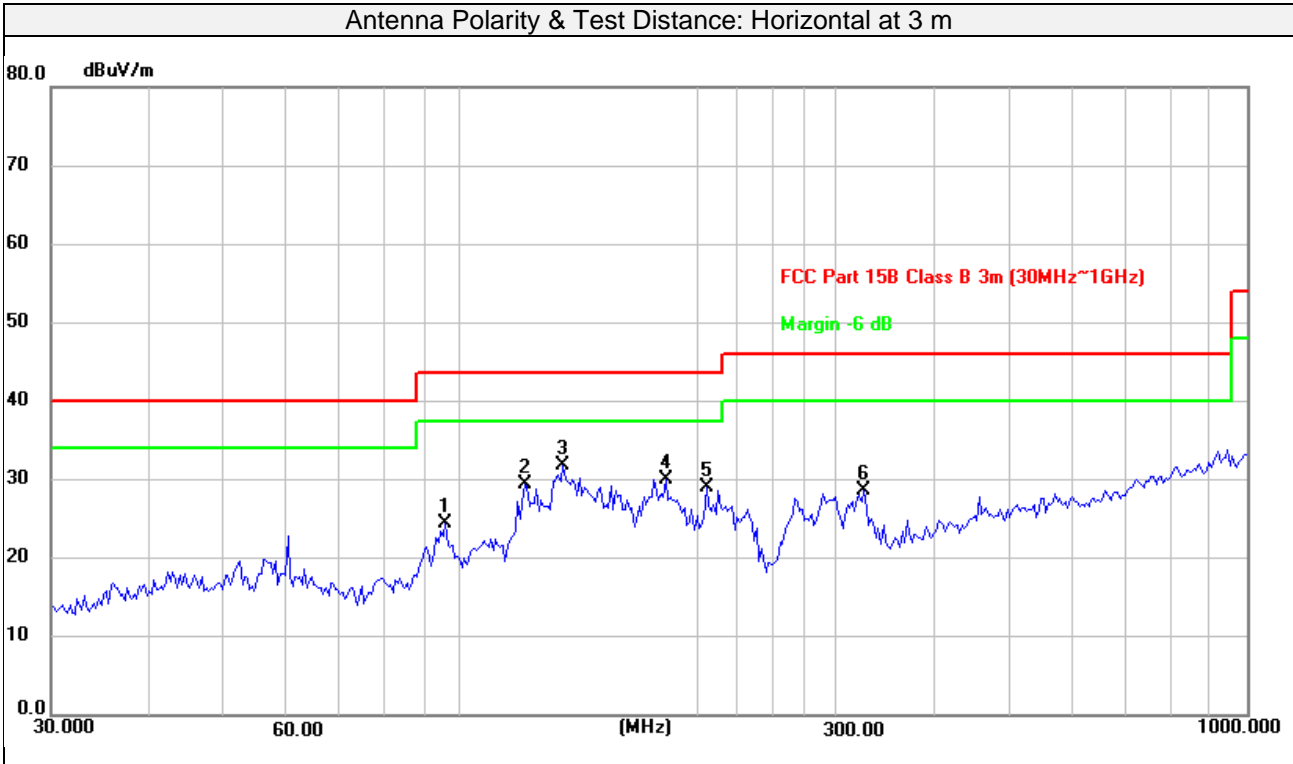

No.	Frequency (MHz)	Reading (dBuV)	Factor (dB)	Emission Level (dBuV/m)	Limit (dBuV/m)	Margin (dB)	Detector	Antenna Height (cm)	Table Angle (Degree)
1	95.4270	44.15	-19.63	24.52	43.50	-18.98	peak	160	13
2	120.2766	44.70	-15.34	29.36	43.50	-14.14	peak	200	234
3	134.5592	47.01	-15.20	31.81	43.50	-11.69	peak	240	194
4	181.9202	45.02	-15.05	29.97	43.50	-13.53	peak	130	168
5	204.9551	46.59	-17.52	29.07	43.50	-14.43	peak	200	147
6	325.5958	41.07	-12.52	28.55	46.00	-17.45	peak	200	259

Remarks:

1. Emission Level = Read Level + Factor (Antenna Factor + Cable Loss - Preamp Factor)
2. Margin value = Emission level – Limit value

Lab: [Hwa-Hsing \(Dongguan\) Testing Co., Ltd.](#)

Address: [No.101, Building N1, Yuyuan 2 Road, Yuyuan Industrial Park, HuangJiang Town, Dongguan City, People's Republic of China](#)

Tel: [0769-83078199](tel:0769-83078199)

Web.: www.hwa-hsing.com

E-Mail: customerservice.dg@hwa-hsing.com

Release

[Ver. 1.5](#)

Frequency Range	30MHz ~ 1GHz	Detector Function	Peak (PK) Quasi-peak (QP)
Test Channel	JL7012 8DPSK 2480+JL7016 8DPSK 2441		

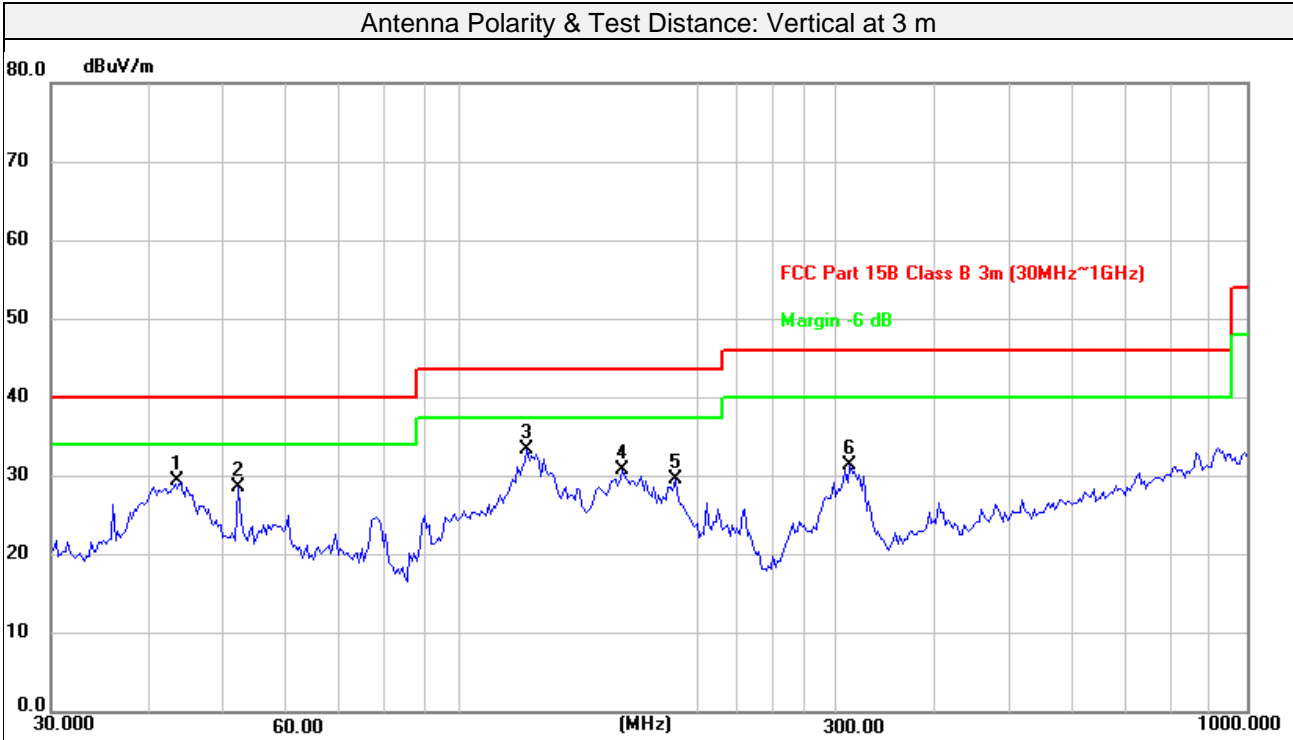

No.	Frequency (MHz)	Reading (dBuV)	Factor (dB)	Emission Level (dBuV/m)	Limit (dBuV/m)	Margin (dB)	Detector	Antenna Height (cm)	Table Angle (Degree)
1	43.8119	44.60	-15.13	29.47	40.00	-10.53	peak	100	165
2	51.8430	43.58	-15.02	28.56	40.00	-11.44	peak	100	110
3	121.1231	48.82	-15.34	33.48	43.50	-10.02	peak	100	259
4	160.3456	43.85	-13.09	30.76	43.50	-12.74	peak	100	92
5	187.0958	45.74	-16.07	29.67	43.50	-13.83	peak	100	158
6	312.1794	44.22	-12.80	31.42	46.00	-14.58	peak	100	208

Remarks:

1. Emission Level = Read Level + Factor (Antenna Factor + Cable Loss - Preamp Factor)
2. Margin value = Emission level – Limit value

Above 1GHz Data:

GFSK

Frequency Range	1GHz ~ 25GHz	Detector Function	Peak (PK) Average (AVG)
Test Channel	Channel 0		

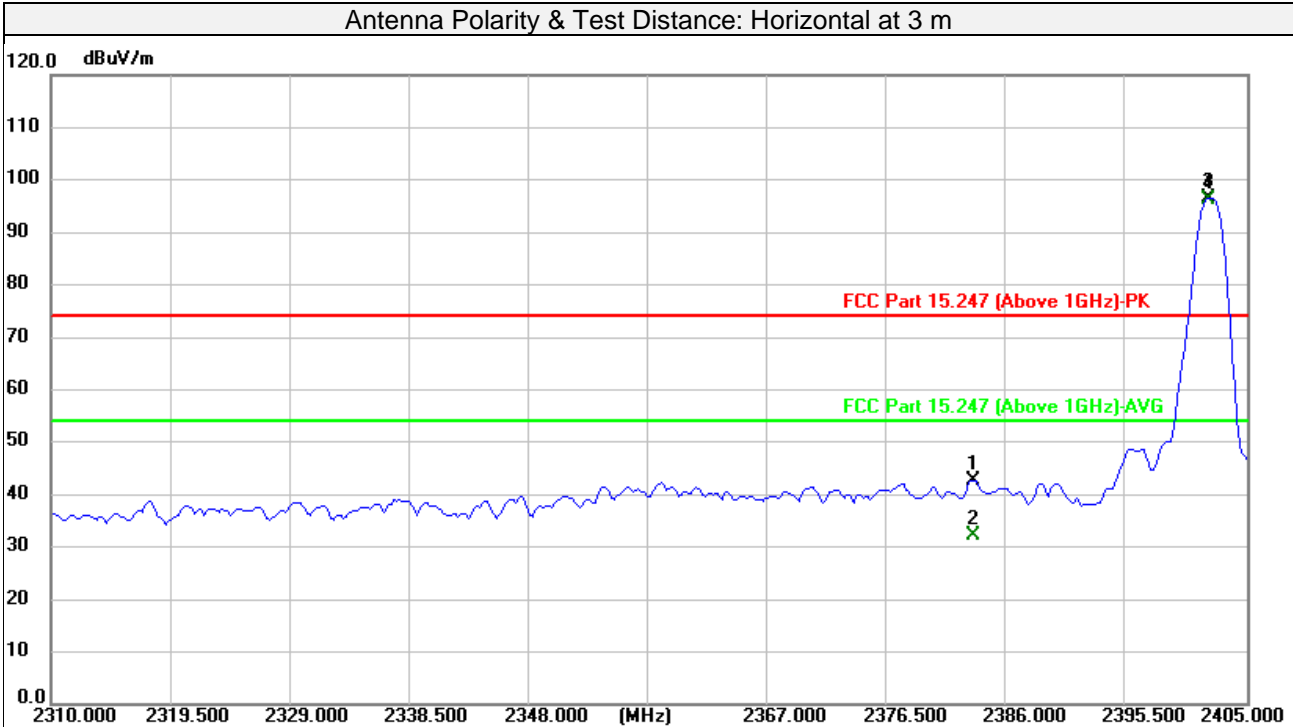

No.	Frequency (MHz)	Reading (dBuV)	Factor (dB)	Emission Level (dBuV/m)	Limit (dBuV/m)	Margin (dB)	Detector	Antenna Height (cm)	Table Angle (Degree)
1	2383.297	43.21	-0.43	42.78	74.00	-31.22	peak	286	180
2	2383.297	32.59	-0.43	32.16	54.00	-21.84	AVG	286	180
3#	2401.954	96.90	-0.39			22.51	peak	286	180
4#	2401.954	96.68	-0.39			42.29	AVG	286	180
5	4804.000	41.55	5.30	46.85	74.00	-27.15	peak	223	229
6	4804.000	37.05	5.30	42.35	54.00	-11.65	AVG	223	229
7	7206.000	41.05	12.40	53.45	74.00	-20.55	peak	176	108
8	7206.000	30.52	12.40	42.92	54.00	-11.08	AVG	176	108
9	9608.000	39.82	15.83	55.65	74.00	-18.35	peak	201	145
10	9608.000	31.74	15.83	47.57	54.00	-6.43	AVG	201	145

Remarks:

- Emission Level = Read Level + Factor (Antenna Factor + Cable Loss - Preamp Factor)
Margin value = Emission level – Limit value
- #2402MHz: Fundamental frequency.
- The amplitude of spurious emissions attenuated more than 20 dB below the permissible value is not required to be report.

Lab: [Hwa-Hsing \(Dongguan\) Testing Co., Ltd.](#)

Address: [No.101, Building N1, Yuyuan 2 Road, Yuyuan Industrial Park, HuangJiang Town, Dongguan City, People's Republic of China](#)

Tel: [0769-83078199](tel:0769-83078199)

Web.: www.hwa-hsing.com

E-Mail: customerservice.dg@hwa-hsing.com

Release

[Ver. 1.5](#)

Frequency Range	1GHz ~ 25GHz	Detector Function	Peak (PK) Average (AVG)
Test Channel	Channel 0		

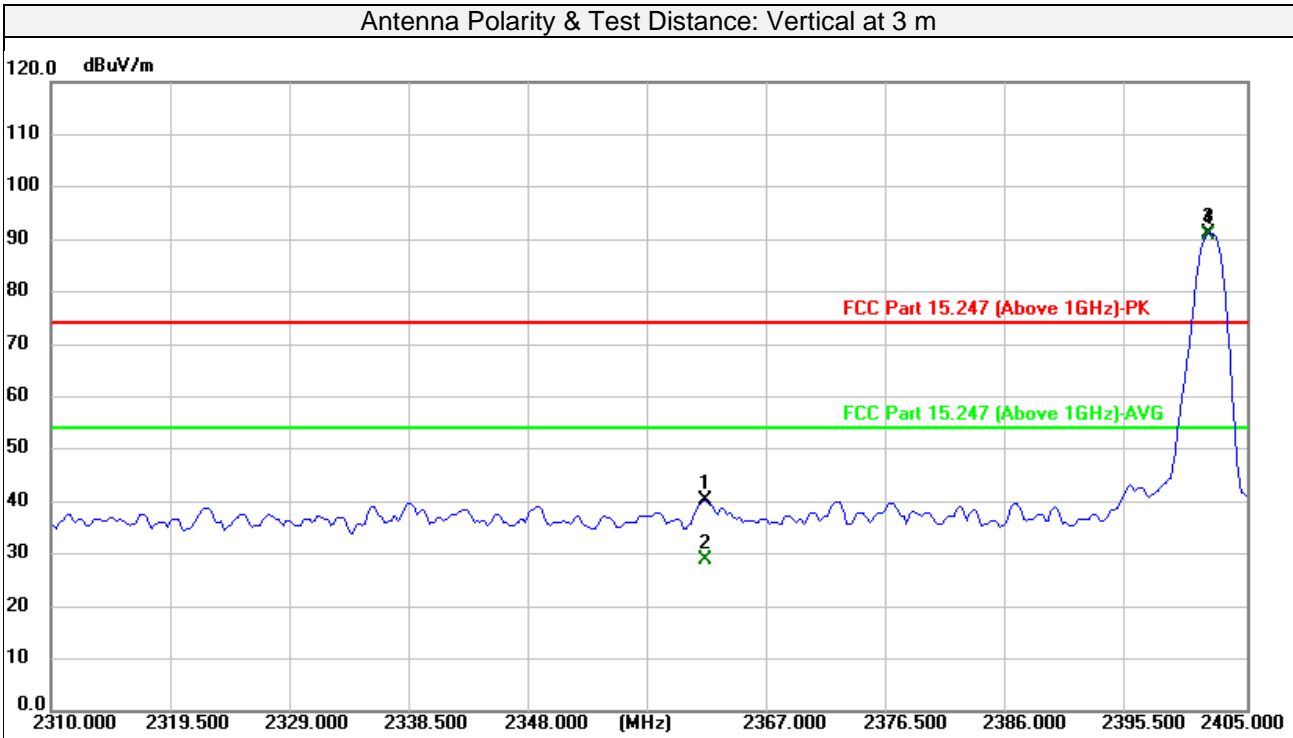

No.	Frequency (MHz)	Reading (dBuV)	Factor (dB)	Emission Level (dBuV/m)	Limit (dBuV/m)	Margin (dB)	Detector	Antenna Height (cm)	Table Angle (Degree)
1	2361.974	40.58	-0.47	40.11	74.00	-33.89	peak	337	230
2	2361.974	29.40	-0.47	28.93	54.00	-25.07	AVG	337	230
3#	2401.954	91.50	-0.39			17.11	peak	337	230
4#	2401.954	91.28	-0.39			36.89	AVG	337	230
5	4804.000	42.04	5.30	47.34	74.00	-26.66	peak	142	263
6	4804.000	36.04	5.30	41.34	54.00	-12.66	AVG	142	263
7	7206.000	41.18	12.40	53.58	74.00	-20.42	peak	139	178
8	7206.000	30.63	12.40	43.03	54.00	-10.97	AVG	139	178
9	9608.000	40.68	15.83	56.51	74.00	-17.49	peak	105	204
10	9608.000	31.82	15.83	47.65	54.00	-6.35	AVG	105	204

Remarks:

- Emission Level = Read Level + Factor (Antenna Factor + Cable Loss - Preamp Factor)
Margin value = Emission level – Limit value
- #2402MHz: Fundamental frequency.
- The amplitude of spurious emissions attenuated more than 20 dB below the permissible value is not required to be report.

Lab: [Hwa-Hsing \(Dongguan\) Testing Co., Ltd.](#)

Address: [No.101, Building N1, Yuyuan 2 Road, Yuyuan Industrial Park, HuangJiang Town, Dongguan City, People's Republic of China](#)

Tel: [0769-83078199](tel:0769-83078199)

Web.: www.hwa-hsing.com

E-Mail: customerservice.dg@hwa-hsing.com

Release

[Ver. 1.5](#)

Frequency Range	1GHz ~ 25GHz	Detector Function	Peak (PK) Average (AVG)
Test Channel	Channel 39		

Antenna Polarity & Test Distance: Horizontal at 3 m									
No.	Frequency (MHz)	Reading (dBuV)	Factor (dB)	Emission Level (dBuV/m)	Limit (dBuV/m)	Margin (dB)	Detector	Antenna Height (cm)	Table Angle (Degree)
1 #	2441.000	94.35	-0.30			20.05	peak	359	97
2 #	2441.000	94.06	-0.30			39.76	AVG	359	97
3	4882.000	40.79	6.27	47.06	74.00	-26.94	peak	210	326
4	4882.000	35.44	6.27	41.71	54.00	-12.29	AVG	210	326
5	7323.000	40.62	12.65	53.27	74.00	-20.73	peak	254	174
6	7323.000	30.48	12.65	43.13	54.00	-10.87	AVG	254	174
7	9764.000	41.91	16.24	58.15	74.00	-15.85	peak	119	126
8	9764.000	31.45	16.24	47.69	54.00	-6.31	AVG	119	126
Antenna Polarity & Test Distance: Vertical at 3 m									
No.	Frequency (MHz)	Reading (dBuV)	Factor (dB)	Emission Level (dBuV/m)	Limit (dBuV/m)	Margin (dB)	Detector	Antenna Height (cm)	Table Angle (Degree)
1 #	2441.000	95.50	-0.30			21.20	peak	365	107
2 #	2441.000	95.17	-0.30			40.87	AVG	365	107
3	4882.000	41.31	6.27	47.58	74.00	-26.42	peak	134	164
4	4882.000	36.01	6.27	42.28	54.00	-11.72	AVG	134	164
5	7323.000	40.60	12.65	53.25	74.00	-20.75	peak	108	185
6	7323.000	30.29	12.65	42.94	54.00	-11.06	AVG	108	185
7	9764.000	41.06	16.24	57.30	74.00	-16.70	peak	116	263
8	9764.000	30.78	16.24	47.02	54.00	-6.98	AVG	116	263

Remarks:

- Emission Level = Read Level + Factor (Antenna Factor + Cable Loss - Preamp Factor)
Margin value = Emission level – Limit value
- #2441MHz: Fundamental frequency.
- The amplitude of spurious emissions attenuated more than 20 dB below the permissible value is not required to be report.

Frequency Range	1GHz ~ 25GHz	Detector Function	Peak (PK) Average (AVG)
Test Channel	Channel 78		

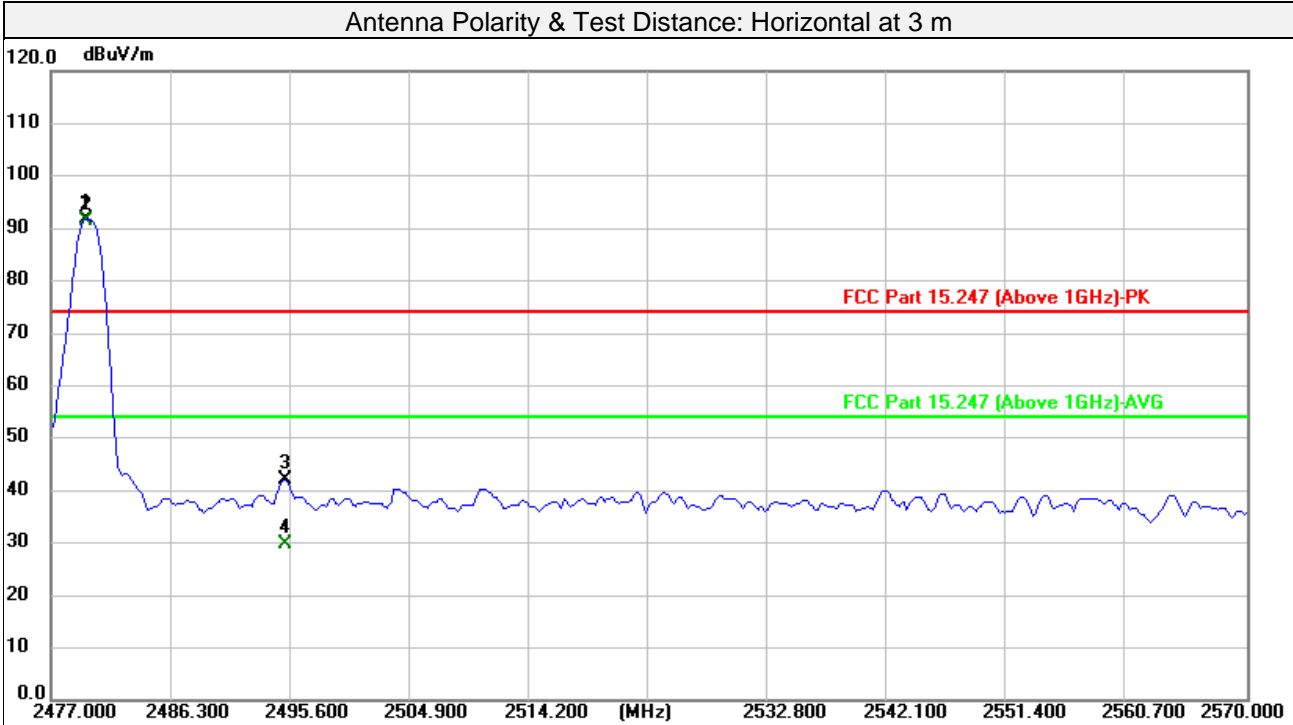

No.	Frequency (MHz)	Reading (dBuV)	Factor (dB)	Emission Level (dBuV/m)	Limit (dBuV/m)	Margin (dB)	Detector	Antenna Height (cm)	Table Angle (Degree)
1#	2479.796	91.96	-0.21			17.75	peak	388	118
2#	2479.796	91.72	-0.21			37.51	AVG	388	118
3	2495.265	42.15	-0.18	41.97	74.00	-32.03	peak	388	118
4	2495.265	29.94	-0.18	29.76	54.00	-24.24	AVG	388	118
5	4960.000	41.77	6.16	47.93	74.00	-26.07	peak	164	166
6	4960.000	33.15	6.16	39.31	54.00	-14.69	AVG	164	166
7	7440.000	39.91	12.91	52.82	74.00	-21.18	peak	195	185
8	7440.000	30.00	12.91	42.91	54.00	-11.09	AVG	195	185
9	9920.000	40.64	16.68	57.32	74.00	-16.68	peak	214	304
10	9920.000	32.36	16.68	49.04	54.00	-4.96	AVG	214	304

Remarks:

- Emission Level = Read Level + Factor (Antenna Factor + Cable Loss - Preamp Factor)
Margin value = Emission level – Limit value
- #2480MHz: Fundamental frequency.
- The amplitude of spurious emissions attenuated more than 20 dB below the permissible value is not required to be report.

Lab: [Hwa-Hsing \(Dongguan\) Testing Co., Ltd.](#)

Address: [No.101, Building N1, Yuyuan 2 Road, Yuyuan Industrial Park, HuangJiang Town, Dongguan City, People's Republic of China](#)

Tel: [0769-83078199](tel:0769-83078199)

Web.: www.hwa-hsing.com

E-Mail: customerservice.dg@hwa-hsing.com

Release

[Ver. 1.5](#)

Frequency Range	1GHz ~ 25GHz	Detector Function	Peak (PK) Average (AVG)
Test Channel	Channel 78		

Antenna Polarity & Test Distance: Vertical at 3 m

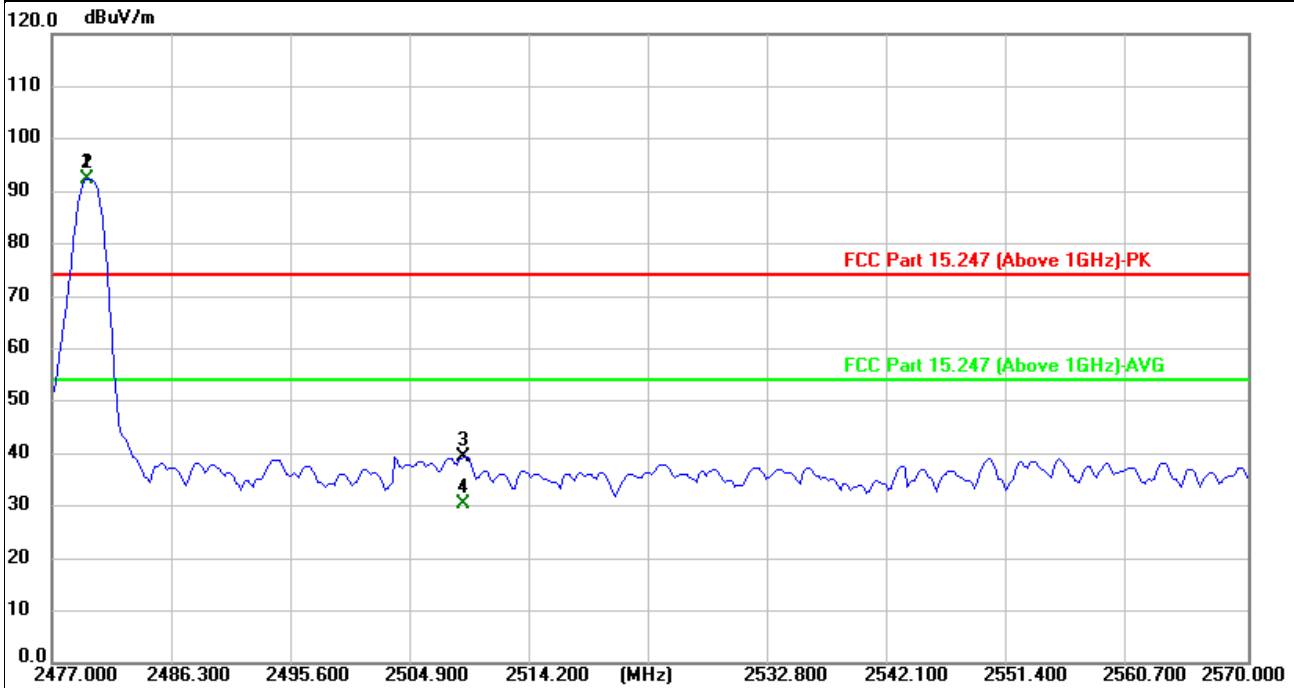

No.	Frequency (MHz)	Reading (dBuV)	Factor (dB)	Emission Level (dBuV/m)	Limit (dBuV/m)	Margin (dB)	Detector	Antenna Height (cm)	Table Angle (Degree)
1#	2479.796	92.64	-0.21			18.43	peak	393	116
2#	2479.796	92.39	-0.21			38.18	AVG	393	116
3	2509.056	39.56	-0.15			-34.59	peak	393	116
4	2509.056	30.63	-0.15	30.48	54.00	-23.52	AVG	393	116
5	4960.000	40.70	6.16	46.86	74.00	-27.14	peak	125	307
6	4960.000	32.85	6.16	39.01	54.00	-14.99	AVG	125	307
7	7440.000	40.70	12.91	53.61	74.00	-20.39	peak	110	195
8	7440.000	30.00	12.91	42.91	54.00	-11.09	AVG	110	195
9	9920.000	40.70	16.68	57.38	74.00	-16.62	peak	148	246
10	9920.000	32.23	16.68	48.91	54.00	-5.09	AVG	148	246

Remarks:

- Emission Level = Read Level + Factor (Antenna Factor + Cable Loss - Preamp Factor)
Margin value = Emission level – Limit value
- #2480MHz: Fundamental frequency.
- The amplitude of spurious emissions attenuated more than 20 dB below the permissible value is not required to be report.

Lab: [Hwa-Hsing \(Dongguan\) Testing Co., Ltd.](#)

Address: [No.101, Building N1, Yuyuan 2 Road, Yuyuan Industrial Park, HuangJiang Town, Dongguan City, People's Republic of China](#)

Tel: [0769-83078199](tel:0769-83078199)

Web.: www.hwa-hsing.com

E-Mail: customerservice.dg@hwa-hsing.com

Release

[Ver. 1.5](#)

8DPSK

Frequency Range	1GHz ~ 25GHz	Detector Function	Peak (PK) Average (AVG)
Test Channel	Channel 0		

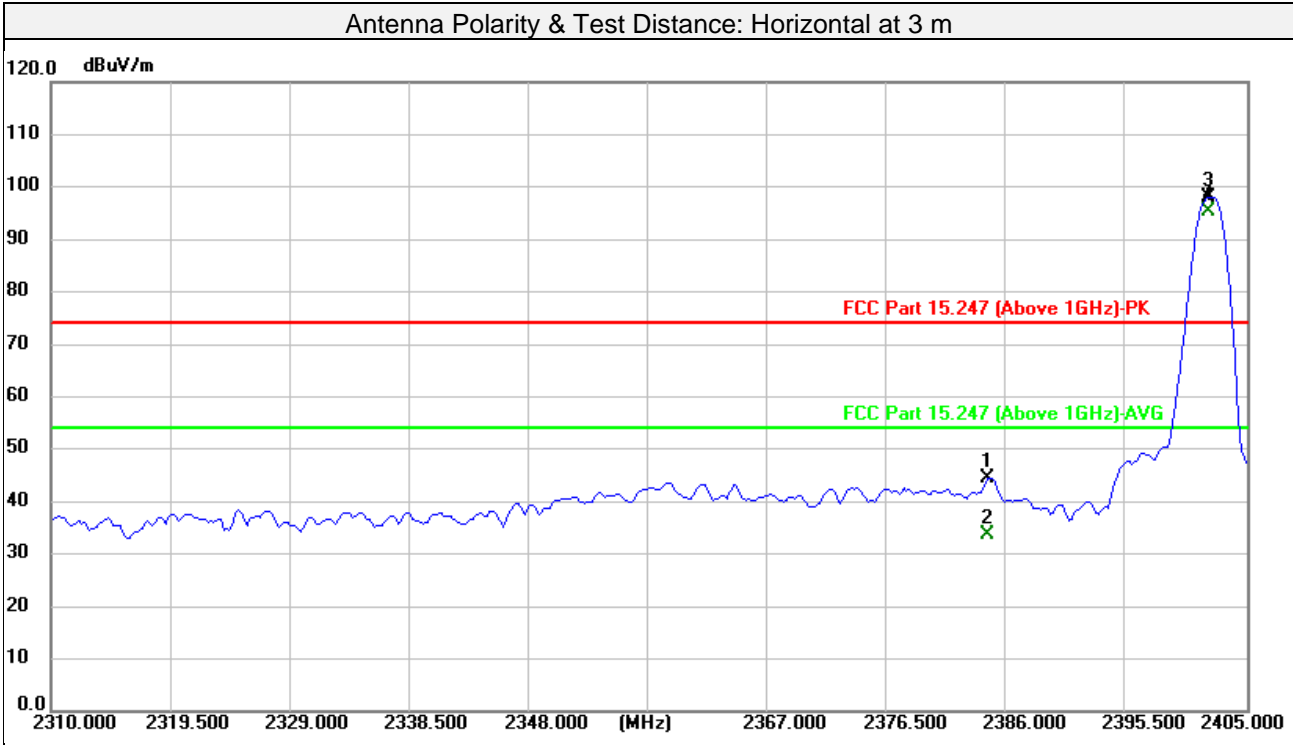

No.	Frequency (MHz)	Reading (dBuV)	Factor (dB)	Emission Level (dBuV/m)	Limit (dBuV/m)	Margin (dB)	Detector	Antenna Height (cm)	Table Angle (Degree)
1	2384.629	44.93	-0.42	44.51	74.00	-29.49	peak	260	181
2	2384.629	33.94	-0.42	33.52	54.00	-20.48	AVG	260	181
3#	2401.954	98.54	-0.39			24.15	peak	260	181
4#	2401.954	95.56	-0.39			41.17	AVG	260	181
5	4804.000	41.85	5.30	47.15	74.00	-26.85	peak	201	184
6	4804.000	34.03	5.30	39.33	54.00	-14.67	AVG	201	184
7	7206.000	41.10	12.40	53.50	74.00	-20.50	peak	115	216
8	7206.000	30.37	12.40	42.77	54.00	-11.23	AVG	115	216
9	9608.000	41.15	15.83	56.98	74.00	-17.02	peak	236	137
10	9608.000	32.49	15.83	48.32	54.00	-5.68	AVG	236	137

Remarks:

- Emission Level = Read Level + Factor (Antenna Factor + Cable Loss - Preamp Factor)
Margin value = Emission level – Limit value
- #2402MHz: Fundamental frequency.
- The amplitude of spurious emissions attenuated more than 20 dB below the permissible value is not required to be report.

Lab: [Hwa-Hsing \(Dongguan\) Testing Co., Ltd.](#)

Address: [No.101, Building N1, Yuyuan 2 Road, Yuyuan Industrial Park, HuangJiang Town, Dongguan City, People's Republic of China](#)

Tel: [0769-83078199](tel:0769-83078199)

Web.: www.hwa-hsing.com

E-Mail: customerservice.dg@hwa-hsing.com

Release

[Ver. 1.5](#)

Frequency Range	1GHz ~ 25GHz	Detector Function	Peak (PK) Average (AVG)
Test Channel	Channel 0		

Antenna Polarity & Test Distance: Vertical at 3 m

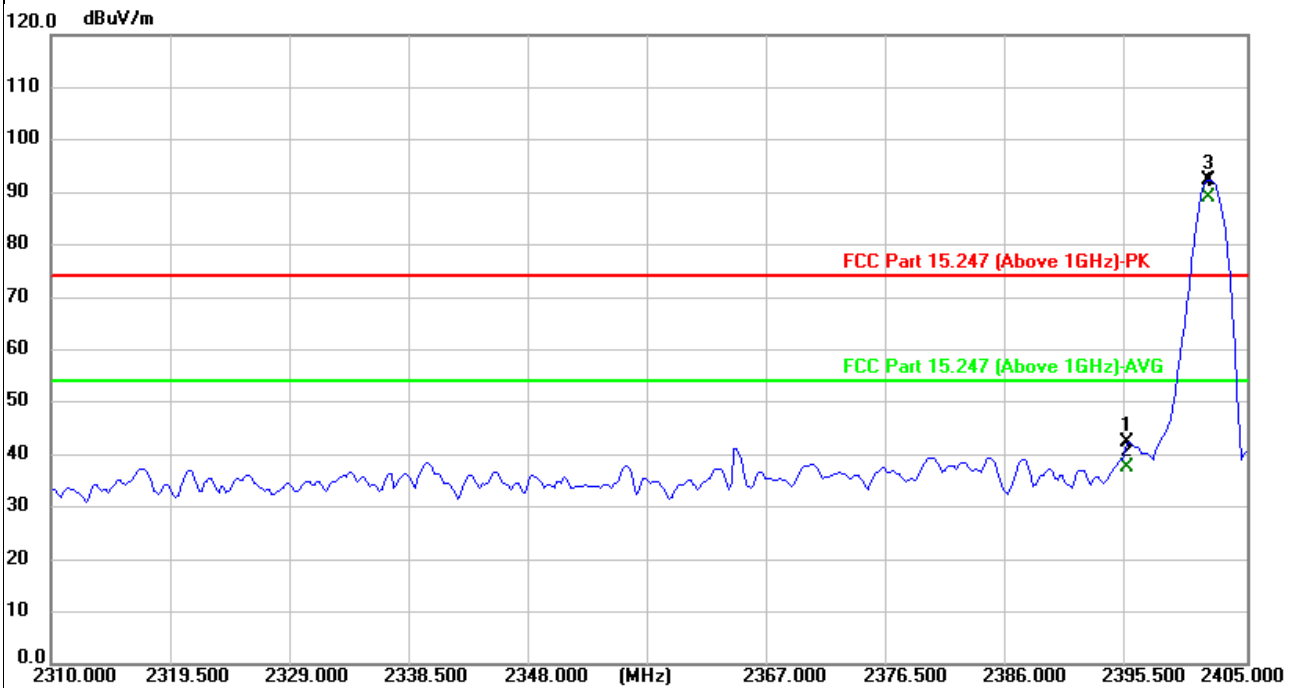

No.	Frequency (MHz)	Reading (dBuV)	Factor (dB)	Emission Level (dBuV/m)	Limit (dBuV/m)	Margin (dB)	Detector	Antenna Height (cm)	Table Angle (Degree)
1	2395.671	42.60	-0.40	42.20	74.00	-31.80	peak	302	230
2	2395.671	37.95	-0.40	37.55	54.00	-16.45	AVG	302	230
3#	2401.954	92.81	-0.39			18.42	peak	302	230
4#	2401.954	89.42	-0.39			35.03	AVG	302	230
5	4804.000	40.89	5.30	46.19	74.00	-27.81	peak	126	115
6	4804.000	33.66	5.30	38.96	54.00	-15.04	AVG	126	115
7	7206.000	41.77	12.40	54.17	74.00	-19.83	peak	130	207
8	7206.000	30.42	12.40	42.82	54.00	-11.18	AVG	130	207
9	9608.000	40.67	15.83	56.50	74.00	-17.50	peak	115	94
10	9608.000	32.06	15.83	47.89	54.00	-6.11	AVG	115	94

Remarks:

- Emission Level = Read Level + Factor (Antenna Factor + Cable Loss - Preamp Factor)
Margin value = Emission level – Limit value
- #2402MHz: Fundamental frequency.
- The amplitude of spurious emissions attenuated more than 20 dB below the permissible value is not required to be report.

Lab: [Hwa-Hsing \(Dongguan\) Testing Co., Ltd.](#)

Address: [No.101, Building N1, Yuyuan 2 Road, Yuyuan Industrial Park, HuangJiang Town, Dongguan City, People's Republic of China](#)

Tel: [0769-83078199](tel:0769-83078199)

Web.: www.hwa-hsing.com

E-Mail: customerservice.dg@hwa-hsing.com

Release

Ver. 1.5

Frequency Range	1GHz ~ 25GHz	Detector Function	Peak (PK) Average (AVG)
Test Channel	Channel 39		

Antenna Polarity & Test Distance: Horizontal at 3 m									
No.	Frequency (MHz)	Reading (dBuV)	Factor (dB)	Emission Level (dBuV/m)	Limit (dBuV/m)	Margin (dB)	Detector	Antenna Height (cm)	Table Angle (Degree)
1#	2441.000	101.29	-0.30				peak	280	186
2#	2441.000	98.55	-0.30				AVG	280	186
3	4882.000	40.36	6.27	46.63	74.00	-27.37	peak	133	338
4	4882.000	32.47	6.27	38.74	54.00	-15.26	AVG	133	338
5	7323.000	40.47	12.65	53.12	74.00	-20.88	peak	186	204
6	7323.000	30.23	12.65	42.88	54.00	-11.12	AVG	186	204
7	9764.000	40.89	16.24	57.13	74.00	-16.87	peak	201	55
8	9764.000	31.58	16.24	47.82	54.00	-6.18	AVG	201	55
Antenna Polarity & Test Distance: Vertical at 3 m									
No.	Frequency (MHz)	Reading (dBuV)	Factor (dB)	Emission Level (dBuV/m)	Limit (dBuV/m)	Margin (dB)	Detector	Antenna Height (cm)	Table Angle (Degree)
1#	2441.000	90.57	-0.30			16.27	peak	100	124
2#	2441.000	87.91	-0.30			33.61	AVG	100	124
3	4882.000	43.04	6.27	49.31	74.00	-24.69	peak	102	268
4	4882.000	33.19	6.27	39.46	54.00	-14.54	AVG	102	268
5	7323.000	40.99	12.65	53.64	74.00	-20.36	peak	112	226
6	7323.000	29.98	12.65	42.63	54.00	-11.37	AVG	112	226
7	9764.000	40.56	16.24	56.80	74.00	-17.20	peak	135	204
8	9764.000	31.58	16.24	47.82	54.00	-6.18	AVG	135	204

Remarks:

- Emission Level = Read Level + Factor (Antenna Factor + Cable Loss - Preamp Factor)
Margin value = Emission level – Limit value
- #2441MHz: Fundamental frequency.
- The amplitude of spurious emissions attenuated more than 20 dB below the permissible value is not required to be report.

Frequency Range	1GHz ~ 25GHz	Detector Function	Peak (PK) Average (AVG)
Test Channel	Channel 78		

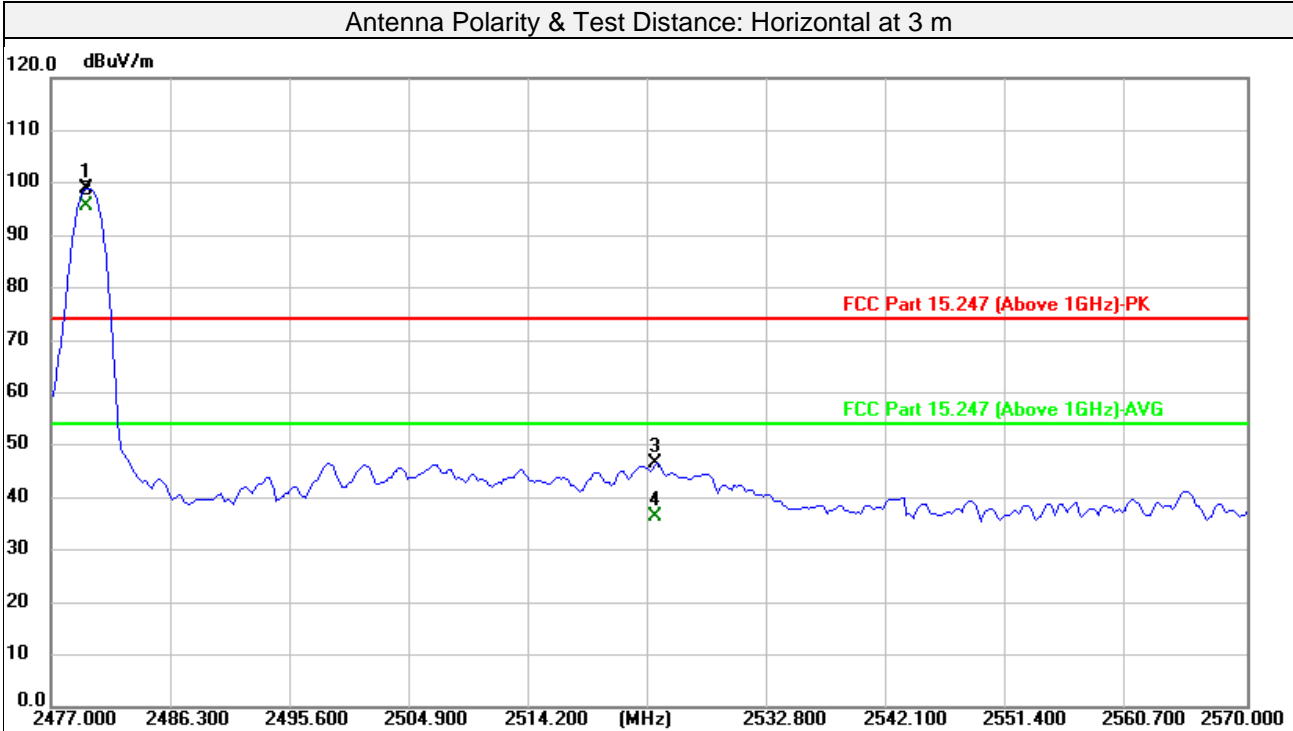

No.	Frequency (MHz)	Reading (dBuV)	Factor (dB)	Emission Level (dBuV/m)	Limit (dBuV/m)	Margin (dB)	Detector	Antenna Height (cm)	Table Angle (Degree)
1#	2479.796	99.19	-0.21			24.98	peak	297	192
2#	2479.796	95.91	-0.21			41.70	AVG	297	192
3	2524.152	46.54	-0.11	46.43	74.00	-27.57	peak	297	192
4	2524.152	36.53	-0.11	36.42	54.00	-17.58	AVG	297	192
5	4960.000	42.19	6.16	48.35	74.00	-25.65	peak	189	165
6	4960.000	33.62	6.16	39.78	54.00	-14.22	AVG	189	165
7	7440.000	41.40	12.91	54.31	74.00	-19.69	peak	152	337
8	7440.000	30.03	12.91	42.94	54.00	-11.06	AVG	152	337
9	9920.000	41.75	16.68	58.43	74.00	-15.57	peak	100	218
10	9920.000	33.04	16.68	49.72	54.00	-4.28	AVG	100	218

Remarks:

- Emission Level = Read Level + Factor (Antenna Factor + Cable Loss - Preamp Factor)
Margin value = Emission level – Limit value
- #2480MHz: Fundamental frequency.
- The amplitude of spurious emissions attenuated more than 20 dB below the permissible value is not required to be report.

Frequency Range	1GHz ~ 25GHz	Detector Function	Peak (PK) Average (AVG)
Test Channel	Channel 78		

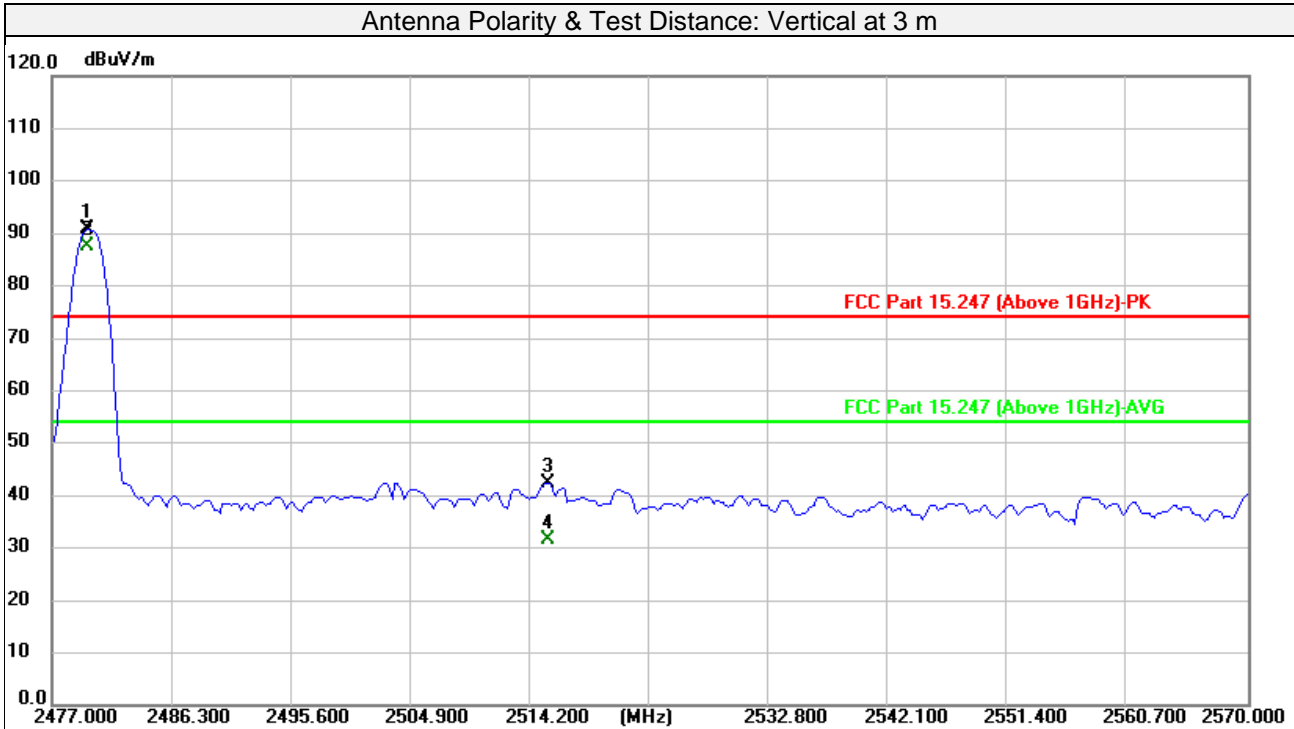

No.	Frequency (MHz)	Reading (dBuV)	Factor (dB)	Emission Level (dBuV/m)	Limit (dBuV/m)	Margin (dB)	Detector	Antenna Height (cm)	Table Angle (Degree)
1#	2479.796	90.89	-0.21			16.68	peak	100	125
2#	2479.796	87.87	-0.21			33.66	AVG	100	125
3	2515.579	42.47	-0.14	42.33	74.00	-31.67	peak	100	125
4	2515.579	31.83	-0.14	31.69	54.00	-22.31	AVG	100	125
5	4960.000	41.54	6.16	47.70	74.00	-26.30	peak	214	315
6	4960.000	34.47	6.16	40.63	54.00	-13.37	AVG	214	315
7	7440.000	40.68	12.91	53.59	74.00	-20.41	peak	105	236
8	7440.000	29.95	12.91	42.86	54.00	-11.14	AVG	105	236
9	9920.000	41.75	16.68	58.43	74.00	-15.57	peak	276	260
10	9920.000	33.08	16.68	49.76	54.00	-4.24	AVG	276	260

Remarks:

- Emission Level = Read Level + Factor (Antenna Factor + Cable Loss - Preamp Factor)
Margin value = Emission level – Limit value
- #2480MHz: Fundamental frequency.
- The amplitude of spurious emissions attenuated more than 20 dB below the permissible value is not required to be report.

Lab: [Hwa-Hsing \(Dongguan\) Testing Co., Ltd.](#)

Address: [No.101, Building N1, Yuyuan 2 Road, Yuyuan Industrial Park, HuangJiang Town, Dongguan City, People's Republic of China](#)

Tel: [0769-83078199](tel:0769-83078199)

Web.: www.hwa-hsing.com

E-Mail: customerservice.dg@hwa-hsing.com

Release

[Ver. 1.5](#)

JL7012+JL7016

Frequency Range	1GHz ~ 25GHz	Detector Function	Peak (PK) Average (AVG)
Test Channel	JL7012 8DPSK 2480+JL7016 8DPSK 2441		

Antenna Polarity & Test Distance: Horizontal at 3 m

No.	Frequency (MHz)	Reading (dBuV)	Factor (dB)	Emission Level (dBuV/m)	Limit (dBuV/m)	Margin (dB)	Detector	Antenna Height (cm)	Table Angle (Degree)
1#	2441.000	101.73	-0.30	101.43			peak	289	130
2#	2441.000	56.47	-0.30	56.17			AVG	289	130
3#	2480.000	100.53	-0.21	100.32			peak	139	234
4#	2480.000	64.49	-0.21	64.28			AVG	139	234
5	4882.000	41.02	6.27	47.29	74.00	-26.71	peak	234	30
6	4882.000	34.98	6.27	41.25	54.00	-12.75	AVG	234	30
7	4960.000	40.21	6.16	46.37	74.00	-27.63	peak	347	119
8	4960.000	34.91	6.16	41.07	54.00	-12.93	AVG	347	119
9	7323.000	39.57	12.65	52.22	74.00	-21.78	peak	376	188
10	7323.000	28.38	12.65	41.03	54.00	-12.97	AVG	376	188
11	7440.000	39.28	12.91	52.19	74.00	-21.81	peak	274	184
12	7440.000	29.25	12.91	42.16	54.00	-11.84	AVG	274	184
13	9764.000	36.63	16.24	52.87	74.00	-21.13	peak	222	185
14	9764.000	29.17	16.24	45.41	54.00	-8.59	AVG	222	185
15	9920.000	39.37	16.68	56.05	74.00	-17.95	peak	220	126
16	9920.000	32.28	16.68	48.96	54.00	-5.04	AVG	220	126

Antenna Polarity & Test Distance: Vertical at 3 m

No.	Frequency (MHz)	Reading (dBuV)	Factor (dB)	Emission Level (dBuV/m)	Limit (dBuV/m)	Margin (dB)	Detector	Antenna Height (cm)	Table Angle (Degree)
1#	2441.000	53.47	-0.30	53.17			peak	113	172
2#	2441.000	96.32	-0.30	96.02			AVG	113	172
3#	2480.000	95.85	-0.21	95.64			peak	365	319
4#	2480.000	59.94	-0.21	59.73			AVG	365	319
5	4882.000	41.05	6.27	47.32	74.00	-26.68	peak	267	195
6	4882.000	34.81	6.27	41.08	54.00	-12.92	AVG	267	195
7	4960.000	40.83	6.16	46.99	74.00	-27.01	peak	380	229
8	4960.000	36.71	6.16	42.87	54.00	-11.13	AVG	380	229
9	7323.000	39.78	12.65	52.43	74.00	-21.57	peak	259	323
10	7323.000	30.15	12.65	42.80	54.00	-11.20	AVG	259	323
11	7440.000	40.73	12.91	53.64	74.00	-20.36	peak	280	164
12	7440.000	29.75	12.91	42.66	54.00	-11.34	AVG	280	164
13	9764.000	40.80	16.24	57.04	74.00	-16.96	peak	166	276
14	9764.000	30.73	16.24	46.97	54.00	-7.03	AVG	166	276
15	9920.000	39.15	16.68	55.83	74.00	-18.17	peak	169	247
16	9920.000	29.93	16.68	46.61	54.00	-7.39	AVG	169	247

Lab: [Hwa-Hsing \(Dongguan\) Testing Co., Ltd.](#)

Address: [No.101, Building N1, Yuyuan 2 Road, Yuyuan Industrial Park, HuangJiang Town, Dongguan City, People's Republic of China](#)

Tel: [0769-83078199](tel:0769-83078199)

Web.: www.hwa-hsing.com

E-Mail: customerservice.dg@hwa-hsing.com

Release

[Ver. 1.5](#)

Test Report No.: 24012105-RF-US-01

Remarks:

1. Emission Level = Read Level + Factor (Antenna Factor + Cable Loss - Preamp Factor)
Margin value = Emission level – Limit value
2. The amplitude of spurious emissions attenuated more than 20 dB below the permissible value is not required to be report.
3. #2480MHzউMHz: Fundamental frequency.
4. This data is tested under JL7012 and JL7016 emission state.

Lab: [Hwa-Hsing \(Dongguan\) Testing Co., Ltd.](#)Address: [No.101, Building N1, Yuyuan 2 Road, Yuyuan Industrial Park, HuangJiang Town, Dongguan City, People's Republic of China](#)Tel: [0769-83078199](#)Web.: [www.hwa-hsing.com](#)E-Mail: customerservice.dg@hwa-hsing.comRelease
[Ver. 1.5](#)

3.2 Conducted Emission Measurement

3.2.1 Limits of Conducted Emission Measurement

Frequency (MHz)	Conducted Limit (dBuV)	
	Quasi-peak	Average
0.15 - 0.5	66 - 56	56 - 46
0.50 - 5.0	56	46
5.0 - 30.0	60	50

- Note: 1. The lower limit shall apply at the transition frequencies.
2. The limit decreases in line with the logarithm of the frequency in the range of 0.15 to 0.50MHz.

3.2.2 Test Instruments

Equipment	Manufacturer	Model No.	Serial No.	Next Cal.
EMI Test Receiver	Rohde&Schwarz	ESR 7	101962	2024-12-17
Artificial Mains Network	Rohde&Schwarz	ENV216	3560.6550.15	2024-12-17
Test software	FARAD	EZ_EMV V1.1.4.2	N/A	N/A
Broadcast test system	R&S	SFU	100410	2024-08-06

- Note: 1. The calibration interval of the above test instruments is 12 months.
2. The test was performed in Shielded Room.

Test Report No.: 24012105-RF-US-01

3.2.3 Test Procedures

- a. The EUT was placed 0.4 meters from the conducting wall of the shielded room with EUT being connected to the power mains through a line impedance stabilization network (LISN). Other support units were connected to the power mains through another LISN. The two LISNs provide 50 ohm/ 50uH of coupling impedance for the measuring instrument.
- b. Both lines of the power mains connected to the EUT were checked for maximum conducted interference.
- c. The frequency range from 150kHz to 30MHz was searched. Emission levels under (Limit – 20dB) was not recorded.

Note: All modes of operation were investigated and the worst-case emissions are reported.

3.2.4 Test Setup

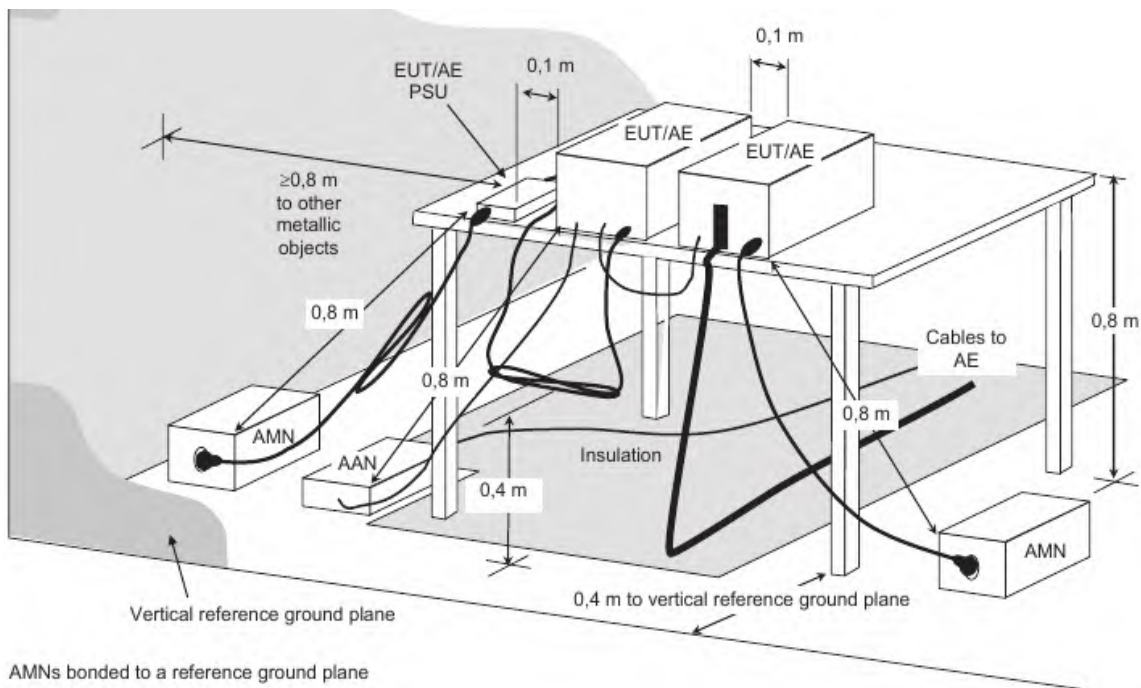

For the actual test configuration, please refer to the attached file (Test Setup Photo).

3.2.5 EUT Operating Condition

Set the EUT under transmission condition continuously at specific channel frequency.

3.2.6 Deviation from Test Standard

No deviation.

Lab: [Hwa-Hsing \(Dongguan\) Testing Co., Ltd.](#)

Address: [No.101, Building N1, Yuyuan 2 Road, Yuyuan Industrial Park, HuangJiang Town, Dongguan City, People's Republic of China](#)

Tel: [0769-83078199](#)

Web.: [www.hwa-hsing.com](#)

E-Mail: customerservice.dg@hwa-hsing.com

Release

[Ver. 1.5](#)

3.2.7 Test Results

Frequency Range	150kHz ~ 30MHz	Detector Function & Resolution bandwidth	Quasi-Peak (QP) / Average (AV), 9kHz
-----------------	----------------	--	--------------------------------------

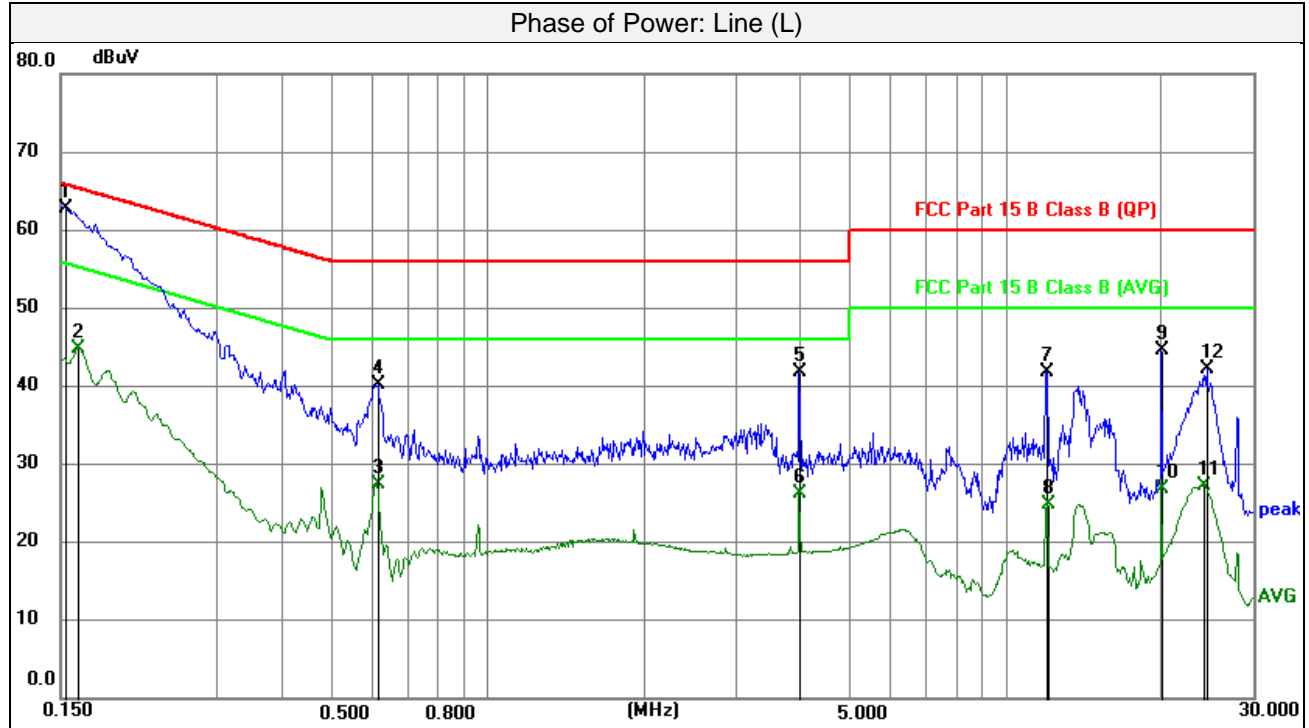

No.	Frequency (MHz)	Reading (dBuV)	Correction Factor (dB)	Emission Level (dBuV)	Limit (dBuV)	Margin (dB)	Remark
1	0.1532	52.61	10.18	62.79	65.82	-3.03	peak
2	0.1613	34.63	10.17	44.80	55.40	-10.60	AVG
3	0.6112	17.39	10.10	27.49	46.00	-18.51	AVG
4	0.6157	30.06	10.10	40.16	56.00	-15.84	peak
5	3.9998	31.70	10.10	41.80	56.00	-14.20	peak
6	3.9998	16.13	10.10	26.23	46.00	-19.77	AVG
7	11.9940	31.63	10.17	41.80	60.00	-18.20	peak
8	12.0008	14.68	10.17	24.85	50.00	-25.15	AVG
9	20.0018	34.15	10.40	44.55	60.00	-15.45	peak
10	20.0018	16.50	10.40	26.90	50.00	-23.10	AVG
11	24.0855	16.96	10.37	27.33	50.00	-22.67	AVG
12	24.4028	31.83	10.37	42.20	60.00	-17.80	peak

Remarks:

1. Q.P. and AV. are abbreviations of quasi-peak and average individually.
2. The emission levels of other frequencies were very low against the limit.
3. Margin value = Emission level - Limit value
4. Correction factor = Insertion loss + Cable loss
5. Emission Level = Correction Factor + Reading Value.

Lab: [Hwa-Hsing \(Dongguan\) Testing Co., Ltd.](#)

Address: [No.101, Building N1, Yuyuan 2 Road, Yuyuan Industrial Park, HuangJiang Town, Dongguan City, People's Republic of China](#)

Tel: [0769-83078199](tel:0769-83078199)

Web.: www.hwa-hsing.com

E-Mail: customerservice.dg@hwa-hsing.com

Release

[Ver. 1.5](#)

Frequency Range	150kHz ~ 30MHz	Detector Function & Resolution andwidth	Quasi-Peak (QP) / Average (AV), 9kHz
-----------------	----------------	---	--------------------------------------

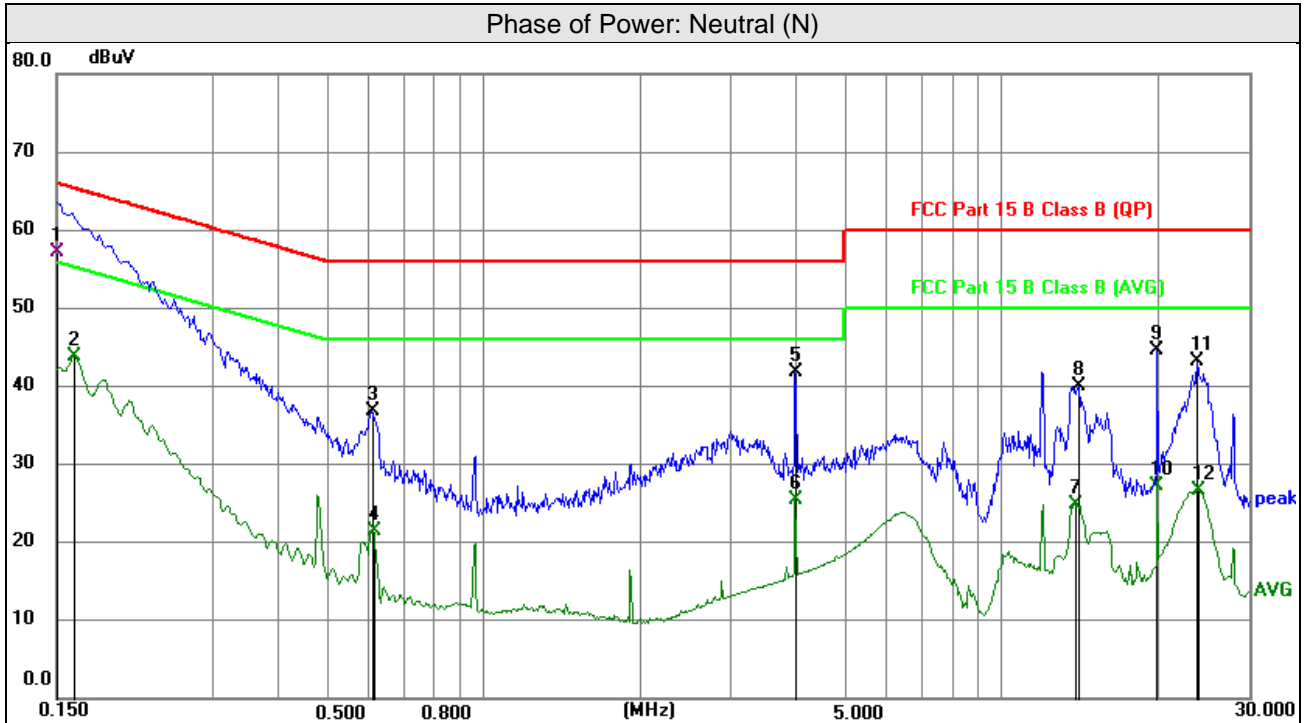

No.	Frequency (MHz)	Reading (dBuV)	Correct Factor (dB)	Emission Level (dBuV)	Limit (dBuV)	Margin (dB)	Remark
1	0.1500	46.95	10.19	57.14	66.00	-8.86	QP
2	0.1613	33.65	10.17	43.82	55.40	-11.58	AVG
3	0.6090	26.66	10.10	36.76	56.00	-19.24	peak
4	0.6112	11.41	10.10	21.51	46.00	-24.49	AVG
5	3.9998	31.67	10.10	41.77	56.00	-14.23	peak
6	3.9998	15.39	10.10	25.49	46.00	-20.51	AVG
7	13.8165	14.56	10.25	24.81	50.00	-25.19	AVG
8	14.0730	29.76	10.25	40.01	60.00	-19.99	peak
9	19.9995	34.15	10.40	44.55	60.00	-15.45	peak
10	19.9995	16.80	10.40	27.20	50.00	-22.80	AVG
11	23.8245	32.82	10.41	43.23	60.00	-16.77	peak
12	23.9370	16.25	10.41	26.66	50.00	-23.34	AVG

Remarks:

1. Q.P. and AV. are abbreviations of quasi-peak and average individually.
2. The emission levels of other frequencies were very low against the limit.
3. Margin value = Emission level - Limit value
4. Correction factor = Insertion loss + Cable loss
5. Emission Level = Correction Factor + Reading Value.

Lab: [Hwa-Hsing \(Dongguan\) Testing Co., Ltd.](#)

Address: [No.101, Building N1, Yuyuan 2 Road, Yuyuan Industrial Park, HuangJiang Town, Dongguan City, People's Republic of China](#)

Tel: [0769-83078199](tel:0769-83078199)

Web.: www.hwa-hsing.com

E-Mail: customerservice.dg@hwa-hsing.com

Release

[Ver. 1.5](#)

Test Report No.: 24012105-RF-US-01

3.3 Number of Hopping Frequency Used

3.3.1 Limits of Hopping Frequency Used Measurement

At least 15 channels frequencies, and should be equally spaced.

3.3.2 Test Setup

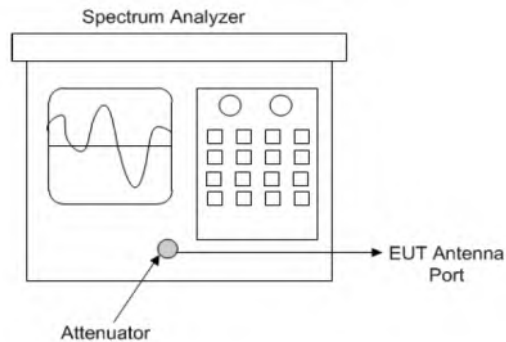

Spectrum analyzer test configuration

3.3.3 Test Instruments

Refer to section 5 to get information of above instrument.

3.3.4 Test Procedure

- Check the calibration of the measuring instrument (SA) using either an internal calibrator or a known signal from an external generator.
- Turn on the EUT and connect its antenna terminal to measurement via a low loss cable. Then set it to any one measured frequency within its operating range and make sure the instrument is operated in its linear range.
- Set the SA on MaxHold Mode, and then keep the EUT in hopping mode. Record all the signals from each channel until each one has been recorded.
- Set the SA on View mode and then plot the result on SA screen.
- Repeat above procedures until all frequencies measured were complete.

3.3.5 Deviation from Test Standard

No deviation.

Lab: [Hwa-Hsing \(Dongguan\) Testing Co., Ltd.](#)

Address: [No.101, Building N1, Yuyuan 2 Road, Yuyuan Industrial Park, HuangJiang Town, Dongguan City, People's Republic of China](#)

Tel: [0769-83078199](#)

Web.: [www.hwa-hsing.com](#)

E-Mail: customerservice.dg@hwa-hsing.com

Release

[Ver. 1.5](#)

Test Report No.: 24012105-RF-US-01

3.3.6 Test Results

There are 79 hopping frequencies in the hopping mode. Please refer to next page for the test result. On the plots, it shows that the hopping frequencies are equally spaced.

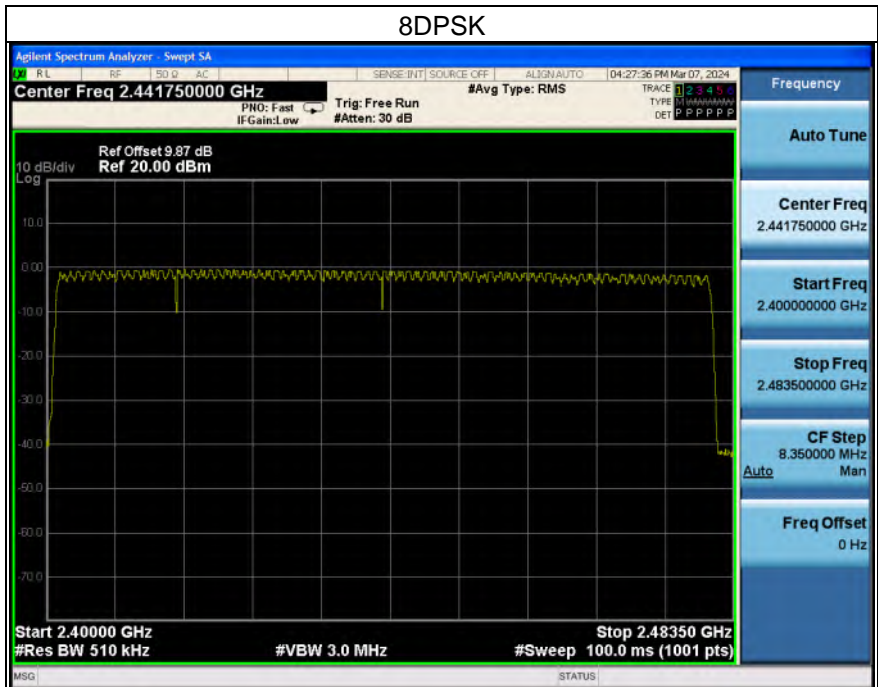
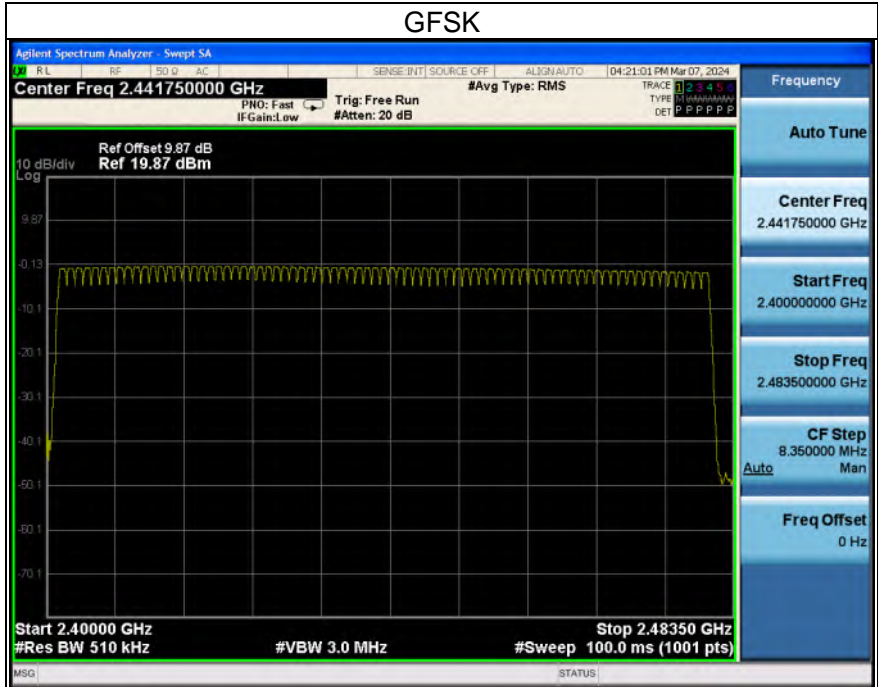

Lab: [Hwa-Hsing \(Dongguan\) Testing Co., Ltd.](#)

Address: [No.101, Building N1, Yuyuan 2 Road, Yuyuan Industrial Park, Huangjiang Town, Dongguan City, People's Republic of China](#)

Tel: [0769-83078199](tel:0769-83078199)

Web.: www.hwa-hsing.com

E-Mail: customerservice.dg@hwa-hsing.com

Release

[Ver. 1.5](#)

3.4 Dwell Time on Each Channel

3.4.1 Limits of Dwell Time on Each Channel Measurement

The average time of occupancy on any channel shall not be greater than 0.4 seconds within a period of 0.4 seconds multiplied by the number of hopping channels employed.

3.4.2 Test Setup

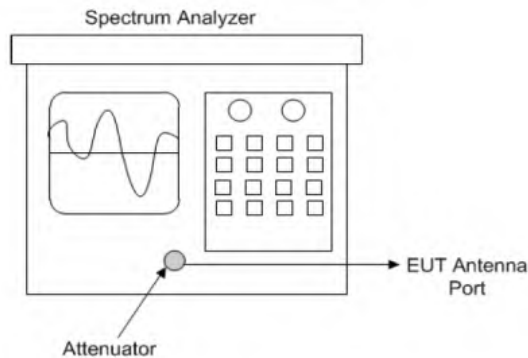

Spectrum analyzer test configuration

3.4.3 Test Instruments

Refer to section 5 to get information of above instrument.

3.4.4 Test Procedures

- Check the calibration of the measuring instrument (SA) using either an internal calibrator or a known signal from an external generator.
- Turn on the EUT and connect its antenna terminal to measurement via a low loss cable. Then set it to any one measured frequency within its operating range and make sure the instrument is operated in its linear range.
- Adjust the center frequency of SA on any frequency be measured and set SA to zero span mode. And then, set RBW and VBW of spectrum analyzer to proper value.
- Measure the time duration of one transmission on the measured frequency. And then plot the result with time difference of this time duration.
- Repeat above procedures until all different time-slot modes have been completed.

3.4.5 Deviation from Test Standard

No deviation.

3.4.6 Test Results

GFSK

Mode	Number of Hopping Channel	Number of transmission in a period (channel number*0.4 sec)				Length of transmission time (msec)	Result (msec)	Limit (msec)	Verdict
		Period (sec)	Sweep time (sec)	times in a sweep	times in a period				
DH1	79	31.6	3.16	31	310	0.383	118.575	400	Pass
DH3	79	31.6	3.16	20	200	1.638	327.600	400	Pass
DH5	79	31.6	3.16	6	60	2.887	173.220	400	Pass

Note: Test plots of the transmitting time slot are shown as below.

8DPSK

Mode	Number of Hopping Channel	Number of transmission in a period (channel number*0.4 sec)				Length of transmission time (msec)	Result (msec)	Limit (msec)	Verdict
		Period (sec)	Sweep time (sec)	times in a sweep	times in a period				
3DH1	79	31.6	3.16	32	320	0.393	125.664	400	Pass
3DH3	79	31.6	3.16	17	170	1.643	279.310	400	Pass
3DH5	79	31.6	3.16	6	60	2.893	173.580	400	Pass

Note: Test plots of the transmitting time slot are shown as below.

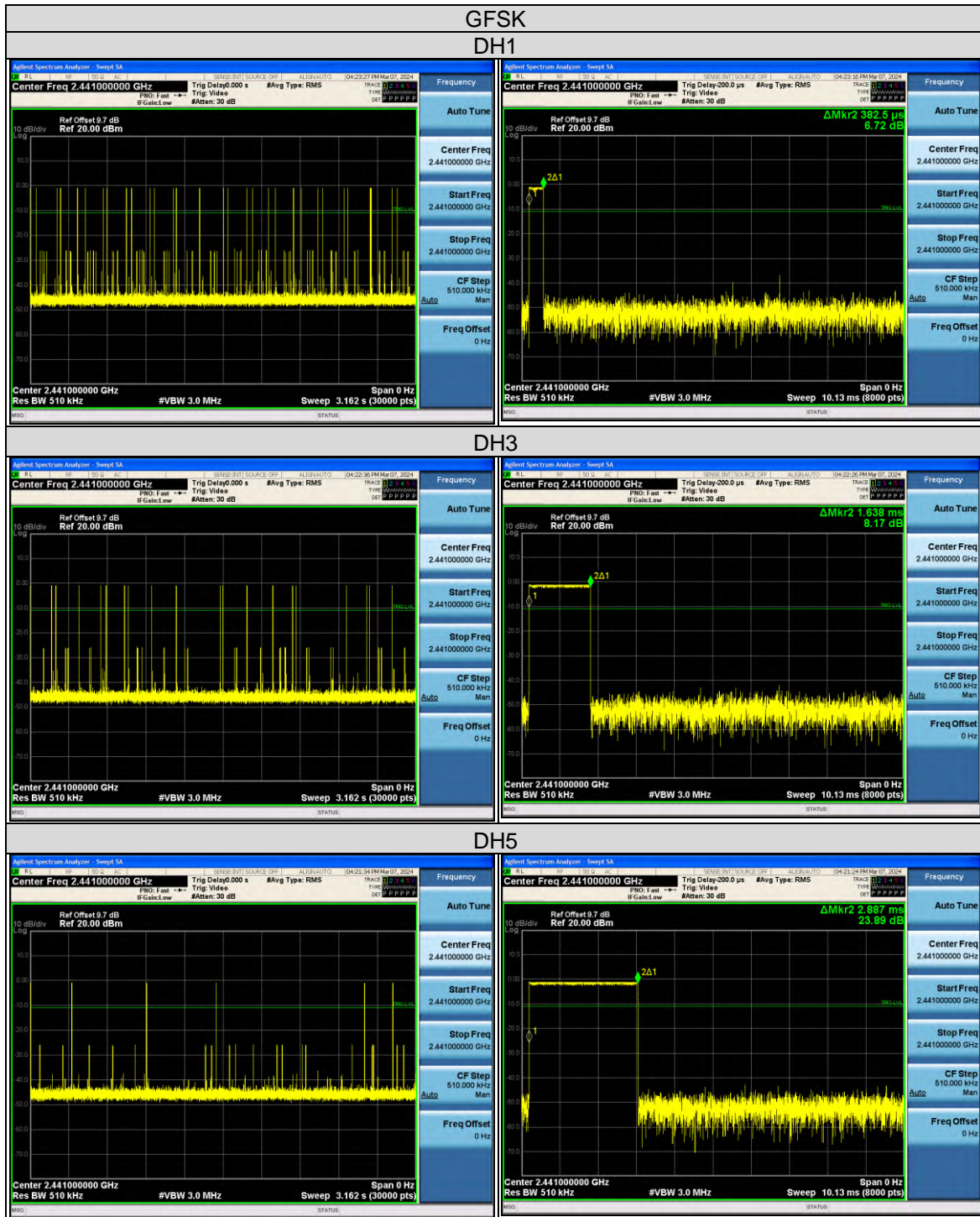

Lab: [Hwa-Hsing \(Dongguan\) Testing Co., Ltd.](#)
 Address: [No.101, Building N1, Yuyuan 2 Road, Yuyuan Industrial Park, Huangjiang Town, Dongguan City, People's Republic of China](#)

Tel: [0769-83078199](tel:0769-83078199)
 Web.: www.hwa-hsing.com
 E-Mail: customerservice.dg@hwa-hsing.com

Release
 Ver. 1.5

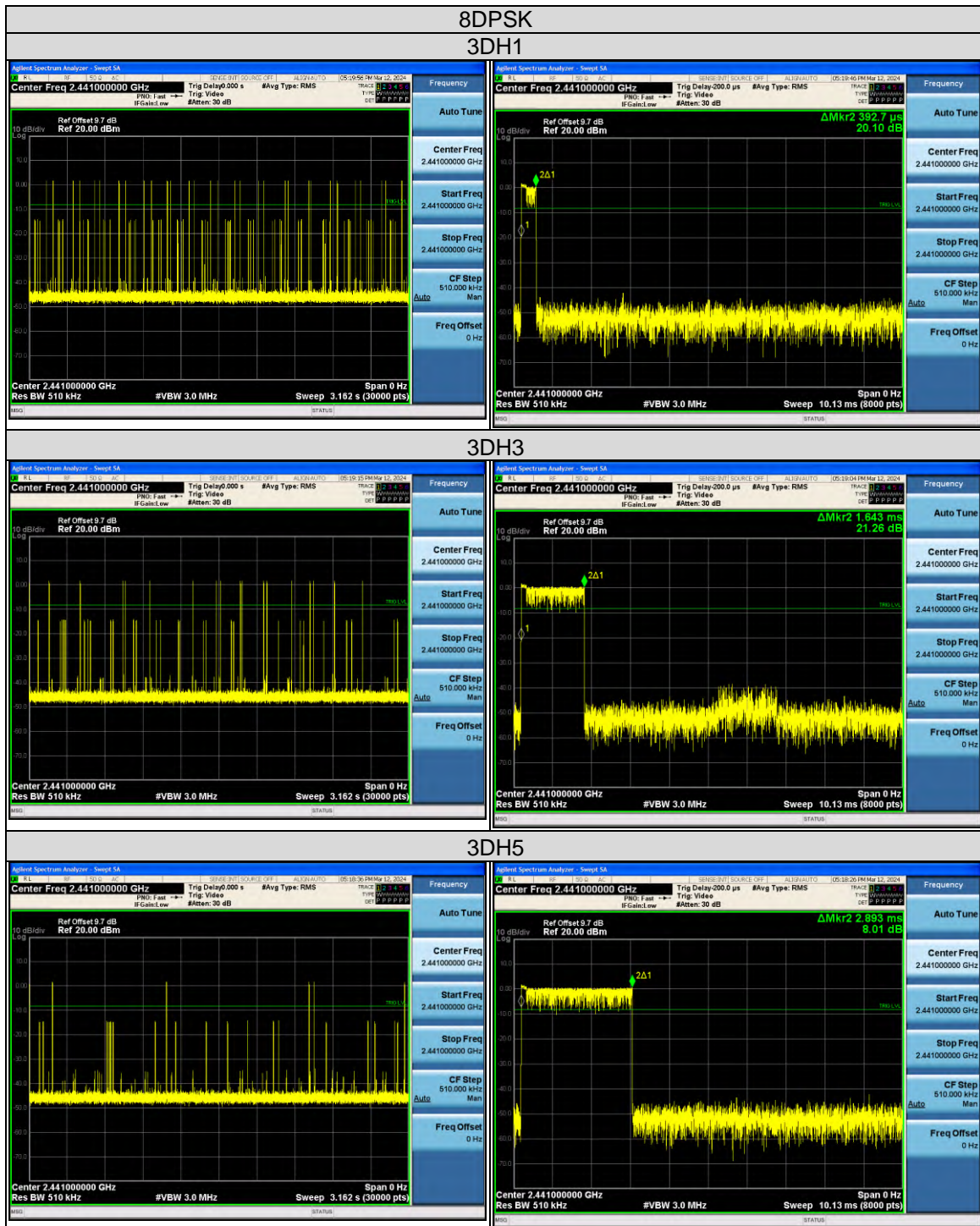

Lab: [Hwa-Hsing \(Dongguan\) Testing Co., Ltd.](#)
 Address: [No.101, Building N1, Yuyuan 2 Road, Yuyuan Industrial Park, Huangjiang Town, Dongguan City, People's Republic of China](#)

Tel: [0769-83078199](tel:0769-83078199)
 Web.: www.hwa-hsing.com
 E-Mail: customerservice.dg@hwa-hsing.com

Release
 Ver. 1.5

3.5 Channel Bandwidth

3.5.1 Limits of Channel Bandwidth Measurement

For frequency hopping system operating in the 2400-2483.5 MHz, if the 20 dB bandwidth of hopping channel is greater than 25 kHz, two-thirds 20 dB bandwidth of hopping channel shall be a minimum limit for the hopping channel separation.

3.5.2 Test Setup

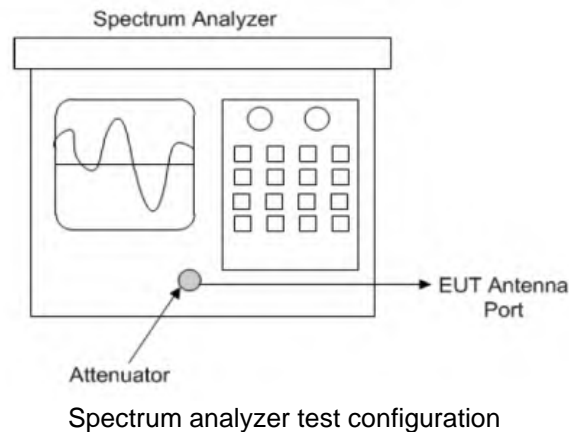

3.5.3 Test Instruments

Refer to section 5 to get information of above instrument.

3.5.4 Test Procedure

- Check the calibration of the measuring instrument using either an internal calibrator or a known signal from an external generator.
- Turn on the EUT and connect it to measurement instrument. Then set it to any one convenient frequency within its operating range. Set a reference level on the instrument equal to the highest peak value.
- Measure the frequency difference of two frequencies that were attenuated 20 dB from the reference level. Record the frequency difference as the emission bandwidth.
- Repeat above procedures until all frequencies measured were complete.

3.5.5 Deviation from Test Standard

No deviation.

3.5.6 EUT Operating Condition

The software provided by client enabled the EUT to transmit and receive data at lowest, middle and highest channel frequencies individually.

Test Report No.: 24012105-RF-US-01

3.5.7 Test Results

Channel	Frequency (MHz)	20dB Bandwidth (MHz)	
		GFSK	8DPSK
0	2402	0.960	1.281
39	2441	0.954	1.266
78	2480	0.963	1.227

Lab: [Hwa-Hsing \(Dongguan\) Testing Co., Ltd.](#)Address: [No.101, Building N1, Yuyuan 2 Road, Yuyuan Industrial Park, HuangJiang Town, Dongguan City, People's Republic of China](#)Tel: [0769-83078199](tel:0769-83078199)Web.: www.hwa-hsing.comE-Mail: customerservice.dg@hwa-hsing.comRelease
[Ver. 1.5](#)



3.6 Occupied Bandwidth Measurement

3.6.1 Test Setup

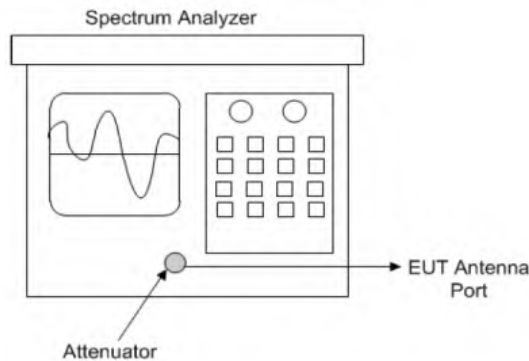

Spectrum analyzer test configuration

3.6.2 Test Instruments

Refer to section 5 to get information of above instrument.

3.6.3 Test Procedure

The transmitter output was connected to the spectrum analyzer through an attenuator. The bandwidth of the fundamental frequency was measured by spectrum analyzer with resolution bandwidth in the range of 1% to 5% of the anticipated emission bandwidth, and a video bandwidth at least 3x the resolution bandwidth and set the detector to PEAK. The width of a frequency band such that, below the lower and above the upper frequency limits, the mean powers emitted are each equal to a specified percentage 0.5% of the total mean power of a given emission.

3.6.4 Deviation from Test Standard

No deviation.

3.6.5 EUT Operating Conditions

The software provided by client to enable the EUT under transmission condition continuously at lowest, middle and highest channel frequencies individually.

Test Report No.: 24012105-RF-US-01

3.6.6 Test Results

Channel	Frequency (MHz)	Occupied Bandwidth (MHz)	
		GFSK	8DPSK
0	2402	0.8616	1.1698
39	2441	0.8758	1.1850
78	2480	0.8707	1.1827

Lab: [Hwa-Hsing \(Dongguan\) Testing Co., Ltd.](#)Address: [No.101, Building N1, Yuyuan 2 Road, Yuyuan Industrial Park, HuangJiang Town, Dongguan City, People's Republic of China](#)Tel: [0769-83078199](tel:0769-83078199)Web.: www.hwa-hsing.comE-Mail: customerservice.dg@hwa-hsing.comRelease
[Ver. 1.5](#)



3.7 Hopping Channel Separation

3.7.1 Limits of Hopping Channel Separation Measurement

At least 25 kHz or two-third of 20 dB hopping channel bandwidth (whichever is greater).

3.7.2 Test Setup

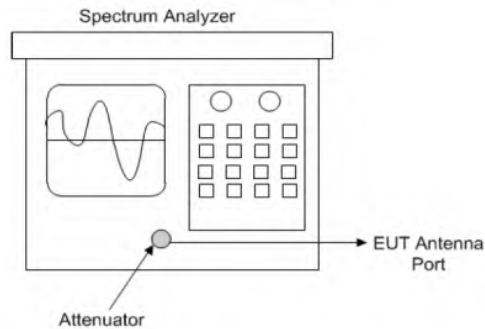

3.7.3 Test Instruments

Refer to section 5 to get information of above instrument.

3.7.4 Test Procedure

- Check the calibration of the measuring instrument using either an internal calibrator or a known signal from an external generator.
- Turn on the EUT and connect it to measurement instrument. Then set it to any one convenient frequency within its operating range.
- By using the MaxHold function record the separation of two adjacent channels.
- Measure the frequency difference of these two adjacent channels by SA MARK function. And then plot the result on SA screen.
- Repeat above procedures until all frequencies measured were complete.

3.7.5 Deviation from Test Standard

No deviation.

3.7.6 Test Results

Channel No.	Frequency (MHz)	Adjacent Channel Separation (MHz)		Minimum Limit (MHz)		Pass / Fail
		GFSK	8DPSK	GFSK	8DPSK	
0	2402	0.996	0.999	0.644	0.870	Pass
39	2441	1.005	0.999	0.636	0.842	Pass
78	2480	1.182	0.993	0.638	0.832	Pass

Note: The minimum limit is two-third 20 dB bandwidth.



Test Report No.: 24012105-RF-US-01

3.8 Maximum Output Power

3.8.1 Limits of Maximum Output Power Measurement

The Maximum Output Power Measurement is 125mW.

3.8.2 Test Setup

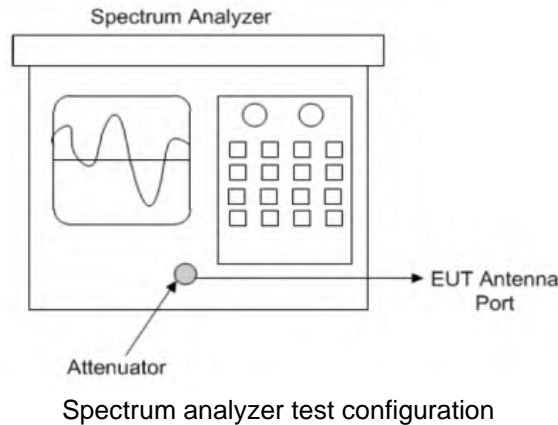

3.8.3 Test Instruments

Refer to section 5 to get information of above instrument.

3.8.4 Test Procedure

Measurement using a spectrum analyzer (SA), Selection of test method:

The proper test method is selected based on the following criteria:

- a) **Method AVGSA-1 or method AVGSA-1A (alternative)** shall be applied if either of the following conditions can be satisfied:
 - 1) The EUT transmits continuously (or with a $D > 98\%$).
 - 2) Sweep triggering can be implemented in such a way that the device transmits at the maximum power control level throughout the duration of each of the instrument sweeps to be averaged. This condition can generally be achieved by triggering the instrument's sweep if the duration of the sweep (with the instrument configured as in method AVGSA-1) is equal to or shorter than the duration T of each transmission from the EUT, and if those transmissions exhibit full power throughout their durations.
- b) **Method AVGSA-2 or method AVGSA-2A (alternative)** shall be applied if the conditions of the preceding item a) cannot be achieved and the transmissions exhibit a constant duty cycle during the measurement duration. Duty cycle will be considered to be constant if variations are less than $+2\%$.
- c) **Method AVGSA-3 or method AVGSA-3A (alternative)** shall be applied if the conditions of the preceding item a) and item b) cannot be achieved.

Lab: [Hwa-Hsing \(Dongguan\) Testing Co., Ltd.](#)

Address: [No.101, Building N1, Yuyuan 2 Road, Yuyuan Industrial Park, HuangJiang Town, Dongguan City, People's Republic of China](#)

Tel: [0769-83078199](#)

Web.: [www.hwa-hsing.com](#)

E-Mail: customerservice.dg@hwa-hsing.com

Release

[Ver. 1.5](#)

Test Report No.: 24012105-RF-US-01

 Measurement using a spectrum analyzer (SA), Selection of test method: Maximum peak conducted output power

The following procedure shall be used when an instrument with a resolution bandwidth that is greater than the DTS bandwidth is available to perform the measurement:

- a) Set the RBW > DTS bandwidth.
- b) Set VBW > [3 x RBW]
- c) Set span > [3 x RBW]
- d) Sweep time = auto couple.
- e) Detector = peak
- f) Trace mode = max hold.
- g) Allow trace to fully stabilize.
- h) Use peak marker function to determine the peak amplitude level.

Lab: [Hwa-Hsing \(Dongguan\) Testing Co., Ltd.](#)Address: [No.101, Building N1, Yuyuan 2 Road, Yuyuan Industrial Park, HuangJiang Town, Dongguan City, People's Republic of China](#)Tel: [0769-83078199](#)Web.: [www.hwa-hsing.com](#)E-Mail: customerservice.dg@hwa-hsing.comRelease
Ver. 1.5

Test Report No.: 24012105-RF-US-01

Maximum conducted (average) output power(Method AVGSA-2):

- a) Check the calibration of the measuring instrument using either an internal calibrator or a known signal from an external generator.
- b) Turn on the EUT and connect it to measurement instrument. Then set it to any one convenient frequency within its operating range. Set a reference level on the measuring instrument equal to the highest peak value.
- c) SA Setting:
 - 1)* Set span to at least 1.5 times the OBW
 - 2)* Set sweep trigger to "free run."
 - 3)* Set RBW= 1% to 5% of the OBW. not to exceed 1MHz.
 - 4)* Set VBW $\geq 3 \times$ RBW
 - 5)* Number of points in sweep $\geq 2 \times$ span /RBW. (This gives bin-to-bin spacing \leq RBW / 2. so that narrowband signals are not lost between frequency bins).
 - 6)* Sweep time \leq (number of points in sweep) x T. where T is defined in 11.6. If this gives a sweep time less than the auto sweep time of the instrument. then method AVGSA-3 shall not be used (use AVGSA-3A). The purpose of this step is so that the averaging time in each bin is less than or equal to the minimum time of a transmission.
 - 7)* Detector =RMS (power averaging).
 - 8)* Trace mode =Max hold.
 - 9)* Allow max hold to run for at least 60 s or longer as needed to allow the trace to stabilize.
 - 10)* Compute power by integrating the spectrum across the OBW of the signal using the instrument's band power measurement function with band limits set equal to the OBW band edges. If the instrument does not have a band power function. then sum the spectrum levels (in power units) at intervals equal to the RBW extending across the entire OBW.
- d. Measure the captured power within the band and recording the plot.
- e. Repeat above procedures until all frequencies required were complete.

3.8.5 Deviation from Test Standard

No deviation.

3.8.6 EUT Operating Condition

The software provided by client enabled the EUT to transmit and receive data at lowest, middle and highest channel frequencies individually.

Lab: [Hwa-Hsing \(Dongguan\) Testing Co., Ltd.](#)

Address: [No.101, Building N1, Yuyuan 2 Road, Yuyuan Industrial Park, HuangJiang Town, Dongguan City, People's Republic of China](#)

Tel: [0769-83078199](#)

Web.: [www.hwa-hsing.com](#)

E-Mail: customerservice.dg@hwa-hsing.com

Release

[Ver. 1.5](#)

3.8.7 Test Results

Peak power

Channel No.	Freq. (MHz)	Output Power (dBm)		Output Power (mW)		Power Limit (mW)	Pass / Fail
		GFSK	8DPSK	GFSK	8DPSK		
0	2402	-0.74	-0.03	0.843	0.993	125	Pass
39	2441	-0.87	-0.03	0.818	0.993	125	Pass
78	2480	-1.95	-1.06	0.638	0.783	125	Pass

Average power

Channel No.	Freq. (MHz)	Output Power (dBm)		Output Power (mW)		Power Limit (mW)	Pass / Fail
		GFSK	8DPSK	GFSK	8DPSK		
0	2402	-0.97	-1.76	0.800	0.667	125	Pass
39	2441	-0.94	-2.35	0.805	0.582	125	Pass
78	2480	-2.33	-1.62	0.585	0.689	125	Pass

Peak Power Spectrum Plot

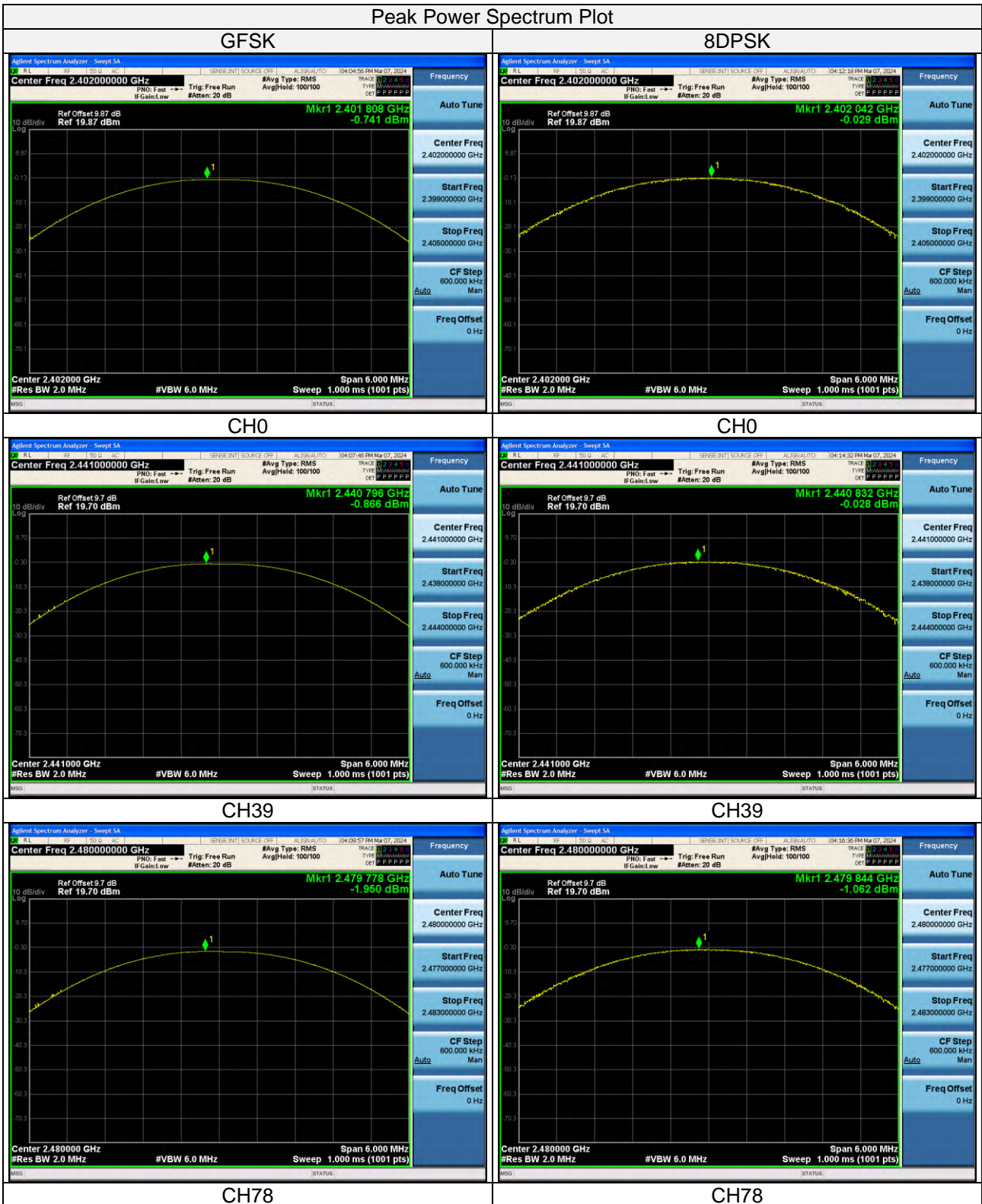

Lab: [Hwa-Hsing \(Dongguan\) Testing Co., Ltd.](#)
 Address: [No.101, Building N1, Yuyuan 2 Road, Yuyuan Industrial Park, Huangjiang Town, Dongguan City, People's Republic of China](#)

Tel: [0769-83078199](tel:0769-83078199)
 Web: www.hwa-hsing.com
 E-Mail: customerservice.dg@hwa-hsing.com

Release Ver. 1.5

Average Power Spectrum Plot

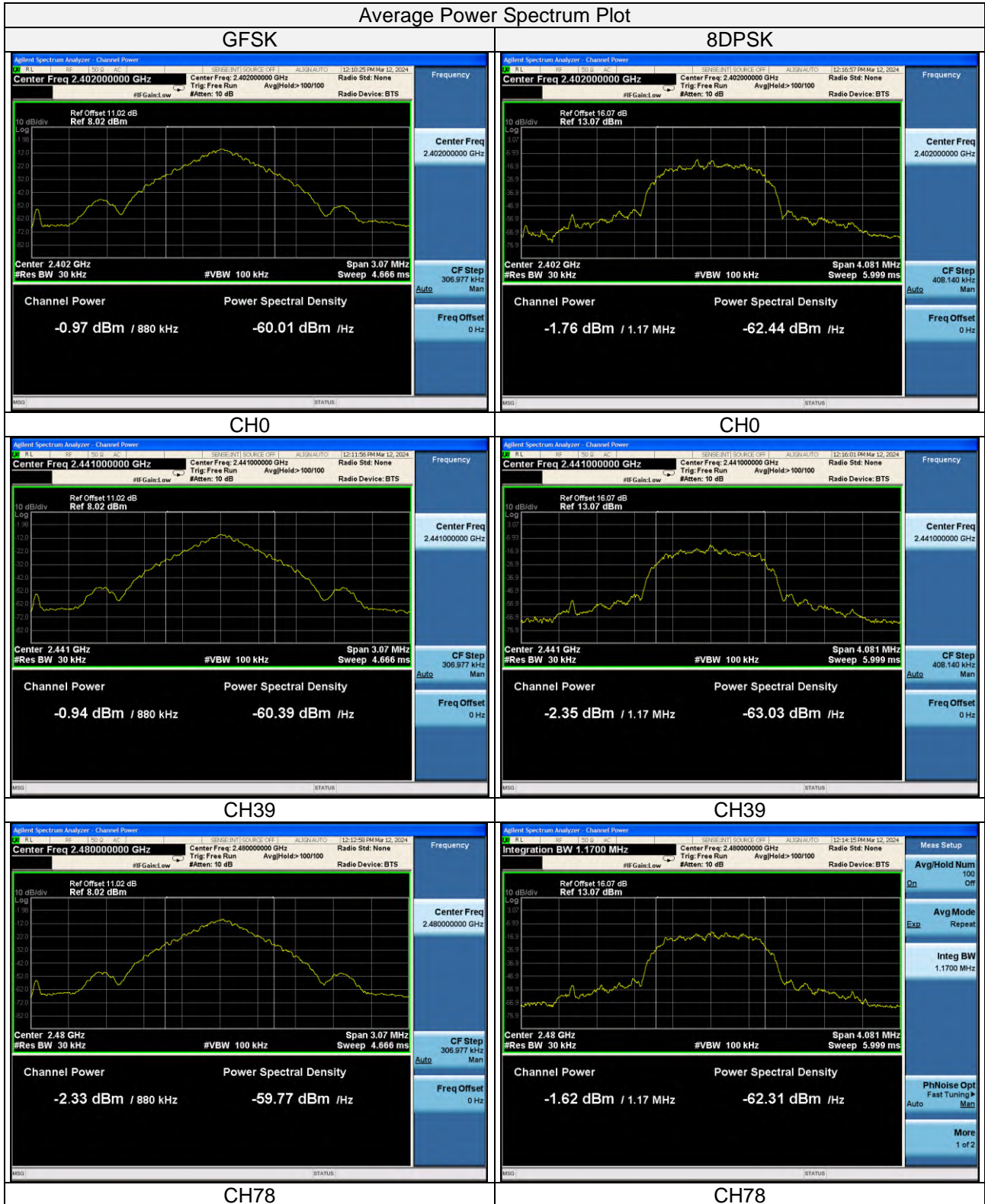

3.9 Conducted Out of Band Emission Measurement

3.9.1 Limits of Conducted Out of Band Emission Measurement

- a. **If the maximum peak conducted output power procedure was used to determine compliance as described in 11.9.1**, then the peak output power measured in any 100 kHz bandwidth outside of the authorized frequency band shall be attenuated by at least 20 dB relative to the maximum in-band peak PSD level in 100 kHz (i.e., 20 dBc).
- b. **If maximum conducted (average) output power was used to determine compliance as described in 11.9.2**, then the peak power in any 100 kHz bandwidth outside of the authorized frequency band shall be attenuated by at least 30 dB relative to the maximum in-band peak PSD level in 100 kHz (i.e., 30 dBc).

3.9.2 Test Setup

- DTS emissions in non-restricted frequency bands Subclause 11.11 of ANSI C63.10 is applicable.
- DTS emissions in restricted frequency bands Subclause 11.12 of ANSI C63.10 is applicable.

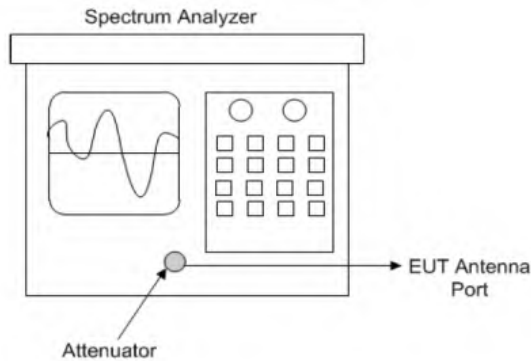

Spectrum analyzer test configuration

3.9.3 Test Instruments

Refer to section 5 to get information of above instrument.

Test Report No.: 24012105-RF-US-01

3.9.4 Test Procedure

- a. Establish a reference level by using the following procedure:
- 1) Set instrument center frequency to DTS channel center frequency.
 - 2) Set the span to 21.5 times the DTS bandwidth)
 - 3) Set the RBW= 100 kHz)
 - 4) Set the VBW $\geq 3 \times$ RBW
 - 5) Detector = peak
 - 6) Sweep time = auto coupling
 - 7) Trace mode =max hold
 - 8) Allow trace to fully stabilize
 - 9) Use the peak marker function to determine the maximum PSD level.

Note that the channel found to contain the maximum PSD level can be used to establish the reference level.

- b. Establish an emission level by using the following procedure:
- 1) Set the center frequency and span to encompass frequency range to be measured.
 - 2) Set the RBW = 100 kHz
 - 3) Set the VBW ≥ 300 kHz.
 - 4) Detector = peak.
 - 5) Sweep time = auto couple.
 - 6) Trace mode = max hold.
 - 7) Allow trace to fully stabilize.
 - 8) Use the peak marker function to determine the maximum power level in any 100 kHz band segment within the fundamental EBW.

3.9.5 Deviation from Test Standard

No deviation.

3.9.6 EUT Operating Condition

The software provided by client enabled the EUT to transmit and receive data at lowest, middle and highest channel frequencies individually.

3.9.7 Test Results

The spectrum plots are attached on the following images. D1 line indicates the highest level, D2 line indicates the 20dB offset below D1. It shows compliance with the requirement.

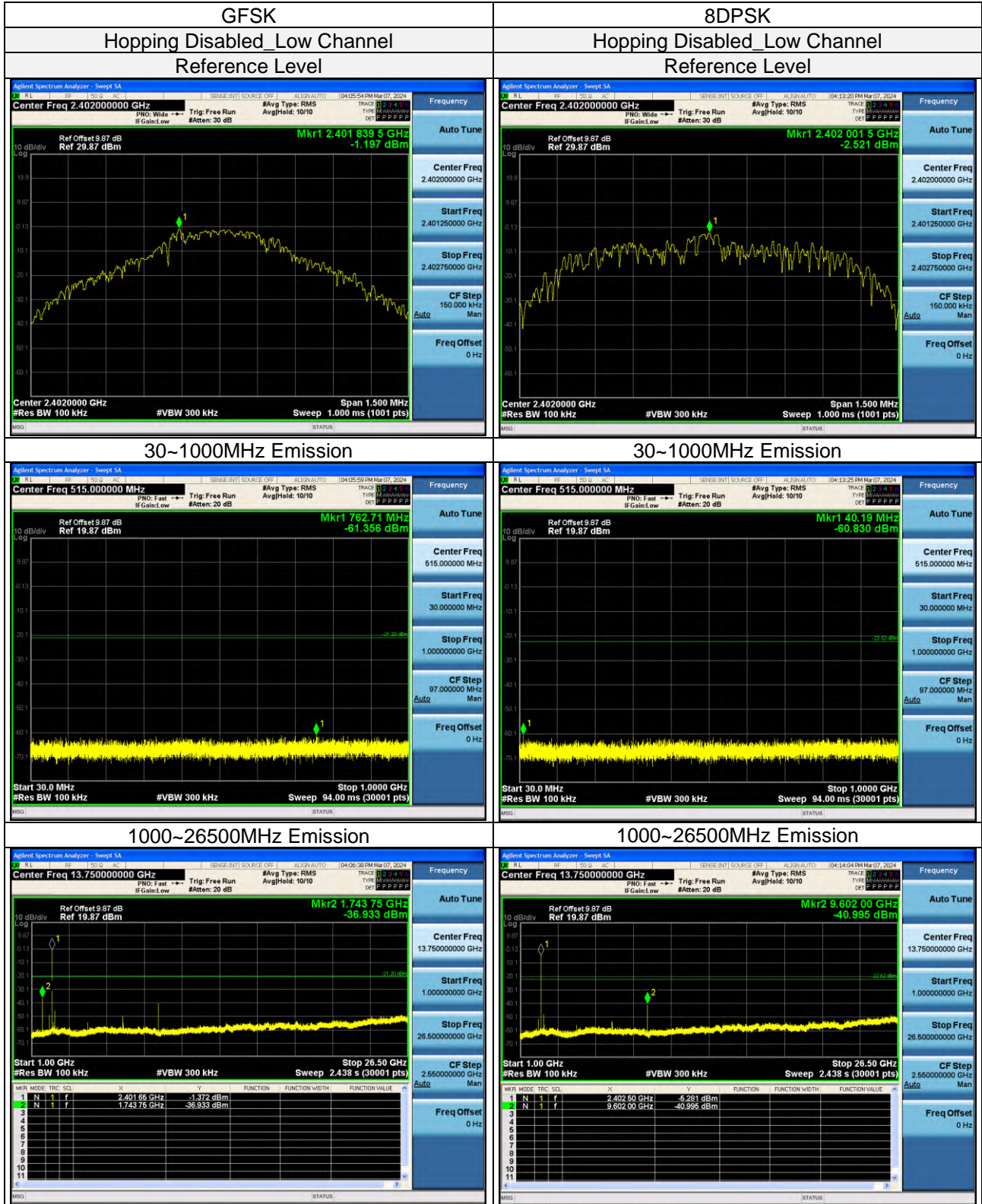

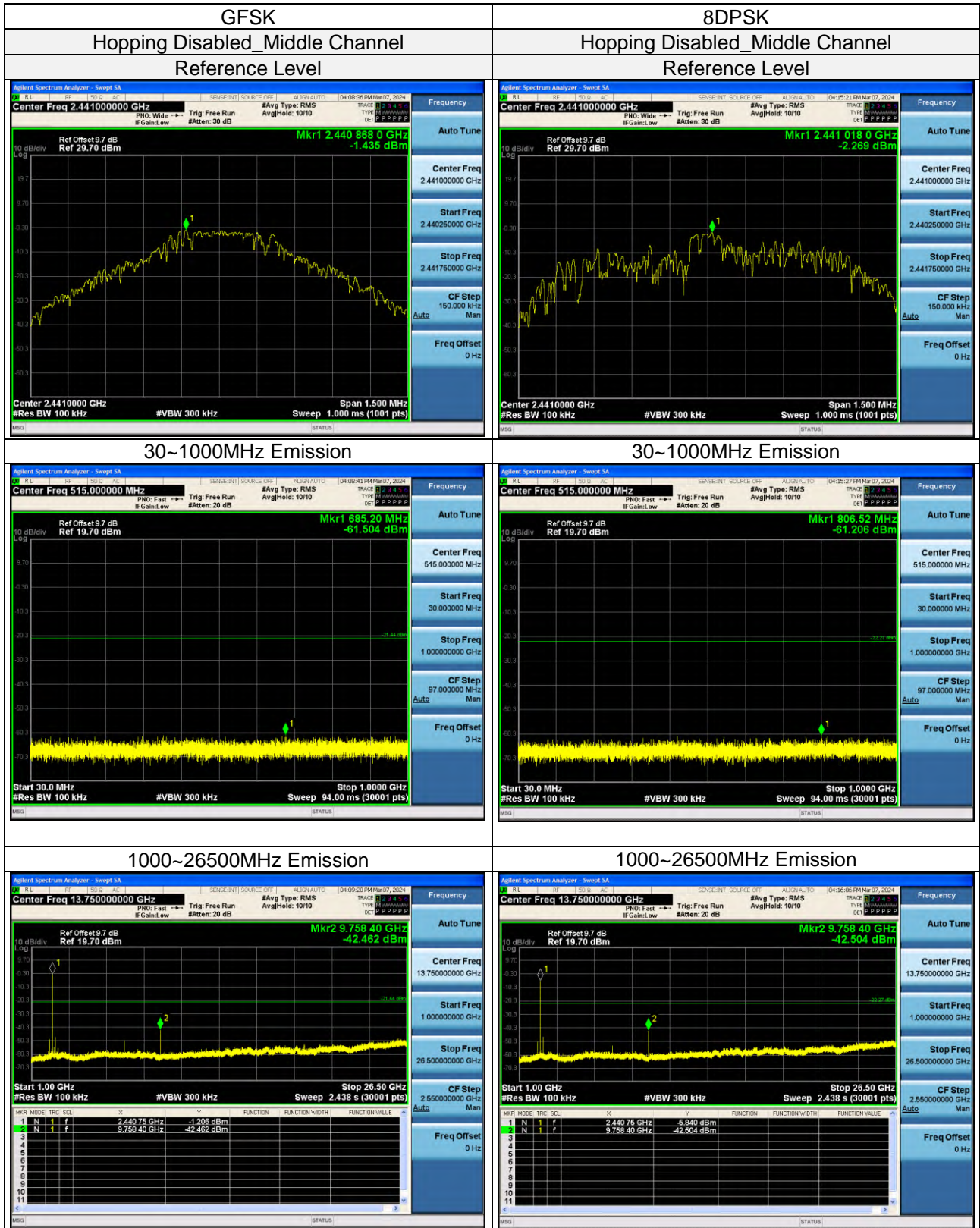

Lab: [Hwa-Hsing \(Dongguan\) Testing Co., Ltd.](#)
 Address: [No.101, Building N1, Yuyuan 2 Road, Yuyuan Industrial Park, HuangJiang Town, Dongguan City, People's Republic of China](#)

Tel: [0769-83078199](tel:0769-83078199)
 Web.: www.hwa-hsing.com
 E-Mail: customerservice.dg@hwa-hsing.com

Release
 Ver. 1.5

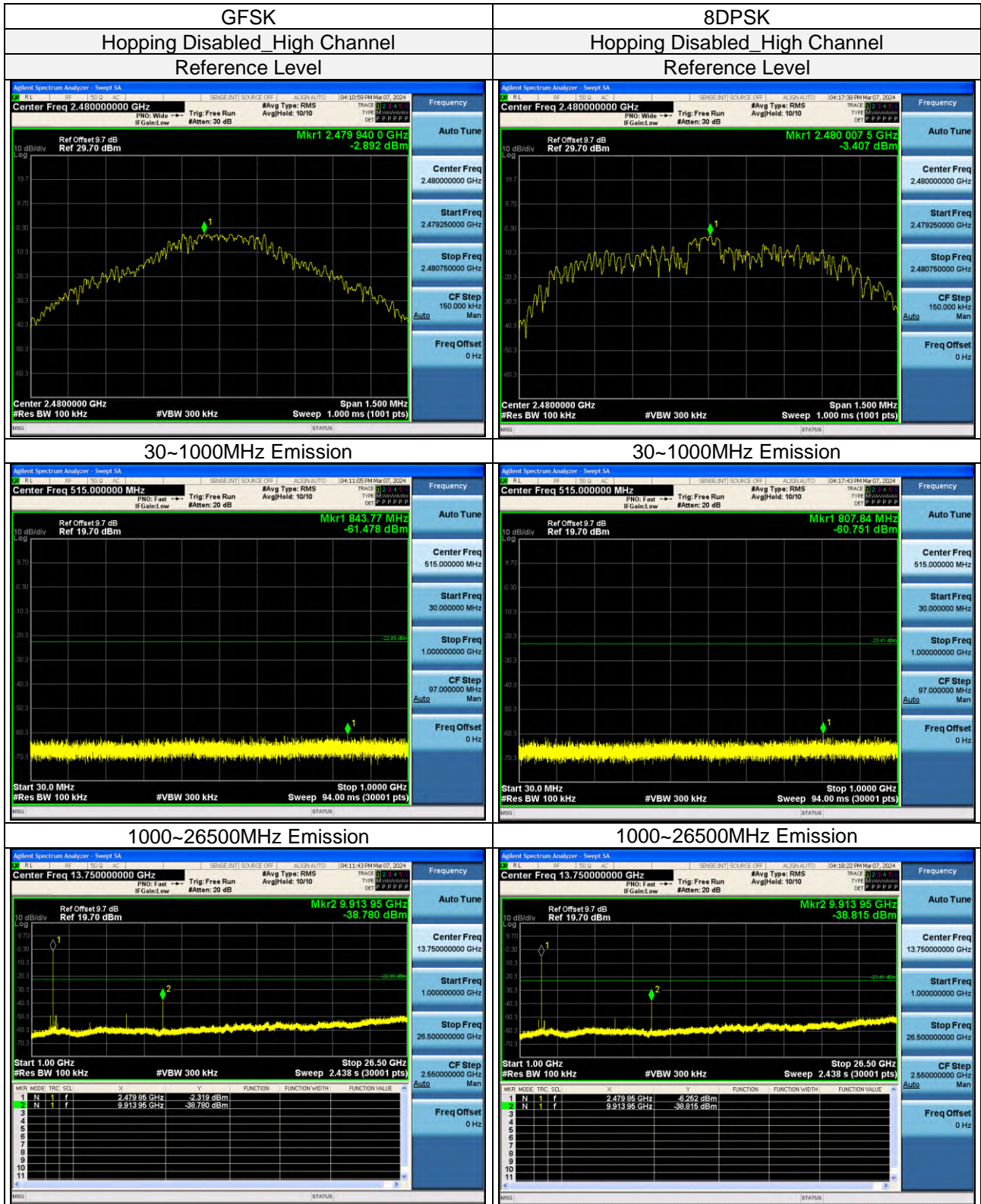

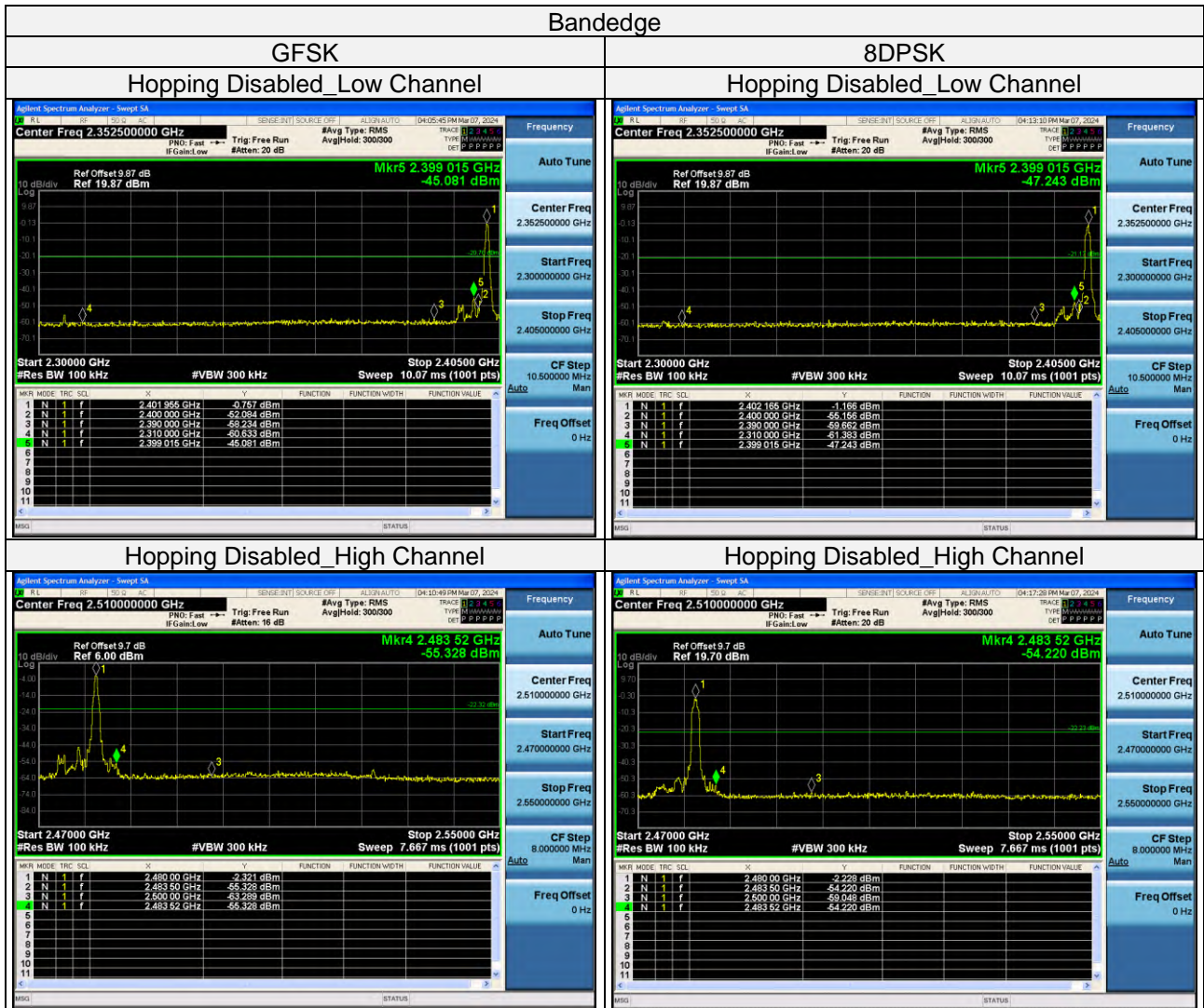

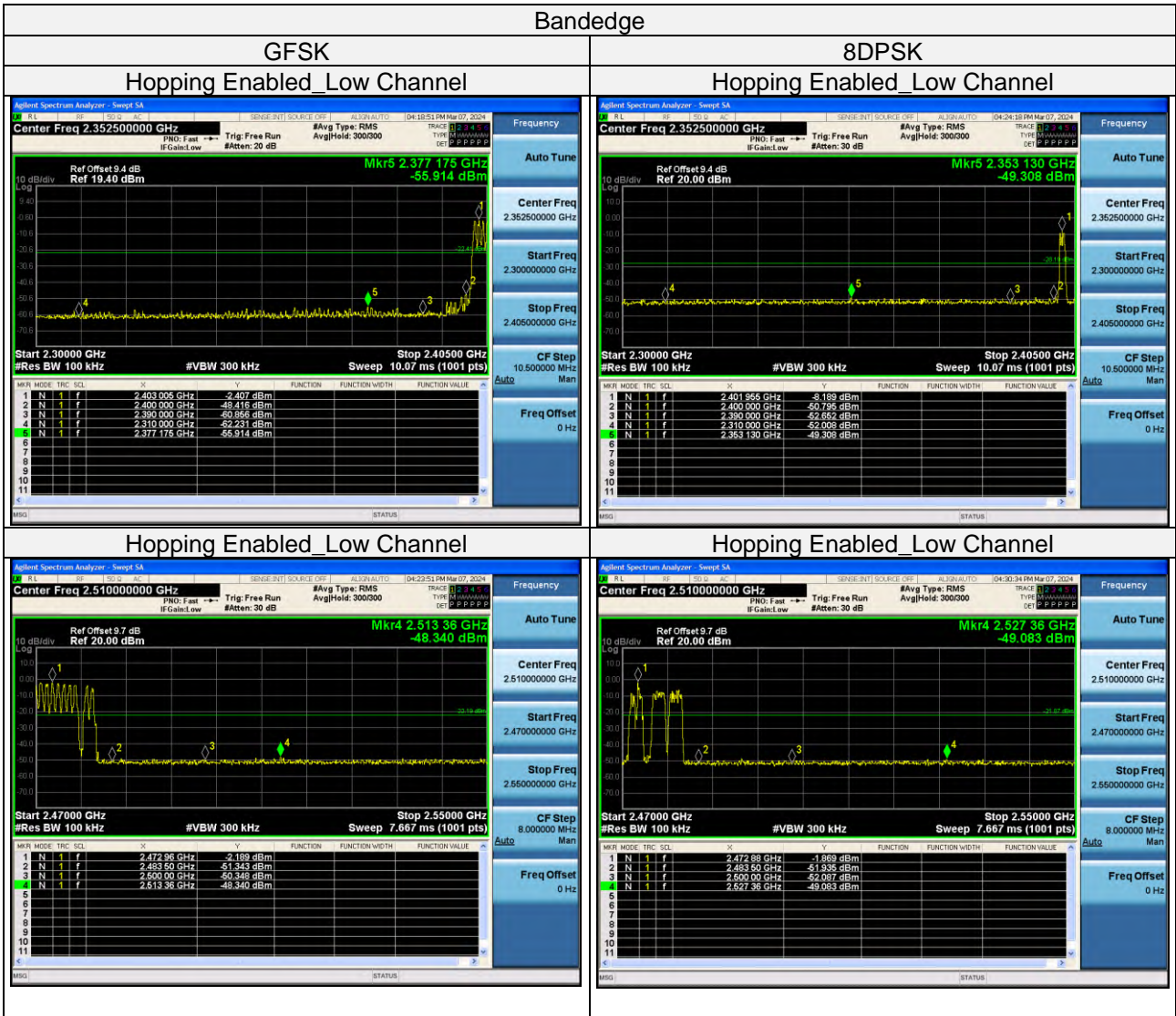

Test Report No.: 24012105-RF-US-01

4 Pictures of Test Arrangements

Please refer to the attached file (Test Setup Photo).

Lab: [Hwa-Hsing \(Dongguan\) Testing Co., Ltd.](#)

Address: [No.101, Building N1, Yuyuan 2 Road, Yuyuan Industrial Park, HuangJiang Town, Dongguan City, People's Republic of China](#)

Tel: [0769-83078199](#)

Web.: [www.hwa-hsing.com](#)

E-Mail: customerservice.dg@hwa-hsing.com

Release
[Ver. 1.5](#)

5 Test Instruments

Equipment	Manufacturer	Model No.	Serial No.	Next Cal.Date
Spectrum	Keysight	N9020A	MY51240612	2024-08-06
Spectrum Analyzer	Rohde&Schwarz	FSV-40N	101783	2024-12-17
Power Meter 10Hz~18GHz	Tonscend	JS0806-2	188060126	2024-08-06
Signal generator	Keysight	E4421B	GB40051020	2024-03-15
Universal Switch Control Unit	Rohde&Schwarz	CMW500	12010002k50	2024-12-17
Test Software	Tonscend	JS0806-2	NA	NA
Humidity tester	Jingchuang	GSP-8A	CMA22B000592	2024-12-24

- Note: 1. The calibration interval of the above test instruments is 12 months.
2. The test was performed in RF Chamber.

Test Report No.: 24012105-RF-US-01

Appendix – Information on the Testing Laboratories

We, [Hwa-Hsing \(Dongguan\) Testing Co., Ltd.](#), A global provider of TESTING and CERTIFICATION services for consumer products, electronic products and wireless information technology products. Adhering to the core values “HONEST and TRUSTWORTHY, OBJECTIVE and IMPARTIALITY, RIGOROUS and AFFICIENT”, commitment to provide professional, perfect and efficient comprehensive ONE-STOP solution of TESTING and CERTIFICATION services for Manufacturers, Buyers, Traders, Brands, Retailers. Assist client to better manage risk, protect their brands, reduce costs and cut time to over 150 markets in global. Our laboratories are FCC recognized accredited test firms and accredited and approved according to ISO/IEC 17025.

If you have any comments, please feel free to contact us at the following:

Lab Address: [No.101, Building N1, Yuyuan 2 Road, Yuyuan Industrial Park, HuangJiang Town, Dongguan City, People's Republic of China](#)

Contact Tel: [0769-83078199](tel:0769-83078199)

Email: Customerservice.dg@hwa-hsing.com

Web Site: www.hwa-hsing.com

The address and road map of all our labs can be found in our web site also.

--- END ---