

## FCC Part 15, Subpart C Test Report

FCC ID: 2AR2SAX700

Applicant: MMD Hong Kong Holding Limited

Address: Units 1208-11, 12th Floor, C-Bons International Center, 108 Wai Yip Street, Kwun Tong, Kowloon, Hong Kong

Manufacturer: MMD Hong Kong Holding Limited

Address: Units 1208-11, 12th Floor, C-Bons International Center, 108 Wai Yip Street, Kwun Tong, Kowloon, Hong Kong

Product(s): Party Speaker

Brand(s): AOC

Test Model(s): AX700W/10

Series Model(s): AX701B/10, AX701U/10, AX700x/yy, AX701x/yy (x=A-Z or NiL , yy=00-99 or NiL for country code)

Test Date: Jan. 10, 2023 ~ Feb. 20, 2023

Issued Date: Mar. 13, 2023

Issued By: Hwa-Hsing (Dongguan) Testing Co., Ltd.

Address: No.101, Bld N1, Yuyuan 2Rd, Yuyuan Industrial Park, HuangJiang Town, Dongguan, China

Test Firm Registration No.: 915896

Designation No.: CN1255

Standards: 47 CFR FCC Part 15, Subpart C (Section 15.247)  
ANSI C63.10:2013

The above equipment has been tested by **Hwa-Hsing (Dongguan) Testing Co., Ltd.**, and found compliance with the requirement of the above standards. The test record, data evaluation & Equipment Under Test (EUT) configurations represented herein are true and accurate accounts of the measurements of the sample's EMC characteristics under the conditions specified in this report.

Prepared by :

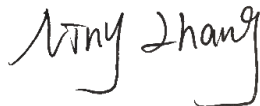

Niny Zhang

Reviewed by :



Tank Tan

Approved by :



Scott He



"This report is for your exclusive use. Any copying or replication of this report to or for any other person or entity, or use of our name or trademark, is permitted only with our prior written permission. This report sets forth our findings solely with respect to the test samples identified herein. Our report includes all the tests requested by you and the results thereof based upon the information that you provided to us. The report would be invalid without specific stamp of test institute and the signatures of tester and approver."

Lab: [Hwa-Hsing \(Dongguan\) Testing Co., Ltd.](#)

Address: [No.101, Bld N1, Yuyuan 2Rd, Yuyuan Industrial Park, HuangJiang Town, Dongguan, China](#)

Tel: [0769-83078199](tel:0769-83078199)

Web.: [www.hwa-hsing.com](http://www.hwa-hsing.com)

E-Mail: [customerservice.dg@hwa-hsing.com](mailto:customerservice.dg@hwa-hsing.com)

Release

[Ver. 1.5](#)



## Table of Contents

|   |           |
|---|-----------|
| Release Control Record .....                                      | 4         |
| <b>1 Summary of Test Results.....</b>                             | <b>5</b>  |
| 1.1 Measurement Uncertainty.....                                  | 5         |
| 1.2 Modification Record .....                                     | 5         |
| <b>2 General Information .....</b>                                | <b>6</b>  |
| 2.1 General Description of EUT .....                              | 6         |
| 2.2 Description of Test Modes.....                                | 7         |
| 2.3 Test Mode Applicability and Tested Channel Detail .....       | 8         |
| 2.4 Description of Support Units .....                            | 10        |
| 2.4.1 Configuration of System under Test .....                    | 10        |
| <b>3 Test Types and Results .....</b>                             | <b>11</b> |
| 3.1 Radiated Emission and Band-edge Measurement .....             | 11        |
| 3.1.1 Limits of Radiated Emission and Band-edge Measurement ..... | 11        |
| 3.1.2 Test Instruments .....                                      | 12        |
| 3.1.3 Test Procedures.....  | 13        |
| 3.1.4 Deviation from Test Standard .....                          | 14        |
| 3.1.5 Test Setup.....   | 15        |
| 3.1.6 EUT Operating Conditions.....                               | 16        |
| 3.1.7 Test Results .....  | 17        |
| 3.2 Number of Hopping Frequency Used .....                        | 29        |
| 3.2.1 Limits of Hopping Frequency Used Measurement .....          | 29        |
| 3.2.2 Test Setup.....   | 29        |
| 3.2.3 Test Instruments .....                                      | 29        |
| 3.2.4 Test Procedure .....  | 29        |
| 3.2.5 Deviation from Test Standard .....                          | 29        |
| 3.2.6 Test Results .....  | 30        |
| 3.3 Dwell Time on Each Channel.....                               | 31        |
| 3.3.1 Limits of Dwell Time on Each Channel Measurement.....       | 31        |
| 3.3.2 Test Setup.....   | 31        |
| 3.3.3 Test Instruments .....                                      | 31        |
| 3.3.4 Test Procedures.....  | 31        |
| 3.3.5 Deviation from Test Standard .....                          | 31        |
| 3.3.6 Test Results .....  | 32        |
| 3.4 Channel Bandwidth.....  | 35        |
| 3.4.1 Limits of Channel Bandwidth Measurement.....                | 35        |
| 3.4.2 Test Setup.....   | 35        |
| 3.4.3 Test Instruments .....                                      | 35        |
| 3.4.4 Test Procedure .....  | 35        |
| 3.4.5 Deviation from Test Standard .....                          | 35        |
| 3.4.6 EUT Operating Condition .....                               | 35        |
| 3.4.7 Test Results .....  | 36        |
| 3.5 Occupied Bandwidth Measurement.....                           | 38        |
| 3.5.1 Test Setup.....   | 38        |
| 3.5.2 Test Instruments .....                                      | 38        |
| 3.5.3 Test Procedure .....  | 38        |
| 3.5.4 Deviation from Test Standard .....                          | 38        |
| 3.5.5 EUT Operating Conditions.....                               | 38        |
| 3.5.6 Test Results .....  | 39        |
| 3.6 Hopping Channel Separation.....                               | 41        |



|          |   |           |
|----------|---|-----------|
| 3.6.1    | Limits of Hopping Channel Separation Measurement.....           | 41        |
| 3.6.2    | Test Setup.....   | 41        |
| 3.6.3    | Test Instruments .....  | 41        |
| 3.6.4    | Test Procedure .....  | 41        |
| 3.6.5    | Deviation from Test Standard .....                              | 41        |
| 3.6.6    | Test Results .....  | 42        |
| 3.7      | Maximum Output Power .....                                      | 44        |
| 3.7.1    | Limits of Maximum Output Power Measurement .....                | 44        |
| 3.7.2    | Test Setup.....   | 44        |
| 3.7.3    | Test Instruments .....  | 44        |
| 3.7.4    | Test Procedure .....  | 44        |
| 3.7.5    | Deviation fromTest Standard .....                               | 45        |
| 3.7.6    | EUT Operating Condition .....                                   | 45        |
| 3.7.7    | Test Results .....  | 46        |
| 3.8      | Conducted Out of Band Emission Measurement .....                | 49        |
| 3.8.1    | Limits of Conducted Out of Band Emission Measurement.....       | 49        |
| 3.8.2    | Tets Setup.....   | 49        |
| 3.8.3    | Test Instruments .....  | 49        |
| 3.8.4    | Test Procedure .....  | 50        |
| 3.8.5    | Deviation from Test Standard .....                              | 50        |
| 3.8.6    | EUT Operating Condition .....                                   | 50        |
| 3.8.7    | Test Results .....  | 51        |
| <b>4</b> | <b>Pictures of Test Arrangements.....</b>                       | <b>56</b> |
| <b>5</b> | <b>Test Instruments .....</b>                                   | <b>57</b> |
|          | <b>Appendix – Information on the Testing Laboratories .....</b> | <b>58</b> |



### Release Control Record

| Issue No.           | Description      | Date Issued   |
|---------------------|------------------|---------------|
| 221226KH23-RF-US-01 | Original Release | Mar. 13, 2023 |



**1 Summary of Test Results**

| 47 CFR FCC Part 15, Subpart C (Section 15.247)<br>KDB 558074 D01 15.247 Meas Guidance v05r02<br>ANSI C63.10:2013; |   |        |                                |
|---|---|--------|--------------------------------|
| FCC Clause  | Test Item   | Result | Remarks                        |
| 15.247(a)(1) (iii)  | Number of Hopping Frequency Used  | Pass   | Meet the requirement of limit. |
| 15.247(a)(1) (iii)  | Dwell Time on Each Channel  | Pass   | Meet the requirement of limit. |
| 15.247(a)(1)  | 1. Hopping Channel Separation<br>2. Spectrum Bandwidth of a Frequency Hopping Sequence Spread Spectrum System | Pass   | Meet the requirement of limit. |
| 15.247(b)   | Maximum Peak Output Power   | Pass   | Meet the requirement of limit. |
| ---   | Occupied Bandwidth Measurement  | Pass   | Reference only                 |
| 15.205 & 209  | Radiated Emissions  | Pass   | Meet the requirement of limit. |
| 15.247(d)   | Band Edge Measurement   | Pass   | Meet the requirement of limit. |
| 15.247(d)   | Antenna Port Emission   | Pass   | Meet the requirement of limit. |
| 15.203  | Antenna Requirement   | Pass   | No antenna connector is used.  |

**Note1:** If the Frequency Hopping System operating in 2400-2483.5MHz band and the output power less than 125mW. The hopping channel carrier frequencies separated by a minimum of 25kHz or two-thirds of the 20dB bandwidth of hopping channel whichever is greater.

**Note2:** The EUT has been verified to comply with the requirements of FCC Part 15, Subpart B, Class B (sDoC). The test report has been issued separately.

**1.1 Measurement Uncertainty**

Where relevant, the following measurement uncertainty levels have been estimated for tests performed on the EUTas specified in CISPR 16-4-2:

The listed uncertainties are the worst-case uncertainty for the entire range of measurement. Please note that the uncertainty values are provided for informational purposes only and are not used in determining the PASS/FAIL results.

| Measurement                    | Frequency       | Expanded Uncertainty (k=2) (±) |
|--------------------------------|-----------------|--------------------------------|
| Radiated Emissions up to 1 GHz | 9KHz ~ 30MHz    | 2.16 dB                        |
|                                | 30MHz ~ 1000MHz | 3.47 dB                        |
| Radiated Emissions above 1 GHz | 1GHz ~ 18GHz    | 4.84 dB                        |
|                                | 18GHz ~ 40GHz   | 4.67 dB                        |

Note: This uncertainty represents an expanded uncertainty expressed at approximately the 95% confidence level using a coverage factor of k = 2.

**1.2 Modification Record**

There were no modifications required for compliance.



2 General Information

2.1 General Description of EUT

|                     |   |
|---------------------|---|
| Product(s)          | Party Speaker   |
| Test Model(s)       | AX700W/10   |
| Sample No.          | HS230111-02-01  |
| Series Model(s)     | AX701B/10, AX701U/10, AX700x/yy,AX701x/yy (x=A-Z or NiL , yy=00-99 or NiL for country code) |
| Status of EUT       | Engineering Prototype   |
| Power Supply Rating | AC 100-240V~ 50/60Hz 50W  |
| Modulation Type     | GFSK, π/4 DQPSK, 8DPSK for FHSS   |
| Transfer Rate       | 1Mbps, 2Mbps, 3Mbps   |
| Operating Frequency | 2402 ~ 2480MHz  |
| Number of Channel   | 79  |
| Output Power (Peak) | 9.094dBm  |
| Antenna Type        | FPC Antenna   |
| Antenna Gain        | 2.14dBi   |
| Antenna Connector   | N/A   |
| Accessory Devider   | N/A   |

Note:

1. Please refer to the EUT photo document (Reference No.:221226KH23-01&02) for detailed product photo.
2. The above EUT information is declared by manufacturer and for more detailed features description, please refer to the manufacturer's specifications or User's Manual.
3. Model difference:

| Model name   | Differences                     |
|--|---------------------------------|
| AX700W/10, AX700x/yy (x=A-Z or NiL, yy=00-99 or NiL for country code)            | With Light effect, without cart |
| AX701B/10, AX701U/10, AX701x/yy (x=A-Z or NiL, yy=00-99 or NiL for country code) | Without Light effect, with cart |
| All models are identical except for the differences described above and color.   |                                 |



### 2.2 Description of Test Modes

79 channels are provided to this EUT:

| Channel | Freq. (MHz) | Channel | Freq. (MHz) | Channel | Freq. (MHz) | Channel | Freq. (MHz) |
|---------|-------------|---------|-------------|---------|-------------|---------|-------------|
| 0       | 2402        | 20      | 2422        | 40      | 2442        | 60      | 2462        |
| 1       | 2403        | 21      | 2423        | 41      | 2443        | 61      | 2463        |
| 2       | 2404        | 22      | 2424        | 42      | 2444        | 62      | 2464        |
| 3       | 2405        | 23      | 2425        | 43      | 2445        | 63      | 2465        |
| 4       | 2406        | 24      | 2426        | 44      | 2446        | 64      | 2466        |
| 5       | 2407        | 25      | 2427        | 45      | 2447        | 65      | 2467        |
| 6       | 2408        | 26      | 2428        | 46      | 2448        | 66      | 2468        |
| 7       | 2409        | 27      | 2429        | 47      | 2449        | 67      | 2469        |
| 8       | 2410        | 28      | 2430        | 48      | 2450        | 68      | 2470        |
| 9       | 2411        | 29      | 2431        | 49      | 2451        | 69      | 2471        |
| 10      | 2412        | 30      | 2432        | 50      | 2452        | 70      | 2472        |
| 11      | 2413        | 31      | 2433        | 51      | 2453        | 71      | 2473        |
| 12      | 2414        | 32      | 2434        | 52      | 2454        | 72      | 2474        |
| 13      | 2415        | 33      | 2435        | 53      | 2455        | 73      | 2475        |
| 14      | 2416        | 34      | 2436        | 54      | 2456        | 74      | 2476        |
| 15      | 2417        | 35      | 2437        | 55      | 2457        | 75      | 2477        |
| 16      | 2418        | 36      | 2438        | 56      | 2458        | 76      | 2478        |
| 17      | 2419        | 37      | 2439        | 57      | 2459        | 77      | 2479        |
| 18      | 2420        | 38      | 2440        | 58      | 2460        | 78      | 2480        |
| 19      | 2421        | 39      | 2441        | 59      | 2461        | -       | -           |



**2.3 Test Mode Applicability and Tested Channel Detail**

| EUT Configure Mode                 | Applicable test items   | X-Axis | Y-Axis | Z-Axis | Voltage Supply |
|------------------------------------|---|--------|--------|--------|----------------|
| Conducted                          | AC Power Conducted Emission   | N/A    | N/A    | N/A    | AC 230/50Hz    |
| Radiated                           | Radiated Emissions  | √      | √      | √      |                |
| Antenna Port Conducted Measurement | Number of Hopping Frequency Used  | N/A    | N/A    | N/A    |                |
|                                    | Dwell Time on Each Channel  | N/A    | N/A    | N/A    |                |
|                                    | Band Edge Measurement   | N/A    | N/A    | N/A    |                |
|                                    | Antenna Port Emission   | N/A    | N/A    | N/A    |                |
|                                    | Conducted power   | N/A    | N/A    | N/A    |                |
|                                    | Hopping Channel Separation  | N/A    | N/A    | N/A    |                |
|                                    | Spectrum Bandwidth of a Frequency Hopping Sequence Spread Spectrum System | N/A    | N/A    | N/A    |                |

- \*: The EUT had been pre-tested on the positioned of each 3 Axis. The worst case was found when positioned on **X-plane**.
- “N/A” means no effect.

**Evaluation of difference data rate:**

| Applicable test items              | Modulation Type |               |       | The Worst-case modes recording in report |
|------------------------------------|-----------------|---------------|-------|--|
|                                    | GFSK            | $\pi/4$ DQPSK | 8DPSK |  |
| Radiated Emissions                 | √               | √             | √     | GFSK& 8DPSK                              |
| Antenna Port Conducted Measurement | √               | √             | √     | GFSK& 8DPSK                              |

**Test Condition:**

| Applicable test items              | Environmental Conditions | Test Date     | Tested by   |
|------------------------------------|--------------------------|---------------|-------------|
| Radiated Emissions                 | 22.8deg. C, 54%RH        | Feb. 20, 2023 | Dragon Long |
| Antenna Port Conducted Measurement | 22.3deg. C, 52%RH        | Feb. 16, 2023 | Dragon Long |

- Pre-Scan has been conducted to determine the worst-case mode from all possible combinations between available modulations, data rates and antenna ports (if EUT with antenna diversity architecture). Following channel(s) was (were) selected for the final test as listed below.





**Radiated Emission Test (Above 1 GHz):**

| EUT Configure Mode | Available Channel | Tested Channel | Modulation Technology | Modulation Type | Packet Type |
|--------------------|-------------------|----------------|-----------------------|-----------------|-------------|
| -                  | 0 to 78           | 0, 39, 78      | FHSS                  | GFSK            | DH5         |
| -                  | 0 to 78           | 0, 39, 78      | FHSS                  | 8DPSK           | 3DH5        |

**Radiated Emission Test (Below 1 GHz):**

| EUT Configure Mode | Available Channel | Tested Channel | Modulation Technology | Modulation Type | Packet Type |
|--------------------|-------------------|----------------|-----------------------|-----------------|-------------|
| -                  | 0 to 78           | 0              | FHSS                  | GFSK            | DH5         |
| -                  | 0 to 78           | 39             | FHSS                  | 8DPSK           | 3DH5        |

**Power Line Conducted Emission Test:**

| EUT Configure Mode | Available Channel | Tested Channel | Modulation Technology | Modulation Type | Packet Type |
|--------------------|-------------------|----------------|-----------------------|-----------------|-------------|
| -                  | 0 to 78           | 39             | FHSS                  | GFSK            | DH5         |

**Antenna Port Conducted Measurement:**

This item includes all test value of each mode, but only includes spectrum plot of worst value of each mode.

| EUT Configure Mode | Available Channel | Tested Channel | Modulation Technology | Modulation Type | Packet Type |
|--------------------|-------------------|----------------|-----------------------|-----------------|-------------|
| -                  | 0 to 78           | 0, 39, 78      | FHSS                  | GFSK            | DH5         |
| -                  | 0 to 78           | 0, 39, 78      | FHSS                  | 8DPSK           | 3DH5        |



### 2.4 Description of Support Units

The EUT has been tested as an independent unit together with other necessary accessories or support units. The following support units or accessories were used to form a representative test configuration during the tests.

| No. | Product  | Brand | Model No.     | Serial No. | FCC ID |
|-----|----------|-------|---------------|------------|--------|
| 1.  | Notebook | DELL  | Latitude 5300 | N/A        | N/A    |

| No. | Signal Cable Description of The Above Support Units |
|-----|---|
| 1.  | USB serial cable Un-shielded1.2m                    |
| 2.  | /   |

#### 2.4.1 Configuration of System under Test

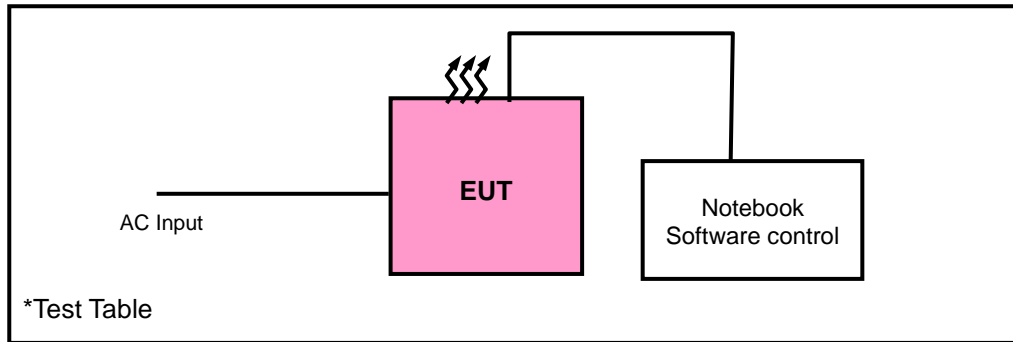



3 Test Types and Results

3.1 Radiated Emission and Band-edge Measurement

3.1.1 Limits of Radiated Emission and Band-edge Measurement

Radiated emissions which fall in the restricted bands must comply with the radiated emission limits specified as below table. Other emissions shall be at least 20 dB below the highest level of the desired power:

| Frequencies (MHz) | Field Strength (microvolts/meter) | Measurement Distance (meters) |
|-------------------|-----------------------------------|-------------------------------|
| 0.009 ~ 0.490     | 2400/F(kHz)                       | 300                           |
| 0.490 ~ 1.705     | 24000/F(kHz)                      | 30                            |
| 1.705 ~ 30.0      | 30                                | 30                            |
| 30 ~ 88           | 100                               | 3                             |
| 88 ~ 216          | 150                               | 3                             |
| 216 ~ 960         | 200                               | 3                             |
| Above 960         | 500                               | 3                             |

\* DTS emissions in non-restricted frequency bands Subclause 11.11 of ANSI C63.10 is applicable.

\* DTS emissions in restricted frequency bands Subclause 11.12 of ANSI C63.10 is applicable

Note:

1. The lower limit shall apply at the transition frequencies.
2. Emission level (dBuV/m) = 20 log Emission level (uV/m).
3. For frequencies above 1000 MHz, the field strength limits are based on average detector, however, the peak field strength of any emission shall not exceed the maximum permitted average limits, specified above by more than 20 dB under any condition of modulation.



3.1.2 Test Instruments

Radiated emission below 30MHz:

| Equipment                           | Manufacturer  | Model No. | Serial No.     | Next Cal.   |
|-------------------------------------|---------------|-----------|----------------|-------------|
| EMI Test Receiver                   | Rohde&Schwarz | ESR7      | 100962         | 2023-12-27  |
| 3m Semi-anechoic Chamber            | MAORUI        | 9m*6m*6m  | NSEMC003       | 2023-04-15* |
| Test software                       | FARAD         | FARAD     | EZ_EMCV1.1.4.2 | N/A         |
| Loop Antenna                        | EMCI          | HLA 6121  | 56735          | 2023-04-15* |
| Preamplifier                        | EMCI          | EMC001340 | 980201         | 2023-04-15  |
| Antenna Tower                       | MF            | MFA-440H  | NA             | NA          |
| Turn Table                          | MF            | MFT-201SS | NA             | NA          |
| Antenna Tower&Turn Table Controller | MF            | MF-7802   | NA             | NA          |

Frequency Range below 1GHz:

| Equipment                | Manufacturer  | Model No. | Serial No.     | Next Cal.   |
|--------------------------|---------------|-----------|----------------|-------------|
| 3m Semi-anechoic Chamber | MAORUI        | 9m*6m*6m  | NSEMC003       | 2023-04-15  |
| EMI Test Receiver        | Rohde&Schwarz | ESR7      | 100962         | 2023-09-12* |
| Broadband antenna        | Schwarzbeck   | VULB 9168 | 00937          | 2023-04-15* |
| Signal Amplifier         | Com-power     | PAM-103   | 18020051       | 2023-08-25  |
| Attenuator               | Rohde&Schwarz | TS2GA-6dB | 18101101       | N/A         |
| Test software            | FARAD         | FARAD     | EZ_EMCV1.1.4.2 | N/A         |

Frequency Range 1-18GHz:

| Equipment                           | Manufacturer | Model No.  | Serial No. | Next Cal.   |
|-------------------------------------|--------------|------------|------------|-------------|
| 3m Semi-anechoic Chamber            | MAORUI       | 9m*6m*6m   | NSEMC003   | 2023-04-15* |
| Horn Antenna                        | Schwarzbeck  | BBHA 9120D | 01959      | 2024-05-04  |
| Broadband Coaxial Preamplifier      | Com-power    | PAM-118A   | 1804003    | 2023-08-25  |
| Spectrum                            | Keysight     | N9020A     | MY51240612 | 2023-08-25  |
| Antenna Tower                       | MF           | MFA-440H   | NA         | NA          |
| Turn Table                          | MF           | MFT-201SS  | NA         | NA          |
| Antenna Tower&Turn Table Controller | MF           | MF-7802    | NA         | NA          |

Frequency Range 18-40GHz:

| Equipment                           | Manufacturer  | Model No.  | Serial No.  | Next Cal.   |
|-------------------------------------|---------------|------------|-------------|-------------|
| 3m Semi-anechoic Chamber            | MAORUI        | 9m*6m*6m   | NSEMC003    | 2023-04-15* |
| Spectrum Analyzer                   | Rohde&Schwarz | FSV-40N    | 101783      | 2023-12-27  |
| Horn Antenna                        | Schwarzbeck   | BBHA 9170  | BBHA9170242 | 2023-04-10* |
| Pre-Amplifier                       | EMCI          | EMC 184045 | 980102      | 2023-12-27  |
| Antenna Tower                       | MF            | MFA-440H   | NA          | NA          |
| Turn Table                          | MF            | MFT-201SS  | NA          | NA          |
| Antenna Tower&Turn Table Controller | MF            | MF-7802    | NA          | NA          |

Note:

1. The calibration interval of the above test instruments is 12 months or 24 months (\*).
2. The test was performed in 966



3.1.3 Test Procedures

a. **Peak emission levels are measured by setting the instrument as follow:**

1) RBW&VBWsetting as a function of frequency:

| Frequency     | RBW    | VBW    |
|---------------|--------|--------|
| 9kHz~150kHz   | 200Hz  | 600Hz  |
| 0.15MHz~30MHz | 9kHz   | 30kHz  |
| 30MHz~1000MHz | 120kHz | 300kHz |
| >1000MHz      | 1MHz   | 3MHz   |

- 2) Detector = peak.
- 3) Sweep time = auto.
- 4) Trace mode = max hold.
- 5) Allow sweeps to continue until the trace stabilizes. (Note that the required measurement time may be lengthened for low-duty-cycle applications.)

Note: If the peak-detected amplitude can be shown to comply with the average limit, then it is not necessary to perform a separate average measurement

b. **Average emission levels are measured by setting the instrument as follow:**

● **Trace averaging with continuous EUT transmission at full power**

If the EUT can be configured or modified to transmit continuously (D ≥ 98%), then the average emission levels shall be measured using the following method (with EUT transmitting continuously):

- 1) RBW=1 MHz (unless otherwise specified).
- 2) VBW ≥ 3 \*RBW.
- 3) Detector =RMS
- 4) Sweep time = auto.
- 5) Perform a trace average of at least 100 traces.

● **Trace averaging across ON and OFF times of the EUT transmissions followed by duty cycle correction**

If continuous transmission of the EUT (D≥98%) cannot be achieved and the duty cycle is constant (duty cycle variations are less than ±2%), then the following procedure shall be used

- 1) The EUT shall be configured to operate at the maximum achievable duty cycle.
- 2) Measure the duty cycle D of the transmitter output signal as described in 11.6.
- 3) RBW=1 MHz (unless otherwise specified).
- 4) VBW ≥ 3 \*RBW.
- 5) Detector =RMS
- 6) Sweep time = auto.
- 7) Perform a trace average of at least 100 traces.

A correction factor shall be added to the measurement results prior to comparing with the emission limit to compute the emission level that would have been measured had the test been performed at 100% duty cycle. The correction factor is computed as follows:

\*If power averaging (rms) mode was used in step 5). then the applicable correction factor is [10 10g (1/ D)], where D is the duty cycle.

\*\*If linear voltage averaging mode was used in step f). then the applicable correction factor is [20 10g (1/D)], where D is the duty cycle.

\*\*\*If a specific emission is demonstrated to be continuous (D > 98%) rather than turning ON and OFF with the transmit cycle, then no duty cycle correction is required for that



● **Reduced VBW Averaging across ON and OFF times of the EUT transmissions with max hold**

If continuous transmission of the EUT ( $D > 98\%$ ) cannot be achieved and the duty cycle is not constant (duty cycle variations exceed  $\pm 2\%$ ), then the following procedure shall be used:

- 1) RBW = 1 MHz.
  - 2)  $VBW \geq 1/T$ .
  - 3) Detector = peak
  - 4) Sweep time = auto.
  - 5) Trace mode = max hold.
  - 6) Allow max hold to run for at least  $[50 \times (1/D)]$  traces
- c. The EUT was placed on the top of a rotating table 0.8 meters (below 1GHz) / 1.5 meters (1-18GHz) / 1.5 meters (18-40GHz) above the reference ground. The table was rotated 360 degrees to determine the position of the highest radiation.
- d. The EUT was set 3 meters away from the interference-receiving antenna (Below 1GHz) & (Above 1-18GHz), which was mounted on the top of a variable-height antenna tower. The EUT was set 1 meters away from the interference-receiving antenna (18-40GHz).
- e. The height of antenna is varied from one meter to four meters above the ground to determine the maximum value of the field strength. Both horizontal and vertical polarizations of the antenna are set to make the measurement.
- f. For each suspected emission, the EUT was arranged to its worst case and then the antenna was tuned to heights from 1 meter to 4 meters and the rotatable table was turned from 0 degrees to 360 degrees to find the maximum reading.
- g. The test-receiver system was set to quasi-peak detect function and specified bandwidth with maximum hold mode when the test frequency is below 1 GHz.

The test-receiver system was set to peak and average detected function and specified bandwidth with maximum hold mode when the test frequency is above 1 GHz. If the peak reading value also meets average limit, measurement with the average detector is unnecessary.

Note:

1. Test procedures for measuring FHSS device: The use of a duty cycle correction factor (DCCF) is permitted for calculating average radiated field strength emission levels for an FHSS device in 15.247. This DCCF can be applied when the unwanted emission limit is subject to an average field strength limit (e.g., within a Government Restricted band) and the conditions specified in Section 15.35(c) can be satisfied. The average radiated field strength is calculated by subtracting the DCCF from the maximum radiated field strength level as determined through measurement. The maximum radiated field strength level represents the worst-case (maximum amplitude) RMS measurement of the emission(s) during continuous transmission (i.e., not including any time intervals during which the transmitter is off or is transmitting at a reduced power level). It is also acceptable to apply the DCCF to a measurement performed with a peak detector instead of the specified RMS power averaging detector. Note that Section 15.35(c) specifies that the DCCF shall represent the worst-case (greatest duty cycle) over any 100 msec transmission period. Subclause 7.5 of ANSI C63.10 provides additional measurement guidance applicable to determination of the DCCF.
2. All modes of operation were investigated and the worst-case emissions are reported.

3.1.4 Deviation from Test Standard

No deviation.



### 3.1.5 Test Setup

Radiated emission below 30MHz:

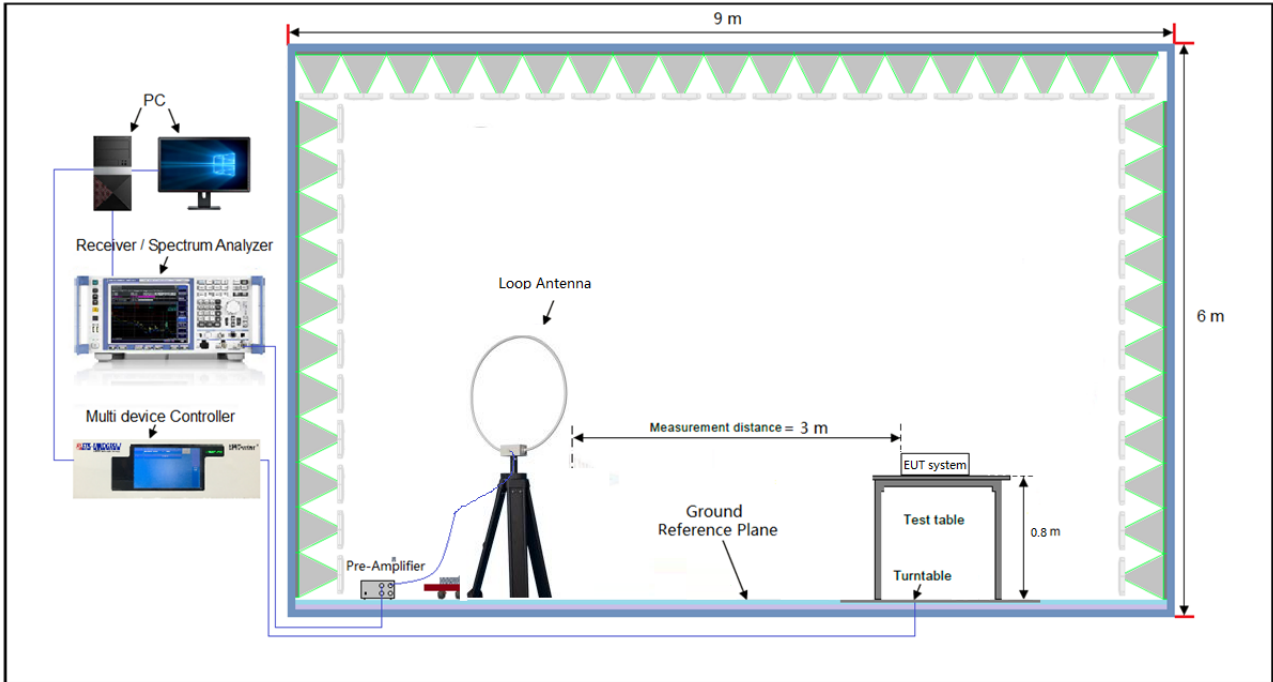

Frequency Range below 1GHz:

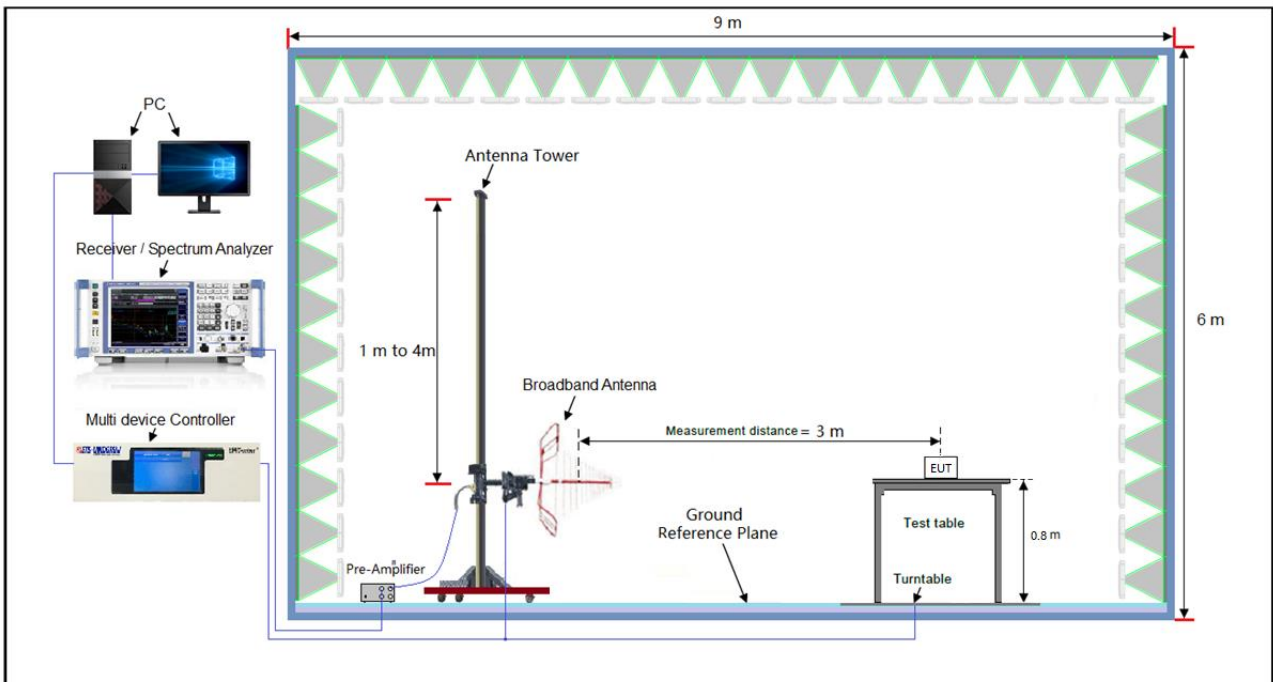



Frequency Range above 1GHz:

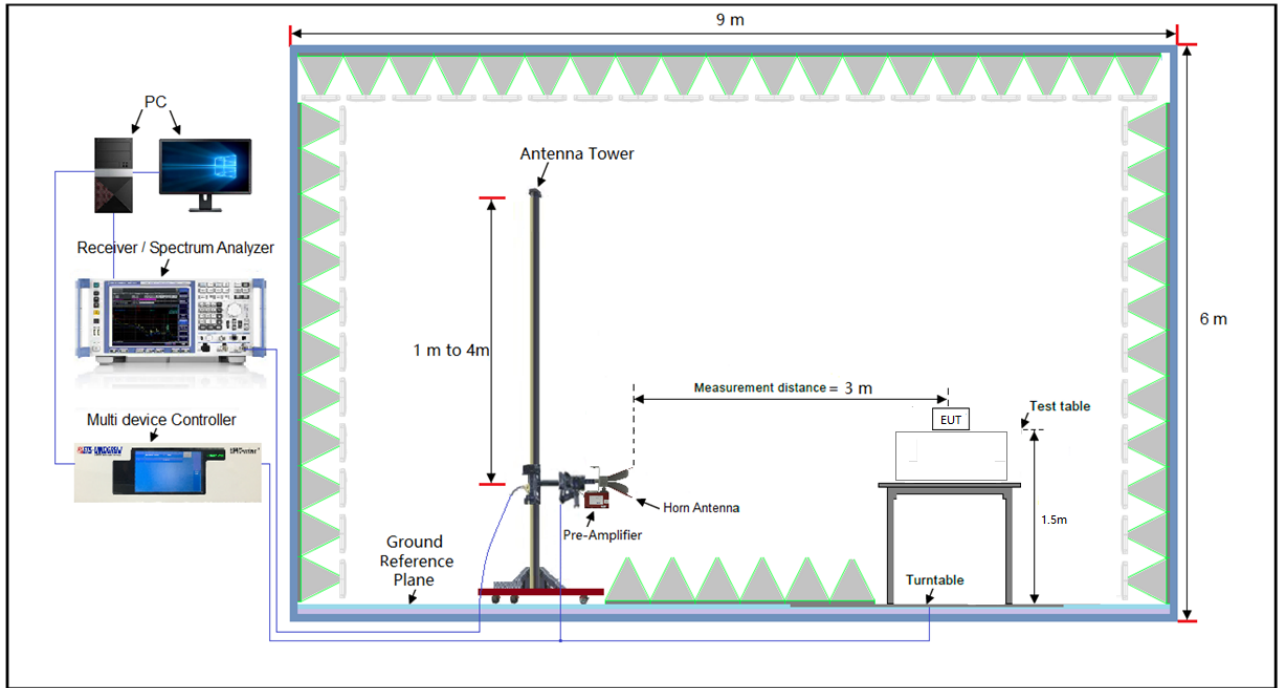

Frequency Range 18-40GHz:

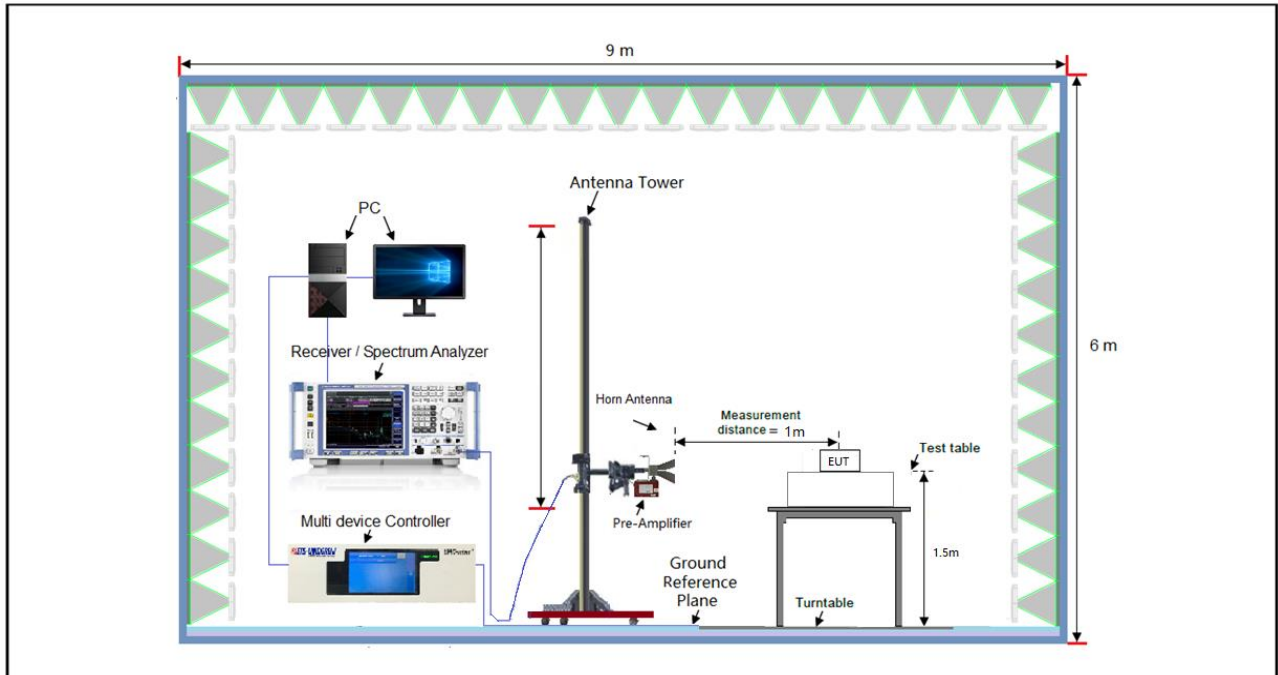

\*For the actual test configuration, please refer to the attached file (Test Setup Photo).

3.1.6 EUT Operating Conditions

Set the EUT under transmission condition continuously at specific channel frequency.





3.1.7 Test Results

9 kHz ~ 30 MHz Data:

The amplitude of spurious emissions attenuated more than 20 dB below the permissible value is not required to be report.

30 MHz ~ 1GHz Worst-Case Data:

|                 |              |                   |                              |
|-----------------|--------------|-------------------|------------------------------|
| Frequency Range | 30MHz ~ 1GHz | Detector Function | Peak (PK)<br>Quasi-peak (QP) |
| Test Channel    | Channel 0    |                   |                              |

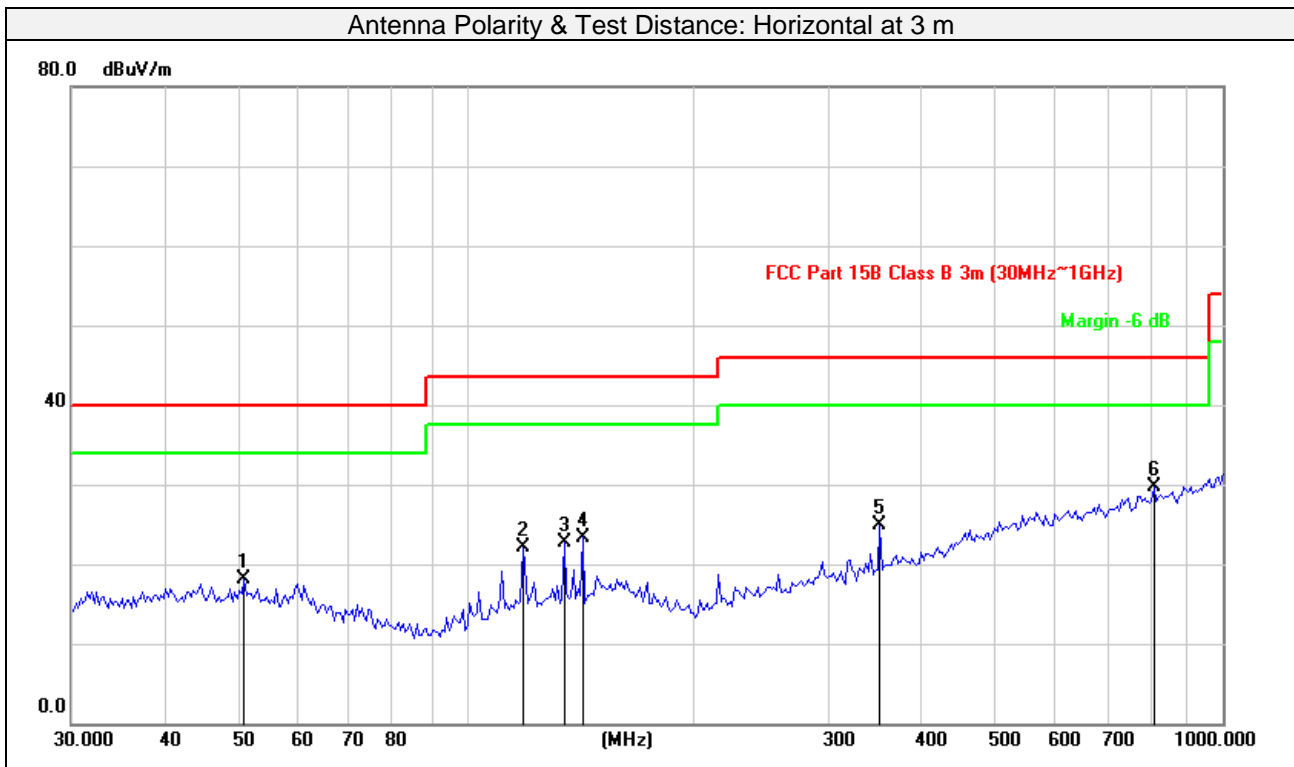

| No. | Frequency (MHz) | Reading (dBuV) | Factor (dB) | Emission Level (dBuV/m) | Limit (dBuV/m) | Margin (dB) | Detector | Antenna Height (cm) | Table Angle (Degree) |
|-----|-----------------|----------------|-------------|-------------------------|----------------|-------------|----------|---------------------|----------------------|
| 1   | 50.7637         | 33.35          | -15.17      | 18.18                   | 40.00          | -21.82      | peak     | 130                 | 154                  |
| 2   | 118.6014        | 38.41          | -16.25      | 22.16                   | 43.50          | -21.34      | peak     | 150                 | 268                  |
| 3   | 134.5592        | 37.98          | -15.21      | 22.77                   | 43.50          | -20.73      | peak     | 200                 | 278                  |
| 4   | 142.3243        | 38.18          | -14.78      | 23.40                   | 43.50          | -20.10      | peak     | 100                 | 230                  |
| 5   | 351.7079        | 36.28          | -11.47      | 24.81                   | 46.00          | -21.19      | peak     | 120                 | 230                  |
| 6 * | 810.2654        | 31.71          | -1.99       | 29.72                   | 46.00          | -16.28      | peak     | 200                 | 136                  |

Remarks:

1. Emission Level = Read Level + Factor (Antenna Factor + Cable Loss - Preamp Factor)
2. Margin value = Emission level – Limit value



|                 |              |                   |                              |
|-----------------|--------------|-------------------|------------------------------|
| Frequency Range | 30MHz ~ 1GHz | Detector Function | Peak (PK)<br>Quasi-peak (QP) |
| Test Channel    | Channel 0    |                   |                              |

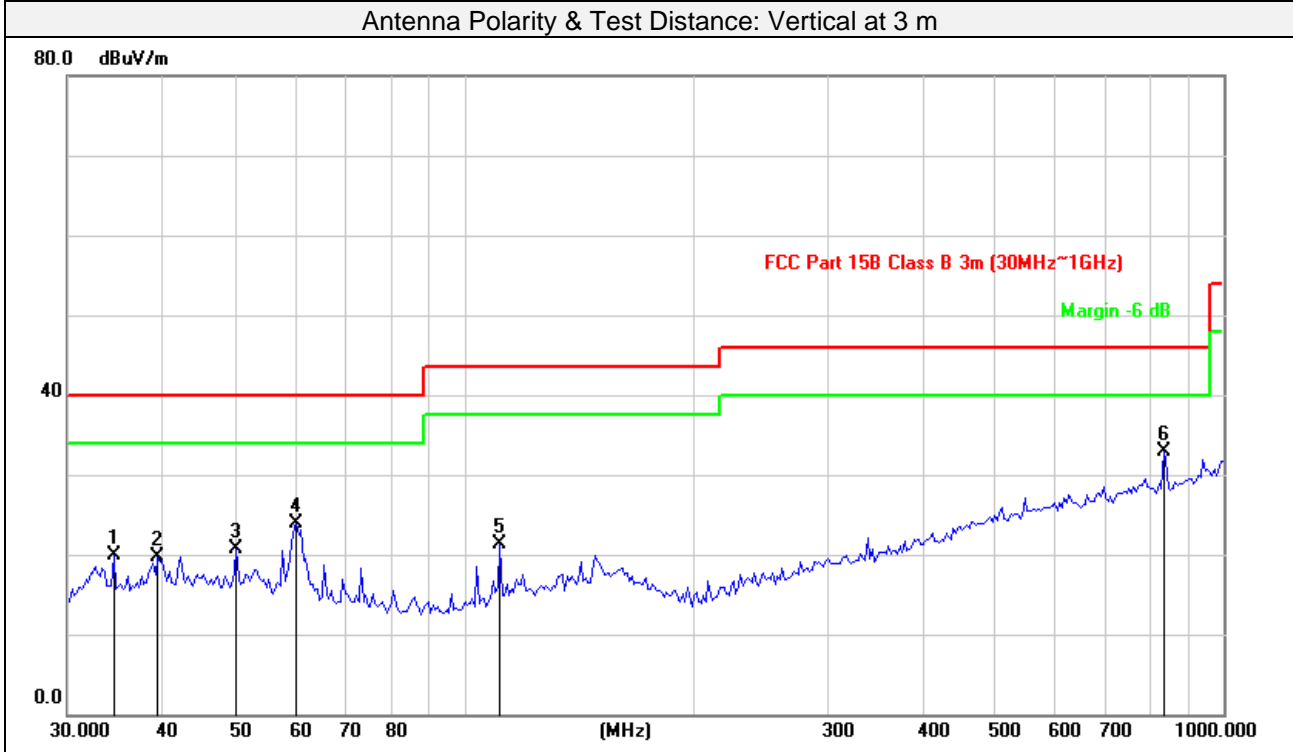

| No. | Frequency (MHz) | Reading (dBuV) | Factor (dB) | Emission Level (dBuV/m) | Limit (dBuV/m) | Margin (dB) | Detector | Antenna Height (cm) | Table Angle (Degree) |
|-----|-----------------|----------------|-------------|-------------------------|----------------|-------------|----------|---------------------|----------------------|
| 1   | 34.5173         | 35.57          | -15.63      | 19.94                   | 40.00          | -20.06      | peak     | 130                 | 230                  |
| 2   | 39.4371         | 34.64          | -14.94      | 19.70                   | 40.00          | -20.30      | peak     | 100                 | 154                  |
| 3   | 50.0566         | 35.78          | -15.10      | 20.68                   | 40.00          | -19.32      | peak     | 100                 | 261                  |
| 4   | 60.0691         | 39.99          | -16.16      | 23.83                   | 40.00          | -16.17      | peak     | 200                 | 157                  |
| 5   | 111.3468        | 38.20          | -16.93      | 21.27                   | 43.50          | -22.23      | peak     | 120                 | 158                  |
| 6 * | 833.3171        | 34.61          | -1.67       | 32.94                   | 46.00          | -13.06      | peak     | 150                 | 230                  |

Remarks:

1. Emission Level = Read Level + Factor (Antenna Factor + Cable Loss - Preamp Factor)
2. Margin value = Emission level – Limit value



Above 1GHz Data:

GFSK

|                 |              |                   |                            |
|-----------------|--------------|-------------------|----------------------------|
| Frequency Range | 1GHz ~ 25GHz | Detector Function | Peak (PK)<br>Average (AVG) |
| Test Channel    | Channel 0    |                   |                            |

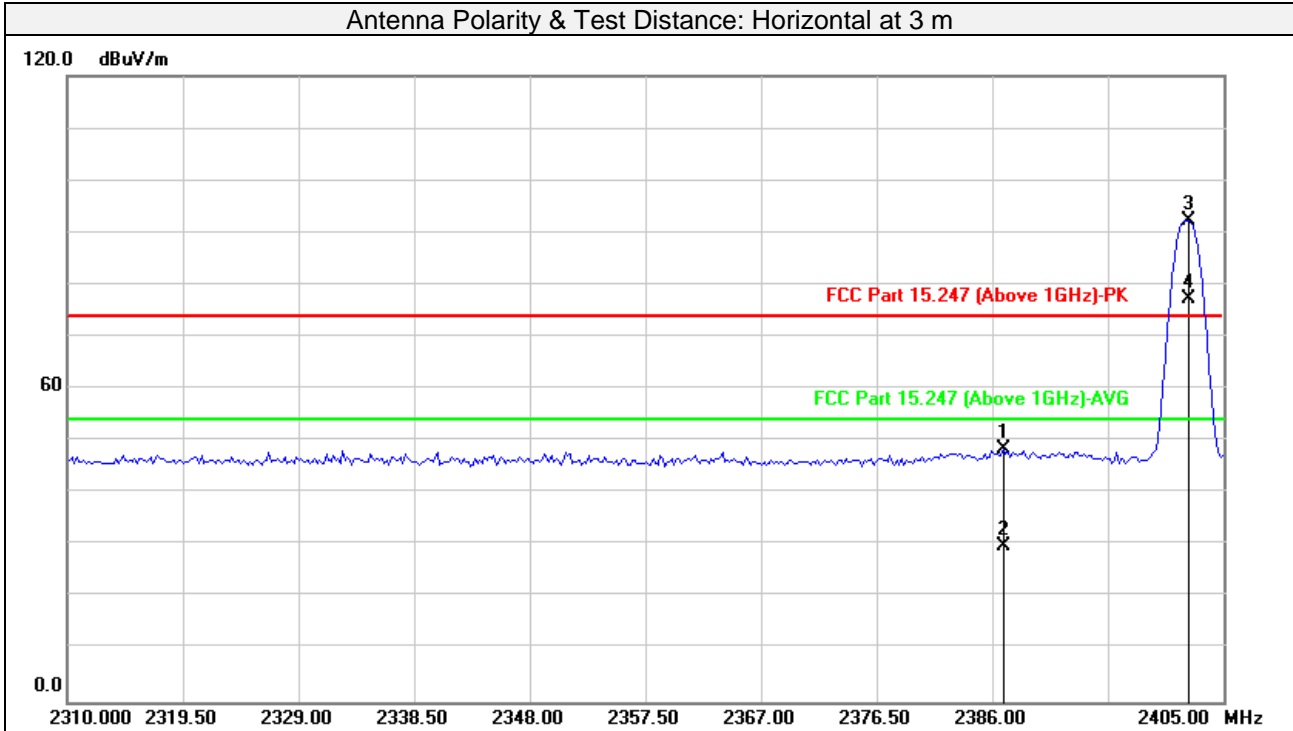

| No. | Frequency (MHz) | Reading (dBuV) | Factor (dB) | Emission Level (dBuV/m) | Limit (dBuV/m) | Margin (dB) | Detector | Antenna Height (cm) | Table Angle (Degree) |
|-----|-----------------|----------------|-------------|-------------------------|----------------|-------------|----------|---------------------|----------------------|
| 1   | 2386.914        | 48.05          | 0.34        | 48.39                   | 74.00          | -25.61      | peak     | 326                 | 158                  |
| 2   | 2386.914        | 29.49          | 0.34        | 29.83                   | 54.00          | -24.17      | AVG      | 326                 | 158                  |
| 3#  | 2402.144        | 91.91          | 0.31        | 92.22                   |                |             | peak     | 326                 | 158                  |
| 4#  | 2402.144        | 76.93          | 0.31        | 77.24                   |                |             | AVG      | 326                 | 158                  |
| 5   | 4804.000        | 43.24          | 7.27        | 50.51                   | 74.00          | -23.49      | peak     | 100                 | 311                  |
| 6   | 4804.000        | 36.09          | 7.27        | 43.36                   | 54.00          | -10.64      | AVG      | 100                 | 311                  |
| 7   | 7206.000        | 42.71          | 10.75       | 53.46                   | 74.00          | -20.54      | peak     | 230                 | 159                  |
| 8   | 7206.000        | 34.34          | 10.75       | 45.09                   | 54.00          | -8.91       | AVG      | 230                 | 159                  |
| 9   | 9608.000        | 40.16          | 14.78       | 54.94                   | 74.00          | -19.06      | peak     | 100                 | 212                  |
| 10  | 9608.000        | 31.59          | 14.78       | 46.37                   | 54.00          | -7.63       | AVG      | 100                 | 212                  |

Remarks:

- Emission Level = Read Level + Factor (Antenna Factor + Cable Loss - Preamp Factor)  
Margin value = Emission level – Limit value
- #2402MHz: Fundamental frequency.
- The amplitude of spurious emissions attenuated more than 20 dB below the permissible value is not required to be report.

Lab: [Hwa-Hsing \(Dongguan\) Testing Co., Ltd.](#)  
Address: [No.101, Bld N1, Yuyuan 2Rd, Yuyuan Industrial Park, HuangJiang Town, Dongguan, China](#)

Tel: [0769-83078199](tel:0769-83078199)  
Web.: [www.hwa-hsing.com](http://www.hwa-hsing.com)  
E-Mail: [customerservice.dg@hwa-hsing.com](mailto:customerservice.dg@hwa-hsing.com)

Release  
[Ver. 1.5](#)



|                 |              |                   |                            |
|-----------------|--------------|-------------------|----------------------------|
| Frequency Range | 1GHz ~ 25GHz | Detector Function | Peak (PK)<br>Average (AVG) |
| Test Channel    | Channel 0    |                   |                            |

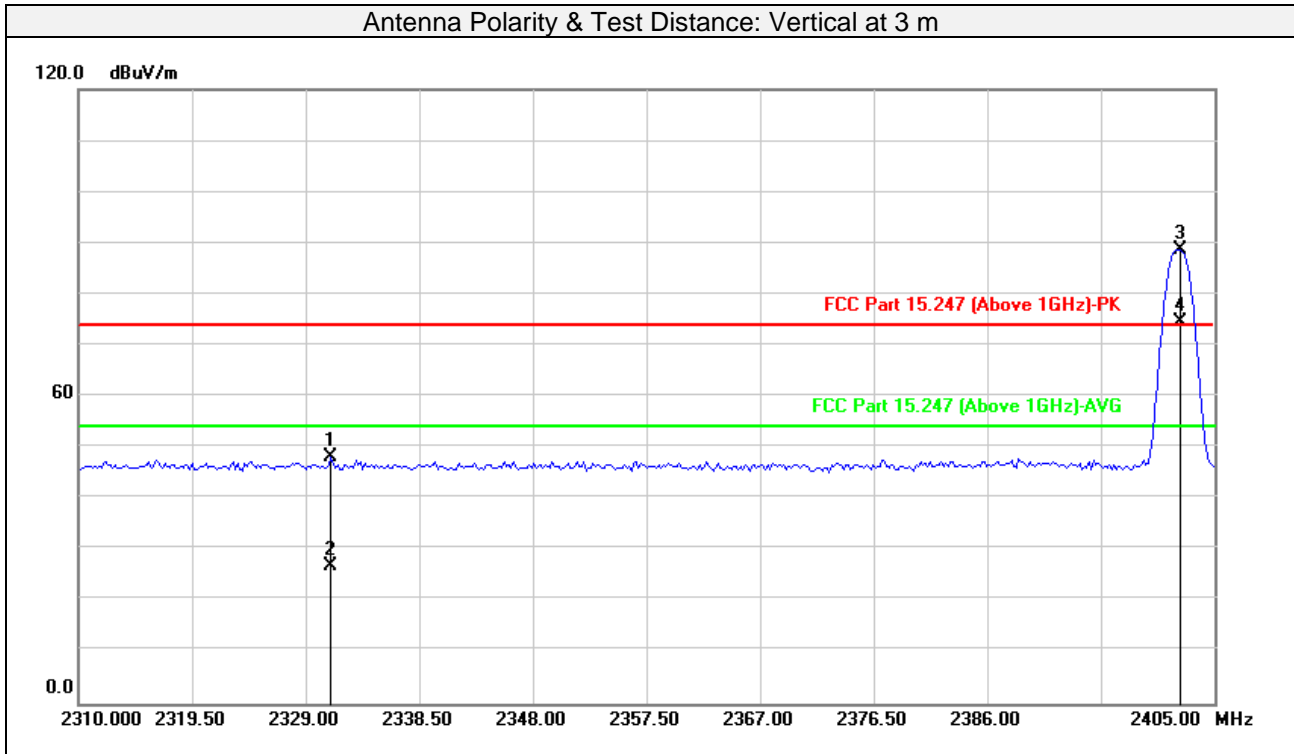

| No. | Frequency (MHz) | Reading (dBuV) | Factor (dB) | Emission Level (dBuV/m) | Limit (dBuV/m) | Margin (dB) | Detector | Antenna Height (cm) | Table Angle (Degree) |
|-----|-----------------|----------------|-------------|-------------------------|----------------|-------------|----------|---------------------|----------------------|
| 1   | 2331.132        | 47.71          | 0.41        | 48.12                   | 74.00          | -25.88      | peak     | 238                 | 318                  |
| 2   | 2331.132        | 26.51          | 0.41        | 26.92                   | 54.00          | -27.08      | AVG      | 238                 | 318                  |
| 3#  | 2402.144        | 88.34          | 0.31        | 88.65                   |                |             | peak     | 238                 | 318                  |
| 4#  | 2402.144        | 74.13          | 0.31        | 74.44                   |                |             | AVG      | 238                 | 318                  |
| 5   | 4804.000        | 45.30          | 7.27        | 52.57                   | 74.00          | -21.43      | peak     | 278                 | 288                  |
| 6   | 4804.000        | 37.82          | 7.27        | 45.09                   | 54.00          | -8.91       | AVG      | 278                 | 288                  |
| 7   | 7206.000        | 45.31          | 10.75       | 56.06                   | 74.00          | -17.94      | peak     | 352                 | 317                  |
| 8   | 7206.000        | 38.84          | 10.75       | 49.59                   | 54.00          | -4.41       | AVG      | 352                 | 317                  |
| 9   | 9608.000        | 41.77          | 14.78       | 56.55                   | 74.00          | -17.45      | peak     | 360                 | 211                  |
| 10  | 9608.000        | 30.55          | 14.78       | 45.33                   | 54.00          | -8.67       | AVG      | 360                 | 211                  |

Remarks:

- Emission Level = Read Level + Factor (Antenna Factor + Cable Loss - Preamp Factor)  
Margin value = Emission level – Limit value
- #2402MHz: Fundamental frequency.
- The amplitude of spurious emissions attenuated more than 20 dB below the permissible value is not required to be report.

Lab: [Hwa-Hsing \(Dongguan\) Testing Co., Ltd.](#)  
Address: [No.101, Bld N1, Yuyuan 2Rd, Yuyuan Industrial Park, HuangJiang Town, Dongguan, China](#)

Tel: [0769-83078199](tel:0769-83078199)  
Web.: [www.hwa-hsing.com](http://www.hwa-hsing.com)  
E-Mail: [customerservice.dg@hwa-hsing.com](mailto:customerservice.dg@hwa-hsing.com)

Release  
[Ver. 1.5](#)



|                 |              |                   |                            |
|-----------------|--------------|-------------------|----------------------------|
| Frequency Range | 1GHz ~ 25GHz | Detector Function | Peak (PK)<br>Average (AVG) |
| Test Channel    | Channel 39   |                   |                            |

| Antenna Polarity & Test Distance: Horizontal at 3 m |                 |                |             |                         |                |             |          |                     |                      |
|---|-----------------|----------------|-------------|-------------------------|----------------|-------------|----------|---------------------|----------------------|
| No.   | Frequency (MHz) | Reading (dBuV) | Factor (dB) | Emission Level (dBuV/m) | Limit (dBuV/m) | Margin (dB) | Detector | Antenna Height (cm) | Table Angle (Degree) |
| 1 #   | 2441.000        | 86.85          | 0.69        | 87.54                   |                |             | peak     | 256                 | 136                  |
| 2 #   | 2441.000        | 68.18          | 0.69        | 68.87                   |                |             | AVG      | 256                 | 136                  |
| 3   | 4882.000        | 45.56          | 7.61        | 53.17                   | 74.00          | -20.83      | peak     | 144                 | 120                  |
| 4   | 4882.000        | 33.75          | 7.61        | 41.36                   | 54.00          | -12.64      | AVG      | 144                 | 120                  |
| 5   | 7323.000        | 41.76          | 10.92       | 52.68                   | 74.00          | -21.32      | peak     | 236                 | 45                   |
| 6   | 7323.000        | 31.05          | 10.92       | 41.97                   | 54.00          | -12.03      | AVG      | 236                 | 45                   |
| 7   | 9764.000        | 39.93          | 15.37       | 55.30                   | 74.00          | -18.70      | peak     | 258                 | 123                  |
| 8   | 9764.000        | 26.27          | 15.37       | 41.64                   | 54.00          | -12.36      | AVG      | 258                 | 123                  |
| Antenna Polarity & Test Distance: Vertical at 3 m   |                 |                |             |                         |                |             |          |                     |                      |
| No.   | Frequency (MHz) | Reading (dBuV) | Factor (dB) | Emission Level (dBuV/m) | Limit (dBuV/m) | Margin (dB) | Detector | Antenna Height (cm) | Table Angle (Degree) |
| 1 #   | 2441.000        | 86.85          | 0.69        | 87.54                   |                |             | peak     | 178                 | 198                  |
| 2 #   | 2441.000        | 66.87          | 0.69        | 67.56                   |                |             | AVG      | 178                 | 198                  |
| 3   | 4882.000        | 45.67          | 7.61        | 53.28                   | 74.00          | -20.72      | peak     | 298                 | 184                  |
| 4   | 4882.000        | 34.49          | 7.61        | 42.10                   | 54.00          | -11.90      | AVG      | 298                 | 184                  |
| 5   | 7323.000        | 42.52          | 10.92       | 53.44                   | 74.00          | -20.56      | peak     | 163                 | 68                   |
| 6   | 7323.000        | 31.73          | 10.92       | 42.65                   | 54.00          | -11.35      | AVG      | 163                 | 68                   |
| 7   | 9764.000        | 39.31          | 15.37       | 54.68                   | 74.00          | -19.32      | peak     | 226                 | 123                  |
| 8   | 9764.000        | 26.99          | 15.37       | 42.36                   | 54.00          | -11.64      | AVG      | 226                 | 123                  |

Remarks:

- Emission Level = Read Level + Factor (Antenna Factor + Cable Loss - Preamp Factor)  
Margin value = Emission level – Limit value
- #2441MHz: Fundamental frequency.
- The amplitude of spurious emissions attenuated more than 20 dB below the permissible value is not required to be report.



|                 |              |                   |                            |
|-----------------|--------------|-------------------|----------------------------|
| Frequency Range | 1GHz ~ 25GHz | Detector Function | Peak (PK)<br>Average (AVG) |
| Test Channel    | Channel 78   |                   |                            |

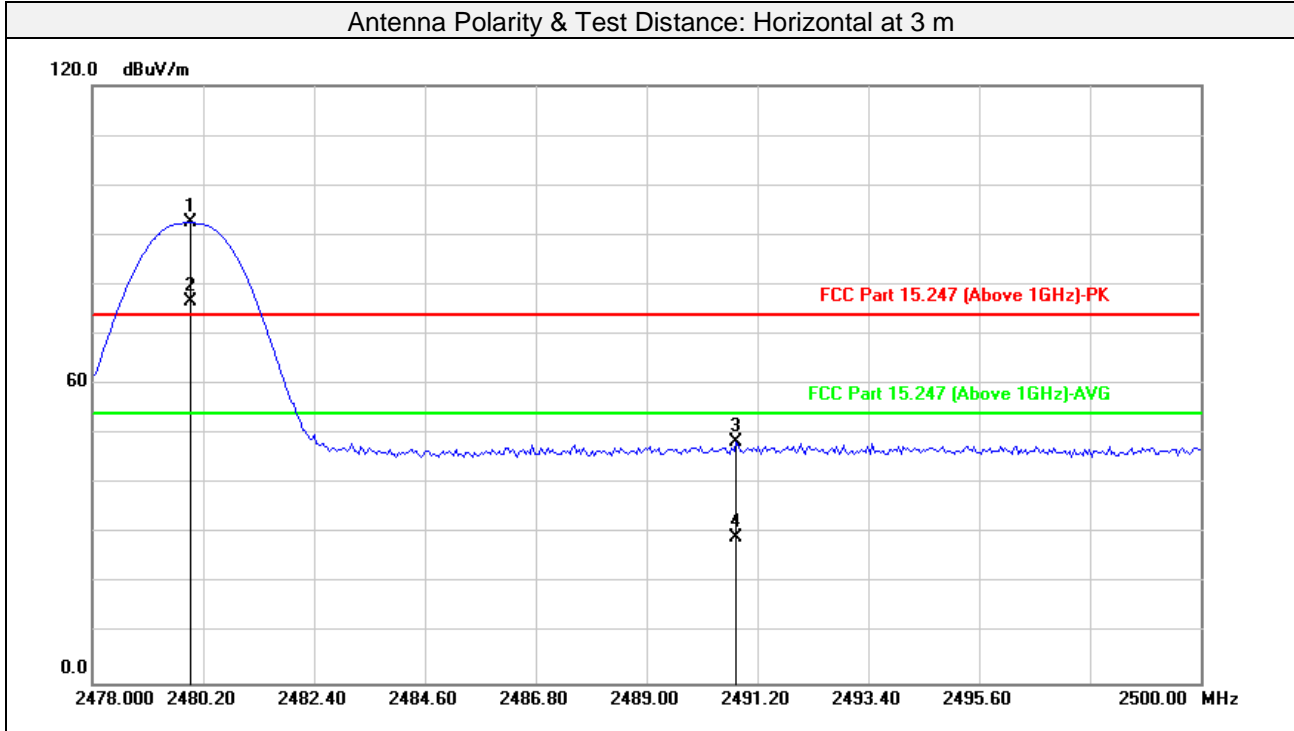

| No. | Frequency (MHz) | Reading (dBuV) | Factor (dB) | Emission Level (dBuV/m) | Limit (dBuV/m) | Margin (dB) | Detector | Antenna Height (cm) | Table Angle (Degree) |
|-----|-----------------|----------------|-------------|-------------------------|----------------|-------------|----------|---------------------|----------------------|
| 1#  | 2479.940        | 92.25          | 0.20        | 92.45                   |                |             | peak     | 288                 | 138                  |
| 2#  | 2479.940        | 76.34          | 0.20        | 76.54                   |                |             | AVG      | 288                 | 138                  |
| 3   | 2490.786        | 48.26          | 0.18        | 48.44                   | 74.00          | -25.56      | peak     | 288                 | 138                  |
| 4   | 2490.786        | 28.94          | 0.18        | 29.12                   | 54.00          | -24.88      | AVG      | 288                 | 138                  |
| 5   | 4960.000        | 44.39          | 7.94        | 52.33                   | 74.00          | -21.67      | peak     | 150                 | 233                  |
| 6   | 4960.000        | 40.42          | 7.94        | 48.36                   | 54.00          | -5.64       | AVG      | 150                 | 233                  |
| 7   | 7440.000        | 45.14          | 11.09       | 56.23                   | 74.00          | -17.77      | peak     | 100                 | 201                  |
| 8   | 7440.000        | 35.53          | 11.09       | 46.62                   | 54.00          | -7.38       | AVG      | 100                 | 201                  |
| 9   | 9920.000        | 39.79          | 15.95       | 55.74                   | 74.00          | -18.26      | peak     | 100                 | 169                  |
| 10  | 9920.000        | 29.15          | 15.95       | 45.10                   | 54.00          | -8.90       | AVG      | 100                 | 169                  |

Remarks:

- Emission Level = Read Level + Factor (Antenna Factor + Cable Loss - Preamp Factor)  
Margin value = Emission level – Limit value
- #2480MHz: Fundamental frequency.
- The amplitude of spurious emissions attenuated more than 20 dB below the permissible value is not required to be report.



|                 |              |                   |                            |
|-----------------|--------------|-------------------|----------------------------|
| Frequency Range | 1GHz ~ 25GHz | Detector Function | Peak (PK)<br>Average (AVG) |
| Test Channel    | Channel 78   |                   |                            |

Antenna Polarity & Test Distance: Vertical at 3 m

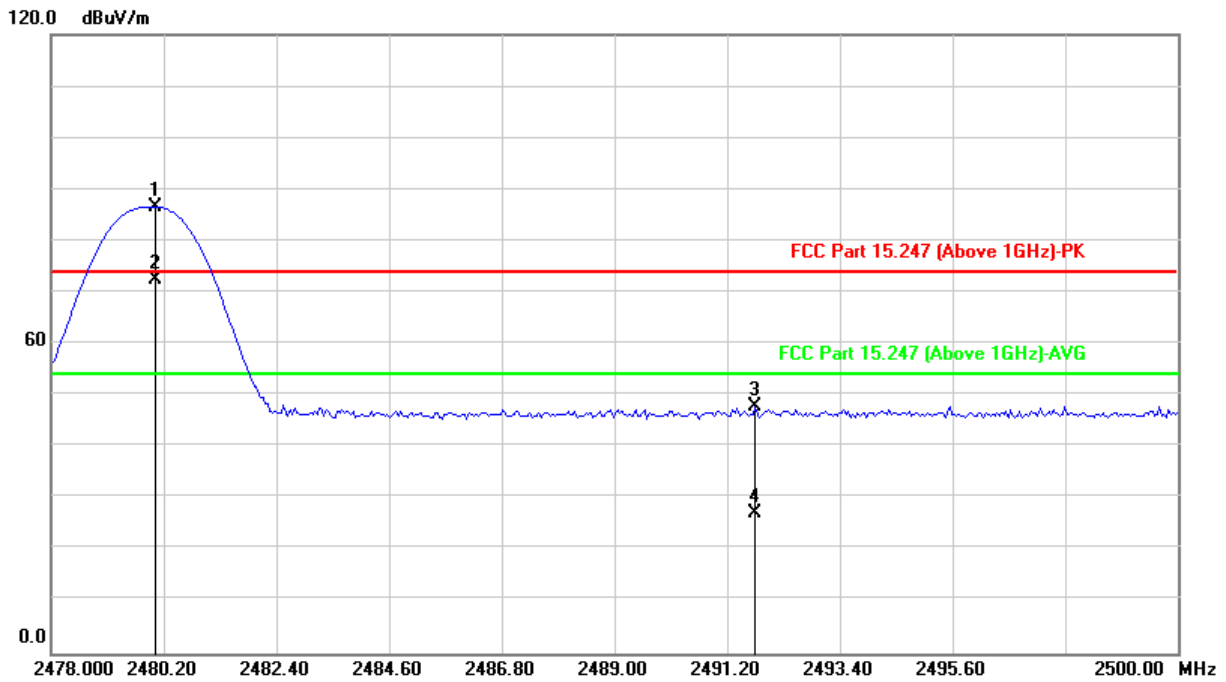

| No. | Frequency (MHz) | Reading (dBuV) | Factor (dB) | Emission Level (dBuV/m) | Limit (dBuV/m) | Margin (dB) | Detector | Antenna Height (cm) | Table Angle (Degree) |
|-----|-----------------|----------------|-------------|-------------------------|----------------|-------------|----------|---------------------|----------------------|
| 1#  | 2480.028        | 86.39          | 0.20        | 86.59                   | 74.00          | 12.59       | peak     | 100                 | 266                  |
| 2#  | 2480.028        | 72.15          | 0.20        | 72.35                   | 54.00          | 18.35       | AVG      | 100                 | 266                  |
| 3   | 2491.756        | 47.71          | 0.18        | 47.89                   | 74.00          | -26.11      | peak     | 100                 | 266                  |
| 4   | 2491.756        | 27.10          | 0.18        | 27.28                   | 54.00          | -26.72      | AVG      | 100                 | 266                  |
| 5   | 4960.000        | 47.39          | 7.94        | 55.33                   | 74.00          | -18.67      | peak     | 100                 | 198                  |
| 6   | 4960.000        | 37.16          | 7.94        | 45.10                   | 54.00          | -8.90       | AVG      | 100                 | 198                  |
| 7   | 7440.000        | 47.56          | 11.09       | 58.65                   | 74.00          | -15.35      | peak     | 355                 | 11                   |
| 8   | 7440.000        | 37.32          | 11.09       | 48.41                   | 54.00          | -5.59       | AVG      | 355                 | 11                   |
| 9   | 9920.000        | 40.32          | 15.95       | 56.27                   | 74.00          | -17.73      | peak     | 360                 | 189                  |
| 10  | 9920.000        | 30.04          | 15.95       | 45.99                   | 54.00          | -8.01       | AVG      | 360                 | 189                  |

Remarks:

- Emission Level = Read Level + Factor (Antenna Factor + Cable Loss - Preamp Factor)  
Margin value = Emission level – Limit value
- #2480MHz: Fundamental frequency.
- The amplitude of spurious emissions attenuated more than 20 dB below the permissible value is not required to be report.



8DPSK

|                 |              |                   |                            |
|-----------------|--------------|-------------------|----------------------------|
| Frequency Range | 1GHz ~ 25GHz | Detector Function | Peak (PK)<br>Average (AVG) |
| Test Channel    | Channel 0    |                   |                            |

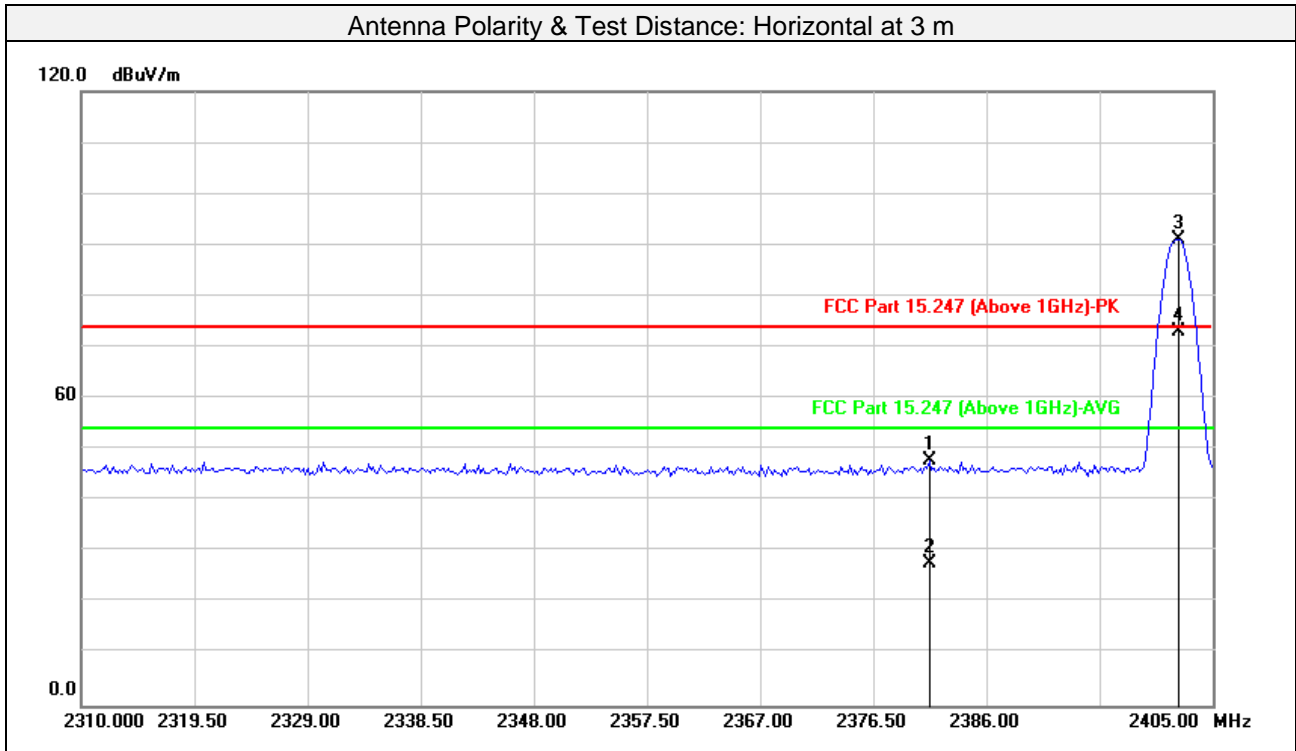

| No. | Frequency (MHz) | Reading (dBuV) | Factor (dB) | Emission Level (dBuV/m) | Limit (dBuV/m) | Margin (dB) | Detector | Antenna Height (cm) | Table Angle (Degree) |
|-----|-----------------|----------------|-------------|-------------------------|----------------|-------------|----------|---------------------|----------------------|
| 1   | 2381.202        | 47.41          | 0.35        | 47.76                   | 74.00          | -26.24      | peak     | 320                 | 113                  |
| 2   | 2381.202        | 27.36          | 0.35        | 27.71                   | 54.00          | -26.29      | AVG      | 320                 | 113                  |
| 3#  | 2402.144        | 90.75          | 0.31        | 91.06                   |                |             | peak     | 320                 | 113                  |
| 4#  | 2402.144        | 72.68          | 0.31        | 72.99                   |                |             | AVG      | 320                 | 113                  |
| 5   | 4804.000        | 48.60          | 7.27        | 55.87                   | 74.00          | -18.13      | peak     | 180                 | 250                  |
| 6   | 4804.000        | 34.29          | 7.27        | 41.56                   | 54.00          | -12.44      | AVG      | 180                 | 250                  |
| 7   | 7206.000        | 42.70          | 10.75       | 53.45                   | 74.00          | -20.55      | peak     | 147                 | 130                  |
| 8   | 7206.000        | 32.46          | 10.75       | 43.21                   | 54.00          | -10.79      | AVG      | 147                 | 130                  |
| 9   | 9608.000        | 41.79          | 14.78       | 56.57                   | 74.00          | -17.43      | peak     | 123                 | 228                  |
| 10  | 9608.000        | 28.78          | 14.78       | 43.56                   | 54.00          | -10.44      | AVG      | 123                 | 228                  |

Remarks:

- Emission Level = Read Level + Factor (Antenna Factor + Cable Loss - Preamp Factor)  
Margin value = Emission level – Limit value
- #2402MHz: Fundamental frequency.
- The amplitude of spurious emissions attenuated more than 20 dB below the permissible value is not required to be report.





|                 |              |                   |                            |
|-----------------|--------------|-------------------|----------------------------|
| Frequency Range | 1GHz ~ 25GHz | Detector Function | Peak (PK)<br>Average (AVG) |
| Test Channel    | Channel 0    |                   |                            |

Antenna Polarity & Test Distance: Vertical at 3 m

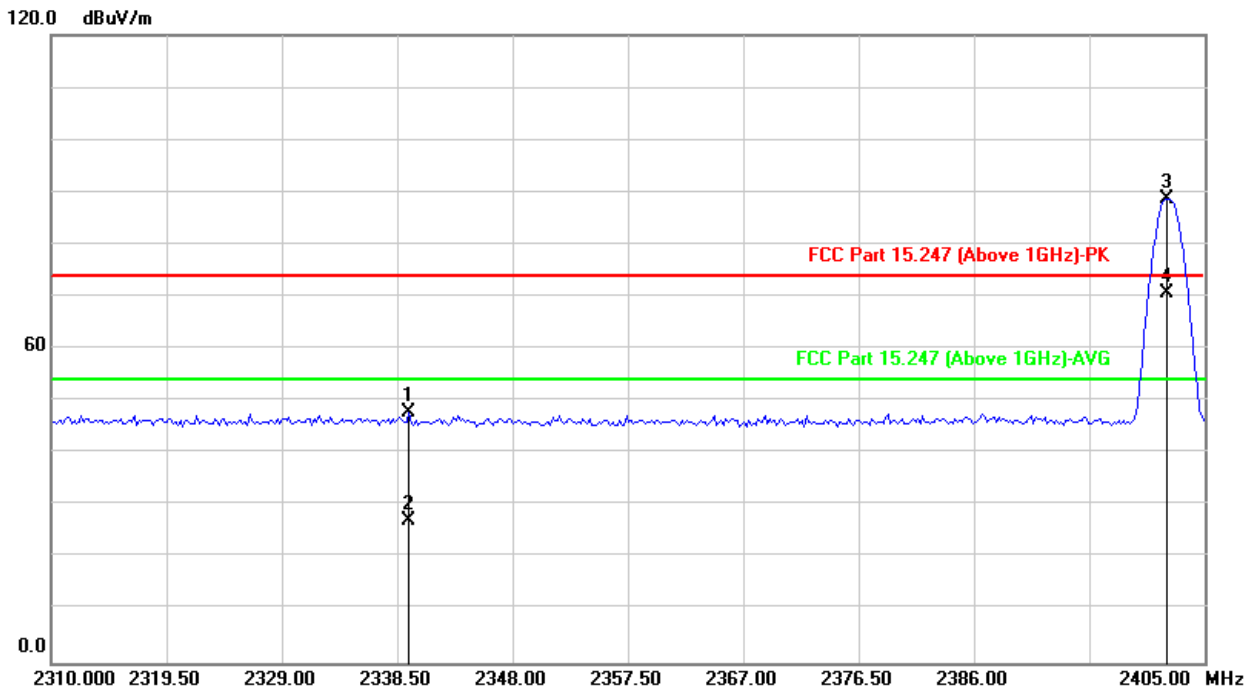

| No. | Frequency (MHz) | Reading (dBuV) | Factor (dB) | Emission Level (dBuV/m) | Limit (dBuV/m) | Margin (dB) | Detector | Antenna Height (cm) | Table Angle (Degree) |
|-----|-----------------|----------------|-------------|-------------------------|----------------|-------------|----------|---------------------|----------------------|
| 1   | 2339.509        | 47.32          | 0.40        | 47.72                   | 74.00          | -26.28      | peak     | 341                 | 168                  |
| 2   | 2339.509        | 26.85          | 0.40        | 27.25                   | 54.00          | -26.75      | AVG      | 341                 | 168                  |
| 3#  | 2401.954        | 88.30          | 0.32        | 88.62                   |                |             | peak     | 341                 | 168                  |
| 4#  | 2401.954        | 70.46          | 0.32        | 70.78                   |                |             | AVG      | 341                 | 168                  |
| 5   | 4804.000        | 49.18          | 7.27        | 56.45                   | 74.00          | -17.55      | peak     | 200                 | 200                  |
| 6   | 4804.000        | 35.29          | 7.27        | 42.56                   | 54.00          | -11.44      | AVG      | 200                 | 200                  |
| 7   | 7206.000        | 43.40          | 10.75       | 54.15                   | 74.00          | -19.85      | peak     | 213                 | 150                  |
| 8   | 7206.000        | 32.79          | 10.75       | 43.54                   | 54.00          | -10.46      | AVG      | 213                 | 150                  |
| 9   | 9608.000        | 41.09          | 14.78       | 55.87                   | 74.00          | -18.13      | peak     | 256                 | 360                  |
| 10  | 9608.000        | 29.37          | 14.78       | 44.15                   | 54.00          | -9.85       | AVG      | 256                 | 360                  |

Remarks:

- Emission Level = Read Level + Factor (Antenna Factor + Cable Loss - Preamp Factor)  
Margin value = Emission level – Limit value
- #2402MHz: Fundamental frequency.
- The amplitude of spurious emissions attenuated more than 20 dB below the permissible value is not required to be report.



|                 |              |                   |                            |
|-----------------|--------------|-------------------|----------------------------|
| Frequency Range | 1GHz ~ 25GHz | Detector Function | Peak (PK)<br>Average (AVG) |
| Test Channel    | Channel 39   |                   |                            |

Antenna Polarity & Test Distance: Horizontal at 3 m

| No. | Frequency (MHz) | Reading (dBuV) | Factor (dB) | Emission Level (dBuV/m) | Limit (dBuV/m) | Margin (dB) | Detector | Antenna Height (cm) | Table Angle (Degree) |
|-----|-----------------|----------------|-------------|-------------------------|----------------|-------------|----------|---------------------|----------------------|
| 1 # | 2441.000        | 87.98          | 0.69        | 88.67                   |                |             | peak     | 160                 | 300                  |
| 2 # | 2441.000        | 69.18          | 0.69        | 69.87                   |                |             | AVG      | 160                 | 300                  |
| 3   | 4882.000        | 45.84          | 7.61        | 53.45                   | 74.00          | -20.55      | peak     | 144                 | 150                  |
| 4   | 4882.000        | 35.36          | 7.61        | 42.97                   | 54.00          | -11.03      | AVG      | 144                 | 150                  |
| 5   | 7323.000        | 42.54          | 10.92       | 53.46                   | 74.00          | -20.54      | peak     | 230                 | 265                  |
| 6   | 7323.000        | 30.64          | 10.92       | 41.56                   | 54.00          | -12.44      | AVG      | 230                 | 265                  |
| 7   | 9764.000        | 41.50          | 15.37       | 56.87                   | 74.00          | -17.13      | peak     | 156                 | 178                  |
| 8   | 9764.000        | 27.21          | 15.37       | 42.58                   | 54.00          | -11.42      | AVG      | 156                 | 178                  |

Antenna Polarity & Test Distance: Vertical at 3 m

| No. | Frequency (MHz) | Reading (dBuV) | Factor (dB) | Emission Level (dBuV/m) | Limit (dBuV/m) | Margin (dB) | Detector | Antenna Height (cm) | Table Angle (Degree) |
|-----|-----------------|----------------|-------------|-------------------------|----------------|-------------|----------|---------------------|----------------------|
| 1 # | 2441.000        | 85.76          | 0.69        | 86.45                   |                |             | peak     | 178                 | 298                  |
| 2 # | 2441.000        | 67.80          | 0.69        | 68.49                   |                |             | AVG      | 178                 | 298                  |
| 3   | 4882.000        | 47.73          | 7.61        | 55.34                   | 74.00          | -18.66      | peak     | 265                 | 210                  |
| 4   | 4882.000        | 34.55          | 7.61        | 42.16                   | 54.00          | -11.84      | AVG      | 265                 | 210                  |
| 5   | 7323.000        | 42.56          | 10.92       | 53.48                   | 74.00          | -20.52      | peak     | 136                 | 150                  |
| 6   | 7323.000        | 31.23          | 10.92       | 42.15                   | 54.00          | -11.85      | AVG      | 136                 | 150                  |
| 7   | 9764.000        | 39.75          | 15.37       | 55.12                   | 74.00          | -18.88      | peak     | 100                 | 250                  |
| 8   | 9764.000        | 26.98          | 15.37       | 42.35                   | 54.00          | -11.65      | AVG      | 100                 | 250                  |

Remarks:

- Emission Level = Read Level + Factor (Antenna Factor + Cable Loss - Preamp Factor)  
Margin value = Emission level – Limit value
- #2441MHz: Fundamental frequency.
- The amplitude of spurious emissions attenuated more than 20 dB below the permissible value is not required to be report.



|                 |              |                   |                            |
|-----------------|--------------|-------------------|----------------------------|
| Frequency Range | 1GHz ~ 25GHz | Detector Function | Peak (PK)<br>Average (AVG) |
| Test Channel    | Channel 78   |                   |                            |

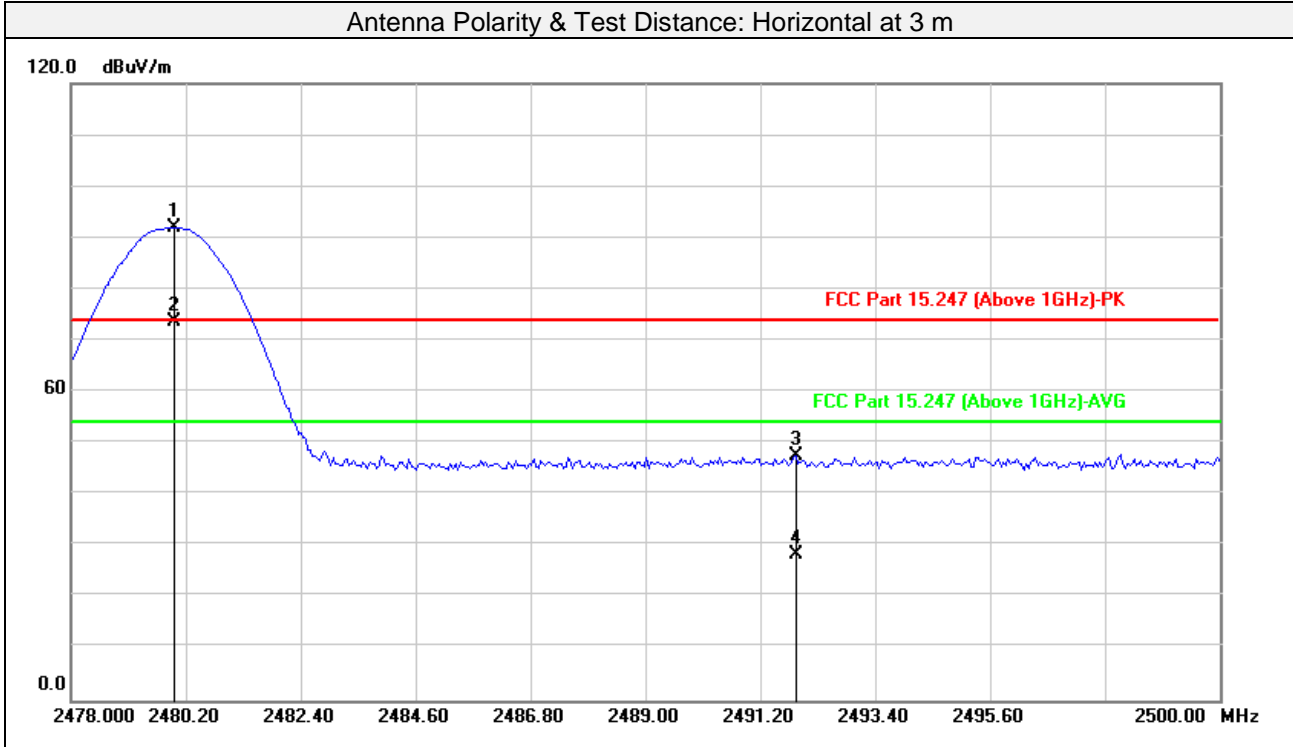

| No. | Frequency (MHz) | Reading (dBuV) | Factor (dB) | Emission Level (dBuV/m) | Limit (dBuV/m) | Margin (dB) | Detector | Antenna Height (cm) | Table Angle (Degree) |
|-----|-----------------|----------------|-------------|-------------------------|----------------|-------------|----------|---------------------|----------------------|
| 1#  | 2479.984        | 91.72          | 0.20        | 91.92                   |                |             | peak     | 318                 | 138                  |
| 2#  | 2479.984        | 73.33          | 0.20        | 73.53                   |                |             | AVG      | 318                 | 138                  |
| 3   | 2491.888        | 47.38          | 0.18        | 47.56                   | 74.00          | -26.44      | peak     | 318                 | 138                  |
| 4   | 2491.888        | 28.19          | 0.18        | 28.37                   | 54.00          | -25.63      | AVG      | 318                 | 138                  |
| 5   | 4960.000        | 46.75          | 7.94        | 54.69                   | 74.00          | -19.31      | peak     | 164                 | 180                  |
| 6   | 4960.000        | 34.62          | 7.94        | 42.56                   | 54.00          | -11.44      | AVG      | 164                 | 180                  |
| 7   | 7440.000        | 43.49          | 11.09       | 54.58                   | 74.00          | -19.42      | peak     | 200                 | 178                  |
| 8   | 7440.000        | 31.47          | 11.09       | 42.56                   | 54.00          | -11.44      | AVG      | 200                 | 178                  |
| 9   | 9920.000        | 38.83          | 15.95       | 54.78                   | 74.00          | -19.22      | peak     | 130                 | 145                  |
| 10  | 9920.000        | 28.94          | 15.95       | 44.89                   | 54.00          | -9.11       | AVG      | 130                 | 145                  |

Remarks:

- Emission Level = Read Level + Factor (Antenna Factor + Cable Loss - Preamp Factor)  
Margin value = Emission level – Limit value
- #2480MHz: Fundamental frequency.
- The amplitude of spurious emissions attenuated more than 20 dB below the permissible value is not required to be report.



|                 |              |                   |                            |
|-----------------|--------------|-------------------|----------------------------|
| Frequency Range | 1GHz ~ 25GHz | Detector Function | Peak (PK)<br>Average (AVG) |
| Test Channel    | Channel 78   |                   |                            |

Antenna Polarity & Test Distance: Vertical at 3 m

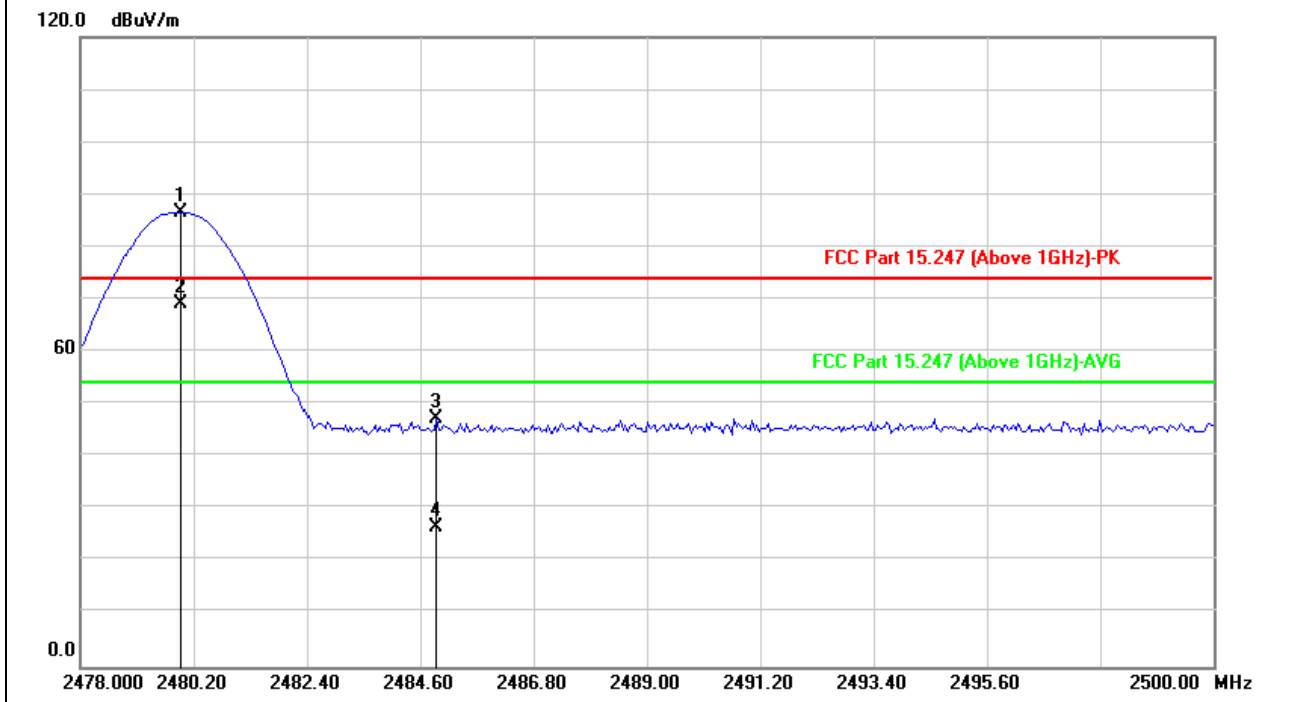

| No. | Frequency (MHz) | Reading (dBuV) | Factor (dB) | Emission Level (dBuV/m) | Limit (dBuV/m) | Margin (dB) | Detector | Antenna Height (cm) | Table Angle (Degree) |
|-----|-----------------|----------------|-------------|-------------------------|----------------|-------------|----------|---------------------|----------------------|
| 1#  | 2479.940        | 86.33          | 0.20        | 86.53                   |                |             | peak     | 100                 | 268                  |
| 2#  | 2479.940        | 69.07          | 0.20        | 69.27                   |                |             | AVG      | 100                 | 268                  |
| 3   | 2484.922        | 46.98          | 0.19        | 47.17                   | 74.00          | -26.83      | peak     | 100                 | 268                  |
| 4   | 2484.922        | 26.26          | 0.19        | 26.45                   | 54.00          | -27.55      | AVG      | 100                 | 268                  |
| 5   | 4960.000        | 47.33          | 7.94        | 55.27                   | 74.00          | -18.73      | peak     | 120                 | 230                  |
| 6   | 4960.000        | 35.21          | 7.94        | 43.15                   | 54.00          | -10.85      | AVG      | 120                 | 230                  |
| 7   | 7440.000        | 45.78          | 11.09       | 56.87                   | 74.00          | -17.13      | peak     | 148                 | 267                  |
| 8   | 7440.000        | 32.15          | 11.09       | 43.24                   | 54.00          | -10.76      | AVG      | 148                 | 267                  |
| 9   | 9920.000        | 42.69          | 15.95       | 58.64                   | 74.00          | -15.36      | peak     | 145                 | 231                  |
| 10  | 9920.000        | 29.30          | 15.95       | 45.25                   | 54.00          | -8.75       | AVG      | 145                 | 231                  |

Remarks:

- Emission Level = Read Level + Factor (Antenna Factor + Cable Loss - Preamp Factor)  
Margin value = Emission level – Limit value
- #2480MHz: Fundamental frequency.
- The amplitude of spurious emissions attenuated more than 20 dB below the permissible value is not required to be report.



### 3.2 Number of Hopping Frequency Used

#### 3.2.1 Limits of Hopping Frequency Used Measurement

At least 15 channels frequencies, and should be equally spaced.

#### 3.2.2 Test Setup

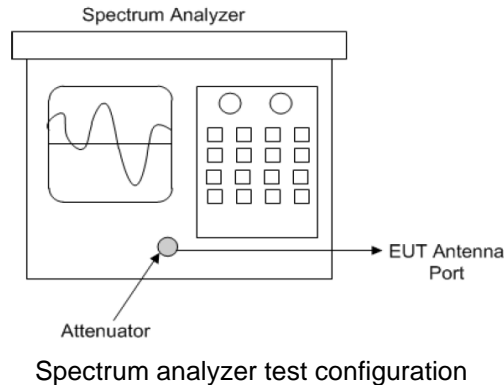

#### 3.2.3 Test Instruments

Refer to section 5 to get information of above instrument.

#### 3.2.4 Test Procedure

- Check the calibration of the measuring instrument (SA) using either an internal calibrator or a known signal from an external generator.
- Turn on the EUT and connect its antenna terminal to measurement via a low loss cable. Then set it to any one measured frequency within its operating range and make sure the instrument is operated in its linear range.
- Set the SA on MaxHold Mode, and then keep the EUT in hopping mode. Record all the signals from each channel until each one has been recorded.
- Set the SA on View mode and then plot the result on SA screen.
- Repeat above procedures until all frequencies measured were complete.

#### 3.2.5 Deviation from Test Standard

No deviation.



3.2.6 Test Results

There are 79 hopping frequencies in the hopping mode. Please refer to next page for the test result. On the plots, it shows that the hopping frequencies are equally spaced.

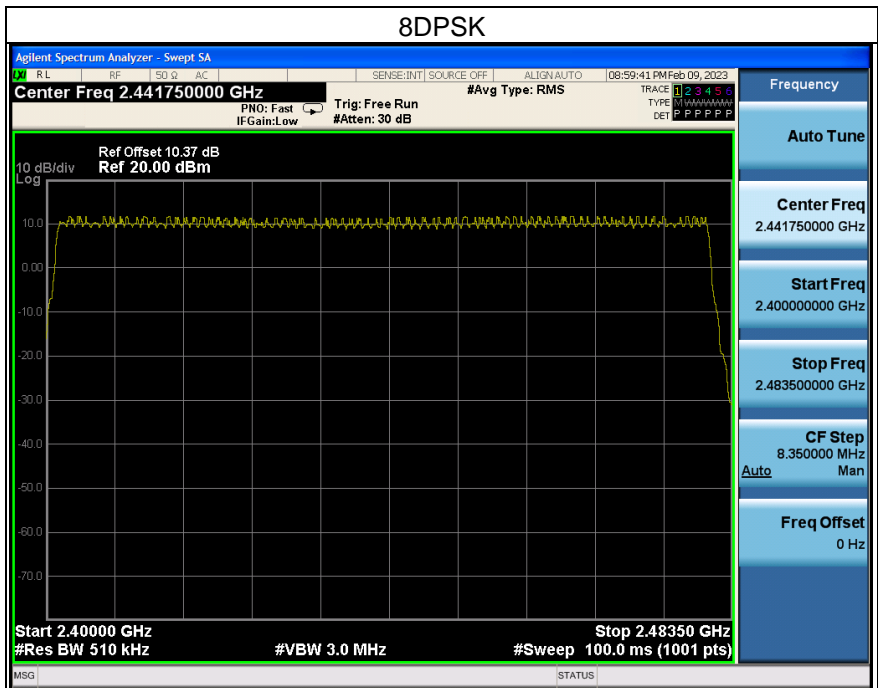
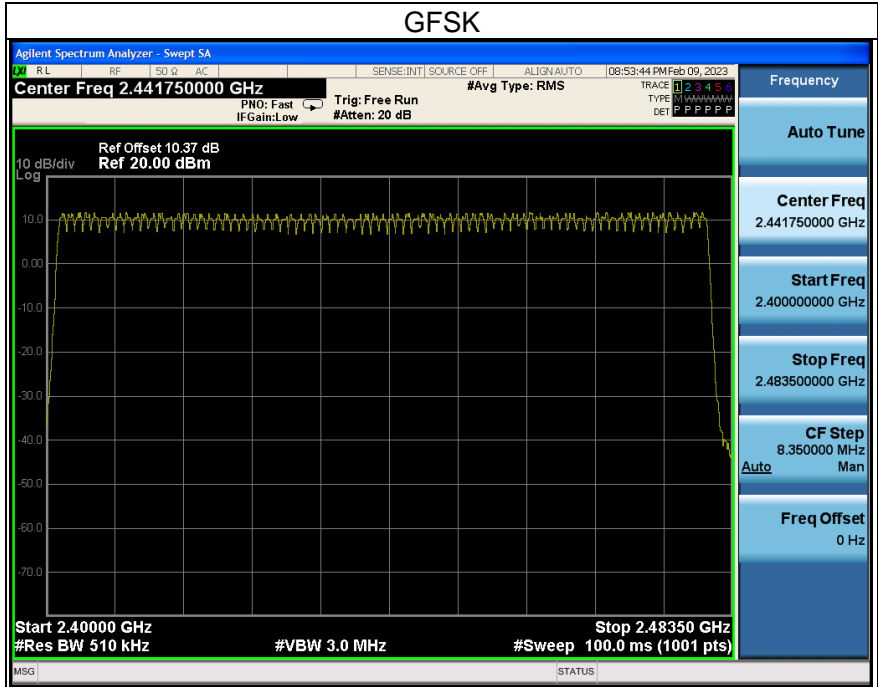



### 3.3 Dwell Time on Each Channel

#### 3.3.1 Limits of Dwell Time on Each Channel Measurement

The average time of occupancy on any channel shall not be greater than 0.4 seconds within a period of 0.4 seconds multiplied by the number of hopping channels employed.

#### 3.3.2 Test Setup

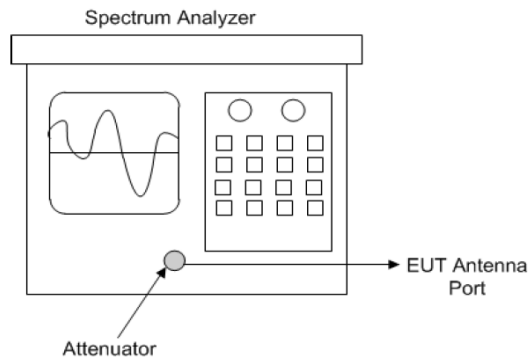

Spectrum analyzer test configuration

#### 3.3.3 Test Instruments

Refer to section 5 to get information of above instrument.

#### 3.3.4 Test Procedures

- Check the calibration of the measuring instrument (SA) using either an internal calibrator or a known signal from an external generator.
- Turn on the EUT and connect its antenna terminal to measurement via a low loss cable. Then set it to any one measured frequency within its operating range and make sure the instrument is operated in its linear range.
- Adjust the center frequency of SA on any frequency be measured and set SA to zero span mode. And then, set RBW and VBW of spectrum analyzer to proper value.
- Measure the time duration of one transmission on the measured frequency. And then plot the result with time difference of this time duration.
- Repeat above procedures until all different time-slot modes have been completed.

#### 3.3.5 Deviation from Test Standard

No deviation.



3.3.6 Test Results

GFSK

| Mode | Number of Hopping Channel | Number of transmission in a period (channel number*0.4 sec) |                  |                  |                   | Length of transmission time (msec) | Result (msec) | Limit (msec) | Verdict |
|------|---------------------------|---|------------------|------------------|-------------------|------------------------------------|---------------|--------------|---------|
|      |                           | Period (sec)  | Sweep time (sec) | times in a sweep | times in a period |                                    |               |              |         |
| DH1  | 79                        | 31.6  | 3.16             | 34               | 340               | 0.372                              | 126.480       | 400          | Pass    |
| DH3  | 79                        | 31.6  | 3.16             | 16               | 160               | 1.621                              | 259.360       | 400          | Pass    |
| DH5  | 79                        | 31.6  | 3.16             | 11               | 110               | 2.868                              | 315.480       | 400          | Pass    |

Note: Test plots of the transmitting time slot are shown as below.

8DPSK

| Mode | Number of Hopping Channel | Number of transmission in a period (channel number*0.4 sec) |                  |                  |                   | Length of transmission time (msec) | Result (msec) | Limit (msec) | Verdict |
|------|---------------------------|---|------------------|------------------|-------------------|------------------------------------|---------------|--------------|---------|
|      |                           | Period (sec)  | Sweep time (sec) | times in a sweep | times in a period |                                    |               |              |         |
| 3DH1 | 79                        | 31.6  | 3.16             | 33               | 330               | 0.380                              | 125.400       | 400          | Pass    |
| 3DH3 | 79                        | 31.6  | 3.16             | 16               | 160               | 1.630                              | 260.800       | 400          | Pass    |
| 3DH5 | 79                        | 31.6  | 3.16             | 11               | 110               | 2.882                              | 317.020       | 400          | Pass    |

Note: Test plots of the transmitting time slot are shown as below.



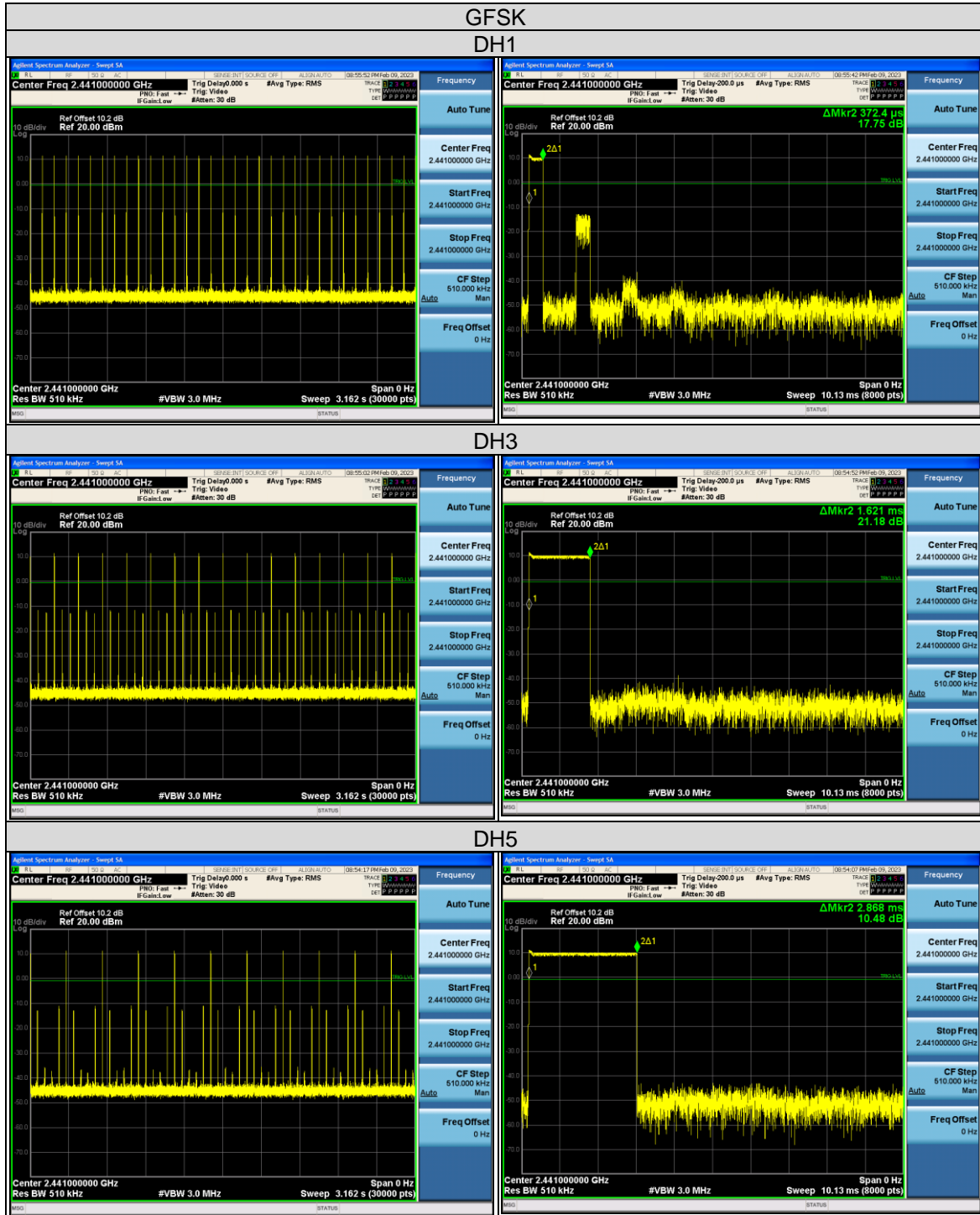

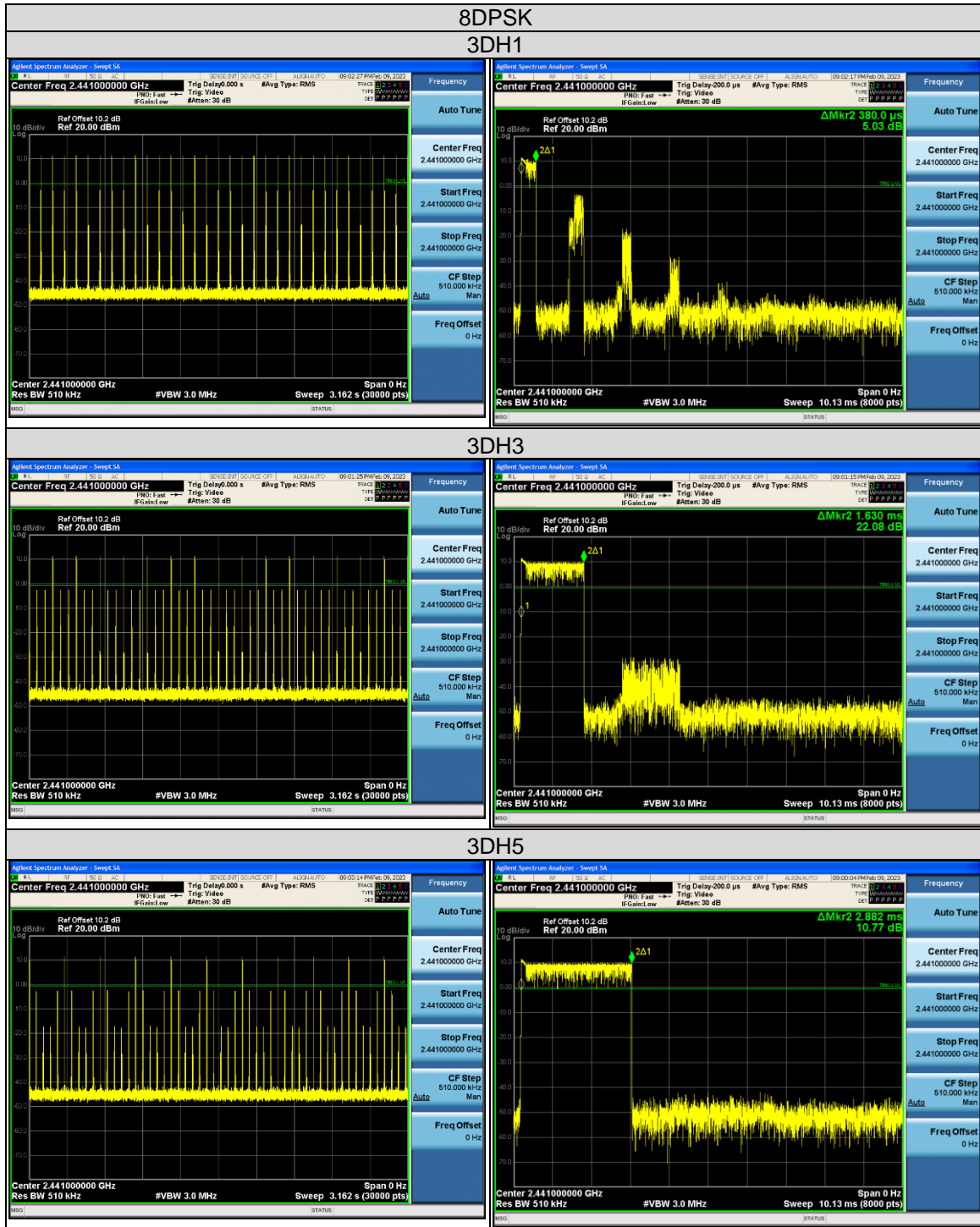

Lab: [Hwa-Hsing \(Dongguan\) Testing Co., Ltd.](#)  
 Address: [No.101, Bld N1, Yuyuan 2Rd, Yuyuan Industrial Park, HuangJiang Town, Dongguan, China](#)

Tel: [0769-83078199](tel:0769-83078199)  
 Web.: [www.hwa-hsing.com](http://www.hwa-hsing.com)  
 E-Mail: [customerservice.dg@hwa-hsing.com](mailto:customerservice.dg@hwa-hsing.com)

Release  
[Ver. 1.5](#)



### 3.4 Channel Bandwidth

#### 3.4.1 Limits of Channel Bandwidth Measurement

For frequency hopping system operating in the 2400-2483.5 MHz, if the 20 dB bandwidth of hopping channel is greater than 25 kHz, two-thirds 20 dB bandwidth of hopping channel shall be a minimum limit for the hopping channel separation.

#### 3.4.2 Test Setup

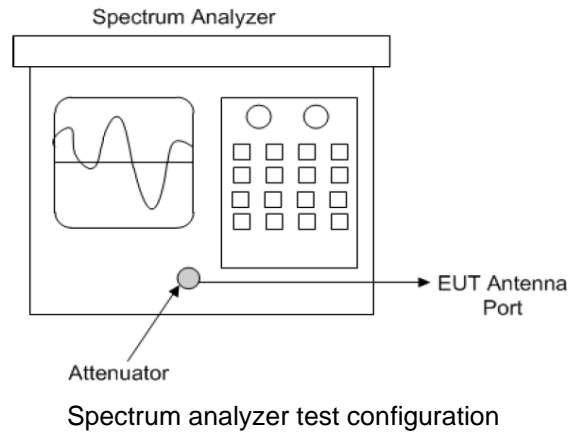

#### 3.4.3 Test Instruments

Refer to section 5 to get information of above instrument.

#### 3.4.4 Test Procedure

- Check the calibration of the measuring instrument using either an internal calibrator or a known signal from an external generator.
- Turn on the EUT and connect it to measurement instrument. Then set it to any one convenient frequency within its operating range. Set a reference level on the instrument equal to the highest peak value.
- Measure the frequency difference of two frequencies that were attenuated 20 dB from the reference level. Record the frequency difference as the emission bandwidth.
- Repeat above procedures until all frequencies measured were complete.

#### 3.4.5 Deviation from Test Standard

No deviation.

#### 3.4.6 EUT Operating Condition

The software provided by client enabled the EUT to transmit and receive data at lowest, middle and highest channel frequencies individually.



3.4.7 Test Results

| Channel | Frequency (MHz) | 20dB Bandwidth (MHz) |       |
|---------|-----------------|----------------------|-------|
|         |                 | GFSK                 | 8DPSK |
| 0       | 2402            | 1.047                | 1.359 |
| 39      | 2441            | 1.038                | 1.299 |
| 78      | 2480            | 1.029                | 1.314 |





### 3.5 Occupied Bandwidth Measurement

#### 3.5.1 Test Setup

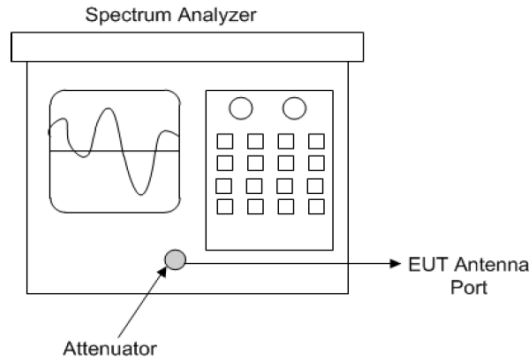

Spectrum analyzer test configuration

#### 3.5.2 Test Instruments

Refer to section 5 to get information of above instrument

#### 3.5.3 Test Procedure

The transmitter output was connected to the spectrum analyzer through an attenuator. The bandwidth of the fundamental frequency was measured by spectrum analyzer with resolution bandwidth in the range of 1% to 5% of the anticipated emission bandwidth, and a video bandwidth at least 3x the resolution bandwidth and set the detector to PEAK. The width of a frequency band such that, below the lower and above the upper frequency limits, the mean powers emitted are each equal to a specified percentage 0.5% of the total mean power of a given emission.

#### 3.5.4 Deviation from Test Standard

No deviation.

#### 3.5.5 EUT Operating Conditions

The software provided by client to enable the EUT under transmission condition continuously at lowest, middle and highest channel frequencies individually.



3.5.6 Test Results

| Channel | Frequency (MHz) | Occupied Bandwidth (MHz) |        |
|---------|-----------------|--------------------------|--------|
|         |                 | GFSK                     | 8DPSK  |
| 0       | 2402            | 0.9340                   | 1.3561 |
| 39      | 2441            | 0.9287                   | 1.3376 |
| 78      | 2480            | 0.9402                   | 1.3761 |







### 3.6 Hopping Channel Separation

#### 3.6.1 Limits of Hopping Channel Separation Measurement

At least 25 kHz or two-third of 20 dB hopping channel bandwidth (whichever is greater).

#### 3.6.2 Test Setup

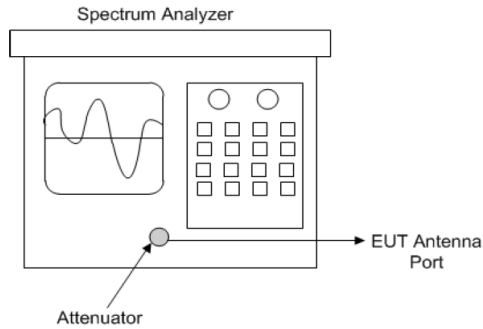

#### 3.6.3 Test Instruments

Refer to section 5 to get information of above instrument.

#### 3.6.4 Test Procedure

- Check the calibration of the measuring instrument using either an internal calibrator or a known signal from an external generator.
- Turn on the EUT and connect it to measurement instrument. Then set it to any one convenient frequency within its operating range.
- By using the MaxHold function record the separation of two adjacent channels.
- Measure the frequency difference of these two adjacent channels by SA MARK function. And then plot the result on SA screen.
- Repeat above procedures until all frequencies measured were complete.

#### 3.6.5 Deviation from Test Standard

No deviation.



3.6.6 Test Results

| Channel No. | Frequency (MHz) | Adjacent Channel Separation (MHz) |       | Minimum Limit (MHz) |       | Pass / Fail |
|-------------|-----------------|-----------------------------------|-------|---------------------|-------|-------------|
|             |                 | GFSK                              | 8DPSK | GFSK                | 8DPSK |             |
| 0           | 2402            | 0.999                             | 0.999 | 0.698               | 0.906 | Pass        |
| 39          | 2441            | 0.999                             | 0.993 | 0.692               | 0.866 | Pass        |
| 78          | 2480            | 0.990                             | 1.002 | 0.686               | 0.876 | Pass        |

**Note:** The minimum limit is two-third 20 dB bandwidth.

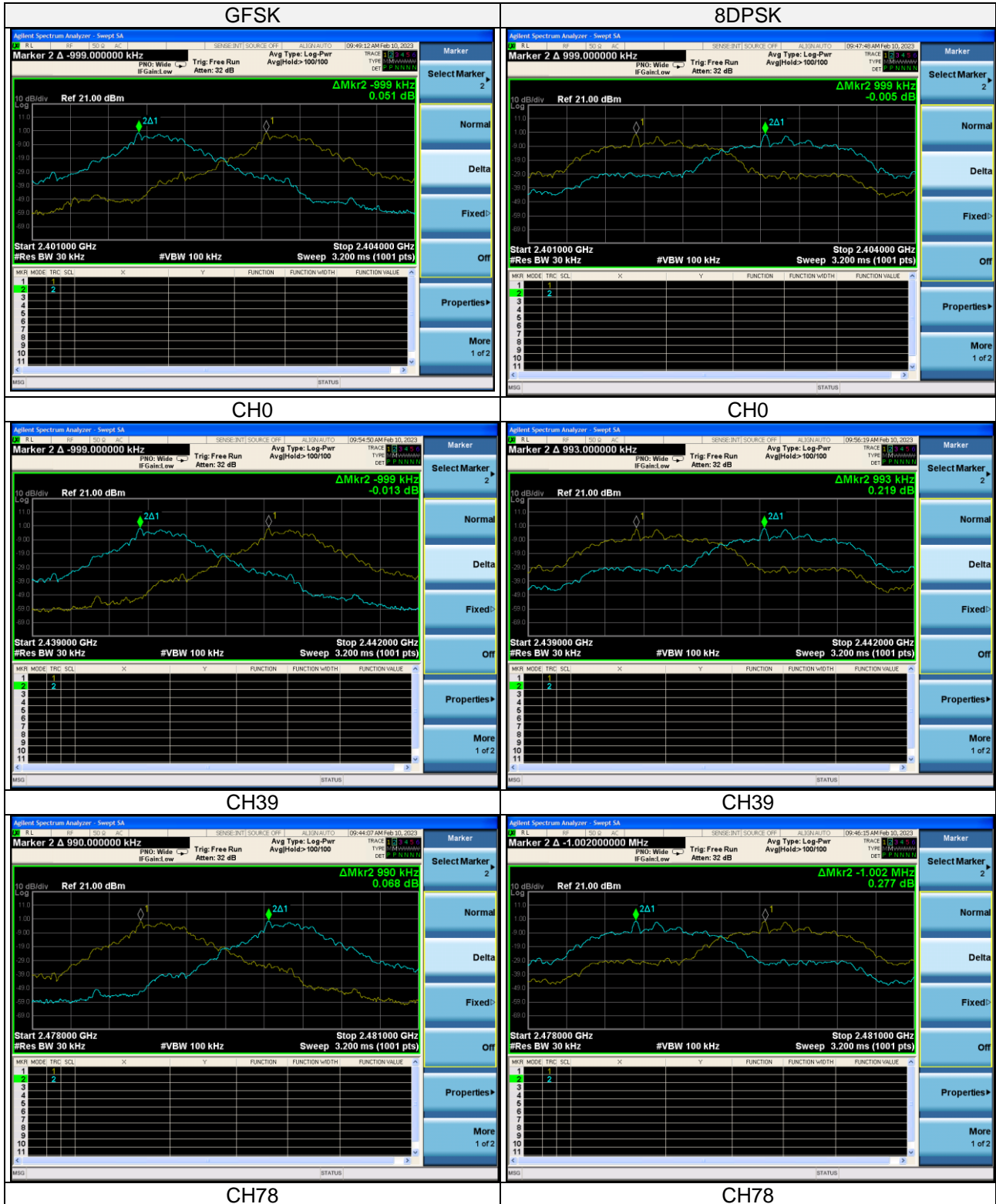



### 3.7 Maximum Output Power

#### 3.7.1 Limits of Maximum Output Power Measurement

The Maximum Output Power Measurement is 125mW.

#### 3.7.2 Test Setup

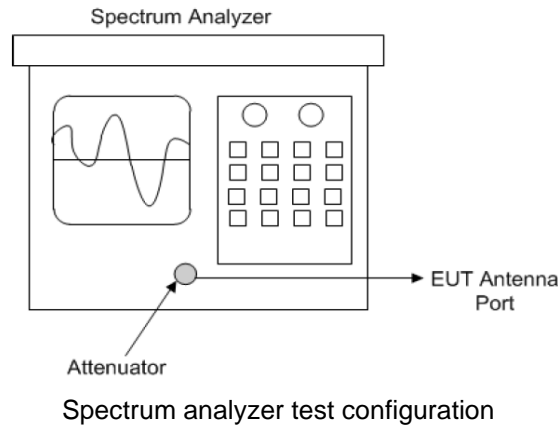

#### 3.7.3 Test Instruments

Refer to section 5 to get information of above instrument.

#### 3.7.4 Test Procedure

Measurement using a spectrum analyzer (SA), Selection of test method:

Maximum peak conducted output power

The following procedure shall be used when an instrument with a resolution bandwidth that is greater than the DTS bandwidth is available to perform the measurement:

- Set the RBW > DTS bandwidth.
- Set VBW > [3 x RBW]
- Set span > [3 x RBW]
- Sweep time = auto couple.
- Detector = peak
- Trace mode = max hold.
- Allow trace to fully stabilize.
- Use peak marker function to determine the peak amplitude level.



Maximum conducted (average) output power

- a) Check the calibration of the measuring instrument using either an internal calibrator or a known signal from an external generator.
- b) Turn on the EUT and connect it to measurement instrument. Then set it to any one convenient frequency within its operating range. Set a reference level on the measuring instrument equal to the highest peak value.
- c) SA Setting:
  - 1)\* Set span to at least 1.5 times the OBW
  - 2)\* Set sweep trigger to "free run."
  - 3)\* Set RBW= 1% to 5% of the OBW. not to exceed 1MHz.
  - 4)\* Set VBW  $\geq 3 \times$  RBW
  - 5)\* Number of points in sweep  $\geq 2 \times$  span /RBW. (This gives bin-to-bin spacing  $\leq$  RBW / 2. so that narrowband signals are not lost between frequency bins).
  - 6)\* Sweep time  $\leq$  (number of points in sweep) x T. where T is defined in 11.6. If this gives a sweep time less than the auto sweep time of the instrument. then method AVGSA-3 shall not be used (use AVGSA-3A). The purpose of this step is so that the averaging time in each bin is less than or equal to the minimum time of a transmission.
  - 7)\* Detector =RMS (power averaging).
  - 8)\* Trace mode =Max hold.
  - 9)\* Allow max hold to run for at least 60 s or longer as needed to allow the trace to stabilize.
  - 10)\* Compute power by integrating the spectrum across the OBW of the signal using the instrument's band power measurement function with band limits set equal to the OBW band edges. If the instrument does not have a band power function. then sum the spectrum levels (in power units) at intervals equal to the RBW extending across the entire OBW.
- d. Measure the captured power within the band and recording the plot.
- e. Repeat above procedures until all frequencies required were complete.

### 3.7.5 Deviation from Test Standard

No deviation.

### 3.7.6 EUT Operating Condition

The software provided by client enabled the EUT to transmit and receive data at lowest, middle and highest channel frequencies individually.



3.7.7 Test Results

**Peak power**

| Channel No. | Freq. (MHz) | Output Power (dBm) |       | Output Power (mW) |       | Power Limit (mW) | Pass / Fail |
|-------------|-------------|--------------------|-------|-------------------|-------|------------------|-------------|
|             |             | GFSK               | 8DPSK | GFSK              | 8DPSK |                  |             |
| 0           | 2402        | 7.984              | 9.094 | 6.286             | 8.117 | 125              | Pass        |
| 39          | 2441        | 7.026              | 8.199 | 5.042             | 6.605 | 125              | Pass        |
| 78          | 2480        | 7.046              | 8.198 | 5.065             | 6.604 | 125              | Pass        |

**Average power**

| Channel No. | Freq. (MHz) | Output Power (dBm) |       | Output Power (mW) |       | Power Limit (mW) | Pass / Fail |
|-------------|-------------|--------------------|-------|-------------------|-------|------------------|-------------|
|             |             | GFSK               | 8DPSK | GFSK              | 8DPSK |                  |             |
| 0           | 2402        | 4.600              | 3.010 | 2.884             | 2.000 | 125              | Pass        |
| 39          | 2441        | 3.640              | 2.150 | 2.312             | 1.641 | 125              | Pass        |
| 78          | 2480        | 3.530              | 2.130 | 2.254             | 1.633 | 125              | Pass        |



### Peak Power Spectrum Plot

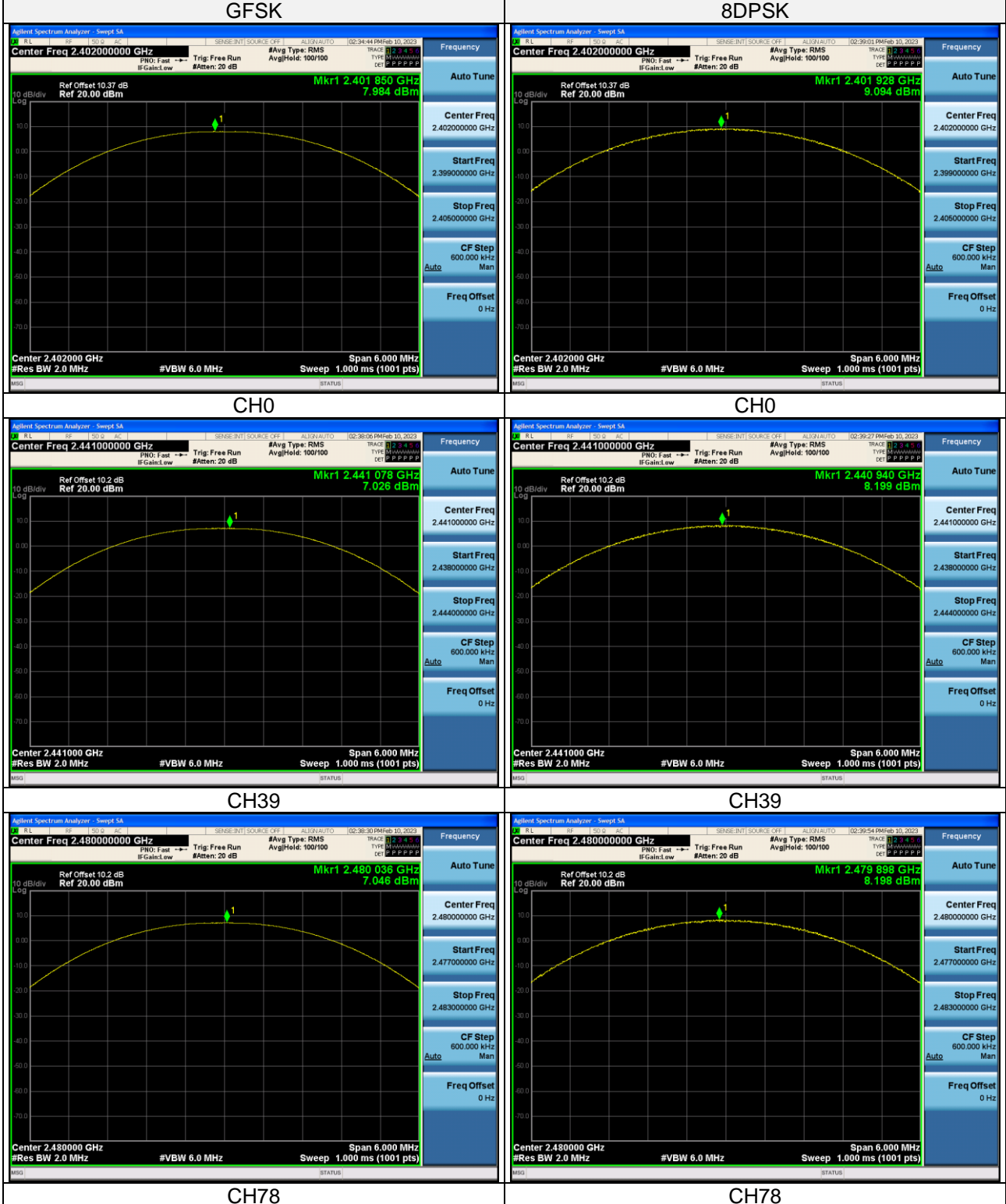

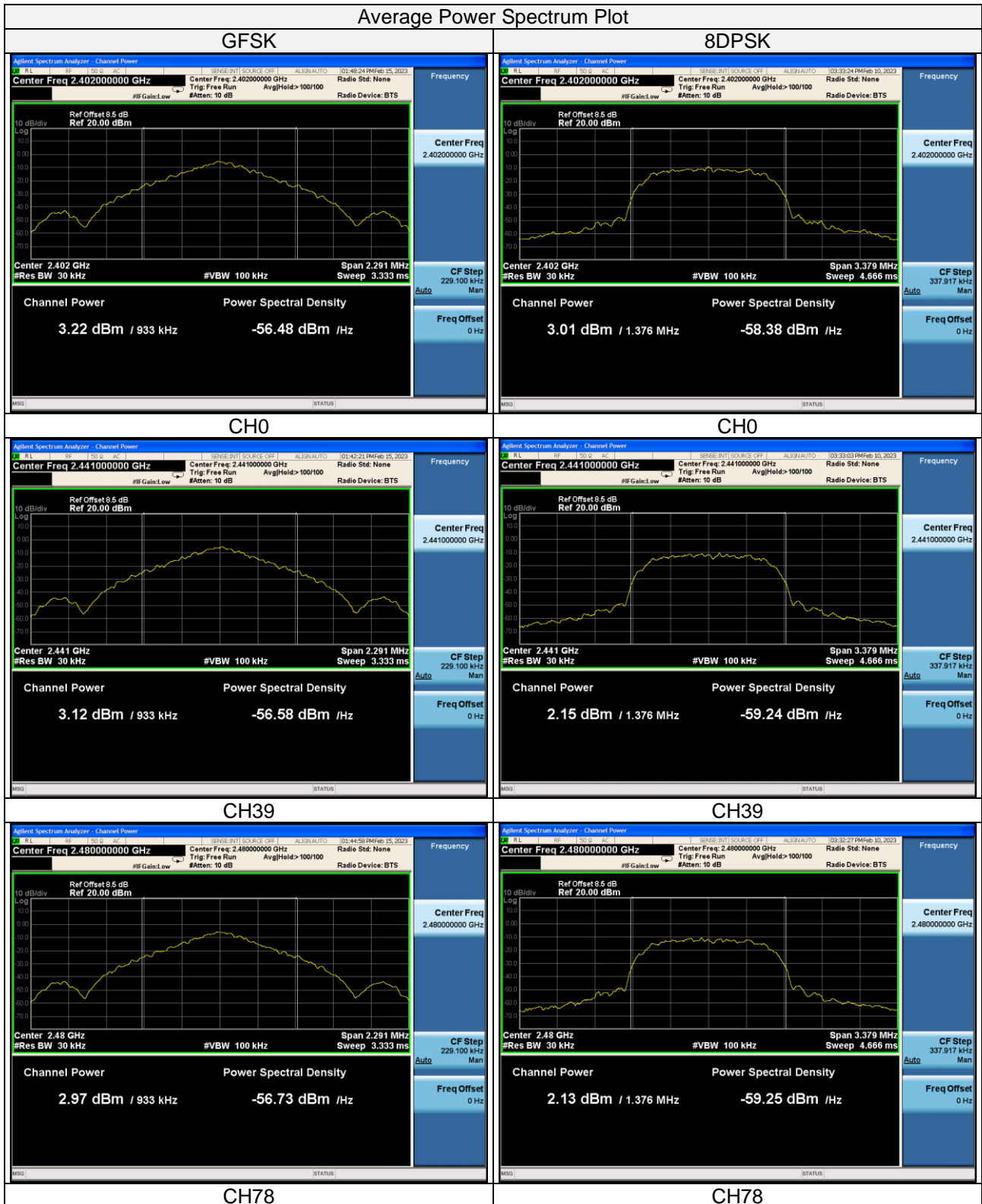





### 3.8 Conducted Out of Band Emission Measurement

#### 3.8.1 Limits of Conducted Out of Band Emission Measurement

- a. **If the maximum peak conducted output power procedure was used to determine compliance as described in 11.9.1**, then the peak output power measured in any 100 kHz bandwidth outside of the authorized frequency band shall be attenuated by at least 20 dB relative to the maximum in-band peak PSD level in 100 kHz (i.e., 20 dBc).
- b. **If maximum conducted (average) output power was used to determine compliance as described in 11.9.2**, then the peak power in any 100 kHz bandwidth outside of the authorized frequency band shall be attenuated by at least 30 dB relative to the maximum in-band peak PSD level in 100 kHz (i.e., 30 dBc)

#### 3.8.2 Tets Setup

- DTS emissions in non-restricted frequency bands Subclause 11.11 of ANSI C63.10 is applicable.
- DTS emissions in restricted frequency bands Subclause 11.12 of ANSI C63.10 is applicable

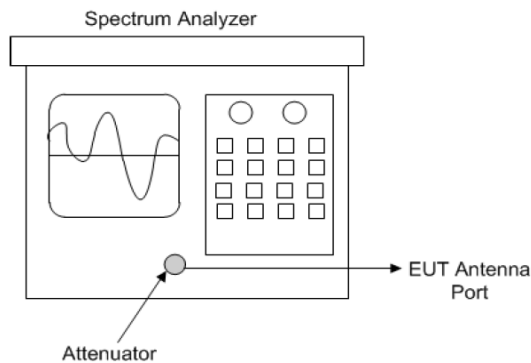

Spectrum analyzer test configuration

#### 3.8.3 Test Instruments

Refer to section 5 to get information of above instrument.



### 3.8.4 Test Procedure

- a. Establish a reference level by using the following procedure:
- 1) Set instrument center frequency to DTS channel center frequency.
  - 2) Set the span to 21.5 times the DTS bandwidth)
  - 3) Set the RBW= 100 kHz)
  - 4) Set the VBW  $\geq 3 \times$  RBW
  - 5) Detector = peak
  - 6) Sweep time = auto coupling
  - 7) Trace mode =max hold
  - 8) Allow trace to fully stabilize
  - 9) Use the peak marker function to determine the maximum PSD level.

Note that the channel found to contain the maximum PSD level can be used to establish the reference level.

- b. Establish an emission level by using the following procedure:
- 1) Set the center frequency and span to encompass frequency range to be measured.
  - 2) Set the RBW = 100 kHz
  - 3) Set the VBW  $\geq 300$  kHz.
  - 4) Detector = peak.
  - 5) Sweep time = auto couple.
  - 6) Trace mode = max hold.
  - 7) Allow trace to fully stabilize.
  - 8) Use the peak marker function to determine the maximum power level in any 100 kHz band segment within the fundamental EBW.

### 3.8.5 Deviation from Test Standard

No deviation.

### 3.8.6 EUT Operating Condition

The software provided by client enabled the EUT to transmit and receive data at lowest, middle and highest channel frequencies individually.