

DC POWER CEILING FAN WALL CONTROL MANUAL

ACTIVATING THE LEARNING PROCESS

1. Open the remote battery cover and install one 12VDC battery to remote. After the receiver installation is complete, AC power is turned on within 30 seconds, press and hold the remote **LEARN** button for 3 seconds. The receiver will make sound, Bi, once. This will indicate the receiver has learned the ID that was previously selected on the transmitter. Then the wall transmitter can control the receiver.
2. If user cannot finish the setting within the 30 seconds time frame, the main power must be turned off and re-started again. This will reset the unit. Repeat step 1 until the LEARNING feature is activated as indicated.

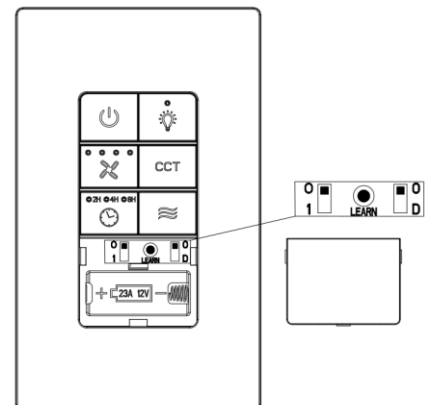



DIP SWITCH – 0 & 1

- 0: All handsets and receivers are factory pre-set to the same channel. You can operate the fan without doing a channel setting above but we recommend that you set an individual channel for your fan.
- 1: This is to allow for each handset and receiver to be set on an individual channel.

DIP SWITCH – O & D (LIGHT FUNCTION SELECT SWITCH)

- O: Light – on / off only
- D: Light – on / off and dimming

WALL TRANSMITTER OPERATION

-  : Press this button to turn the fan on or off.
-  : Press button to set fan speed.
-  : ON/OFF—Press this button and release instantly to turn on or off the light.
- DIMMER**—Press and hold to dim or brighten lights to the desired level and release. (*Only when the dip switch was set on “D” dimmer setting*)

CCT : Press for color-temperature change setting.

 : Press for setting up that the ceiling fan will turn off after 2, 4 or 8 hours automatically.

 : Fan speed will modulate to simulate a natural breeze.

TRANSMITTER

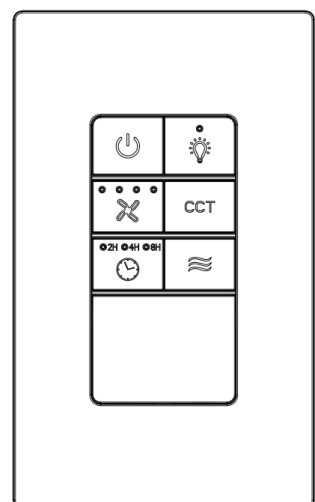

Installing Wall Control (TRANSMITTER):

Remove wall plate. Secure wall control unit with 2 screws previously removed. Face plate could be locked onto the transmitter.

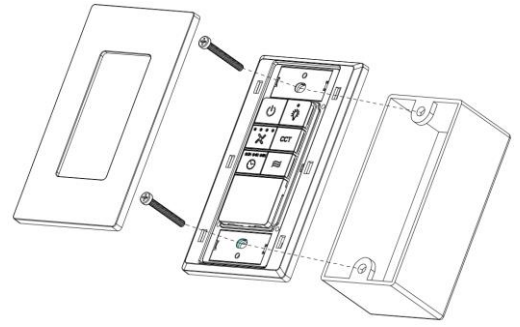

To assure continued FCC compliance:

FEDERAL COMMUNICATIONS COMMISSION INTERFERENCE STATEMENT

This equipment has been tested and found to comply with the limits for a Class B digital device, pursuant to part 15 of the FCC Rules. These limits are designed to provide reasonable protection against harmful interference in a residential installation. This equipment generates uses and can radiate radio frequency energy and, if not installed and used in accordance with the instructions, may cause harmful interference to radio communications. However, there is no guarantee that interference will not occur in a particular installation. If this equipment does cause harmful interference to radio or television reception, which can be determined by turning the equipment off and on, the user is encouraged to try to correct the interference by one or more of the following measures:

- Reorient or relocate the receiving antenna.
- Increase the separation between the equipment and receiver.
- Connect the equipment into an outlet on a circuit different from that to which the receiver is connected.
- Consult the dealer or an experienced radio/TV technician for help.

CAUTION:

To assure continued FCC compliance:

Any changes or modifications not expressly approved by the grantee of this device could void the user's authority to operate the equipment.

FCC ID : 2AQZU-18042

This device complies with Part 15 of the FCC Rules. Operation is subject to the following two conditions: (1) This device may not cause harmful interference, and (2) this device must accept any interference received, including interference that may cause undesired operation.

NOTE 1: This equipment has been tested and found to comply with the limits for a Class B digital device, pursuant to part 15 of the FCC Rules. These limits are designed to provide reasonable protection against harmful interference in a residential installation. This equipment generates uses and can radiate radio frequency energy and, if not installed and used in accordance with the instructions, may cause harmful interference to radio communications. However, there is no guarantee that interference will not occur in a particular installation. If this equipment does cause harmful interference to radio or television reception, which can be determined by turning the equipment off and on, the user is encouraged to try to correct the interference by one or more of the following measures:

- Reorient or relocate the receiving antenna.
- Increase the separation between the equipment and receiver.
- Connect the equipment into an outlet on a circuit different from that to which the receiver is connected.
- Consult the dealer or an experienced radio/TV technician for help.

NOTE 2: Any changes or modifications to this unit not expressly approved by the party responsible for compliance could void the user's authority to operate the equipment.

IC WARNING

This device contains licence-exempt transmitter(s) that comply with Innovation, Science and Economic Development Canada's licence-exempt RSS(s). Operation is subject to the following two conditions:

- (1) This device may not cause interference.
- (2) This device must accept any interference, including interference that may cause undesired operation of the device.

L'émetteur/récepteur exempt de licence contenu dans le présent appareil est conforme aux CNR d'Innovation, Sciences et Développement économique Canada applicables aux appareils radio exempts de licence. L'exploitation est autorisée aux deux conditions suivantes:

1. L'appareil ne doit pas produire de brouillage;
2. L'appareil doit accepter tout brouillage radioélectrique subi, même si le brouillage est susceptible d'en compromettre le fonctionnement.