

DC POWER CEILING FAN REMOTE CONTROL MANUAL

LEARNING PROCESS

NOTE: The Hand Held Remote Control System is equipped with a learning frequency function which has code combinations to prevent potential interference from other remote units.

Step: 1. Install the DC1.5V/AAA 2pcs batteries. Within 30 seconds of turning the Receivers AC power ON. Press the transmitter's "LEARN" button.

Step: 2. Hold the "LEARN" button for over 5 seconds, once the receiver has detected the frequency, the receiver will make sound, Bi Bi, twice. This will indicate the receiver has learned the frequency that was previously selected on the transmitter.

NOTE: After the AC power is on, do not press any other button on the transmitter before pressing the "LEARN" button, Because doing so will cause the procedure to fail.

After completing the steps above, you should be able to operate the ceiling fan and light. If the fan is not responding to the transmitter, please turn the power off to the receiver. And repeat step 1 and 2.

NOTE: Remove the batteries if not used for long periods of time to prevent damage to the hand held remote.

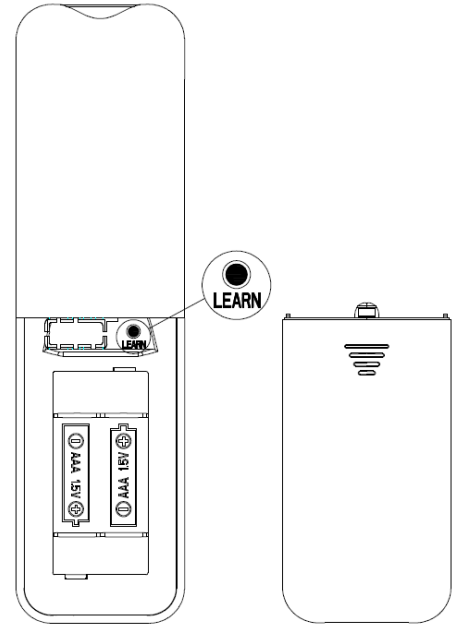

FUNCTIONS OF TRANSMITTER

1. FAN SPEED:

- 1 : Turn on ceiling fan at 1st speed (lowest speed)
- 2 : Turn on ceiling fan at 2nd speed
- 3 : Turn on ceiling fan at 3rd speed
- 4 : Turn on ceiling fan at 4th speed
- 5 : Turn on ceiling fan at 5th speed
- 6 : Turn on ceiling fan at 6th speed (high speed)

 : Turn off ceiling fan.

 Press for forward/reverse airflow of ceiling fan.

 : Natural breeze: Fan speed will modulate to simulate a natural breeze.

FAN TIMER:

1hr: Setting up that the ceiling fan will turn off after 1 hours automatically.

3hr: Setting up that the ceiling fan will turn off after 3 hours automatically.

6hr: Setting up that the ceiling fan will turn off after 6 hours automatically.

2. LIGHT:

 ON/OFF—Press and release instantly to turn on or off the light.

 Press and hold to brighten light to the desired level and release.

 Press and hold to dim light to the desired level and release.

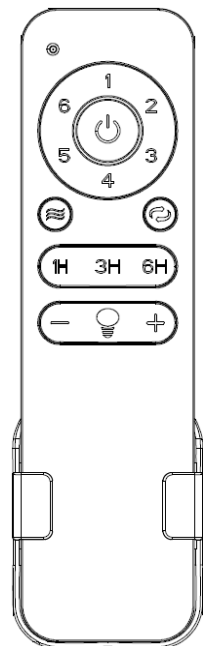

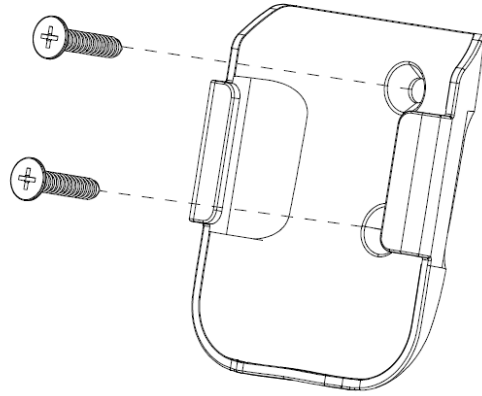

Installation of Transmitter Wall Mount Holder with Two screws.

To assure continued FCC compliance:

FEDERAL COMMUNICATIONS COMMISSION INTERFERENCE STATEMENT

This equipment has been tested and found to comply with the limits for a Class B digital device, pursuant to Part 15 of the FCC Rules. These limits are designed to provide reasonable protection against harmful interference in a residential installation. This equipment generates, uses and can radiate radio frequency energy and, if not installed and used in accordance with the instructions, may cause harmful interference to radio communications. However, there is no guarantee that interference will not occur in a particular installation. If this equipment does cause harmful interference to radio or television reception, which can be determined by turning the equipment off and on, the user is encouraged to try to correct the interference by one or more of the following measures:

--Reorient or relocate the receiving antenna. --Increase the separation between the equipment and receiver. --Connect the equipment into an outlet on a circuit different from that to which the receiver is connected. --Consult the dealer or an experienced radio/TV technician for help.

CAUTION:

To assure continued FCC compliance:

Any changes or modifications not expressly approved by the grantee of this device could void the user's authority to operate the equipment.

FCC ID: 2AQZU-18026

This device complies with Part 15 of the FCC Rules. Operation is subject to the following two conditions: (1) This device may not cause harmful interference, and (2) this device must accept any interference received, including interference that may cause undesired operation.