

# FCC RADIO TEST REPORT

## FCC ID: 2AQZL-ELT10101H

**Product:** MID

**Trade Mark:** HighQ

**Model No.:** ELT10101H

**Family Model:** M1002

**Report No.:** S19061103606003

**Issue Date:** 01 Jul. 2019

### Prepared for

EPIK Learning, LLC.

7801 Hayvenhurst Avenue, Van Nuys, California 91406 USA

### Prepared by

Shenzhen NTEK Testing Technology Co., Ltd.

1/F, Building E, Fenda Science Park, Sanwei Community,  
Xixiang Street Bao'an District, Shenzhen P.R. China

Tel.: +86-755-6115 6588

Fax.: +86-755-6115 6599

Website: <http://www.ntek.org.cn>

**TABLE OF CONTENTS**

<b>1</b>	<b>TEST RESULT CERTIFICATION .....</b>	<b>3</b>
<b>2</b>	<b>SUMMARY OF TEST RESULTS.....</b>	<b>4</b>
<b>3</b>	<b>FACILITIES AND ACCREDITATIONS .....</b>	<b>5</b>
3.1	FACILITIES .....	5
3.2	LABORATORY ACCREDITATIONS AND LISTINGS .....	5
2.3	MEASUREMENT UNCERTAINTY .....	5
<b>4</b>	<b>GENERAL DESCRIPTION OF EUT .....</b>	<b>6</b>
<b>5</b>	<b>DESCRIPTION OF TEST MODES .....</b>	<b>8</b>
<b>6</b>	<b>SETUP OF EQUIPMENT UNDER TEST .....</b>	<b>10</b>
6.1	BLOCK DIAGRAM CONFIGURATION OF TEST SYSTEM.....	10
6.2	SUPPORT EQUIPMENT.....	11
6.3	EQUIPMENTS LIST FOR ALL TEST ITEMS.....	12
<b>7</b>	<b>TEST REQUIREMENTS.....</b>	<b>14</b>
7.1	CONDUCTED EMISSIONS TEST .....	14
7.2	RADIATED SPURIOUS EMISSION .....	19
7.3	6DB BANDWIDTH.....	28
7.4	DUTY CYCLE.....	30
7.5	MAXIMUM OUTPUT POWER.....	32
7.6	POWER SPECTRAL DENSITY .....	34
7.7	CONDUCTED BAND EDGE MEASUREMENT.....	36
7.8	SPURIOUS RF CONDUCTED EMISSIONS.....	38
7.9	ANTENNA APPLICATION .....	39
<b>8.</b>	<b>TEST RESULTS.....</b>	<b>40</b>
8.1	DUTY CYCLE.....	40
8.2	MAXIMUM CONDUCTED OUTPUT POWER .....	47
8.3	OCCUPIED CHANNEL BANDWIDTH .....	48
8.4	MAXIMUM POWER SPECTRAL DENSITY LEVEL .....	55
8.5	BAND EDGE.....	62
8.6	CONDUCTED RF SPURIOUS EMISSION .....	71

**1 TEST RESULT CERTIFICATION**

Applicant's name .....	EPIK Learning, LLC.
Address .....	7801 Hayvenhurst Avenue, Van Nuys, California 91406 USA
Manufacturer's Name .....	EPIK Learning, LLC.
Address .....	7801 Hayvenhurst Avenue, Van Nuys, California 91406 USA
Product description	
Product name .....	MID
Model and/or type reference .....	ELT10101H
Family Model .....	M1002

Measurement Procedure Used:

APPLICABLE STANDARDS	
APPLICABLE STANDARD/ TEST PROCEDURE	TEST RESULT
FCC 47 CFR Part 2, Subpart J FCC 47 CFR Part 15, Subpart C KDB 174176 D01 Line Conducted FAQ v01r01 ANSI C63.10-2013 KDB 558074 D01 15.247 Meas Guidance v05r02	Complied

This device described above has been tested by Shenzhen NTEK Testing Technology Co., Ltd., and the test results show that the equipment under test (EUT) is in compliance with the FCC requirements. And it is applicable only to the tested sample identified in the report.

This report shall not be reproduced except in full, without the written approval of Shenzhen NTEK Testing Technology Co., Ltd., this document may be altered or revised by Shenzhen NTEK Testing Technology Co., Ltd., personnel only, and shall be noted in the revision of the document.

The test results of this report relate only to the tested sample identified in this report.

Date of Test : 13 Jun. 2019 ~ 27 Jun. 2019

Testing Engineer : Allen Liu  
(Allen Liu)

Technical Manager : Jason Chen  
(Jason Chen)

Authorized Signatory : Sam Chen  
(Sam Chen)

**2 SUMMARY OF TEST RESULTS**

<b>FCC Part15 (15.247), Subpart C</b>			
<b>Standard Section</b>	<b>Test Item</b>	<b>Verdict</b>	<b>Remark</b>
15.207	Conducted Emission	PASS	
15.247 (a)(2)	6dB Bandwidth	PASS	
15.247 (b)	Maximum Output Power	PASS	
15.209 (a) 15.205 (a)	Radiated Spurious Emission	PASS	
15.247 (e)	Power Spectral Density	PASS	
15.247 (d)	Band Edge Emission	PASS	
15.247 (d)	Spurious RF Conducted Emission	PASS	
15.203	Antenna Requirement	PASS	

Remark:

1. "N/A" denotes test is not applicable in this Test Report.
2. All test items were verified and recorded according to the standards and without any deviation during the test.

### 3 FACILITIES AND ACCREDITATIONS

#### 3.1 FACILITIES

All measurement facilities used to collect the measurement data are located at  
1/F, Building E, Fenda Science Park, Sanwei Community, Xixiang Street Bao'an District, Shenzhen  
518126 P.R. China

The sites are constructed in conformance with the requirements of ANSI C63.7, ANSI C63.10 and CISPR  
Publication 22.

#### 3.2 LABORATORY ACCREDITATIONS AND LISTINGS

Site Description

CNAS-Lab. : The Laboratory has been assessed and proved to be in compliance with  
CNAS-CL01:2006 (identical to ISO/IEC 17025:2005)  
The Certificate Registration Number is L5516.

IC-Registration The Certificate Registration Number is 9270A.  
CAB identifier:CN0074

FCC- Accredited Test Firm Registration Number: 463705.

Designation Number: CN1184

A2LA-Lab. The Certificate Registration Number is 4298.01  
This laboratory is accredited in accordance with the recognized  
International Standard ISO/IEC 17025:2005 General requirements for  
the competence of testing and calibration laboratories.

This accreditation demonstrates technical competence for a defined  
scope and the operation of a laboratory quality management system  
(refer to joint ISO-ILAC-IAF Communiqué dated 8 January 2009).

Name of Firm : Shenzhen NTEK Testing Technology Co., Ltd.

Site Location : 1/F, Building E, Fenda Science Park, Sanwei Community, Xixiang  
Street, Bao'an District, Shenzhen 518126 P.R. China.

#### 2.3 MEASUREMENT UNCERTAINTY

The reported uncertainty of measurement  $y \pm U$ , where expanded uncertainty  $U$  is based on a standard  
uncertainty multiplied by a coverage factor of  $k=2$ , providing a level of confidence of approximately 95 %.

No.	Item	Uncertainty
1	Conducted Emission Test	$\pm 1.38\text{dB}$
2	RF power, conducted	$\pm 0.16\text{dB}$
3	Spurious emissions, conducted	$\pm 0.21\text{dB}$
4	All emissions, radiated(<1G)	$\pm 4.68\text{dB}$
5	All emissions, radiated(>1G)	$\pm 4.89\text{dB}$
6	Temperature	$\pm 0.5^\circ\text{C}$
7	Humidity	$\pm 2\%$

#### 4 GENERAL DESCRIPTION OF EUT

Product Feature and Specification	
Equipment	MID
Trade Mark	HighQ
FCC ID	2AQZL-ELT10101H
Model No.	ELT10101H
Family Model	M1002
Model Difference	All models are the same circuit and RF module, except the model name.
Operating Frequency	2412-2462MHz for 802.11b/g/11n(HT20); 2422-2452MHz for 802.11n(HT40);
Modulation	DSSS with DBPSK/DQPSK/CCK for 802.11b; OFDM with BPSK/QPSK/16QAM/64QAM for 802.11g/n;
Number of Channels	11 channels for 802.11b/g/11n(HT20); 7 channels for 802.11n(HT40);
Antenna Type	FPCB Antenna
Antenna Gain	0.81dBi
Power supply	<input checked="" type="checkbox"/> DC supply: DC 3.7V/6000mAh from Battery or DC 5V from USB Port.
	<input checked="" type="checkbox"/> Adapter supply: Model:NA010050020 Input: 100-240V~50/60Hz 0.5A Output: 5V---2000mA
HW Version	M86HKR300
SW Version	google 8.1

Note: Based on the application, features, or specification exhibited in User's Manual, the EUT is considered as an ITE/Computing Device. More details of EUT technical specification, please refer to the User's Manual.



## 5 DESCRIPTION OF TEST MODES

To investigate the maximum EMI emission characteristics generates from EUT, the test system was pre-scanning tested base on the consideration of following EUT operation mode or test configuration mode which possible have effect on EMI emission level. Each of these EUT operation mode(s) or test configuration mode(s) mentioned above was evaluated respectively.

The Transmitter was operated in the normal operating mode. The TX frequency was fixed which was for the purpose of the measurements.

Test of channel included the lowest and middle and highest frequency to perform the test, then record on this report.

Those data rates (802.11b: 1 Mbps; 802.11g: 6 Mbps; 802.11n (HT20): MCS0; 802.11n (HT40): MCS0) were used for all test.

The EUT was pretested with 3 orientations placed on the table for the radiated emission measurement –X, Y, and Z-plane. The Y-plane results were found as the worst case and were shown in this report.

Frequency and Channel list for 802.11b/g/n (HT20/HT40):

Channel	Frequency(MHz)
1	2412
2	2417
...	...
5	2432
6	2437
...	...
10	2457
11	2462

Note:  $f_c=2412\text{MHz}+(k-1)\times 5\text{MHz}$   $k=1$  to 11

EUT built-in battery-powered, the battery is fully-charged.



Test Mode:

Test Items	Mode	Data Rate	Channel	Ant
AC Power Line Conducted Emissions	Normal Link	-	-	-
Maximum Conducted Output Power	11b/CCK	1 Mbps	1/6/11	1
	11g/BPSK	6 Mbps	1/6/11	1
	11n HT20	MCS0	1/6/11	1
	11n HT40	MCS0	3/6/9	1
Power Spectral Density	11b/CCK	1 Mbps	1/6/11	1
	11g/BPSK	6 Mbps	1/6/11	1
	11n HT20	MCS0	1/6/11	1
	11n HT40	MCS0	3/6/9	1
6dB Spectrum Bandwidth	11b/CCK	1 Mbps	1/6/11	1
	11g/BPSK	6 Mbps	1/6/11	1
	11n HT20	MCS0	1/6/11	1
	11n HT40	MCS0	3/6/9	1
Radiated Emissions Below 1GHz	Normal Link	-	-	-
Radiated Emissions Above 1GHz	11b/CCK	1 Mbps	1/6/11	1
	11g/BPSK	6 Mbps	1/6/11	1
	11n HT20	MCS0	1/6/11	1
	11n HT40	MCS0	3/6/9	1
Band Edge Emissions	11b/CCK	1 Mbps	1/6/11	1
	11g/BPSK	6 Mbps	1/6/11	1
	11n HT20	MCS0	1/6/11	1
	11n HT40	MCS0	3/6/9	1

## 6 SETUP OF EQUIPMENT UNDER TEST

### 6.1 BLOCK DIAGRAM CONFIGURATION OF TEST SYSTEM

For AC Conducted Emission Mode

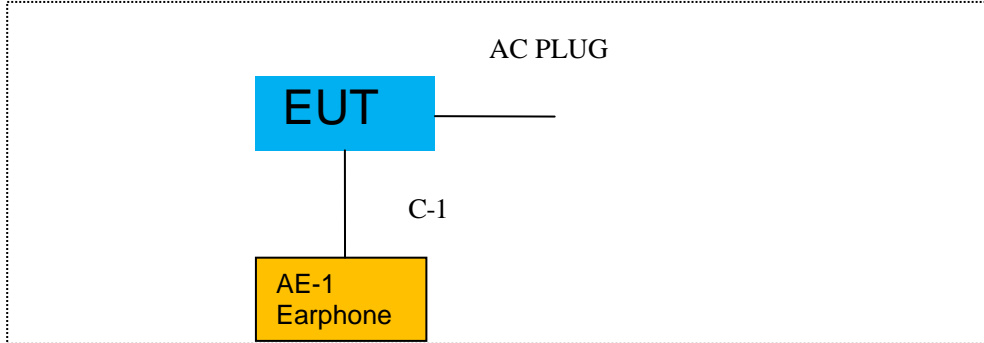

For Radiated Test Cases

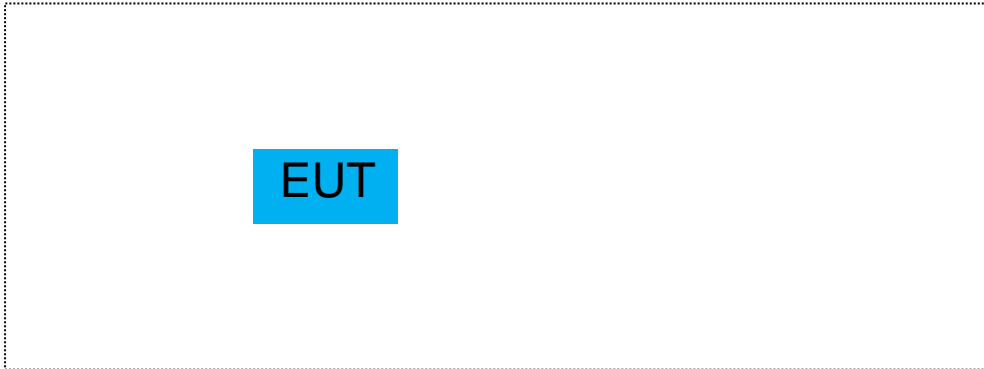

For Conducted Test Cases

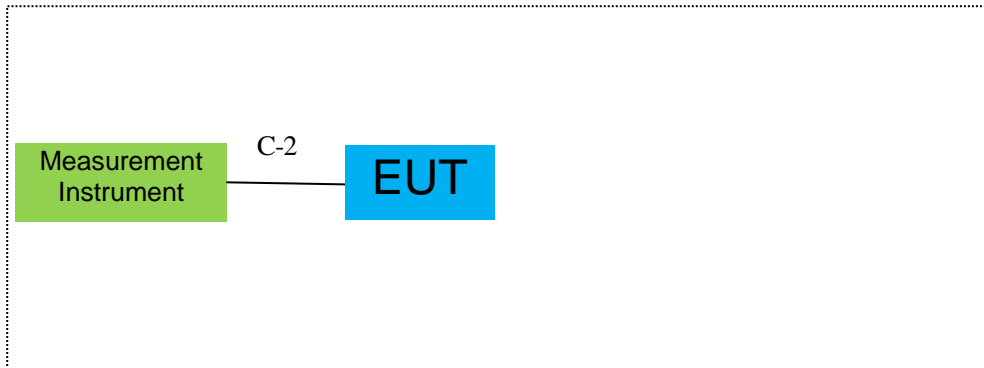

Note: The temporary antenna connector is soldered on the PCB board in order to perform conducted tests and this temporary antenna connector is listed in the equipment list.

**6.2 SUPPORT EQUIPMENT**

The EUT has been tested as an independent unit together with other necessary accessories or support units. The following support units or accessories were used to form a representative test configuration during the tests.

Item	Equipment	Mfr/Brand	Model/Type No.	Series No.	Note
AE-1	Earphone	N/A	N/A	N/A	Peripherals

Item	Cable Type	Shielded Type	Ferrite Core	Length
C-1	Earphone Cable	NO	NO	1.2m
C-2	RF Cable	YES	NO	0.1m

**Notes:**

- (1) The support equipment was authorized by Declaration of Confirmation.
- (2) For detachable type I/O cable should be specified the length in cm in 『Length』 column.
- (3) “YES” is means “shielded” “with core”; “NO” is means “unshielded” “without core”.

### 6.3 EQUIPMENTS LIST FOR ALL TEST ITEMS

#### Radiation& Conducted Test equipment

Item	Kind of Equipment	Manufacturer	Type No.	Serial No.	Last calibration	Calibrated until	Calibration period
1	Spectrum Analyzer	Agilent	E4407B	MY45108040	2019.05.13	2020.05.12	1 year
2	Spectrum Analyzer	Agilent	N9020A	MY49100060	2018.10.08	2019.10.07	1 year
3	Spectrum Analyzer	R&S	FSV40	101417	2018.10.08	2019.10.07	1 year
4	Test Receiver	R&S	ESPI7	101318	2019.05.13	2020.05.12	1 year
5	Bilog Antenna	TESEQ	CBL6111D	31216	2019.04.15	2020.04.14	1 year
6	50Ω Coaxial Switch	Anritsu	MP59B	6200983705	2018.05.19	2020.05.18	2 year
7	Horn Antenna	EM	EM-AH-10180	2011071402	2019.04.15	2020.04.14	1 year
8	Broadband Horn Antenna	SCHWARZBECK	BBHA 9170	803	2018.12.11	2019.12.10	1 year
9	Amplifier	EMC	EMC051835SE	980246	2018.08.05	2019.08.04	1 year
10	Active Loop Antenna	SCHWARZBECK	FMZB 1519B	055	2018.12.11	2019.12.10	1 year
11	Power Meter	DARE	RPR3006W	15I00041SN084	2018.08.05	2019.08.04	1 year
12	Test Cable (9KHz-30MHz)	N/A	R-01	N/A	2017.04.21	2020.04.20	3 year
13	Test Cable (30MHz-1GHz)	N/A	R-02	N/A	2017.04.21	2020.04.20	3 year
14	High Test Cable(1G-40G Hz)	N/A	R-03	N/A	2017.04.21	2020.04.20	3 year
15	High Test Cable(1G-40G Hz)	N/A	R-04	N/A	2017.04.21	2020.04.20	3 year
16	Filter	TRILTHIC	2400MHz	29	2017.04.19	2020.04.18	3 year
17	temporary antenna connector (Note)	NTS	R001	N/A	N/A	N/A	N/A

Note:

We will use the temporary antenna connector (soldered on the PCB board) When conducted test  
And this temporary antenna connector is listed within the instrument list

AC Conduction Test equipment

Item	Kind of Equipment	Manufacturer	Type No.	Serial No.	Last calibration	Calibrated until	Calibration period
1	Test Receiver	R&S	ESCI	101160	2019.05.13	2020.05.12	1 year
2	LISN	R&S	ENV216	101313	2019.04.15	2020.04.14	1 year
3	LISN	SCHWARZBECK	NNLK 8129	8129245	2019.05.13	2020.05.12	1 year
4	50Ω Coaxial Switch	ANRITSU CORP	MP59B	6200983704	2018.05.19	2020.05.18	2 year
5	Test Cable (9KHz-30MHz)	N/A	C01	N/A	2017.04.21	2020.04.20	3 year
6	Test Cable (9KHz-30MHz)	N/A	C02	N/A	2017.04.21	2020.04.20	3 year
7	Test Cable (9KHz-30MHz)	N/A	C03	N/A	2017.04.21	2020.04.20	3 year

Note: Each piece of equipment is scheduled for calibration once a year except the Aux Equipment & Test Cable which is scheduled for calibration every 2 or 3 years.

**7 TEST REQUIREMENTS**

**7.1 CONDUCTED EMISSIONS TEST**

**7.1.1 Applicable Standard**

According to FCC Part 15.207(a) and KDB 174176 D01 Line Conducted FAQ v01r01

**7.1.2 Conformance Limit**

Frequency(MHz)	Conducted Emission Limit	
	Quasi-peak	Average
0.15-0.5	66-56*	56-46*
0.5-5.0	56	46
5.0-30.0	60	50

Note: 1. \*Decreases with the logarithm of the frequency  
 2. The lower limit shall apply at the transition frequencies  
 3. The limit decreases in line with the logarithm of the frequency in the range of 0.15 to 0.50MHz.

**7.1.3 Measuring Instruments**

The Measuring equipment is listed in the section 6.3 of this test report.

**7.1.4 Test Configuration**

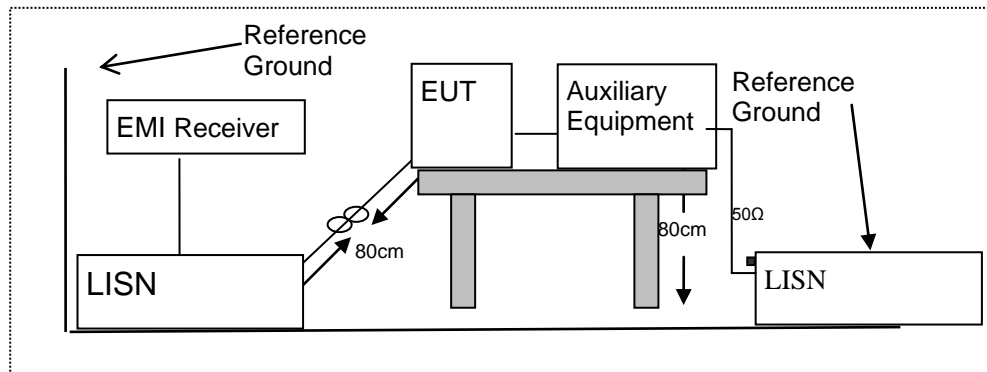

**7.1.5 Test Procedure**

According to the requirements in Section 13.1.4.1 of ANSI C63.10-2013 Conducted emissions the EUT measured in the frequency range between 0.15 MHz and 30 MHz using CISPR Quasi-Peak and average detector mode.

1. The EUT was placed 0.4 meter from the conducting wall of the shielding room.
2. The EUT was placed on a table which is 0.8m above ground plane.
3. Connect EUT to the power mains through a line impedance stabilization network (LISN). All other support equipments powered from additional LISN(s). The LISN provide 50 Ohm/ 50uH of coupling impedance for the measuring instrument.
4. Interconnecting cables that hang closer than 40 cm to the ground plane shall be folded back and forth in the center forming a bundle 30 to 40cm long.
5. I/O cables that are not connected to a peripheral shall be bundled in the center. The end of the cable may be terminated, if required, using the correct terminating impedance. The overall length shall not exceed 1 m.
6. LISN at least 80 cm from nearest part of EUT chassis.
7. The frequency range from 150KHz to 30MHz was searched.
8. Set the test-receiver system to Peak Detect Function and specified bandwidth(IF bandwidth=9KHz) with Maximum Hold Mode
9. For the actual test configuration, please refer to the related Item –EUT Test Photos.

**7.1.6 Test Results**

EUT:	MID	Model Name :	ELT10101H
Temperature:	25 °C	Relative Humidity:	55%
Pressure:	1010hPa	Phase :	L
Test Voltage :	DC 5V from Adapter AC 120V/60Hz	Test Mode:	Normal Link

Frequency (MHz)	Reading Level (dBμV)	Correct Factor (dB)	Measure-ment (dBμV)	Limits (dBμV)	Margin (dB)	Remark
0.5140	34.85	9.74	44.59	56.00	-11.41	QP
0.5140	21.63	9.74	31.37	46.00	-14.63	AVG
0.8540	32.45	9.74	42.19	56.00	-13.81	QP
0.8540	20.28	9.74	30.02	46.00	-15.98	AVG
1.0940	33.14	9.74	42.88	56.00	-13.12	QP
1.0940	18.41	9.74	28.15	46.00	-17.85	AVG
2.2620	30.55	9.79	40.34	56.00	-15.66	QP
2.2620	17.78	9.79	27.57	46.00	-18.43	AVG
3.7820	29.55	9.85	39.40	56.00	-16.60	QP
3.7820	17.01	9.85	26.86	46.00	-19.14	AVG
4.9499	28.67	9.87	38.54	56.00	-17.46	
4.9499	16.01	9.87	25.88	46.00	-20.12	AVG

Remark:

1. All readings are Quasi-Peak and Average values.
2. Factor = Insertion Loss + Cable Loss.

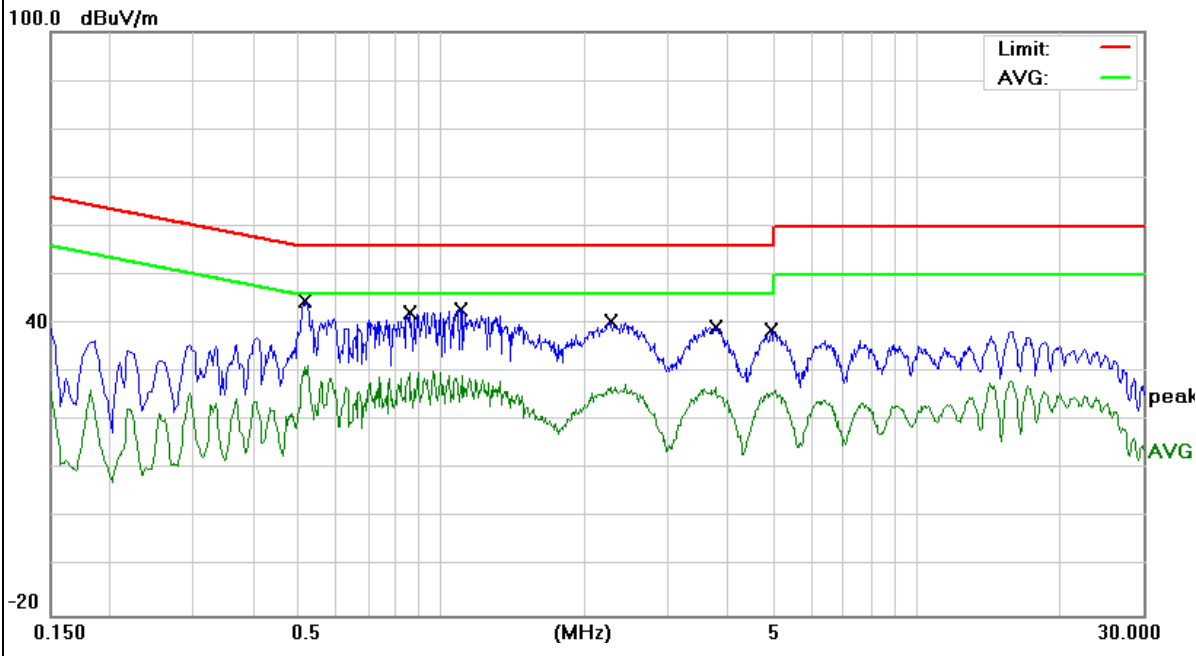

EUT:	MID	Model Name :	ELT10101H
Temperature:	25 °C	Relative Humidity:	55%
Pressure:	1010hPa	Phase :	N
Test Voltage :	DC 5V from Adapter AC 120V/60Hz	Test Mode:	Normal Link

Frequency (MHz)	Reading Level (dBμV)	Correct Factor (dB)	Measurement (dBμV)	Limits (dBμV)	Margin (dB)	Remark
0.5180	36.76	9.75	46.51	56.00	-9.49	QP
0.5180	27.72	9.75	37.47	46.00	-8.53	AVG
0.7260	28.37	9.75	38.12	56.00	-17.88	QP
0.7260	18.30	9.75	28.05	46.00	-17.95	AVG
0.8540	28.16	9.75	37.91	56.00	-18.09	QP
0.8540	19.58	9.75	29.33	46.00	-16.67	AVG
1.1019	28.60	9.75	38.35	56.00	-17.65	QP
1.1019	15.70	9.75	25.45	46.00	-20.55	AVG
5.1380	27.77	9.94	37.71	60.00	-22.29	QP
5.1380	13.90	9.94	23.84	50.00	-26.16	AVG
16.5100	26.51	10.13	36.64	60.00	-23.36	QP
16.5100	17.60	10.13	27.73	50.00	-22.27	AVG

Remark:

1. All readings are Quasi-Peak and Average values.
2. Factor = Insertion Loss + Cable Loss.

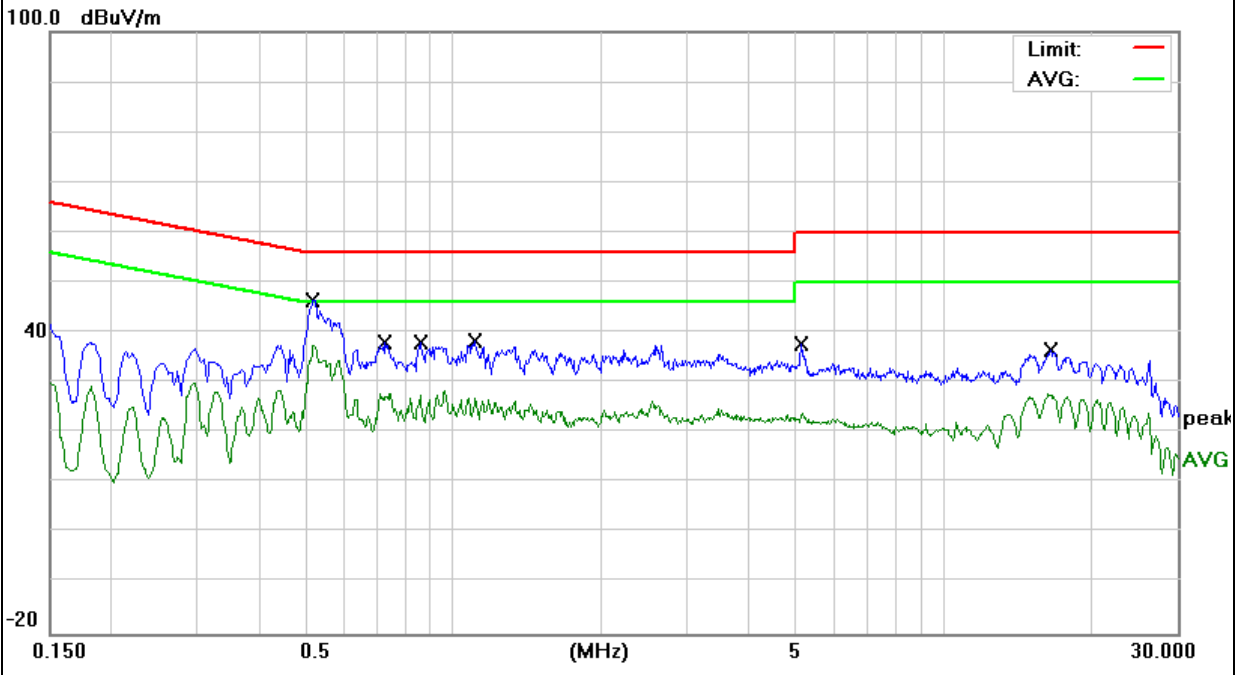



EUT:	MID	Model Name :	ELT10101H
Temperature:	25 °C	Relative Humidity:	55%
Pressure:	1010hPa	Phase :	L
Test Voltage :	DC 5V from Adapter AC 240V/60Hz	Test Mode:	Normal Link

Frequency (MHz)	Reading Level (dBμV)	Correct Factor (dB)	Measure-ment (dBμV)	Limits (dBμV)	Margin (dB)	Remark
0.5620	34.30	9.74	44.04	56.00	-11.96	QP
0.5620	18.92	9.74	28.66	46.00	-17.34	AVG
0.5980	36.19	9.74	45.93	56.00	-10.07	QP
0.5980	24.58	9.74	34.32	46.00	-11.68	AVG
1.0780	34.09	9.74	43.83	56.00	-12.17	QP
1.0780	22.29	9.74	32.03	46.00	-13.97	AVG
2.3020	31.37	9.79	41.16	56.00	-14.84	QP
2.3020	18.04	9.79	27.83	46.00	-18.17	AVG
3.6980	30.11	9.84	39.95	56.00	-16.05	QP
3.6980	17.70	9.84	27.54	46.00	-18.46	AVG
4.8979	28.03	9.87	37.90	56.00	-18.10	QP
4.8979	18.28	9.87	28.15	46.00	-17.85	

Remark:

- All readings are Quasi-Peak and Average values.
- Factor = Insertion Loss + Cable Loss.

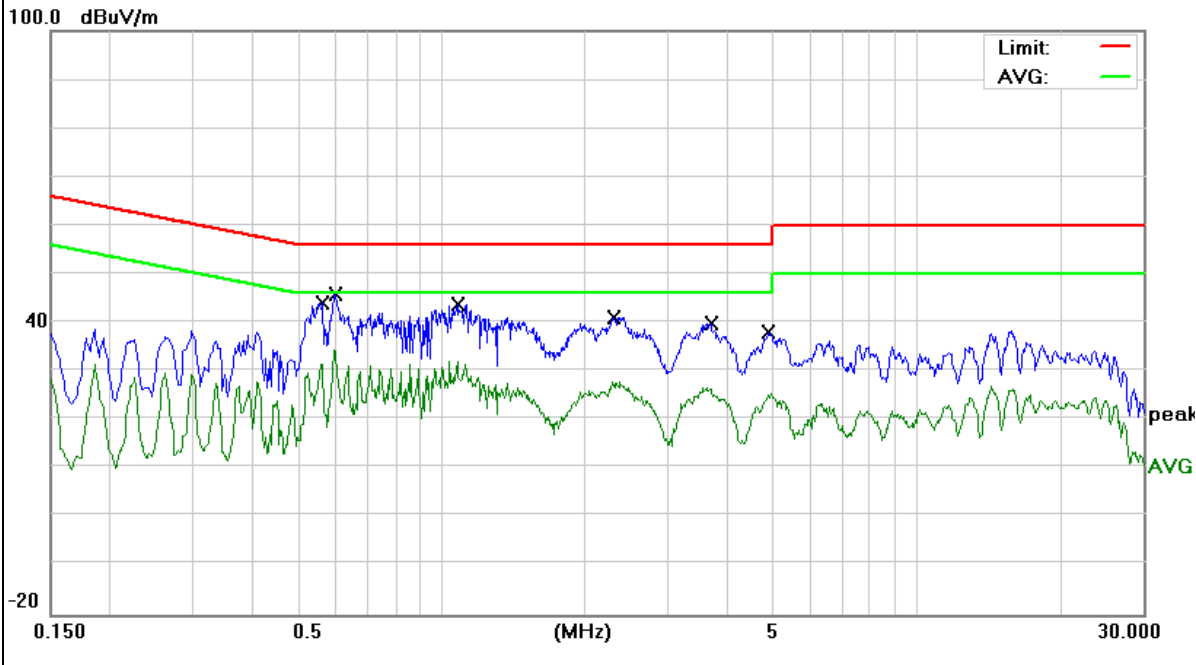

EUT:	MID	Model Name :	ELT10101H
Temperature:	25 °C	Relative Humidity:	55%
Pressure:	1010hPa	Phase :	N
Test Voltage :	DC 5V from Adapter AC 240V/60Hz	Test Mode:	Normal Link

Frequency (MHz)	Reading Level (dBμV)	Correct Factor (dB)	Measurement (dBμV)	Limits (dBμV)	Margin (dB)	Remark
0.5580	38.27	9.75	48.02	56.00	-7.98	QP
0.5580	32.69	9.75	42.44	46.00	-3.56	AVG
0.5980	36.36	9.75	46.11	56.00	-9.89	QP
0.5980	29.51	9.75	39.26	46.00	-6.74	AVG
0.7380	31.84	9.75	41.59	56.00	-14.41	QP
0.7380	18.72	9.75	28.47	46.00	-17.53	AVG
1.0820	31.95	9.75	41.70	56.00	-14.30	QP
1.0820	20.27	9.75	30.02	46.00	-15.98	AVG
1.4780	30.57	9.77	40.34	56.00	-15.66	QP
1.4780	19.68	9.77	29.45	46.00	-16.55	AVG
15.2460	25.29	10.09	35.38	60.00	-24.62	QP
15.2460	16.34	10.09	26.43	50.00	-23.57	AVG

Remark:

1. All readings are Quasi-Peak and Average values.
2. Factor = Insertion Loss + Cable Loss.

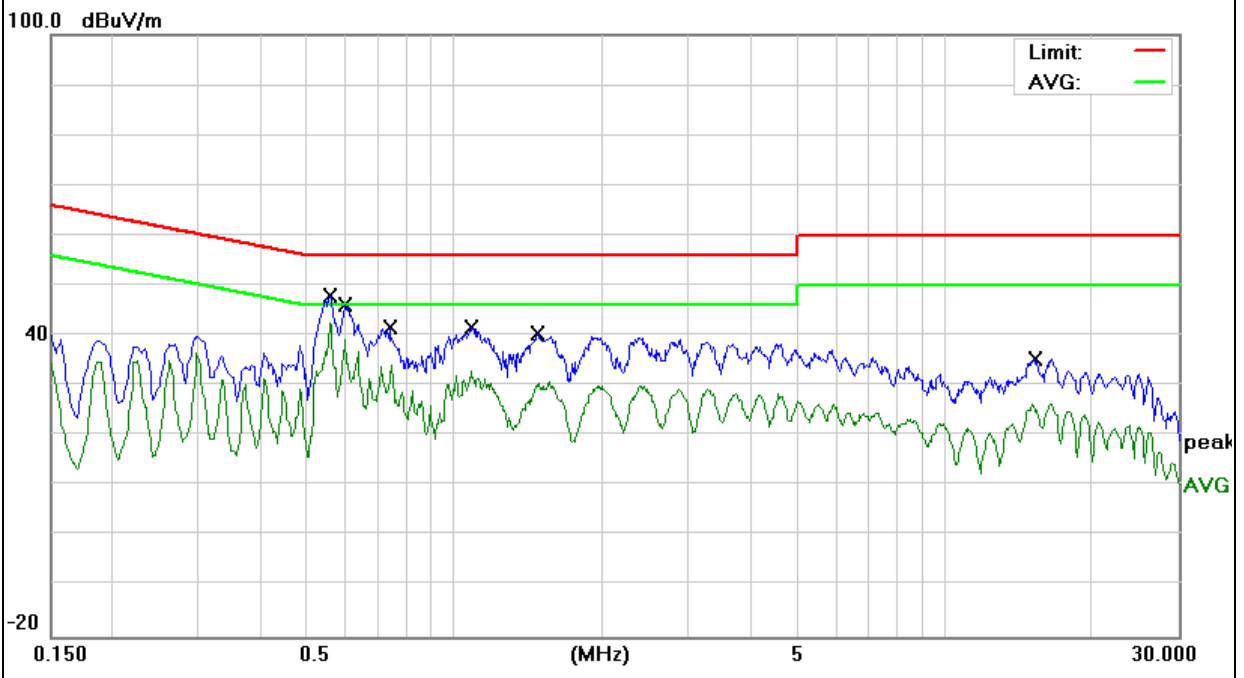

**7.2 RADIATED SPURIOUS EMISSION**

**7.2.1 Applicable Standard**

According to FCC Part 15.247(d) and 15.209 and ANSI C63.10-2013

**7.2.2 Conformance Limit**

According to FCC Part 15.247(d): radiated emissions which fall in the restricted bands, as defined in §15.205(a), must also comply with the radiated emission limits specified in §15.209(a) (see §15.205(c)).  
According to FCC Part 15.205, Restricted bands

MHz	MHz	MHz	GHz
0.090-0.110	16.42-16.423	399.9-410	4.5-5.15
0.495-0.505	16.69475-16.69525	608-614	5.35-5.46
2.1735-2.1905	16.80425-16.80475	960-1240	7.25-7.75
4.125-4.128	25.5-25.67	1300-1427	8.025-8.5
4.17725-4.17775	37.5-38.25	1435-1626.5	9.0-9.2
4.20725-4.20775	73-74.6	1645.5-1646.5	9.3-9.5
6.215-6.218	74.8-75.2	1660-1710	10.6-12.7
6.26775-6.26825	123-138	2200-2300	14.47-14.5
8.291-8.294	149.9-150.05	2310-2390	15.35-16.2
8.362-8.366	156.52475-156.52525	2483.5-2500	17.7-21.4
8.37625-8.38675	156.7-156.9	2690-2900	22.01-23.12
8.41425-8.41475	162.0125-167.17	3260-3267	23.6-24.0
12.29-12.293	167.72-173.2	3332-3339	31.2-31.8
12.51975-12.52025	240-285	3345.8-3358	36.43-36.5
12.57675-12.57725	322-335.4	3600-4400	(2)
13.36-13.41			

20dBc in any 100 kHz bandwidth outside the operating frequency band. In case the emission fall within the restricted band specified on 15.205(a), then the 15.209(a) limit in the table below has to be followed.

Restricted Frequency(MHz)	Field Strength (µV/m)	Field Strength (dBµV/m)	Measurement Distance
0.009~0.490	2400/F(KHz)	20 log (uV/m)	300
0.490~1.705	24000/F(KHz)	20 log (uV/m)	30
1.705~30.0	30	29.5	30
30-88	100	40	3
88-216	150	43.5	3
216-960	200	46	3
Above 960	500	54	3

Limits of Radiated Emission Measurement(Above 1000MHz)

Frequency(MHz)	Class B (dBuV/m) (at 3M)	
	PEAK	AVERAGE
Above 1000	74	54

Remark :1. Emission level in dBuV/m=20 log (uV/m)  
 2. Measurement was performed at an antenna to the closed point of EUT distance of meters.  
 3. For Frequency 9kHz~30MHz:  
 Distance extrapolation factor =40log(Specific distance/ test distance)(dB);  
 Limit line=Specific limits(dBuV) + distance extrapolation factor.  
 For Frequency above 30MHz:  
 Distance extrapolation factor =20log(Specific distance/ test distance)(dB);  
 Limit line=Specific limits(dBuV) + distance extrapolation factor.

**7.2.3 Measuring Instruments**

The Measuring equipment is listed in the section 6.3 of this test report.

**7.2.4 Test Configuration**

(a) For radiated emissions below 30MHz

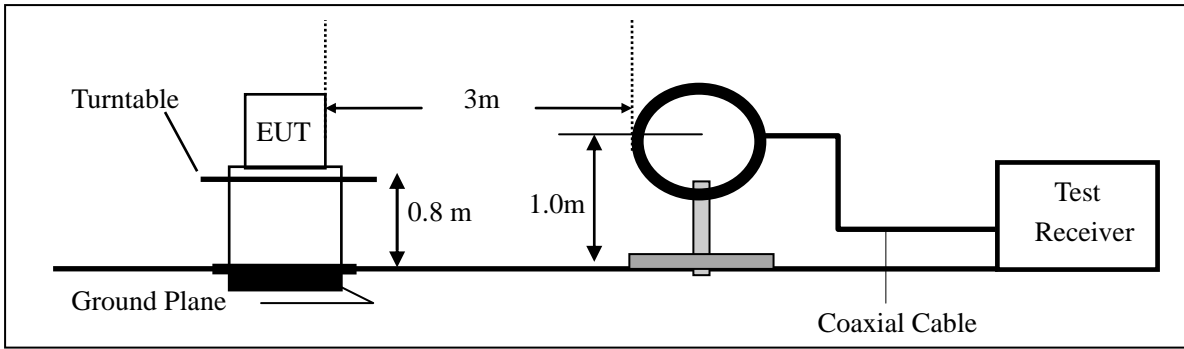

(b) For radiated emissions from 30MHz to 1000MHz

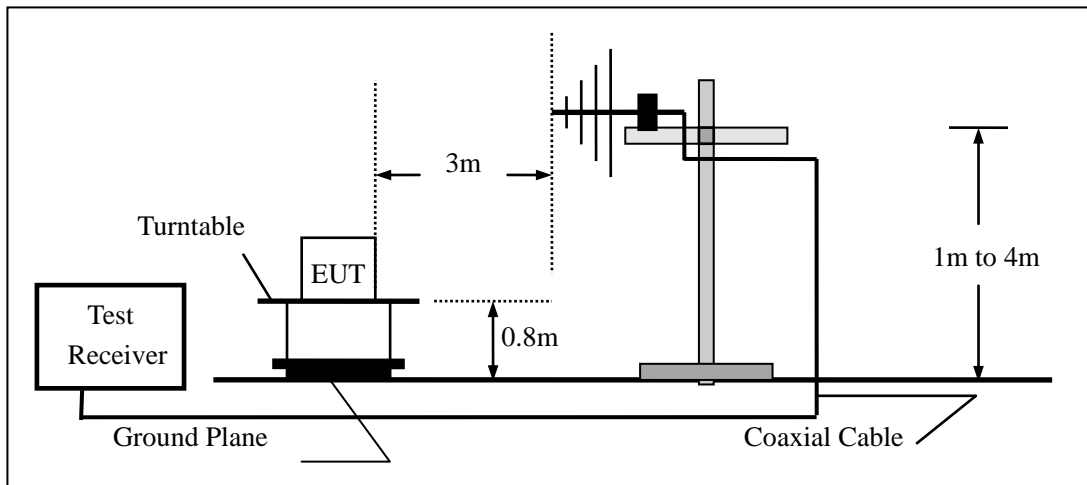

(c) For radiated emissions above 1000MHz

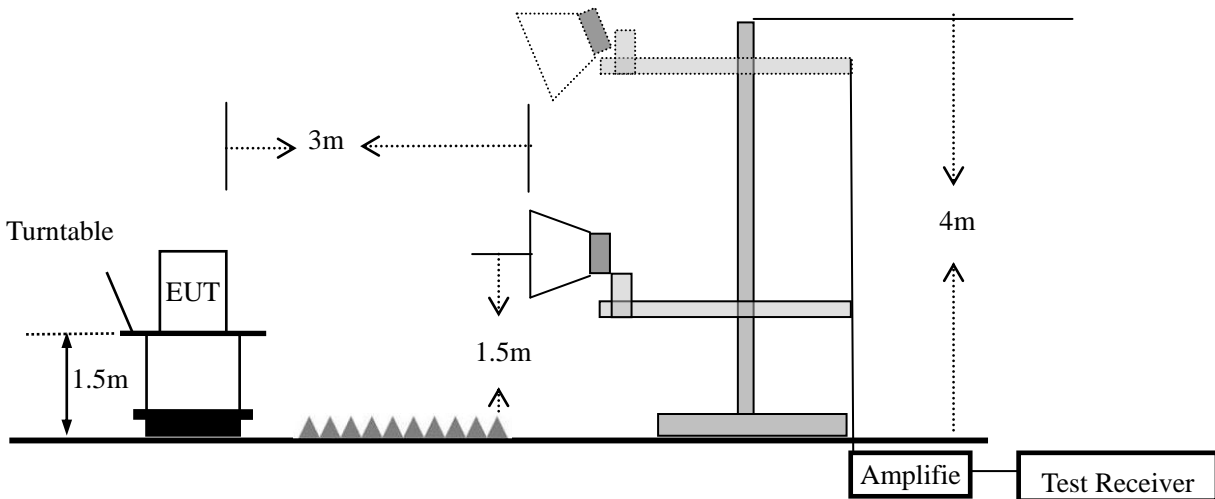

**7.2.5 Test Procedure**

The test site semi-anechoic chamber has met the requirement of NSA tolerance 4 dB according to the standards: ANSI C63.10-2013. The test distance is 3m. The setup is according to the requirements in Section 13.1.4.1 of ANSI C63.10-2013 and CAN/CSA-CEI/IEC CISPR 22. This test is required for any spurious emission that falls in a Restricted Band, as defined in Section 15.205. It must be performed with the highest gain of each type of antenna proposed for use with the EUT. Use the following spectrum analyzer settings:

Spectrum Parameter	Setting
Attenuation	Auto
Start Frequency	1000 MHz
Stop Frequency	10th carrier harmonic
RB / VB (emission in restricted band)	1 MHz / 1 MHz for Peak, 1 MHz / 10Hz for Average

Receiver Parameter	Setting
Attenuation	Auto
Start ~ Stop Frequency	9kHz~150kHz / RB 200Hz for QP
Start ~ Stop Frequency	150kHz~30MHz / RB 9kHz for QP
Start ~ Stop Frequency	30MHz~1000MHz / RB 120kHz for QP

- a. The measuring distance of at 3 m shall be used for measurements at frequency up to 1GHz and frequencies above 1GHz,
- b. The EUT was placed on the top of a rotating table 0.8 m for below 1GHz and 1.5m for above 1GHz the ground at a 3 meter. The table was rotated 360 degrees to determine the position of the highest radiation.
- c. The height of the equipment or of the substitution antenna shall be 0.8 m for below 1GHz and 1.5m for above 1GHz; the height of the test antenna shall vary between 1 m to 4 m. Both horizontal and vertical polarizations of the antenna are set to make the measurement.
- d. For the radiated emission test above 1GHz:  
Place the measurement antenna away from each area of the EUT determined to be a source of emissions at the specified measurement distance, while keeping the measurement antenna aimed at the source of emissions at each frequency of significant emissions, with polarization oriented for maximum response. The measurement antenna may have to be higher or lower than the EUT, depending on the radiation pattern of the emission and staying aimed at the emission source for receiving the maximum signal. The final measurement antenna elevation shall be that which maximizes the emissions. The measurement antenna elevation for maximum emissions shall be restricted to a range of heights of from 1 m to 4 m above the ground or reference ground plane.
- e. The initial step in collecting conducted emission data is a spectrum analyzer peak detector mode pre-scanning the measurement frequency range. Significant peaks are then marked and then Quasi Peak detector mode re-measured.
- f. If the Peak Mode measured value compliance with and lower than Quasi Peak Mode Limit, the EUT shall be deemed to meet QP Limits and then no additional QP Mode measurement performed.
- g. For the actual test configuration, please refer to the related Item –EUT Test Photos.

Note:

Both horizontal and vertical antenna polarities were tested and performed pretest to three orthogonal axis. The worst case emissions were reported

During the radiated emission test, the Spectrum Analyzer was set with the following configurations:

For peak measurement:

Set RBW=120 kHz for  $f < 1$  GHz;  $VBW \geq RBW$ ; Sweep = auto; Detector function = peak; Trace = max hold; Set RBW = 1 MHz, VBW= 3MHz for  $f \geq 1$  GHz

For average measurement:

VBW = 10 Hz, when duty cycle is no less than 98 percent.

VBW  $\geq 1/T$ , when duty cycle is less than 98 percent where T is the minimum transmission duration over which the transmitter is on and is transmitting at its maximum power control level for the tested mode of

operation.

Note: for the frequency ranges below 30 MHz, a narrower RBW is used for these ranges but the measured value should add a RBW correction factor (RBWCF) where  $RBWCF [dB] = 10 \cdot \lg(100 [kHz]/\text{narrower RBW [kHz]})$ . , the narrower RBW is 1 kHz and RBWCF is 20 dB for the frequency 9 kHz to 150 kHz, and the narrower RBW is 10 kHz and RBWCF is 10 dB for the frequency 150 kHz to 30 MHz.

**7.2.6 Test Results**

■ Spurious Emission below 30MHz (9KHz to 30MHz)

EUT:	MID	Model No.:	ELT10101H
Temperature:	20 °C	Relative Humidity:	48%
Test Mode:	802.11b/g/n(HT20, HT40)	Test By:	Allen Liu

Freq. (MHz)	Ant.Pol. H/V	Emission Level(dBuV/m)		Limit 3m(dBuV/m)		Over(dB)	
		PK	AV	PK	AV	PK	AV
--	--	--	--	--	--	--	--

Note: the amplitude of spurious emission that is attenuated by more than 20dB below the permissible limit has no need to be reported.

- Spurious Emission below 1GHz (30MHz to 1GHz)  
All the modulation modes have been tested, and the worst result was report as below:

EUT:	MID	Model Name :	ELT10101H
Temperature:	25 °C	Relative Humidity:	51%
Pressure:	1010hPa	Test Mode:	Normal Link
Test Voltage :	DC 3.7V		

Polar (H/V)	Frequency	Meter Reading	Factor	Emission Level	Limits	Margin	Remark
	(MHz)	(dBuV)	(dB)	(dBuV/m)	(dBuV/m)	(dB)	
V	31.3992	8.76	18.40	27.16	40.00	-12.84	QP
V	44.5868	13.23	11.80	25.03	40.00	-14.97	QP
V	165.4866	14.92	11.41	26.33	43.50	-17.17	QP
V	190.4050	14.45	10.17	24.62	43.50	-18.88	QP
V	315.4806	9.75	16.43	26.18	46.00	-19.82	QP
V	801.7863	9.11	27.27	36.38	46.00	-9.62	QP

**Remark:**

Absolute Level= ReadingLevel+ Factor, Margin= Absolute Level - Limit

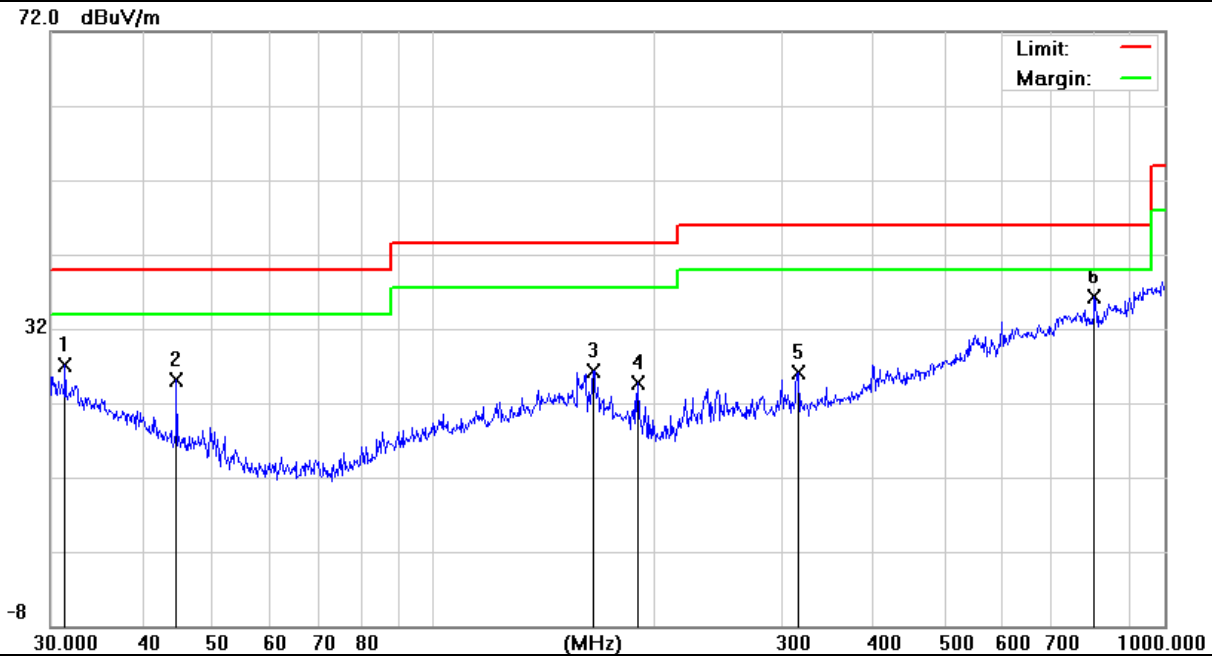

Polar (H/V)	Frequency	Meter Reading	Factor	Emission Level	Limits	Margin	Remark
	(MHz)	(dBuV)	(dB)	(dBuV/m)	(dBuV/m)	(dB)	
H	150.0108	17.36	12.77	30.13	43.50	-13.37	QP
H	165.4866	20.10	11.41	31.51	43.50	-11.99	QP
H	241.6763	18.62	13.25	31.87	46.00	-14.13	QP
H	313.2760	13.29	16.40	29.69	46.00	-16.31	QP
H	396.2415	17.32	19.38	36.70	46.00	-9.30	QP
H	804.6028	11.04	27.33	38.37	46.00	-7.63	QP

**Remark:**

Absolute Level= ReadingLevel+ Factor, Margin= Absolute Level - Limit

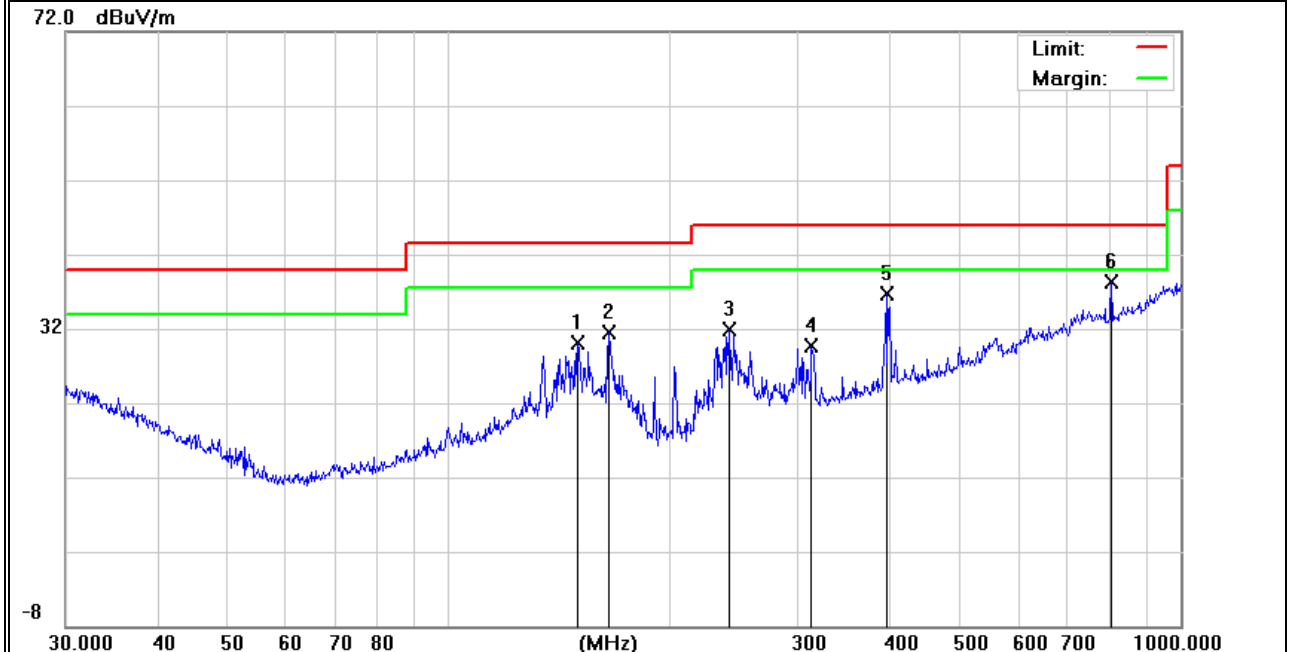



■ Spurious Emission Above 1GHz (1GHz to 25GHz)

EUT:	MID	Model No.:	ELT10101H
Temperature:	20 °C	Relative Humidity:	48%
Test Mode:	802.11b/g/n(HT20, HT40)	Test By:	Allen Liu

All the modulation modes have been tested, and the worst result was report as below:

Frequency (MHz)	Read Level (dBμV)	Cable loss (dB)	Antenna Factor dB/m	Preamp Factor (dB)	Emission Level (dBμV/m)	Limits (dBμV/m)	Margin (dB)	Remark	Comment
Low Channel (2412 MHz)(802.11g)--Above 1G									
4824.702	64.47	5.21	35.59	44.30	60.97	74.00	-13.03	Pk	Vertical
4824.702	42.68	5.21	35.59	44.30	39.18	54.00	-14.82	AV	Vertical
7237.177	63.72	6.48	36.27	44.60	61.87	74.00	-12.13	Pk	Vertical
7237.177	46.51	6.48	36.27	44.60	44.66	54.00	-9.34	AV	Vertical
4824.607	64.38	5.21	35.55	44.30	60.84	74.00	-13.16	Pk	Horizontal
4824.607	43.90	5.21	35.55	44.30	40.36	54.00	-13.64	AV	Horizontal
7236.698	65.71	6.48	36.27	44.52	63.94	74.00	-10.06	Pk	Horizontal
7236.698	45.83	6.48	36.27	44.52	44.06	54.00	-9.94	AV	Horizontal
Middle Channel (2437 MHz)(802.11g)--Above 1G									
4874.393	60.98	5.21	35.66	44.20	57.65	74.00	-16.35	Pk	Vertical
4874.393	39.84	5.21	35.66	44.20	36.51	54.00	-17.49	AV	Vertical
7311.36	58.06	7.10	36.50	44.43	57.23	74.00	-16.77	Pk	Vertical
7311.36	40.63	7.10	36.50	44.43	39.80	54.00	-14.20	AV	Vertical
4874.376	58.70	5.21	35.66	44.20	55.37	74.00	-18.63	Pk	Horizontal
4874.376	41.50	5.21	35.66	44.20	38.17	54.00	-15.83	AV	Horizontal
7311.626	58.92	7.10	36.50	44.43	58.09	74.00	-15.91	Pk	Horizontal
7311.626	41.60	7.10	36.50	44.43	40.77	54.00	-13.23	AV	Horizontal
High Channel (2462 MHz)(802.11g)--Above 1G									
4924.326	61.63	5.21	35.52	44.21	58.15	74.00	-15.85	Pk	Vertical
4924.326	43.06	5.21	35.52	44.21	39.58	54.00	-14.42	AV	Vertical
7386.384	65.07	7.10	36.53	44.60	64.10	74.00	-9.90	Pk	Vertical
7386.384	42.88	7.10	36.53	44.60	41.91	54.00	-12.09	AV	Vertical
4924.854	65.74	5.21	35.52	44.21	62.26	74.00	-11.74	Pk	Horizontal
4924.854	44.67	5.21	35.52	44.21	41.19	54.00	-12.81	AV	Horizontal
7386.853	62.77	7.10	36.53	44.60	61.80	74.00	-12.20	Pk	Horizontal
7386.853	43.88	7.10	36.53	44.60	42.91	54.00	-11.09	AV	Horizontal

Note:

- (1) Emission Level= Antenna Factor + Cable Loss + Read Level - Preamp Factor
- (2) Data of measurement within this frequency range shown "--" in the table above means the reading of emissions are attenuated more than 20dB below the permissible limits or the field strength is too small to be measured.
- (3)"802.11g" mode is the worst mode. When PK value is lower than the Average value limit, average don't record.

■ Spurious Emission in Restricted Band 2310MHz -18000MHz

All the modulation modes have been tested, and the worst result was report as below:

Frequency (MHz)	Meter Reading (dBμV)	Cable Loss (dB)	Antenna Factor (dB/m)	Preamp Factor (dB)	Emission Level (dBμV/m)	Limits (dBμV/m)	Margin (dB)	Detector Type	Comment
802.11b									
2310.00	63.42	2.97	27.80	43.80	50.39	74	-23.62	Pk	Horizontal
2310.00	43.66	2.97	27.80	43.80	30.63	54	-23.37	AV	Horizontal
2310.00	61.55	2.97	27.80	43.80	48.52	74	-25.48	Pk	Vertical
2310.00	44.55	2.97	27.80	43.80	31.52	54	-22.48	AV	Vertical
2390.00	62.55	3.14	27.21	43.80	49.10	74	-24.90	Pk	Vertical
2390.00	44.41	3.14	27.21	43.80	30.96	54	-23.04	AV	Vertical
2390.00	60.65	3.14	27.21	43.80	47.20	74	-26.80	Pk	Horizontal
2390.00	43.45	3.14	27.21	43.80	30.00	54	-24.00	AV	Horizontal
2483.50	62.62	3.58	27.70	44.00	49.90	74	-24.10	Pk	Vertical
2483.50	43.74	3.58	27.70	44.00	31.02	54	-22.98	AV	Vertical
2483.50	64.32	3.58	27.70	44.00	51.60	74	-22.40	Pk	Horizontal
2483.50	42.55	3.58	27.70	44.00	29.83	54	-24.17	AV	Horizontal
802.11g									
2310.00	68.17	2.97	27.80	43.80	55.14	74	-18.86	Pk	Horizontal
2310.00	47.97	2.97	27.80	43.80	34.94	54	-19.06	AV	Horizontal
2310.00	69.87	2.97	27.80	43.80	56.84	74	-17.16	Pk	Vertical
2310.00	49.08	2.97	27.80	43.80	36.05	54	-17.95	AV	Vertical
2390.00	68.17	3.14	27.21	43.80	54.72	74	-19.28	Pk	Vertical
2390.00	48.97	3.14	27.21	43.80	35.52	54	-18.48	AV	Vertical
2390.00	68.31	3.14	27.21	43.80	54.86	74	-19.14	Pk	Horizontal
2390.00	51.74	3.14	27.21	43.80	38.29	54	-15.71	AV	Horizontal
2483.50	69.16	3.58	27.70	44.00	56.44	74	-17.56	Pk	Vertical
2483.50	50.08	3.58	27.70	44.00	37.36	54	-16.64	AV	Vertical
2483.50	70.27	3.58	27.70	44.00	57.55	74	-16.45	Pk	Horizontal
2483.50	51.74	3.58	27.70	44.00	39.02	54	-14.98	AV	Horizontal
802.11n20									
2310.00	62.41	2.97	27.80	43.80	49.38	74	-24.62	Pk	Horizontal
2310.00	41.88	2.97	27.80	43.80	28.85	54	-25.15	AV	Horizontal
2310.00	64.55	2.97	27.80	43.80	51.52	74	-22.48	Pk	Vertical
2310.00	42.55	2.97	27.80	43.80	29.52	54	-24.48	AV	Vertical
2390.00	65.32	3.14	27.21	43.80	51.87	74	-22.13	Pk	Vertical
2390.00	44.53	3.14	27.21	43.80	31.08	54	-22.92	AV	Vertical
2390.00	63.55	3.14	27.21	43.80	50.10	74	-23.90	Pk	Horizontal
2390.00	46.45	3.14	27.21	43.80	33.00	54	-21.00	AV	Horizontal
2483.50	62.34	3.58	27.70	44.00	49.62	74	-24.38	Pk	Vertical
2483.50	45.63	3.58	27.70	44.00	32.91	54	-21.09	AV	Vertical
2483.50	61.88	3.58	27.70	44.00	49.16	74	-24.84	Pk	Horizontal
2483.50	44.52	3.58	27.70	44.00	31.80	54	-22.20	AV	Horizontal
802.11n40									
2310.00	64.51	2.97	27.80	43.80	51.48	74	-22.52	Pk	Horizontal
2310.00	43.74	2.97	27.80	43.80	30.71	54	-23.29	AV	Horizontal
2310.00	64.07	2.97	27.80	43.80	51.04	74	-22.96	Pk	Vertical
2310.00	46.07	2.97	27.80	43.80	33.04	54	-20.96	AV	Vertical
2390.00	63.85	3.14	27.21	43.80	50.40	74	-23.60	Pk	Vertical
2390.00	44.51	3.14	27.21	43.80	31.06	54	-22.94	AV	Vertical
2390.00	66.08	3.14	27.21	43.80	52.63	74	-21.37	Pk	Horizontal
2390.00	44.51	3.14	27.21	43.80	31.06	54	-22.94	AV	Horizontal
2483.50	63.85	3.58	27.70	44.00	51.13	74	-22.87	Pk	Vertical
2483.50	44.08	3.58	27.70	44.00	31.36	54	-22.64	AV	Vertical
2483.50	64.82	3.58	27.70	44.00	52.10	74	-21.90	Pk	Horizontal
2483.50	43.04	3.58	27.70	44.00	30.32	54	-23.68	AV	Horizontal

Spurious Emission in Restricted Bands 3260MHz- 18000MHz

All the modulation modes have been tested, the worst result was report as below:

Frequency (MHz)	Reading Level (dB $\mu$ V)	Cable Loss (dB)	Antenna Factor (dB/m)	Preamp Factor (dB)	Emission Level (dB $\mu$ V/m)	Limits (dB $\mu$ V/m)	Margin (dB)	Detector Type	Comment
3260	66.21	4.04	29.57	44.70	55.12	74	-18.88	Pk	Vertical
3260	53.07	4.04	29.57	44.70	41.98	54	-12.02	AV	Vertical
3260	67.00	4.04	29.57	44.70	55.91	74	-18.09	Pk	Horizontal
3260	55.10	4.04	29.57	44.70	44.01	54	-9.99	AV	Horizontal
3332	64.54	4.26	29.87	44.40	54.27	74	-19.73	Pk	Vertical
3332	54.63	4.26	29.87	44.40	44.36	54	-9.64	AV	Vertical
3332	63.29	4.26	29.87	44.40	53.02	74	-20.98	Pk	Horizontal
3332	52.20	4.26	29.87	44.40	41.93	54	-12.07	AV	Horizontal
17797	44.90	10.99	43.95	43.50	56.34	74	-17.66	Pk	Vertical
17797	33.00	10.99	43.95	43.50	44.44	54	-9.56	AV	Vertical
17788	47.50	11.81	43.69	44.60	58.40	74	-15.60	Pk	Horizontal
17788	28.94	11.81	43.69	44.60	39.84	54	-14.16	AV	Horizontal

"802.11b" mode is the worst mode. When PK value is lower than the Average value limit, average don't record.

### 7.3 6DB BANDWIDTH

#### 7.3.1 Applicable Standard

According to FCC Part 15.247(a)(2) and KDB 558074 D01 15.247 Meas Guidance v05r02 Section 8.2.

#### 7.3.2 Conformance Limit

The minimum permissible 6dB bandwidth is 500 kHz.

#### 7.3.3 Measuring Instruments

The Measuring equipment is listed in the section 6.3 of this test report.

#### 7.3.4 Test Setup

Please refer to Section 6.1 of this test report.

#### 7.3.5 Test Procedure

The testing follows Subclause 11.8 of ANSI C63.10.

The RF output of EUT was connected to the spectrum analyzer by RF cable and attenuator.

The path loss was compensated to the results for each measurement.

Set to the maximum power setting and enable the EUT transmit continuously.

The EUT was operating in controlled its channel.

Use the following spectrum analyzer settings:

Span = the frequency band of operation

RBW = 100KHz

VBW  $\geq$  3\*RBW

Sweep = auto

Detector function = peak

Trace = max hold

7.3.6 Test Results

EUT:	MID	Model No.:	ELT10101H
Temperature:	20 °C	Relative Humidity:	48%
Test Mode:	802.11b/g/n20/n40	Test By:	Allen Liu

Test data reference attachment.

## 7.4 DUTY CYCLE

### 7.4.1 Applicable Standard

According to KDB 558074 D01 15.247 Meas Guidance v05r02 Section 6.

### 7.4.2 Conformance Limit

No limit requirement.

### 7.4.3 Measuring Instruments

The Measuring equipment is listed in the section 6.3 of this test report.

### 7.4.4 Test Setup

Please refer to Section 6.1 of this test report.

### 7.4.5 Test Procedure

The zero-span mode on a spectrum analyzer or EMI receiver if the response time and spacing between bins on the sweep are sufficient to permit accurate measurements of the on and off times of the transmitted signal. Set the center frequency of the instrument to the center frequency of the transmission. Set RBW  $\geq$  OBW if possible; otherwise, set RBW to the largest available value. Set VBW  $\geq$  RBW. Set detector = peak or average. The zero-span measurement method shall not be used unless both RBW and VBW are  $> 50/T$  and the number of sweep points across duration T exceeds 100. (For example, if VBW and/or RBW are limited to 3 MHz, then the zero-span method of measuring duty cycle shall not be used if  $T \leq 16.7$  microseconds.)

The transmitter output is connected to the Spectrum Analyzer. We tested according to the zero-span measurement method, 6.0)b) in KDB 558074

The largest available value of RBW is 8 MHz and VBW is 50 MHz. The zero-span method of measuring duty cycle shall not be used if  $T \leq 6.25$  microseconds. ( $50/6.25 = 8$ )

The zero-span method was used because all measured T data are  $> 6.25$  microseconds and both RBW and VBW are  $> 50/T$ .

The RF output of EUT was connected to the spectrum analyzer by RF cable and attenuator.

The path loss was compensated to the results for each measurement.

Set to the maximum power setting and enable the EUT transmit continuously.

The EUT was operating in controlled its channel.

Use the following spectrum analyzer settings:

Span = Zero Span

RBW = 8MHz(the largest available value)

VBW = 8MHz ( $\geq$  RBW)

Number of points in Sweep  $> 100$

Detector function = peak

Trace = Clear write

Measure  $T_{total}$  and  $T_{on}$

Calculate Duty Cycle =  $T_{on} / T_{total}$

**7.4.6 Test Results**

EUT:	MID	Model No.:	ELT10101H
Temperature:	20 °C	Relative Humidity:	48%
Test Mode:	802.11b/g/n20/n40	Test By:	Allen Liu

Test data reference attachment.

**7.5 MAXIMUM OUTPUT POWER**

**7.5.1 Applicable Standard**

According to FCC Part 15.247(b)(3) and KDB 558074 D01 15.247 Meas Guidance v05r02 Section 8.3.2.3.

**7.5.2 Conformance Limit**

The maximum peak conducted output power of the intentional radiator for systems using digital modulation in the 2400 - 2483.5 MHz bands shall not exceed: 1 Watt (30dBm). If transmitting antenna of directional gain greater than 6dBi is used, the peak output power from the intentional radiator shall be reduced below the above stated value by the amount in dB that the directional gain of the antenna exceeds 6 dBi. In case of point-to-point operation, the limit has to be reduced by 1dB for every 3dB that the directional gain of the antenna exceeds 6dBi.

**7.5.3 Measuring Instruments**

The following table is the setting of the power meter.

Power meter parameter	Setting
Detector	Peak

**7.5.4 Test Setup**

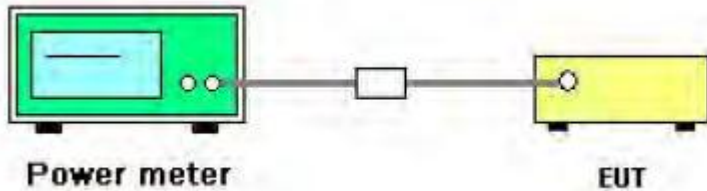

**7.5.5 Test Procedure**

The maximum peak conducted output power may be measured using a broadband peak RF power meter. The power meter shall have a video bandwidth that is greater than or equal to the *DTS bandwidth* and shall utilize a fast-responding diode detector.

**7.5.6 EUT operation during Test**

The EUT was programmed to be in continuously transmitting mode.



**7.5.7 Test Results**

EUT:	MID	Model No.:	ELT10101H
Temperature:	20 °C	Relative Humidity:	48%
Test Mode:	802.11b/g/n20/n40	Test By:	Allen Liu

Test data reference attachment.

## 7.6 POWER SPECTRAL DENSITY

### 7.6.1 Applicable Standard

According to FCC Part 15.247(e) and KDB 558074 D01 15.247 Meas Guidance v05r02 Section 8.4.

### 7.6.2 Conformance Limit

The transmitter power spectral density conducted from the transmitter to the antenna shall not be greater than 8 dBm in any 3 kHz band during any time interval of continuous transmission.

### 7.6.3 Measuring Instruments

The Measuring equipment is listed in the section 6.3 of this test report.

### 7.6.4 Test Setup

Please refer to Section 6.1 of this test report.

### 7.6.5 Test Procedure

The testing follows Measurement Procedure Subclause 11.10.2 of ANSI C63.10

This procedure shall be used if maximum peak conducted output power was used to demonstrate compliance, and is optional if the maximum conducted (average) output power was used to demonstrate compliance.

- a) Set analyzer center frequency to DTS channel center frequency.
- b) Set the span to 1.5 times the DTS bandwidth.
- c) Set the RBW to:  $3 \text{ kHz} \leq \text{RBW} \leq 100 \text{ kHz}$ .
- d) Set the VBW  $\geq 3 * \text{RBW}$ .
- e) Detector = peak.
- f) Sweep time = auto couple.
- g) Trace mode = max hold.
- h) Allow trace to fully stabilize.
- i) Use the peak marker function to determine the maximum amplitude level within the RBW.
- j) If measured value exceeds limit, reduce RBW (no less than 3 kHz) and repeat.

**7.6.6 Test Results**

EUT:	MID	Model No.:	ELT10101H
Temperature:	20 °C	Relative Humidity:	48%
Test Mode:	802.11b/g/n20/n40	Test By:	Allen Liu

Test data reference attachment.

## 7.7 CONDUCTED BAND EDGE MEASUREMENT

### 7.7.1 Applicable Standard

According to FCC Part 15.247(d) and KDB 558074 D01 15.247 Meas Guidance v05r02 Section 8.7.

### 7.7.2 Conformance Limit

In any 100 kHz bandwidth outside the frequency band in which the spread spectrum or digitally modulated intentional radiator is operating, the radio frequency power that is produced by the intentional radiator shall be at least 20 dB below that in the 100 kHz bandwidth within the band that contains the highest level of the desired power, based on either an RF conducted or a radiated measurement, provided the transmitter demonstrates compliance with the peak conducted power limits. If the transmitter complies with the conducted power limits based on the use of RMS averaging over a time interval, as permitted under paragraph (b)(3) of this section, the attenuation required under this paragraph shall be 30 dB instead of 20 dB.

### 7.7.3 Measuring Instruments

The Measuring equipment is listed in the section 6.3 of this test report.

### 7.7.4 Test Setup

Please refer to Section 6.1 of this test report.

### 7.7.5 Test Procedure

The testing follows FCC KDB 558074 D01 15.247 Meas Guidance v05r02 Section 8.7.

The RF output of EUT was connected to the spectrum analyzer by RF cable and attenuator.

The path loss was compensated to the results for each measurement.

Set to the maximum power setting and enable the EUT transmit continuously.

The EUT was operating in controlled its channel.

Set RBW to 100 kHz and VBW of spectrum analyzer to 300 kHz with a convenient frequency span including 100 kHz bandwidth from band edge.

Measure the highest amplitude appearing on spectral display and set it as a reference level. Plot the graph with marking the highest point and edge frequency.

Repeat above procedures until all measured frequencies were complete.

**7.7.6 Test Results**

EUT:	MID	Model No.:	ELT10101H
Temperature:	20 °C	Relative Humidity:	48%
Test Mode:	802.11b/g/n20/n40	Test By:	Allen Liu

Test data reference attachment.

## 7.8 SPURIOUS RF CONDUCTED EMISSIONS

### 7.8.1 Conformance Limit

1. Below -30dB of the highest emission level in operating band.
2. Fall in the restricted bands listed in section 15.205. The maximum permitted average field strength is listed in section 15.209.

### 7.8.2 Measuring Instruments

The Measuring equipment is listed in the section 6.3 of this test report.

### 7.8.3 Test Setup

Please refer to Section 6.1 of this test report.

### 7.8.4 Test Procedure

The Spurious RF conducted emissions compliance of RF radiated emission should be measured by following the guidance in ANSI C63.10-2013 with respect to maximizing the emission by rotating the EUT, measuring the emission while the EUT is situated in three orthogonal planes (if appropriate), adjusting the measurement antenna height and polarization etc. Set RBW=100kHz and VBW= 300KHz to measure the peak field strength , and mwasure frequency range from 9KHz to 26.5GHz.

### 7.8.5 Test Results

Remark: The measurement frequency range is from 9KHz to the 10th harmonic of the fundamental frequency. The lowest, middle and highest channels are tested to verify the spurious emissions and bandege measurement data.

Test data reference attachment.

## 7.9 ANTENNA APPLICATION

### 7.9.1 Antenna Requirement

15.203 requirement: For intentional device, according to 15.203: an intentional radiator shall be designed to ensure that no antenna other than that furnished by the responsible party shall be used with the device.

### 7.9.2 Result

The EUT antenna is permanent attached FPCB Antenna (Gain: 0.81dBi). It comply with the standard requirement.

### 8. TEST RESULTS

#### 8.1 DUTY CYCLE

Condition	Mode	Frequency (MHz)	Duty Cycle (%)	Correction Factor (dB)
NVNT	802.11b	2412	100	0
NVNT	802.11b	2437	100	0
NVNT	802.11b	2462	100	0
NVNT	802.11g	2412	100	0
NVNT	802.11g	2437	100	0
NVNT	802.11g	2462	100	0
NVNT	802.11n(HT20)	2412	100	0
NVNT	802.11n(HT20)	2437	100	0
NVNT	802.11n(HT20)	2462	100	0
NVNT	802.11n(HT40)	2422	100	0
NVNT	802.11n(HT40)	2437	100	0
NVNT	802.11n(HT40)	2452	100	0

Duty Cycle NVNT 802.11b 2412MHz

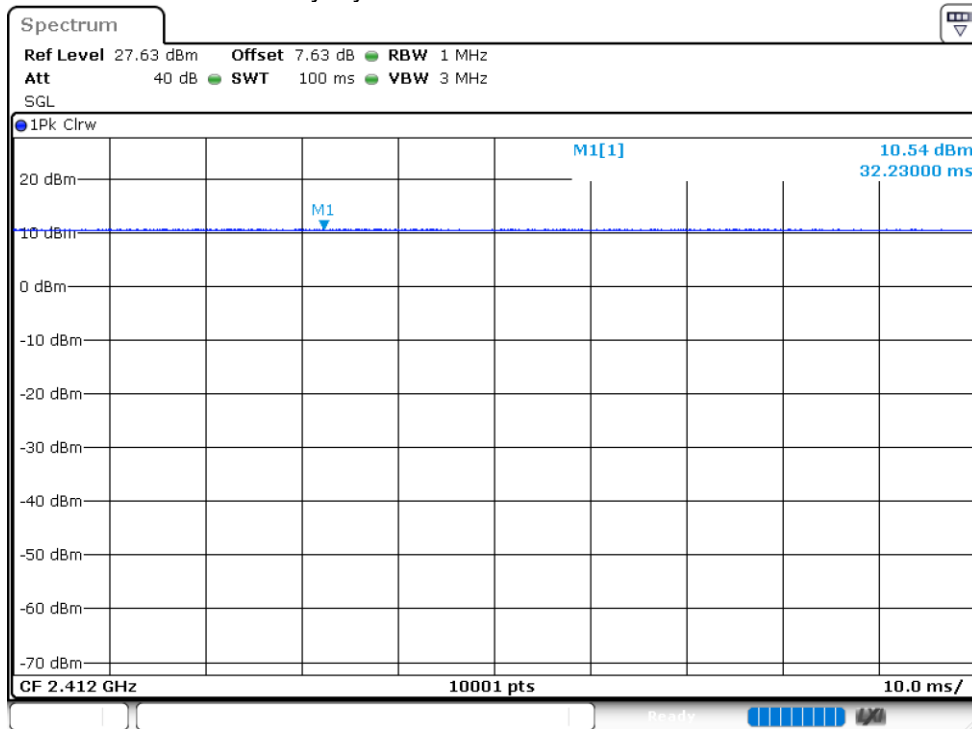



Duty Cycle NVNT 802.11b 2437MHz

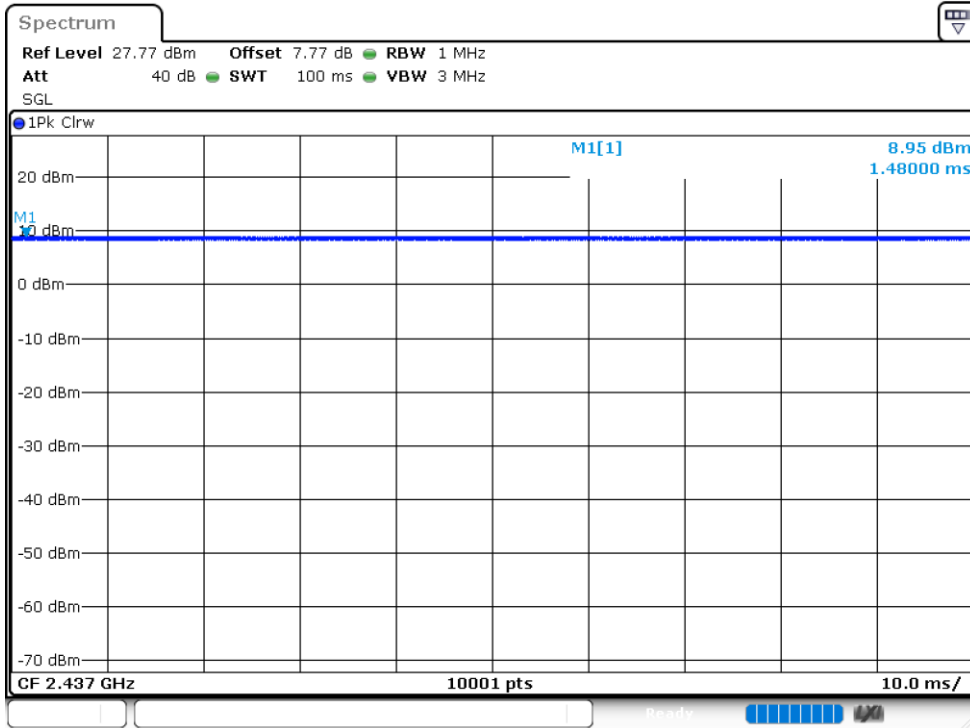

Duty Cycle NVNT 802.11b 2462MHz

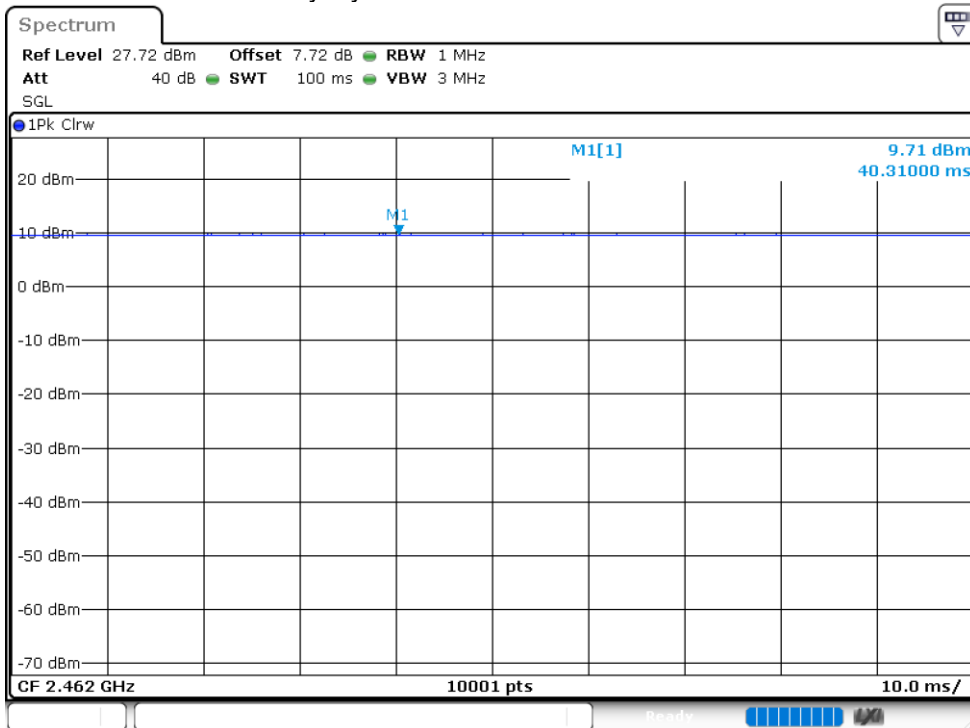

### Duty Cycle NVNT 802.11g 2412MHz

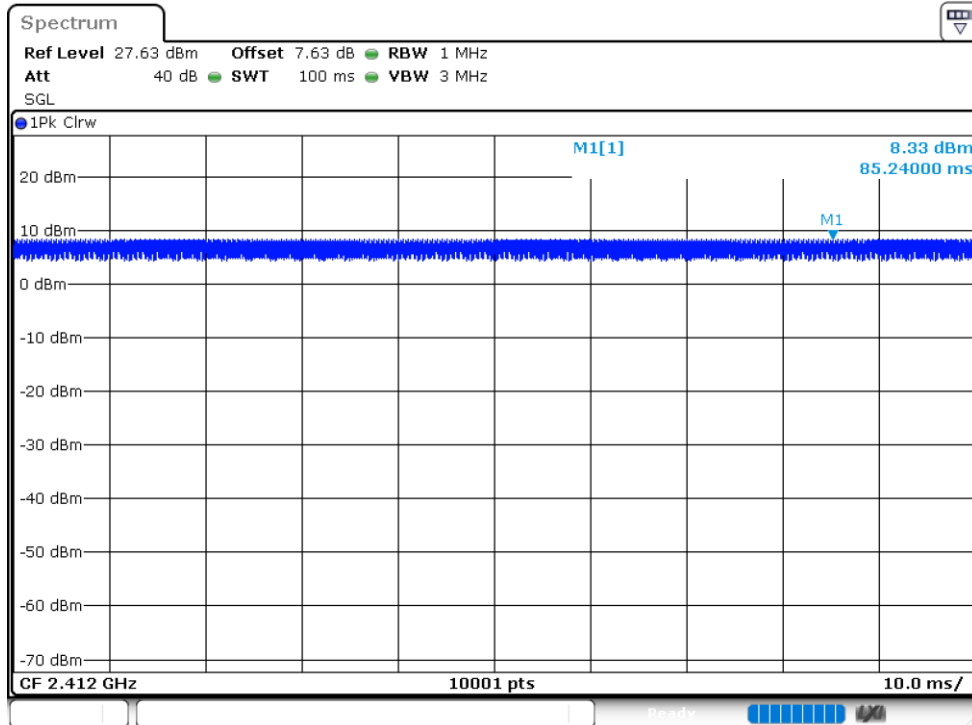

### Duty Cycle NVNT 802.11g 2437MHz

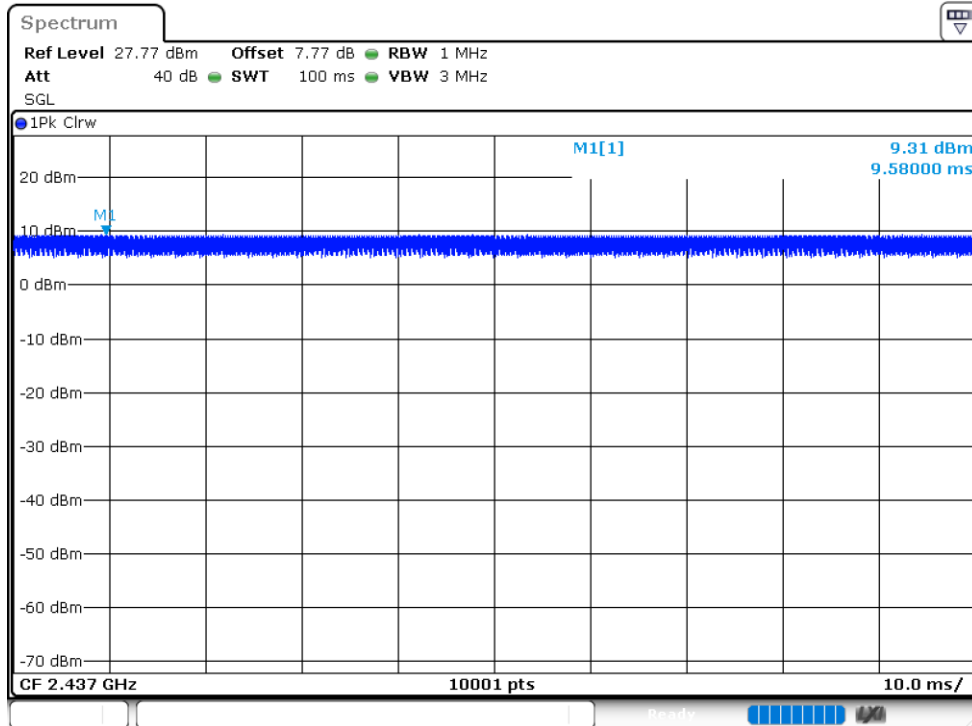

### Duty Cycle NVNT 802.11g 2462MHz

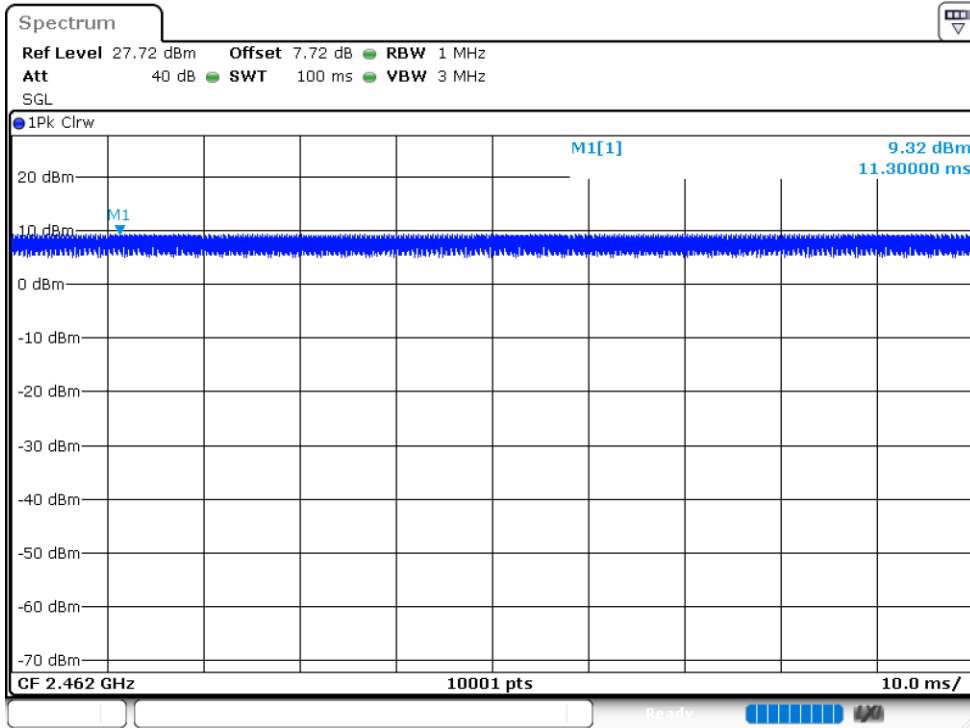

### Duty Cycle NVNT 802.11n(HT20) 2412MHz

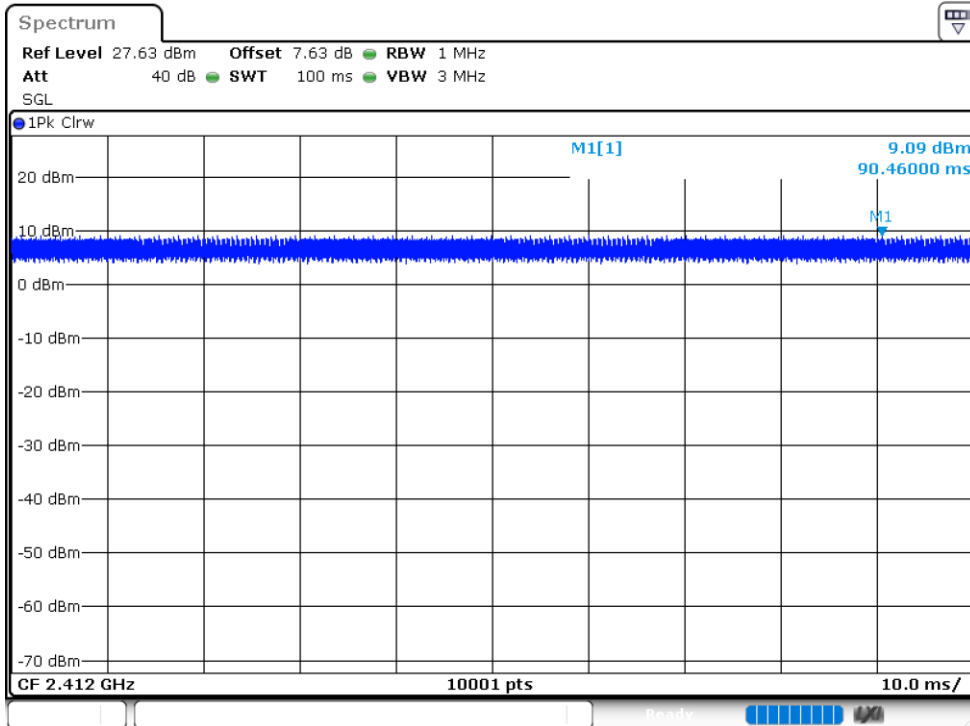

### Duty Cycle NVNT 802.11n(HT20) 2437MHz

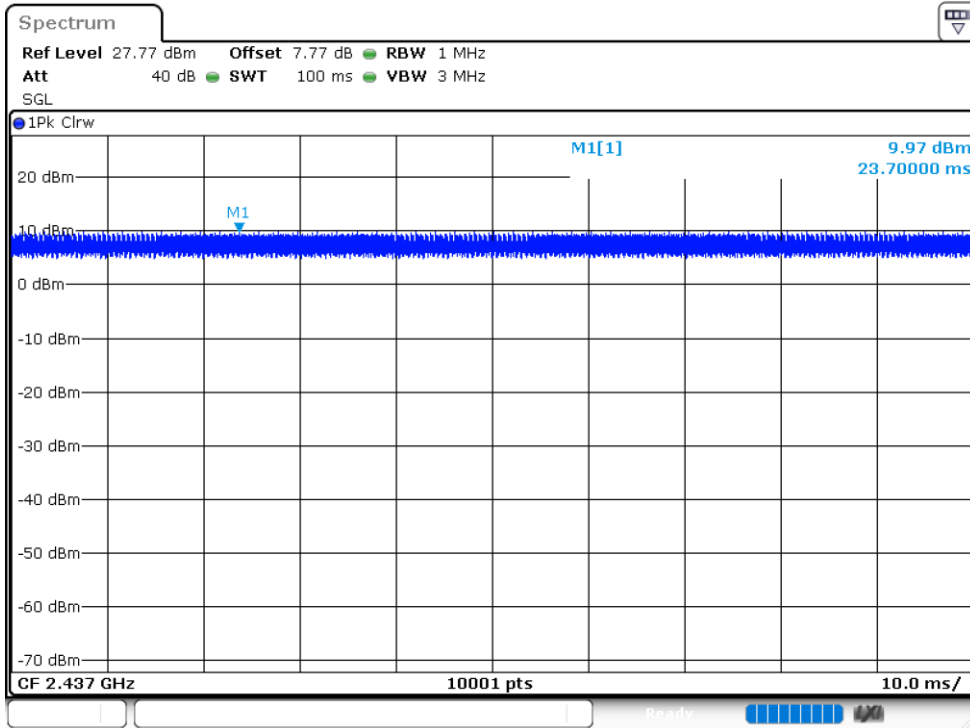

### Duty Cycle NVNT 802.11n(HT20) 2462MHz

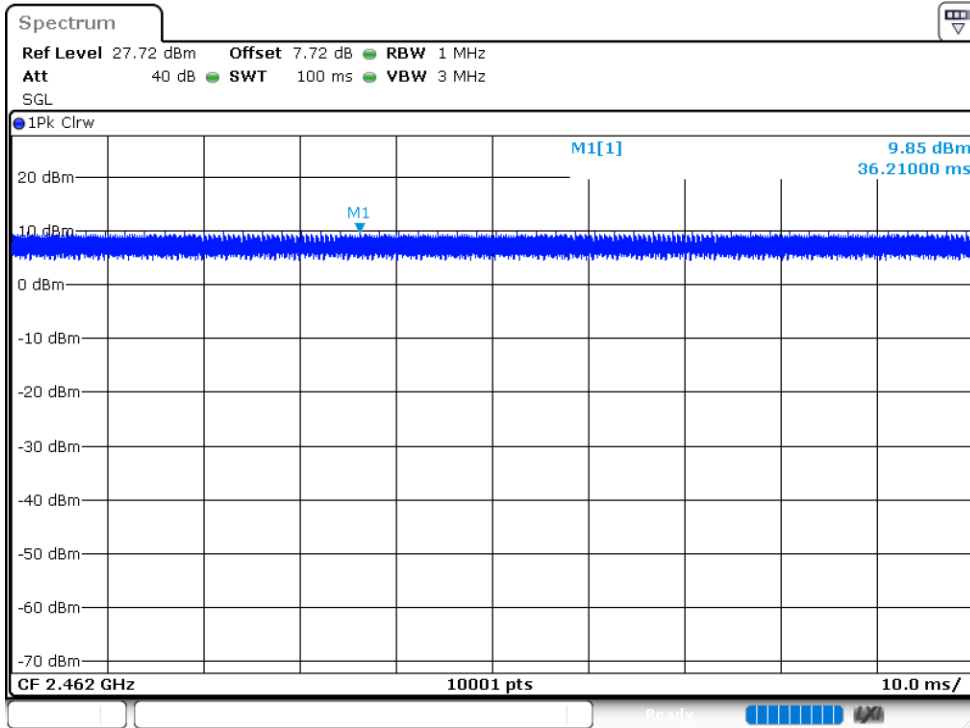

### Duty Cycle NVNT 802.11n(HT40) 2422MHz

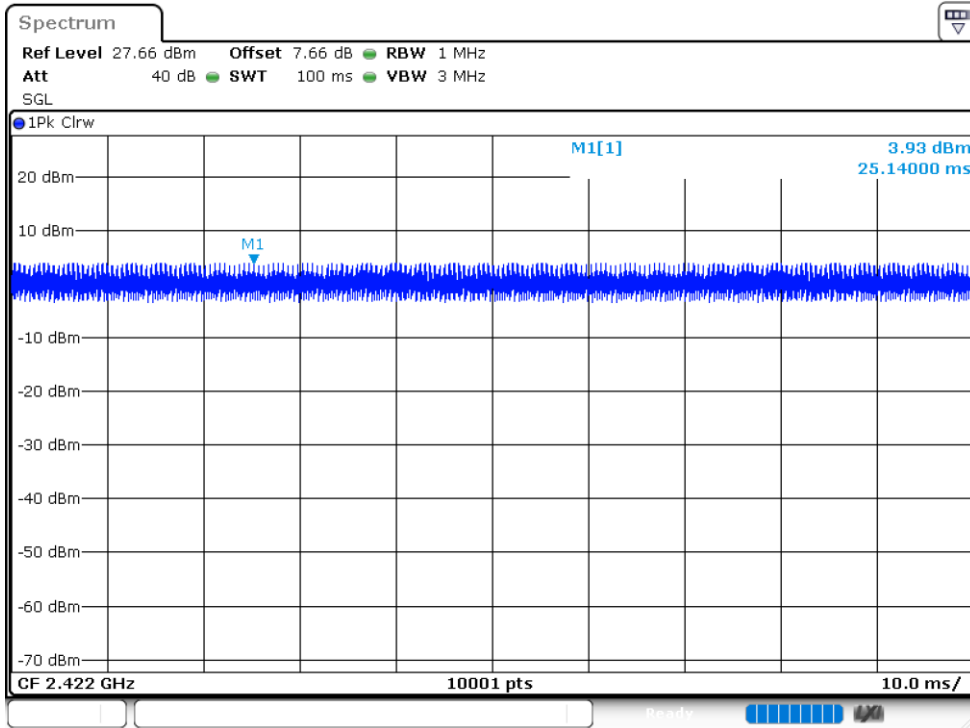

### Duty Cycle NVNT 802.11n(HT40) 2437MHz

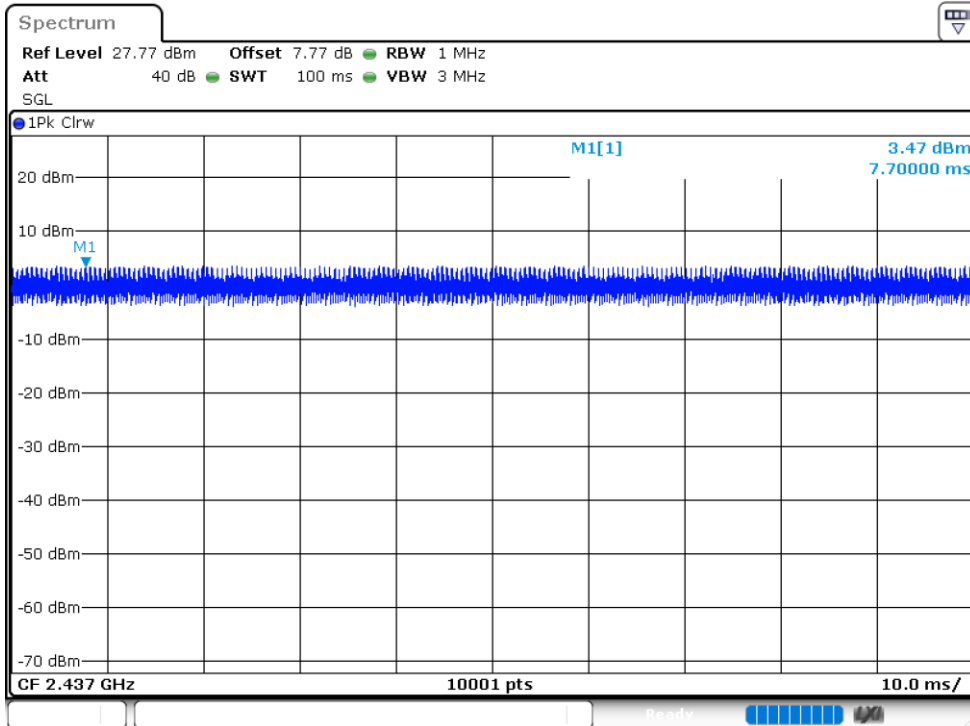

Duty Cycle NVNT 802.11n(HT40) 2452MHz

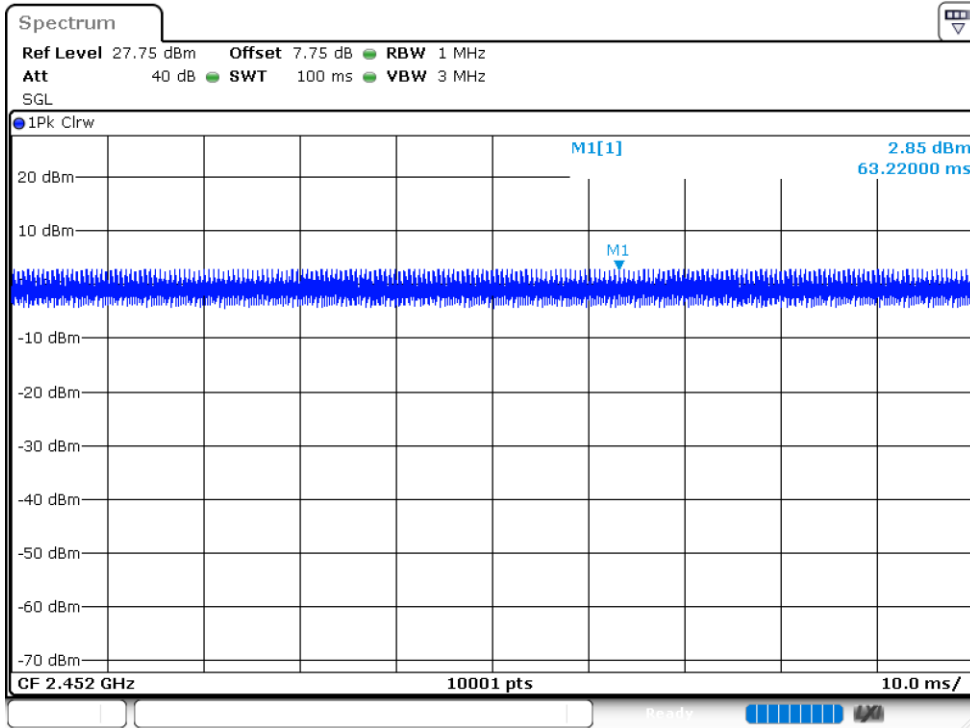

**8.2 MAXIMUM CONDUCTED OUTPUT POWER**

Condition	Mode	Frequency (MHz)	Antenna	Conducted Power (dBm)	Duty Factor (dB)	Total Power (dBm)	Limit (dBm)	Verdict
NVNT	802.11b	2412	Ant 1	16.728	0	16.728	30	Pass
NVNT	802.11b	2437	Ant 1	16.391	0	16.391	30	Pass
NVNT	802.11b	2462	Ant 1	15.646	0	15.646	30	Pass
NVNT	802.11g	2412	Ant 1	12.854	0	12.854	30	Pass
NVNT	802.11g	2437	Ant 1	13.483	0	13.483	30	Pass
NVNT	802.11g	2462	Ant 1	13.263	0	13.263	30	Pass
NVNT	802.11n(HT20)	2412	Ant 1	12.681	0	12.681	30	Pass
NVNT	802.11n(HT20)	2437	Ant 1	13.303	0	13.303	30	Pass
NVNT	802.11n(HT20)	2462	Ant 1	12.854	0	12.854	30	Pass
NVNT	802.11n(HT40)	2422	Ant 1	12.755	0	12.755	30	Pass
NVNT	802.11n(HT40)	2437	Ant 1	13.081	0	13.081	30	Pass
NVNT	802.11n(HT40)	2452	Ant 1	12.622	0	12.622	30	Pass

**8.3 OCCUPIED CHANNEL BANDWIDTH**

Condition	Mode	Frequency (MHz)	Antenna	99% OBW (MHz)	-6 dB Bandwidth (MHz)	Limit -6 dB Bandwidth (MHz)	Verdict
NVNT	802.11b	2412	Ant 1	12.516	9.56	0.5	Pass
NVNT	802.11b	2437	Ant 1	12.48	9.108	0.5	Pass
NVNT	802.11b	2462	Ant 1	12.4	9.124	0.5	Pass
NVNT	802.11g	2412	Ant 1	16.38	16.4	0.5	Pass
NVNT	802.11g	2437	Ant 1	16.388	16.348	0.5	Pass
NVNT	802.11g	2462	Ant 1	16.38	16.328	0.5	Pass
NVNT	802.11n(HT20)	2412	Ant 1	17.58	17.664	0.5	Pass
NVNT	802.11n(HT20)	2437	Ant 1	17.56	17.58	0.5	Pass
NVNT	802.11n(HT20)	2462	Ant 1	17.536	17.56	0.5	Pass
NVNT	802.11n(HT40)	2422	Ant 1	35.656	32.552	0.5	Pass
NVNT	802.11n(HT40)	2437	Ant 1	35.88	36.336	0.5	Pass
NVNT	802.11n(HT40)	2452	Ant 1	35.832	36.304	0.5	Pass

OBW NVNT 802.11b 2412MHz Ant1

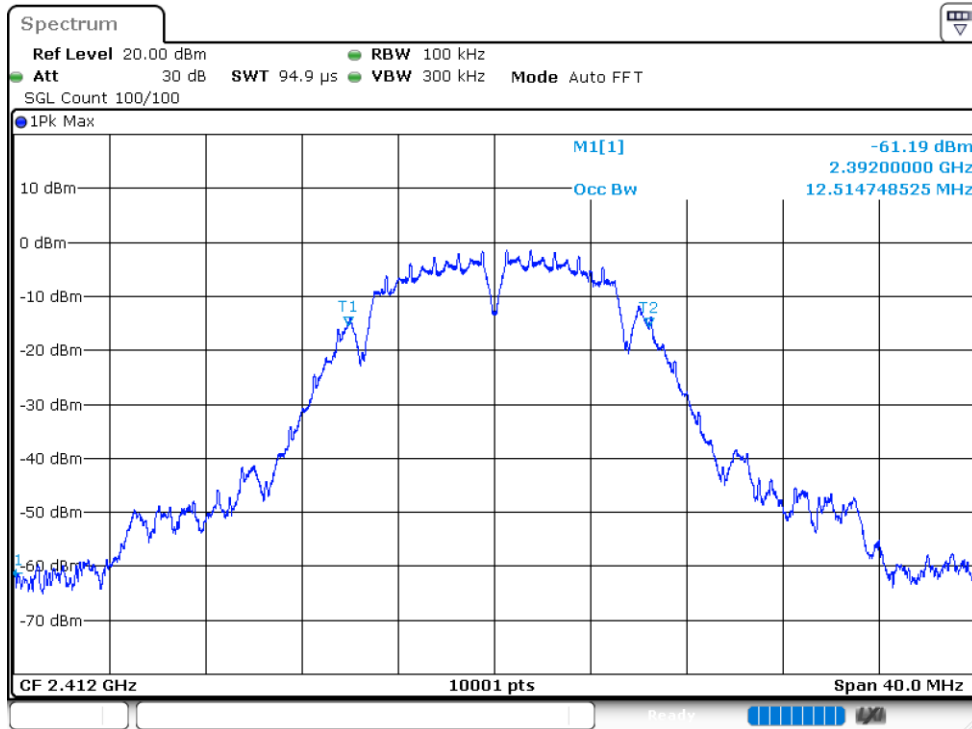



OBW NVNT 802.11b 2437MHz Ant1

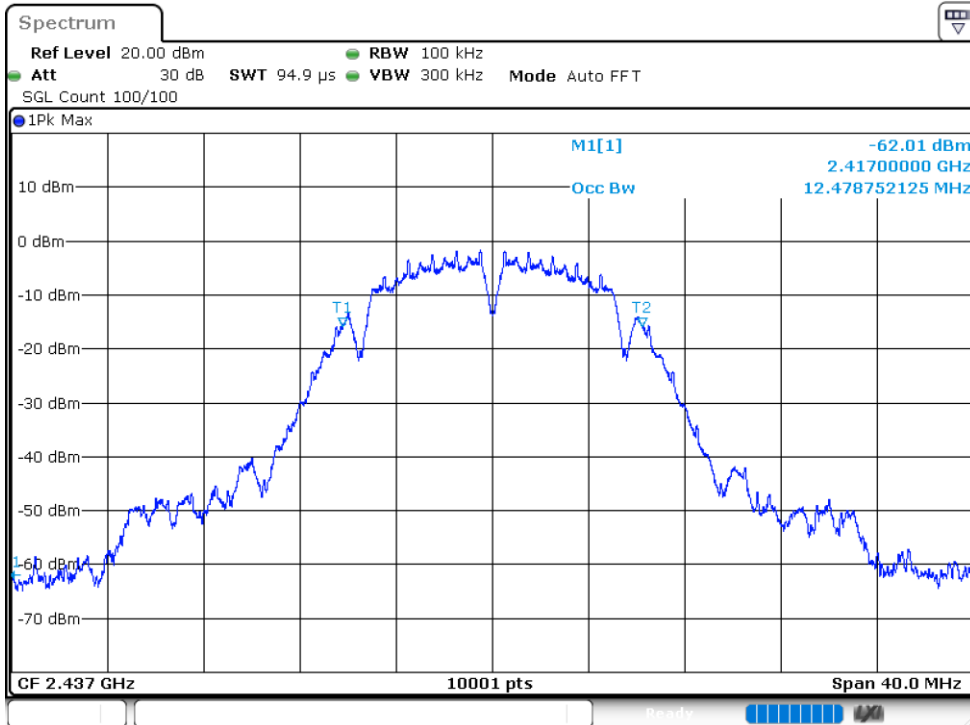

OBW NVNT 802.11b 2462MHz Ant1

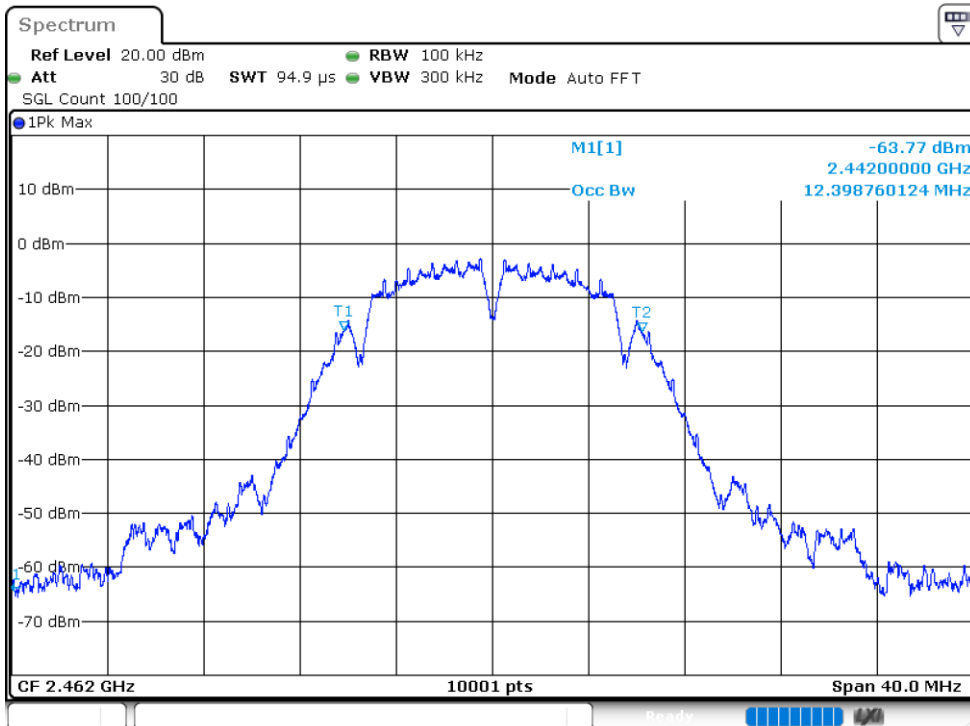

OBW NVNT 802.11g 2412MHz Ant1

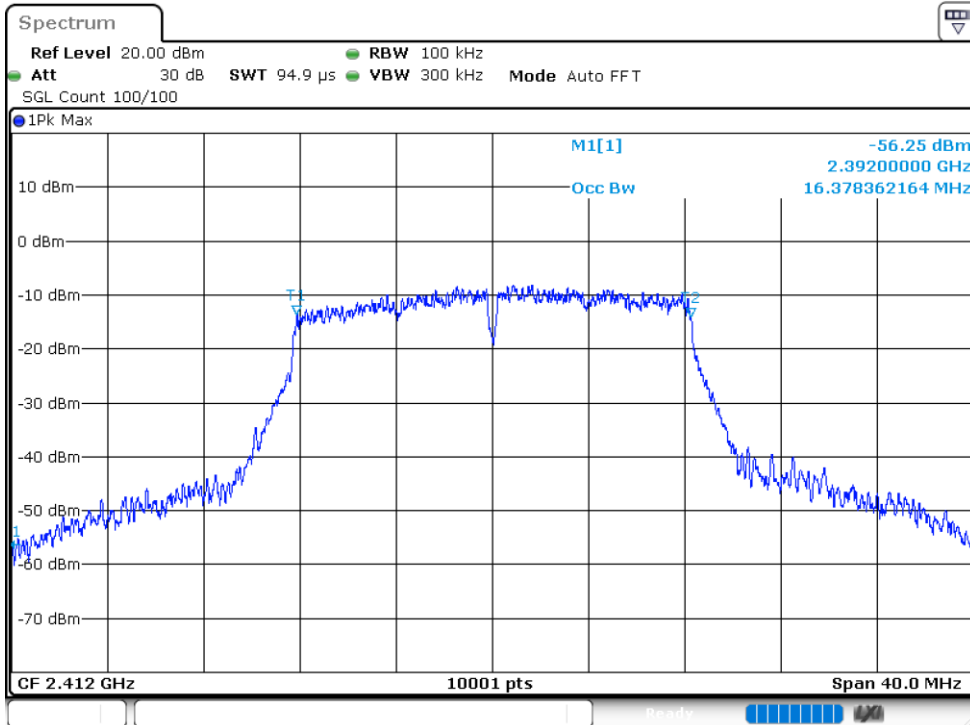

OBW NVNT 802.11g 2437MHz Ant1

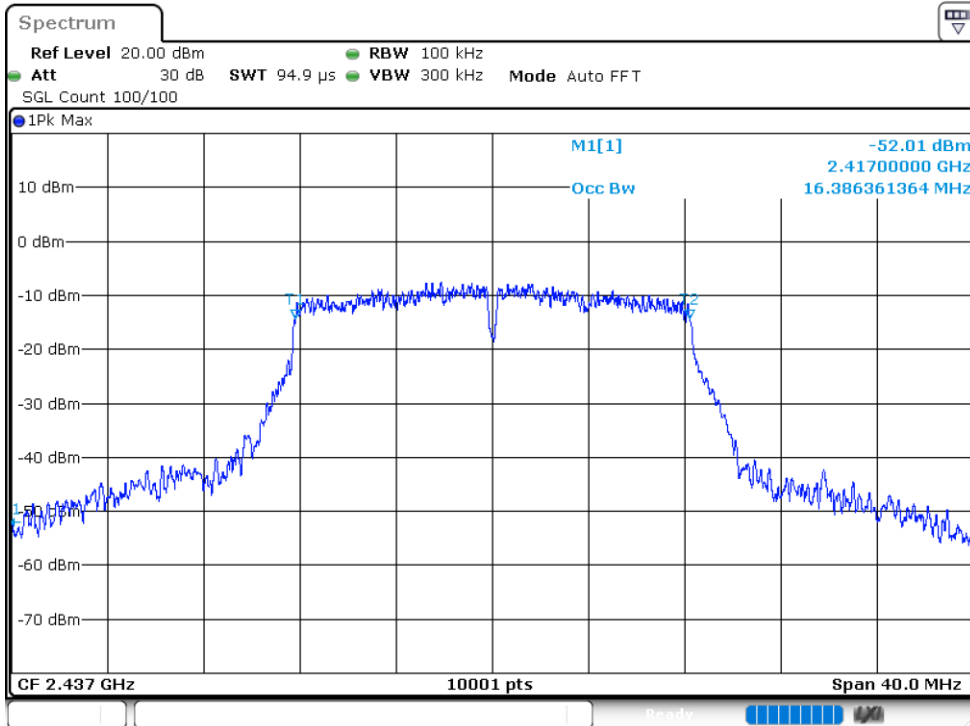

OBW NVNT 802.11g 2462MHz Ant1

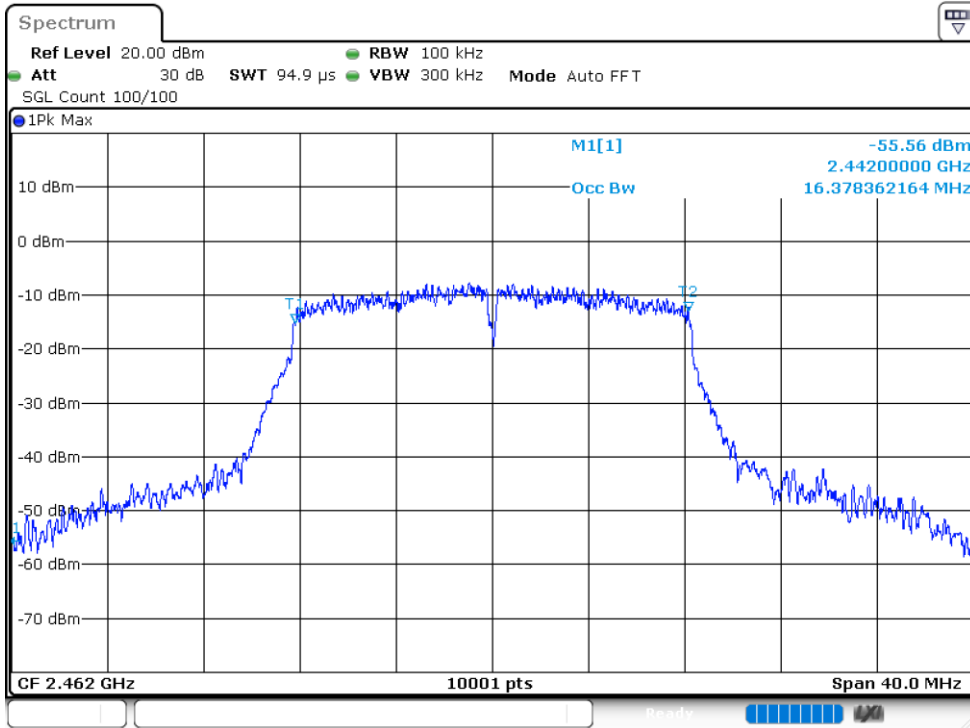

OBW NVNT 802.11n(HT20) 2412MHz Ant1

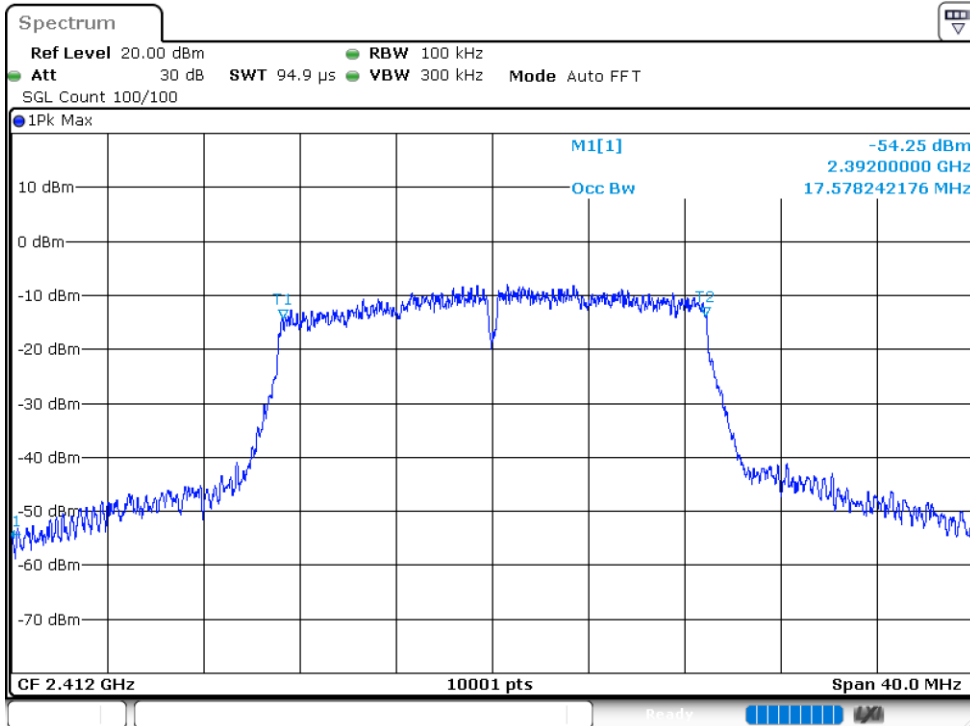

OBW NVNT 802.11n(HT20) 2437MHz Ant1

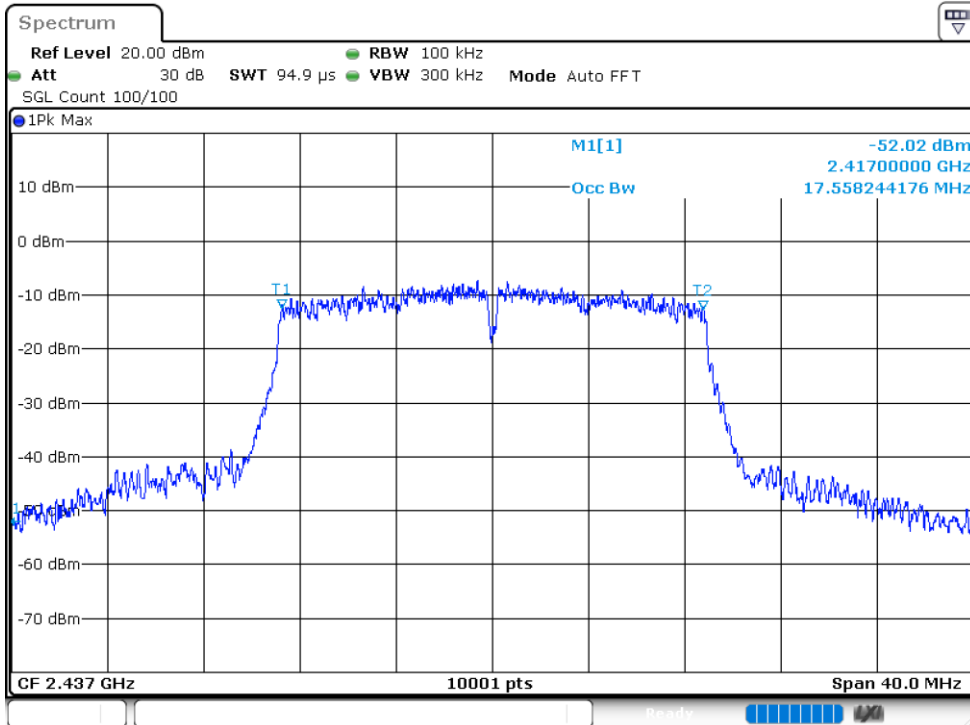

OBW NVNT 802.11n(HT20) 2462MHz Ant1

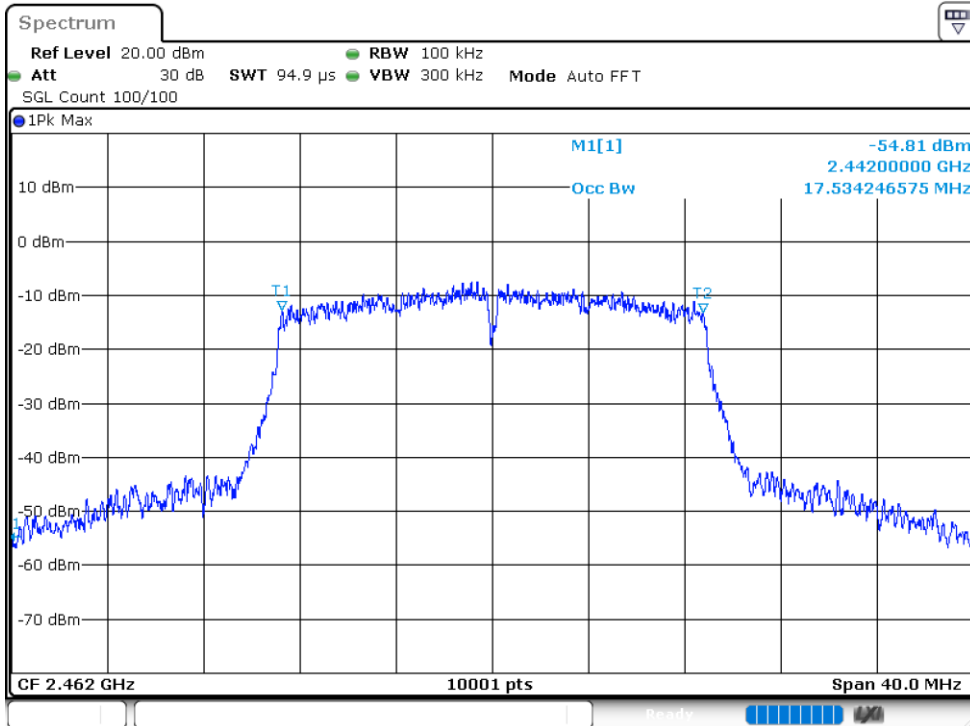

OBW NVNT 802.11n(HT40) 2422MHz Ant1

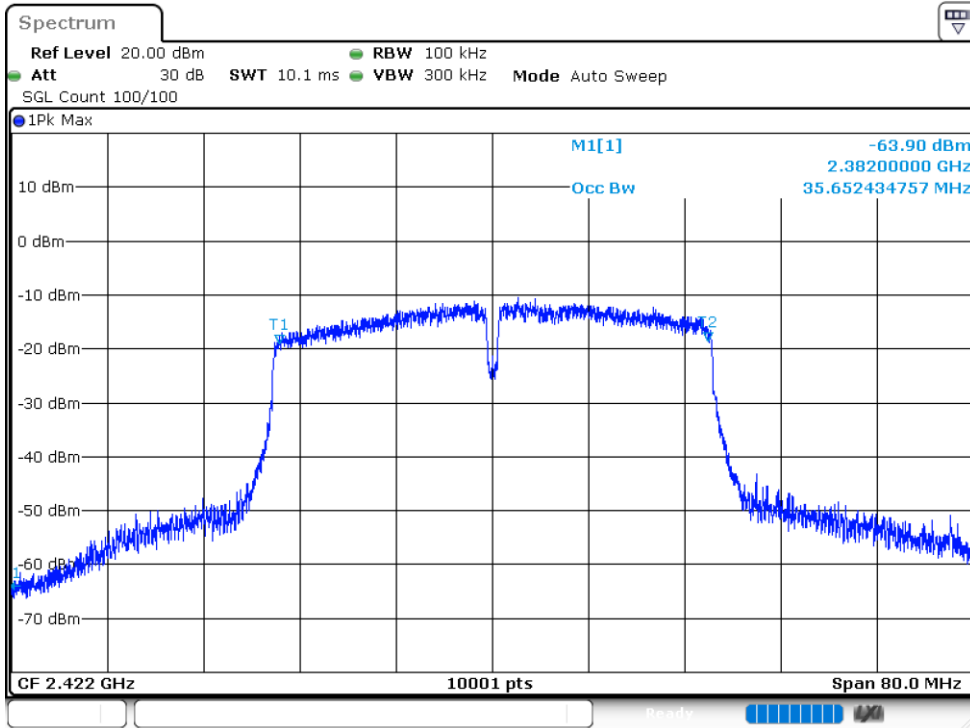

OBW NVNT 802.11n(HT40) 2437MHz Ant1

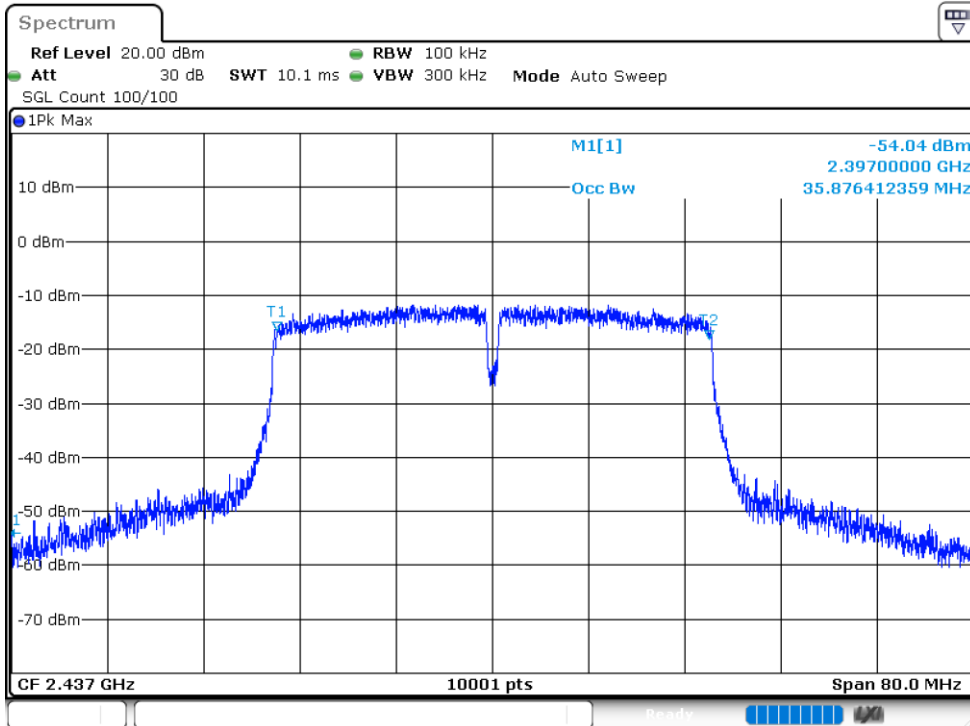

OBW NVNT 802.11n(HT40) 2452MHz Ant1

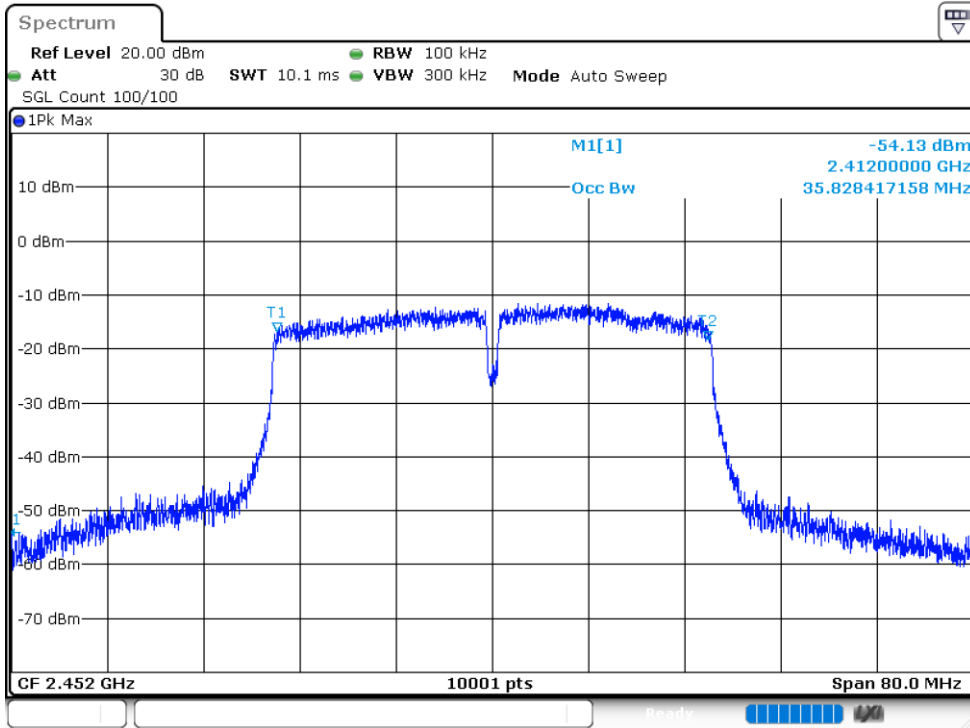

8.4 MAXIMUM POWER SPECTRAL DENSITY LEVEL

Condition	Mode	Frequency (MHz)	Antenna	Max PSD (dBm/3kHz)	Limit (dBm/3kHz)	Verdict
NVNT	802.11b	2412	Ant 1	-12.011	8	Pass
NVNT	802.11b	2437	Ant 1	-12.241	8	Pass
NVNT	802.11b	2462	Ant 1	-12.772	8	Pass
NVNT	802.11g	2412	Ant 1	-14.966	8	Pass
NVNT	802.11g	2437	Ant 1	-13.767	8	Pass
NVNT	802.11g	2462	Ant 1	-13.753	8	Pass
NVNT	802.11n(HT20)	2412	Ant 1	-14.776	8	Pass
NVNT	802.11n(HT20)	2437	Ant 1	-13.795	8	Pass
NVNT	802.11n(HT20)	2462	Ant 1	-14.157	8	Pass
NVNT	802.11n(HT40)	2422	Ant 1	-15.911	8	Pass
NVNT	802.11n(HT40)	2437	Ant 1	-15.032	8	Pass
NVNT	802.11n(HT40)	2452	Ant 1	-16.243	8	Pass

PSD NVNT 802.11b 2412MHz Ant1

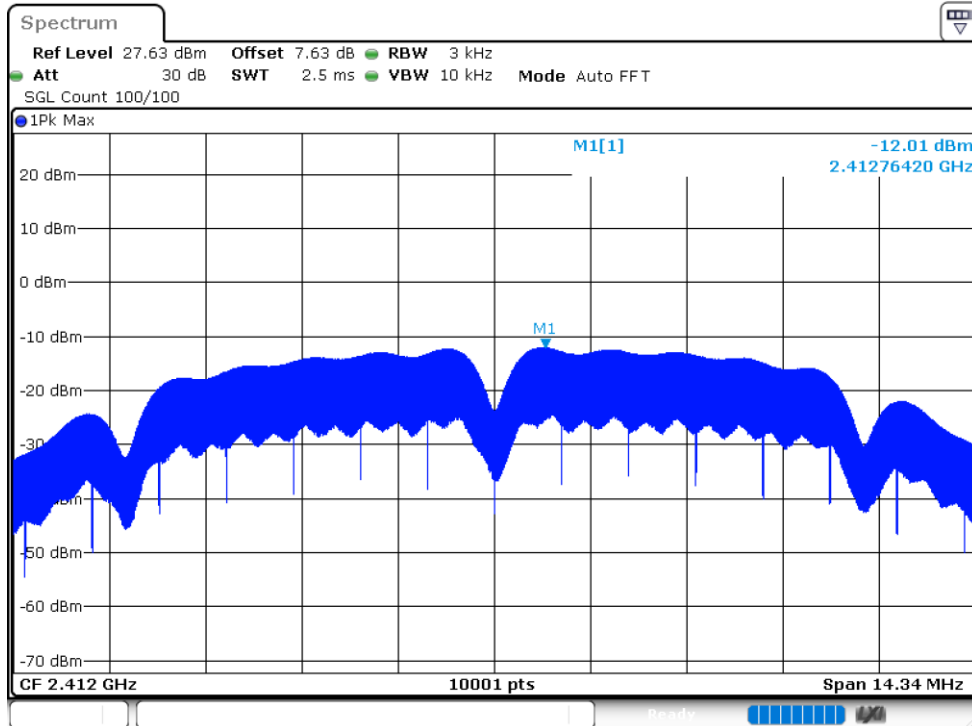

PSD NVNT 802.11b 2437MHz Ant1

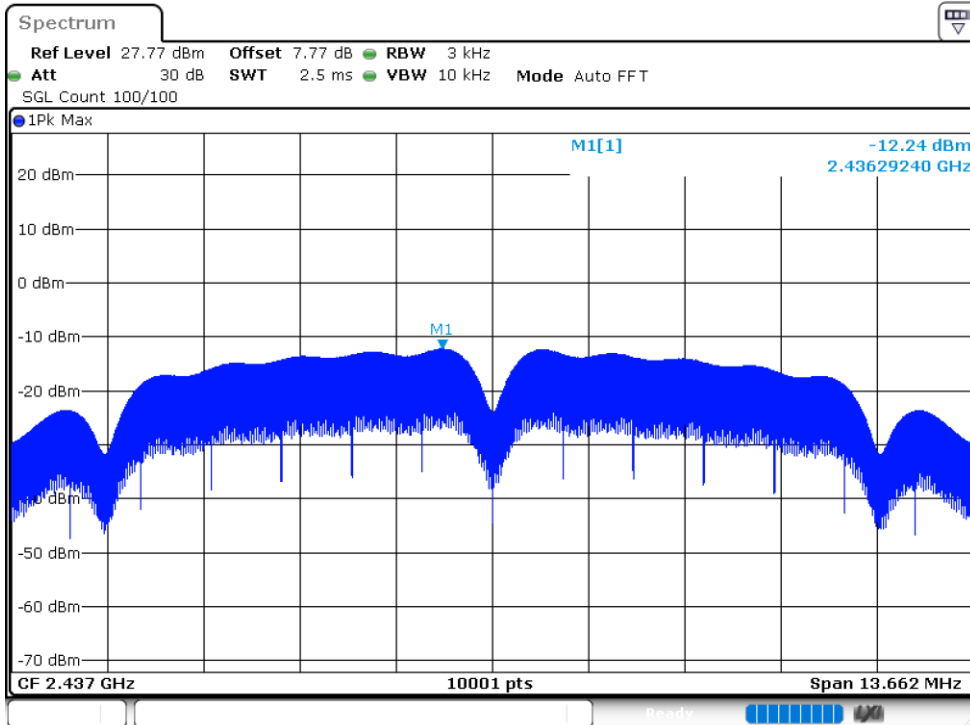

PSD NVNT 802.11b 2462MHz Ant1

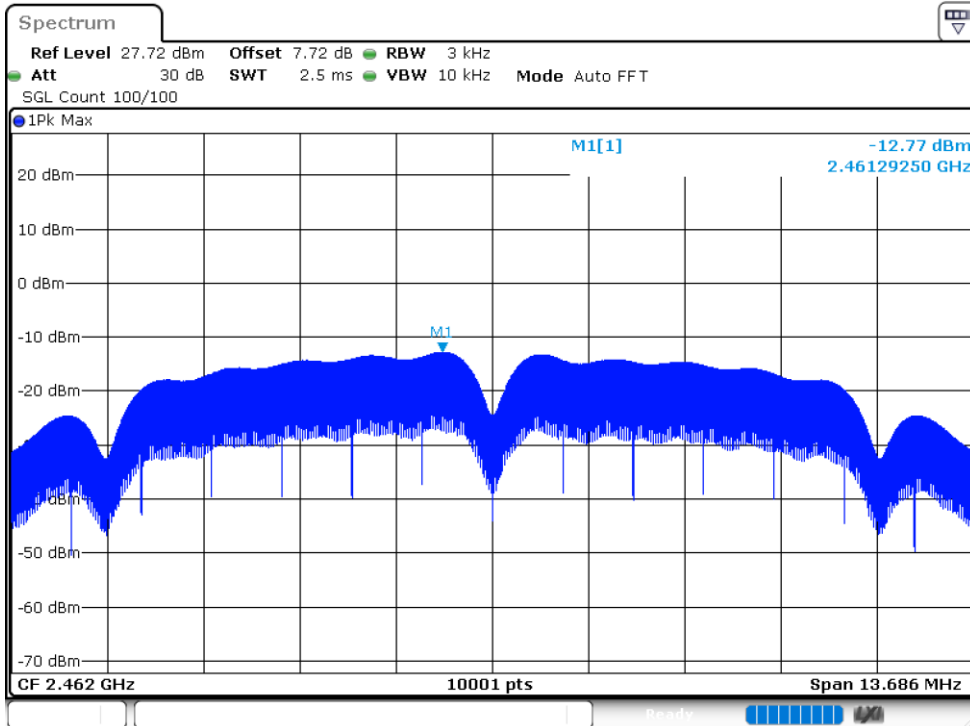



### PSD NVNT 802.11g 2412MHz Ant1

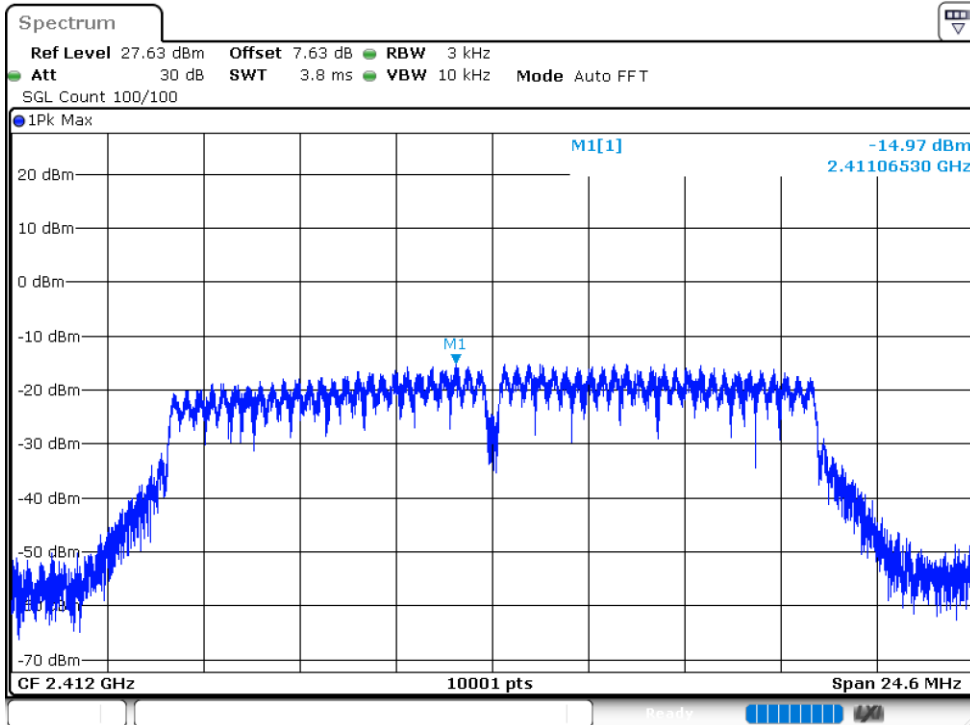

### PSD NVNT 802.11g 2437MHz Ant1

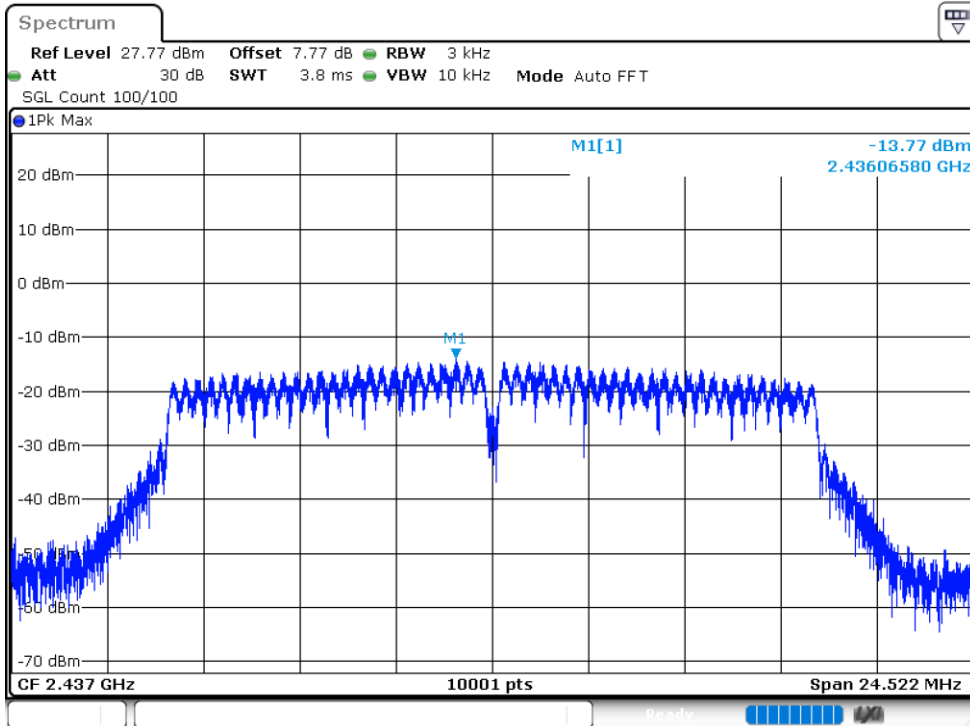

### PSD NVNT 802.11g 2462MHz Ant1

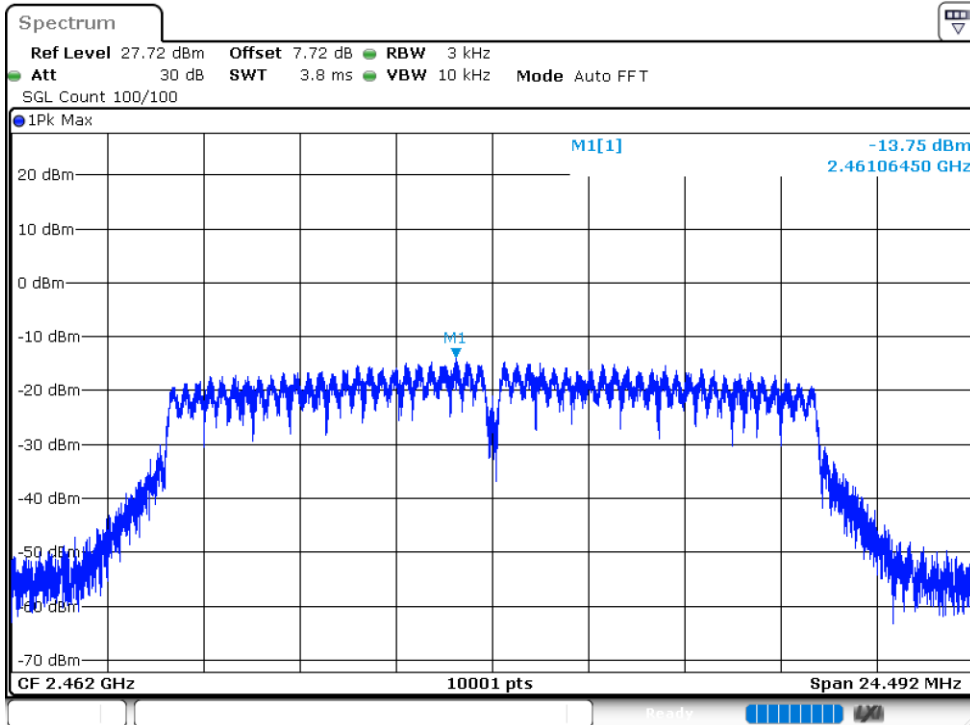

### PSD NVNT 802.11n(HT20) 2412MHz Ant1

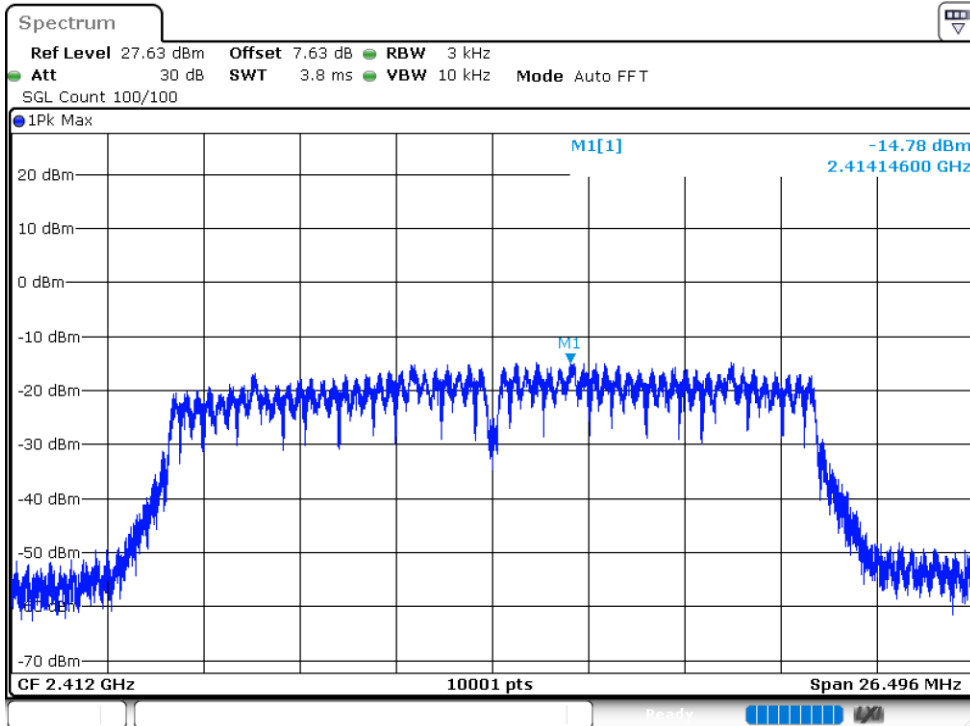

PSD NVNT 802.11n(HT20) 2437MHz Ant1

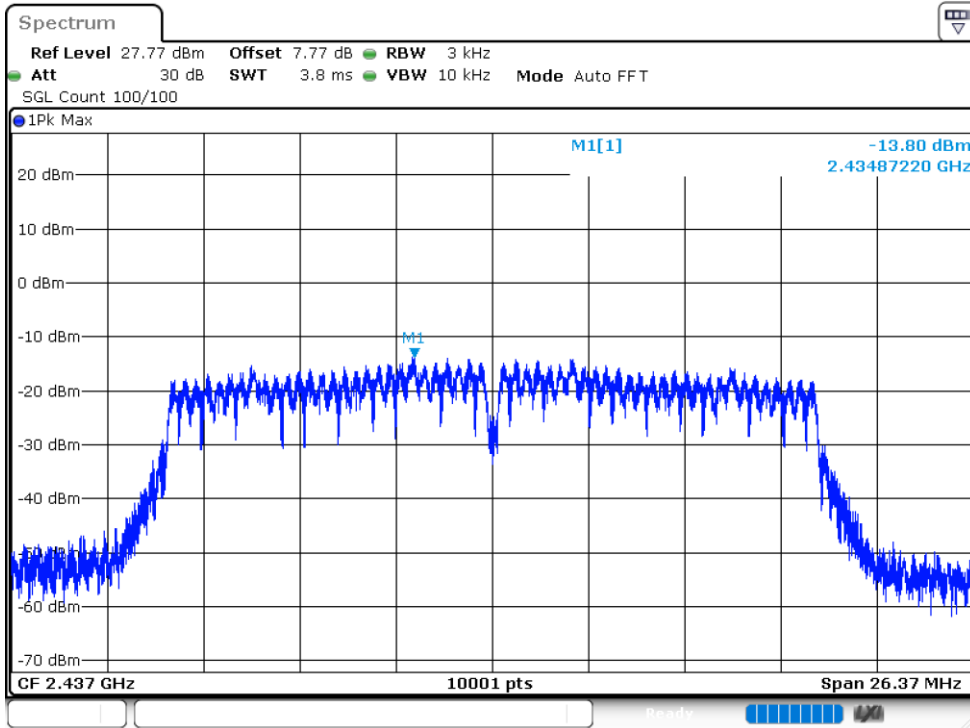

PSD NVNT 802.11n(HT20) 2462MHz Ant1

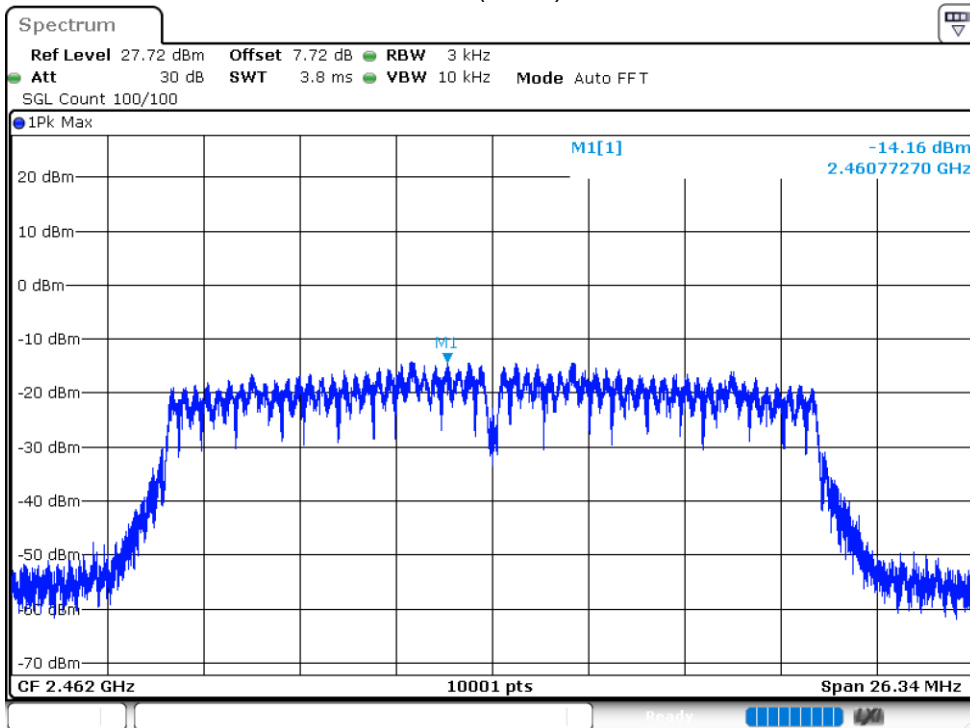

PSD NVNT 802.11n(HT40) 2422MHz Ant1

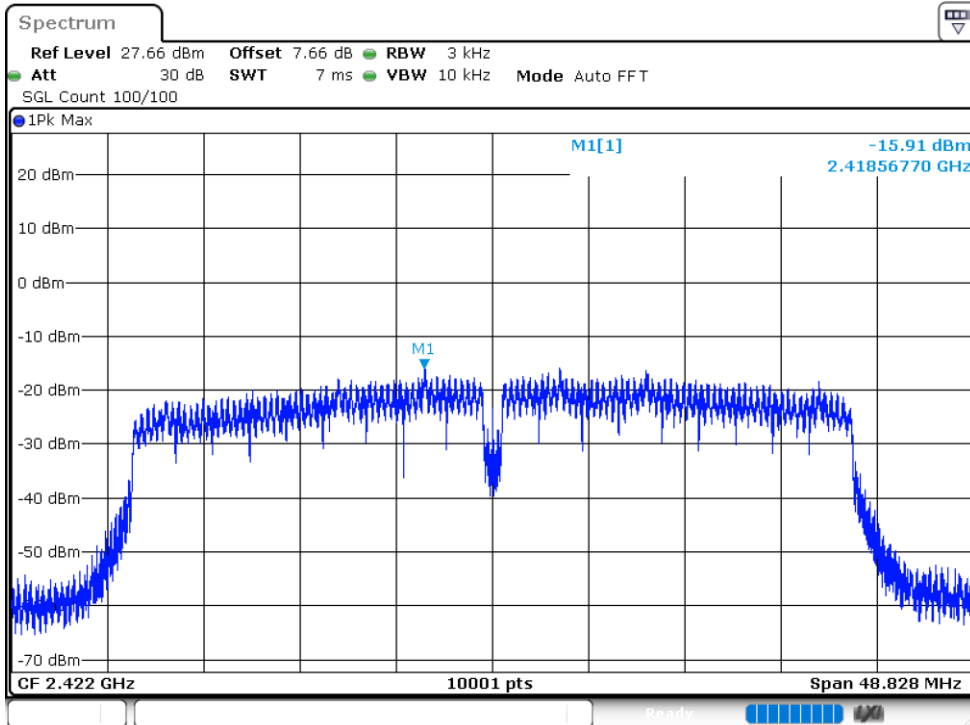

PSD NVNT 802.11n(HT40) 2437MHz Ant1

