

**FCC 47 CFR PART 15 SUBPART C**

**CERTIFICATION TEST REPORT**

*For*

**SuperNote**

**MODEL No.: SN-A6**

**FCC ID: 2AQZ9-SNA6**

**Trade Mark: N/A**

**REPORT NO:ES190610019W02**

**ISSUE DATE: July 15, 2019**

*Prepared for*

**Shanghai Ratta Smart technology Co.,Ltd**

**Room 301, Building No.1,168 Jixin Road, Minhang, Shanghai, China**

*Prepared by*

**EMTEK(SHENZHEN) CO., LTD.**

**Bldg 69, Majialong Industry Zone, NanshanDistrict,Shenzhen,  
Guangdong, China**

**TEL: 86-755-26954280**

**FAX: 86-755-26954282**

**Table of Contents**

1 TEST RESULT CERTIFICATION ..... 3

2 EUT TECHNICAL DESCRIPTION..... 4

3 SUMMARY OF TEST RESULT ..... 5

4 TEST METHODOLOGY ..... 6

    4.1 GENERAL DESCRIPTION OF APPLIED STANDARDS..... 6

    4.2 MEASUREMENT EQUIPMENT USED ..... 6

    4.3 DESCRIPTION OF TEST MODES..... 8

5 FACILITIES AND ACCREDITATIONS ..... 9

    5.1 FACILITIES ..... 9

    5.2 LABORATORY ACCREDITATIONS AND LISTINGS ..... 9

6 TEST SYSTEM UNCERTAINTY ..... 10

7 SETUP OF EQUIPMENT UNDER TEST ..... 11

    7.1 RADIO FREQUENCY TEST SETUP 1..... 11

    7.2 RADIO FREQUENCY TEST SETUP 2..... 11

    7.3 CONDUCTED EMISSION TEST SETUP..... 12

    7.4 SUPPORT EQUIPMENT ..... 13

8 FREQUENCY HOPPING SYSTEM REQUIREMENTS ..... 14

    8.1 STANDARD APPLICABLE ..... 14

    8.2 EUT PSEUDORANDOM FREQUENCY HOPPING SEQUENCE ..... 14

    8.3 EQUAL HOPPING FREQUENCY USE..... 15

    8.4 FREQUENCY HOPPING SYSTEM..... 15

9 TEST REQUIREMENTS..... 16

    9.1 20DB BANDWIDTH ..... 16

    9.2 CARRIER FREQUENCY SEPARATION..... 22

    9.3 NUMBER OF HOPPING FREQUENCIES ..... 28

    9.4 AVERAGE TIME OF OCCUPANCY (DWELL TIME) ..... 30

    9.5 MAXIMUM PEAK CONDUCTED OUTPUT POWER ..... 33

    9.6 CONDUCTED SUPRIOUS EMISSION ..... 39

    9.7 RADIATED SPURIOUS EMISSION..... 46

    9.8 CONDUCTED EMISSION TEST..... 59

    9.9 ANTENNA APPLICATION..... 62

# 1 TEST RESULT CERTIFICATION

|                      |   |
|----------------------|---|
| Applicant:           | Shanghai Ratta Smart technology Co.,Ltd<br>Room 301, Building No.1,168 Jixin Road, Minhang, Shanghai, China |
| Manufacturer:        | Shanghai Ratta Smart technology Co.,Ltd<br>Room 301, Building No.1,168 Jixin Road, Minhang, Shanghai, China |
| Factory:             | Group Sense Ltd<br>Cai Wu Industrial Park, Wusha, Chang An, Dongguan, P.R.C                                 |
| Product Description: | SuperNote   |
| Model Number:        | SN-A6   |
| Trade Mark:          | N/A   |
| File Number:         | ES190610019W02  |

Measurement Procedure Used:

| APPLICABLE STANDARDS  |             |
|---|-------------|
| STANDARD  | TEST RESULT |
| FCC 47 CFR Part 2 2018, Subpart J<br>FCC 47 CFR Part 15 2018, Subpart C | PASS        |

The above equipment was tested by EMTEK(SHENZHEN) CO., LTD.The test data, data evaluation, test procedures, and equipment configurations shown in this report were made in accordance with the procedures given in ANSI C63.10 (2013) and the energy emitted by the sample EUT tested as described in this report is in compliance with the requirements of FCC Rules Part 2 2018 and Part 15.247 2018

The test results of this report relate only to the tested sample identified in this report.

Date of Test : June 10, 2019 to July 15, 2019

Prepared by: *Yaping Shen*  
Yaping Shen/Editor

Reviewer: *Joe Xia*  
Joe Xia/Supervisor

Approve & Authorized Signer : *[Signature]*  
Lisa Wang/Manager



## 2 EUT TECHNICAL DESCRIPTION

| Characteristics           | Description   |
|---------------------------|---|
| Device Type               | Bluetooth with classic mode   |
| Data Rate                 | 1Mbps for GFSK modulation<br>2Mbps for pi/4-DQPSK modulation<br>3 Mbps for 8DPSK modulation |
| Modulation                | GFSK modulation (1Mbps)<br>pi/4-DQPSK modulation (2Mbps)<br>8DPSK modulation (3Mbps)        |
| Operating Frequency Range | 2402-2480MHz for BT   |
| Number of Channels        | 79 channels for BT  |
| Max Transmit Power        | 2.874 dBm for BT  |
| Antenna Type              | FPC antenna for BT  |
| Gain                      | 0.37 dbi  |
| Power Rating              | DC 5V from external power or DC 3.8V by battery   |
| Temperature Range         | -10°C ~ +55°C   |

**Note:** for more details, please refer to the User's manual of the EUT.

### 3 SUMMARY OF TEST RESULT

| FCC PartClause              | Test Parameter                         | Verdict | Remark |
|-----------------------------|--|---------|--------|
| 15.247(a)(1)                | 20 dB Bandwidth                        | PASS    |        |
| 15.247(a)(1)                | Carrier Frequency Separation           | PASS    |        |
| 15.247(a)(1)                | Number of Hopping Frequencies          | PASS    |        |
| 15.247(a)(1)                | Average Time of Occupancy (Dwell Time) | PASS    |        |
| 15.247(b)(1)                | Maximum Peak Conducted Output Power    | PASS    |        |
| 15.247(c)                   | Conducted Spurious Emissions           | PASS    |        |
| 15.247(d)<br>15.209         | Radiated Spurious Emissions            | PASS    |        |
| 15.207                      | Conducted Emission                     | PASS    |        |
| 15.203                      | Antenna Application                    | PASS    |        |
| NOTE 1:N/A (Not Applicable) |  |         |        |

RELATED SUBMITTAL(S) / GRANT(S):

This submittal(s) (test report) is intended for FCC ID: 2AQZ9-SNA6 filing to comply with Section 15.247 of the FCC Part 15, Subpart C.

## 4 TEST METHODOLOGY

### 4.1 GENERAL DESCRIPTION OF APPLIED STANDARDS

According to its specifications, the EUT must comply with the requirements of the following standards:  
 FCC 47 CFR Part 2, Subpart J  
 FCC 47 CFR Part 15, Subpart C  
 DA 00-705

### 4.2 MEASUREMENT EQUIPMENT USED

#### 4.2.1 Conducted Emission Test Equipment

| EQUIPMENT TYPE     | MFR             | MODEL NUMBER | SERIAL NUMBER | LAST CAL.  | DUE CAL.   |
|--------------------|-----------------|--------------|---------------|------------|------------|
| Test Receiver      | Rohde & Schwarz | ESCS30       | 828985/018    | 05/18/2019 | 05/17/2020 |
| L.I.S.N.           | Schwarzbeck     | NNLK8129     | 8129203       | 05/18/2019 | 05/17/2020 |
| 50Ω Coaxial Switch | Anritsu         | MP59B        | M20531        | 05/18/2019 | 05/17/2020 |
| Pulse Limiter      | Rohde & Schwarz | ESH3-Z2      | 100006        | 05/18/2019 | 05/17/2020 |
| Voltage Probe      | Rohde & Schwarz | TK9416       | N/A           | 05/18/2019 | 05/17/2020 |
| I.S.N              | Rohde & Schwarz | ENY22        | 1109.9508.02  | 05/18/2019 | 05/17/2020 |

#### 4.2.2 Radiated Emission Test Equipment

| Equipment         | Manufacturer    | Model No. | Serial No.   | Last Cal.  | DUE CAL.   |
|-------------------|-----------------|-----------|--------------|------------|------------|
| EMI Test Receiver | Rohde & Schwarz | ESU       | 1302.6005.26 | 05/18/2019 | 05/17/2020 |
| Pre-Amplifier     | HP              | 8447F     | 2944A07999   | 05/18/2019 | 05/17/2020 |
| Bilog Antenna     | Schwarzbeck     | VULB9163  | 142          | 05/18/2019 | 05/17/2020 |
| Cable             | Schwarzbeck     | AK9513    | ACRX1        | 05/18/2019 | 05/17/2020 |
| Cable             | Rosenberger     | N/A       | FP2RX2       | 05/18/2019 | 05/17/2020 |
| Cable             | Schwarzbeck     | AK9513    | CRPX1        | 05/18/2019 | 05/17/2020 |
| Cable             | Schwarzbeck     | AK9513    | CRRX2        | 05/18/2019 | 05/17/2020 |

#### 4.2.3 For 3m Radiated Emission Measurement 1G-18G (3m chamber 1#)

| Equipment         | Manufacturer    | Model No.          | Serial No.   | Last Cal.  | DUE CAL.   |
|-------------------|-----------------|--------------------|--------------|------------|------------|
| EMI Test Receiver | Rohde & Schwarz | ESU                | 1302.6005.26 | 05/18/2019 | 05/17/2020 |
| Pre-Amplifier     | A.H.            | PAM-0126           | 1415261      | 05/18/2019 | 05/17/2020 |
| Horn Antenna      | Schwarzbeck     | BBHA 9120          | 707          | 05/18/2019 | 05/17/2020 |
| Cable             | H+B             | 0.5M<br>SF104-26.5 | 289147/4     | 05/18/2019 | 05/17/2020 |
| Cable             | H+B             | 3M<br>SF104-26.5   | 295838/4     | 05/18/2019 | 05/17/2020 |
| Cable             | H+B             | 6M<br>SF104-26.5   | 295840/4     | 05/18/2019 | 05/17/2020 |

**4.2.4 For 3m Radiated Emission Measurement 18G-26.5G (3m chamber 1#)**

| Equipment         | Manufacturer    | Model No.          | Serial No.   | Last Cal.  | Cal. Interval |
|-------------------|-----------------|--------------------|--------------|------------|---------------|
| EMI Test Receiver | Rohde & Schwarz | ESU                | 1302.6005.26 | 05/18/2019 | 05/17/2020    |
| Pre-Amplifier     | A.H.            | PAM-0126           | 1415261      | 05/18/2019 | 05/17/2020    |
| Horn Antenna      | Schwarzbeck     | BBHA 9170          | BBHA9170399  | 05/18/2019 | 05/17/2020    |
| Cable             | H+B             | 0.5M<br>SF104-26.5 | 289147/4     | 05/18/2019 | 05/17/2020    |
| Cable             | H+B             | 3M<br>SF104-26.5   | 295838/4     | 05/18/2019 | 05/17/2020    |
| Cable             | H+B             | 6M<br>SF104-26.5   | 295840/4     | 05/18/2019 | 05/17/2020    |

**4.2.5 Radio Frequency Test Equipment**

| EQUIPMENT TYPE    | MFR     | MODEL NUMBER | SERIAL NUMBER | LAST CAL.  | DUE CAL.   |
|-------------------|---------|--------------|---------------|------------|------------|
| Spectrum Analyzer | Agilent | E4407B       | 88156318      | 05/18/2019 | 05/17/2020 |
| Signal Analyzer   | Agilent | N9010A       | My53470879    | 05/18/2019 | 05/17/2020 |
| Power meter       | Anritsu | ML2495A      | 0824006       | 05/18/2019 | 05/17/2020 |
| Power sensor      | Anritsu | MA2411B      | 0738172       | 05/18/2019 | 05/17/2020 |

*Remark: Each piece of equipment is scheduled for calibration once a year.*

**4.3 SUPPORT EQUIPMENT**

| Item | Equipment | Mfr/Brand | Model/Type No. | Note       |
|------|-----------|-----------|----------------|------------|
| 1.   | Notebook  | Lenovo    | WB0205140E     | WB06355728 |

**Notes:**

1. All the equipment/cables were placed in the worst-case configuration to maximize the emission during the test.
2. Grounding was established in accordance with the manufacturer's requirements and conditions for the intended use.

#### 4.4 DESCRIPTION OF TEST MODES

The EUT has been tested under its typical operating condition.

The EUT configuration for testing is installed on RF field strength measurement to meet the Commissions requirement and operating in a manner which intends to maximize its emission characteristics in a continuous normal application.

The Transmitter was operated in the normal operating mode. The TX frequency was fixed which was for the purpose of the measurements.

Test of channel included the lowest and middle and highest frequency to perform the test, then record on this report.

Those data rates (1Mbps for Bluetooth GFSK modulation; 2Mbps for Bluetooth pi/4-DQPSK modulation; 3Mbps for Bluetooth 8DPSK modulation) were used for all test.

Pre-defined engineering program for regulatory testing used to control the EUT for staying in continuous transmitting and receiving mode is programmed.

Frequency and Channel list for Bluetooth with classic mode

| Channel   | Frequency (MHz) | Channel | Frequency (MHz) | Channel | Frequency (MHz) |
|---|-----------------|---------|-----------------|---------|-----------------|
| 0   | 2402            | 39      | 2441            | ...     | ...             |
| 1   | 2403            | 40      | 2442            | 76      | 2478            |
| 2   | 2404            | 41      | 2443            | 77      | 2479            |
| ...   | ...             | ...     | ...             | 78      | 2480            |
| Note: $f_c = 2402\text{MHz} + (k-1) \times 1\text{MHz}$ k=1 to 79 |                 |         |                 |         |                 |

Test Frequency and channel for Bluetooth with classic mode

| Lowest Frequency |                 | Middle Frequency |                 | Highest Frequency |                 |
|------------------|-----------------|------------------|-----------------|-------------------|-----------------|
| Channel          | Frequency (MHz) | Channel          | Frequency (MHz) | Channel           | Frequency (MHz) |
| 0                | 2402            | 39               | 2441            | 78                | 2480            |



## 5 FACILITIES AND ACCREDITATIONS

### 5.1 FACILITIES

All measurement facilities used to collect the measurement data are located at

Bldg 69, Majialong Industry Zone District, Nanshan District, Shenzhen, China

The sites are constructed in conformance with the requirements of ANSI C63.7, ANSI C63.10 and CISPR Publication 22.

### 5.2 LABORATORY ACCREDITATIONS AND LISTINGS

Site Description

EMC Lab.

- : Accredited by CNAS, 2016.10.24  
The certificate is valid until 2022.10.28  
The Laboratory has been assessed and proved to be in compliance with CNAS-CL01: 2006(identical to ISO/IEC17025: 2005)  
The Certificate Registration Number is L2291
  
- : Accredited by TUV Rheinland Shenzhen, 2016.5.19  
The Laboratory has been assessed according to the requirements ISO/IEC 17025.
  
- :  
Accredited by FCC, August 06, 2018  
The certificate is valid until August 07, 2020  
Designation Number: CN1204  
Test Firm Registration Number: 882943
  
- Accredited by A2LA, July 31, 2017  
The Certificate Registration Number is 4321.01.
  
- : Accredited by Industry Canada, November 09, 2018  
The Conformity Assessment Body Identifier is CN0008.

## 6 TEST SYSTEM UNCERTAINTY

The following measurement uncertainty levels have been estimated for tests performed on the apparatus:

| Parameter                      | Uncertainty               |
|--------------------------------|---------------------------|
| Radio Frequency                | $\pm 1 \times 10^{-5}$    |
| Maximum Peak Output Power Test | $\pm 1.0\text{dB}$        |
| Conducted Emissions Test       | $\pm 2.0\text{dB}$        |
| Radiated Emission Test         | $\pm 2.0\text{dB}$        |
| Occupied Bandwidth Test        | $\pm 1.0\text{dB}$        |
| Band Edge Test                 | $\pm 3\text{dB}$          |
| All emission, radiated         | $\pm 3\text{dB}$          |
| Antenna Port Emission          | $\pm 3\text{dB}$          |
| Temperature                    | $\pm 0.5^{\circ}\text{C}$ |
| Humidity                       | $\pm 3\%$                 |

Measurement Uncertainty for a level of Confidence of 95%

## 7 SETUP OF EQUIPMENT UNDER TEST

### 7.1 RADIO FREQUENCY TEST SETUP 1

The Bluetooth component's antenna ports(s) of the EUT are connected to the measurement instrument per an appropriate attenuator. The EUT is controlled by PC/software to emit the specified signals for the purpose of measurements.

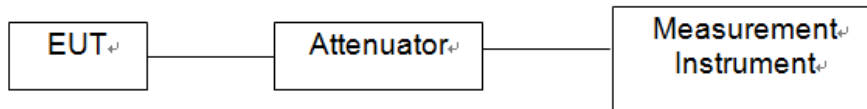

### 7.2 RADIO FREQUENCY TEST SETUP 2

The test site semi-anechoic chamber has met the requirement of NSA tolerance 4 dB according to the standards: ANSI C63.10. The test distance is 3m. The setup is according to the requirements in Section 13.1.4.1 of ANSI C63.10-2013 and CAN/CSA-CEI/IEC CISPR 22.

Below 30MHz:

The EUT is placed on a turntable 0.8 meters above the ground in the chamber, 3 meter away from the antenna (loop antenna). The Antenna should be positioned with its plane vertical at the specified distance from the EUT and rotated about its vertical axis for maximum response at each azimuth about the EUT. The center of the loop shall be 1 m above the ground. For certain applications, the loop antenna plane may also need to be positioned horizontally at the specified distance from the EUT.

30MHz-1GHz:

The EUT is placed on a turntable 0.8 meters above the ground in the chamber, 3 meter away from the antenna. The maximal emission value is acquired by adjusting the antenna height, polarisation and turntable azimuth. Normally, the height range of antenna is 1 m to 4 m, the azimuth range of turntable is 0° to 360°, and the receive antenna has two polarizations Vertical (V) and Horizontal (H).

Above 1GHz:

The EUT is placed on a turntable 1.5 meters above the ground in the chamber, 3 meter away from the antenna. The maximal emission value is acquired by adjusting the antenna height, polarisation and turntable azimuth. Normally, the height range of antenna is 1 m to 4 m, the azimuth range of turntable is 0° to 360°, and the receive antenna has two polarizations Vertical (V) and Horizontal (H).

(a) Radiated Emission Test Set-Up, Frequency Below 30MHz

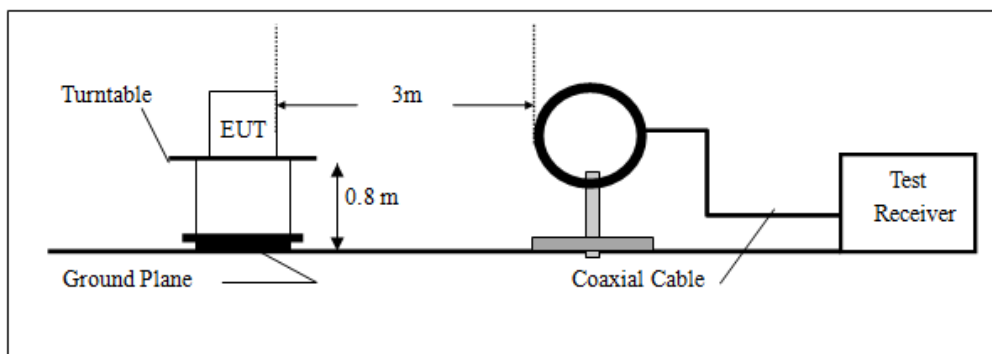

(b) Radiated Emission Test Set-Up, Frequency Below 1000MHz

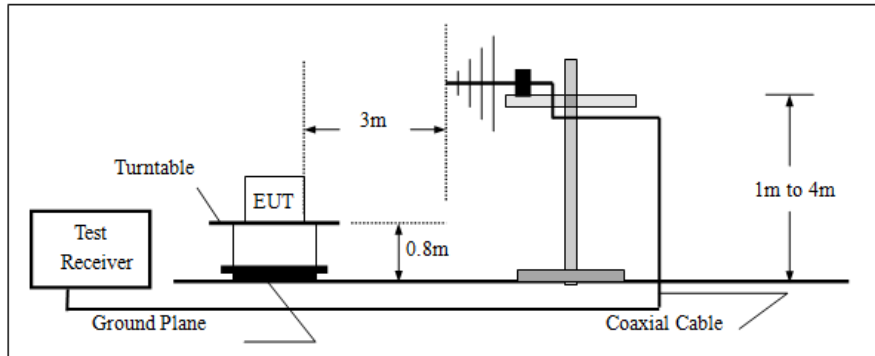

(c) Radiated Emission Test Set-Up, Frequency above 1000MHz

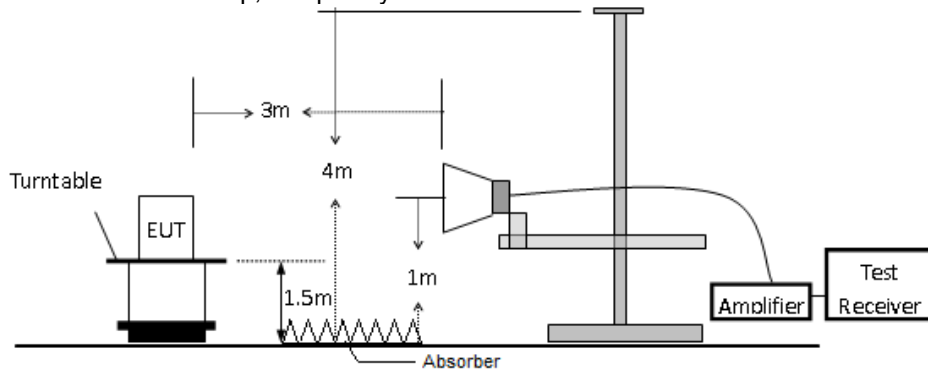

### 7.3 CONDUCTED EMISSION TEST SETUP

The mains cable of the EUT (Game fitness board) must be connected to LISN. The LISN shall be placed 0.8 m from the boundary of EUT and bonded to a ground reference plane for LISN mounted on top of the ground reference plane. This distance is between the closest points of the LISN and the EUT. All other units of the EUT and associated equipment shall be at least 0.8m from the LISN.

Ground connections, where required for safety purposes, shall be connected to the reference ground point of the LISN and, where not otherwise provided or specified by the manufacturer, shall be of same length as the mains cable and run parallel to the mains connection at a separation distance of not more than 0.1 m.

According to the requirements in Section 13.1.4.1 of ANSI C63.10-2013 Conducted emissions from the EUT measured in the frequency range between 0.15 MHz and 30 MHz using CISPR Quasi-Peak and average detector mode.

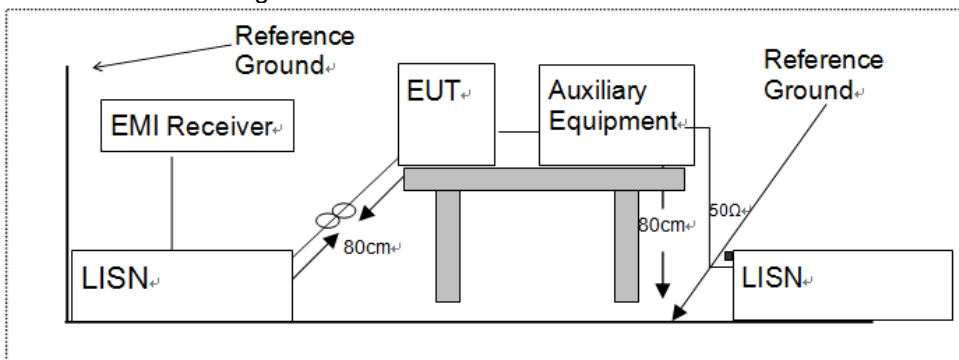

**7.4 SUPPORT EQUIPMENT**

| <b>EUT Cable List and Details</b> |            |                     |                        |
|-----------------------------------|------------|---------------------|------------------------|
| Cable Description                 | Length (m) | Shielded/Unshielded | With / Without Ferrite |
| USB cable                         | 0.6        | N/A                 | N/A                    |

| <b>Auxiliary Cable List and Details</b> |            |                     |                        |
|---|------------|---------------------|------------------------|
| Cable Description                       | Length (m) | Shielded/Unshielded | With / Without Ferrite |
| /                                       | /          | /                   | /                      |

| <b>Auxiliary Equipment List and Details</b> |              |                 |               |
|---|--------------|-----------------|---------------|
| Description                                 | Manufacturer | Model           | Serial Number |
| Adapter                                     | ICU          | PS10C050K2000US | N/A           |

**Notes:**

3. All the equipment/cables were placed in the worst-case configuration to maximize the emission during the test.
4. Grounding was established in accordance with the manufacturer's requirements and conditions for the intended use.

## 8 FREQUENCY HOPPING SYSTEM REQUIREMENTS

### 8.1 Standard Applicable

According to FCC Part 15.247(a)(1), The system shall hop to channel frequencies that are selected at the system hopping rate from a pseudo randomly ordered list of hopping frequencies. Each frequency must be used equally on the average by each transmitter. The system receivers shall have input bandwidths that match the hopping channel bandwidths of their corresponding transmitters and shall shift frequencies in synchronization with the transmitted signals.

(g) Frequency hopping spread spectrum systems are not required to employ all available hopping channels during each transmission. However, the system, consisting of both the transmitter and the receiver, must be designed to comply with all of the regulations in this section should the transmitter be presented with a continuous data (or information) stream. In addition, a system employing short transmission bursts must comply with the definition of a frequency hopping system and must distribute its transmissions over the minimum number of hopping channels specified in this section.

(h) The incorporation of intelligence within a frequency hopping spread spectrum system that permits the system to recognize other users within the spectrum band so that it individually and independently chooses and adapts its hopsets to avoid hopping on occupied channels is permitted. The coordination of frequency hopping systems in any other manner for the express purpose of avoiding the simultaneous occupancy of individual hopping frequencies by multiple transmitters is not permitted.

### 8.2 EUT Pseudorandom Frequency Hopping Sequence

The channel is represented by a pseudo-random hopping sequence hopping through the 79 RF channels. The hopping sequence is unique for the piconet and is determined by the Bluetooth device address of the master; the phase in the hopping sequence is determined by the Bluetooth clock of the master. The channel is divided into time slots where each slot corresponds to an RF hop frequency. Consecutive hops correspond to different RF hop frequencies. The normal hop is 1 600 hops/s.

The pseudorandom sequence may be generated in a nine-stage shift register whose 5th and 9th stage outputs are added in a modulo-two addition stage, and the result is fed back to the input of the first stage. The sequence begins with the first ONE of 9 consecutive ONES; i.e. the shift register is initialized with nine ones. Number of shift register stages: 9  
Length of pseudo-random sequence:  $2^9 - 1 = 511$  bits  
Longest sequence of zeros: 8 (non-inverted signal)

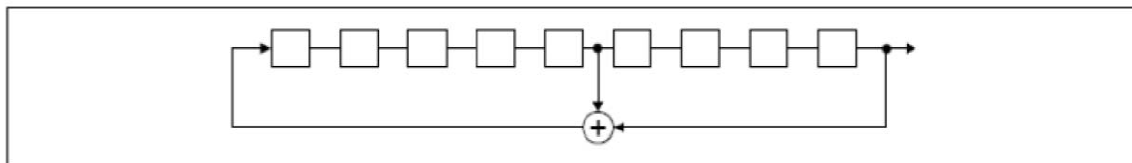

*Linear Feedback Shift Register for Generation of the PRBS sequence*

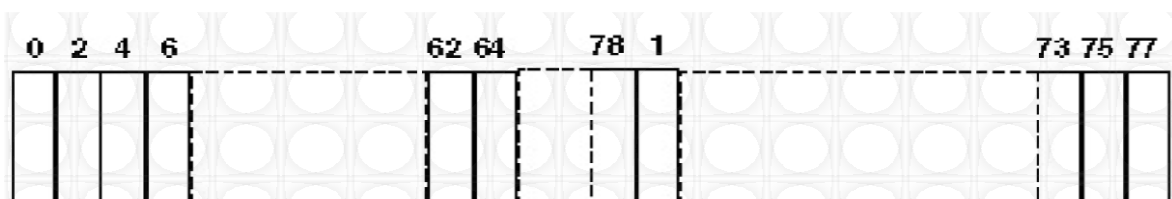

Each frequency used equally on the average by each transmitter.

The system receiver have input bandwidths that match the hopping channel bandwidths of their corresponding transmitters and shift frequencies in synchronization with the transmitted signals.

### **8.3 Equal Hopping Frequency Use**

All Bluetooth units participating in the piconet are time and hop-synchronized to the channel.

Example of a 79 hopping sequence in data mode:

35, 27, 6, 44, 14, 61, 74, 32, 1, 11, 23, 2, 55, 65, 29, 3, 9, 52, 78, 58, 40, 25, 0, 7, 18, 26, 76, 60, 47, 50, 2, 5, 16, 37, 70, 63, 66, 54, 20, 13, 4, 8, 15, 21, 26, 10, 73, 77, 67, 69, 43, 24, 57, 39, 46, 72, 48, 33, 17, 31, 75, 19, 41, 62, 68, 28, 51, 66, 30, 56, 34, 59, 71, 22, 49, 64, 38, 45, 36, 42, 53

Each Frequency used equally on the average by each transmitter

### **8.4 Frequency Hopping System**

This transmitter device is frequency hopping device, and complies with FCC part 15.247 rule.

This device uses Bluetooth radio which operates in 2400-2483.5 MHz band. Bluetooth uses a radio technology called frequency-hopping spread spectrum, which chops up the data being sent and transmits chunks of it on up to 79 bands (1 MHz each; centred from 2402 to 2480 MHz) in the range 2,400-2,483.5 MHz. The transmitter switches hop frequencies 1,600 times per second to assure a high degree of data security. All Bluetooth devices participating in a given piconet are synchronized to the frequency-hopping channel for the piconet. The frequency hopping sequence is determined by the master's device address and the phase of the hopping sequence (the frequency to hop at a specific time) is determined by the master's internal clock. Therefore, all slaves in a piconet must know the master's device address and must synchronize their clocks with the master's clock.

Adaptive Frequency Hopping (AFH) was introduced in the Bluetooth specification to provide an effective way for a Bluetooth radio to counteract normal interference. AFH identifies "bad" channels, where either other wireless devices are interfering with the Bluetooth signal or the Bluetooth signal is interfering with another device. The AFH-enabled Bluetooth device will then communicate with other devices within its piconet to share details of any identified bad channels. The devices will then switch to alternative available "good" channels, away from the areas of interference, thus having no impact on the bandwidth used.





|            |                    |                 |
|------------|--------------------|-----------------|
| Test Model | 20dB Bandwidth     |                 |
|            | Channel 0: 2402MHz | GFSK Modulation |

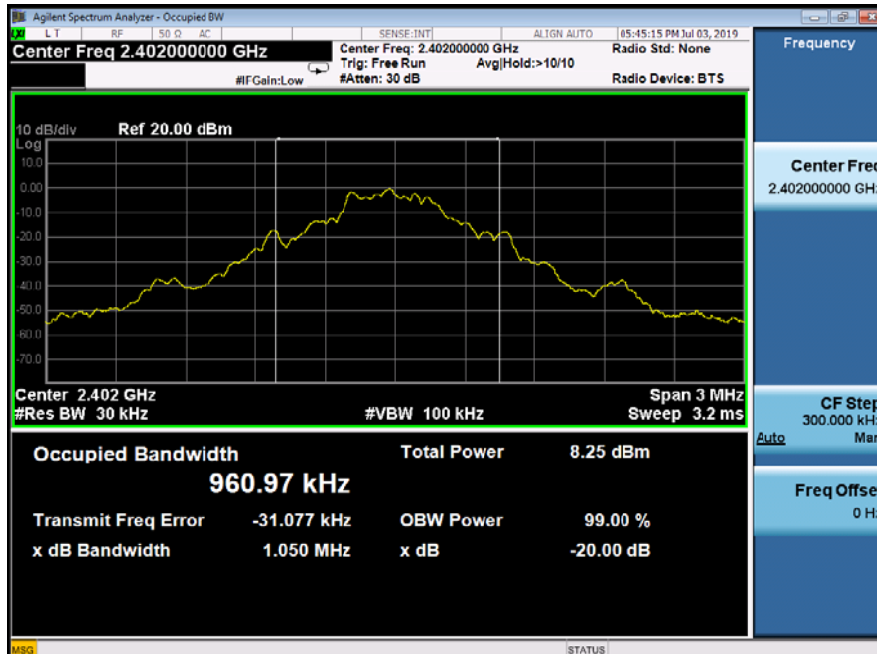

|            |                     |                 |
|------------|---------------------|-----------------|
| Test Model | 20dB Bandwidth      |                 |
|            | Channel 39: 2441MHz | GFSK Modulation |



|            |                     |                 |
|------------|---------------------|-----------------|
| Test Model | 20dB Bandwidth      |                 |
|            | Channel 78: 2480MHz | GFSK Modulation |



|            |                    |                       |
|------------|--------------------|-----------------------|
| Test Model | 20dB Bandwidth     |                       |
|            | Channel 0: 2402MHz | pi/4-DQPSK Modulation |



|            |                     |                       |
|------------|---------------------|-----------------------|
| Test Model | 20dB Bandwidth      |                       |
|            | Channel 39: 2441MHz | pi/4-DQPSK Modulation |

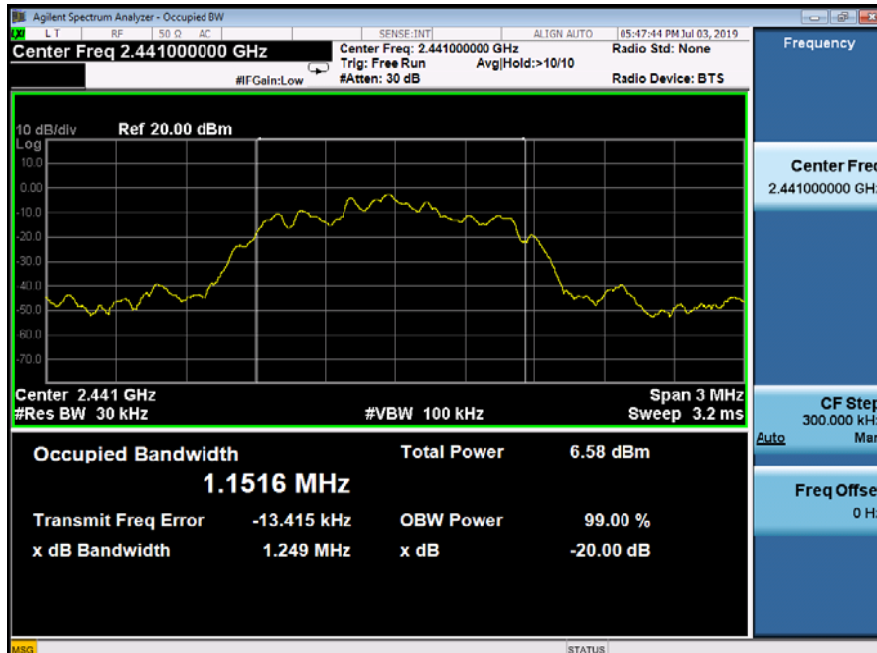

|            |                     |                       |
|------------|---------------------|-----------------------|
| Test Model | 20dB Bandwidth      |                       |
|            | Channel 78: 2480MHz | pi/4-DQPSK Modulation |

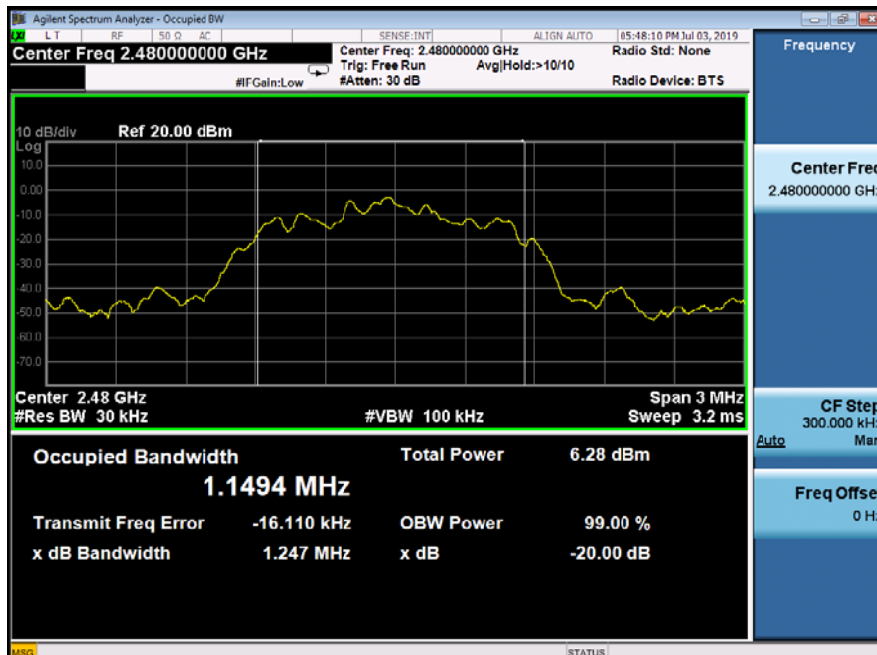

|            |                    |                  |
|------------|--------------------|------------------|
| Test Model | 20dB Bandwidth     |                  |
|            | Channel 0: 2402MHz | 8DPSK Modulation |

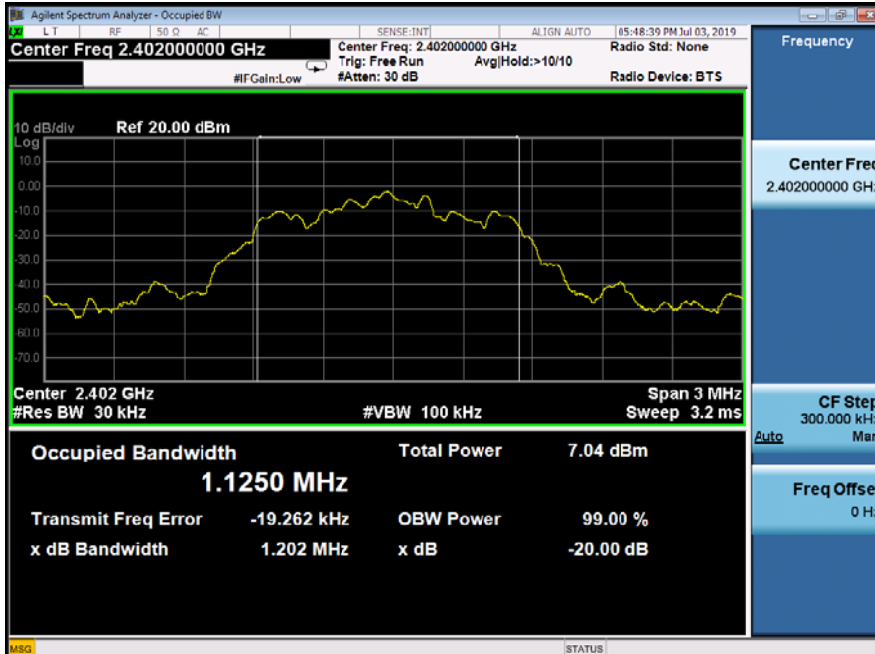

|            |                     |                  |
|------------|---------------------|------------------|
| Test Model | 20dB Bandwidth      |                  |
|            | Channel 39: 2441MHz | 8DPSK Modulation |

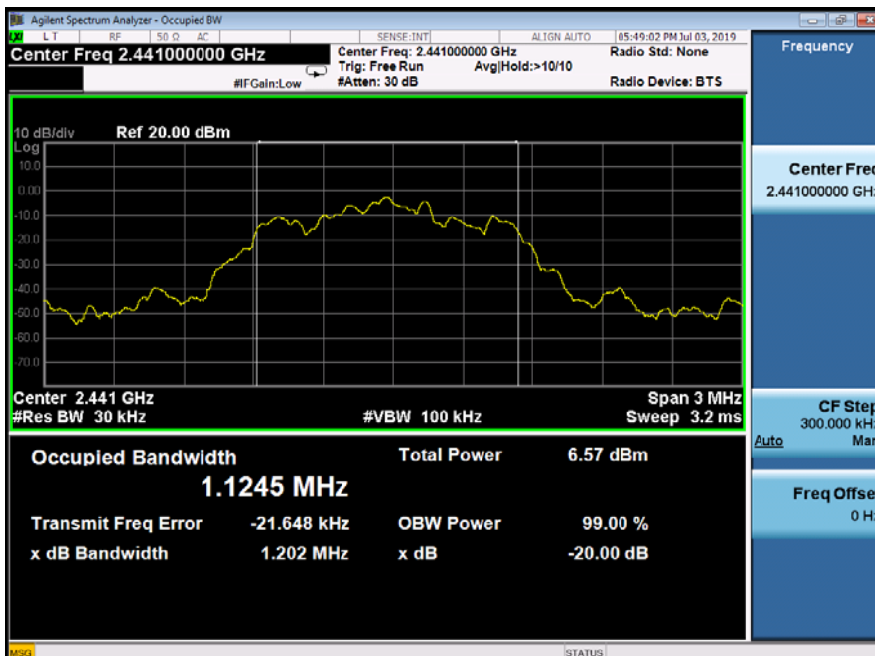

|            |                     |                  |
|------------|---------------------|------------------|
| Test Model | 20dB Bandwidth      |                  |
|            | Channel 78: 2480MHz | 8DPSK Modulation |





|            |                              |                 |
|------------|------------------------------|-----------------|
| Test Model | Carrier Frequency Separation |                 |
|            | Channel 0: 2402MHz           | GFSK Modulation |



|            |                              |                 |
|------------|------------------------------|-----------------|
| Test Model | Carrier Frequency Separation |                 |
|            | Channel 39: 2441MHz          | GFSK Modulation |



|            |                              |                 |
|------------|------------------------------|-----------------|
| Test Model | Carrier Frequency Separation |                 |
|            | Channel 78: 2480MHz          | GFSK Modulation |



|            |                              |                       |
|------------|------------------------------|-----------------------|
| Test Model | Carrier Frequency Separation |                       |
|            | Channel 0: 2402MHz           | pi/4-DQPSK Modulation |





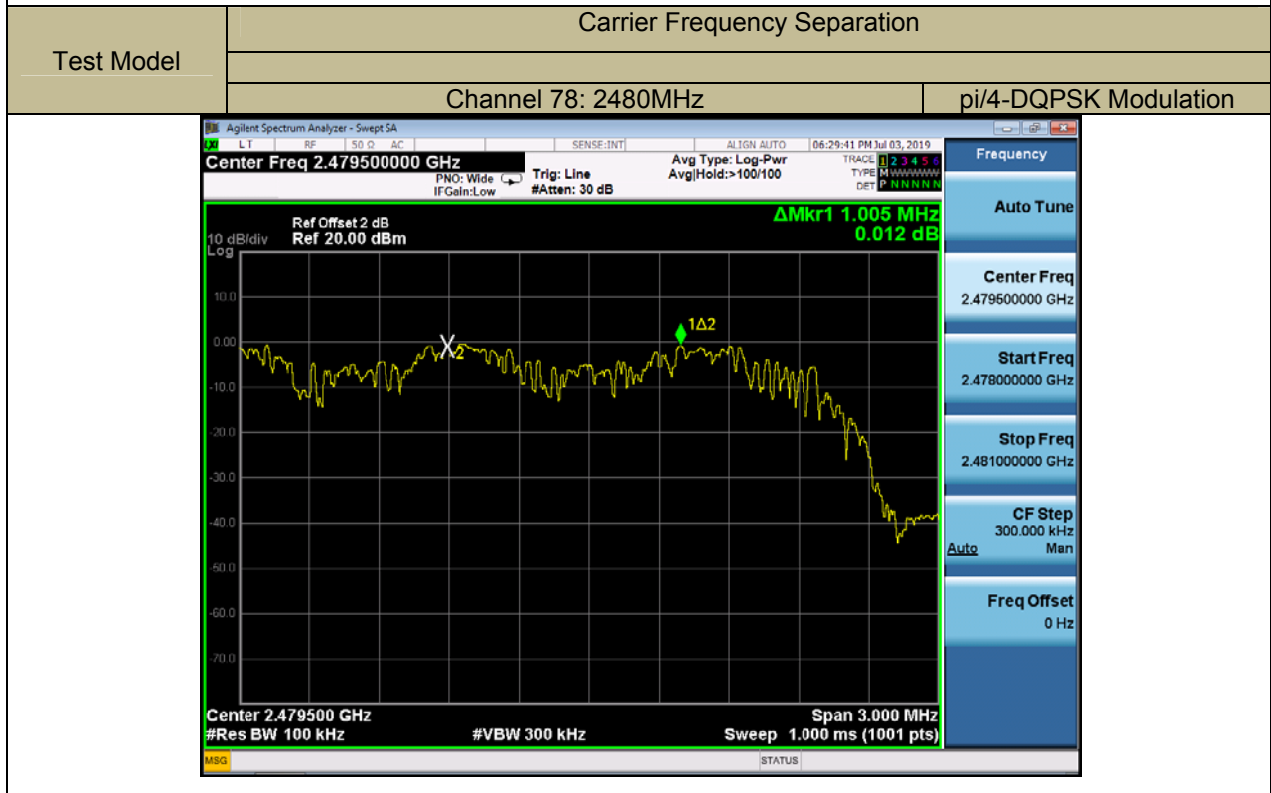
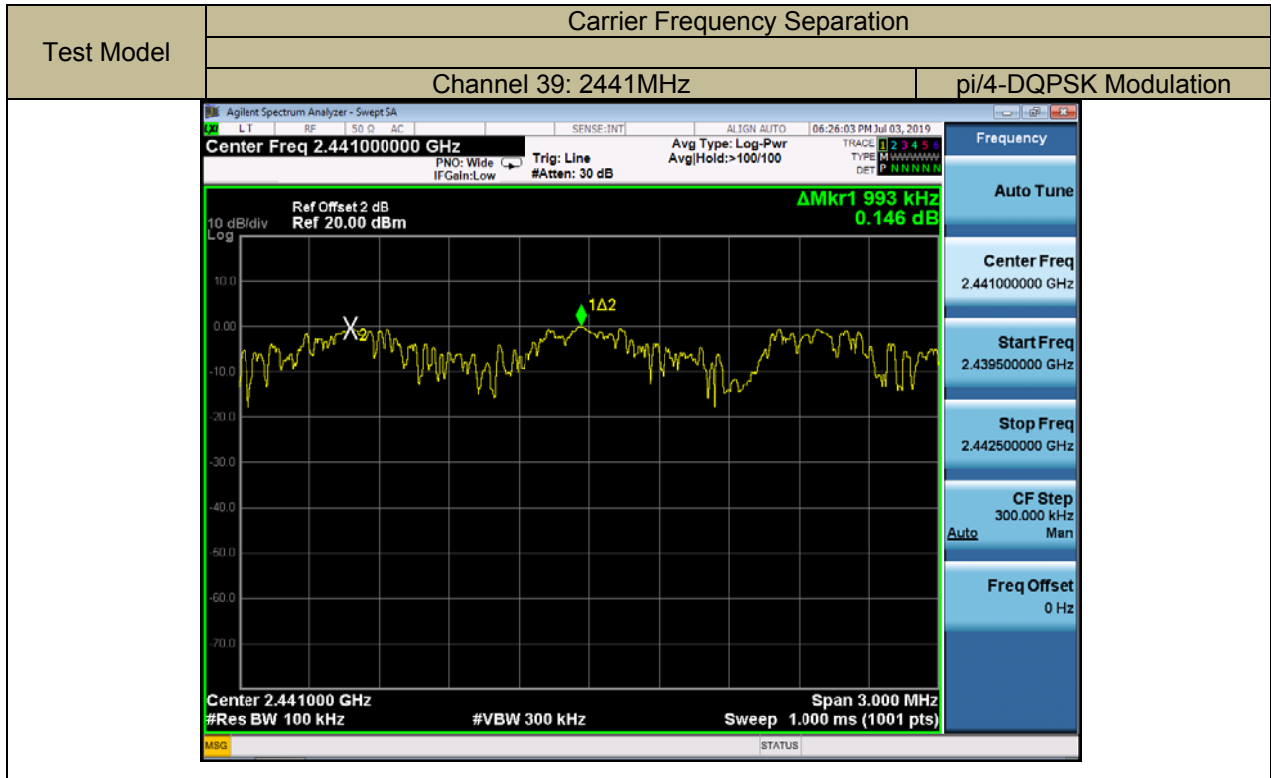

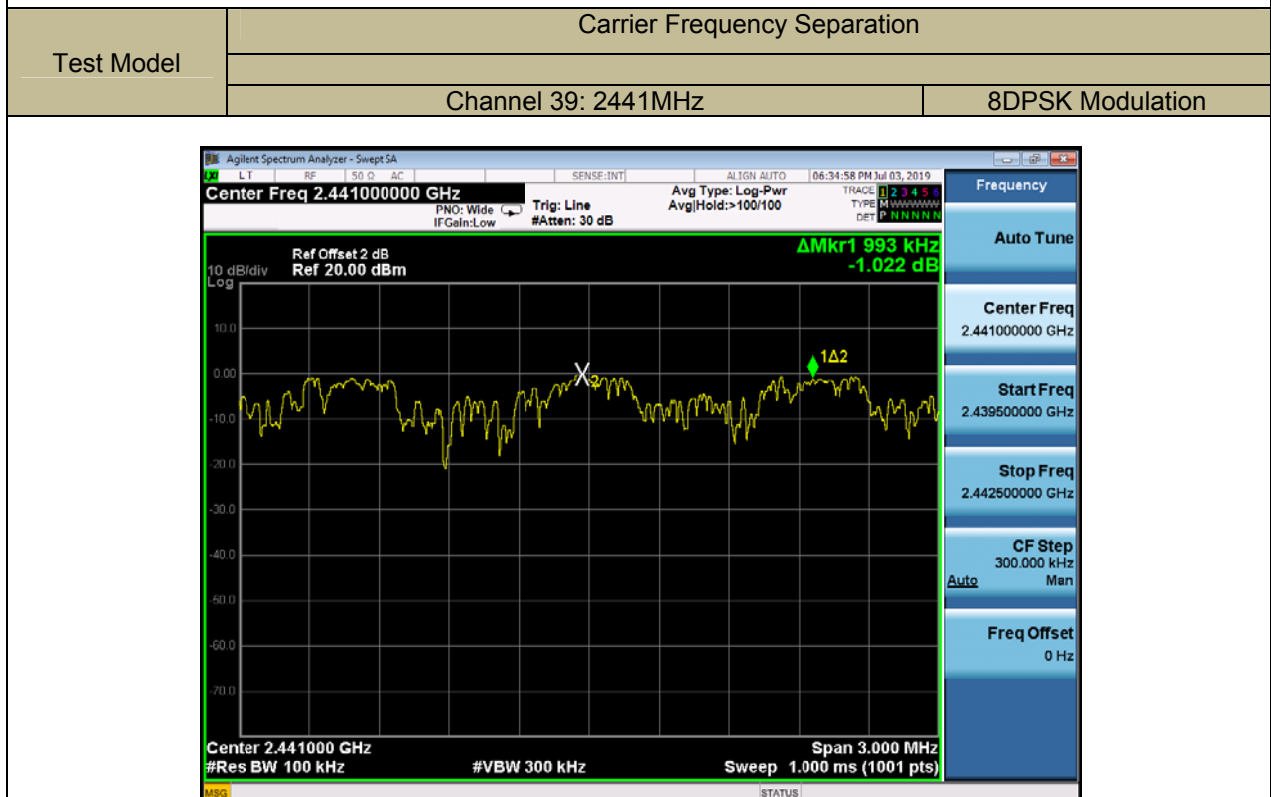
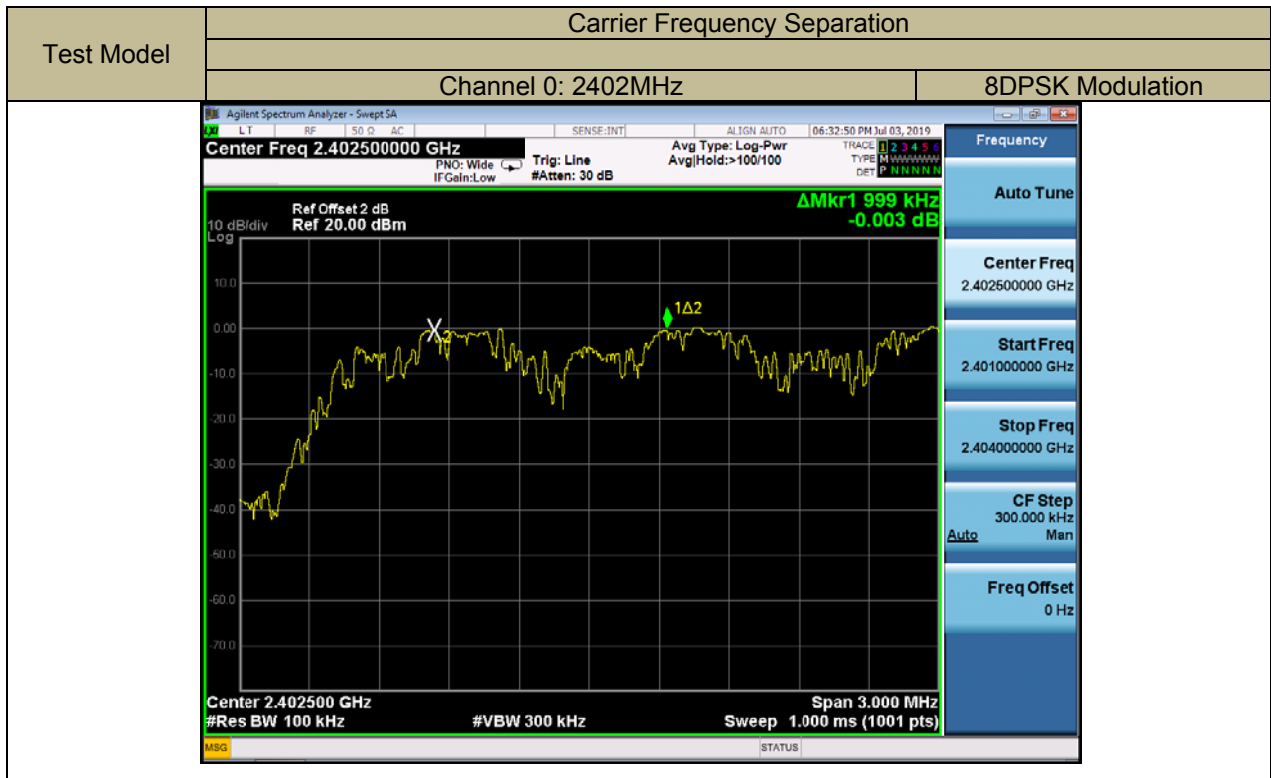

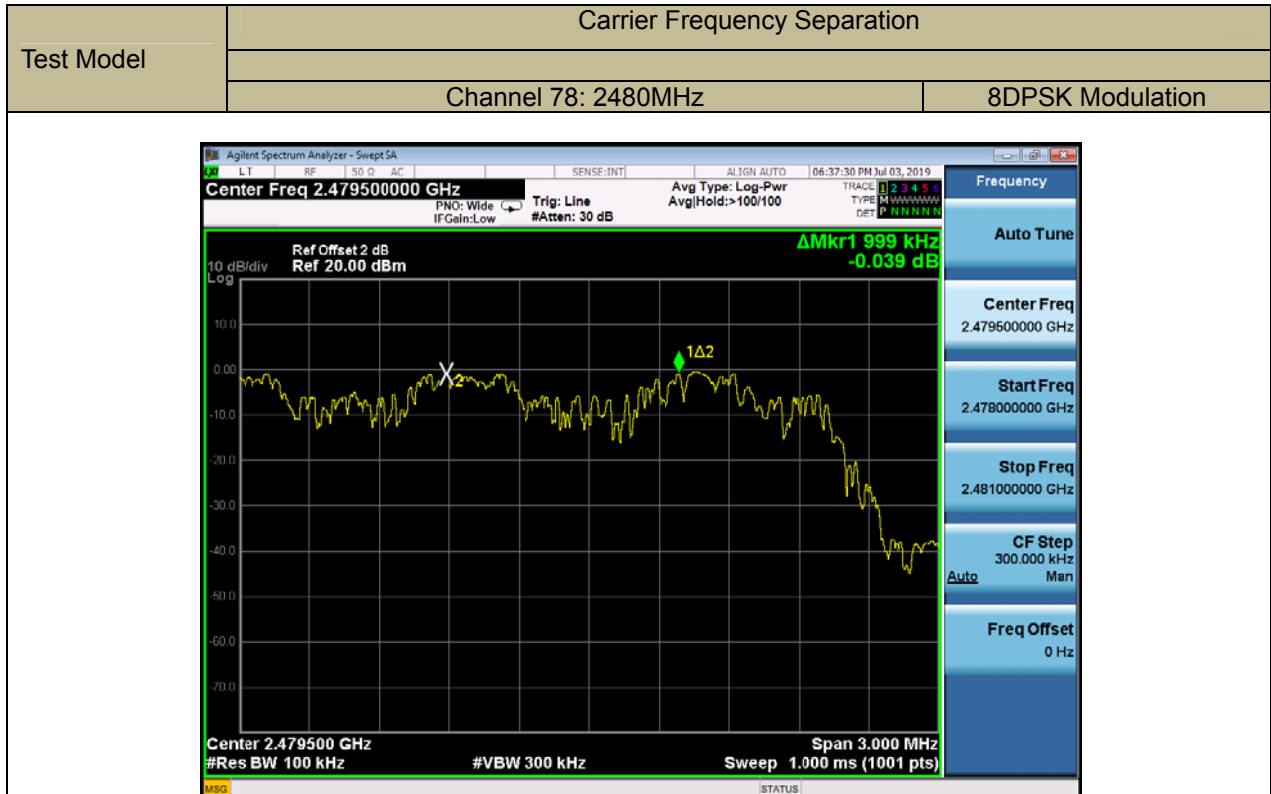

**9.3 NUMBER OF HOPPING FREQUENCIES**

**9.3.1 Applicable Standard**

According to FCC Part 15.247(a)(1) (iii) and DA 00-705

**9.3.2 Conformance Limit**

Frequency hopping systems operating in the 2400-2483.5MHz band shall use at least 15 channels.

**9.3.3 Test Configuration**

Test according to clause 7.1 radio frequency test setup 1

**9.3.4 Test Procedure**

- According to FCC Part 15.247(a)(1)(iii)

The EUT must have its hopping function enabled. Use the following spectrum analyzer settings:

Span = the frequency band of operation

RBW = 1MHz

VBW ≥ RBW

Sweep = auto

Detector function = peak

Trace = max hold

Allow the trace to stabilize. It may prove necessary to break the span up to sections, in order to clearly show all of the hopping frequencies.

**Test Results**

Temperature: 24°C  
Humidity: 53 %

Test Date: July 03, 2019  
Test By: KK

| Hopping Channel Frequency Range   | Quantity of Hopping Channel | Quantity of Hopping Channel limit |
|---|-----------------------------|-----------------------------------|
| 2402-2480 (GFSK)  | 79                          | > 15                              |
| Note: Both EDR & EDR mode has been evaluated, and the worst result recorded was report. |                             |                                   |

|            |                               |      |
|------------|-------------------------------|------|
| Test Model | Number Of Hopping Frequencies |      |
|            | Span:2400-2483.5MHz           | GFSK |

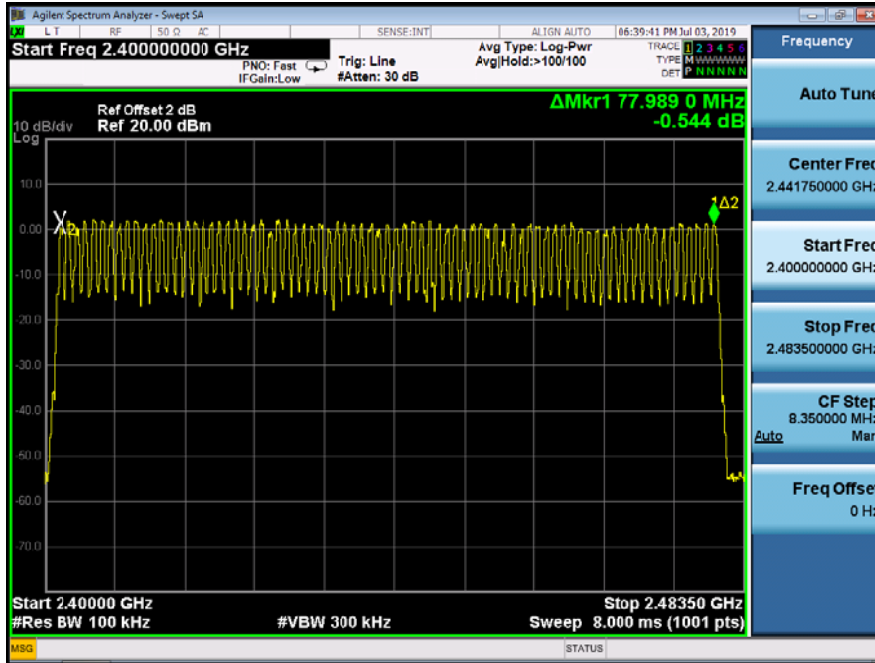

**9.4 AVERAGE TIME OF OCCUPANCY (DWEELL TIME)**

**9.4.1 Applicable Standard**

According to FCC Part 15.247(a)(1)(iii) and DA 00-705

**9.4.2 Conformance Limit**

For frequency hopping systems operating in the 2400-2483.5MHz band, the averagetime of occupancy on any channel shall not be greater than 0.4s within a period of 0.4smultiplied by the number of hopping channels employed.

**9.4.3 Test Configuration**

Test according to clause 7.1 radio frequency test setup 1

**9.4.4 Test Procedure**

- According to FCC Part15.247(a)(1)(iii)

The EUT must have its hopping function enabled. Use the following spectrum analyzersettings:

Span = zero span, centered on a hopping channel

RBW = 1 MHz

VBW ≥ RBW

Sweep = as necessary to capture the entire dwell time per hopping channel

Detector function = peak

Trace = max hold

If possible, use the marker-delta function to determine the dwell time. If this value varies with different modes of operation (e.g., data rate, modulation format, etc.), repeat this test for each variation. The limit is specified in one of the subparagraphsof this Section.

**9.4.5 Test Results**

|              |       |            |                            |
|--------------|-------|------------|----------------------------|
| Temperature: | 24 °C | Test Date: | June 26, 2019July 03, 2019 |
| Humidity:    | 53 %  | Test By:   | KK                         |

Bluetooth (GFSK, pi/4-DQPSK, 8DPSK) mode have been tested, and the worst result(GFSK)was report as below:

| Modulation Mode   | Channel Number | Packet type | Pluse width (ms) | DwellTime (ms) | Limit (ms) | Verdict |
|---|----------------|-------------|------------------|----------------|------------|---------|
| GFSK  | 0              | DH1         | 0.368            | 117.76         | <400       | PASS    |
|   | 0              | DH3         | 1.631            | 260.96         | <400       | PASS    |
|   | 0              | DH5         | 2.940            | 313.61         | <400       | PASS    |
| <p>Note1: DwellTime(DH1)=PW*(1600/2/79)*31.6<br/>           DwellTime(DH3)=PW*(1600/4/79)*31.6<br/>           DwellTime(DH5)=PW*(1600/6/79)*31.6</p> <p>Note2: Bluetooth (GFSK, pi/4-DQPSK, 8DPSK) mode have been tested, and the worst results has been recorded on the follow page.</p> |                |             |                  |                |            |         |

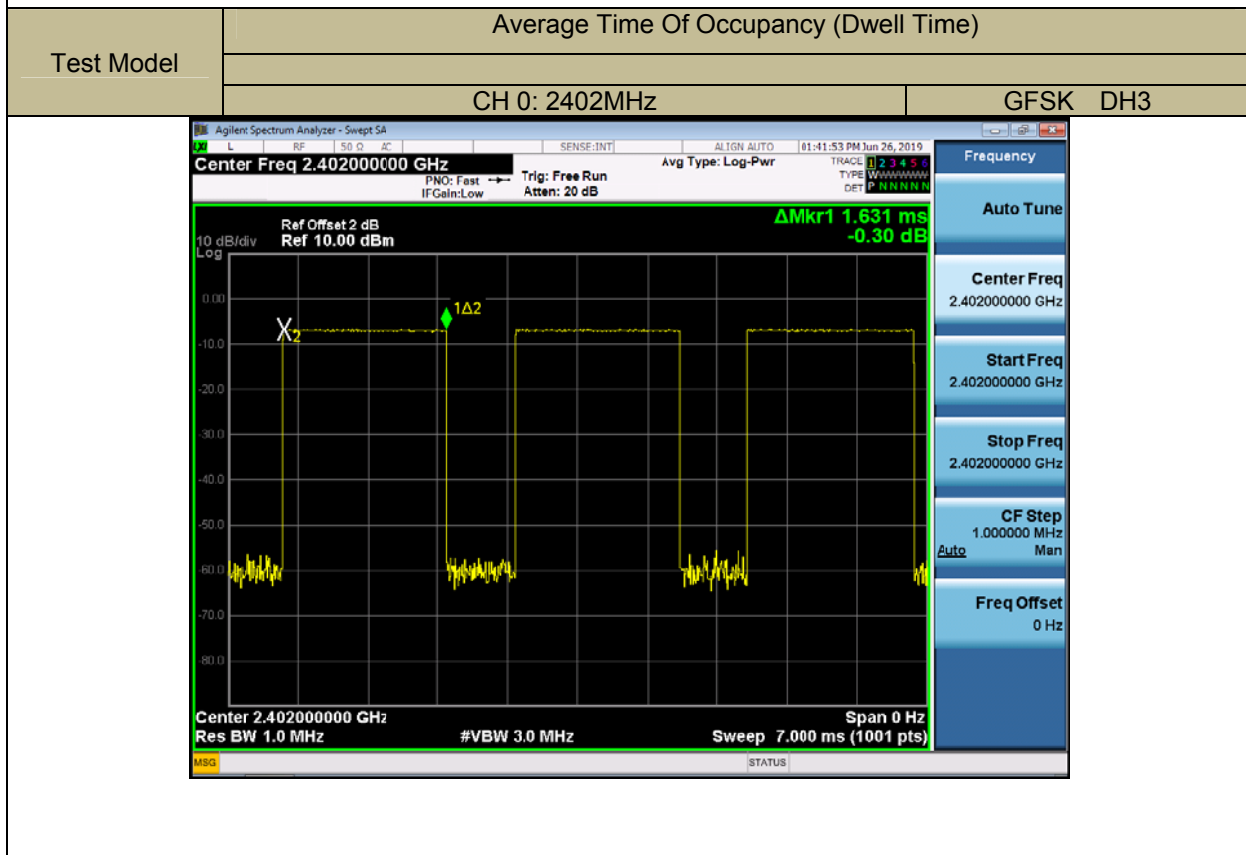
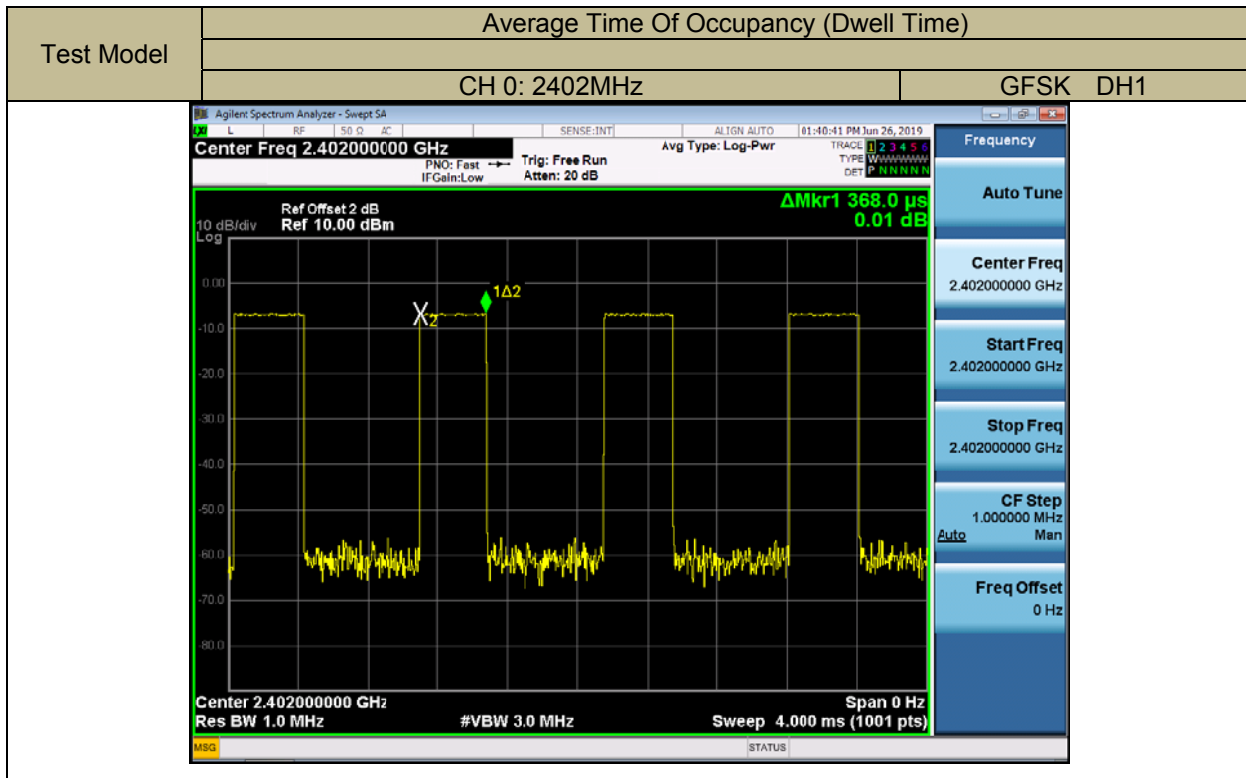

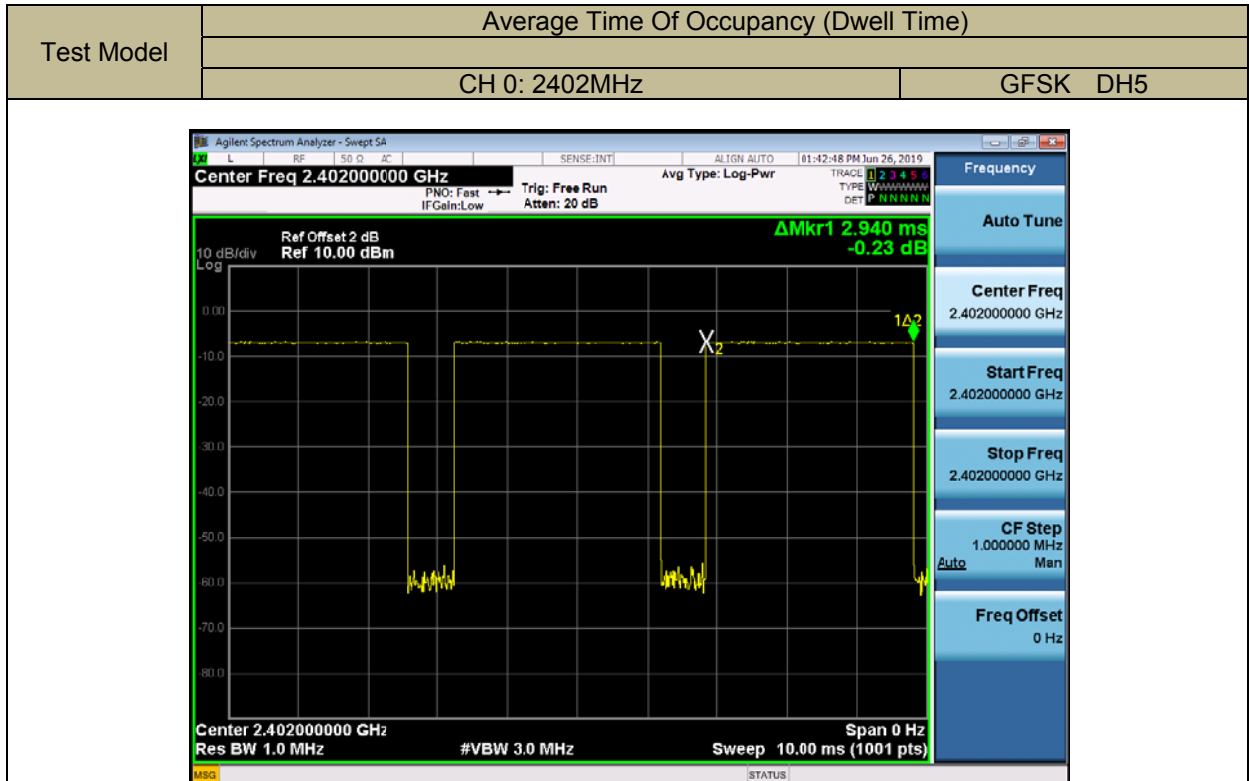





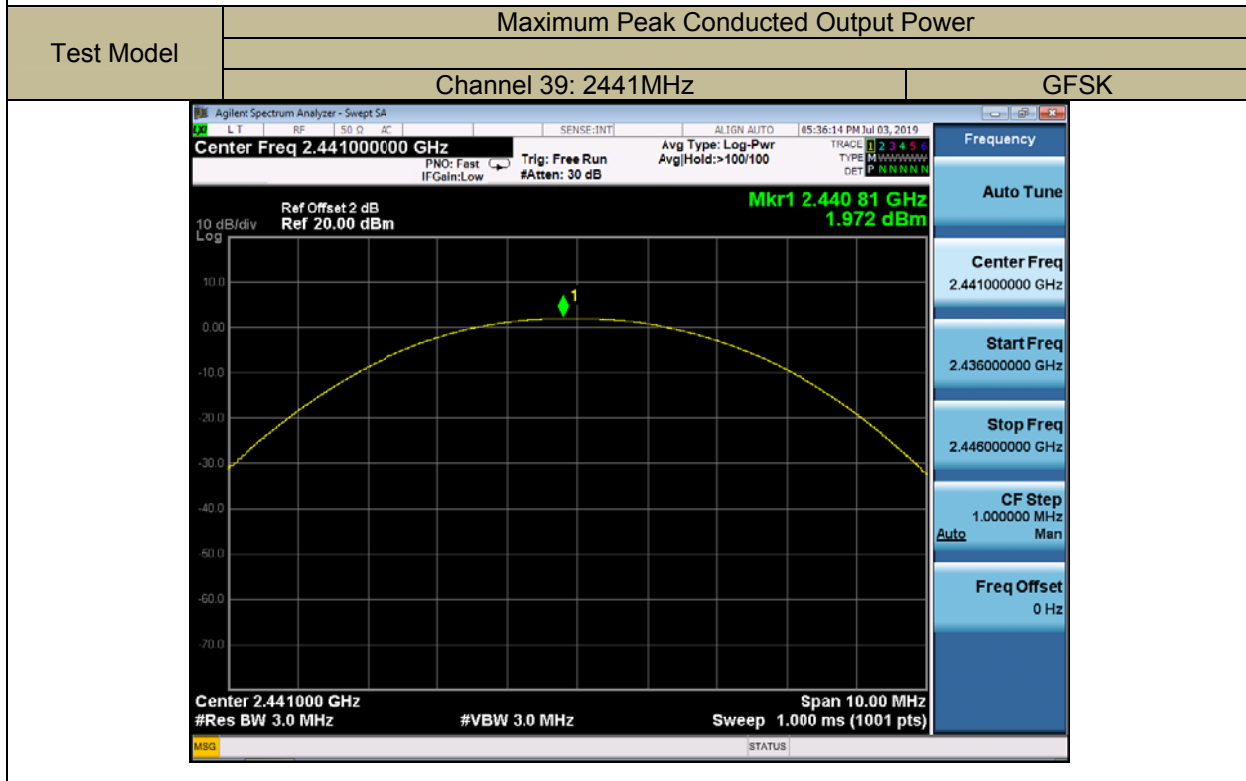
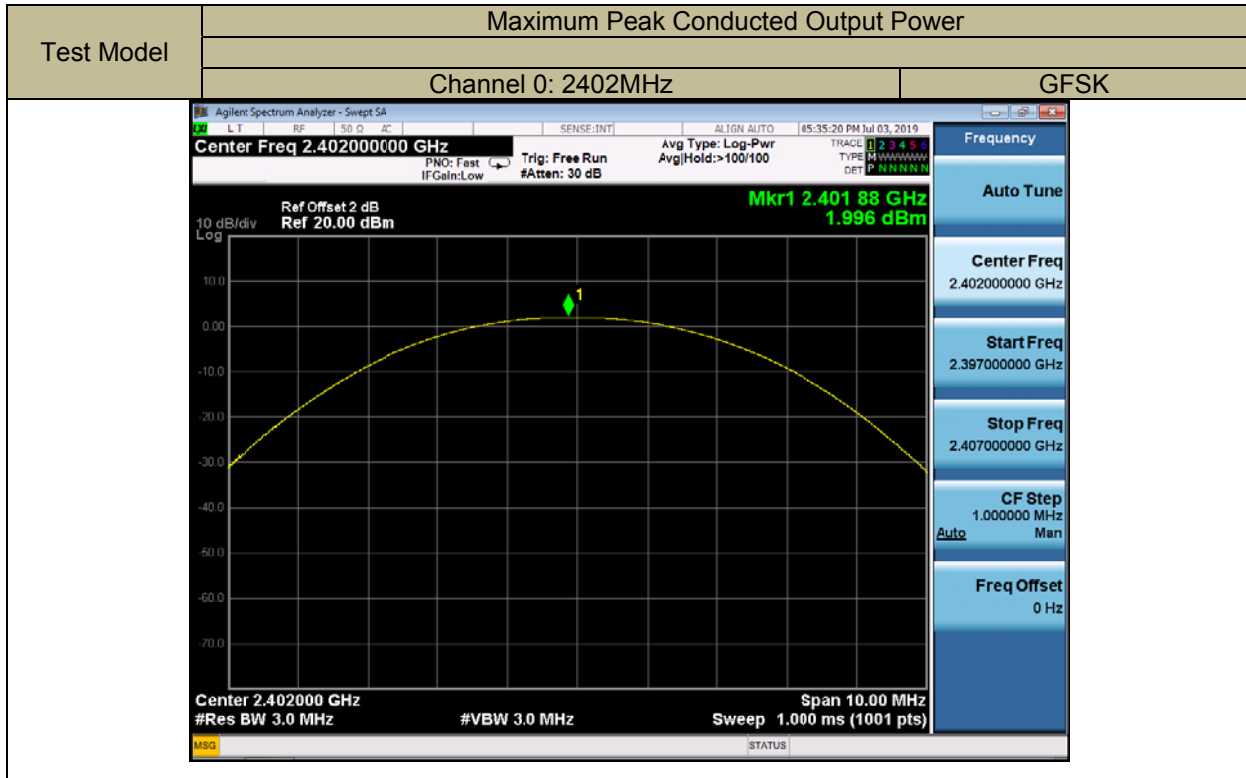

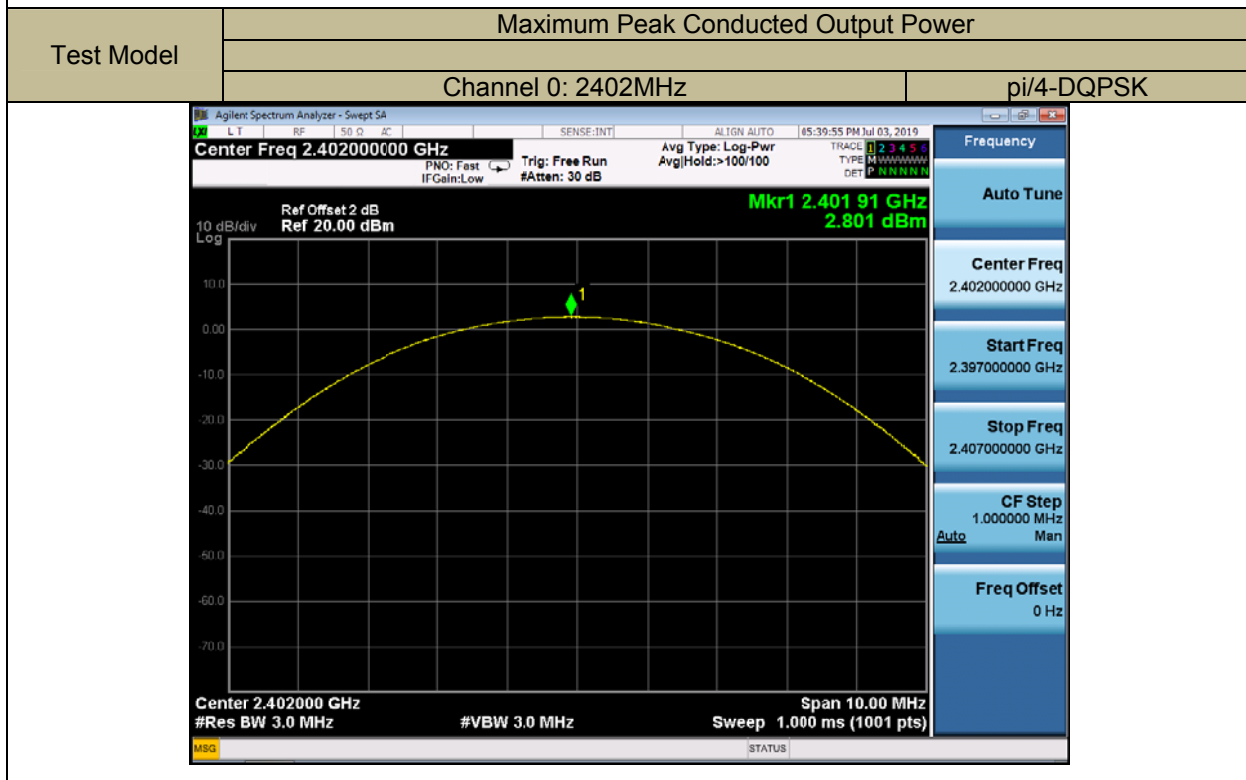
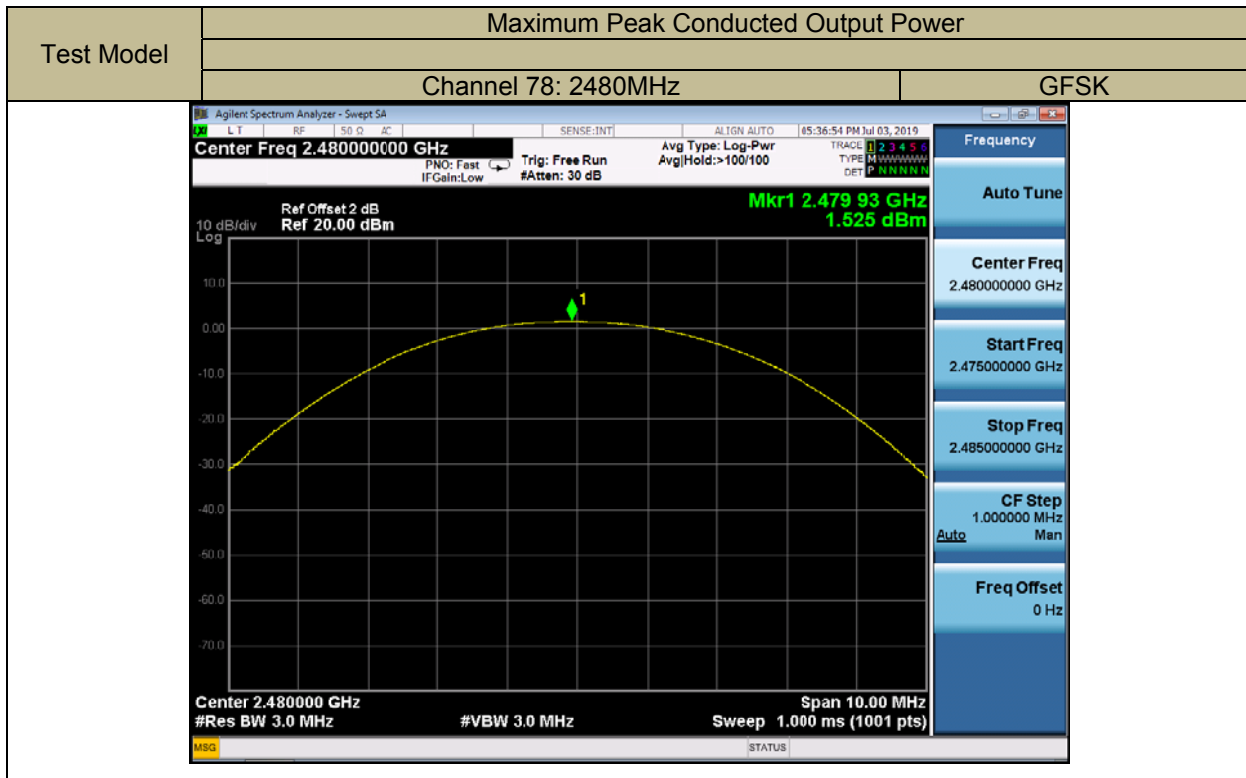

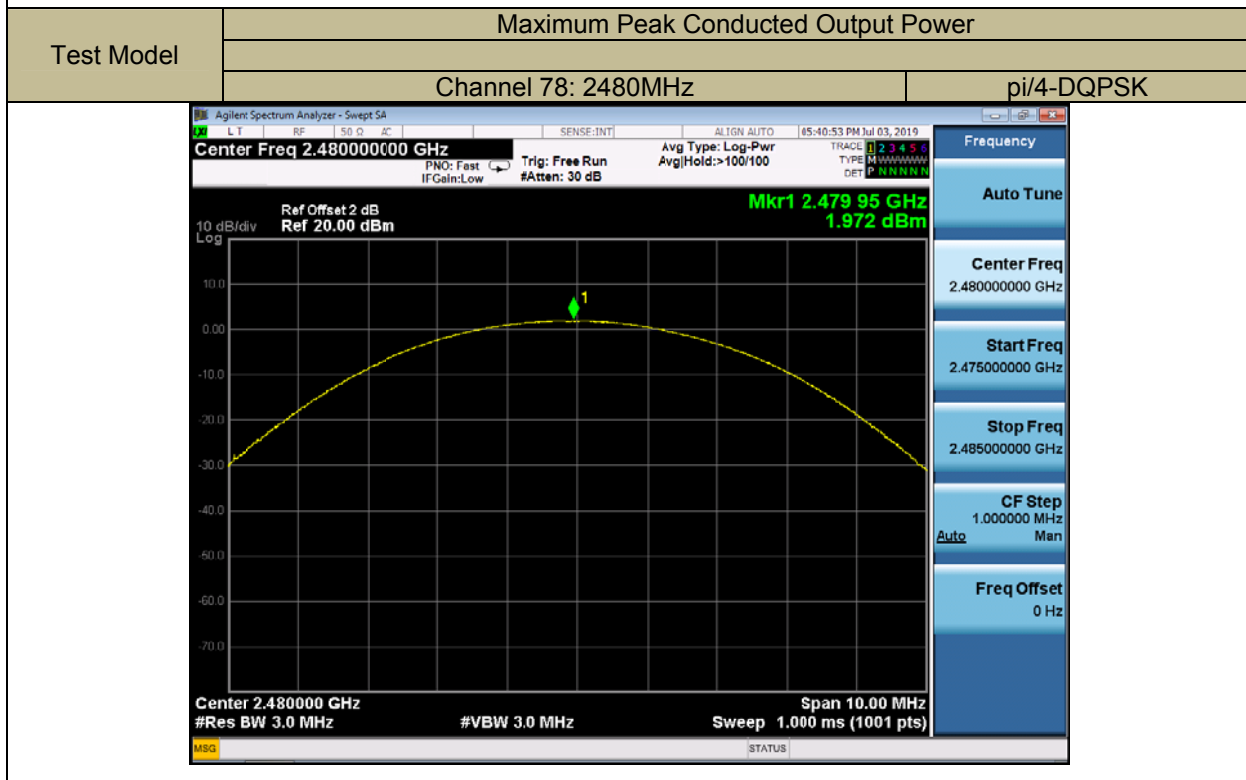
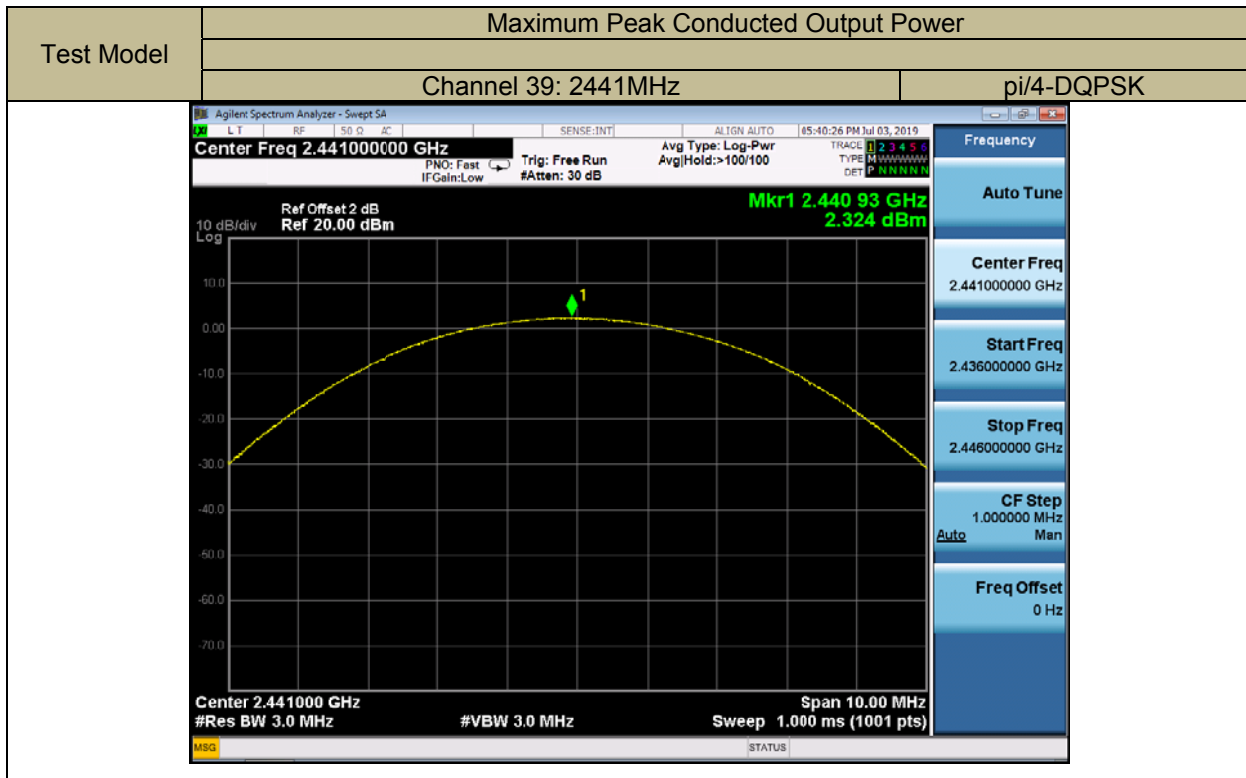

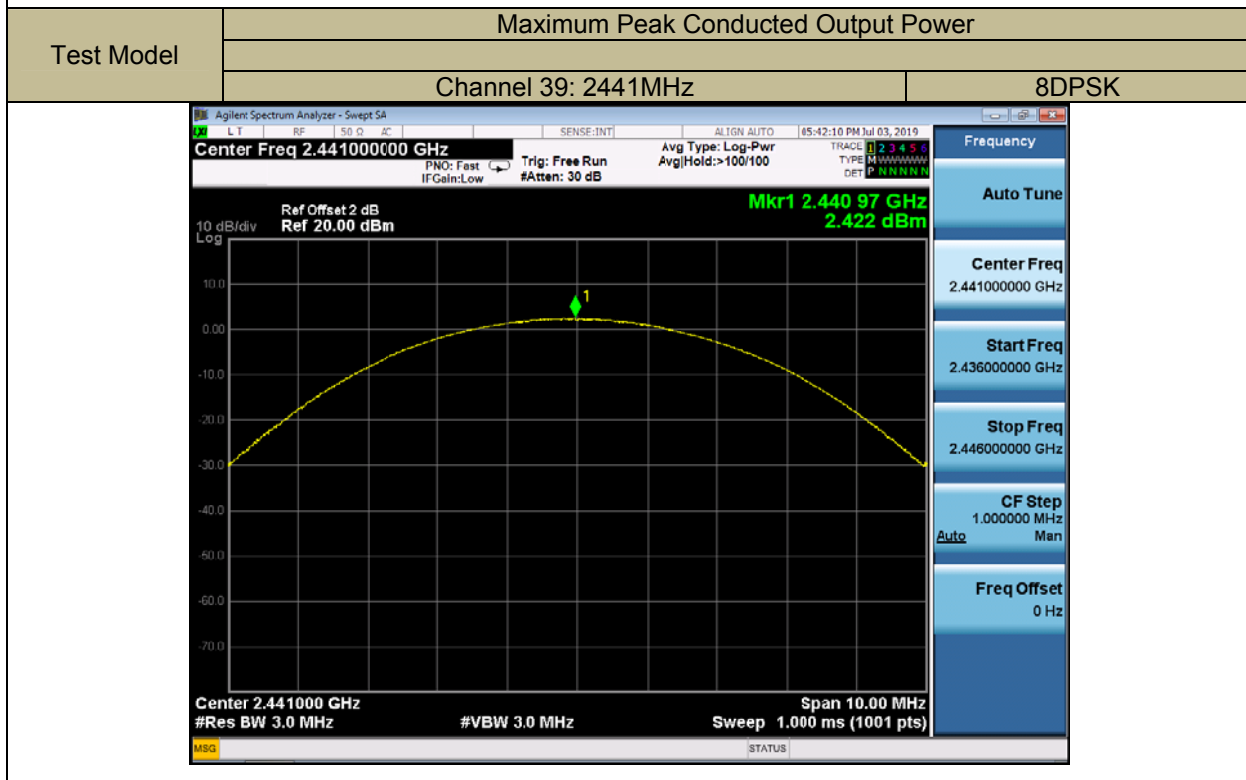
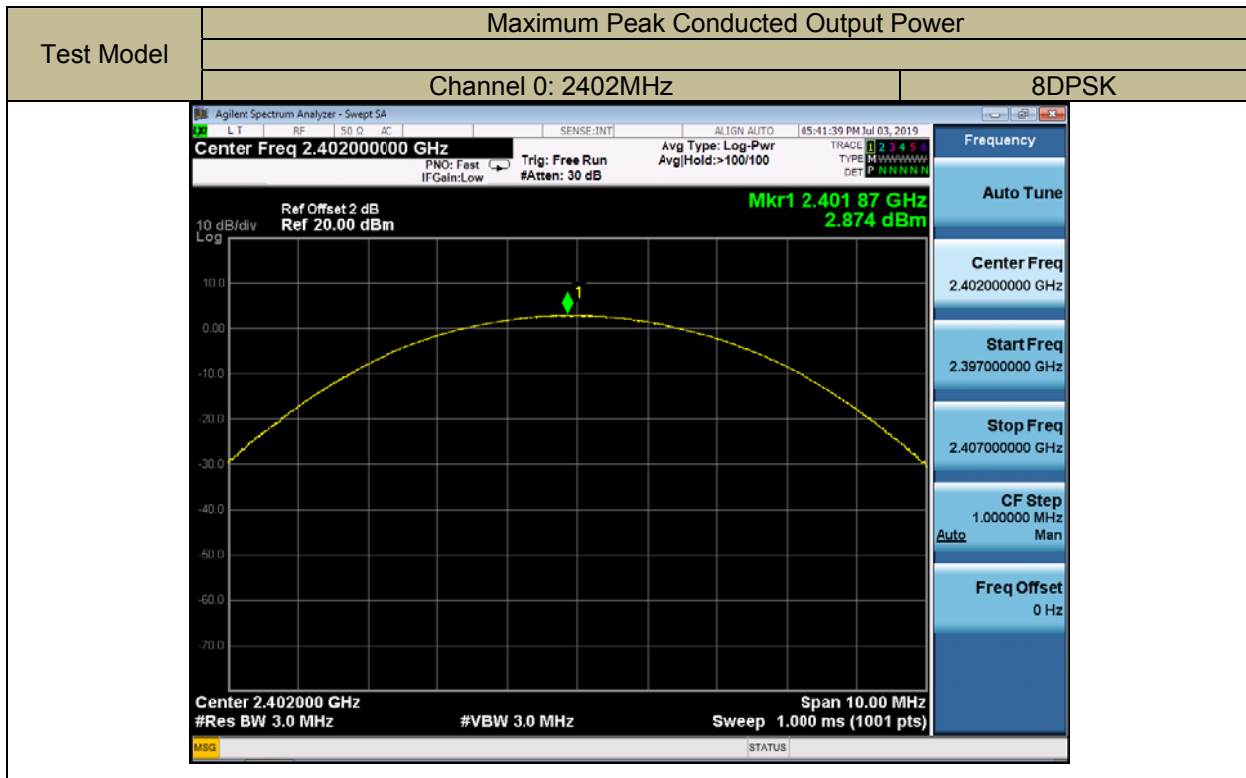

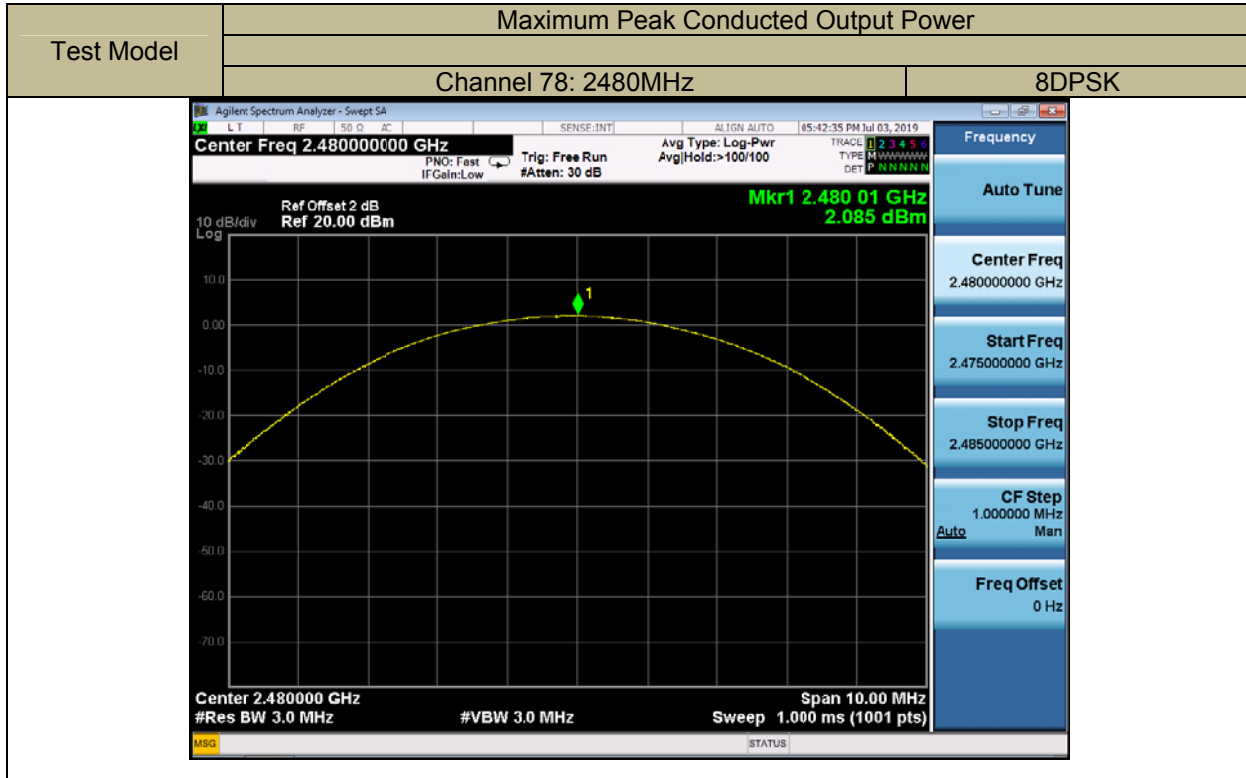

## 9.6 CONDUCTED SUPRIIOUS EMISSION

### 9.6.1 Applicable Standard

According to FCC Part 15.247(d) and DA 00-705

### 9.6.2 Conformance Limit

According to FCC Part 15.247(d):

In any 100 kHz bandwidth outside the frequency band in which the spread spectrum intentional radiator is operating, the radio frequency power that is produced by the intentional radiator shall be at least 20 dB below that in the 100 kHz bandwidth within the band that contains the highest level of the desired power, based on either an RF conducted, provided the transmitter demonstrates compliance with the peak conducted power limits.

### 9.6.3 Test Configuration

Test according to clause 7.1 radio frequency test setup 1

### 9.6.4 Test Procedure

The transmitter output (antenna port) was connected to the spectrum analyzer

#### ■ Reference level measurement

Establish a reference level by using the following procedure:

Set instrument center frequency to DSS channel center frequency.

Set Span = approximately 5 times the 20 dB bandwidth, centered on a hopping channel.

Set the RBW = 100 kHz. Set the VBW  $\geq 3 \times$  RBW.

Set Detector = peak. Set Sweep time = auto couple.

Set Trace mode = max hold. Allow trace to fully stabilize.

Use the peak marker function to determine the maximum Maximumconducedlevel.

Note that the channel found to contain the maximum conduced level can be used to establish the reference level.

#### ■ Band-edge Compliance of RF Conducted Emissions

Use the following spectrum analyzer settings:

Span = wide enough to capture the peak level of the emission operating on the channel closest to the band-edge, as well as any modulation products which fall outside of the authorized band of operation

Set RBW  $\geq 1\%$  of the span=100kHzSet VBW  $\geq$  RBW

Set Sweep = autoSetDetector function = peakSetTrace = max hold

Allow the trace to stabilize. Set the marker on the emission at the bandedge, or on the highest modulation product outside of the band, if this level is greater than that at the bandedge. Enable the marker-delta function, then use the marker-to-peak function to move the marker to the peak of the in-band emission.

The marker-delta value now displayed must comply with the limit specified in this Section.

Now, using the same instrument settings, enable the hopping function of the EUT. Allow the trace to stabilize. Follow the same procedure listed above to determine if any spurious emissions caused by the hopping function also comply with the specified limit.

#### ■ Conduced Spurious RF Conducted Emission

Use the following spectrum analyzer settings:

Span = wide enough to capture the peak level of the in-band emission and all spurious emissions (e.g., harmonics) from the lowest frequency generated in the EUT up through the 10th harmonic.(30MHz to 25GHz).Set RBW = 100 kHzSetVBW  $\geq$  RBW

Set Sweep = autoSetDetector function = peakSetTrace = max hold

Allow the trace to stabilize. Set the marker on the peak of any spurious emission recorded. The level displayed must comply with the limit specified in this Section.

**9.6.5 Test Results**

Bluetooth (GFSK, pi/4-DQPSK, 8DPSK) mode have been tested, and the worst result(GFSK)was report as below:

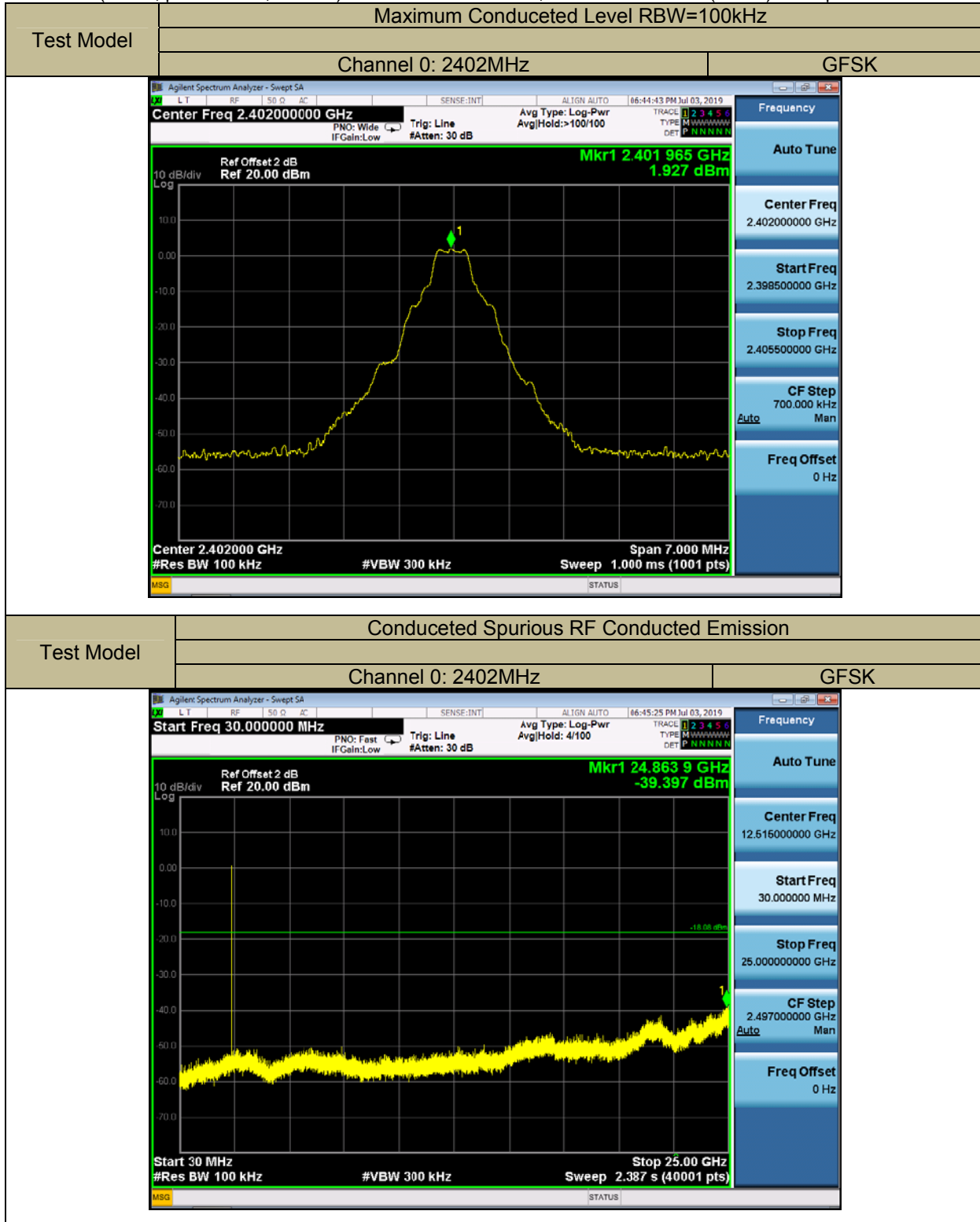



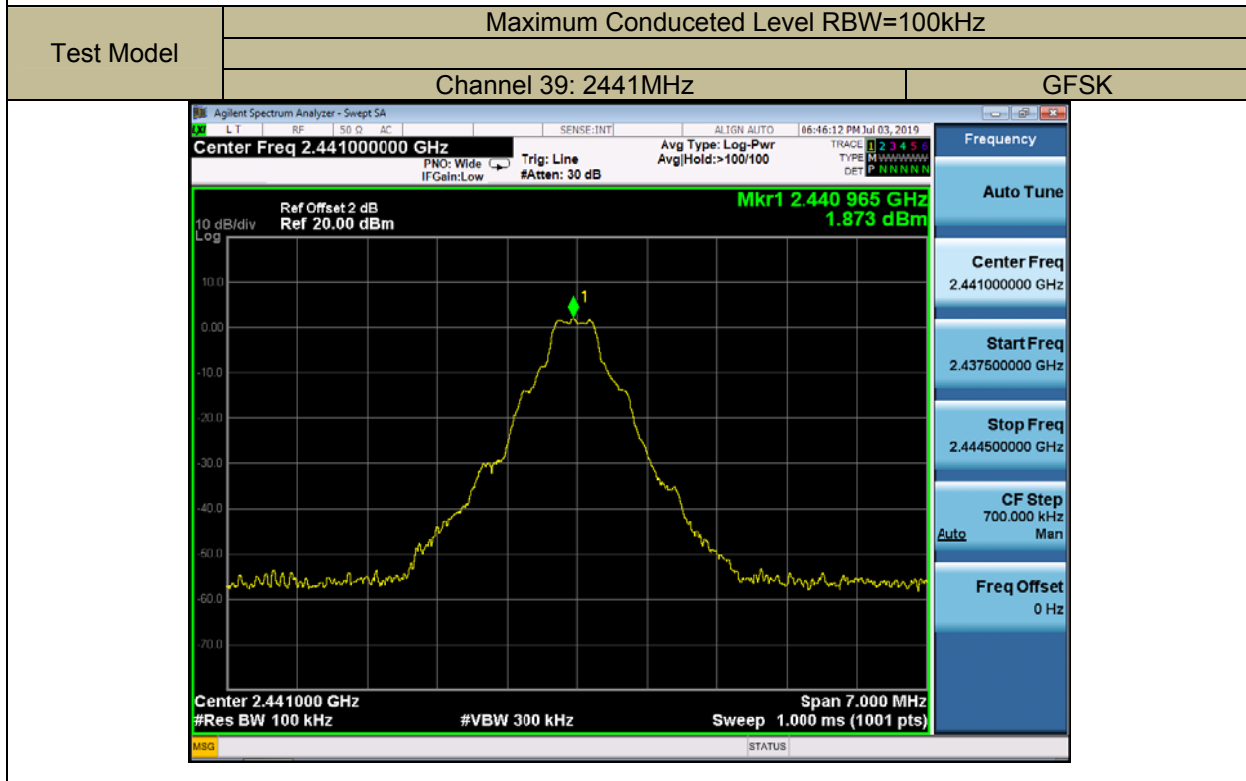
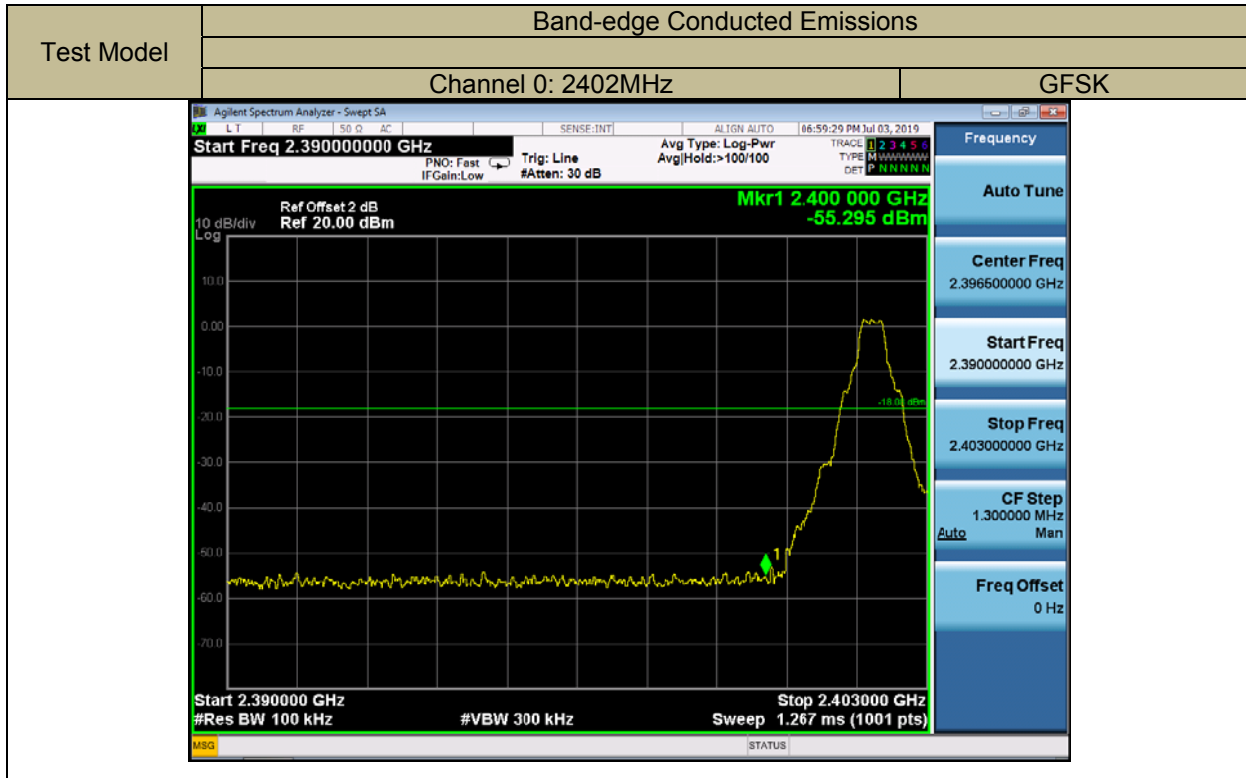

|            |  |      |
|------------|--|------|
| Test Model | Conducted Spurious RF Conducted Emission |      |
|            | Channel 39: 2441MHz                      | GFSK |



|            |                                   |      |
|------------|-----------------------------------|------|
| Test Model | Maximum Conduced Level RBW=100kHz |      |
|            | Channel 78: 2480MHz               | GFSK |

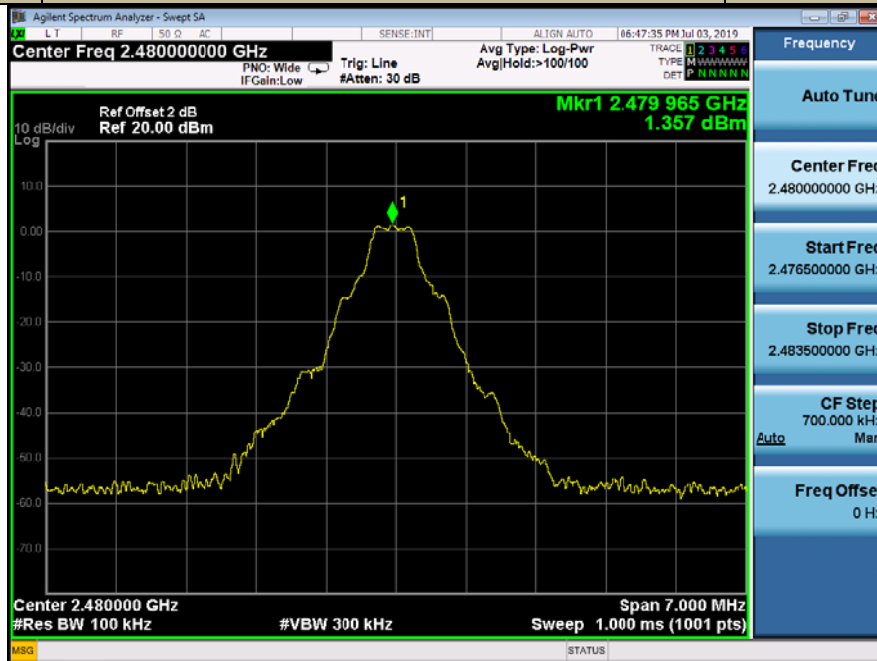

|            |  |      |
|------------|--|------|
| Test Model | Conducted Spurious RF Conducted Emission |      |
|            | Channel 78: 2480MHz                      | GFSK |

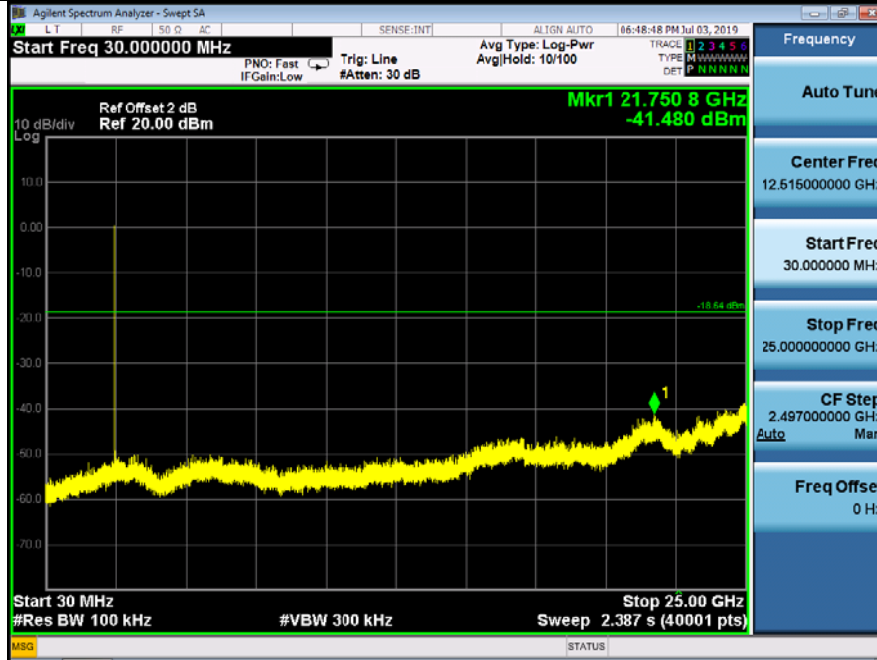

|            |                               |      |
|------------|-------------------------------|------|
| Test Model | Band-edge Conducted Emissions |      |
|            | Channel 78: 2480MHz           | GFSK |

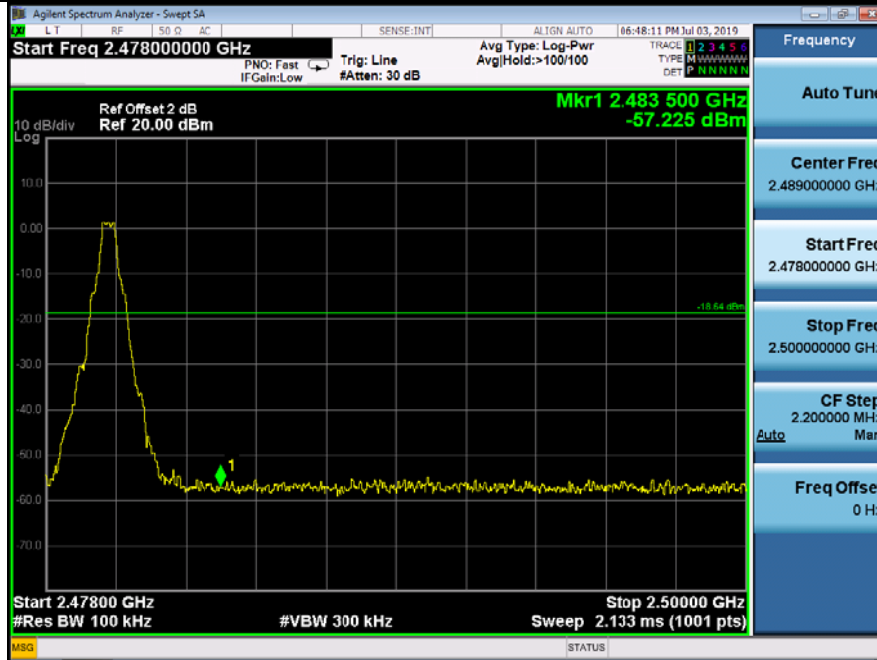

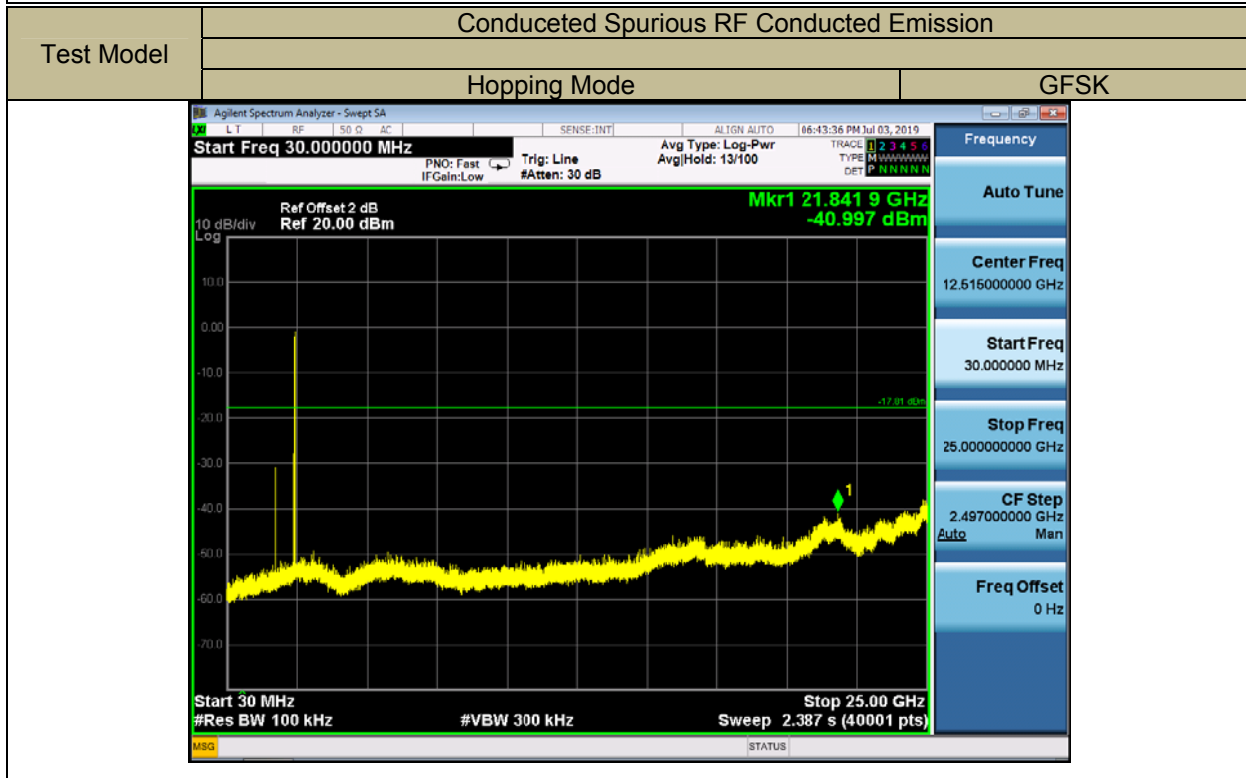
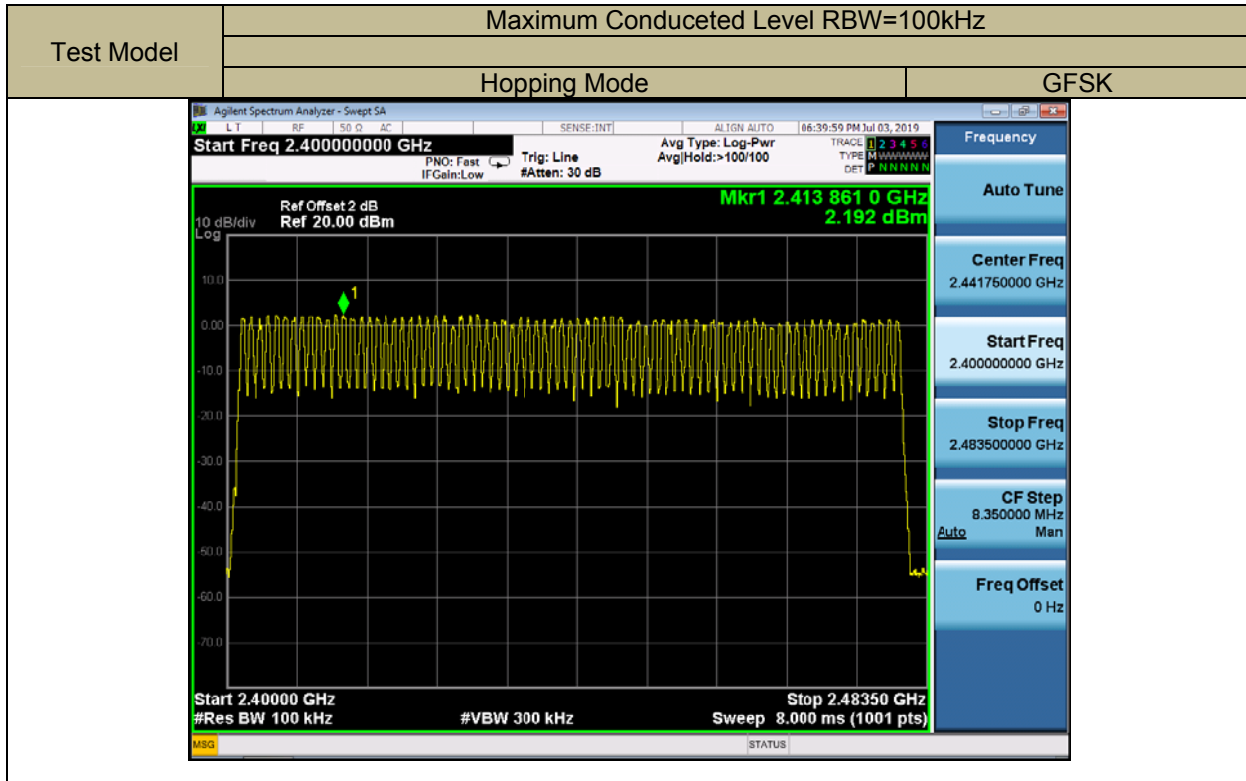

|            |                               |      |
|------------|-------------------------------|------|
| Test Model | Band-edge Conducted Emissions |      |
|            | Hopping Mode                  | GFSK |

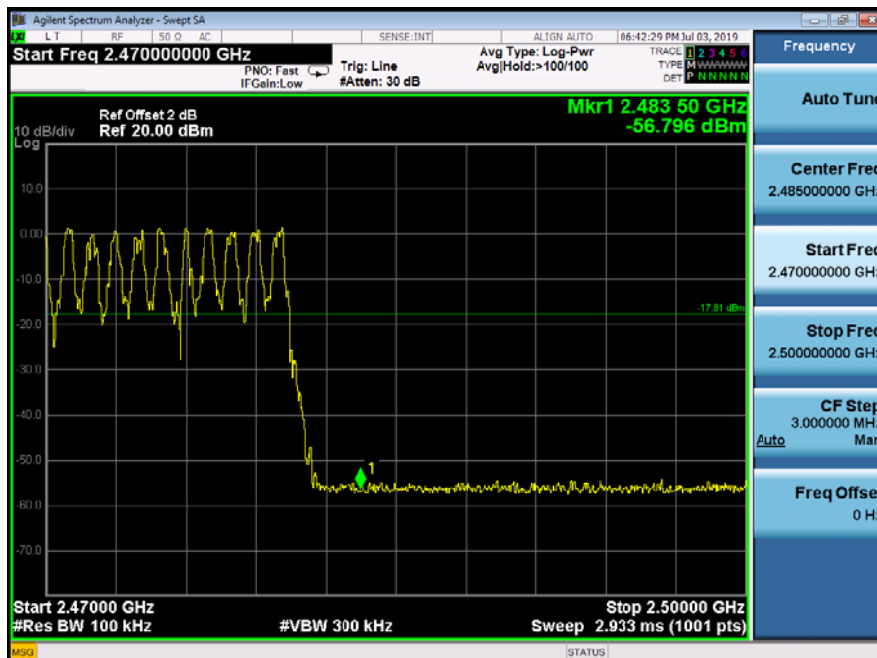
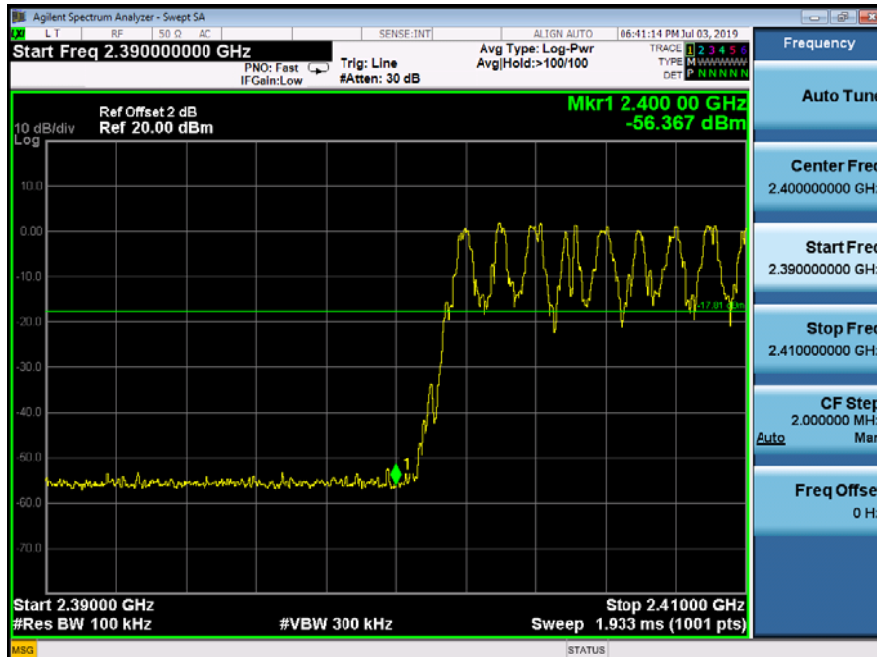

**9.7 RADIATED SPURIOUS EMISSION**

**9.7.1 Applicable Standard**

According to FCC Part 15.247(d) and 15.209 and DA 00-705

**9.7.2 Conformance Limit**

According to FCC Part 15.247(d): radiated emissions which fall in the restricted bands, as defined in §15.205(a), must also comply with the radiated emission limits specified in §15.209(a) (see §15.205(c)).  
According to FCC Part 15.205, Restricted bands

| MHz               | MHz                 | MHz           | GHz         |
|-------------------|---------------------|---------------|-------------|
| 0.090-0.110       | 16.42-16.423        | 399.9-410     | 4.5-5.15    |
| 10.495-0.505      | 16.69475-16.69525   | 608-614       | 5.35-5.46   |
| 2.1735-2.1905     | 16.80425-16.80475   | 960-1240      | 7.25-7.75   |
| 4.125-4.128       | 25.5-25.67          | 1300-1427     | 8.025-8.5   |
| 4.17725-4.17775   | 37.5-38.25          | 1435-1626.5   | 9.0-9.2     |
| 4.20725-4.20775   | 73-74.6             | 1645.5-1646.5 | 9.3-9.5     |
| 6.215-6.218       | 74.8-75.2           | 1660-1710     | 10.6-12.7   |
| 6.26775-6.26825   | 123-138             | 2200-2300     | 14.47-14.5  |
| 8.291-8.294       | 149.9-150.05        | 2310-2390     | 15.35-16.2  |
| 8.362-8.366       | 156.52475-156.52525 | 2483.5-2500   | 17.7-21.4   |
| 8.37625-8.38675   | 156.7-156.9         | 2690-2900     | 22.01-23.12 |
| 8.41425-8.41475   | 162.0125-167.17     | 3260-3267     | 23.6-24.0   |
| 12.29-12.293      | 167.72-173.2        | 3332-3339     | 31.2-31.8   |
| 12.51975-12.52025 | 240-285             | 3345.8-3358   | 36.43-36.5  |
| 12.57675-12.57725 | 322-335.4           | 3600-4400     | (2)         |
| 13.36-13.41       |                     |               |             |

According to FCC Part 15.205, the level of any transmitter spurious emission in Restricted bands shall not exceed the level of the emission specified in the following table

| Restricted Frequency(MHz) | Field Strength (µV/m) | Field Strength (dBµV/m) | Measurement Distance |
|---------------------------|-----------------------|-------------------------|----------------------|
| 0.009-0.490               | 2400/F(KHz)           | 20 log (uV/m)           | 300                  |
| 0.490-1.705               | 2400/F(KHz)           | 20 log (uV/m)           | 30                   |
| 1.705-30                  | 30                    | 29.5                    | 30                   |
| 30-88                     | 100                   | 40                      | 3                    |
| 88-216                    | 150                   | 43.5                    | 3                    |
| 216-960                   | 200                   | 46                      | 3                    |
| Above 960                 | 500                   | 54                      | 3                    |

**9.7.3 Test Configuration**

Test according to clause 7.2 radio frequency test setup 2

**9.7.4 Test Procedure**

This test is required for any spurious emission that falls in a Restricted Band, as defined in Section 15.205. It must be performed with the highest gain of each type of antenna proposed for use with the EUT. Use the following spectrum analyzer settings:

The EUT was placed on a turn table which is 0.8m above ground plane.

Maximum procedure was performed on the highest emissions to ensure EUT compliance.

Span = wide enough to fully capture the emission being measured

RBW = 1 MHz for f ≥ 1 GHz(1GHz to 25GHz), 100 kHz for f < 1 GHz(30MHz to 1GHz)

VBW ≥ RBW

Sweep = auto

Detector function = peak

Trace = max hold

Follow the guidelines in ANSI C63.10-2013 respect to maximizing the emission by rotating the EUT, measuring the emission while the EUT is situated in three orthogonal planes (if appropriate), adjusting the measurement antenna height and polarization, etc. A pre-amp and a high pass filter are required for this test, in order to provide the measuring system with sufficient sensitivity. Allow the trace to stabilize. The peak reading of the emission, after being corrected by the antenna factor, cable loss, pre-amp gain, etc., is the peak field strength, which must comply with the limit specified in Section 15.35(b). Submit this data.

Now set the VBW to 10 Hz, while maintaining all of the other instrument settings. This peak level, once corrected, must comply with the limit specified in Section 15.209. If the dwell time per channel of the hopping signal is less than 100 ms, then the reading obtained with the 10 Hz VBW may be further adjusted by a “duty cycle correction factor”, derived from  $20\log(\text{dwell time}/100 \text{ ms})$ , in an effort to demonstrate compliance with the 15.209 limit. Submit this data.

Repeat above procedures until all frequency measured was complete.

**9.7.5 Test Results**

■ Spurious Emission below 30MHz(9KHz to 30MHz)

Temperature: 29.5°C                      Test Date: June 30, 2019  
 Humidity: 48 %                             Test By: KK  
 Test mode: TX Mode

| Freq. (MHz) | Ant.Pol. H/V | Emission Level(dBuV/m) |    | Limit 3m(dBuV/m) |    | Over(dB) |    |
|-------------|--------------|------------------------|----|------------------|----|----------|----|
|             |              | PK                     | AV | PK               | AV | PK       | AV |
| --          | --           | --                     | -- | --               | -- | --       | -- |

Note: the amplitude of spurious emission that is attenuated by more than 20dB below the permissible limit has no need to be reported.

Distance extrapolation factor =  $40\log(\text{Specific distance}/ \text{test distance})$  ( dB);

Limit line=Specific limits(dBuV) + distance extrapolation factor

■ Spurious Emission Above 1GHz(1GHz to 25GHz)

Bluetooth (GFSK, pi/4-DQPSK, 8DPSK, Hopping) mode have been tested, and the worst result(GFSK)was report as below:

Temperature: 29.5°C                      Test Date: June 30, 2019  
 Humidity: 48 %                             Test By: KK  
 Test mode: GFSK                            Frequency: Channel 0: 2402MHz

| Freq. (MHz) | Ant.Pol. H/V | Emission Level(dBuV/m) |       | Limit 3m(dBuV/m) |    | Over(dB) |        |
|-------------|--------------|------------------------|-------|------------------|----|----------|--------|
|             |              | PK                     | AV    | PK               | AV | PK       | AV     |
| 1585.650    | V            | 46.51                  | 33.26 | 74               | 54 | -27.49   | -20.74 |
| 11398.05    | V            | 54.86                  | 39.57 | 74               | 54 | -19.14   | -14.43 |
| 17909.05    | V            | 58.00                  | 42.07 | 74               | 54 | -16.00   | -11.93 |
| 1732.700    | H            | 44.55                  | 32.47 | 74               | 54 | -29.45   | -21.53 |
| 9934.350    | H            | 54.18                  | 40.18 | 74               | 54 | -19.82   | -13.82 |
| 17977.90    | H            | 57.52                  | 41.43 | 74               | 54 | -16.48   | -12.57 |

Temperature: 29.5°C  
 Humidity: 48 %  
 Test mode: GFSK

Test Date: June 30, 2019  
 Test By: KK  
 Frequency: Channel 39: 2441MHz

| Freq. (MHz) | Ant.Pol. H/V | Emission Level(dBuV/m) |       | Limit 3m(dBuV/m) |    | Over(dB) |        |
|-------------|--------------|------------------------|-------|------------------|----|----------|--------|
|             |              | PK                     | AV    | PK               | AV | PK       | AV     |
| 1606.900    | V            | 44.45                  | 32.14 | 74               | 54 | -29.55   | -21.86 |
| 11707.45    | V            | 55.86                  | 40.22 | 74               | 54 | -18.14   | -13.78 |
| 17967.70    | V            | 57.01                  | 41.62 | 74               | 54 | -16.99   | -12.38 |
| 1661.300    | H            | 45.31                  | 33.14 | 74               | 54 | -28.69   | -20.86 |
| 11493.25    | H            | 56.54                  | 40.15 | 74               | 54 | -17.46   | -13.85 |
| 17909.90    | H            | 57.57                  | 41.54 | 74               | 54 | -16.43   | -12.46 |

Temperature: 29.5°C  
 Humidity: 48 %  
 Test mode: GFSK

Test Date: June 30, 2019  
 Test By: KK  
 Frequency: Channel 78: 2480MHz

| Freq. (MHz) | Ant.Pol. H/V | Emission Level(dBuV/m) |       | Limit 3m(dBuV/m) |    | Over(dB) |        |
|-------------|--------------|------------------------|-------|------------------|----|----------|--------|
|             |              | PK                     | AV    | PK               | AV | PK       | AV     |
| 1708.900    | V            | 45.73                  | 32.67 | 74               | 54 | -28.27   | -21.33 |
| 10162.15    | V            | 55.02                  | 39.62 | 74               | 54 | -18.98   | -14.38 |
| 17901.40    | V            | 57.23                  | 41.27 | 74               | 54 | -16.77   | -12.73 |
| 1677.450    | H            | 44.86                  | 32.64 | 74               | 54 | -29.14   | -21.36 |
| 10588.85    | H            | 53.88                  | 39.43 | 74               | 54 | -20.12   | -14.57 |
| 17897.15    | H            | 57.47                  | 41.27 | 74               | 54 | -16.53   | -12.73 |

- Note:**
- (1) All Readings are Peak Value (VBW=3MHz) and Average Value (VBW=10Hz).
  - (2) Emission Level= Reading Level+Probe Factor +Cable Loss.
  - (3) Data of measurement within this frequency range shown "--" in the table above means the reading of emissions are attenuated more than 20dB below the permissible limits or the field strength is too small to be measured.



■ Spurious Emission in Restricted Band 2310-2390MHz and 2483.5-2500MHz

Bluetooth (GFSK, pi/4-DQPSK, 8DPSK, Hopping) mode have been tested, and the worst result(GFSK, Hopping) was report as below:

|              |       |            |                    |
|--------------|-------|------------|--------------------|
| Temperature: | 24 °C | Test Date: | June 30, 2019      |
| Humidity:    | 53 %  | Test By:   | KK                 |
| Test mode:   | GFSK  | Frequency: | Channel 0: 2402MHz |

| Frequency (MHz) | Polarity H/V | PK(dBuV/m) (VBW=3MHz) | Limit 3m (dBuV/m) | Over(dB) | AV(dBuV/m) (VBW=10Hz) | Limit 3m (dBuV/m) | Over (dB) |
|-----------------|--------------|-----------------------|-------------------|----------|-----------------------|-------------------|-----------|
| 2386.456        | H            | 48.09                 | 74                | -25.91   | 33.58                 | 54                | -20.42    |
| 2382.024        | V            | 47.10                 | 74                | -26.90   | 34.57                 | 54                | -19.43    |

|              |       |            |                     |
|--------------|-------|------------|---------------------|
| Temperature: | 24 °C | Test Date: | June 30, 2019       |
| Humidity:    | 53 %  | Test By:   | KK                  |
| Test mode:   | GFSK  | Frequency: | Channel 78: 2480MHz |

| Frequency (MHz) | Polarity H/V | PK(dBuV/m) (VBW=3MHz) | Limit 3m (dBuV/m) | Over(dB) | AV(dBuV/m) (VBW=10Hz) | Limit 3m (dBuV/m) | Over (dB) |
|-----------------|--------------|-----------------------|-------------------|----------|-----------------------|-------------------|-----------|
| 2483.531        | H            | 51.90                 | 74                | -22.10   | 37.25                 | 54                | -16.75    |
| 2483.736        | V            | 47.50                 | 74                | -26.50   | 33.47                 | 54                | -20.53    |

|              |       |            |               |
|--------------|-------|------------|---------------|
| Temperature: | 24 °C | Test Date: | June 30, 2019 |
| Humidity:    | 53 %  | Test By:   | KK            |
| Test mode:   | GFSK  | Frequency: | Hopping       |

| Frequency (MHz) | Polarity H/V | PK(dBuV/m) (VBW=3MHz) | Limit 3m (dBuV/m) | Over(dB) | AV(dBuV/m) (VBW=10Hz) | Limit 3m (dBuV/m) | Over (dB) |
|-----------------|--------------|-----------------------|-------------------|----------|-----------------------|-------------------|-----------|
| 2390.000        | H            | 45.62                 | 74                | -28.38   | 31.58                 | 54                | -22.42    |
| 2483.500        | H            | 45.05                 | 74                | -28.95   | 32.41                 | 54                | -21.59    |
| 2390.000        | V            | 45.56                 | 74                | -28.44   | 32.47                 | 54                | -21.53    |
| 2483.500        | V            | 44.76                 | 74                | -29.24   | 31.24                 | 54                | -22.76    |

- Note:** (1) All Readings are Peak Value (VBW=3MHz) and Average Value (VBW=10Hz).  
 (2) Emission Level= Reading Level+Probe Factor +Cable Loss.  
 (3) Data of measurement within this frequency range shown “ -- ” in the table above means the reading of emissions are attenuated more than 20dB below the permissible limits or the field strength is too small to be measured.

|            |   |      |   |
|------------|---|------|---|
| Test Model | Spurious Emission in Restricted Band 2310-2390MHz |      |   |
|            | Channel 0: 2402MHz                                | GFSK | H |

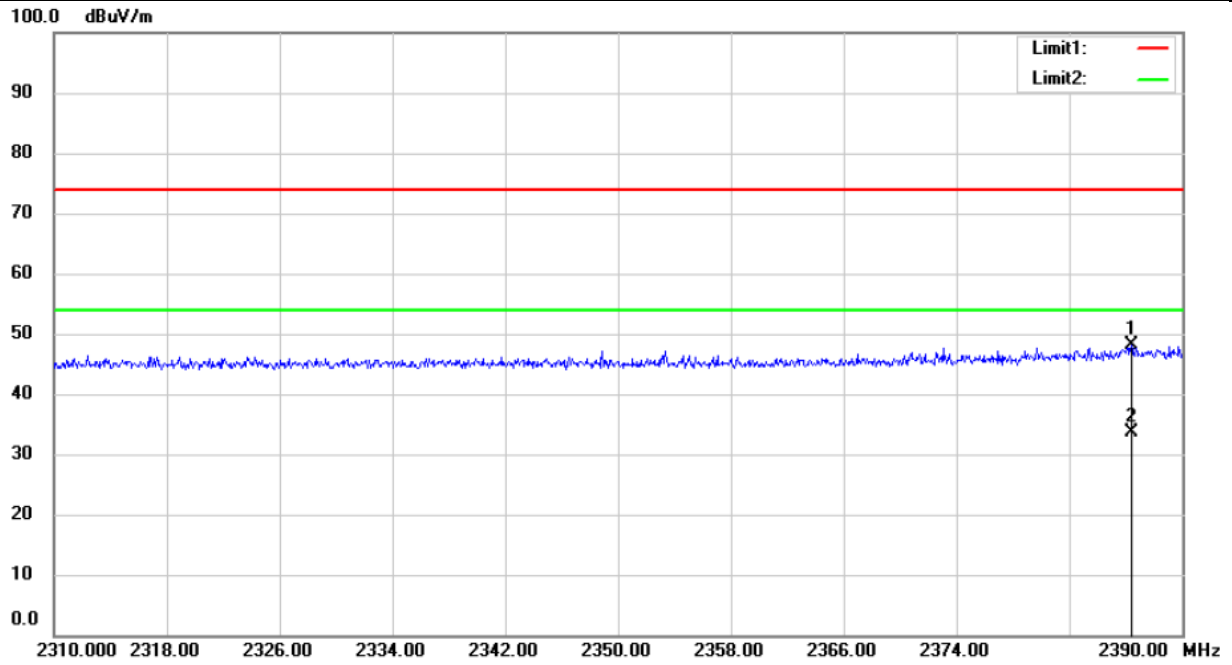

|            |   |      |   |
|------------|---|------|---|
| Test Model | Spurious Emission in Restricted Band 2310-2390MHz |      |   |
|            | Channel 0: 2402MHz                                | GFSK | V |

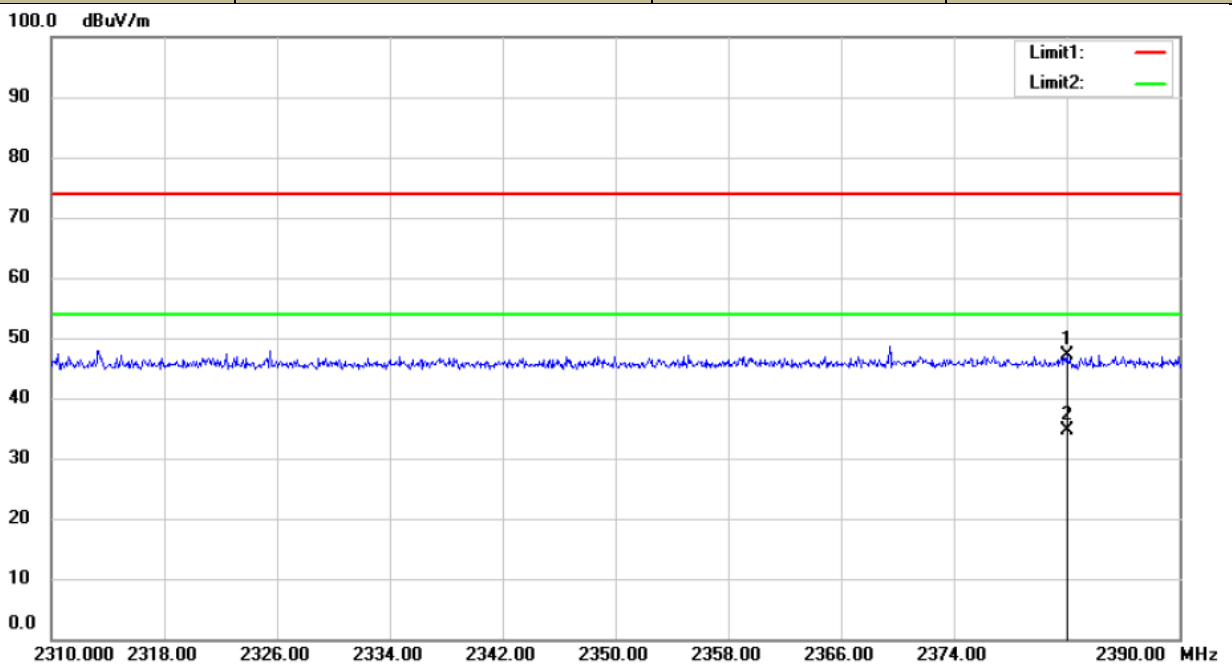

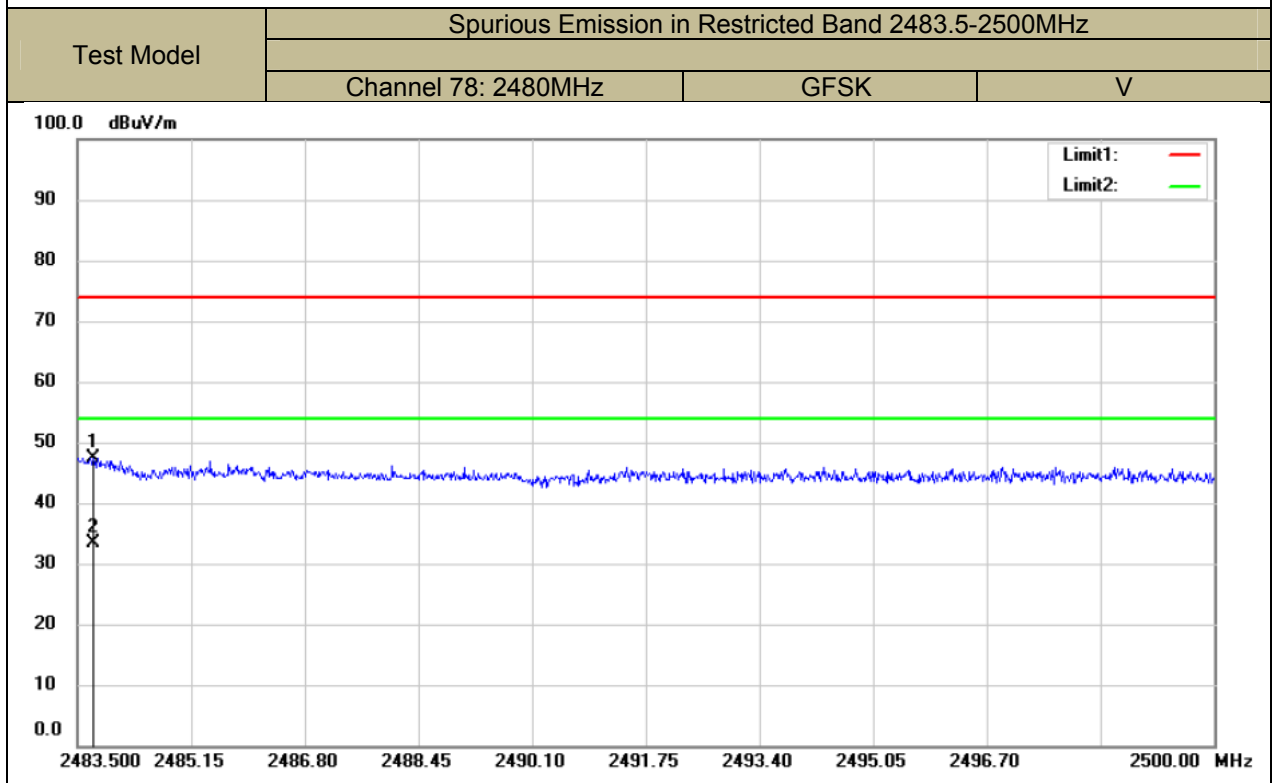
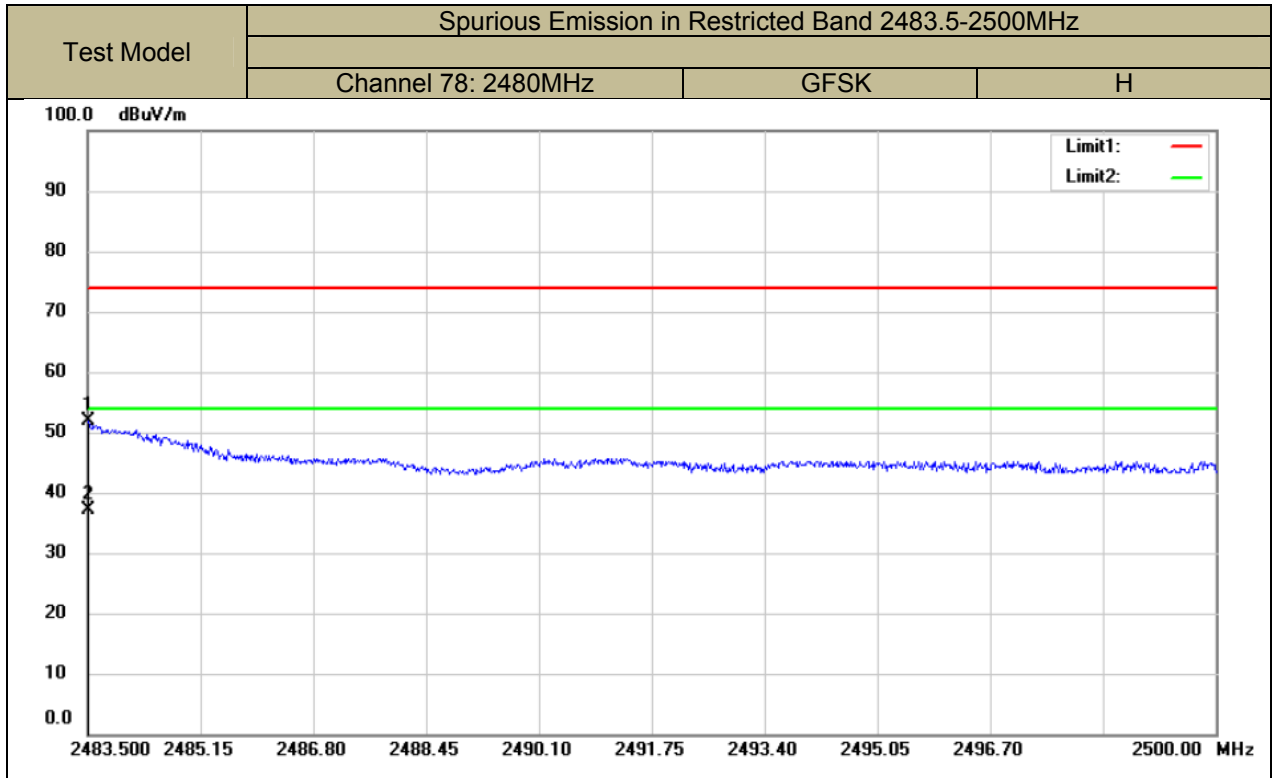

|            |   |      |   |
|------------|---|------|---|
| Test Model | Spurious Emission in Restricted Band 2310-2390&2483.5-2500MHz |      |   |
|            | Hopping   | GFSK | H |

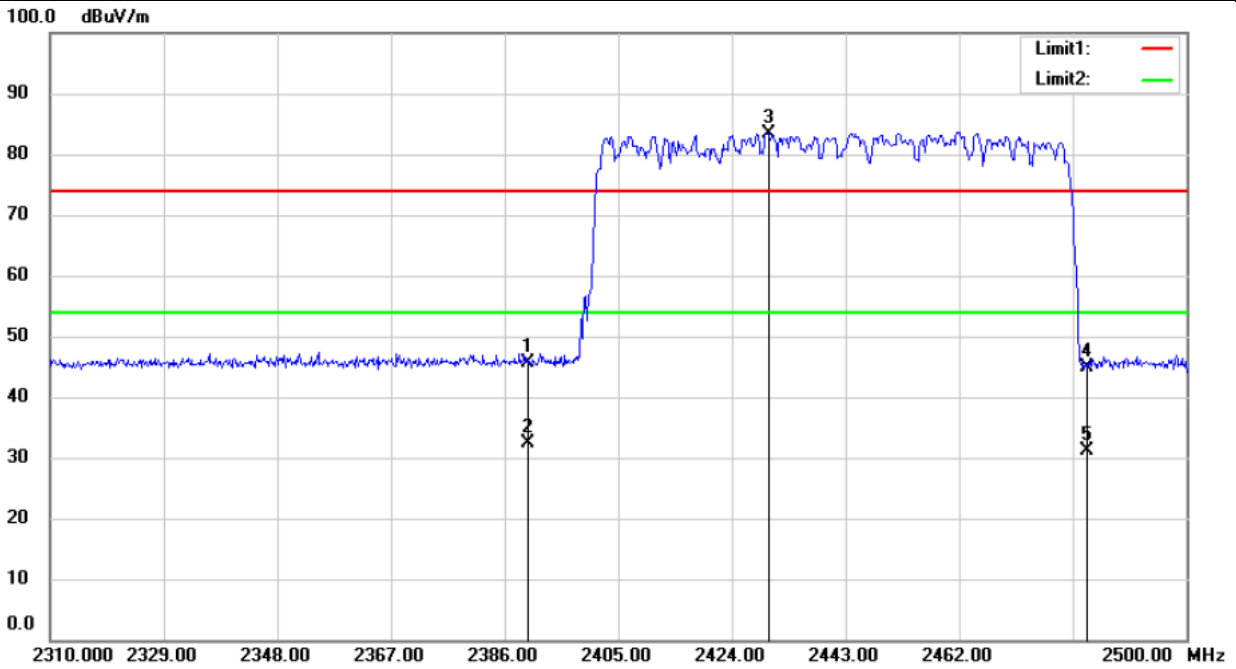

|            |   |      |   |
|------------|---|------|---|
| Test Model | Spurious Emission in Restricted Band 2310-2390&2483.5-2500MHz |      |   |
|            | Hopping   | GFSK | V |

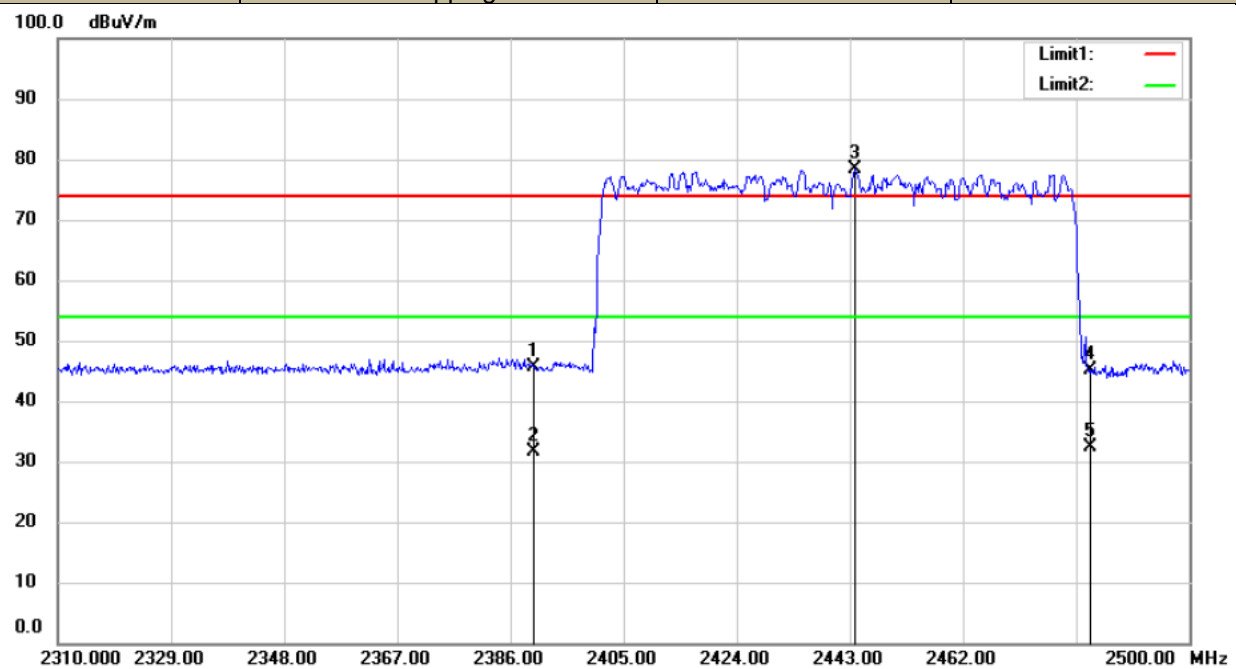

■ Spurious Emission below 1GHz(30MHz to 1GHz)  
Bluetooth (GFSK, pi/4-DQPSK, 8DPSK)modehave been tested, and the worst result recorded was report as below:

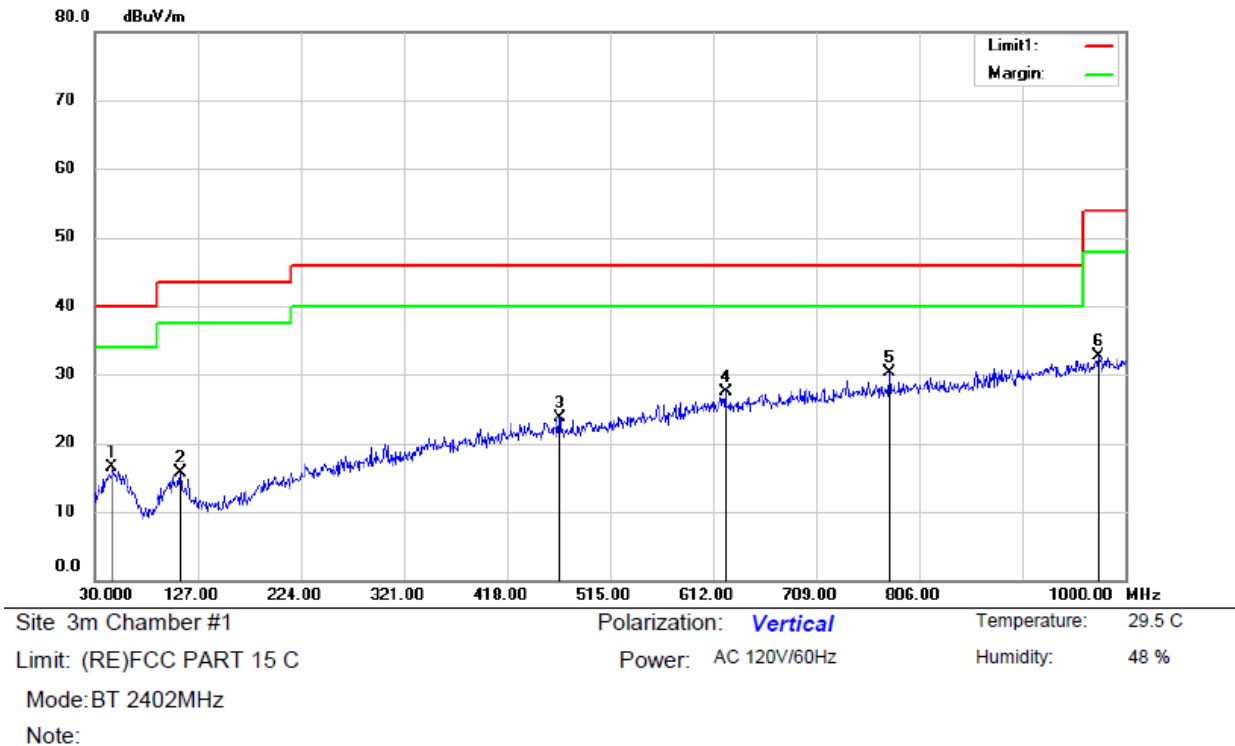

| No. | Mk. | Freq.<br>MHz | Reading<br>Level<br>dBuV | Correct<br>Factor<br>dB | Measure-<br>ment<br>dBuV/m | Limit<br>dBuV/m | Over<br>dB | Detector | Antenna<br>Height<br>cm | Table<br>Degree<br>degree | Comment |
|-----|-----|--------------|--------------------------|-------------------------|----------------------------|-----------------|------------|----------|-------------------------|---------------------------|---------|
| 1   |     | 46.4900      | 27.75                    | -11.27                  | 16.48                      | 40.00           | -23.52     | QP       |                         |                           |         |
| 2   |     | 110.5100     | 28.25                    | -12.64                  | 15.61                      | 43.50           | -27.89     | QP       |                         |                           |         |
| 3   |     | 467.4700     | 28.92                    | -5.21                   | 23.71                      | 46.00           | -22.29     | QP       |                         |                           |         |
| 4   |     | 623.6400     | 29.49                    | -1.89                   | 27.60                      | 46.00           | -18.40     | QP       |                         |                           |         |
| 5   | *   | 777.8700     | 30.29                    | 0.10                    | 30.39                      | 46.00           | -15.61     | QP       |                         |                           |         |
| 6   |     | 974.7800     | 29.35                    | 3.39                    | 32.74                      | 54.00           | -21.26     | QP       |                         |                           |         |

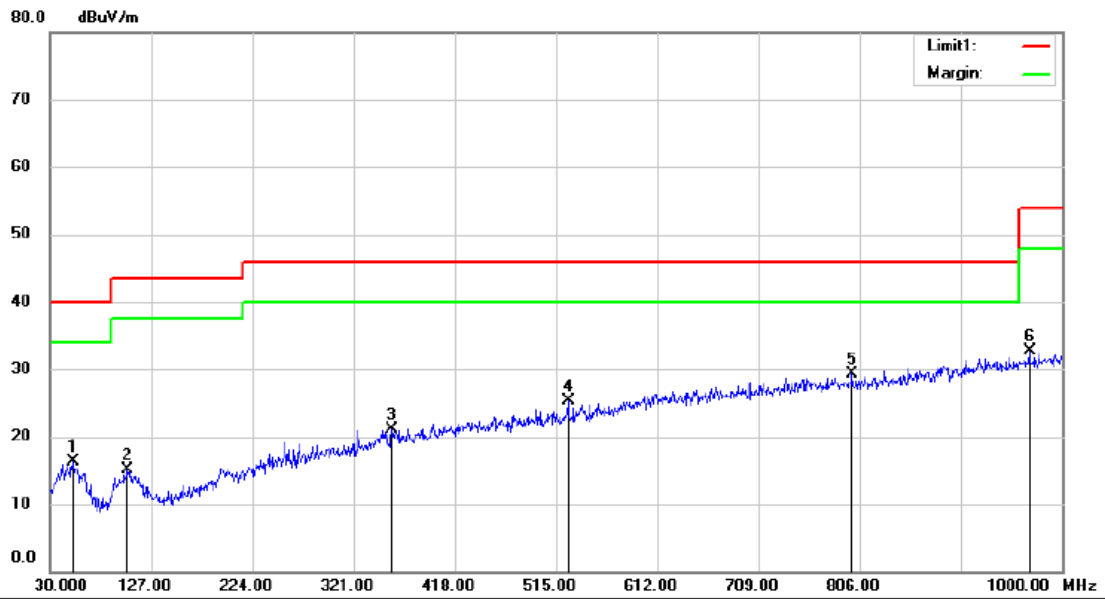

Site 3m Chamber #1      Polarization: **Horizontal**      Temperature: 29.5 C  
 Limit: (RE)FCC PART 15 C      Power: AC 120V/60Hz      Humidity: 48 %  
 Mode: BT 2402MHz  
 Note:

| No. | Mk. | Freq.<br>MHz | Reading<br>Level<br>dBuV | Correct<br>Factor<br>dB | Measure-<br>ment<br>dBuV/m | Limit<br>dBuV/m | Over<br>dB | Antenna<br>Height<br>cm | Table<br>Degree<br>degree | Comment |
|-----|-----|--------------|--------------------------|-------------------------|----------------------------|-----------------|------------|-------------------------|---------------------------|---------|
| 1   |     | 52.3100      | 27.49                    | -11.17                  | 16.32                      | 40.00           | -23.68     | QP                      |                           |         |
| 2   |     | 104.6900     | 27.36                    | -12.29                  | 15.07                      | 43.50           | -28.43     | QP                      |                           |         |
| 3   |     | 357.8600     | 27.87                    | -6.82                   | 21.05                      | 46.00           | -24.95     | QP                      |                           |         |
| 4   |     | 526.6400     | 29.56                    | -4.22                   | 25.34                      | 46.00           | -20.66     | QP                      |                           |         |
| 5   | *   | 799.2100     | 28.98                    | 0.27                    | 29.25                      | 46.00           | -16.75     | QP                      |                           |         |
| 6   |     | 968.9600     | 29.42                    | 3.25                    | 32.67                      | 54.00           | -21.33     | QP                      |                           |         |

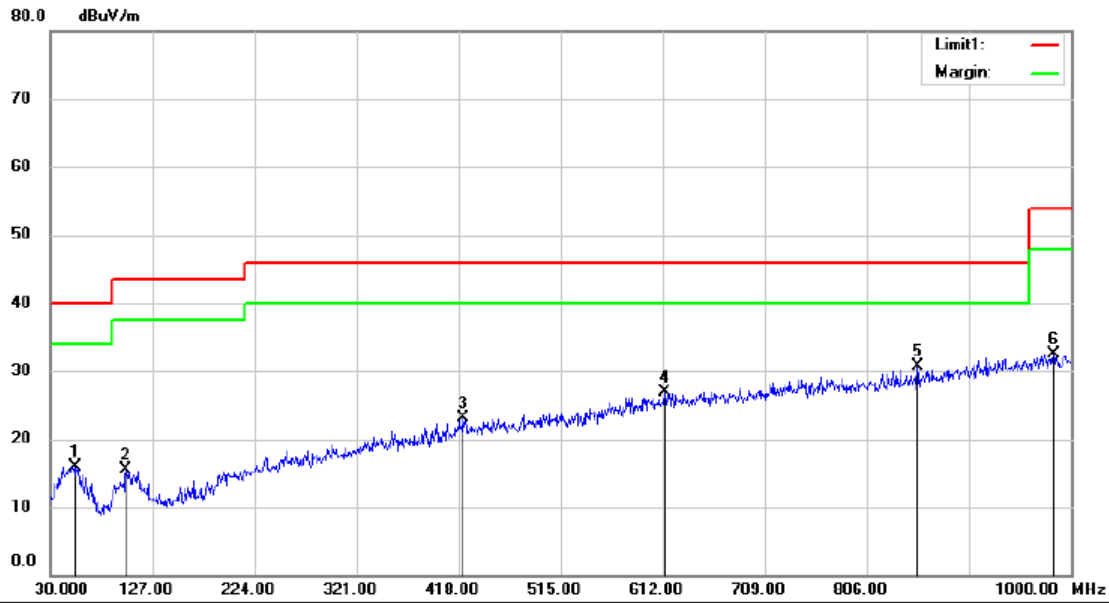

Site 3m Chamber #1      Polarization: **Vertical**      Temperature: 29.5 C  
 Limit: (RE)FCC PART 15 C      Power: AC 120V/60Hz      Humidity: 48 %  
 Mode: BT 2441MHz  
 Note:

| No. | Mk. | Freq.<br>MHz | Reading<br>Level<br>dBuV | Correct<br>Factor<br>dB | Measure-<br>ment<br>dBuV/m | Limit<br>dBuV/m | Over<br>dB | Antenna<br>Height<br>cm | Table<br>Degree<br>degree | Comment |
|-----|-----|--------------|--------------------------|-------------------------|----------------------------|-----------------|------------|-------------------------|---------------------------|---------|
| 1   |     | 54.2500      | 27.40                    | -11.46                  | 15.94                      | 40.00           | -24.06     | QP                      |                           |         |
| 2   |     | 101.7800     | 27.98                    | -12.50                  | 15.48                      | 43.50           | -28.02     | QP                      |                           |         |
| 3   |     | 421.8800     | 28.69                    | -5.55                   | 23.14                      | 46.00           | -22.86     | QP                      |                           |         |
| 4   |     | 613.9400     | 28.90                    | -1.98                   | 26.92                      | 46.00           | -19.08     | QP                      |                           |         |
| 5   | *   | 854.5000     | 29.60                    | 1.05                    | 30.65                      | 46.00           | -15.35     | QP                      |                           |         |
| 6   |     | 983.5100     | 28.81                    | 3.61                    | 32.42                      | 54.00           | -21.58     | QP                      |                           |         |

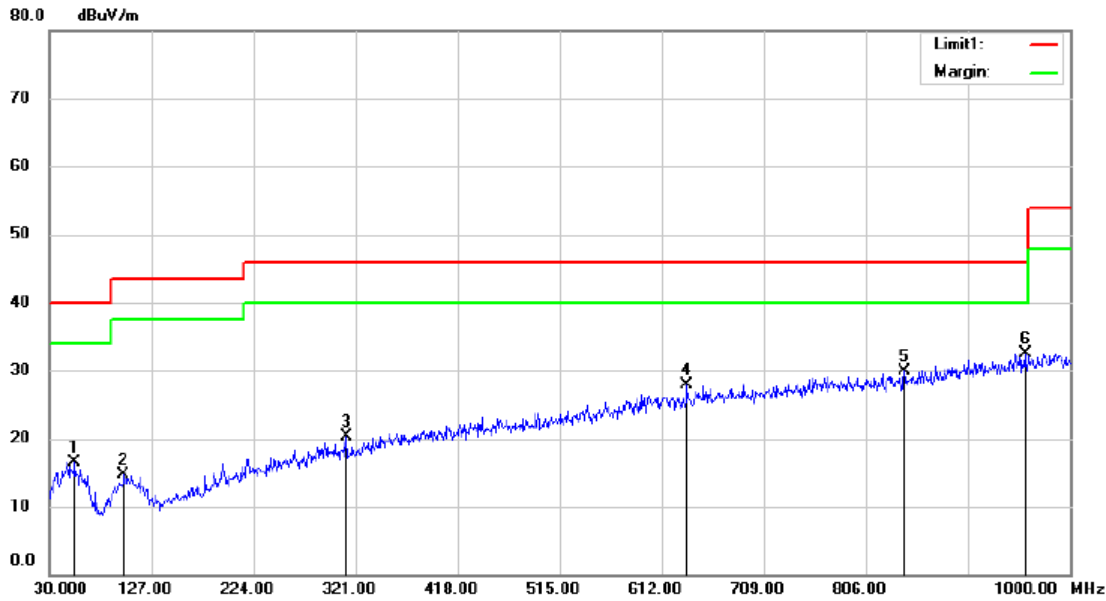

Site: 3m Chamber #1  
 Limit: (RE)FCC PART 15 C  
 Mode: BT 2441MHz  
 Note:

Polarization: *Horizontal*  
 Power: AC 120V/60Hz

Temperature: 29.5 C  
 Humidity: 48 %

| No. | Mk. | Freq.<br>MHz | Reading<br>Level<br>dBuV | Correct<br>Factor<br>dB | Measure-<br>ment<br>dBuV/m | Limit<br>dBuV/m | Over<br>dB | Antenna<br>Height<br>cm | Table<br>Degree<br>degree | Comment |
|-----|-----|--------------|--------------------------|-------------------------|----------------------------|-----------------|------------|-------------------------|---------------------------|---------|
| 1   |     | 54.2500      | 27.93                    | -11.46                  | 16.47                      | 40.00           | -23.53     | QP                      |                           |         |
| 2   |     | 100.8100     | 27.25                    | -12.59                  | 14.66                      | 43.50           | -28.84     | QP                      |                           |         |
| 3   |     | 312.2700     | 28.39                    | -8.07                   | 20.32                      | 46.00           | -25.68     | QP                      |                           |         |
| 4   |     | 636.2500     | 29.77                    | -1.81                   | 27.96                      | 46.00           | -18.04     | QP                      |                           |         |
| 5   |     | 842.8600     | 29.05                    | 0.85                    | 29.90                      | 46.00           | -16.10     | QP                      |                           |         |
| 6   | *   | 957.3200     | 29.46                    | 3.13                    | 32.59                      | 46.00           | -13.41     | QP                      |                           |         |





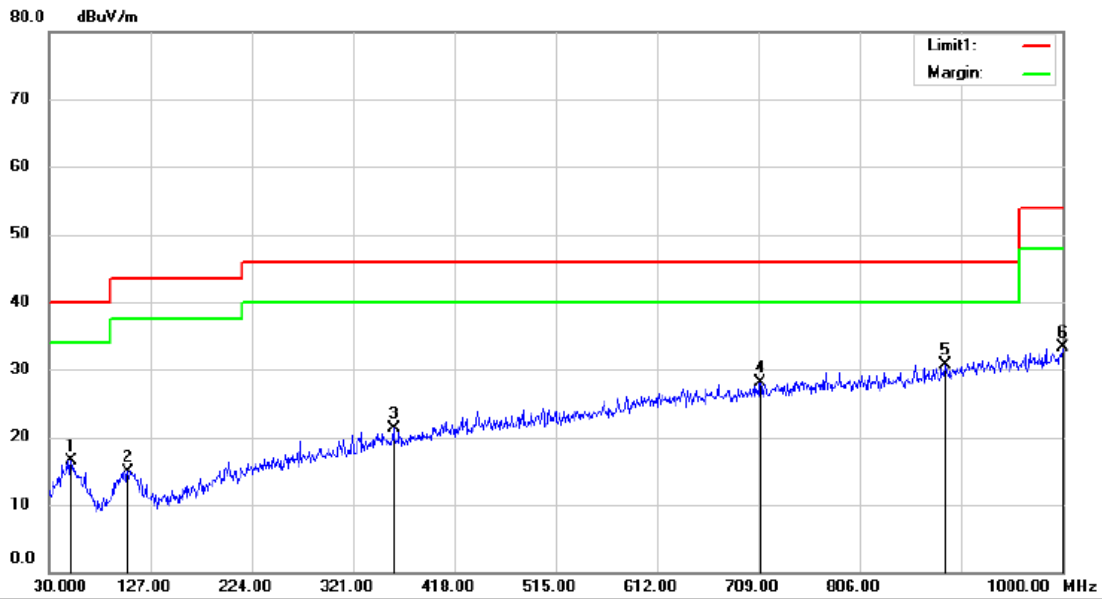

Site: 3m Chamber #1      Polarization: **Horizontal**      Temperature: 29.5 C  
 Limit: (RE)FCC PART 15 C      Power: AC 120V/60Hz      Humidity: 48 %  
 Mode: BT 2480MHz  
 Note:

| No. | Mk. | Freq.<br>MHz | Reading<br>Level<br>dBuV | Correct<br>Factor<br>dB | Measure-<br>ment<br>dBuV/m | Limit<br>dBuV/m | Over<br>dB | Antenna<br>Height<br>cm | Table<br>Degree<br>degree | Comment |
|-----|-----|--------------|--------------------------|-------------------------|----------------------------|-----------------|------------|-------------------------|---------------------------|---------|
| 1   |     | 51.3400      | 27.76                    | -11.17                  | 16.59                      | 40.00           | -23.41     | QP                      |                           |         |
| 2   |     | 105.6600     | 27.20                    | -12.29                  | 14.91                      | 43.50           | -28.59     | QP                      |                           |         |
| 3   |     | 359.8000     | 28.18                    | -6.84                   | 21.34                      | 46.00           | -24.66     | QP                      |                           |         |
| 4   |     | 710.9400     | 29.01                    | -0.84                   | 28.17                      | 46.00           | -17.83     | QP                      |                           |         |
| 5   | *   | 888.4500     | 28.94                    | 1.70                    | 30.64                      | 46.00           | -15.36     | QP                      |                           |         |
| 6   |     | 1000.0000    | 29.29                    | 3.93                    | 33.22                      | 54.00           | -20.78     | QP                      |                           |         |

## 9.8 CONDUCTED EMISSION TEST

### 9.8.1 Applicable Standard

According to FCC Part 15.207(a)

### 9.8.2 Conformance Limit

| Frequency(MHz) | Conducted Emission Limit |         |
|----------------|--------------------------|---------|
|                | Quasi-peak               | Average |
| 0.15-0.5       | 66-56                    | 56-46   |
| 0.5-5.0        | 56                       | 46      |
| 5.0-30.0       | 60                       | 50      |

Note: 1. The lower limit shall apply at the transition frequencies  
2. The limit decreases in line with the logarithm of the frequency in the range of 0.15 to 0.50MHz.

### 9.8.3 Test Configuration

Test according to clause 7.3 conducted emission test setup

### 9.8.4 Test Procedure

The EUT was placed on a table which is 0.8m above ground plane.  
Maximum procedure was performed on the highest emissions to ensure EUT compliance.  
Repeat above procedures until all frequency measured were complete.

### 9.8.5 Test Results

The 120V & 240V voltage have been tested, and the worst result recorded was report as below:

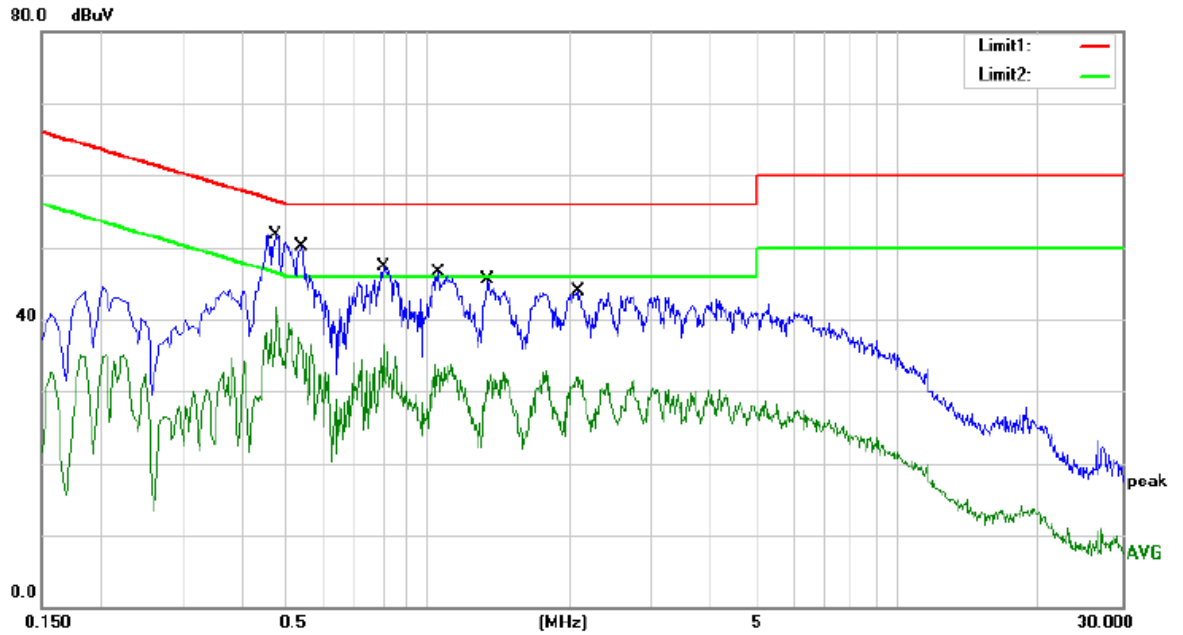

Site Conduction #2

Phase: **L1**

Temperature: 24.9

Limit: (CE)FCC PART 15 C

Power: AC 120V/60Hz

Humidity: 54 %

Mode: Charging+WIFI +BT connecting+Reading

Note:

| No. | Mk. | Freq.<br>MHz | Reading<br>Level<br>dBuV | Correct<br>Factor<br>dB | Measure-<br>ment<br>dBuV | Limit<br>dBuV | Over<br>dB | Detector | Comment |
|-----|-----|--------------|--------------------------|-------------------------|--------------------------|---------------|------------|----------|---------|
| 1   |     | 0.4740       | 38.04                    | 9.56                    | 47.60                    | 56.44         | -8.84      | QP       |         |
| 2   | *   | 0.4740       | 32.04                    | 9.56                    | 41.60                    | 46.44         | -4.84      | AVG      |         |
| 3   |     | 0.5380       | 36.64                    | 9.56                    | 46.20                    | 56.00         | -9.80      | QP       |         |
| 4   |     | 0.5380       | 30.03                    | 9.56                    | 39.59                    | 46.00         | -6.41      | AVG      |         |
| 5   |     | 0.8020       | 37.67                    | 9.58                    | 47.25                    | 56.00         | -8.75      | QP       |         |
| 6   |     | 0.8020       | 26.91                    | 9.58                    | 36.49                    | 46.00         | -9.51      | AVG      |         |
| 7   |     | 1.0540       | 36.83                    | 9.58                    | 46.41                    | 56.00         | -9.59      | QP       |         |
| 8   |     | 1.0540       | 24.15                    | 9.58                    | 33.73                    | 46.00         | -12.27     | AVG      |         |
| 9   |     | 1.3420       | 35.87                    | 9.58                    | 45.45                    | 56.00         | -10.55     | QP       |         |
| 10  |     | 1.3420       | 23.19                    | 9.58                    | 32.77                    | 46.00         | -13.23     | AVG      |         |
| 11  |     | 2.0860       | 34.32                    | 9.60                    | 43.92                    | 56.00         | -12.08     | QP       |         |
| 12  |     | 2.0860       | 22.35                    | 9.60                    | 31.95                    | 46.00         | -14.05     | AVG      |         |

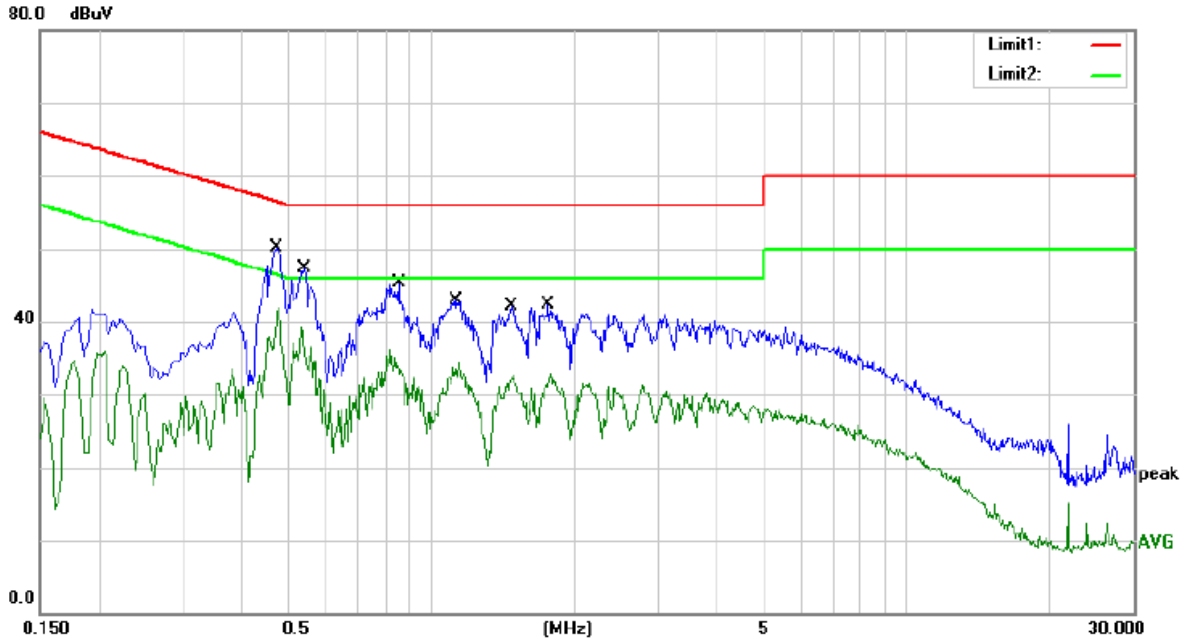

Site Conduction #2

Phase: **N**

Temperature: 24.9

Limit: (CE)FCC PART 15 C

Power: AC 120V/60Hz

Humidity: 54 %

Mode: Charging+WIFI +BT connecting+Reading

Note:

| No. | Mk. | Freq.<br>MHz | Reading<br>Level<br>dBuV | Correct<br>Factor<br>dB | Measure-<br>ment<br>dBuV | Limit<br>dBuV | Over<br>dB | Detector | Comment |
|-----|-----|--------------|--------------------------|-------------------------|--------------------------|---------------|------------|----------|---------|
| 1   |     | 0.4740       | 40.61                    | 9.56                    | 50.17                    | 56.44         | -6.27      | QP       |         |
| 2   | *   | 0.4740       | 32.36                    | 9.56                    | 41.92                    | 46.44         | -4.52      | AVG      |         |
| 3   |     | 0.5420       | 37.69                    | 9.56                    | 47.25                    | 56.00         | -8.75      | QP       |         |
| 4   |     | 0.5420       | 29.80                    | 9.56                    | 39.36                    | 46.00         | -6.64      | AVG      |         |
| 5   |     | 0.8540       | 35.75                    | 9.58                    | 45.33                    | 56.00         | -10.67     | QP       |         |
| 6   |     | 0.8540       | 26.52                    | 9.58                    | 36.10                    | 46.00         | -9.90      | AVG      |         |
| 7   |     | 1.1300       | 33.28                    | 9.58                    | 42.86                    | 56.00         | -13.14     | QP       |         |
| 8   |     | 1.1300       | 24.77                    | 9.58                    | 34.35                    | 46.00         | -11.65     | AVG      |         |
| 9   |     | 1.4780       | 32.44                    | 9.59                    | 42.03                    | 56.00         | -13.97     | QP       |         |
| 10  |     | 1.4780       | 23.01                    | 9.59                    | 32.60                    | 46.00         | -13.40     | AVG      |         |
| 11  |     | 1.7700       | 32.70                    | 9.59                    | 42.29                    | 56.00         | -13.71     | QP       |         |
| 12  |     | 1.7700       | 23.23                    | 9.59                    | 32.82                    | 46.00         | -13.18     | AVG      |         |

**9.9 ANTENNA APPLICATION**

**9.9.1 Antenna Requirement**

| Standard           | Requirement  |
|--------------------|--|
| FCC CRF Part15.203 | An intentional radiator shall be designed to ensure that no antenna other than that furnished by the responsible party shall be used with the device. The use of a permanently attached antenna or of an antenna that uses a unique coupling to the intentional radiator shall be considered sufficient to comply with the provisions of this section. The manufacturer may design the unit so that a broken antenna can be replaced by the user, but the use of a standard antenna jack or electrical connector is prohibited. This requirement does not apply to carrier current devices or to devices operated under the provisions of §15.211, §15.213, §15.217, §15.219, or §15.221. Further, this requirement does not apply to intentional radiators that must be professionally installed, such as perimeter protection systems and some field disturbance sensors, or to other intentional radiators which, in accordance with §15.31(d), must be measured at the installation site. However, the installer shall be responsible for ensuring that the proper antenna is employed so that the limits in this part are not exceeded. |

For intentional device, according to FCC 47 CFR Section 15.203, an intentional radiator shall be designed to ensure that no antenna other than that furnished by the responsible party shall be used with the device. And according to FCC 47 CFR Section 15.247 (b), if transmitting antennas of directional gain greater than 6dBi are used, the power shall be reduced by the amount in dB that the directional gain of the antenna exceeds 6dBi.

**9.9.2 Result**

The BT antenna is FPC antenna. The antenna's gain is 0.37 dBi, and the antenna can't be replaced by the user which in accordance to section 15.203, please refer to the photos.