



Antenna Test Report

**Manufacturer: Dongguan Yijia Electronic Communication
Technology Co., Ltd**

**Address: Building 3, No. 59 Muyu Road, Shatou Community,
Chang'an Town, Dongguan City, Guangdong Province**

Contents:

1. Device Profile

2. WiFi /BT Antenna Test

3. Assembly Picture

Tester :Yu Yafeng

Approval : Chen Guoqiang

Date : 2023 / 8/ 9





1. Device Profile

Device

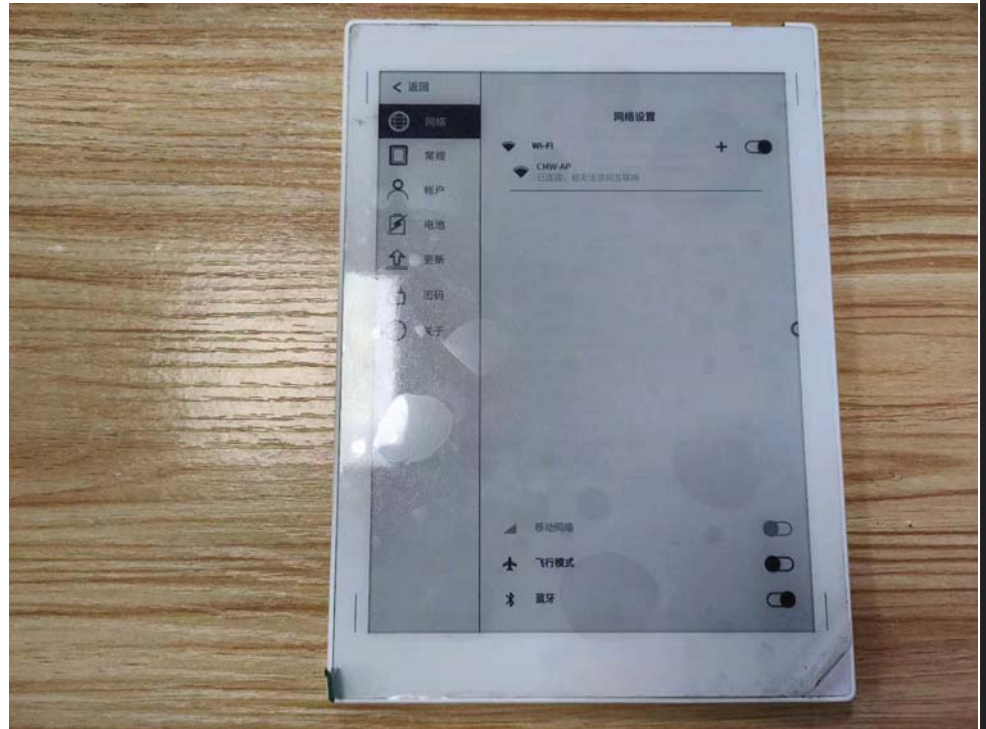



2. WIFI/BT Antenna Test

*WIFI
Antenna*

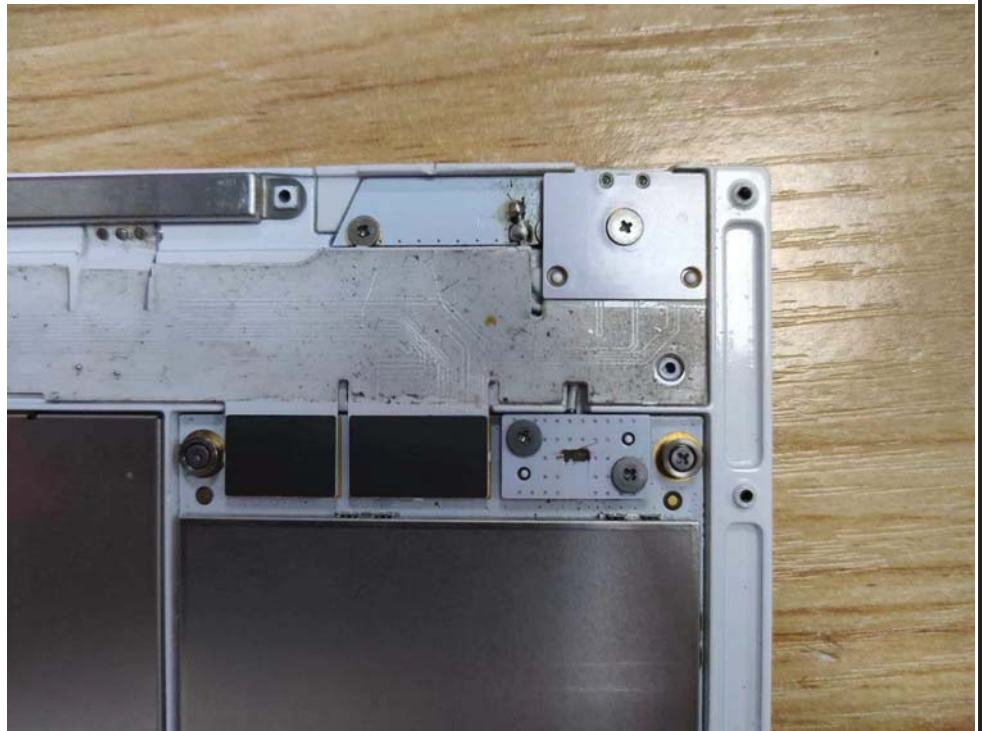



Agilent E5071B

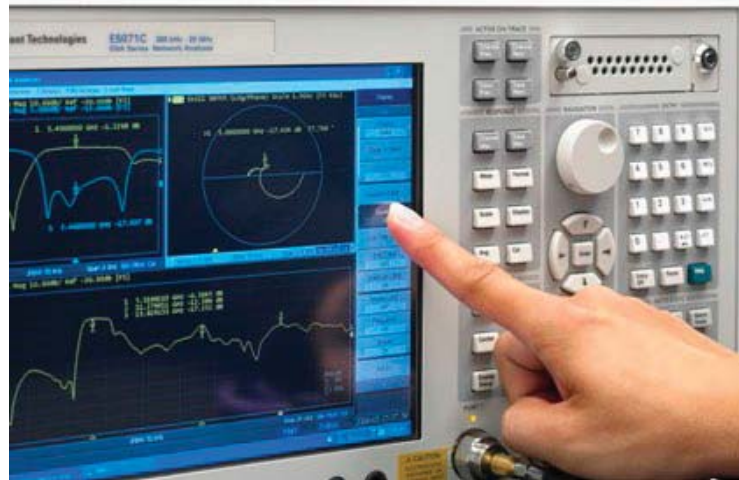

S Parameter Test // WIFI/BT Antenna

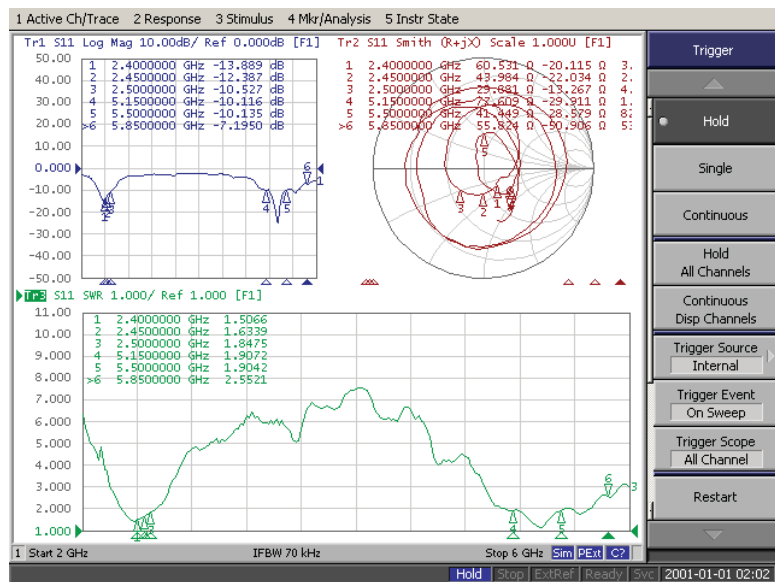



WIFI/BT Antenna Matching Circuit

Antenna

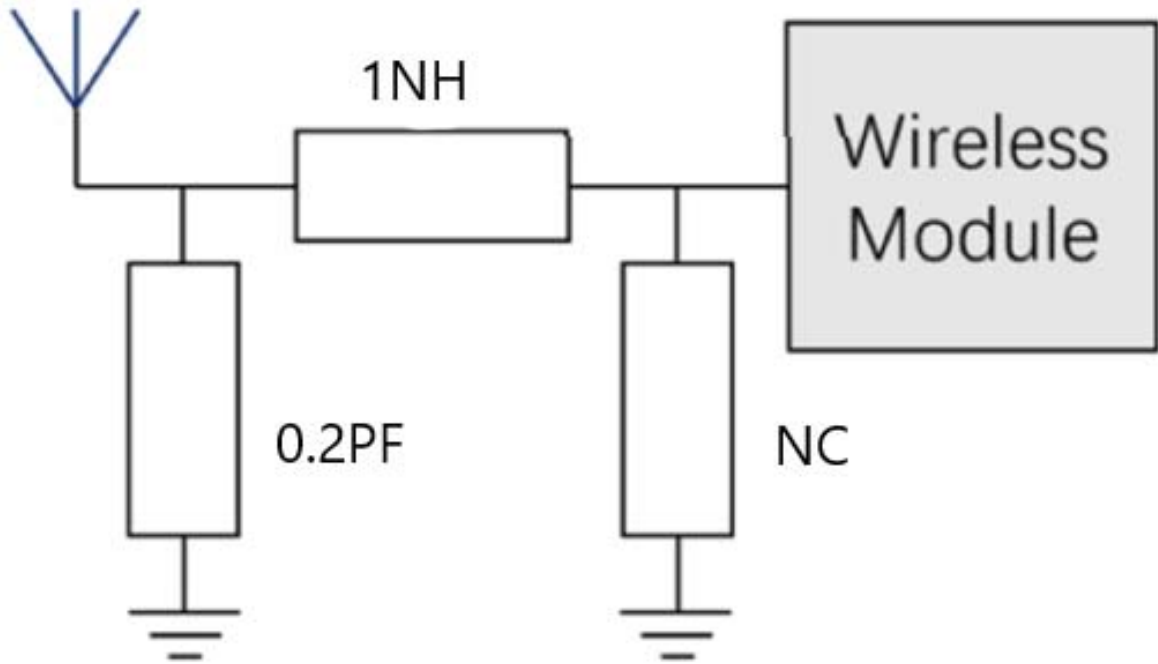



Passive Test For WiFi2.4G

Freq (MHz)	Effi (%)	Effi (dB)	Gain (dBi)
2400	32.1	-4.9	-1.2
2410	32.8	-4.8	-0.9
2420	33.8	-4.7	-0.8
2430	34.6	-4.6	-0.5
2440	35.6	-4.5	-0.4
2450	37.2	-4.3	-0.1
2460	36.9	-4.3	-0.2
2470	37.0	-4.3	-0.2
2480	36.1	-4.4	-0.4
2490	34.8	-4.6	-0.7
2500	34.5	-4.6	-0.7



Passive Test For WiFi/BT5.8G

Freq (MHz)	Effi (%)	Effi (dB)	Gain (dBi)
5150	33.9	-4.7	-1.4
5200	34.2	-4.7	-1.3
5250	34.3	-4.6	-1.1
5300	34.8	-4.6	-0.9
5350	34.9	-4.6	-0.7
5400	32.1	-4.9	-0.6
5450	35.8	-4.5	-0.3
5500	37.1	-4.3	-0.3
5550	32.1	-4.9	-1.0
5600	31.4	-5.0	-1.0
5650	43.8	-3.6	0.7
5700	44.6	-3.5	0.9
5750	47.5	-3.2	0.9
5800	42.8	-3.7	0.6
5850	40.3	-4.0	0.2



Radiation Pattern For WIFI /BT Antenna

2450.000MHz

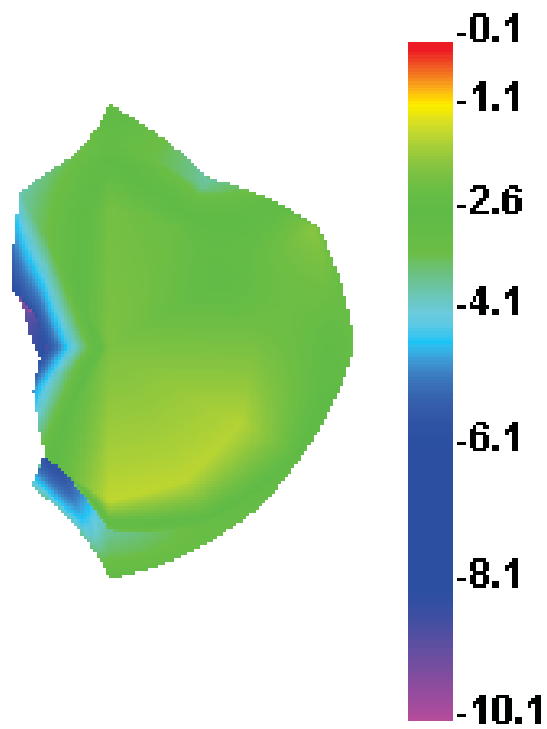



Radiation Pattern For WIFI/BT Antenna

5500.000MHz

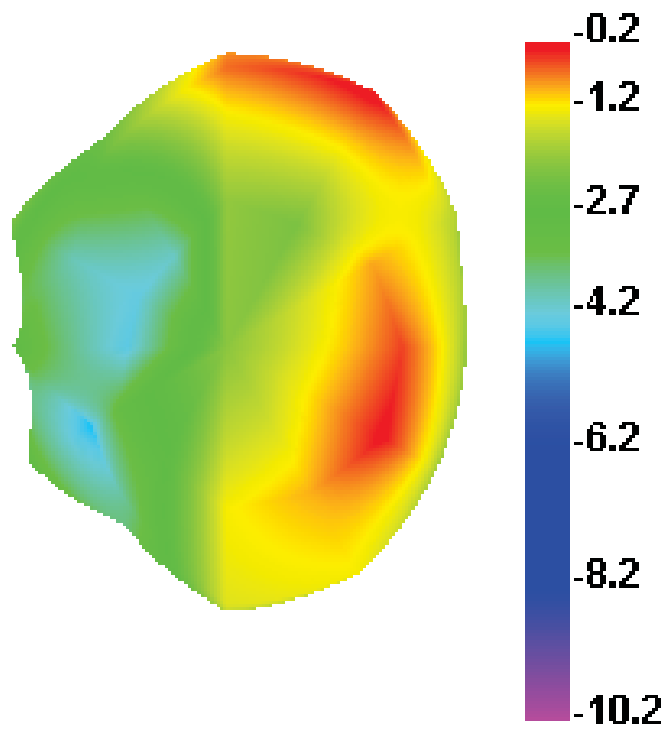



Active Test For WIFI/BT					
Band	Channel	Data Rate	TRP	Data Rate	TIS
WIFI 2.4G 802.11b	1	11Mbps	13.6	11Mbps	-83.9
	7		13.2		-83.6
	13		13.0		-82.8
WIFI 2.4G 802.11g	1	54Mbps	11.2	54Mbps	-69.7
	7		10.8		-70.0
	13		10.4		-69.9
WIFI 2.4G 802.11gn	1	MCS7	10.7	MCS7	-70.2
	7		10.4		-70.3
	13		9.9		-69.1
WIFI 5.8G 802.11a	36	6Mbps	10.9	54Mbps	-69.2
	149		10.3		-69.7
	165		10.5		-69.9
WIFI 5.8G 802.11an	36	MCS7	10.1	MCS7	-66.5
	149		-		-
	165		-		-



Active Test For BT/WIFI

Channel	TRP	TIS
0	2.8	-84.9
39	3.6	-88.1
78	4.1	-87.2



3. Assembly Picture





Paste conductive sponge here





Antenna Type:PCB antenna
Denmision:

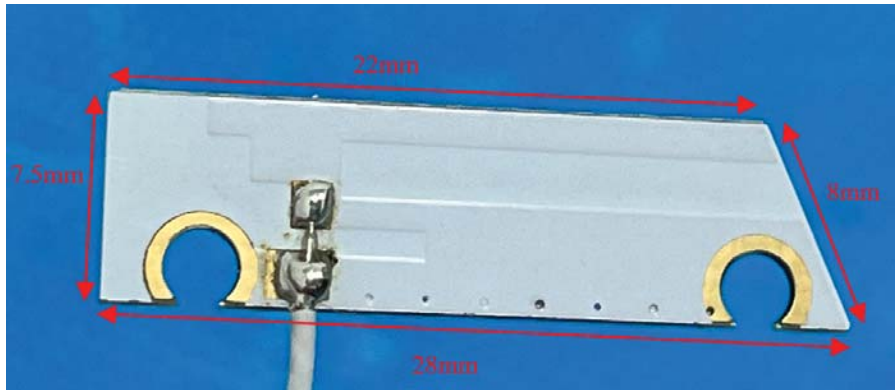

The model of the screw replacement magnet is used to reinforce the connection between the antenna and the ground

