

# User Manual

**DIECUT PANTONNE COOL GRAY 8 C**

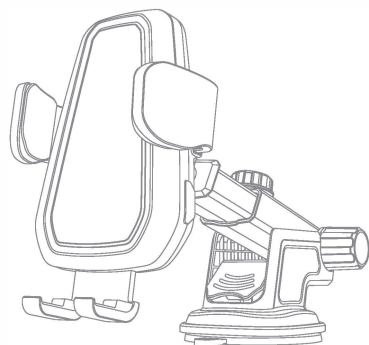

Automatic Car Mount  
Wireless Charger  
Trade Mark: VICSEED

Please read this operation instruction carefully and keep it properly before using this product.

### Thank you for purchasing and using this product!

In order to bring you a better experience, read this manual and also please refer to your mobile phone or your electronic product manual.

### Product Specifications

Product Name	Automatic Car Mount Wireless Charger
Model	CTEZ59
Size	≈(118×83×67)mm
Net Weight	≈137g
Input	5V ≈2A / 9V ≈2A
Output	10 W(Max)
Charging Induction Distance	≈(6-8)mm
Application Model	Compatible with iPhone, Samsung, LG, Moto etc.
Package Includes	Automatic car mount wireless charger ×1, Micro-USB charging cable ×1, Air vent clip ×1, Suction cup holder ×1, Manual book ×1

The parameters above are derived from the laboratory of ANDOBIL. The actual parameter would be different Because of products and other factors.

### Product Overview

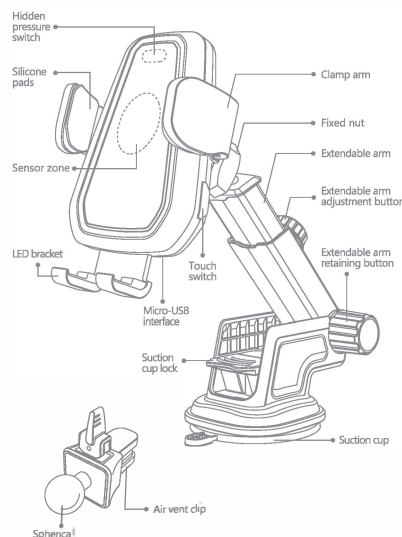

### Instructions

#### How to use the air vent clip



1. Unscrew the fixed nut and choose the air vent clip, set the ball in the fixed nut. Fasten the nut into the spherical top and push the nut forcibly into the round hole at the back of the vehicle bracket.

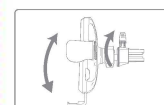

2. Rotate clockwise to tighten the nut, then it is able to adjust the angle of the automatic car mount wireless charger.

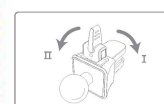

3. Fix the automatic car mount wireless charger on the suitable place of outlet. There are two gears in the clip, left or right can be selected, it is recommended that the thick wind leaf choose one "I", thin choose two "II".

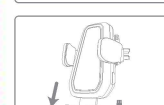

4. Plug the Micro-USB charging cable into the power interface. Pull down the LED bracket and the area of height adjustment appears. Customers can adjust the height of the LED bracket according to the sizes of their mobile phones.



5. Put the mobile phone in the bracket to trigger switch. The arm lock automatically clamps the mobile phone, and automatically starts the wireless charging. At the same time, the LED bracket lights up. If there is no respond with the arm lock, tap the upper half of the phone.



6. After use, short press any on the side edge, the arm lock stretches automatically. You can take out your phone from the mount easily as shown in the picture.

#### How to use the suction cup holder

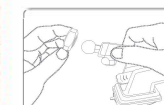

1. Unscrew the fixed nut and choose the suction cup holder. There has a connection ball on the clip, make this ball go through the fixed nut, pay attention that the screw thread must be toward to the groove.

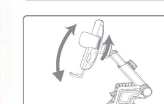

2. Adjust the angle to suit for your line of sight, then rotate clockwise to tighten the fixed nut completely.



3. Clean the glass where you need use the holder with a damp cloth, and wait glass to dry.

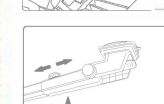

4. Buckle the mobile phone mount to the long pole, and rotate the adjusting knob to fix the mobile phone base twist the spin button at the long bar to draw or pull the long rod buckle the base of long pole and lock the buckle of fasten the sucker.

### FCC Statement

This device complies with part 15 and part 18 of the FCC Rules. Operation is Subject To the following two conditions:

(1) This device may not cause harmful interference, and (2) this device must accept any interference received, including interference that may cause undesired operation. Changes or modifications not explicitly approved by the party responsible for compliance could void the user's authority to operate this equipment.

Note: this equipment has been tested and found to comply with the limits for a Class B digital device, pursuant to part 15 and part 18 of the FCC Rules.

These limits are designed to provide reasonable protection against harmful interference in a residential installation. This equipment generates, uses and can radiate radio frequency energy and, if not installed and used in accordance with the instructions, may cause harmful interference to radio communications.

However, there is no guarantee that interference will not occur in a particular installation. If this equipment does cause harmful interference to radio or television reception, which can be determined by turning the equipment off and on, the user is encouraged to try to correct the interference by one or more of the following measures:

- Reorient or relocate the receiving antenna
- Increase the separation between the equipment and receiver.
- Connect the equipment into an outlet on a circuit different from that to which the receiver is connected.
- Consult the dealer or an experienced radio/TV technician for help.

The equipment complies with FCC radiation exposure limits set forth for an uncontrolled environment. During the operation of device a distance of 15 cm surrounding the device and 20 cm above the top surface of the device must be respected.

This device complies with Part 18 of the FCC Rules. This equipment generates uses and can radiate radio frequency energy and, if not installed and used in accordance with the instructions, may cause harmful interference to radio communications. If this equipment does cause harmful interference to radio or television reception, which can be determined by turning the equipment off and on, the user is encouraged to try to correct the interference by one or more of the following measures:

- Increase the separation between the equipment and any other radio device.
- Connect the equipment into an outlet on a circuit different from that to which the receiver is connected.

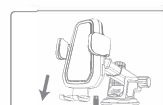

5. Plug the Micro-USB charging cable into the power interface. Pull down the LED bracket and the area of height adjustment appears. Customers can adjust the height of the LED bracket according to the sizes of their mobile phones.



6. Put the mobile phone in the bracket to trigger switch. The arm lock automatically clamps the mobile phone, and automatically starts the wireless charging. At the same time, the LED bracket lights up. If there is no respond with the arm lock, tap the upper half of the phone.

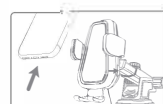

7. After use, short press any on the side edge, the arm lock stretches automatically. You can take out your phone from the mount easily as shown in the picture.

### The LED bracket corresponds to the phone model

LED BRACKET SCALE	PHONE MODEL
4.7"	iPhone 8
5.0"	iPhone X / GALAXY S8 / GALAXY S9
5.5"	iPhone 8 plus / GALAXY S8+ / GALAXY S9+
6.3"	Note 8

### The LED light display status of wireless charger

CHARGING STATUS	LED LIGHT DISPLAY STATUS
Power on	The red indicator light is bright for 3 seconds and then goes out.
Standby	The indicator light goes out.
Charging	The blue light breathes to be bright (dark until bright for 1s, bright until dark for 1s, cycling all the time).
Mobile phone full of electricity	When the phone is full of electricity, the blue light is always on for 20 seconds and then goes out.
Abnormal FOD (foreign object detection)	The red light flashes 10 times: lights for 1s, extinguishes for 1s and then goes out.
Built-in battery with low voltage	When putting on the phone, the beep sound will prompt charging and the motor will not start.

### Notes

- Please install the car holder in the good condition before driving navigation and do not operate and adjust the bracket during driving.
- The automatic car mount support 4-6.5 inches of mainstream model mobile phone, wireless charging will need to mobile phone have the function.
- The mobile phone case with metal on the back will lead to the failure of wireless charging function and the possibility of damage to the vehicle support. Please check carefully before use.
- Please turn on car vent condition (fan) when in hot day or long time use, it'll help you to cool down the wireless car charger and speed up charging speed.
- Low power, please turn off the screen and charge your phone for 10 minutes. Then open your map, it can avoid lose power very quickly.
- Not toys for fun, please keep it away from children.
- If you choose the suction cup holder, please clean up the surface before using to ensure its adsorption if the cup holder is not used for a long time.

8. If you choose the suction cup holder, please do not stick the bracket to the dashboard or windshield for a long time, you can reinstall the bracket before using it for the next time. After take off the car holder, please use plastic wrap to protect the suction cup holder.

9. If you choose the suction cup holder, please do not affix to curved surfaces, plush fabrics, or bumpy surfaces. Do not install the car mount on a place that will influence the operation of airbag and driving.

10. We do not recommend to apply the suction cup on leather, wall or filmed glass surfaces as the suction cup is designed with strong viscosity and attraction.

### Warranty Card

Customer Name: \_\_\_\_\_

Phone Number: \_\_\_\_\_

Product Name: \_\_\_\_\_

Date of Purchase: \_\_\_\_\_

Address: \_\_\_\_\_

Notes: \_\_\_\_\_

EMAIL:  
VANMASS\_service@hotmail.com

WWW.VANMASSONLINE.COM

VANMASS™ is trademark registered in the U.S. and other countries. All rights reserved.

DESIGNED IN H.K.  
ASSEMBLED IN CHINA



B	Date	20180806	VMPI0009A	VICSEED
---	------	----------	-----------	---------