

# WiNRADiO<sup>®</sup>

*by RADIXON<sup>®</sup>*

## WR-G65DDC

*EXCALIBUR SIGMA<sup>™</sup>*

**Software-Defined Communications Receiver**

### **User's Guide**

Ver. 1.07

Published by  
Radixon Group Pty. Ltd.  
45 - 47 Islington Street, Collingwood, Victoria 3066 Australia  
© 2018 Radixon, Melbourne, Australia

All rights reserved. No part of this book may be reproduced or transmitted in any form or by any means without the written permission of the publisher.

## **Trademarks**

WiNRADiO, G3, G65DDC and Excalibur Sigma are trademarks of WiNRADiO Communications

All other brand and product names are trademarks of their respective owners.

Published in Australia

## **FCC Notice**

The WiNRADiO WR-G65DDC receiver has been tested and found to comply with the limits for a Class B digital device, pursuant to Part 15 of the FCC Rules. These limits are designed to provide reasonable protection against harmful interference in a residential installation. This equipment generates, uses and can radiate radio frequency energy and, if not installed and used in accordance with the instructions, may cause harmful interference to radio communications. However, there is no guarantee that interference will not occur in a particular installation. If this equipment does cause harmful interference to radio or television reception, which can be determined by turning the equipment off and on, the user is encouraged to try to correct the interference by one or more of the following measures:

- Reorient or relocate the receiving antenna
- Increase the separation between the equipment and the receiver
- Connect the computer into a different outlet so that the two devices are on different branch circuits
- Consult an authorised dealer or an experienced radio/TV technician for help

## **Caution**

To comply with the limits for the Class B digital device, pursuant to Part 15 of the FCC rules, the WiNRADiO receiver must be attached to a computer certified to comply with the Class B limits. Only peripherals certified to comply with the Class B limits may be attached to the computer containing the WiNRADiO receiver. All cables used to connect the computer and peripherals must be shielded and grounded. Operation with non-certified peripherals may result in interference to radio and TV reception.

## **Modifications**

Any changes or modifications to the WiNRADiO receiver not expressly approved in this book could void the user's authority to operate this equipment.

## **Limitation of Liability and Remedies**

*The information published in this book has been compiled from several sources. While every effort has been made to ensure its accuracy, neither the authors nor the publisher can guarantee that all information is entirely correct or up-to-date. Furthermore, neither the authors nor the publisher can take any responsibility for the use of this information or any consequences arising therefrom. WiNRADiO Communications shall have no liability for any damages due to lost profits, loss of use or anticipated benefits, or other incidental, special or punitive damages arising from the use of, or the inability to use, the WiNRADiO receiver, whether arising out of contract, negligence, tort or under any warranty, even if WiNRADiO Communications has been advised of the possibility of such damages. In no event shall WiNRADiO Communications' liability for damages exceed the amount paid for this product. WiNRADiO Communications neither assumes nor authorises anyone to assume for it any other liabilities.*

## **Warning**

*In certain countries or states it may be illegal to monitor certain frequencies. We cannot accept any responsibility for the consequences of your non-compliance with government regulations. If you are in doubt about the regulations in your country or state, please contact your nearest radio communications regulatory authority.*

## Table of Contents

---

<b>Table of Contents .....</b>	<b>4</b>
<b>Introduction.....</b>	<b>6</b>
<b>The Hardware.....</b>	<b>7</b>
<b>Installation.....</b>	<b>8</b>
Recommended System Requirements.....	8
Software and Hardware Installation.....	9
Setting up the Sound Card .....	10
Connecting the Antenna .....	11
Grounding .....	11
<b>Getting Started .....</b>	<b>13</b>
Achieving Best Selectivity.....	16
Avoiding Front-End Overload .....	17
<b>Inside the <i>Excalibur Sigma</i>.....</b>	<b>17</b>
<b>Resizing the Application Window.....</b>	<b>21</b>
<b>Drop-Down Menu Controls.....</b>	<b>22</b>
<b>Tuning the <i>Excalibur Sigma</i>.....</b>	<b>23</b>
Manual Frequency Entry.....	23
Tuning Knob .....	25
Keyboard Tuning .....	25
Multiple Receiver Operation .....	26
Point-and-Click Tuning .....	27
Dragging the Passband .....	27
IF Shift and Passband Tuning .....	29
Frequency Stepping.....	30
Frequency Display Offset .....	31
<b>Receiver Selection .....</b>	<b>31</b>
<b>Mode Selection .....</b>	<b>32</b>
AMS Mode .....	33
ISB and DSB Modes.....	34
DRM Mode.....	35
FSK Mode.....	38
UDM Mode.....	38
<b>Function Tabs.....</b>	<b>38</b>
Tuning Tab.....	39
Audio Tab .....	43
Memory Tab.....	48
Notch.....	54
Squelch .....	55
Gain .....	57
Noise Blanker .....	60

---

Pause.....	61
<b>Spectrum Scopes.....</b>	<b>63</b>
Zoom Spectrum.....	64
Save and Print Spectrum.....	65
Resolution Bandwidth.....	65
Spectrum Averaging.....	66
Waterfall Spectrum.....	66
Spectrum Markers.....	68
Information Buttons.....	69
Baseline Level.....	70
Peak Hold.....	70
Audio Spectrum.....	70
Activity Search.....	72
<b>Recording Functions.....</b>	<b>75</b>
<b>Attenuator.....</b>	<b>79</b>
<b>Preamplifier.....</b>	<b>79</b>
<b>RF Filter.....</b>	<b>80</b>
<b>S-meter.....</b>	<b>80</b>
<b>Top Menu Bar.....</b>	<b>81</b>
File.....	81
Options.....	84
Memory.....	98
Scheduler.....	99
Logger.....	103
Plugins.....	104
<b>Power Switch.....</b>	<b>104</b>
<b>Date and Time Display.....</b>	<b>104</b>
<b>Appendix A – SDR and DDC Primer.....</b>	<b>106</b>
<b>Appendix B – Troubleshooting.....</b>	<b>113</b>
<b>Appendix C – USB and LAN Interface Diagnostics.....</b>	<b>117</b>
<b>Appendix D – Dealing with Interference.....</b>	<b>118</b>
<b>Appendix E – Waterfall Spectrum Palettes.....</b>	<b>120</b>
<b>Appendix F – Recording File Formats.....</b>	<b>121</b>
<b>Appendix G – G65DDC Connections.....</b>	<b>124</b>
<b>Appendix H – Compliance Declarations.....</b>	<b>125</b>
<b>Appendix I – Safety Disposal.....</b>	<b>126</b>

## Introduction

---

Welcome to the **WiNRADiO G65DDC** receiver, the **Excalibur Sigma**.

This receiver is an advanced frequency extended successor to the award-winning WR-G35DDC receiver, the Excalibur Ultra. Like many WiNRADiO receivers in the past, this advanced software-defined receiver breaks many new grounds. Some of its features are hard to beat, such as the real-time 88/72 MHz-wide spectrum analyzer, two independent frequency ranges (both in direct sampling mode) with dedicated inputs, the capability to record up to a 64 MHz wide digitized RF signal, 0.1 ppm frequency stability, USB3 and Ethernet connectivity (including PoE capability) and much more.

Installed on any modern computer via the USB interface, the *Excalibur Sigma* transforms it into a remarkable surveillance, monitoring and testing station suited for the most demanding applications, and yet still remaining user-friendly, convenient and remarkably cost-effective.

The WiNRADiO *Excalibur Sigma* will take you right to the leading edge of what is possible with today's technology. As the name *Excalibur Sigma* suggests, a magical sword synonymous with power and bravery, this is not just a receiver; it is a powerful radio communications instrument in a class of its own. We have crafted it with meticulous workmanship, utmost care, attention to detail and dedication to excellence, to make it suitable for the most demanding of applications. We are proud to present you with this instrument and wish you much success and many hours of enjoyment in putting your WiNRADiO *Excalibur Sigma* to a good use.

---

*One of the great benefits and advantages of software-defined radio is its flexibility and potential for further improvement. By continuously improving the software, we continue increasing our customers' return on their investment long after the receiver purchase. However, this makes producing printed user manuals impractical, because a printed version may become already obsolete by the time the manual gets printed and bound. This is why we supply a complete user's guide for this receiver in a soft form only. Saving paper is, of course, yet another side benefit. The user's guide in a PDF format, will be installed on your computer as part of the installation process, with a shortcut placed on the desktop.*

---

## The Hardware

---

The WiNRADiO G65DDC receiver is presented as an external USB-interfaced design which provides portability and flexibility of use. The WR-G65DDC hardware is contained in a small metal box, encapsulated with transparent plastic.

The front of the enclosure contains an indicator LED. The LED also serves for diagnostic purposes and installation trouble-shooting (see **Appendix C – USB Interface Diagnostics**). During normal operation, its flashing can be disabled by a setting in the application software, should it appear disturbing.



The *power input socket* requires 12 V DC with a tolerance of  $\pm 1$  V. The power adapter must be rated for a minimum of 1 A.

**CAUTION: For best performance and safety, we recommend using only the power adapter supplied by WiNRADiO, which comes included with your receiver.**

There are two *antenna inputs* both being SMA-type connectors with 50 ohm impedance. The receiver *interfaces* to a Windows-compatible PC via USB 3.0, or 1 Gb Ethernet LAN port with PoE (Power over Ethernet functionality according to IEEE 802.3at).

## Installation

---

The complete WiNRADiO G65DDC receiver package contains the following items:

- WiNRADiO G65DDC receiver
- Application software, User's and Installation Guide on a CD ROM
- Installation Guide in printed form
- Warranty information
- AC/DC adapter with power cord
- USB interface cable

In order for the WiNRADiO G65DC receiver to be able to provide best performance, your computer should fulfil the system requirements specified below.

## Recommended System Requirements

---

CPU	i5 or better
RAM	4 GB RAM or more
Display	SVGA or better
Hard Disk	separate drive with min. 320 MB/s data throughput for recording/playback
Sound card	Any standard Windows-supported sound-card
Interface	USB 3.0 port
OS	Windows 7, 8 or 10 (32/64-bit)

The CPU speed directly influences the maximum selectivity and DDC bandwidth that can be achieved with this receiver. The receiver may still be usable on slower computers, but with some compromises, for example using only one of the two receiver channels and/or reduced maximum achievable selectivity and DDC bandwidth. Other background processes and programs running simultaneously on the computer may also adversely affect the receiver's performance.

---

*Do you have any suggestions about how we could further improve our product, or do you wish to tell us of your experiences using this receiver in your application? Please do not hesitate to leave your comments on [www.winradio.com/feedback](http://www.winradio.com/feedback) We always love hearing from you.*



## Software and Hardware Installation

---

1. Leave the receiver disconnected from the PC and insert the installation CD ROM. The installer should start automatically. If the installation program does not start automatically, choose the **Run** command from the Windows **Start** menu and type **D:VNSTALL** (if the CD ROM is the D: drive on your PC).
2. Connect the receiver to the USB port.
3. Connect the supplied power adapter to the power outlet on one side and the power lead to the receiver on the other side. The blue LED will flash to indicate that the receiver is ready. Windows should now detect your new receiver and automatically install the driver.

After all the files have been installed to your hard disk, run the *WiNRADiO G65DDC* application by clicking on the new icon that has been installed on your desktop. Note also a shortcut to the user's manual file (**G65DDC User's Guide.pdf**) that will also appear on your desktop.

Finally, connect your antenna to the antenna connectors (SMA-type) at the rear of the receiver. Having a good antenna is most important; see more details in the chapter **Connecting the Antenna**.

---

### *Something to consider?*



*WiNRADiO also manufactures numerous antennas and antenna accessories. For example, the (pictured) WR-LWA-0130 adapter can be used to match the impedance of a long wire HF antenna to the 50 ohm input impedance of a WiNRADiO receiver, as well as provide a convenient grounding point.*

*This usually results in a significant signal strength increase (up to 17 dB in some cases, and approximately 5 dB on average), compared to a long-wire antenna connected directly to the antenna input of the receiver.*

*To ensure best performance, we recommend using this long-wire balun for all long-wire antenna installations.*

## Setting up the Sound Card

---

As the digitally down-converted signal from the receiver is transferred to the PC over the USB interface, no external connection to the PC sound card input is necessary. The sound card is only used for the demodulated audio output.

On Windows 10, the audio volume can be adjusted using the **WR-G65DDC** volume slider inside the **Applications** section and the master volume inside the **Device** section. Both controls need to be unmuted.

Click on the speaker icon and then click on the **Mixer** link to bring up the sound card control panel. Different Windows versions may use a different method of bringing up this control panel; in Windows 10 type **mixer** into the Windows Start / Search box to access the "Adjust system volume" link:

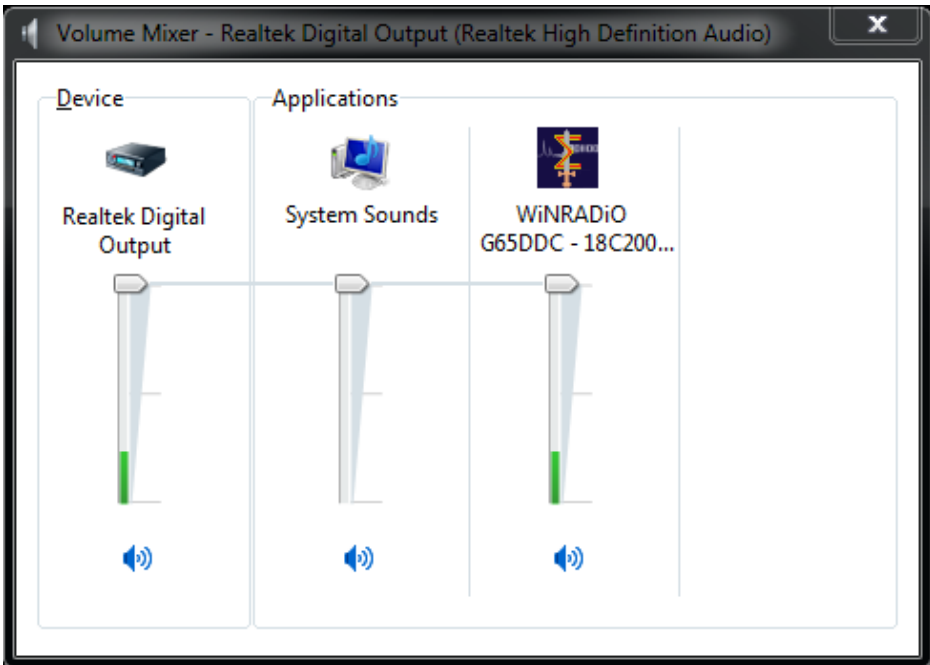

To get started, make sure the volume is set approximately as shown above. If you find that the maximum volume as set on the 'receiver application panel' is not sufficient, you may then wish to increase the 'sound card' volume later.

## Connecting the Antenna

---

As the old saying goes, *“a good antenna is the best amplifier”*. No matter how good a radio receiver is, the performance limit of a radio receiving system is always determined by the first element of the receiving chain – the antenna.

To make the most out of your WiNRADiO receiver, you should install a good antenna, preferably located outdoors, as far away as possible from interference sources. If you are looking for a new antenna, please also check out the WiNRADiO antenna product range at [www.winradio.com/antennas](http://www.winradio.com/antennas)

The specifics of a computer-based receiver may often require careful consideration with respect to the antenna connection and installation, to make sure that computer-generated noise does not enter the receiver's antenna input.

## Grounding

---

To obtain the maximum possible performance from your receiver, you may also like to experiment with grounding, in particular when you are using long-wire antennas. In some cases, signal reception may be significantly enhanced with improved grounding. Unfortunately, results are not always predictable due to variations in individual installations, so some trial and error experiments may be required in the search for ultimate performance.

With long-wire antennas, good grounding is absolutely essential. If you don't apply any external additional grounding with the receiver, then you are relying on grounding provided via the power supply or via the computer's USB interface. Such grounding may not be optimum as it may introduce noise to the receiver's input due to *“ground loops”*, where the useful signal is sharing the ground path with undesirable interference.

**The grounding requirement does not usually apply with antennas which do not require ground as a counterpoise to the "live" terminal. For example, the magnetic field loop antenna, which provides two output terminals, and also some electric field antennas such as dipole, inverted "V", etc. These antennas have balanced outputs, and will require impedance matching to the Excalibur Ultra's unbalanced 50 ohm input.**

A "good" ground for a receiver is one that provides a low impedance path to ground for radio signals in the frequency range of interest. A metal cold water pipe located in close proximity to a possible ground connection point could provide good results. If no such point exists, a copper stake hammered into the ground may be required. Copper earth stakes can be obtained from electrical supply outlets.

Assuming a typical installation where the coaxial cable to the receiver enters the building at some point, an opportunity may exist to make a connection between the outer shield of the coaxial cable and the suitable ground point. In order for the grounding to be effective, the connection between the ground point and the coaxial cable outer should preferably be no more than a few meters in length. A low impedance connection (such as braid removed from a section of coaxial cable) should be used to make the connection. In an ideal situation, the length of coaxial cable to the receiver should be no more than a few meters in order to provide a low RF ground impedance at the receiver.

In order to make a connection to the coaxial cable, a number of options exist. These include WiNRADiO antenna accessories such as the **WR-CMC-30 Common Mode Choke** (see [www.winradio.com/cmc30](http://www.winradio.com/cmc30)) or the **WR-LWA-0130 Long Wire Adapter** (sometimes referred to as a "**long wire balun**"; see [www.winradio.com/lwa](http://www.winradio.com/lwa)) which, along with their other intended purpose, the WR-CMC-30 provides a convenient ground connection stud that will allow the connection to be made.

**CAUTION: With any outdoor antennas, be sure to install a lightning arrester and disconnect the antenna (and ground it if possible) during thunderstorms. To prevent receiver damage from static charge build-up, always ground your antenna momentarily before connecting it to the receiver.**

If it is too difficult to make ground connections near the building, it may still be well worthwhile experimenting at a point where connections can be more made more easily. The **WR-CMC-30 Common Mode Choke** makes it possible to provide several grounding points along the entire length of the antenna feedline, in those locations where good quality grounding is available.

Where small physical size is important, magnetic field loop antennas usually perform best. For indoor applications, WiNRADiO also offers the miniature AX-17C antenna (see [www.winradio.com/ax17c](http://www.winradio.com/ax17c)) which does not require grounding.

## Getting Started

The following quick-start introduction is intended to make it possible for you to enjoy your new receiver as quickly as possible. Detailed operation is described in the subsequent chapters. We do hope you will return to these chapters as the WiNRADiO *Excalibur Sigma* receiver has many unique and innovative features the usage of which may not be immediately obvious and which would be a shame to miss.

Start the WiNRADiO *Excalibur Sigma* receiver application (by double clicking on the program icon). The receiver's "**virtual control panel**" will appear:

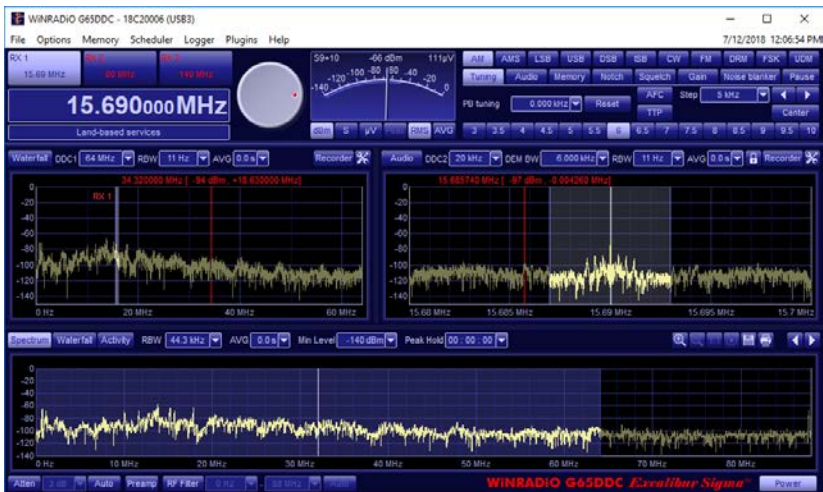

The control panel has some basic elements similar to conventional receivers and many new ones as well. For example, you will note the wideband spectrum analyzer at the bottom of the application that (if the **Spectrum** button is engaged) shows the real-time activity of a wide spectrum, making the WiNRADiO *Excalibur Sigma* a true **panoramic receiver**.

The quickest way to get started with this receiver is to check its operation on your local stations.

Using the keyboard, type in the frequency of one of your local AM stations: For example, for 774 kHz, type in **7 7 4**, then **k** for kHz, then press **Enter**. The typed-in frequency will appear on the digital frequency display.

When you start the receiver the first time, the AM mode is selected by default. Otherwise you can set the demodulation mode by clicking on the appropriate mode selection button at the top-right:



When tuned, you should be able to see the station peak in both real-time spectrum scopes in the upper section of the application window: The spectrum scope on the left shows the output of the primary **Digital Down-Converter (DDC1)** and the one on the right is that of the secondary DDC (**DDC2**), which refines the observed spectrum further.

You can adjust the receiver's selectivity bandwidth for optimum reception using the row of numbered buttons at the bottom of the **Tuning** tab, this being the left-most tab located just under the AM mode selection button. The numbers on the buttons represent the bandwidth in kHz.

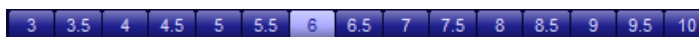

To adjust the bandwidth continuously, use the **DEM BW** control located at the top of the demodulator spectrum scope:

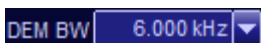

At this point, you should be able to hear the station. The volume is adjustable under the **Audio** tab, located just next to the tuning tab. You can use either the slider, or select the value next to the **Volume** edit box, next to the **Mute** button.



An alternative and fast way to adjust the volume is by using the left/right arrow keys of the computer keyboard.

Manual tuning can be done in several ways. Let's start with the tuning knob:

Place the mouse cursor onto the upper half of the tuning knob, at which point you will see the cursor change to a curved double ended arrow.

Hold down the right or left mouse buttons to increase or decrease the frequency, and the knob will rotate clockwise or anti-clockwise, respectively.

If you place your cursor onto the bottom half of the tuning knob, the direction of the rotation will reverse. *(You don't need to move the cursor up or down to change the rotation of the knob, simply press either the left or right mouse button.)*

The rotation increment of the tuning knob is 1 kHz. This can be changed easily using the **Alt**, **Shift** or **Ctrl** keys: If you press the **Alt** key while tuning, the increment will decrease ten times (100 Hz). Pressing **Shift** will decrease the increment a hundred times (10 Hz). And if you use the **Ctrl** key, the increment becomes a thousand times smaller (1 Hz).

Another way of tuning is to use the up and down arrow keys on the PC keyboard. The **Alt**, **Shift** and **Ctrl** keys can be used to a similar effect as with the tuning knob, to modify the frequency increment step.

If your mouse has a wheel (as we would recommend), you can also use this; you might find it somewhat similar to using the tuning knob of a conventional receiver. And again, the **Alt**, **Shift** and **Ctrl** keys, when used together with the mouse wheel, modify the tuning step accordingly.

If you press the **Shift** key while hovering with your mouse cursor over the individual digits of the main frequency display, the display enters a different mode where and you can change the digits using the mouse wheel – presenting another convenient way of quickly tuning to the frequency you want.



## Achieving Best Selectivity

---

In any software-defined receiver, the maximum achievable selectivity is a function of the processing power of the host computer: The greater the CPU power, the “longer” and therefore the sharper its digital filters can be made.

The selectivity of your receiver can be adjusted using the function **Filter length** under the top bar menu **Options**. The greater the **Demodulator filter length** parameter, the better the selectivity:

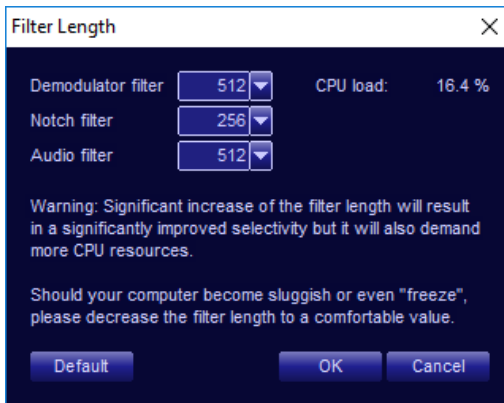

This function also makes it possible to observe the **CPU load**, which will depend on this setting. It may not be advisable to select a value resulting in more than say 30% CPU load as the computer may then become sluggish.

Should the computer become sluggish or even “freeze” as a result of this adjustment, please reduce the demodulator filter length to a lower value.

**Note also that the CPU load can be lowered (while keeping selectivity high) by reducing the DDC1 and/or DDC2 bandwidths (DDC1 and DDC2 values are shown above the two respective spectrum displays). For example, HF signals can be demodulated with 20 kHz DDC1 and DDC2 bandwidths without a decrease in the demodulation quality. Wider DDC bandwidths affect display and recording, while increasing the CPU load considerably.**



## Avoiding Front-End Overload

If you are tuned to the HF bands and the S-meter shows the words **ADC CLP**, the analog-to-digital converter (ADC) is overloaded (i.e. clipping the signal). In such a case, use the **Attenuator** to reduce the level of the signal entering the ADC. You can use the **Auto** button which reduces the signal automatically to the optimum level.

If you experience any installation problems or are unable to tune to any radio stations at this point, please refer to **Appendix B - Troubleshooting**.

Should you encounter interference-related problems with your receiver, effective remedies do exist; please peruse **Appendix D – Dealing with Interference**.

## Inside the *Excalibur Sigma*

Let's have a look at what's inside this receiver and how it relates to the graphical user interface of the control application. Here is a simplified functional block diagram of the hardware portion of the receiver:

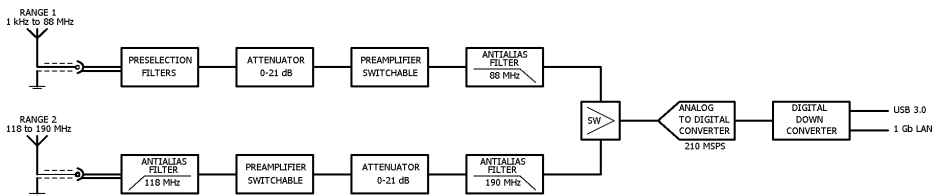

The receiver operates in two separate frequency ranges: **Range 1** from 1 kHz to 88 MHz and **Range 2** from 118 MHz to 190 MHz.

There are two antenna inputs on the receiver, for each of its respective frequency ranges. Both antenna inputs are followed by a dedicated signal chain for its frequency range.

For **frequency range 1** the signal chain starts with the antenna input and its associated protective and impedance matching circuitry, followed by the Preselector and the Attenuator.

The **Preselector** contains a bank of user-configurable filters that can be used to filter out strong frequencies in the vicinity of the received signal, and so reduce overloading and intermodulation distortion.

The **attenuator** is adjustable from zero to 21 dB in 3 dB increments and serves to reduce signal levels in the proximity of strong stations. The attenuator can be operated either manually, or left to the receiver to determine its optimum level automatically to avoid overloading.

The signal then passes through a switchable low-noise, low-distortion amplifier which can be enabled or disabled by the user. When enabled, this adds approximately 10 dB of amplification, making it possible to achieve higher sensitivity (at the expense of strong signal handling capability). Following the amplifier is an anti-aliasing filter, which is necessary for the digitization.

For **frequency range 2** the signal chain starts with the antenna input and its associated protective and impedance matching circuitry, followed by a 118 MHz high pass anti-alias filter which also effectively suppresses the FM broadcast band.

The signal then passes through a switchable low-noise, low-distortion amplifier which can be enabled or disabled by the user. When enabled, this adds approximately 10 dB of amplification, making it possible to achieve higher sensitivity (at the expense of strong signal handling capability).

This is followed by the attenuator which is adjustable from zero to 21 dB in 3 dB increments and serves to reduce signal levels in the proximity of strong stations. The attenuator can be operated either manually, or left to the receiver to determine its optimum level automatically to avoid overloading.

Following the amplifier is an anti-aliasing low pass filter at 190 MHz which is necessary for the digitization.

The signals from **both frequency ranges** meet at signal switch, which selects the appropriate frequency range according to the tuned frequency. Please note that only one of the frequency ranges can be used at a time.

The signal is then sampled by a 16-bit analog-to-digital converter (ADC) which samples the input signal at 210 MSPS (megasamples per second), producing a steady stream of digital data for the subsequent **Digital Down-Converter (DDC)**.

The digital data then proceeds via the USB 3.0 or the Gigabit Ethernet (1000BaseT) to the computer which provides all the additional processing, filtering, demodulation, signal strength measurement, squelch, noise blanking, notch, audio filtering and other functions.

Connecting the receiver via the USB 3.0 provides full DDC bandwidth of up to 64 MHz. However when the receiver is connected via a Gigabit Ethernet, the DDC bandwidth is limited to 16 MHz due to limited throughput of the Gigabit Ethernet connection.

In the WiNRADiO Excalibur Sigma receiver, the chunk of the input spectra that is processed by the DDC can be recorded and played back by the PC, making it possible to “re-receive” signals located anywhere within that chunk. The maximum width of the DDC chunk (called the DDC bandwidth) is 64 MHz when connected through the USB 3.0 and 16 MHz when connected through a Gigabit Ethernet.

The larger the DDC bandwidth, the more CPU processing power is required by the computer. On slower computers, using the maximum DDC bandwidth may not be possible as the computer may then become sluggish and the application may “freeze”.

The chunk of the input signal spectrum seen and processed by the DDC is shown at the top-left; this is called the DDC1 spectrum. Its bandwidth is determined by the DDC1 BW control at the top of the DDC spectrum.

Anywhere within the DDC1 spectrum, you can place three independent demodulators (“virtual receivers”), each of them capable of independently demodulating signals of different modulation types and different bandwidths. These signals can also be separately recorded and then played back. Effectively, the WiNRADiO Excalibur Sigma includes three receivers in one.

You can select any one of these three receivers using the three tabs above the main frequency display (RX1, RX2, RX3). There are some important tuning ramifications resulting from the fact that all three receivers must reside within the current DDC spectrum - these will be described in greater detail in a later chapter, ***Tuning the Excalibur Sigma***.

The spectrum scope at the top-right of the application window shows the spectrum as seen and acted upon by the currently selected virtual receiver (DDC2). This spectrum represents the output of the final decimation process and is available for final filtering and demodulation. As a convenient short-hand, we will refer to this spectrum simply as the **Demodulator spectrum**.

As a useful parallel, the demodulator spectrum can be compared to the IF spectrum of a conventional receiver.

The dark blue rectangular area inside the DDC1 spectrum corresponds to the demodulator bandwidth, while the gray area inside both the DDC1 and demodulator spectrums relate to the demodulator filter bandwidth. This bandwidth represents the selectivity bandwidth of the receiver... and for the best signal-to-noise ratio of the received signal, you might wish to adjust this bandwidth to very closely embrace the visible spectrum of the received signal. You can do this either by using the **DEM BW** control, or by dragging the edges of the gray area in the demodulator spectrum.

You can also drag the gray areas sideways, by clicking and dragging at their center or anywhere inside them, in both the DDC1 and demodulator spectrum. This is equivalent to the **IF Shift** function of conventional receivers.

Clicking on any of the three spectrum scopes will cause the receiver to tune to the corresponding frequency. But as the WiNRADiO Excalibur Sigma consists of three receivers in one, this does have some ramifications which will be further explained in the following chapters.

The receiver also features optional external 10 MHz reference input/outputs and coherence mode of operation, also a 1 PPS pulse input and an FPGA interface.

---

*Please don't forget to register as a WiNRADiO user to receive news about new products, accessories and software upgrades for your Excalibur receiver. Use our on-line registration form at [www.winradio.com/register](http://www.winradio.com/register) to take advantage of this free service.*

---

## Resizing the Application Window

---

The WiNRADiO *Excalibur Sigma* application is fully resizable, which means you can drag its edges, corners and some internal boundaries to maximize the available screen space.

The application panel also supports being resized over two or more monitors: You can literally surround yourself with a complete panorama of radio spectrum. To adjust the size of the application panel and the proportion of the three spectrum scopes, simply drag the edges or corners, or the internal boundaries separating the three spectrum scopes.

Below is an example of how the application window can be resized. This was achieved by first dragging the right-hand edge of the application panel to extend the panel horizontally, then making more room for the DDC1 spectrum at the expense of the demodulator (DDC2) spectrum by dragging the vertical line separating them to the right, and, finally, by vertically enlarging the DDC1 and demodulator spectrum scopes at the expense of the height of the wideband spectrum, by dragging the dividing horizontal line down:

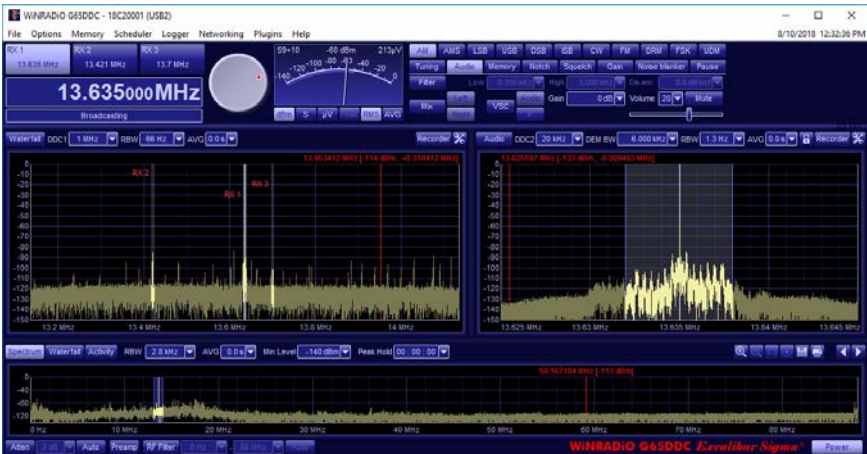

---

## Drop-Down Menu Controls

---

The WiNRADiO *Excalibur Sigma* receiver employs an innovative type of "drop-down menu controls" that work slightly differently from standard Windows controls.

To illustrate this, let's try, for example, the **DEM BW (demodulator filter bandwidth)** control located just above the demodulator (DDC2) spectrum:

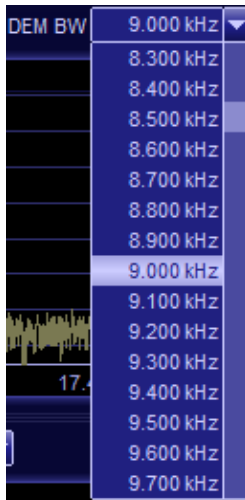

Clicking on the arrow button opens a drop-down menu showing a list of values to select from, as you would expect. Spinning the mouse wheel will move the list up and down with a little bit of inertia; the faster you spin, the faster the imaginary "wheel" will turn. Clicking on an item will select it; double-clicking will select it and also close the list.

***If you don't have a mouse wheel (for example using a laptop with a touch pad instead of a mouse), you can also use the keyboard up/down cursor keys to navigate inside the list.***

There is also another difference with this control: On a long list, you can "click and drag" the list, and the mouse cursor wraps from the top to the bottom of the screen and vice versa. This does not select the item you clicked on, but moves the whole list up and down underneath the selection. This works particularly well with a trackpad on a notebook.

## Tuning the *Excalibur Sigma*

---

### Manual Frequency Entry

---

To change frequency, simply type the new frequency into the keyboard. As soon as you press a number or decimal point, the frequency display will activate, waiting for a frequency to be typed. You can also double-click on the display to type in a new frequency in a highlighted field, or after single-clicking on the display, it is possible to use the mouse wheel to increment/decrement a particular digit, depending on the current cursor position. After typing the new frequency, press **Enter** and the receiver will instantly retune. To abort, press **Escape**. To enter units, kHz, MHz or Hz, simply press **k** for kHz, **m** for MHz or **h** for Hz, after entering the digits. The tuned frequency will then be displayed in the chosen units. Any invalid keystrokes are ignored.

***The same principle of changing the displayed frequency units is applied anywhere in the Excalibur Sigma application where frequency is to be entered – if you prefer to display or enter the frequency in different units simply terminate the entry with “h” for Hz, “k” for kHz, “m” for MHz and “g” for GHz.***

Frequencies outside the receiver's limits will not be accepted and the display will revert to the previous frequency.

The actually tuned frequency of the currently selected receiver is shown in the main frequency display:



123.456789MHz

If you press the **Shift** key and hover with the mouse cursor over the main frequency display, the display enters a special mode where you can use the mouse wheel to quickly step up or down the frequency in the corresponding digit positions.



Release the **Shift** key to exit this mode.

Under the main frequency display there is a **Band description** window:

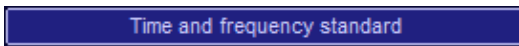

This window shows the band allocation of the currently tuned frequency. While the displayed band descriptions are specific to the North American standard band allocation, they are based on international treaties and therefore are generally applicable worldwide with minor differences, and can be easily edited by the user.

The displayed band descriptions can be overridden with a call sign or a user-defined description of a particular frequency stored in memory. This overrides the band description for that particular tuned frequency only.

It is also possible to change the naming and frequency allocations for entire frequency bands. This can be done by editing the file called **Bands.csv** in the program installation folder, usually located at...

with a 32-bit operating system

**C:/Program Files/WiNRADiO/G65DDC/Defs**

with a 64-bit operating system

**C:/Program Files (x86)/WiNRADiO/G65DDC/Defs**

This is a standard **comma-separated-value** format file which can be edited using a spreadsheet application such as Microsoft Excel. Please note that with newer Windows versions, you will need **administrator privileges** to be able to edit this file.



## Tuning Knob

---

The **Tuning knob** provides adjustment of the frequency in fixed 1 kHz, 100 Hz, 10 Hz or 1 Hz steps.



To use the tuning knob, position the mouse cursor over the knob (the cursor will turn into a curved double ended arrow) and click using either the left or right mouse button. If the cursor is on the top half of the knob, the left button will decrease the frequency, and the right button will increase the frequency. If the cursor is in the lower half, the opposite will occur (and the cursor will invert its shape).

***You don't need to move up or down with the cursor to change the rotation of the knob. Simply press either the right or left mouse button.***

As the knob rotates, the frequency will change in 1 kHz steps. Holding the mouse button down will accelerate the tuning.

The step size can be changed to 100 Hz, 10 Hz or 1 Hz by pressing the **Alt**, **Shift** or **Ctrl** keys, respectively, while clicking the tuning knob with mouse button.

The tuning knob can also be conveniently rotated using a wheel of a wheel-equipped mouse, or any other standard Windows-supported pointing device. The tuning steps can be also modified using the **Alt**, **Shift** or **Ctrl** keys.

## Keyboard Tuning

---

The receiver's frequency can also be adjusted using the keyboard cursor control keys (the **arrow** keys): Using the up/down arrow keys, the frequency changes in 1 kHz steps. Similarly to using the tuning knob or the mouse wheel, the step size can be again changed to 100 Hz, 10 Hz or 1 Hz using the **Alt**, **Shift** or **Ctrl** keys, respectively, while pressing the up/down arrow keys.

## Multiple Receiver Operation

---

With the WiNRADiO *Excalibur Sigma* you can tune to three stations at once, listening to one (or all of them mixed together). Listen to one while recording the others (into separate files).

The only condition is that all of these frequencies must fit inside the DDC1 bandwidth. The DDC1 bandwidth is selectable using the **DDC BW** control above the DDC1 spectrum.

You can select one of the three receivers by clicking on the associated tab above the main frequency display:

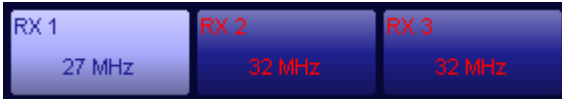

The same tuning procedure applies for all three receivers. For example you can type the frequency directly into the keyboard, use the tuning knob, etc. If the new frequency is such that the existing DDC1 bandwidth 'cannot accommodate' this new frequency while keeping the other receivers tuned to their existing frequencies, the software will “dump” (disable) one or both of the other two receivers. This gives priority to the currently selected receiver, except when one of the other receivers is currently recording or its frequency is “locked” by the user. In such a case, the new frequency will not be accepted and the recording or lock indicators inside the other receivers' tabs will flash to indicate this situation. You will either need to manually stop the recording or unlock the locked receivers.

The receivers can be locked by using the **Lock** button  located above the demodulator spectrum (DDC2). Each receiver can be locked separately.

If a receiver is locked, a “lock” symbol will appear in the bottom-left corner of its associated tab:



If you are currently recording the DDC1 spectrum using the DDC recorder, it will be impossible to tune any of the three receivers to any frequency outside

of the currently recorded DDC1 spectrum. Any such attempt will be ignored and the recording button above the DDC spectrum will flash to indicate the reason why this operation failed. You would need to stop the recording first.

If tuning to a new frequency causes a receiver to be disabled, this disabled receiver's audio will be muted, and the tuned frequency shown in the corresponding receiver tab will turn 'red' to indicate that this receiver is currently non-active. Clicking on a disabled receiver's tab will re-activate the receiver, which may in turn disable a previously active receiver.

By clicking on the receiver tabs, you can quickly alternate between receivers in a similar way in which you would use the **VCO** function in a conventional receiver. There is the additional benefit of being able to change complete receiver settings including demodulation mode, bandwidth, notch filter, audio filter, etc. without the need to keep reprogramming when switching receivers.

---

## Point-and-Click Tuning

---

Pointing and clicking anywhere inside the three spectrum scopes will tune the currently selected receiver to the corresponding frequency. Also when clicking on the spectrum, the **Shift** or **Ctrl** keys can be held down, which will round the tuned frequency to the nearest kHz or 100 Hz, respectively. However, there are some ramifications depending on which one of the three spectrum scopes you click:

Clicking inside the **Wideband Spectrum Scope** at the bottom of the application window (when the **Spectrum** button is engaged) will center the DDC1 passband of the selected receiver to the new frequency. In turn, clicking on the DDC1 passband may center the demodulator (DDC2) passband to the new frequency.

---

## Dragging the Passband

---

The dark blue rectangular area inside the wideband spectrum scope represents the DDC1 passband; the gray area inside both the DDC1 and demodulator (DDC2) spectrum represents the demodulator filter passband. You can drag all these areas and this will result in a corresponding change of the tuned frequency. As with point-and-click tuning, there are again some differences in behavior depending on which particular spectrum window the highlighted passband is being dragged in.

Dragging the gray area in the wideband spectrum will relocate the DDC1 passband to a new frequency. However, it is not possible to drag beyond the current spectrum boundaries; you will need to stay within the current frequency range.

Internally, the receiver's hardware operates in two separate ranges: **Range 1** from 1 kHz to 88 MHz and **Range 2** from 118 MHz to 190 MHz; the fine tuning with 1 Hz resolution is accomplished by software processing.

So, to switch between frequency ranges, you can either retune the receiver to the new frequency using any of the standard methods, or you can switch the range using these two buttons (which are located above-right of the wideband spectrum):

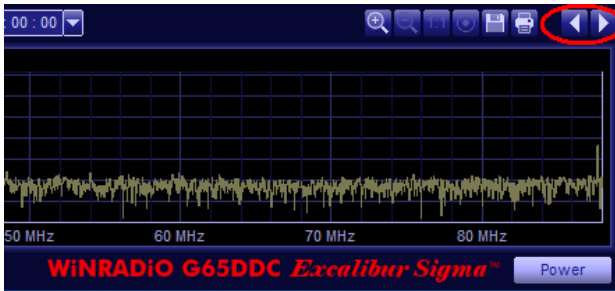

Inside the DDC1 and demodulator (DDC2) spectra, it is actually possible to drag the respective DDC or demodulator filter passbands beyond the existing boundaries, in both directions. In such a case, the receiver will tune automatically.

Dragging either one of the edges of the grayed-out area inside the demodulator spectrum will result in continuously changing the filter bandwidth, except for LSB and USB modes. (This function is not available in the demodulator spectrum so as to prevent unwanted dragging of the entire passband when the shaded area becomes too narrow with larger demodulator bandwidths.)

For LSB mode, dragging the right-hand edge of the grayed-out filter passband results in tuning, dragging the left-hand edge results in adjusting the filter bandwidth. For USB mode, the opposite applies. The edge that is used for tuning is highlighted for operator convenience.

## IF Shift and Passband Tuning

Dragging the grayed-out demodulator filter passband in the demodulator spectrum will result in tuning the receiver in a manner somewhat similar to the **IF Shift** function in conventional receivers. The passband will move inside the displayed spectrum and the tuned frequency will change accordingly.

In a DDC-based receiver, "**IF Shift**" is in fact a misnomer because there is no "intermediate frequency", but as this is a time-honored and commonly used term for this function, we will still use it here for convenience.

IF shift makes it possible to tune the receiver by positioning the demodulator filter precisely over the spectrum of the received signal, while keeping the DDC passband located exactly where it is.

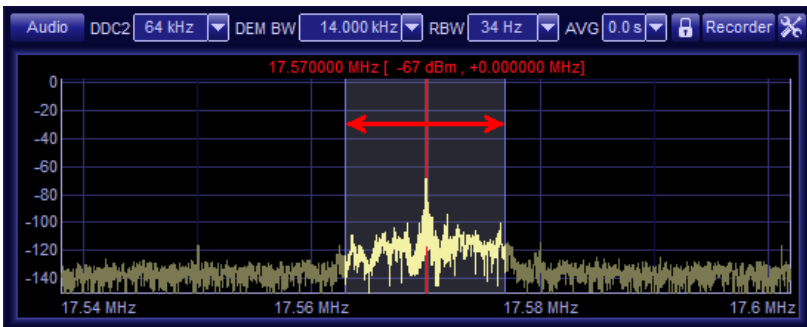

This makes it possible to quickly and visually tune to another station represented by a signal peak in the spectrum. However, it is not very suitable for the AMS, USB, LSB, ISB, DSB and CW modes if you only wish to adjust the filter passband position slightly for the station you are currently receiving (for example in order to avoid interference from an adjacent channel).

If you do this, when you are for example, tuned to an AM station using the AMS mode, or an SSB station using the USB or LSB modes, then moving away from the exact carrier frequency will result in a whistle being heard, its pitch being directly proportional to the IF shift displacement. This is because while you have changed the tuned frequency, you have not changed the "BFO" (or rather the digital equivalent of it) simultaneously.

To make it possible to move the filter but still remain tuned to the same frequency, there is also an associated **Passband tuning** function: This is

invoked simply by dragging the filter passband with the right mouse button instead of the left one. This makes it possible to finely adjust the filter position in the AMS, LSB, USB, ISB, DSB and CW modes without the whistle effect, because the internal “digital BFO” will be tuned alongside the passband movement.

When the demodulator passband is being dragged using the right mouse button, a red **PBT** indicator will appear next to the cursor to indicate you are in the PBT mode, and showing the tuning offset at the same time:

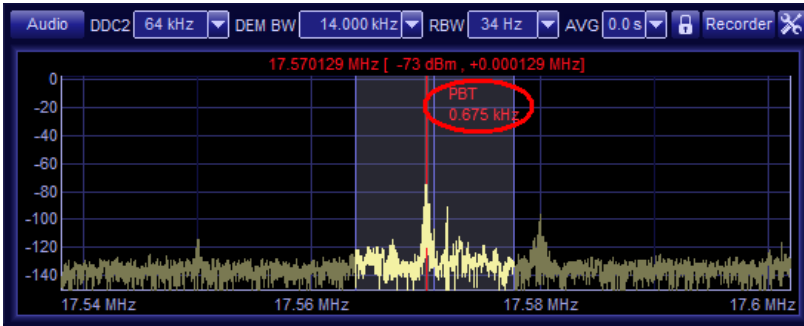



To revert to the IF shift mode, simply use the left mouse button again.

## Frequency Stepping

---

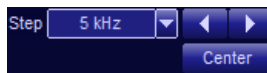
To make the chapter on tuning complete, we need to fast forward a bit: There is one more tuning facility located on the right under the **Tuning tab** (all the **function tabs** will be described in more detail in one of the following chapters):



The **Step** control selects the stepping size. The following convenient step sizes are available: 1 Hz, 10 Hz, 100 Hz, 1 kHz, 3.125 kHz, 5 kHz, 6.25 kHz, 9 kHz, 10 kHz, 12.5 kHz, 25 kHz, 50 kHz, 100 kHz. The left  and right  arrow buttons perform the actual stepping.

## Frequency Display Offset

---

It is possible to connect the *Excalibur Sigma* to a down-converter to receive frequencies which are normally beyond the *Excalibur Sigma*'s frequency range. In this scenario, it is convenient to see the actual received frequency rather than having to manually transpose the displayed frequency to the down-converter's input signal.

For this purpose, there is an option to add a user-defined offset to the displayed frequency. This option is called **Display offset** and is located under the **Options** top menu bar:

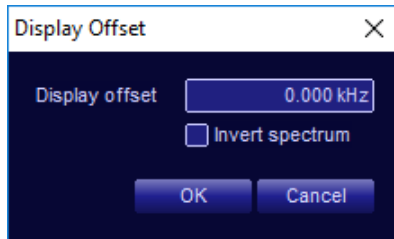

As usual, you can enter the display offset in Hz, kHz or MHz by terminating the entered value with either **h**, **k** or **m**, respectively, if you prefer to change the displayed frequency unit.

An option to invert the spectrum is provided for situations where the spectrum is inverted by the down-converter.

## Receiver Selection

---

Clicking on one of the three **Receiver tabs** located above the main frequency display selects that particular **virtual receiver**. The other receiver continues operating provided its frequency fits within the current DDC1 spectrum bandwidth.

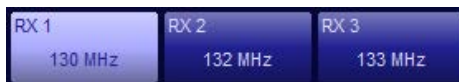

The tuned frequency of each receiver is displayed inside their associated tabs.

If the frequency of one of the other receivers does not fit into the current DDC1 spectrum bandwidth, that receiver becomes disabled and the frequency in the tab turns red to indicate the disabled condition.

The position of all virtual receivers (or rather their demodulator DDC2 bandwidths) is shown as dark blue areas inside the DDC1 spectrum scope, with the currently selected receiver highlighted.

If a receiver is tuned away from the current DDC1 spectrum bandwidth (and therefore disabled), it will not be shown in the DDC1 spectrum.

By clicking on the receiver tabs, you can quickly alternate between receivers in a similar way in which you would use the **VFO** function in a conventional receiver. There is the additional benefit of being able to change complete receiver settings including demodulation mode, bandwidth, notch filter, audio filter, etc. without the need to keep reprogramming when switching receivers.

## Mode Selection

---

The **Mode selection** buttons are located at the top-right of the receiver's control panel.



The individual buttons correspond to the following modes:

<b>AM</b>	Amplitude Modulation
<b>AMS</b>	Amplitude Modulation (Synchronous Demodulation)
<b>LSB</b>	Lower Side Band
<b>USB</b>	Upper Side Band
<b>DSB</b>	Dual Side Bands
<b>ISB</b>	Independent Side Bands
<b>CW</b>	Continuous Wave (Morse Code)
<b>FM</b>	Narrow-Band Frequency Modulation
<b>DRM</b>	"Digital Radio Mondiale" (HF Digital Radio)



<b>FSK</b>	Frequency Shift Keying
<b>UDM</b>	User Definable Mode

In addition to the standard AM, LSB, USB, CW and FM modes, the *Excalibur Sigma* receiver is equipped with several special modes, **AMS**, **ISB**, **DSB**, **DRM**, **FSK** and **UDM**.

## AMS Mode

The **AMS** mode is used to improve reception quality of amplitude-modulated signals, especially those affected by selective fading which occurs over a large distance.

When the AMS mode is selected, special controls appear under the tuning tab, making it possible to select one (or both) of the signal's sidebands to achieve optimum reception:

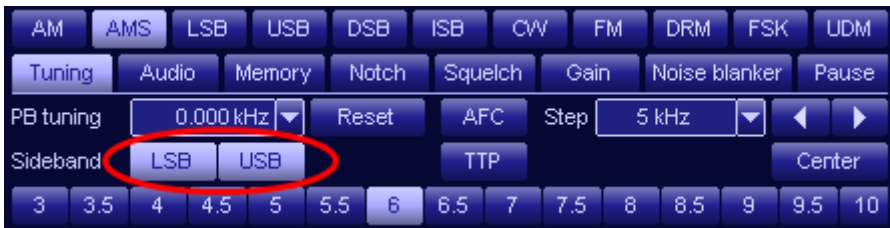

In the AMS mode, there is a certain "capture range", a frequency range within which the receiver will "capture" the signal and achieve synchronization. If you are tuning to a new signal, this initial capture ("**Tune capture range**") is initially quite wide, within plus or minus 1.5 kHz (default value) from the actual signal frequency. This is to enable easy tuning by pointing and clicking near the peak in the DDC1 spectrum, or dragging the filter passband area in the demodulator spectrum.

Once locked to a signal, the capture range automatically reduces ("**Sync. lock range**") to plus or minus 50 Hz (default value) from the signal frequency. The reason for such reduction is to avoid "kidnapping" of the synchronization frequency by a nearby strong signal if the carrier signal fades, as may happen especially with long-distance reception, due to ionospheric effects.

Both the **Tune capture range** and the **Sync. lock range** values are user-definable, under the **Options | AMS capture range** menu:

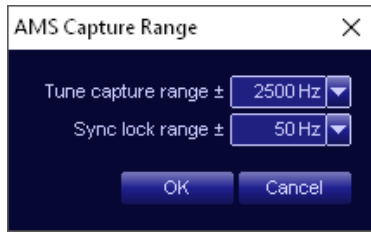

When the signal is locked in synchronization, this is indicated using a "lock" symbol located in the top left corner of the frequency display:



## ISB and DSB Modes

**ISB** (independent sideband) is quite similar to the AMS mode and makes it possible to receive independent information in the two sidebands of an AM-modulated signal with suppressed, or partially suppressed, carrier.

The desired audio output can be selected between the lower and upper side bands using two selector **USB** and **LSB** buttons accessible under the **Tuning** tab:

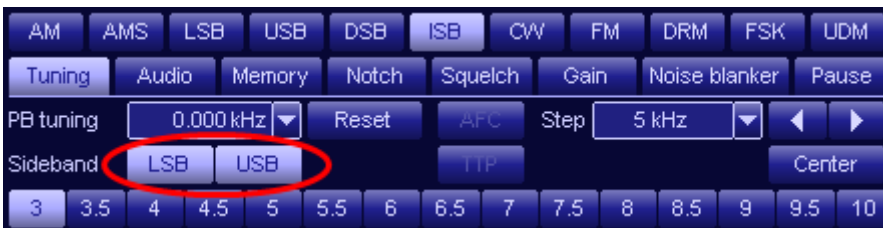

**Note: Both channels of an ISB transmission can be recorded simultaneously using the recording facility of the G65DDC receiver. For this purpose, allocate two receivers to the same signal, select LSB on one and USB on the other, and record the signals separately.**

In the DSB (dual sideband) mode, both side-bands carry the same information, but the carrier is either entirely or partially suppressed. The controls and operation are similar to the AMS mode.

## DRM Mode

---

The **DRM** mode is a new broadcasting system designed to introduce digital broadcasting to medium and short waves, commonly referred to as DRM30. This is achieved by introducing sophisticated state-of-the-art digital signal coding and compression, together with extending channel bandwidth. This results in a dramatic improvement in broadcast quality. For more information about this mode, refer to [www.winradio.com/drm](http://www.winradio.com/drm)

Activating this mode requires purchasing a license from the **DRM consortium**. Selecting the DRM mode will provide details how to acquire the license.

After acquiring the license (and installing the key), when the DRM mode is selected, the contents of the audio tab change to accommodate the special requirements of this mode:



When a DRM station is successfully received, on top of the demodulator spectrum (DDC2), there will be a text display that shows a continuously running “ticker” text which is usually transmitted by the station along with the audio, and which typically contains the station ID and program information associated with the broadcast.

At left, there is also a description of “services” that are available. Up to four services are available in a DRM broadcast, and these are selectable by the services selector in the Audio tab:



On the right-hand side of the demodulator spectrum (DDC2), a DRM capture progress indicator will display **Sync detected** before **Audio decoded** and finally **Signal-to-Noise Ratio (SNR)**, indicating the quality of the received signal. For reliable audio output, the SNR needs to be above a

certain threshold, typically 15 dB. Until this threshold is reached, the audio is entirely muted (no noise at all coming from the speaker), as the decoded signal would not render any usable audio.

The *Excalibur Sigma*'s DRM decoder can also decode **multimedia content**, which is audiovisual information that may be broadcast by some DRM stations. If such multimedia content is detected in the incoming signal, a special browser program is launched to display this information.

To receive a DRM station, simply tune to the frequency and select the DRM mode. If the signal is of sufficient strength and quality, it will be decoded. A DRM station is easily recognizable thanks to its characteristic flat spectrum:

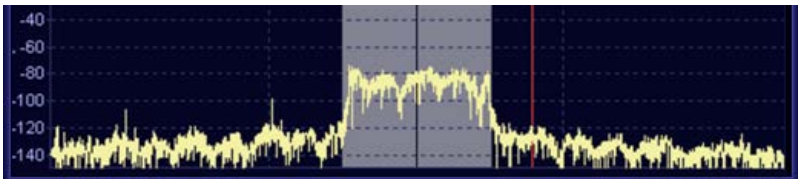

DRM broadcaster schedule information is available at [www.drm-dx.de](http://www.drm-dx.de) and also at [www.drm.org/index.php?p=broadcast\\_schedule](http://www.drm.org/index.php?p=broadcast_schedule).

---

*Did you know?*

*WiNRADiO became involved in DRM technology shortly after its inception. Our laboratory in Melbourne, Australia, was used to conduct long-range reception tests and our G3-series receivers were developed to ensure optimum DRM performance.*

## FSK Mode

---

The **FSK (Frequency Shift Keying)** mode performs in a similar manner to the CW mode, in that all of the parameters associated with CW are also available with FSK, but each with its own independent setting. Of particular note is the **tone** frequency: With CW, or Morse transmission, this is typically set to 800 Hz to provide a comfortable sound for the listener. However, with FSK transmissions, because of the need to make the frequency readout of the main receiver display correspond to the published frequency allocation tables, the tone frequency must be different. The FSK tone frequency is traditionally set to 1.9 kHz due to the typical characteristics of modems relying on transmitters operating in a suppressed carrier mode. However, any offset may be used, and the values are automatically saved.

## UDM Mode

---

The **UDM (User Definable Mode)** makes it possible to define any set of parameters for a special application. All settings, including the actual demodulation mode, may be selected and saved. For instance a user may wish to have a special USB mode with a very wide demodulation bandwidth, and unusual audio filter settings, and these may all be catered for, saved, and be available for quick and easy recall.

**Note that as there are three receivers in the Excalibur Sigma, each receiver can have its mode set independently. The current mode setting for each receiver will be remembered when the user exits the program.**

## Function Tabs

---

The **Function tabs** are located under the mode buttons:

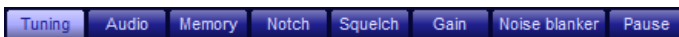

The function tabs contain numerous essential and ancillary functions dedicated to various aspects of the receiver's operation.

## Tuning Tab

The **Tuning tab** contains controls for **Passband tuning**, **BW presets**, demodulator spectrum **Centering**, **AFC (Automatic Frequency Control)**, **TTP (Tune to Peak)** and **Stepping** controls. For the AMS, LSB and DSB modes, it also contains lower or upper sideband selection, and for the UDM mode there is also a mode selection.

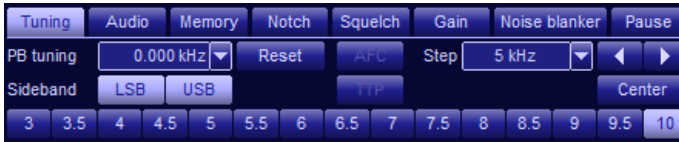

### Passband tuning

The 'passband tuning control' duplicates the function of dragging the demodulator passband using the right mouse button. These two methods (drop-down or mouse) are interchangeable. The advantage of this control is that the actual tuning offset is visible and can be precisely adjusted.

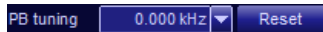

Passband tuning makes it possible to finely adjust the demodulator filter position in the AMS, LSB, USB and CW modes without a whistle effect due to a misaligned BFO, making it possible to avoid interference and finely tune the receiver for optimum reception.

Pressing the **Reset** button sets the passband tuning offset to zero.

### Demodulator Bandwidth Presets

The **Demodulator filter bandwidth** (which represents the overall selectivity of the receiver) can be set in two ways: The quickest way is to use the preset values represented by the row of 15 buttons at the bottom of the Tuning tab:

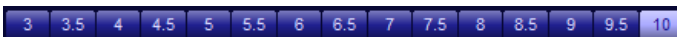

The numbers on the buttons represent the bandwidth in kHz. These preset bandwidths change depending on the selected mode, offering an optimum choice of typical values applicable to that mode. These buttons do not appear when DRM is selected because the bandwidth is fixed.

To change the demodulator bandwidth continuously, you can use the **DEM BW** control located above the demodulator spectrum scope:



There are two ways you can use this control: Either click on the box and highlight all digits, then type the bandwidth directly into the edit box (you can terminate the entry with **h** for Hz or **k** for kHz), or select the required bandwidth value using the drop-down list.

Another very convenient method of adjusting the demodulator filter bandwidth is a graphical one, by dragging the edges of the shaded area representing the filter passband in the demodulator spectrum:

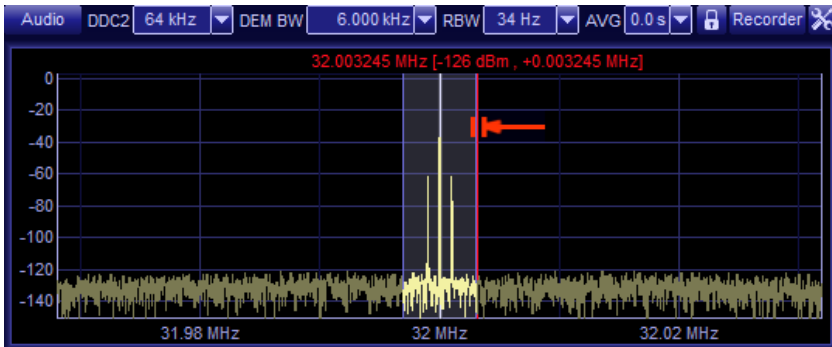

Continuous adjustment of the demodulator filter bandwidth makes it possible to adjust the bandwidth to exactly fit the actual spectrum of the received signal, to obtain the best signal-to-noise ratio and minimize interference from adjacent channels.



For USB/LSB modes, dragging one edge of the shaded area adjusts the tuning position, while dragging the other edge adjusts the filter bandwidth. The "tuning edge" is highlighted for easy orientation. The same applies to AMS, ISB and DSB modes - if only one sideband is selected.



## Frequency Stepping

Another facility available under the tuning tab is **Frequency stepping**:



The **Step** control selects the stepping size. The following convenient step sizes are available: 1 Hz, 10 Hz, 100 Hz, 1 kHz, 3.125 kHz, 5 kHz, 6.25 kHz, 10 kHz, 12.5 kHz, 25 kHz, 50 kHz, 100 kHz. The left  and right  arrow buttons perform the actual stepping.

## Spectrum Centering

The **Center** button , next to the stepping controls, centers the demodulator passband.

Use this button if you have tuned to a station by dragging the filter passband over its spectrum, and you would like to see this station relocated to the center of the demodulator spectrum.

## AFC (Automatic Frequency Control)

When engaged, the AFC button  forces the receiver to automatically adjust its tuning to follow the frequency drift of the received transmission.

While this function is active, the receiver will periodically check the received signal and correct the frequency in approximately five-second intervals.

***This facility is not recommended for LSB and USB modes with voice modulation.***

## TTP (Tune to Peak Control)

The **Tune to Peak** function can be invoked by pressing the **TTP** button . The receiver will tune to the signal peak (provided the peak falls inside the selected IF bandwidth – the highlighted area of the real-time frequency spectrum).

Depending on the location of the peak and type of signal, it may take several seconds for the receiver to tune in accurately, by a successive approximation process.

*In LSB and USB modes, the success of this facility will depend on the type of modulation signal. It may be useful for certain types of data modulation (fax), but is not usually recommended for voice modulation.*

## Band Selection

In the AMS, ISB and DSB modes, the tuning tab also includes **Band selection** controls:

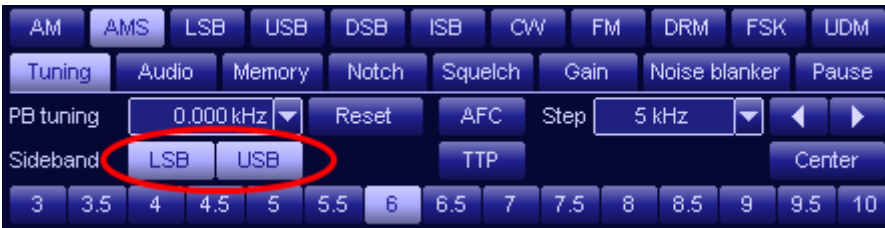

These controls make it possible to choose which of the sidebands is to be listened to, either the lower sideband, upper sideband, or both. This is useful in situations where one of the sidebands is damaged by interference.

## UDM Mode Selection

If the UDM mode (User Definable Mode) is selected, the AMS band selection controls are replaced with the **Mode** selector for the user-defined mode:

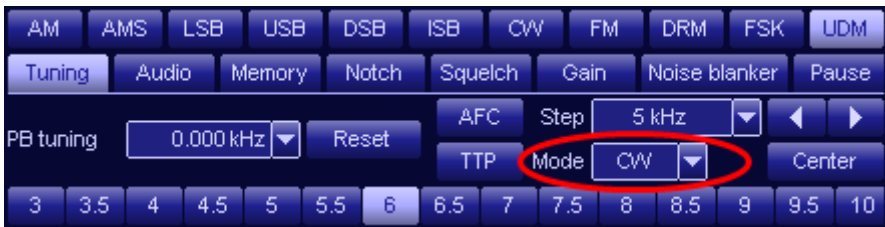

The UDM mode can utilize the AM, USB, LSB, CW or FM modes.

## Audio Tab

The **Audio tab** contains functions specific to the parameters of the output sound, for example volume and audio filtering.



### Audio Filter

The **Filter** button turns on the **Audio filter**. The audio filter is a bandpass filter with continuously adjustable lower and upper cut-off frequencies:



When the audio filter is enabled, its low and high cut-off frequencies can be adjusted using the **Low** and **High** controls. The **De-em** control is used to adjust **de-emphasis**, relating to the filter's slope from the highest frequency to the lowest, which is particularly important for FM signals (a typical de-emphasis value for narrow-band FM-modulated signals is 6.0 dB/oct). However, it can be also useful for AM signals: Gently sloping the filter passband can sometimes make the signal easier on ears and avoid operator fatigue.

The audio filter passband is shown as a shaded area inside the **Audio spectrum**, which is accessible by pressing the **Audio** button:

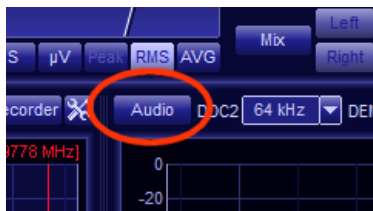

The filter can be also adjusted graphically, by dragging either edge of the audio filter passband:

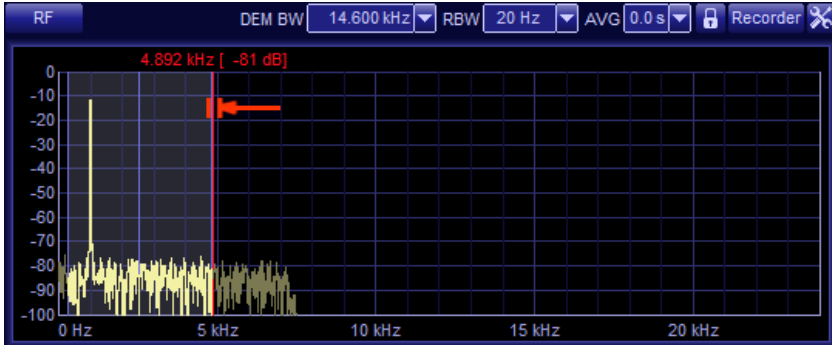

Clicking the **RF** button while the audio spectrum is displayed will return the spectrum scope to the default RF spectrum mode.



## Volume Control



The **Volume control** is also located under the Audio tab. The volume can range from 0 (no sound) to 31 (full volume). To enter a value directly, click on the display and type in the new volume level followed by ENTER. The volume can also be increased or decreased by selecting the desired value from the drop-down list.

An alternative way of changing the volume is by using the **Volume slider**. Place the mouse cursor on the slider and drag it either left or right to change the volume.

Finally, another convenient way of changing the volume is using the **left and right cursor keys** on the keyboard. This can be done anytime, no matter which of the function tabs is selected.

Next to the volume control is the **Mute** button, which makes it possible to disable the audio output. This is faster and more practical to use than setting the volume to zero, with the added benefit of not changing the set volume level. To use the mute control, simply click on this button. Click again to release.

## Audio Mixer

The WiNRADiO *Excalibur Sigma* includes an audio mixer, which makes it possible to combine audio outputs from the three virtual receivers in various ways. For example, you could simply listen to all three signals mixed together. Or, you might be recording with one receiver and listening to the second receiver with your left ear and the third receiver with your right ear. There are many possible combinations.

The mixer buttons are located at the bottom left of the audio tab:



If the **Mix** button is disabled, the currently selected receiver will behave as if there was no mixer at all, and you will simply hear audio from the receiver which you have currently selected (i.e. the receiver that is *in focus*).

Enabling the mixer button for a particular receiver will connect its audio output to the mixer. The mixer is stereo and using the **Left** and **Right** buttons, you have a choice of sending a receiver's audio to the left or right audio channel, or both.

***To listen to mixed audio, you need to select a receiver which is actually connected to the mixer, i.e. has the Mix button engaged.***

Here are some examples of several mixer button combinations and the effect they have on the resulting audio:

<b>RX 1 settings</b>	<b>RX 2 settings</b>	<b>RX 3 settings</b>	<b>Currently selected</b>	<b>Resulting audio</b>
Mix = on Left = on Right = off	Mix = on Left = off Right = on	Mix = off	RX3	Only RX3 will be heard (because it is currently selected and not connected to mixer)
Mix = on Left = on Right = off	Mix = on Left = off Right = on	Mix = off	RX1	Audio will come out for RX1 and RX2 only; RX1 from left channel and RX2 from right channel
Mix = on Left = on Right = off	Mix = on Left = off Right = on	Mix = on Left = off Right = off	RX3	Audio will come out for RX1 and RX2 only; RX1 from the left and RX2 from the right channel. (RX3 will not be heard even though it is currently selected, because neither the Left nor Right buttons are engaged.)
Mix = on Left = on Right = on	Mix = on Left = on Right = on	Mix = on Left = on Right = on	RX3	Audio will come out for all RX1, RX2 and RX3, all mixed together, from both channels
Mix = on Left = on Right = off	Mix = on Left = off Right = on	Mix = on Left = on Right = on	R 3	Audio will come out for all RX1, RX2 and RX3: RX1+RX3 from left channel, RX2+RX3 from right channel

## Virtual Sound Card

The *Excalibur Sigma* receiver is equipped with an interface to the WiNRADiO **Digital Bridge™ Virtual Sound Card**.

The Virtual Sound Card (VSC) is a software option designed to transfer digitized audio signal streams from WiNRADiO receivers directly to other applications. It does so by creating a Windows multimedia driver which will make the WiNRADiO receiver appear to the system as another sound card.

Third party software applications which would normally rely on a sound card input as the signal source (such as various data decoders), can access

digitized data (either undemodulated IF signal or demodulated audio) directly from the WiNRADiO receiver, eliminating unnecessary conversions between the digital and analog domains, reducing distortion and improving signal quality. For more information about the VSC, please refer to the webpage [www.winradio.com/vsc](http://www.winradio.com/vsc)

The VSC control buttons become available once the VSC is installed:



Engaging the **VSC** button connects the selected receiver to the virtual sound card. Using the **IF** button, you can select the entire contents of the demodulator spectrum to the VSC; the **Audio** button only sends the filtered and demodulated audio.

The VSC IF signal is sent in I/Q (in-phase and quadrature) form, 16 bit, stereo. The I/Q outputs are at baseband (zero frequency) and the target application must be able to accept these parameters. Any demodulation mode may be selected for the IF output - this setting is not relevant as the VSC IF output sends a raw spectrum without any filtering or demodulation.

***The sampling rates for both the VSC audio and IF outputs can be set independently, using the VSC Set-up function under the Options top menu bar.***

To use the VSC for audio output, select the required demodulation mode and engage the VSC Audio button. This will connect the receiver's demodulator to the VSC stream. The demodulated audio will be affected by all the various settings normally available for the demodulation, such as bandwidth, audio filter, etc.

VSC can only be active on one virtual receiver at a time and is indicated by the letters **VSC** appearing on the corresponding RX1, RX2 or RX3 tabs. You have to deselect VSC from the active virtual receiver before it can be used on another virtual receiver.

You can have the VSC installed and running in five minutes!

The Digital Bridge™ Virtual Sound Card and many other software accessories are available via direct download at WiNRADiO online software shop [www.winradio.com/directdownload](http://www.winradio.com/directdownload).

## Memory Tab

---

The **Memory tab** contains functions related to the frequency memory available in the *Excalibur Sigma*. This user-defined memory makes it possible to store and recall arbitrary frequencies, and group them together in a tree-like structure.

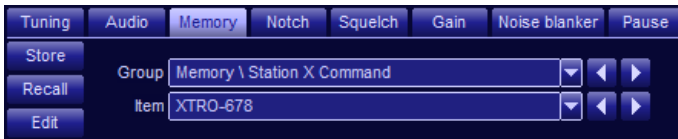

The number of frequencies that can be stored in *Excalibur Sigma* memories is limited only by the size of your computer's hard disk.

### Storing a Frequency into Memory

With each frequency, you can store several additional attributes: mode, callsign, description, bandwidth, squelch parameters, audio filter parameters and a hotkey.

To store a frequency into memory, the receiver must first be tuned to that frequency. Next click on the **Store** button:

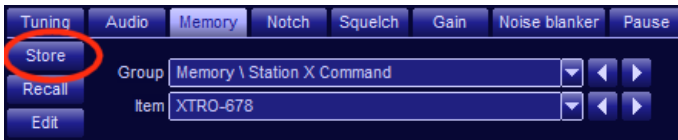

A **Store frequency** window will pop up:



At the top of the window is the **Callsign** edit box. That's where you would store a callsign or a name of the station whose frequency you are storing. The next line contains a **Description** where you can type your comments regarding the station. Below is the **Frequency** you are storing and the demodulator **Bandwidth**.

The mode buttons (**AM**, **AMS**, **LSB**, etc.) make it possible to store the demodulation mode. If you do not wish to store a particular demodulation mode with a frequency, simply leave the **Mode** button disengaged – in such a case, the frequency will be recalled with the currently selected demodulation mode unchanged.

The squelch settings can be also stored optionally. If enabled using the **Squelch** button, the specified squelch settings will be applied automatically when the frequency is recalled, otherwise the current receiver settings will be preserved. Note that while the **Level** squelch can be applied at all times, the **Noise**, **Voice**, **CTCSS** and **DCS** squelch buttons are mutually exclusive.

The same applies to the audio **Filter**, **Attenuator**, **Preamp** and **DDC** settings. If enabled, their settings will be stored together with the frequency and the specified values will be applied when the memory is recalled.

### Hotkey

For quick tuning to your favorite stations, you can also assign a **Hotkey** (function keys **F2** to **F12**) to up to eleven different frequencies. If you then press this hotkey, the associated frequency will be instantly recalled. Hotkeys which are already assigned will be shown in the drop-down list preceded with an asterisk. However you can overwrite the previous assignment with a new one if you wish. Note: F1 calls the help menu so cannot be assigned to a memory.

### Memory scan lockout

This setting relates to the **Scanner** facility. If this checkbox is ticked, this will cause this frequency to be skipped while scanning.

***Note that as although the Excalibur Sigma does not have the scanner facility, the memory format is the same for a range of WiNRADiO receivers and some of the support memory scanner facility.***

### Recalling a Frequency from Memory

There are several ways to recall a frequency from memory:

- Using the **Recall** button
- Using the **Memory step** buttons
- Using a hotkey
- Selecting the frequency directly from the memory tree structure

To recall a frequency, click on the **Recall** button. A dialog box will pop up showing a list of all memory frequencies:



To select a frequency, click on an item in the list on the right, and the frequency will be tuned. Then close the window.

Frequencies which have been set for **Memory scan lockout** are indicated by a **x** symbol at the left-hand side.

## Editing a Memory

To change the settings for a particular frequency, click on the **Edit** button, or select **Edit** from the right-click menu:

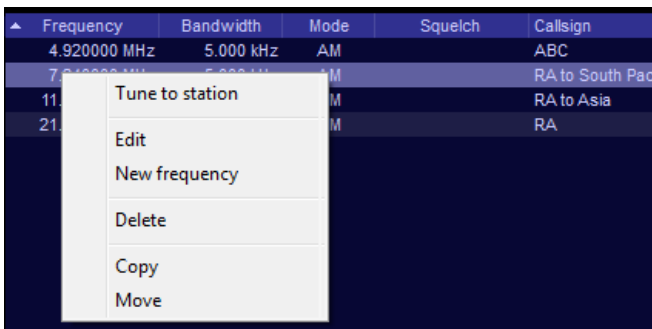

A window will open showing the current settings. All settings can be edited. After the entry has been edited, click on **OK**.

## Deleting a Frequency

To remove a frequency, first click on the **Recall** button. Select the frequency you wish to delete, and click on the **Delete** button at bottom right (alternatively,

select **Delete** from the right-click menu). You will be asked to confirm that you wish to delete this frequency from memory.

To delete all frequencies in a particular folder, click on the **Delete** button at bottom left (under the folders). You will be asked to confirm that you want to clear all the frequencies in the folder.

## Viewing the User Memory

To see the entire user memory structure, you can use either the **Recall** button, or the equivalent function **Show user memory** under the **Memory** top bar menu. The **User memory** window will open.

In the left-hand portion of the window, you can set up a tree-like structure made of folders and subfolders:

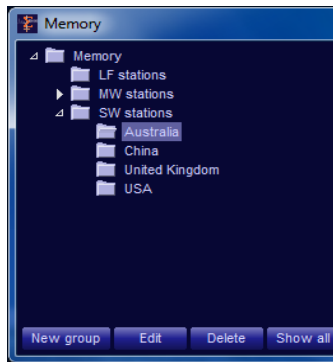

All these folders and subfolders are user-definable and can be nested indefinitely, i.e. a subfolder can contain another subfolder, etc. These folders and subfolders represent memory **Groups**. You can group frequencies together using your own arbitrary criteria. To create a new group, use the **New group** button at bottom-left of the User memory popup. If you do this after you have clicked on a particular subfolder, another subfolder will be created in it.

Inside each subfolder (i.e. group), you can store as many frequencies as you wish, limited only by your hard drive capacity. You can create a new frequency by clicking the **New frequency** button (in the User memory popup) or you can do this using the **Store** button under the memory tab (in such case the new frequency will be stored in the currently selected group, as displayed under the memory tab).

## Memory Stepping

Memory stepping makes it possible to step through frequencies stored in the current user memory file.

To step through groups or the individual memory frequencies, use the left or right arrow buttons located under the memory tab next to **Group** or **Item** drop-down list controls:

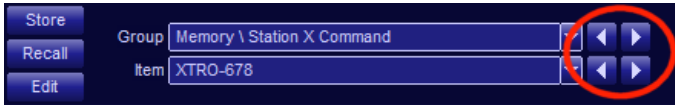

When the receiver is tuned to a frequency that is equal to a frequency stored in the memory, the stored callsign will be shown in the band indicator under the main frequency display. If there is no callsign stored with the frequency, the content of the description field will be shown instead.

The user memory will first be searched for a matching frequency for the currently selected group. If no matching frequency is found there, then the whole memory structure will be searched and the first one found will be displayed.

## Saving the User Memory File

You can have more than one user memory file; the number of such files is limited only by the capacity of your hard drive. You can save a user memory file under an arbitrary name, and then load it back, making it possible to have different memory files for different situations. To save the current memory file, simply select **Save user memory as** from the top bar **File** menu. A dialog box will pop up allowing you to specify the file name.

When you exit the WinRadio *Excalibur Sigma* application, all memory changes are automatically saved; there is no need to use the Save command before exit.

*Note: The default user memory file is called **Memory.r7m** and resides in the following folder: **My Documents/WiNRADiO/G65DDC***

## Opening the User Memory File

When the WiNRADiO *Excalibur Sigma* receiver application starts up, the most recently used memory file will be opened automatically.

To open a different memory file, select **Load user memory** from the **File** menu. A dialog box will pop up allowing you to choose a memory file to load.

## Notch

---

The **Notch tab** contains controls dedicated to the **Notch filter** function. There are two notch filters which can be operated simultaneously:



The notch filter is a **band-stop** filter which can be used to minimize the effects of interference falling inside or near a received station's spectrum. Each filter is activated by pressing the associated **Enable** button. The center frequency and the width can be adjusted using the appropriately named controls.

For both notch controls, the same usage rules apply as with the demodulator bandwidth setting, i.e. the values can be changed by direct manual entry, or selected from the drop-down list.

Another way of changing the notch filter parameters is by dragging the stopband of the filter (a blue shaded area) with the mouse. The stopband width can be adjusted by dragging the edges, while the center frequency can be changed by dragging the center line, which makes it possible to conveniently position the filter stopband over the interfering signal.

The **Center** button serves to relocate the notch filter stopband to the center of the demodulator filter passband. This can be useful in situations when the notch filter is hidden beyond the currently visible demodulator spectrum limits, in particular when the spectrum is zoomed in, or when first enabled.

The following picture shows a signal with strong interference in the passband

(the large peak to the right of center, at the cursor position).

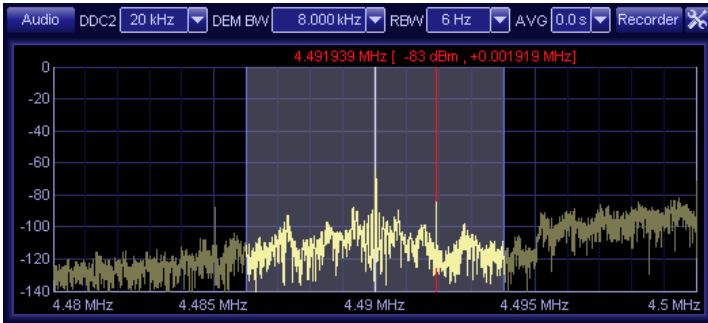

In the resulting audio, typically there would be a strong buzzing sound. After applying the notch filter, adjusting its center and bandwidth (by dragging the blue area center and edges) to fall exactly over the interfering signal, the situation will look like this:

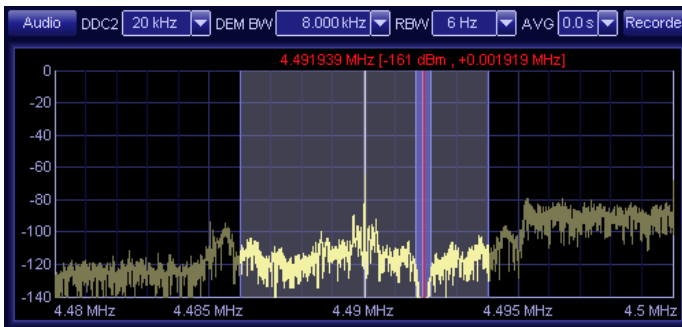

This results in significantly reduced interference and a much more pleasing sound.

## Squelch

The **Squelch tab** contains squelch-related controls:

Tuning	Audio	Memory	Notch	Squelch	Gain	Noise blanker	Pause
Enable				Voice	50 %	35%	
Level	-50 dBm	-36 dBm		CTCSS	62.5 Hz	167.9 Hz	
Noise	50 %	45%		DCS	R	006	?

The squelch control can be used to automatically mute the receiver when no signal is being received. Without a signal, all you will usually hear is noise, so squelch is provided to cut out the noise until a useful signal is received, making the receiver more comfortable to use.

The WiNRADiO *Excalibur Sigma* has five different types of squelch, suited for different types of scenarios:

**Level** squelch refers to the received signal strength, as indicated by the **S-meter**. If the signal strength is lower than the specified threshold, the squelch will mute the receiver. For operator's convenience, the current signal strength level is shown next to the threshold setting (copied from the S-meter). This is the most common form of squelch to use.

**Noise** squelch determines the level of noise in the received demodulated audio above which the squelch will mute the receiver. This is particularly useful for the FM mode, where there is a considerable level of noise in the absence of a useful signal. The current *Noise content* value is also shown next to the corresponding control.

**Voice** squelch determines the contents of voice frequencies in the spectrum of the demodulated audio. If lower than the preset threshold, the receiver will be muted. The voice frequencies content of the currently received signal is also shown next to the corresponding control.

**CTCSS** (*Continuous Tone Coded Squelch System*) defines a particular CTCSS code which, when received, will open the squelch. The currently received CTCSS code is shown in the demodulator spectrum display. A question mark is shown if there is no known CTCSS code currently received.

**DCS** (*Digital Control Squelch, also known as Continuous Digital Controlled Squelch System or CDCSS*) specifies a particular DCS code which will open the squelch. The **R** button serves to indicate a *reverse* code, to comply with systems which transmit the DCS code in reverse. A question mark is shown if there is no known DCS code currently received.

The *Level* squelch can operate simultaneously with any of other types of squelch. If the *Level* squelch is selected together with any other then **both** selected conditions must be satisfied at the same time for the squelch to open ("**and**" condition).

The *Noise*, *Voice*, *CTCSS* and *DCS* squelch modes are mutually exclusive – only one can be active at a time.



To adjust the level squelch control, first tune to an unoccupied frequency that produces only noise. Increase the squelch until the receiver is muted. You will see the red-colored segment of the S-meter growing until it gets higher than the current S-meter value. At that moment the receiver will be muted and the word “**squelched**” will be displayed on the S-meter. Add a few dB extra to allow a margin for background noise fluctuation on the band. Now when you tune to an occupied frequency, if its signal strength is higher than the squelch level, the receiver will be unmuted.

To adjust the noise squelch control, first tune to an unoccupied frequency that produces only noise. Note the **Noise content** value indicated next to the associated control. Then tune to an occupied frequency where there is a useful signal, and note the noise content value again. Then set the noise threshold somewhere between these extreme values. Note that the noise squelch is particularly effective in the FM mode and its values also depend on the demodulator bandwidth setting.

The adjustment procedure for the voice squelch is similar: Tune to an unoccupied channel first, then to an active voice channel, note the corresponding **Voice content** values, and set the voice threshold between these two extremes.

To enable the squelch action, click the **Enable** button. Clicking it again disables it.

***It is easy to forget that squelch is active. If the receiver doesn't seem to be operational (no sound from the speaker), check the squelch and mute settings first.***

## Gain

The **Gain tab** contains several controls to adjust various gain-related settings of the receiver. The gain is a software parameter, and can be set separately for each of the three virtual receivers.

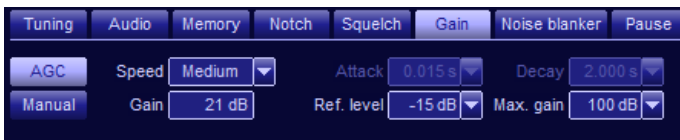

## AGC

The **Automatic Gain Control (AGC)** acts upon the digitally down-converted and filtered demodulator passband, in order to keep the signal coming to the demodulator at a constant level.

This is in fact functionally similar to AGC typically implemented in conventional receivers, which also works on the IF signal prior to demodulation. The difference is that in a conventional receiver, this is implemented in hardware, while with the Excalibur Sigma it is a software function.

The AGC has six speed settings: **Slow, Medium, Fast, User 1, User 2** and **User 3**. These make it possible to select the speed with which the AGC reacts. Typically, the AGC would be in the medium position.



For most practical applications, the medium setting is recommended. Slow setting would be used especially with Morse code (CW mode), while fast AGC speed might be appropriate for very noisy signals, where noise bursts might temporarily desensitize the receiver if a slower AGC was employed.

While the timing of the slow, medium or fast speed settings is fixed, the remaining three settings are user-definable, making it possible to specify the **Attack** and **Decay** times:



The attack time is the speed with which the AGC reacts to a rising signal level, while the decay time is the speed with which it reacts to a falling signal level. These settings are recommended only for advanced users.

When enabled, the AGC tries to maintain the audio output at a constant level, referred to as the **AGC reference level**. This level is also user adjustable under the gain tab, using the **Ref. level** control:

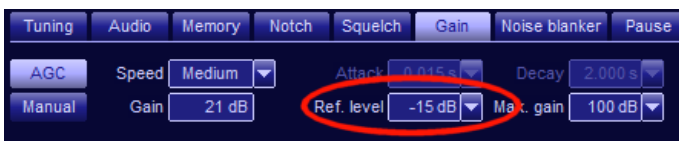

The higher the AGC reference level, the stronger will be the signal at the input of the demodulator. If this level is too high and the input signal too strong, distortion may appear. On the other hand, decreasing the AGC reference level will generally result in lower audio levels.

While in the automatic gain mode, the actual momentary gain will be shown next to the word **Gain** - as can be seen in the following illustration.

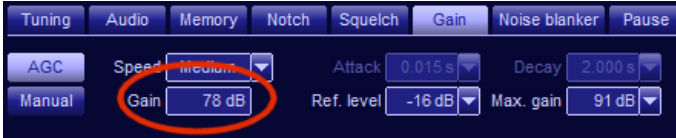

By using the **Max. gain** control it is possible to limit the maximum gain that the AGC has at its disposal, and preventing an excessive “pumping noise” between transmissions. This is especially useful with SSB signals or when monitoring point-to-point transmissions where the transmitter is switched on intermittently.

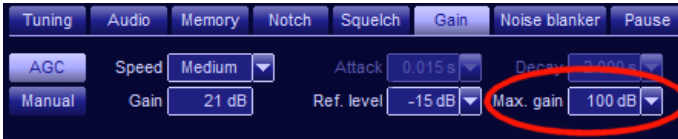

In such cases, if the maximum gain was not limited, the AGC may tend to increase the maximum gain too much, which could result in unpleasant noise bursts between transmissions. By limiting the maximum gain, such noise bursts can be reduced or eliminated.

### Manual Gain

The **Manual gain** mode can be enabled using the **Manual** button, which is mutually exclusive with the **AGC** button. In this mode, the gain can be adjusted manually to the desired value using the **Gain** control drop-down:



*Useful notes about AGC to remember:*

- 1. In AM, AMS, LSB, USB, ISB, DSB and CW modes, the gain setting affects loudness. If the receiver volume appears too low (and yet the volume control is all the way up), make sure that AGC is enabled*
- 2. If the AGC is enabled and the sound is distorted despite the volume being turned down, make sure that the AGC reference level is not set too high. If the volume is too low, try to increase the AGC reference level.*
- 3. If the AGC is disabled and the sound is too weak despite the volume control being all the way up, try to increase the manual gain.*
- 4. In LSB, USB, ISB, DSB and CW modes, manual gain is often preferable to automatic gain. This is because there is no constant "carrier" for the AGC to act upon and maintain at a constant level. If AGC is used, then the **slow** setting is preferable.*

---

## Noise Blanker

---

The **Noise Blanker** can be used for removal of random high-level noise-spikes resulting from atmospheric effects and man-made interference.

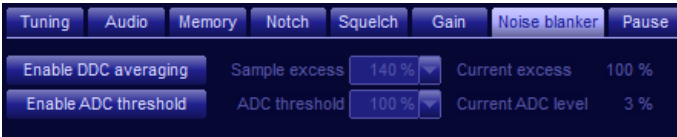

There are two types of noise blankers available, one using the **Short Time DDC Averaging** method and another using the **ADC Input Threshold** method.

The **Short Time DDC averaging** method is based upon comparing the instantaneous signal level at the DDC output (demodulator input) to a short-time exponential average. If the instantaneous level exceeds the short-time average, these samples will be replaced with zeros.

With the **ADC Input threshold** method, the blanking effect occurs much earlier in the signal processing chain: The signal samples arriving from the

ADC are compared to a threshold value, and if greater, then these samples are zeroed.

The **Short Time DDC averaging** method is preferable and will yield improvement in most cases of atmospheric or man-made interference. It is activated by pressing the **Enable DDC averaging** button located under the **Noise Blanker** tab. If the instantaneous signal level at the input of the demodulator exceeds the short-time average level by a user-adjustable percentage amount, these signal samples will be replaced by zero values.

The **Sample Excess** setting should be adjusted as a compromise between the noise blanking effect and the minimum acceptable distortion of the wanted signal. The current value of the signal excess above the short-time average is indicated in the associated display, to assist with the adjustment.

The **ADC Input threshold** method is activated by pressing the **Enable ADC threshold** button. If the input at the ADC exceeds that defined by the **ADC threshold** control, the ADC input will be blanked. The current ADC level is shown in the adjacent display to help with this adjustment. The maximum level (100%) corresponds to the entire input range of the ADC.

## Pause

The **Pause** facility makes it possible to temporarily stop the audio and resume it at any time – a useful function if one needs to get away from the receiver for a while. While the receiver is pausing, the entire incoming down-converted pre-demodulation signal (DDC2 output) is being stored in a temporary buffer, so that other demodulation-related functions, such as the audio filter or notch, can still be applied on the resumed signal.

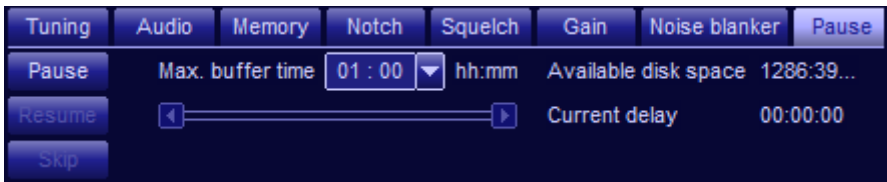

The **Max. buffer time** setting determines the amount of disk space to be allocated for the pause buffer, i.e. the maximum length of the pause. Any signal that is older than the maximum buffer time allows, will be discarded.

Pressing the **Pause** button activates this function. The audio will be muted and the DDC2 spectrum will freeze. The DDC2 signal stream will be saved into the buffer instead of going through the usual demodulation process. In this state, the **Current delay** display will show the increasing amount of saved signal in terms of the time delay, while the **Pause time** display will show the time when the pausing started. If the paused data length exceeds the **Maximum buffer time**, then **Pause time** will show the oldest buffered data that remains available for playback.

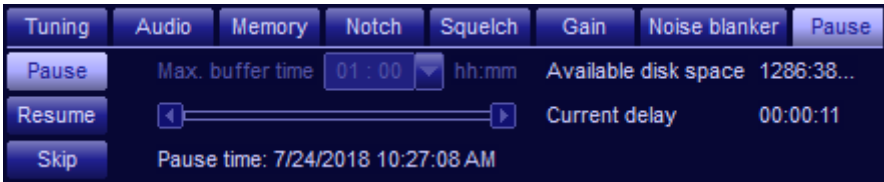

If there is some data in the pause buffer, the **Resume** button becomes available. When activated, it will start playback of the saved signal stream, while the incoming real-time signal will continue to be saved in the buffer.

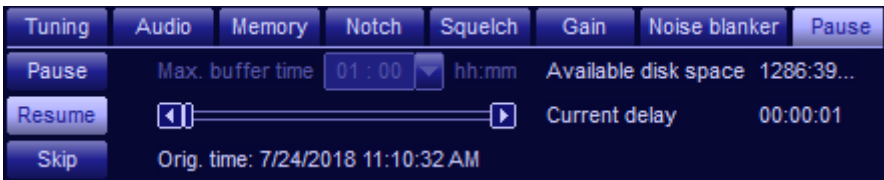

The **Orig. time** display shows the time when the currently played signal was originally received. Data that has already been played back is automatically removed from the buffer to make room for the incoming signal, so that simultaneous buffering and playback can run for an unlimited time, effectively making it possible to listen to the signal with an adjustable delay.

In pause mode, the **Progress bar** is grayed out and only shows the increasing amount of data in the buffer. In resume mode, the **Progress bar** becomes enabled, making it possible for the user to move its slider and so skip a portion of the buffered data.

The **Skip** button discards the entire buffer contents and terminates the pause mode. The **Pause** button then becomes enabled again, making it possible to start another pause session.

During playback of the paused signal, the S-meter, the DDC2 spectrum and all demodulator controls will relate to the currently played back (buffered) signal.

However, the wideband and DDC1 spectrum displays and the main frequency read-out will all relate to the currently received signal.

## Spectrum Scopes

We have already touched on the spectrum scopes in some of the preceding paragraphs, but there is much more to the WiNRADiO *Excalibur Sigma* spectrum scopes than just the ability to “point-and-click” tune or drag the demodulator filter passband.

There are three spectrum scopes which effectively can be considered as subsets of one another.

At the bottom of the application window (if the **Spectrum** button is engaged) is the **Wideband spectrum scope**:



The **Wideband spectrum scope** displays the RF spectrum contents of the current range which the receiver is tuned to in real time. For the **first range** this is 88 MHz wide from 0 Hz to 88 MHz, for the **second range** this is 72 MHz wide from 118 MHz to 190 MHz.

A zoomed-in portion of the wideband spectrum is the **DDC1 spectrum** (top-left) whose width can vary from 20 kHz to 64 MHz in 36 steps (selectable using the **DDC1** control).

The **DDC2 spectrum (Demodulator spectrum)** (top-right) is a subset of the DDC1 spectrum, making it possible to inspect the signal with the highest resolution, and its width can vary from 20 kHz to 64 kHz in 6 steps (selectable using the **DDC2** control).

DDC2 bandwidth always needs to be smaller or equal to that of DDC1, so if an attempt is made to set DDC1 bandwidth to a lower value than that of DDC2, then the DDC2 value will automatically adjust to that lower value.

The gray shaded area in the wideband spectrum represents the DDC bandwidth. The gray shaded areas in both the DDC and demodulator spectrum both represent the currently selected demodulator filter bandwidth.

Even though their functionality is different, all these three spectrum scopes utilize some common controls. Let us examine these common controls first, and leave the specific features of each spectrum scope until last.

The controls of the DDC spectrum scopes are made visible by pressing the “toolbox” button , while in the wideband spectrum scope these are visible at all times.

Pressing the button in either of the DDC spectrum displays will reveal a “toolbox worth” of controls on the right-hand side:

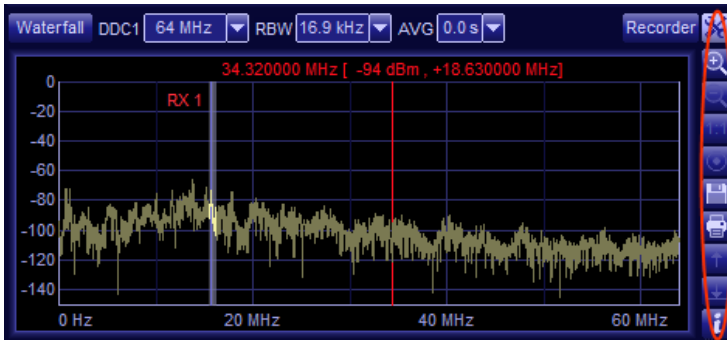

## Zoom Spectrum

---

Each spectrum scope includes **Zoom** buttons .

Use the two zoom buttons to zoom in and out of the spectrum – this is a useful feature for observing frequency peaks in close detail, for example where stations are very close to one another. When the spectrum window is zoomed, you can use the bottom slider to conveniently navigate to a portion of the spectrum that you wish to inspect.

To restore the original scale and reset the zoom, use the **1:1** button .



The **Spectrum centering** button , when used in the DDC1 and DDC2 spectrum scopes, shifts the spectrum so that the demodulated frequency is in the center of the spectrum display (or as close as possible). In the wideband spectrum, this button shifts the spectrum so that the DDC1 passband will be as close to the wideband display center as possible.

## Save and Print Spectrum

---

The **Save**  button is used to save the displayed spectrum as an image file. The image types **BMP**, **JPEG** or **PNG** can be used.

The current visible spectrum can be printed using the **Print**  button.

## Resolution Bandwidth

---

The **RBW** control alters the **Resolution bandwidth** of the spectrum scopes; in other words it specifies the amount of detail that will be visible in the spectrum. A low RBW value provides a greater detail, a higher value results in a smoother trace. The resolution bandwidth control is similar in functionality to that available in high-performance spectrum analyzers.

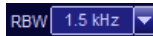

Please note that average CPU load may rise with finer RBW settings. The saved waterfall spectrum files (which are also of the BMP image type) are also significantly larger with finer RBW values.



***Note that the best achievable accuracy of the various point-and-click operations inside the displayed spectra will be limited by the width of the displayed spectrum (remember that the width of any of the spectrum scope windows is adjustable and can be extended over two or more monitors) and the respective RBW limit of the particular spectrum scope, which is dependent on the currently selected DDC bandwidth.***

## Spectrum Averaging

The **AVG** control employs **time averaging** to smooth the spectrum trace. The trace is averaged over the selected time period, variable from 0 to 2 seconds.



This makes the viewing of the spectrum easier on the eyes, reducing the noise floor fluctuations while leaving the useful signal clean and steady.

The  and  buttons of the DDC1 and DDC2 spectrums are used to reveal the minimum and maximum signal values (respectively) received during the averaging period. These buttons are enabled only if the averaging period is non-zero.

## Waterfall Spectrum

The DDC1 and wideband spectrum scopes are both equipped with a **Waterfall** function. Clicking on the **Waterfall** button transforms the standard spectrum scope into a waterfall-type display, where the vertical-axis represents time and signal strength is represented by a palette of colors:

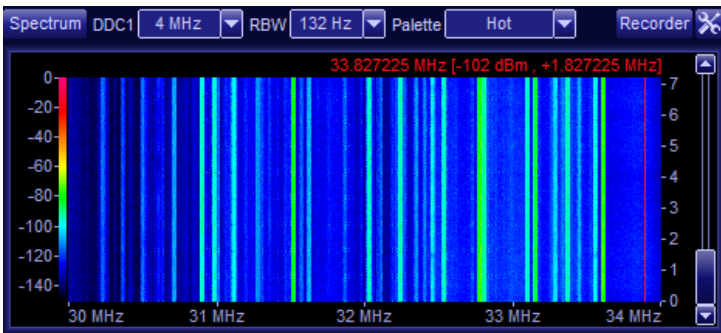

The palette can be selected using the **Palette** control (located above the display), from a set of several factory defined color palettes:



To invoke the **palette menu** simply click on the dBm scale on the left. This will reveal three selectable parameters, using which the waterfall can be made more informative.



The palette **Top** and **Bottom** parameters can be understood as optical limits, or baselines. They define the highest and lowest signal level values which will correspond to the lightest and darkest palette colors. All signal levels above and below these limit values will be drawn in the lightest or darkest color. This makes it possible to shrink or stretch the palette to match the desired signal strength range.

The palette **Gravity** can be used to highlight a given signal level of special interest with enhanced colors. If for example the palette gravity has been selected at -80 dBm then the monitored signal will be shown with additional colors around that signal level, thereby improving the contrast of this section within the overall waterfall display.

The check box inside the **Gravity** control activates the gravity settings, or when unchecked, restores the palette default state.

It is also possible for users to create their own color palettes. For details please see **Appendix F: Waterfall Spectrum Palettes**.

The waterfall displays has its own set of additional controls: The **Reset** button clears the current waterfall display and starts a new one. The **Direction control** button alters the direction of the waterfall, while the **Pause** button temporarily pauses (and also restarts) the waterfall spectrum.

The **Passband reveal**  button can be interesting. When activated in the wideband spectrum scope, it will show the DDC1 passband inside the waterfall. When activated in the DDC1 spectrum scope, it will show the DDC2 passband.

## Spectrum Markers

This facility exists in the wideband, DDC1 and audio spectrum scopes, making it possible to mark frequencies of interest, set reference points and calculate differential frequencies.

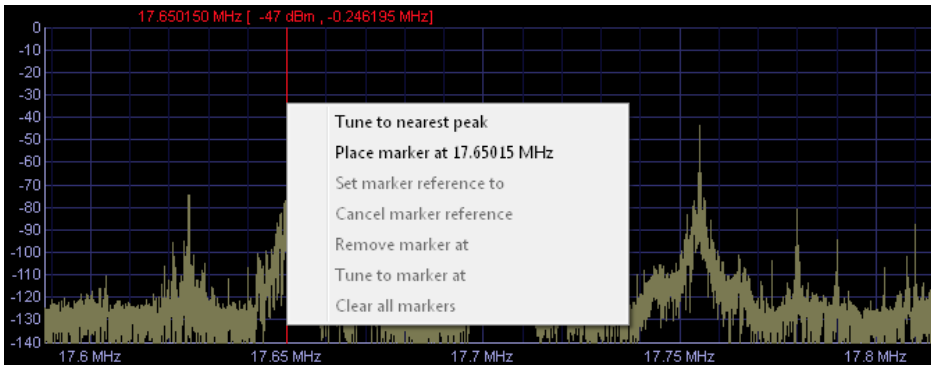

The current cursor frequency is shown above the cursor (vertical red line). This is followed by two associated values in square brackets representing the instantaneous signal strength value at the cursor position, and the frequency difference between the receiver tuned frequency and the current cursor position. The “frequency delta” display is very convenient for measuring signal bandwidths, distances between transmitted channels or signal sidebands, etc.

Right-clicking on the spectrum reveals a menu with the following functions:

**Tune to nearest peak** – this will tune the receiver to a peak that is nearest to the cursor. The capture area is 15 pixels either side of the cursor (the actual frequency range will vary depending on the current zoom status).

**Place marker** – this will place a marker to the current cursor position.

If a marker exists next to the cursor, additional functions become available:

**Set marker reference** – this will set this particular marker as a reference from which frequency differences will be calculated and displayed for the other

markers. The reference marker will be marked with an **R** next to its displayed frequency. The differential value with respect to the reference marker will be displayed next to the other markers:

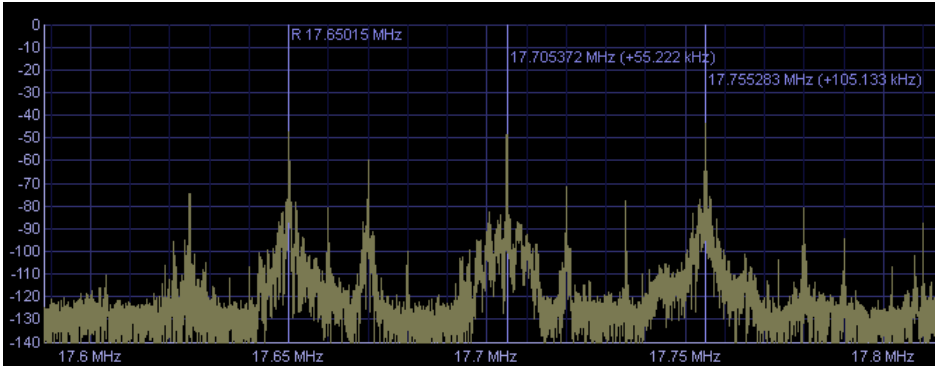

**Cancel marker reference** – this will remove the marker’s status as a reference and the differential frequencies will not be displayed for the other markers.

**Remove marker at xx.xxx MHz** – by selecting this function, this marker will be deleted.

**Tune to marker at xx.xxx MHz** – this will tune the receiver to the marker frequency.

**Clear all markers** – this function removes all markers from the spectrum.

## Information Buttons

The information button  in the DDC1 and DDC2 spectrum scope “toolbox” conveniently duplicates the functions **Show measurements** and **Show data rates** under **Options**. When activated in the DDC1 spectrum, the internal receiver and PC data rates are shown, which is useful particularly for installation and research purposes.

In the DDC2 spectrum, this function reveals particulars about the received signal, such as frequency error, modulation depth, SINAD, THD, etc.

## Baseline Level

The wideband spectrum scope provides adjustment for the baseline level using the **Min. Level** control. This adjusts the minimum displayed signal strength level, and serves to maximize the useful display space in situations where the noise floor would occupy too large proportion of the displayed spectrum (for example in noisy environments or with large antennas):

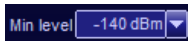

## Peak Hold

This feature is only available in the wideband spectrum scope, making it possible to observe a spectrum for a long time and indicate any signal peaks that may have occurred in the past, but have since disappeared. In other words, when this value is set, the spectrum scope will record and display the signal maximum values and hold it for a user-defined period of time, specified in hours, minutes and seconds:

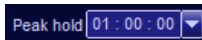

## Audio Spectrum

Pressing the **Audio** button above the DDC2 spectrum will reveal the **Audio spectrum scope**, showing the real-time audio spectrum of the demodulated signal.

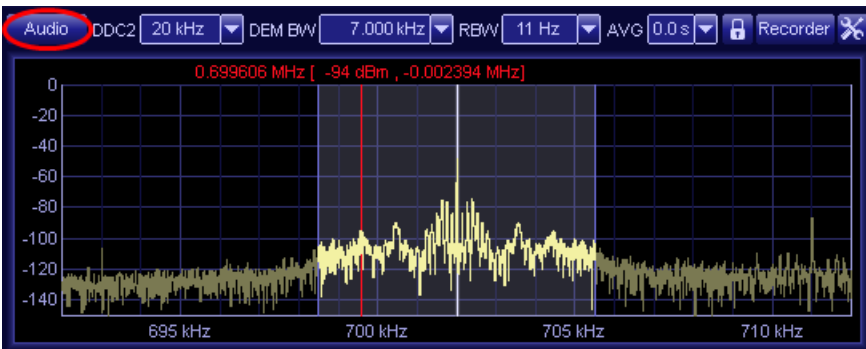

Markers (when the spectrum is right-clicked) are also available in the **Audio Spectrum** display mode.

When the **Audio filter** is enabled (using the **Filter** button under the **Audio tab**), its passband will be shown as a gray area superimposed over the audio spectrum. The low and high cut-off frequencies of the filter can be graphically adjusted by dragging the left and right edges of the displayed passband. The input audio signal to the filter is shown in a darker color while the filtered output is shown in a lighter color.

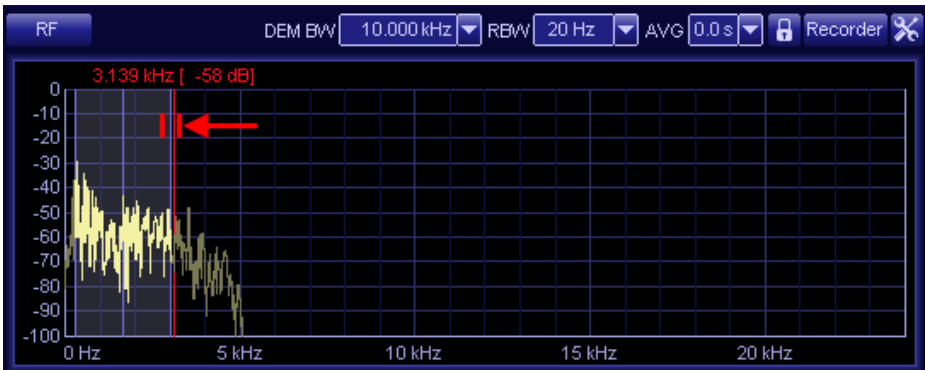

Finally, clicking the **RF** button while the audio spectrum is displayed will exit the audio spectrum mode and return the display to the RF spectrum mode, showing the DDC2 output.

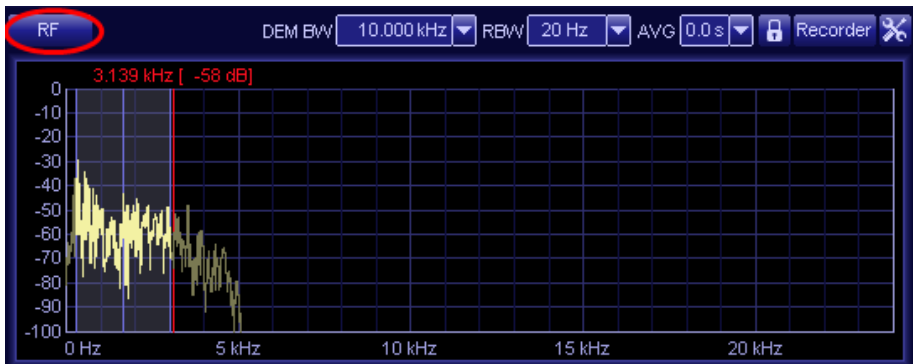

## Activity Search

If the **Activity** button is engaged, this will put the receiver into the **Activity search** mode:



In this mode, the wide-band display does not show a contiguous spectrum, but rather “hits” on discrete frequency channels. In other words, the receiver will operate like a conventional scanner.

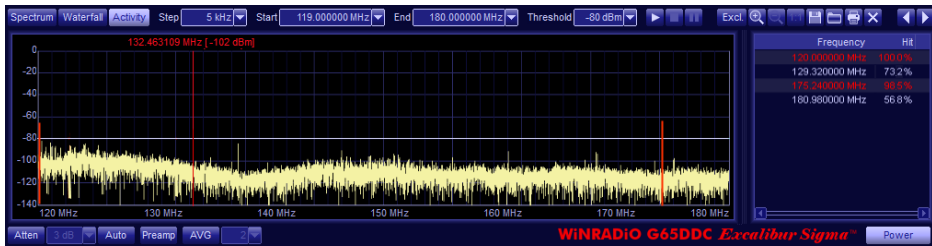

To prepare for the activity search, you need to first set the **Start** and **End** frequencies of the range, and the **Step** size:



The step size and the starting frequency must be determined so that they fall on the actual channel frequencies inside the searched band. Start and End frequencies must be within the currently selected range.

The next value to set up is the **Threshold**. The threshold can be set using the drop-down or by keying in a value preceded by a minus, or the 'threshold line' can be dragged with the mouse to set a value.



When started, the activity search will look for signals that exceed this threshold value. In the activity graph, these signals will appear as highlighted peaks, crossing the horizontal line that represents the predefined threshold.



Starting, stopping and pausing is controlled by three self-explanatory buttons (start / stop / pause):



The **AVG** option in the activity mode (at the bottom of the window) averages the specified number of spectra before they are used. This may reduce short time interference or noise in the final spectrum but it reduces the speed of the activity search as well. The average value can be set between 2 and 16 (or toggled off).



In addition to the visual activity search on the right-hand side of the spectrum, the search result will also be presented in a textual form, where the currently active frequencies will be highlighted:

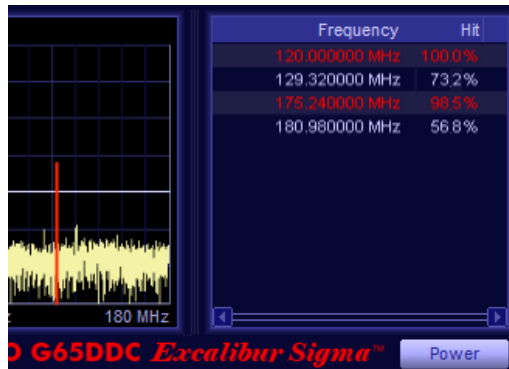

The **Hit** column will show the percentage of the time (since the start of the search) that the discovered frequencies were on air.

Right-clicking on a listed frequency will open the context menu with several options:

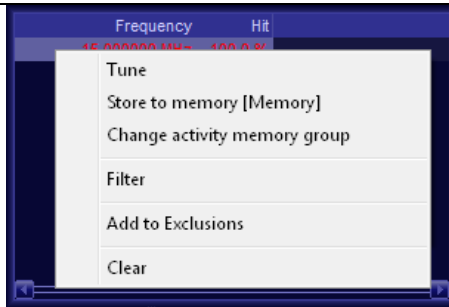

**Tune** - tune the receiver to the selected frequency.

**Store to memory** - store the frequency to the default activity memory group.

**Change activity memory group** – specify the default activity memory group (any listed frequencies which have been stored in the default activity memory group will be displayed with reduced brightness).

**Filter** - set an activity threshold for displaying found frequencies (this does not affect the activity search spectrum display).

**Add to Exclusions** – add the selected frequency to the Exclusions list.

**Clear** - clear the most recently found active frequencies in the activity spectrum display and reset the activity frequency list.

The activity search results can be saved in a special proprietary format (extension “.g65ddcact”) and then loaded back to be viewed by the *Excalibur Sigma* application. The frequency table with hit counts can also be saved to a CSV or XLS file. This is accomplished using the file **Save** and **Load** buttons, respectively:



Sometimes it is desirable to exclude certain frequencies from the activity search, even when the signal level of these frequencies is above the specified threshold. It is also possible to exclude multiple frequency ranges. This is done using the **Exclusions** button:



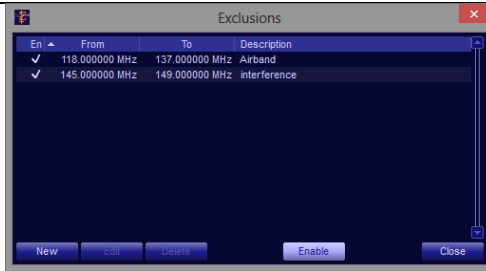

To activate frequency exclusions in the activity search, press the **Enable** button. Excluded bands are highlighted in the activity spectrum.

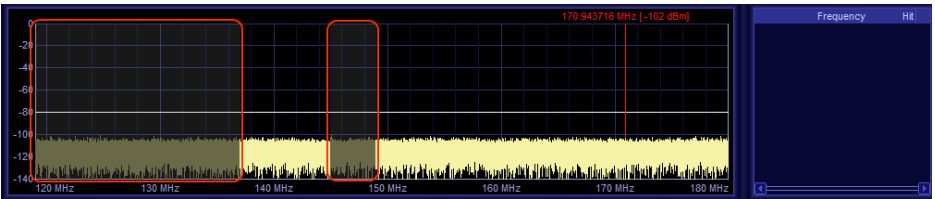

## Recording Functions

At the top of the DDC1 and DDC2 spectrum scopes there are **Recorder** buttons that serve to reveal their respective recording facilities.

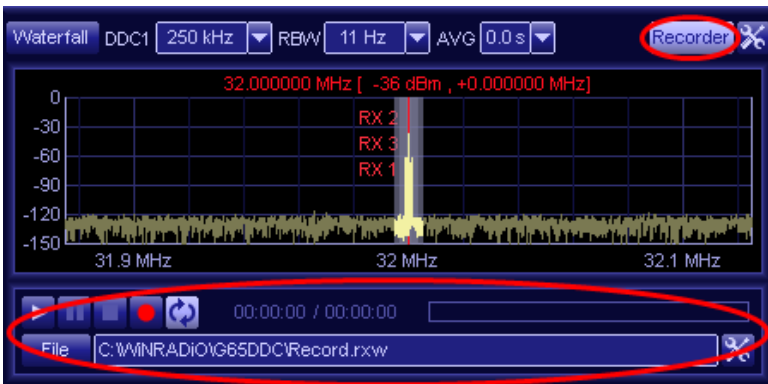



Pressing the **Recorder** button (DDC1 or DDC2) will reduce the height of the spectrum scope at the bottom and utilize the extra space for the recorder controls.

The recording controls of the DDC1 and DDC2 spectrum scopes *appear* identical. However, their functions differ: The recording controls of the DDC1 panel relate to the **DDC recorder**, making it possible to record the entire DDC1 bandwidth (up to 64 MHz wide), while the **Audio recorder** in the DDC2 panel serves to record the demodulated audio.

**AUDIO:** As each of the three virtual receivers has its own demodulator, each of the three receivers can record demodulated audio independently and simultaneously, and create separate audio files of three different stations.

**DDC:** The DDC recorder can be very useful in situations where the spectrum is to be searched for interesting stations, or even when just a single signal is of such significance that it needs to be repeatedly analysed with various receiver settings. A weak or interference-obscured signal can thus be “re-received” many times with different demodulator filter bandwidths, notch filter or audio filter settings, etc., to arrive at the best possible demodulated audio.

Recording starts when the **Recording** button  is engaged, and stops when the **Stop** button  is pressed. A **Pause** button  is also available, to temporarily pause both the recording and playback.

Playback starts when the **Play** button  is engaged. The **Loop** button  can be toggled to keep playing a recorded file in an infinite loop.

The **DDC recorder** can record files with the extension “.**ddc**” format or “.**rxw**” proprietary format. The **Audio recorder** will record in the standard Windows wave format (extension “.**wav**”) or in the “.**wwv**” proprietary format. The actual format can be chosen in the **Browse** file dialog or just by typing the file extension in the file name edit box. For more details regarding the recording formats, please see **Appendix G - Recording File Formats**.

The recorded file name can be set up using the usual Windows file edit box. Pressing the **File** button reveals the Windows standard directory browsing facility that can be used instead of having to type the path and file names.

If the “toolbox” button  next to the file name is activated, this will reveal a set of useful controls specific to the recorders:

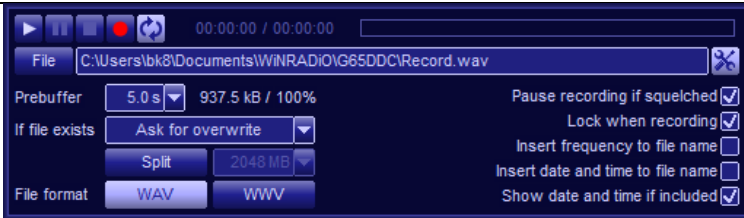

The **Prebuffer** control sets the time for pre-buffering, which means that the recorder will include the specified number of seconds of recording before you press the recording start button. This is in order 'not to miss' the start of an interesting transmission. The pre-buffering interval can be set from zero to 10 seconds.

If a recording file name is specified which already exists in the destination path, three buttons located next to the **if file exists** condition are used to instruct the recorder how to deal with this situation. The user then has the following options to select from:

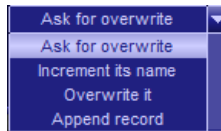

**Ask for overwrite** – a dialog box will ask you if you wish to overwrite the file.

**Increment its name** - each time the record button is pressed, a “counter” will be inserted in the file name and prefixed with the “\$” symbol. If there is no initial number then “001” is automatically used first, and then incremented each time a new file is created. For example, the file name may look like this: **rec-\$001.wav**

**Overwrite** - the file will be overwritten with the new data.

**Append record** – the new data will be appended to the end of the existing file. (Note that only the RXW format allows appending wave data of different formats, such as sampling rate. Other supported file formats do not allow this.)

The **Split** button, when engaged, prevents the size of the recorded files from exceeding 2 GB (larger files may be inconvenient to handle). If the file size reaches 2 GB, the file will be automatically closed and named (for example)

**rec-12.345678MHz-^001.ddc**, where the “^” symbol denotes a split section. Recording will then automatically continue into a file called **rec-12.345678MHz-^002.ddc**. When the file is played back, the recorder will automatically assemble the related split sections and play them back seamlessly.

The split option should be used especially if the hard drive is using FAT32 rather than NTFS partitioning, as FAT32 has a maximum file size of 4 GB.

The **File format** selection makes it possible to choose between **RXW** or **DDC** formats for the DDC1 recorder and **WAV** or **WWV** formats for the Audio recorder (DDC2 demodulator).

***The RXW and WWV formats are WinRADIO proprietary. The advantage of these formats is in their ability to store date/time stamps as well as other parameters with the recordings. For more details see Appendix G – Recording File Formats.***

When recording, a receiver can be “locked” to prevent being “dumped” if a user tunes other receiver outside of the current DDC1 bandwidth. This is done by activating the **Lock when recording** checkbox.

Audio recordings can be controlled by the squelch condition. Should the recording pause if the receiver is squelched, this can be set up by checking the **Pause recording if squelched** checkbox. (This function is not applicable to DDC recordings.)

The **Insert frequency to file name** and **Insert date and time to file name** facilities allow to insert the current local time and the currently tuned frequency into the file name (with DDC files this will be the current center frequency of the DDC bandwidth). As a result, the file name may for example look like this: **rec-12.345678MHz\_11-07-04\_15'34'57.ddc** (for DDC files) or **rec-12.345678MHz\_11-07-04\_15'34'57.wav** (for audio files. This is very useful especially with DDC files: If DDC files are played back with a frequency inserted in the file name in this way, it will be assumed that this frequency is the DDC center frequency. It will then be possible to tune to frequencies within the DDC passband as if the recorded signal was a real-time transmission.

## Attenuator

---

The **Attenuator** is used to reduce the signal coming to the ADC and therefore the receiver's sensitivity. This is useful in situations where strong signals cause overload. Overload is indicated by the words "**ADC CLP**" appearing in the S-meter:



The attenuator is variable from zero to 21 dB, in 3 dB steps. It can be engaged by pressing the **Atten** button, which will also enable manual selection of the attenuation value.

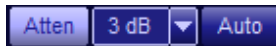

Pressing the **Auto** button will adjust the attenuator automatically by increasing the attenuation to the point when overload stops. (However, it does not automatically decrease the attenuation if the original strong signal disappears; this needs to be done manually.)

***If sensitivity appears poor, please first ensure that the attenuator is disabled.***

## Preamplifier

---

The **Preamp** button engages a low noise preamplifier, which adds approx 10 dB of amplification to the RF front-end, and so increases sensitivity.



***Please note that the actions of both the attenuator and preamplifier are compensated for by the S-meter. This means that the S-meter always displays the actual signal strength at the antenna input, within the available measurement range (readings are normalised).***

## RF Filter

---

The **RF filter** is a bank of mostly band-pass preselector filters whose cut-off frequencies are user-adjustable.



When engaged, and the lower and upper cut-off frequencies are set, the adjacent frequencies will be attenuated, to reduce susceptibility to interference from the adjacent bands. The cut-off frequencies can be adjusted manually (18 filter combinations are possible, out of which 10 are band-pass, 4 low-pass and 4 high-pass).

If you engage the **Auto** button, the software will automatically select an optimum filter combination for the currently tuned frequency. Such automatic switch-over will usually occur somewhat earlier than the exact cut-off frequency, in order for the signal to remain within the flat portion of the filter passband.

When the RF filter is engaged, its passband is indicated by a grayed out area visible in the wideband spectrum.

## S-meter

---

The WiNRADiO *Excalibur Sigma* receiver is equipped with a very sensitive and selective **Signal Strength Meter** (*S-meter*) which makes it possible to measure peak or RMS signal level in dBm,  $\mu\text{V}$  or S-units, within the demodulator filter passband. The measurement units are selected by appropriately marked buttons at the bottom of the display.



The S-meter also shows the currently selected value of the squelch (the red section at the bottom-left side of the scale) when the squelch is enabled. When the signal strength falls under the squelch level (i.e. the needle falls in the red region and also turns red), the receiver audio will be muted and the word "**Squelched**" will appear inside the S-meter.



The squelch value is always indicated in dBm (even if the signal strength is displayed in S-units or microvolts).

The **Peak** and **RMS** buttons select between displays of peak and RMS values. The **AVG** button applies a floating average with a one second time interval to smooth the S-meter movement.

The S-meter is very selective, and acts only upon signals within the selected demodulator bandwidth (the gray-shaded area in the demodulator spectrum display).

***Please note that the actions of both the attenuator and preamplifier are compensated for by the S-meter. This means that the S-meter always displays the true value of the signal strength at the antenna input, within the available measurement range.***

## Top Menu Bar

---

The top menu bar contains numerous ancillary functions of the *Excalibur Sigma*:

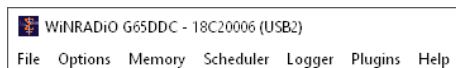

## File

---

The **File** menu includes functions associated with file operations.

---

*Did you know?*

*The word "file" was used publicly in the context of computer storage as early as February, 1950. In an RCA (Radio Corporation of America) advertisement in Popular Science describing a new "memory" vacuum tube it had developed, RCA stated: "...the results of countless computations can be kept 'on file' and taken out again. Such a 'file' now exists in a 'memory' tube developed at RCA Laboratories. Electronically it retains*

figures fed into calculating machines, holds them in storage while it memorizes new ones - speeds intelligent solutions through mazes of mathematics."

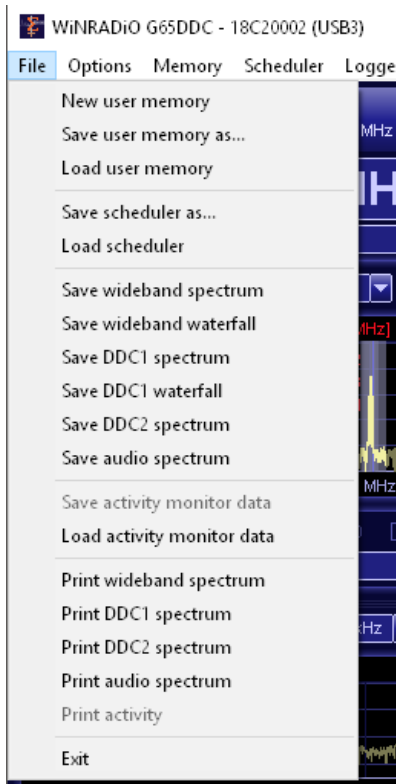

User memory files are of a special format with the extension “.**r7m**”. Scheduler files have the extension “.**r7s**”. Activity monitor data (refer to the **Activity search** chapter) has the extension “.**g65ddcact**”.

Spectra are all saved as images using the **BMP, JPEG or PNG** format. They can also be printed.

## Memory Export and Import

The **Save user memory as** and **Load user memory** functions can also save or load the user memory in the **CSV** format (comma separated values), making it possible to export frequencies in this commonly used format, as well as import frequencies from third party sources.

Each line of CSV file contains the following information, in this particular order:

"Folder", "Callsign", "Description", "Frequency", "Mode", "Bandwidth", "Level squelch", "Noise squelch", "Voice squelch", "CTCSS squelch", "DCS squelch", "Audio filter low", "Audio filter high", "Audio filter de-emphasis"

**Folder** can also include subfolders (groups), which are separated by slash signs "/", for example as follows:

"Memory/SW stations/Australia"

**Frequency**, **Bandwidth** and the audio filter parameters are specified including the frequency unit, for example:

"21.525MHz"

To save or load the CSV file, simply specify this as a file type in the respective window, for example:

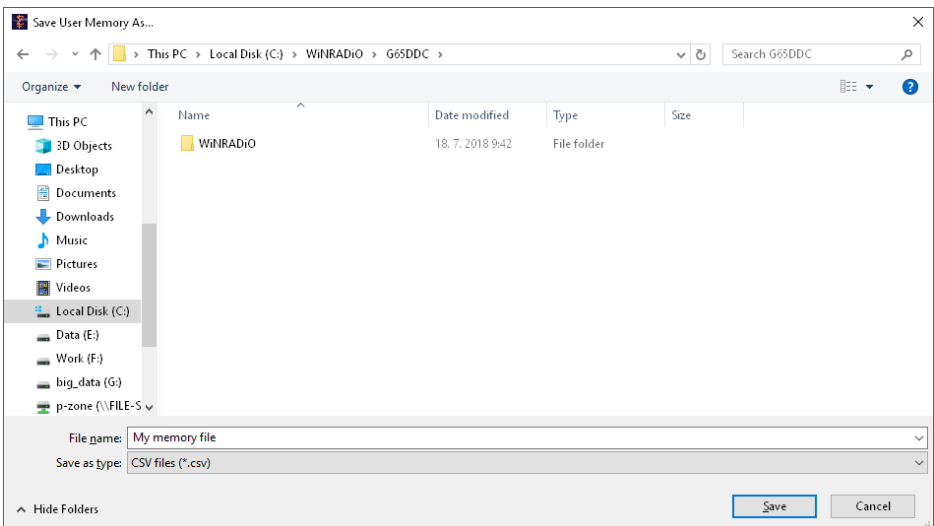

User memory can be cleared using the **New user memory** function. This deletes all the memory groups and their content.

## Options

---

The **Options** menu contains a number of user settings making it possible to customize the receiver's look and behavior, adjust its numerous operational parameters, activate various test and measurement displays, calibrate the receiver, as well as restore factory defaults for user-definable parameters.

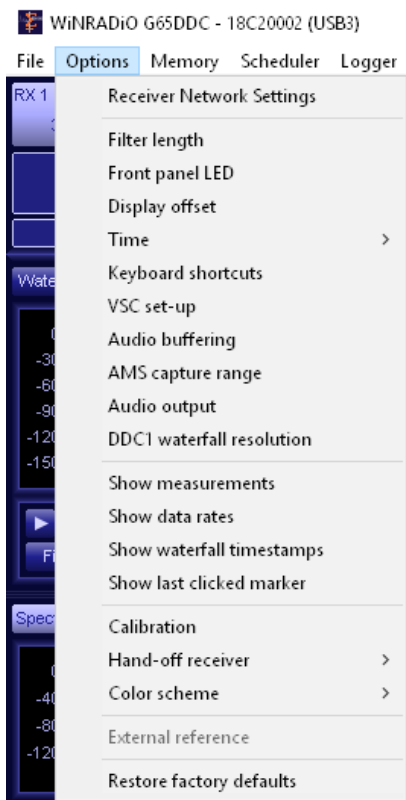

## Receiver Network Settings

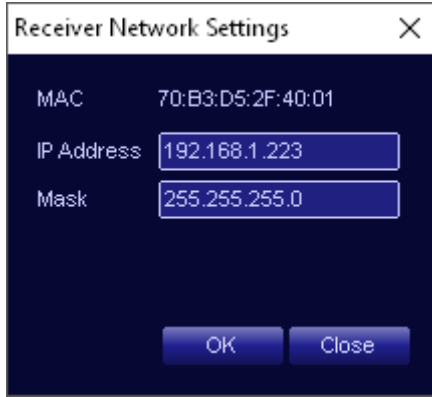

The **Receiver Network Settings** dialog displays the receiver's MAC address and provides controls to set its IP address and network mask. This dialog is only available if the receiver is connected via its USB port.

The receiver must be turned off using the power button on the bottom right of the application panel to be able to change the network settings. Otherwise the dialog is displayed in read-only mode with a short explanation.

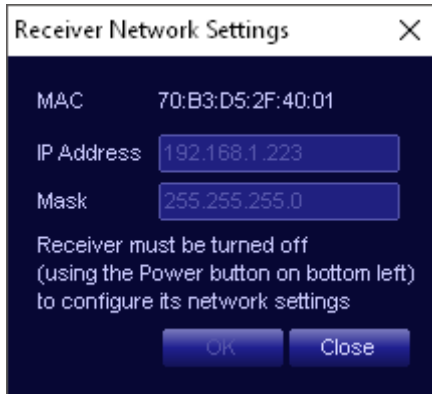

## Filter Length

This facility makes it possible to adjust the digital filter "length" (which directly translates into selectivity) for three types of filter used in the *Excalibur Sigma*:

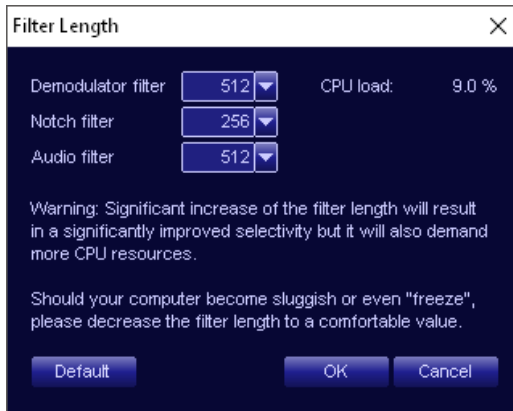

The **Demodulator filter length** has a direct influence upon the overall 'receiver selectivity'. Greater length produces better selectivity.

The maximum achievable selectivity is limited by the processing power of your computer: The greater the CPU power, the "longer" (and therefore sharper) the filter can be made.

This function also makes it possible to observe the **CPU load**, which will depend upon this setting. It may not be advisable to select a value resulting in more than say 30% CPU load, as the computer may then become sluggish.

The **Notch** and **Audio** filter lengths can also be adjusted using this facility, resulting in sharper (or shallower) notch and audio filtering, tailored to specific operator requirements.

Should the computer become sluggish or even "freeze" as a result of this adjustment, please reduce the respective filter length to a lower value.

Note also that the CPU load can be lowered (while keeping selectivity high) by reducing the DDC1 bandwidth. For example standard HF and narrow-band FM signals can be demodulated with 20 kHz DDC1 bandwidth without decrease in demodulation quality. Wider DDC bandwidths affect display and recording, while increasing the CPU load considerably.

## Front Panel LED

This function is only applicable to the WR-G65DDCe (USB/LAN interfaced) model. Normally, its front panel blue LED flashes with various patterns which

are useful for installing the receiver and debugging possible interface problems (see **Appendix C**).

However, as the flashing LED may be distracting, the behavior of this LED in its normal "receiver ready" state can be controlled by the user, making it possible to keep the LED continuously on or off, to suit the user's preference:

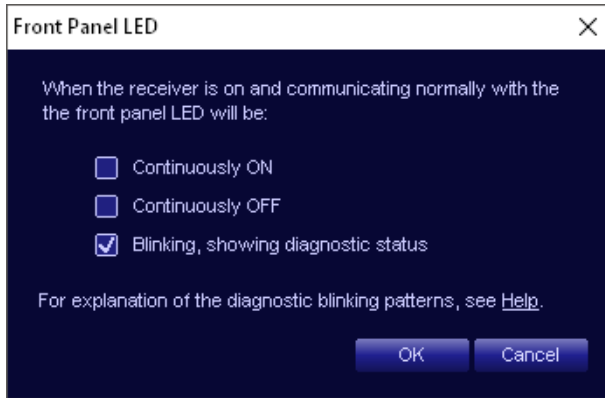

## Display Offset

This feature makes it possible to introduce a fixed offset to the displayed frequency. It is particularly useful when an external frequency down-converter is being used with the receiver:

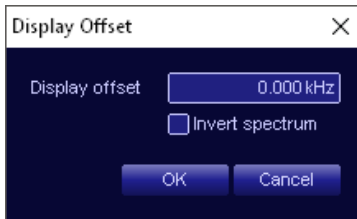

Enter the required offset value in the **Display** offset edit box, click OK, this value will be added to the displayed frequency.

Optionally, you can invert the displayed spectrum using the **Invert spectrum** checkbox, which may be useful for example if a spectrum-inverting down-converter is used at the RF input.

## Time

The time information displayed in the top-right menu bar can be either the local time (as provided by the PC) or UTC (Coordinated Universal Time). This can be selected by the user via this option.

It is also possible to select 12 or 24 hour time display format, or the default format determined by the Windows "locale" settings.

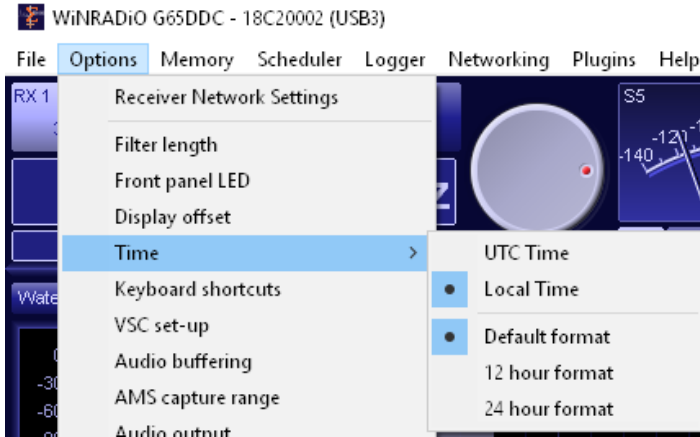

Note the format in which the date is displayed depends on the "locale" settings of your computer. You can change this in your Windows control panel under **Regional and Language Options** (the exact wording will depend upon your Windows version.)

---

*We are open 24/7!*

*With despatch centers located in the UK, EU and Australia, no matter what the time of the day is, the WiNRADiO direct online one-stop-shop for receivers, software, antennas and accessories never closes. Check this out at [www.winradio.com/shop](http://www.winradio.com/shop)*



## Keyboard Shortcuts

Keyboard shortcuts make it possible to use keyboard keys instead of the mouse to select the most common functions. The keyboard shortcuts are also very useful for blind and visually impaired radio operators as a preferred alternative to a graphical user interface.



All shortcuts can be user defined. If there is a conflict in the definition table (the same keystrokes are specified for more than one function), this will be highlighted in red. The **Default** button restores the factory defaults and the **Enable** button can be used to enable or disable all shortcuts. The **Load** and **Save** buttons allow the user to load and save shortcut settings from/to a file.

## VSC Set-up

The *Virtual Sound Card (VSC)* is a software option designed to transfer digitized audio signal streams from WinRadio receivers directly to other applications. For a more detailed description please refer to the chapter *Virtual Sound Card* (under **Function Tabs**, the **Audio tab**).

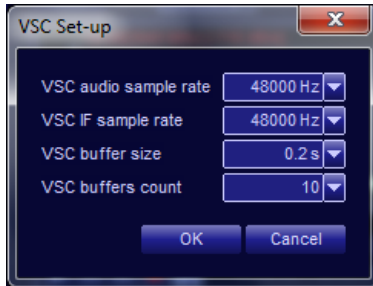

This function makes it possible to set sampling rates for both the VSC audio and IF outputs independently, to match the requirements of the target application.

The VSC audio data is always 16 bit mono, the IF data is 16 bit stereo (each of the "I and Q" components uses its own channel). The **buffer size** can be adjusted to control latency, while the **buffers count** should be set to an optimum value to avoid drop outs in data due to unequal sampling rates between the applications.

### Audio Buffering

The audio signal resulting from the receiver filtering and demodulation process is sent to a Windows multimedia output device, i.e. in most cases the PC sound card. Prior to this, the audio data is buffered in order to avoid potential drop-outs due to other background processes taking place by the PC, which may cause an irregular data rate.

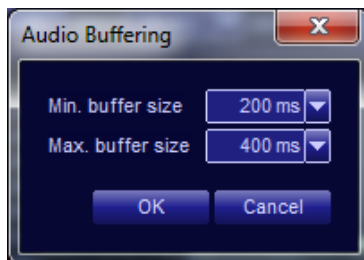

While the buffering removes drop-outs, it introduces a certain delay (latency) to the output audio.

The **Min. buffer size** and **Max. buffer size** parameters can be adjusted to minimize the latency for a particular computer system.

The **Min. buffer size** parameter can be adjusted to the minimum acceptable value before significant distortion or drop-outs develop. The **Max. buffer size** parameter determines the maximum allowable latency.

## AMS Capture Range

In the AMS mode, there is a certain "capture range", a frequency range within which the receiver will capture the signal and lock to synchronization. If you are tuning to a new signal, this **Tune capture range** is initially quite wide, within  $\pm 1.5$  kHz (factory default value) from the actual signal frequency, to enable easy tuning by pointing and clicking near the peak in the DDC spectrum, or by dragging the filter passband area in the demodulator spectrum.

You can adjust the **Tune capture range** to a different width for tuning convenience.

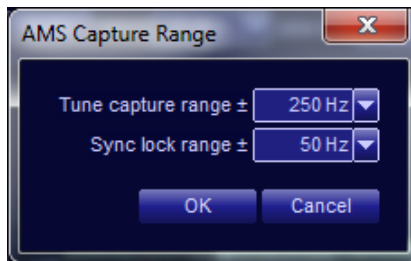

Once locked to a signal, the capture range automatically reduces to  $\pm 50$  Hz (factory default value) from the signal frequency. The reason for such a reduction is to avoid "kidnapping" of the synchronization frequency by a nearby strong signal if the carrier signal fades, as may happen especially with long-distance reception due to ionospheric effects.

You can adjust the **Sync. lock range** as a compromise value – if it is too small, then you may lose sync if the transmitter frequency drifts (modern day transmitters have much better frequency stability than those of yesteryear). On

the other hand, if the **Sync. lock range** is too wide, then there is an increased possibility of losing sync due to a nearby strong signal.

When the signal is locked in synchronization, a "lock" symbol located in the top-left corner of the frequency display confirms successful lock:



## Audio Output

The audio output function makes it possible to allocate the audio output of the three virtual receivers to different **Wave out** audio devices available on your computer. This may be handy in special applications where you might wish to use one receiver for audio output only, another one for data decoding (via a virtual sound card), etc.

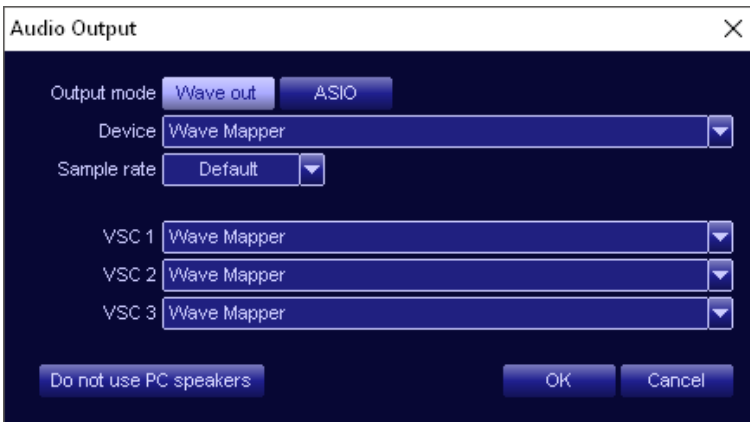

It is also possible to channel the audio output to an **ASIO (Audio Stream Input/Output)** device, if it is available in your system. This feature makes it possible for an ASIO device to bypass the Windows audio processing layers and access the receiver's audio output directly, with the lowest possible latency and eliminating any artifacts introduced by the computer's operating system. The **Sample rate** option specifies the sampling rate of audio data sent to an audio output device (sound card). The Default sampling rate is equal to the audio sampling rate of the receiver which is 48 kHz. Some sound cards do not allow use of high sampling rates, therefore it is necessary to use this option to specify a lower audio output device sampling rate. The **Do not use**

**PC speakers** button can be used to stop audio from being sent to any audio device installed in the system.

## DDC1 Waterfall Resolution

The **DDC1 waterfall resolution** specifies the time interval between displayed lines of the DDC1 waterfall. The default value is 50 ms, with a finer value of 10 ms available to help discern and analyze short-duration signals.

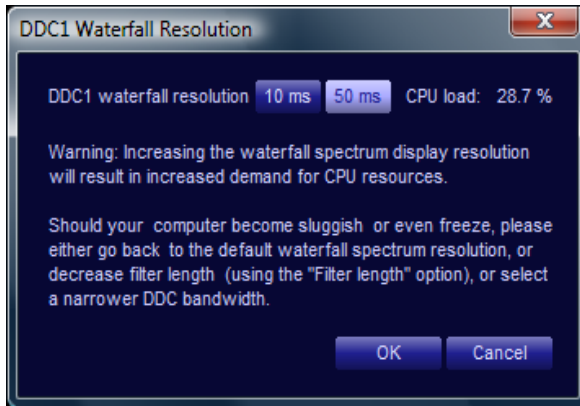

Should, as a result of selecting 10 ms waterfall resolution, your computer becomes sluggish, you might need to either revert to the default 50 ms value or reduce the CPU load by narrowing the DDC1 bandwidth or reducing the **Filter length** setting under **Options**.

## Show Measurements

The **Test and Measurement** functions of the *Excalibur Sigma* receiver make it possible to indicate the **ADC input level** (in percentage of the entire ADC range), **Frequency error** of the received signal (assuming the receiver is tuned to the correct frequency), **AM modulation depth** (for AM-modulated signals), **Frequency deviation** (for FM-modulated signals), **SINAD** (signal-plus-noise-plus-distortion to noise-plus-distortion ratio) and **THD** (total harmonic distortion):

ADC level	3 %
Freq. error	130 Hz
AM depth	50 %
SINAD	41 dB
THD	2 %

For SINAD and THD measurements, the test frequency is assumed to be 1 kHz.

**Note that this function is also duplicated by the information button  in the demodulator spectrum DDC2 scope “toolbox”.**

## Show Data Rates

The Show Data Rates display shows the various internal data rates of the entire G65DDC receiver system. This may be useful especially for debugging of installation problems:

USB rate	2.8 MB/s
Data lost rate	0 B/s
DDC1 rate	25.044 kHz
DDC2 rate	24.979 kHz
Audio rate	47.831 kHz
Soundcard rate	48.000 kHz
Audio latency	101 ms
CPU load	12 %

Of particular interest to many users will be the **CPU load** (excessive CPU load may cause sluggish behavior or freezing of the computer), and **Audio latency**. Apart from **DDC1 bandwidth**, CPU load may be minimized by reducing the **Demodulator filter length** (thus sacrificing selectivity) and audio latency may be minimized by reducing the **Audio buffering** (while inviting the possibility of audio drop-outs or distortion). Both these controls are available under **Options**.

**Note that this function is also duplicated by the information button  in the DDC1 spectrum scope “toolbox”.**

*Measuring your Excalibur Sigma’s sensitivity using your Excalibur Sigma:*

*Using the SINAD measurement facility, you can measure the sensitivity of the WiNRADiO Excalibur Sigma receiver very easily. All you need is a calibrated signal generator. For example, to measure AM sensitivity, connect the signal generator to the antenna input and turn on AM modulation (the modulation depth is usually set to 30%, although some manufacturers prefer to quote sensitivity figures at higher modulation depths, for example 60 or 80%). Set*

the Test frequency equal to the modulating frequency (typically 1 kHz). Adjust the IF bandwidth for the maximum SINAD. Then gradually keep reducing the generator output level to the point when SINAD drops to 10 dB. The receiver sensitivity is then equal to the generator level at this point.

Measuring AM sensitivity using SINAD rather than the conventionally used  $S+N/N$  is quite appropriate as SINAD also includes distortion, which is as much an impediment to intelligible reception as noise, and therefore provides a more practical result. Even though in theory using SINAD should result in the sensitivity figures being somewhat worse than if  $S+N/N$  is used, in practice, with a good receiver such as the Excalibur Sigma, there is no noticeable difference.

**Note:** When measuring sensitivity using SINAD, it is very important that the Audio Filter is enabled and the cut-off frequencies (and for FM measurements, also the de-emphasis) are set according to the specified test conditions. Proper audio filtering makes a substantial difference to the SINAD results.

### Show Waterfall Timestamps

Invoking this option makes the DDC1 waterfall spectrum display show time stamps, making it possible to relate spectrum events to absolute time:

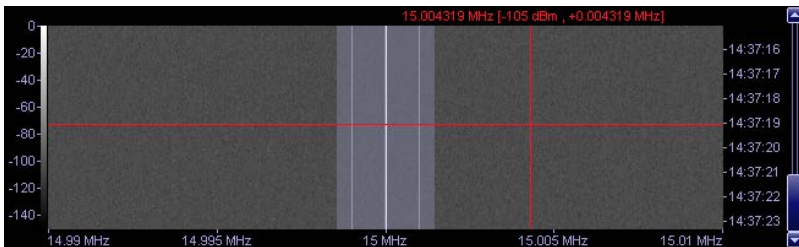

### Show Last Clicked Marker

If this option is selected, all the spectrum displays (including sweeper and activity displays) will show a marker at the position of the "last clicked on frequency" to which the receiver was tuned. Passband-dragging zones are excluded as possible last-click marker positions.

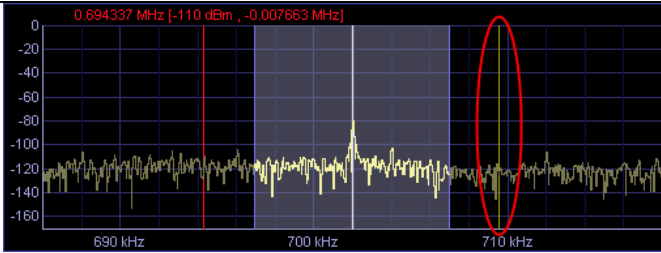

## Calibration

Since the *Excalibur Sigma* uses an accurate and stable temperature compensated crystal oscillator with 0.1 ppm (parts per million) tuning stability, there is no real need for calibration for most practical purposes. However, for the most demanding user, a calibration facility still remains available:

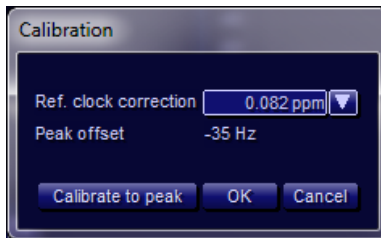

Such calibration can be done either manually, by entering a correction factor for the reference oscillator directly, or using automatic calibration against a known reference signal.

To calibrate to a peak, simply tune the receiver to a known reference frequency (presuming a reasonably strong and steady signal). The frequency difference between the peak and the receiver's tuned frequency will be shown as **Peak offset**.

To calibrate the receiver to the peak frequency, click on **Calibrate to peak**. If successful, the peak offset will show as zero. Press **OK** to complete the process.

## Hand-Off Receiver

The *Excalibur Sigma* receiver software offers a special **Hand-Off** feature which makes it possible to utilize other available WinRADIo receivers, such as



---

the **WR-G313/180**, the **WR-G315**, the **WR-G39DDC**, or another **WR-G65DDC** receiver, or the inactive **RX** portion of the currently used **WR-G65DDC** receiver, as a hand-off or recording receiver.

When any one of the above receivers is available, selecting the **Hand-Off receiver** option under the **Options** top menu bar allows the *Excalibur Sigma* to pass the parameters for tuned frequency, mode and bandwidth directly to the hand-off receiver. For any receiver to become available to the *Excalibur Sigma*, it must be connected and switched on, and its application software must be running as well.

This feature may be useful if a frequency of interest is found and you wish to record or monitor it, and then tune the *Excalibur Sigma* to a frequency outside the currently tuned DDC1 bandwidth.

Audio from the WR-G313, or WR-G315 receivers will normally be presented to the stereo mixer system, although with the **WR-G313i**, or **WR-G315i** models (internal PCI-card version), it may be more convenient to use a separate speaker connected directly to the receiver's audio output socket.

## Color scheme

The entire color scheme of the **Excalibur Sigma** can be changed. If the dark blue of the default "skin" does not suit, there are more to choose from to suit the user's personal preference.

## Restore factory defaults

If you get lost by too much experimenting, help is always at hand: The **Restore factory defaults** function resets all the variables to the factory default values without losing any memory contents.

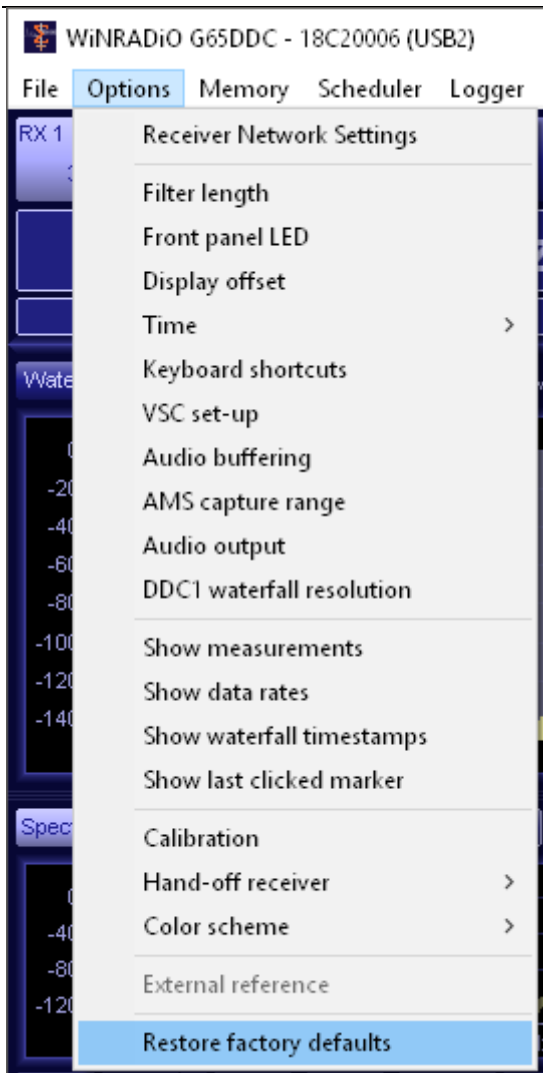

## Memory

The memory functions are described in full detail in the chapter **Memory tab** (under **Function tabs**). Selecting this top bar menu function is equivalent to pressing the Recall button under the memory tab.

The top menu bar function **Memory** contains the following facilities:



**Show user memory** makes it possible to display and edit the entire frequency memory structure.



**Memory Search Range** is used to adjust the accepted offset from stored frequencies. In this example, only stations that fall within  $\pm 1$  kHz of the tuned frequency are shown in the callsign display.

## Scheduler

The **Scheduler** is used to schedule automatic audio recording of stations at predefined dates and times:

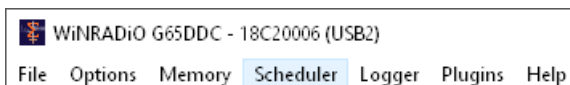

When the Scheduler function is selected, the following **Task list** is shown:

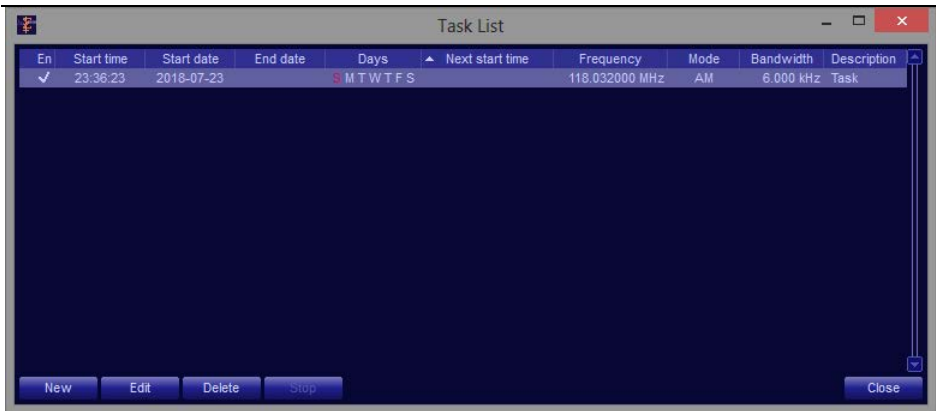

You can add new recording tasks by pressing the **New** button at the bottom-left. This opens the **New task** window.



At the top of the window, you can add the task description or name in the **Description** edit box which will then appear in the task list.

The next item to specify is the **Frequency** for the receiver to be tuned to.

The next items are **Start time** and **Start date**. This is when the task will be executed, for example a recording will commence.

After this, you will need to specify whether you wish for this task to run only once (select **Run once**), or whether this is to be a repetitive task (select **Repeat**). If this is to be a repetitive task, you can select the repeat period in terms of days, hours and minutes, and the ending date (using the **Until** control).

If the task is to be performed only on particular days of week, you can select those days of the week on which the task is to be performed. (By default, initially all days are selected, so you will have to deselect the unwanted days.)

Then there are three choices for the type of action for the Scheduler to perform: You can either run a special-purpose plug-in, an external application program, or make a recording. The last option, **Record**, selected by default, is the one that is most commonly used. The file name edit box allows you to choose the recorded file name and the actual recording file format (for more information about recording formats, please refer to **Appendix G**).

If the recording action is selected, you can then select whether the recording should be of the demodulated **Audio** or **DDC**. DDC recordings have the advantage of containing much more information, making it possible to “re-receive” many stations in the recorded spectrum which can be up to 64 MHz wide.

If the Audio recording type is selected, you can set the demodulator filter bandwidth (DEM BW) – an identical control to the one in the demodulator window. For DDC recording type, this control can be used to select the DDC recorded bandwidth.

For Audio recordings, the **Mode**, **Squelch** and **Audio filter** controls also become enabled, making it possible to set these parameters, similarly as they are set under their respective tabs during normal receiver operation. If squelch is enabled, the recording will be paused while the signal is below the squelch level.

Using the **Stop recording** controls, you can force a recording to stop if one (or more) of three conditions apply: The recording time exceeds a certain length, the recorded file exceeds a certain size, or the signal becomes squelched for a longer than specified period.

Finally, you can decide whether you wish to delete a task from the task list if ended, or wish to keep it for later editing and re-use.

All added tasks will be included in the task list. Right-clicking on an item in the task list will show a pop-up menu which makes it possible to enable or disable a task without deleting it, tune to the station specified in the task, edit or delete a task (these last two functions serve for convenience and duplicate the **New** and **Edit** buttons).

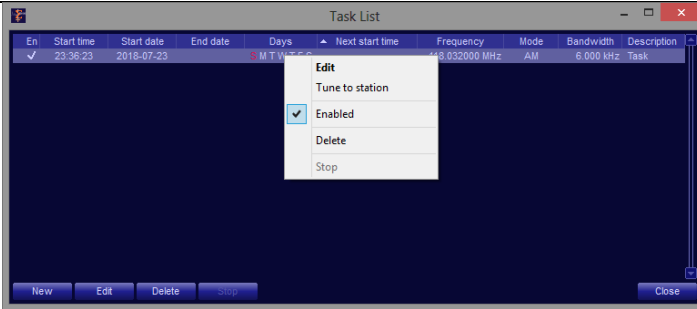

By default, the recorded audio files are saved in the **My Documents/WiNRADiO/G65DDC** folder but you can change this using the file browser function when entering the recorded file name.

## Logger

The *Excalibur Sigma* receiver is equipped with a simple logging function which makes it possible to log signal strength on up to three frequencies at the same time.

These are specified by simply tuning one or all of the three receivers (RX1, RX2 or RX3) to the desired frequencies.

A simple dialog box then makes it possible to specify the file path and name into which the logging will be made (in the CSV format) and the logging period.

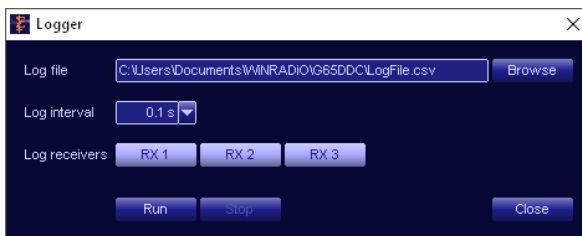

While the Logger is running, normal operation of the receiver is not possible. Elapsed time is shown in the Logger window and this is also where the logging task can be stopped. Once logging is stopped and the Logger window closed, the receiver's operation returns back to normal.

## Plugins

---

The last item (except **Help**) in the top bar menu is **Plugins**. Like many other WiNRADiO products, the *Excalibur Sigma* has the capability to integrate with WiNRADiO's XRS (Extensible Radio Specification) plug-ins that can extend the receiver's capability in many respects.

These can include various general-purpose enhancements related to particular user-interface functions, as well as additional demodulators and other signal processing facilities. It is also possible for users to write their own special application plug-ins.

For more information about XRS plug-ins, please refer to [www.winradio.com/xrs](http://www.winradio.com/xrs)

## Power Switch

---

The **Power** switch, located at the bottom-right corner of the application window, controls the receiver's power. When it is off, the receiver circuitry will be powered down.



When you exit and restart the WiNRADiO G65DDC application, the power on/off status will be remembered. However, you do not need to power-off the receiver using this button before closing the application.

## Date and Time Display

---

The top menu bar clock display indicates the current time and date.



Using the function **UTC time** under **Options** top menu bar, you can set the display to be in local time or UTC time.

If in the UTC time mode, the clock will show **Universal Coordinated Time**, formerly called **GMT** (Greenwich Mean Time), which is the standard time used around the world. This is provided because most shortwave stations announce their broadcast times in UTC. Both time modes derive their information from



the PC clock. The time difference is determined by a setting in your Windows Control Panel (**Date and Time** setting, **Time Zone** tab).

---

*Did you know?*

*Coordinated Universal Time is abbreviated "UTC". The International Telecommunication Union wanted Coordinated Universal Time to have a single abbreviation for all languages. English speakers and French speakers each wanted the initials of their respective language's terms to be used internationally: "CUT" for "coordinated universal time" and "TUC" for "temps universel coordonné". This resulted in the final compromise of using "UTC".*

---

## Appendix A – SDR and DDC Primer

---

This note is intended to help “traditional” radio enthusiasts understand the technology differences between old style analog receivers and the new generation of **Software Defined Radio (SDR)**, especially with reference to the WiNRADiO *Excalibur Sigma*.

### Analog Receivers

Prior to the era of computer-interfaced radio receivers, a block diagram of a typical HF receiver would look similar to that below. Incoming radio signals are down-converted via one or more conversion processes, all using analog components, tuned circuits, and various amplifiers, mixers and oscillators. Following the final down-conversion, the resulting signal is applied to a demodulator, and then to the audio output circuits:

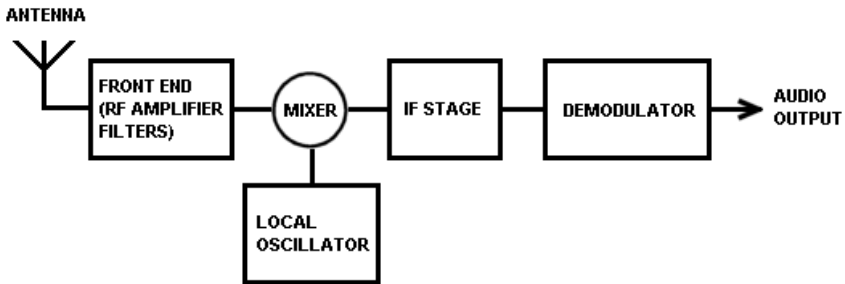

These receivers depend only on hardware for their performance and functionality. In the currently prevailing nomenclature of the SDR industry, they are formally referred to as **SDR Tier Zero** receivers, meaning that there is no involvement of software at all.

### First Generation SDR

With the proliferation of personal computers into every aspect of our life, some manufacturers realized that the world of radio had essentially remained unaffected by computers and the radio receivers of the day would benefit from some degree of computerization. WiNRADiO led that movement with the introduction of the world's first consumer PC-based communications receiver in 1995, the award-winning **WR-1000i** model – a fully-fledged general-coverage receiver on a PC card. A serial-interfaced (RS-232) external model

**WR-1000e** shortly followed suit. These receivers were little more than software **controlled** (rather than software **defined**): Their functionality, especially those critical filtering and demodulation functions, was still very much defined by and dependent on hardware. The software portion of these products was limited to only two basic functions: To provide a convenient graphical user interface and to process the audio via a computer sound card.

However, even with this limited added functionality, it was already obvious that the “marriage” of a radio and computer was inevitable and could produce some very interesting results: A software-based user interface can be considerably more powerful than a hardware panel of a conventional receiver, and computer-based audio processing can provide ancillary functions such as audio filtering and recording with ease and at little additional cost.

Radio receivers that implement such software control, yet still retain most of their other functionality defined by hardware, are often classified as **SDR Tier One**, or **Software-Controlled Radio**.

## Second Generation SDR

The second generation SDR receivers bring the radio-computer integration a step further, by including an analog-to-digital converter (ADC) into the essential functionality of the receiver. This came about primarily as a result of performance improvement in PC sound cards, as well as increased CPU power of personal computers that started to rival that of dedicated digital signal processors (DSPs).

With the second generation of SDR receivers, the output of the final IF stage is applied to an ADC (either a PC sound card, or included in the receiver), and the resulting digitized IF signal is then processed further by the host computer using mathematical digital signal processing (DSP) principles. Such processing would include filtering and demodulation.

DSP-based filtering has brought two major benefits: A DSP filter can be made much sharper than a traditional one, resulting in improved selectivity. At the same time, the filter bandwidth can be made continuously variable, making it possible to match the filter passband to the actual signal bandwidth and so maximize the signal-to-noise ratio.

DSP-based demodulation provides a receiver with great flexibility, where additional modes can be easily added by a simple software change, while the

hardware remains the same. Plus of course, there is a benefit of performance consistency: With the same input, a software routine will always produce the same result, not depending in variations and aging of components such as diodes, resistors and capacitors.

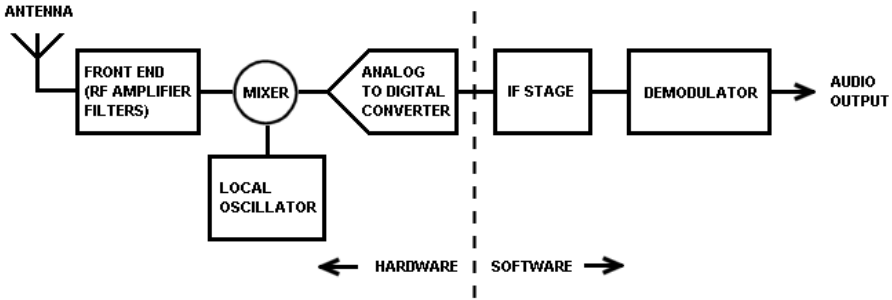

Another advantage of this concept is in the ability to present the IF signal in a real-time spectrum display. Being able to “see” a signal and its neighborhood, in addition to merely hear it, has brought about a major paradigm change and increased a radio operator’s expectation as to what to expect from a radio receiver.

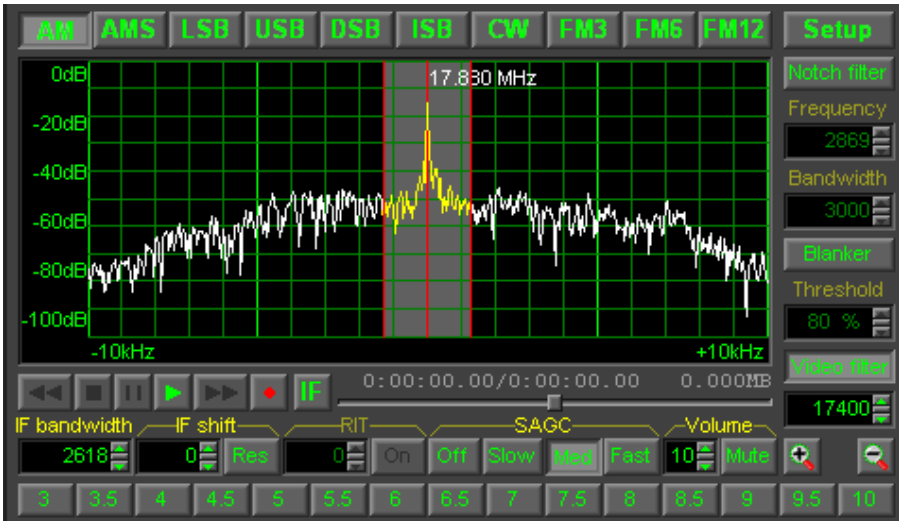

The preceding spectrum display is that of the WiNRADiO **G313** receiver, a typical representative of this type of SDR receivers, belonging to a class of receivers also referred to as **SDR Tier Two** or **Software-Reconfigurable**

**Radio.** In SDR Tier Two radios, software is used to control and redefine a variety of modulation techniques, spectrum bandwidth, and other essential parameters and functionality of a radio receiver.

### DDC-Based Receivers – The *Excalibur Sigma*

The arrival of the digital down-converter (DDC) has moved the hardware-software dividing line of *SDR Tier Two* category receivers closer to the antenna and introduced additional benefits.

Advances in digital electronics, especially the introduction of fast ADCs and field-programmable gate arrays (FPGA) made it possible to eliminate some, if not all, hardware-based heterodyne processes and introduce the concept of digital down-conversion, where the local oscillator and a mixer can be replaced with a single software-reconfigurable hardware component.

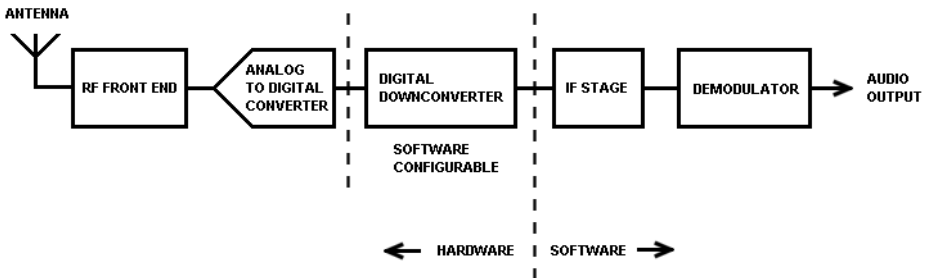

Modern ADCs can achieve a sampling rate of 200 MHz and beyond. The **Nyquist theorem** says that the maximum frequency that can be sampled needs to be smaller than half of the sampling rate (see [www.wikipedia.org/wiki/Nyquist\\_frequency](http://www.wikipedia.org/wiki/Nyquist_frequency)). So, with 210 MSPS (mega samples per second) we have the potential with the Excalibur Sigma to sample almost 105 MHz of spectrum at once.

However, one ADC does not yet make an SDR, and more software processes are involved. Because of the very high amount of data in a real time bandwidth of 105 MHz, it is necessary to reduce this to a more manageable bandwidth for further processing by the computer. The most common process for such a reduction is digital down-conversion (DDC) which typically relies on a special hardware component known as a field programmable gate array (FPGA).

The process of reducing real time data and thus the usable bandwidth is known as decimation, and in the Excalibur Sigma this first decimation results in a DDC bandwidth of up to 64 MHz. This 64 MHz bandwidth effectively allows the user to place a 64 MHz wide window anywhere within the ADC

bandwidth (up to almost 105 MHz in the Excalibur Sigma).

It is interesting (but not recommended to the faint-hearted) to note the decimation description at

**[www.wikipedia.org/wiki/Decimation\\_\(Roman\\_army\)](http://www.wikipedia.org/wiki/Decimation_(Roman_army)).**

In fact, it is easy to imagine this decimation process to be similar to the mixing and IF stages of a conventional super-heterodyne receiver, with each filtering stage progressively refining the output of the process.

The Excalibur Sigma has two stages of decimation. The first stage of decimation is performed by the primary DDC implemented in an FPGA component, which is physically located within the receiver module. Here the 105 MHz analog spectrum of the ADC is reduced by decimation to the bandwidth of 64 MHz or less. This effectively reduces the amount of data that needs to be transferred to the PC for further processing.

The data produced by primary DDC is sent from the receiver to the PC, either via the USB 3.0 or the Gigabit Ethernet interface (LAN) interfaces. The second decimation takes place inside the PC within the demodulator software.

If the USB 3.0 interface is used, there are no limitations to the operation of the receiver.

However, if the Gigabit Ethernet (LAN) interface is used, it is important to note that the theoretical limit of 1000 Mbit/s reduces the available DDC bandwidth of the receiver to 16 MHz when operating over the Gigabit Ethernet.

As the whole DDC spectrum is sent to the PC for processing, it is necessary to use a 'modern' PC, typically with at least a four core CPU of later generation. With slower CPUs, it may not be possible to achieve the entire potential of the *Excalibur Sigma*, in particular the ability to process the entire 64 MHz wide DDC bandwidth.

Once the DDC data is efficiently transferred to the PC, it is then possible to process the data by digital filtering and demodulation. Using the *Excalibur Sigma* software running on a modern PC, it is possible to simultaneously demodulate three signals, providing three **virtual receivers**. Each virtual receiver can be placed at any frequency within the DDC spectrum, and each controlled, in respect of mode and bandwidth setting, filtering, recording, etc., completely independently.

The *Excalibur Sigma* is provided with comprehensive recording facilities. In

addition to audio, the entire DDC spectrum can be recorded, up to the full 64 MHz bandwidth. However, this does have a high demand on the PC hardware. For example, a 64 MHz wide DDC stream, with a low resolution, needs to transfer data to the hard disk at approximately 19 GB per minute.

Clearly, in order to maintain this transfer rate, not only must the hard disk be relatively large, but also the data transport inside the PC must operate at its optimum. For example, with desktop PCs it is relatively easy to fit internal SATA disk drives. However, with external (USB interfaced) disk drives, it is important to remember that...

***If the external hard drive is USB-interfaced and connected via a USB hub shared with the Excalibur Sigma, the total USB data transfer speed has to be shared, thus reducing the performance of both devices.***

So far we have discussed the clever digital 'bits' of SDRs, but we should not ignore the RF issues associated with direct sampling, such as the effect of the ADC performance.

Firstly, the dynamic range: With the *Excalibur Sigma*, any signals ranging from (almost) DC to (almost) 105 MHz (210 MHz respectively) will be digitally sampled and processed. However, in order to provide sufficient sensitivity, it is necessary to insert a degree of amplification before the ADC, but this amplification can have a detrimental effect if not correctly managed.

Traditional super-heterodyne receivers often include many tuned circuits designed to reduce various spurious ghost signals (birdies), often generated by the RF and IF mixing processes involved. While with a direct-sampling receiver such as the *Excalibur Sigma* these birdies and ghosts are entirely eliminated, another factor comes into play:

The ADC has a maximum 'input level', beyond which the sampler becomes unable to operate correctly. With the *Excalibur Sigma*, this is approximately 0 dBm. If the ADC is presented with a signal greater than this, the ADC will be overloaded, resulting in distortion (much like overloading a speaker with too much audio).

The ADC is effectively 'wide open' to any input frequency, even if a user is tuned to 10 MHz, a strong signal in the Medium Wave band can still overload the receiver. This effect is easily avoided by using the **Auto** setting for the **Attenuator**. With the auto setting, the input level is continuously monitored, and if the level exceeds the threshold, an appropriate level of attenuation is automatically inserted.

Another issue is 'image response'. As already mentioned, traditional oscillator based spurious responses are eliminated in a direct sampling receiver, however, there is still a potential for a spurious signal similar to the traditional image response.

The ADC sampling frequency of the *Excalibur Sigma* is 210 MHz. According to the **Nyquist theorem**, this would allow sampling of an RF spectrum to close to half of that frequency, i.e. close to 105 MHz.

To make things simpler, let's pretend for a while that the *Excalibur Sigma* features only one lower frequency range from 1 kHz to 88 MHz. With a signal input of less than 105 MHz, all is well. But above 105 MHz, an image or alias signal will appear in the spectrum below 105 MHz. For example, if a signal at 195 MHz is present at the input, this would appear on 15 MHz due to the aliasing effect and potentially mask a wanted signal there.

In the *Excalibur Sigma*, this effect is significantly reduced by the use of a high quality low-pass filter preceding the ADC and effectively removing the 195 MHz signal before it is presented to its input. This filter is known as the **anti-aliasing filter**. However, this anti-aliasing filter cannot be made perfect; its skirt is always somewhat sloping rather than being an ideal vertical line, and its stop-band attenuation cannot be made infinite. As a result, the receiver's lower bandwidth is smaller than 105 MHz, and there is also an "image response" of signals higher than 105 MHz. However, in the *Excalibur Sigma*, the image response is still excellent compared to any conventional receiver.

Now, let's get back to second frequency range of the *Excalibur Sigma*. The second frequency range from 118 to 190 MHz features a separate antenna input and dedicated signal chain. Here, the aliasing effect is taken advantage of and grants the *Excalibur Sigma* the ability to process signals of frequencies, which according to the Nyquist theorem are higher than half of the sampling rate of the ADC, i.e. 105 MHz. However now the **anti-aliasing filter** is still needed and has to be even more complex: on the lower side it has to filter out the frequency components below 105 MHz, which are now considered as spurious and on the higher side it has to filter out frequency components higher than 210 MHz. So, for the second frequency range from 118 to 190 MHz the anti-aliasing filter consists of two high quality separate filters – the high pass at 118 MHz and the low pass filter at 190 MHz.



---

## Appendix B – Troubleshooting

---

Problem	Solution
Upon installation, the software says that the receiver is not found and offers to run in demo mode only.	<p><b><i>WR-G65DDCe (USB/LAN model):</i></b></p> <p>Check that receiver is turned on. The blue LED should flash.</p> <p>Compare the LED flashing pattern with the table shown in <b>Appendix C</b>. If the flashing pattern is “5” (meaning USB connected, driver not installed), please reinstall the driver: Disconnect the receiver from the USB port first and reinstall the software from the supplied CD ROM. Then reconnect the receiver. Windows should detect this and start the usual “new hardware found” routine.</p>

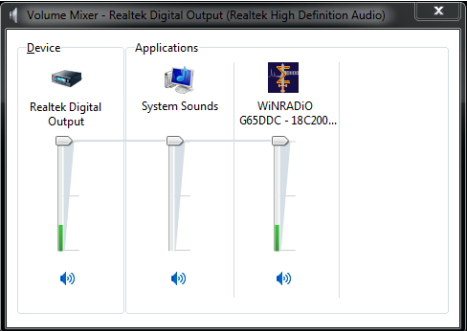
Problem	Solution
<p>The receiver application runs OK, but there is no sound coming from the speaker.</p>	<p>When you tune to a known station, you should be able to see a peak on the demodulator spectrum scope. If you can't see any peak, make sure your antenna is properly connected. If you can see a peak but there is no sound coming from the speaker, please check the following:</p> <p>The <b>Mute</b> button under the <b>Audio</b> tab is disengaged and the volume is set to a medium level (say 15).</p> <p><b>AGC</b> under the <b>Gain</b> tab is enabled and set to medium speed.</p> <p>The squelch is disabled (the <b>Enable</b> button under the <b>Squelch</b> tab is disengaged).</p> <p>The sound card output is properly connected to speakers or headphones and both the WiNRADiO Application and Device volume controls are unmuted in the sound card control panel and the levels adjusted approximately as shown in the following picture:</p> 







<b>Problem</b>	<b>Solution</b>
<p>I can hear the audio and tune the receiver, but the sound is distorted.</p>	<p>Make sure that <b>AGC</b> under the <b>Gain</b> tab is enabled and set to medium speed. Try to adjust the <b>Gain</b> parameter under the <b>Audio</b> tab (excessive audio gain can cause distortion).</p> <p>If the S-meter shows the <b>ADC CLP</b> message, try to reduce the signal level using the <b>Attenuator</b>.</p>
<p>I can hear the audio and tune the receiver, but the volume is too low, even if I adjust the volume control to maximum.</p>	<p>Presuming the volume is already set to the maximum level under the <b>Audio</b> tab, try to adjust the <b>Wave</b> and <b>Master</b> volume also in the sound card control panel, or on the amplified speakers you are using.</p> <p>Make sure that <b>AGC</b> under the <b>Gain</b> tab is enabled. Try to adjust the <b>Gain</b> parameter under the <b>Audio</b> tab (excessive audio gain can cause distortion).</p>
<p>I can hear the audio and tune the receiver, but the software is very sluggish, sometimes it may even freeze.</p>	<p>Close all other programs to reduce the CPU load.</p> <p>Go to <b>Options</b> top bar menu and select <b>Filter Length</b>. This function shows the CPU load. This value should not go over 30%. If it does, this may indicate insufficient PC resources. You might need to decrease the demodulator filter length (although values under 200 may not provide adequate selectivity) and/or limit the maximum DDC1 bandwidth you can use (the wider the DDC1 bandwidth the greater burden on the CPU resources). For best performance, modern PCs should be used, preferably with quad core or higher.</p>

Problem	Solution
<p>I can hear the audio and tune the receiver, but the audio is very noisy.</p>	<p>Make sure the <b>Attenuator</b> is disabled and the <b>Preamplifier</b> is engaged. Check that your antenna is properly connected, the connector is not loose and that the antenna cable is not damaged. Does the noise floor drop significantly if you disconnect the antenna? If so, then perhaps the antenna is picking up too much ambient noise. Try to improve the antenna, or move it further away from the PC. An outdoor antenna is preferable. Watch for ground loop problems (for details, see the chapter <b>Connecting the Antenna</b>).</p>
<p>Reception is obscured with a buzzing interference or periodic RF peaks.</p>	<p>Check for the sources of interference in your surroundings: it could be fluorescent lights, a lamp dimmer, or other household appliances. Your PC could be the culprit. Unless you are able to suppress the interference at the source, the only solution is to install a better antenna, preferably an outdoor one. Computer networks are especially noisy and if your PC is connected to one, you will almost certainly need an outdoor antenna. If the interference level varies periodically with peaks about 30-100 kHz apart, the most likely culprit is the monitor or the video card. Modern LCD monitors generate much lower levels of interference than old CRT ones. A noisy laptop may also create “comb-like” spectra with peaks several MHz apart. Switch the monitor off - if the interference disappears then the cause is the monitor. Move the antenna away from the computer and observe if the interference reduces as a result. (See also <b>Appendix D – Dealing With Interference</b>.)</p>

## Appendix C – USB and LAN Interface Diagnostics

The flashing pattern of the blue LED on the WR-G65DDCe receiver's front panel has a diagnostics meaning. Normally, when the receiver is powered up and the application running, the blue LED should flash in a dih-dah pattern (i.e. a short flash followed by a long one).

A complete list of the flashing patterns and their meaning is as follows:

No.	Pattern	Description	Mode
1		Off	No power
2		Fading	No connection to computer
3		Two short flashes	USB or LAN client connected, radio off
4		One short flash followed by a long one	USB or LAN client connected, radio on, <b>ready</b>
5		Two short flashes followed by a long one	USB connected, driver not installed
6		Three short flashes	USB or LAN connected, driver installed, application not running

For the normal **Ready** state as indicated by pattern 4 (one short flash followed by a long one), the front panel LED can be controlled by the user, under the **Options / Front panel LED** top bar menu. Depending on these settings, the LED can be made to either indicate the diagnostic patterns, or be continuously on or off (while the application is running).

This is useful in situations when a flashing LED might appear disturbing and a steady state is preferable.

## Appendix D – Dealing with Interference

---

**Electromagnetic Interference (EMI)** is what prevents us from receiving a clear signal, even when the receiver should be sensitive enough to receive it. There are many types of interference you can experience with radio receivers, emanating from both natural and man-made sources.

Natural interference is produced by atmospheric phenomena such as storms and sun activity.

Not so surprisingly, man-made interference is often worse. Sources include electric motors, power lines, passing cars, electrical welding equipment, fluorescent lights, domestic appliances, computer networks, etc. Receiving antennas should always be as far away from sources of electromagnetic interference as possible.

One significant source of man-made electromagnetic interference is the personal computer. Since the *WiNRADiO Excalibur Sigma* receiver requires a personal computer to operate, this creates a potential paradox. The receiver itself is designed to be substantially immune to computer-generated interference. However, any receiver needs to be connected to an antenna, and antennas can't discriminate between useful signals and interference. The interference from your computer can either radiate directly to the antenna, or it can be conducted to it along the outer conductor of the lead-in cable. Even in professional radio receiving stations, a lot of care and effort is always needed, if this type of self-interference is to be avoided.

Some computers are worse than others in terms of generated electromagnetic interference. The specifics of a computer-based software-defined receiver require a careful consideration with respect to computer-generated noise. Over the past decade or so, computers have become considerably quieter in terms of radiated radio frequency interference (RFI). Replacing CRT monitors with modern LCD types has substantially contributed to this, as have strict FCC and CE requirements with respect to allowable levels of RFI for consumer products.

To check this, tune to some of the interfering signals, then switch off the monitor and see if the signal disappears. If it does then you could continue using the *WiNRADiO* receiver, and live with the fact that some useful frequencies will be obscured by your monitor's interference, or you can replace

your monitor with a 'quieter' one, or you can try to relocate your antenna further away from your computer.

While the *WiNRADiO Excalibur Sigma* receiver has been designed to minimize interference-related problems, switched-mode computer power supplies sometimes still present a challenge. This type of interference would usually enter the receiver as **common-mode noise**, which means that the noise is in the same phase on both the active and shielding conductors of the antenna lead.

A good remedy to try is to wind five to ten turns of the antenna lead-in cable through a large ferrite core (the doughnut shaped *toroid* type), near the PC end of the cable. This suppresses the **common-mode interference**, which is a typical but curable problem with PC-controlled receivers.

A most effective remedy is the *WiNRADiO WR-CMC-30 Common-Mode Choke* (see [www.winradio.com/cmc30](http://www.winradio.com/cmc30)), which is well proven to cure most common-mode interference problems. In extreme cases, two or more chokes can be used, placed strategically along the antenna lead where suitable grounding points exist.

Long wire antennas, while most commonly used, also appear to be most susceptible to problems related to ground loops. If you encounter such problems, we would also suggest experimenting with **magnetic loop** antennas which do not require grounding at all.

Another type of interference which you may encounter is **intermodulation interference**. This is usually caused by strong local stations, whose frequencies combine to create 'ghost' signals on frequencies which are arithmetic combinations of the stations' frequencies. These 'ghost' signals can sometimes coincide with useful frequencies, rendering them partially or completely unusable. They will usually disappear when you enable the **Attenuator**. In some cases, intermodulation interference in the shortwave band is caused by a strong local MW station and the most effective remedy would be to install an external **MW filter**.

## Appendix E – Waterfall Spectrum Palettes

---

The **Waterfall spectrum** (wide band and DDC1) use color palettes, selectable using the **Palette** control:



The color palettes reside in ordinary text files with an extension “.pal”, located in the application installation folder, i.e. typically **C:/Program files (x86)/WiNRADiO/G65DDC/Defs**

The existing files are named **Blue.pal**, **Cold.pal**, **DeepBlue.pal**, **Gray.pal**, **Hot.pal**, **Magenta.pal**, **Rainbow.pal**, **Sepia.pal** and **Yellow.pal**.

You can create your own additional palettes quite easily.

A palette file consists of 256 lines. The top line corresponds to the maximum signal strength (**max\_SS**) displayed by the waterfall, the bottom line corresponds to the minimum signal strength (**min\_SS**).

Each line contains a set of decimal RGB values separated by spaces (0 0 0 represents black; 255 255 255 is white). The incoming signal strength values are mapped to this color space as follows:

If the attenuator is off, the minimum signal level is -150 dBm, the maximum level is 0 dBm. If the attenuator is on, the attenuation value is added to these figures (for example, for 10 dB attenuation, the minimum displayed signal level will be -140 dBm and the maximum level will be +10 dBm).

The **Color index**, i.e. the sequential number of the corresponding line in the palette related to a particular input signal strength (**SS**) will be calculated using a linear interpolation formula:

$$\text{Color\_index} = 255 * (\text{SS} - \text{min\_SS}) / (\text{max\_SS} - \text{min\_SS})$$

(All signal strength values are in dBm.)



## Appendix F – Recording File Formats

The **DDC recorder** can record the DDC stream in a standard **WAV** file format, but saves the files with an extension **“.ddc”** in order to avoid confusion with audio wave files. The proprietary WiNRADiO **RXW** file format (extension **“.rxw”**) is often a better choice, because it also contains additional data such as the current DDC center frequency, date, time and internal compensation data, which makes it possible to simulate original conditions during the playback. When replaying an **RXW** recording, the recorder panel shows the original time of the played back signal and the DDC spectrum scope shows the original DDC frequency. If **“Waterfall timestamps”** option is enabled, the DDC waterfall also shows the original time in its vertical axis.

All DDC files are stereo (as they are stored in the I/Q form) and 24 bit for DDC bandwidths below 3.2 MHz and 16 bits for 3.2 MHz and wider DDC bandwidths. The recording sampling rate varies according to the selected DDC bandwidth, shown in the following table:

DDC Bandwidth (kHz)	DDC Recording Sampling Rate (kHz)
20	25
24	32
32	40
40	50
50	62.5
64	80
80	100
100	125
125	160
160	200
200	250
250	312.5
320	400
400	500
500	625
640	800
800	1000
1000	1250
1250	1666.67
1600	2000

DDC Bandwidth (kHz)	DDC Recording Sampling Rate (kHz)
2000	2500
2500	3333.3
3200	4000
4000	5000
5000	6250
6000	8333.3
8000	10000
10000	12500
12500	16666.67
16000	20000
20000	25000
25000	33333.33
32000	40000
40000	50000
50000	66666.67
64000	80000

**Note: The Nyquist sampling theorem is satisfied because there are two values (I and Q) for each sample (stored as two stereo channels), so the effective sampling rate is twice of that shown.**

The **Audio recorder** can record standard Windows **“.wav”** files with 16 bit word length, sampled at 48 kHz, in stereo, or in WiNRADiO proprietary **WWW** (extension **“.www”**) file format, which also stores the actual time, frequency, mode and the RMS signal strength. These additional data can be viewed in special WWW players, such as the WiNRADiO **WAARP**.

The following standard naming conventions apply to files created by the DDC and audio recorders:

If the **Insert Frequency and Date/Time** checkbox is checked in the recorder “toolbox” a file with a name such as **rec-12.345678MHz\_11-07-04\_15'34'57.ddc** is created. The center frequency of the DDC spectrum, together with the current local time, are saved as a part of the file name, to be able to position the spectrum accurately during playback. With audio recordings, the actual tuned frequency and the local time are inserted. (This information serves merely for the user's convenience, i.e. the receiver is not tuned to this frequency when such file is played back.)

If you select **Increment its name** for the **If file exists** condition and start recording, this will create a file named for example **rec-12.345678MHz-**

**\$001.ddc**. The file name includes a "counter" prefixed by the "\$" sign. With each new created file, this counter will be incremented.

If you engage the **Split** button and the file size reaches 2 GB, the existing file will be automatically closed and named **rec-12.345678MHz-\$001-^001.ddc**, where the "^" sign denotes these split sections, and recording will automatically continue into a file named **rec-12.345678MHz-\$001-^002.ddc**. If you manually stop and restart the recording, it will continue to a file named **rec-12.345678MHz-\$002.ddc**, etc.

## Appendix G – G65DDCe Connections

---

All connectors are located on the rear panel of the receiver. Some of the connectors may not be installed depending upon the customer's requirements.



1. Frequency reference output (optional)
2. Frequency reference input (optional)
3. Antenna input frequency range 1 : 1 kHz – 88 MHz
4. Antenna input frequency range 2 : 118 MHz – 190 MHz
5. Power input connector 12 V
6. Gigabit Ethernet Interface (LAN) with PoE capability
7. USB 3.0 Interface

## Appendix H – Compliance Declarations

---

### CE Conformity

Radixon Group Pty.Ltd. declares that the WiNRADiO G65DDC *Excalibur Sigma* receiver complies with the following EC standards:

EN 60950  
ETSI EN 301489-1  
ETSI EN 300113

### FCC Compliance

This device, trade name **WiNRADiO Communications Receiver**, model number **WR-G65DDC** complies with FCC part 15B and ICES-003. Operation is subject to the following conditions: (1) This device may not cause harmful interference, and (2) this device must accept any interference received, including interference that may cause undesired operation.

We have determined and warrant that the above described device has been shown to comply with the requirements of the FCC Part 15, by having a device tested at an accredited testing laboratory. Each unit marked is identical to the device as tested. Compliance assumes no unauthorized changes will be made to the equipment and it will be maintained and operated properly. A test report has been generated. A technical file containing the test report will be maintained for a period of at least 2 years after manufacturing ceases. It is also understood that characteristics of this equipment will require retesting.

Please direct all communication regarding this matter to:

Compliance Manager  
Radixon Group Pty.Ltd.  
45 - 47 Islington Street  
Collingwood  
Victoria 3066  
Australia

Tel: +61 3 9417 3417  
Fax: +61 3 9417 3556

## Appendix I – Safety Disposal

---



1. When this crossed-out bin symbol is attached to a product it means that the product is covered by the European Community directive 2002/96/EC.
2. All electrical and electronic products should be disposed of separately from the municipal waste stream via designated collection facilities appointed by the government or by the local authorities.
3. The correct disposal of your old appliance will help prevent potential negative consequences for the environment and the human health.
4. For more detailed information about the disposal of your old appliance, please consult your city office, waste disposal service or the shop where you purchased the product.

**WiNRADiO®**

COMMUNICATIONS

[www.winradio.com](http://www.winradio.com)