



FCC TEST REPORT

Report No:STS1808184W08

Issued for

Shadow Creator Information Technology Co., Ltd.

3 Floor, Building 12, 399 lane, Chuan Qiao Road, Pudong
New Area, Shanghai, China

Product Name:	VR virtual reality helmet
Brand Name:	Shadow Creator
Model Name:	Shadow V01
Series Model:	N/A
FCC ID:	2AQYUSHADOWV01
Test Standard:	FCC Part 15.407

Any reproduction of this document must be done in full. No single part of this document may be reproduced without permission from STS, All Test Data Presented in this report is only applicable to presented Test sample.





TEST RESULT CERTIFICATION

Applicant's name : Shadow Creator Information Technology Co., Ltd.
Address : 3 Floor, Building 12, 399 lane, Chuan Qiao Road, Pudong New Area, Shanghai, China
Manufacture's Name..... : Shadow Creator Information Technology Co., Ltd.
Address : 3 Floor, Building 12, 399 lane, Chuan Qiao Road, Pudong New Area, Shanghai, China

Product description

Product Name..... : VR virtual reality helmet
Brand Name : Shadow Creator
Model Name : Shadow V01
Series Model..... : N/A

Test Standards..... : FCC Part15.407

Test procedure..... ANSI C63.10-2013

This device described above has been tested by STS, the test results show that the equipment under test (EUT) is in compliance with the FCC&IC requirements. And it is applicable only to the tested sample identified in the report.

This report shall not be reproduced except in full, without the written approval of STS, this document only be altered or revised by STS, personal only, and shall be noted in the revision of the document.

Date of Test..... :

Date (s) of performance of tests : 20 Aug.2018~24 Aug.2018

Date of Issue..... : 28 Aug.2018

Test Result..... : **Pass**

Testing Engineer : 

 (Chris chen)

Technical Manager : 

 (Sean she)



Authorized Signatory : 

 (Vita Li)



Table of Contents	Page
1 . SUMMARY OF TEST RESULTS	5
1.1 TEST FACTORY	6
1.2 MEASUREMENT UNCERTAINTY	6
2 . GENERAL INFORMATION	7
2.1 GENERAL DESCRIPTION OF EUT	7
2.2 DESCRIPTION OF TEST MODES	10
2.3 BLOCK DIGRAM SHOWING THE CONFIGURATION OF SYSTEM TESTED	11
2.4 DESCRIPTION OF SUPPORT UNITS(CONDUCTED MODE)	11
2.5 EQUIPMENTS LIST FOR ALL TEST ITEMS	12
3 . EMC EMISSION TEST	13
3.1 CONDUCTED EMISSION MEASUREMENT	13
3.2 RADIATED EMISSION AND (BANDEGE) MEASUREMENT	17
3.2.6 FIELD STRENGTH CALCULATION	20
4. CONDUCTED SPURIOUS EMISSIONS AND BANDEGE	28
4.1 APPLIED PROCEDURES / LIMIT	28
5. POWER SPECTRAL DENSITY TEST	30
5.1 APPLIED PROCEDURES / LIMIT	30
6. BANDWIDTH MEASUREMENT	32
6.1 EMISSION BANDWIDTH (EBW) 26 BANDWID PROCEDURES / LIMIT	32
6.2 OCCUPIED BANDWIDTH (99%) TEST APPLIED PROCEDURES / LIMIT	33
6.3 MINIMUM EMISSION BANDWIDTH(6 DB) PROCEDURES / LIMIT	34
7. MAXIMUM CONDUCTED OUTPUT POWER	35
7.1 APPLIED PROCEDURES / LIMIT	35
8. AUTOMATICALLY DISCONTINUE TRANSMISSION	38
8.1 LIMIT OF AUTOMATICALLY DISCONTINUE TRANSMISSION	38
8.2 TEST RESULT OF AUTOMATICALLY DISCONTINUE TRANSMISSION	38
9. ANTENNA REQUIREMENT	39
9.1 STANDARD REQUIREMENT	39
9.2 EUT ANTENNA	39
APPENDIX - PHOTOS OF TEST SETUP	40



Revision History

Rev.	Issue Date	Report NO.	Effect Page	Contents
00	28 Aug.2018	STS1808184W08	ALL	Initial Issue





1. SUMMARY OF TEST RESULTS

Test procedures according to the technical standards:

§ 15.407, KDB 789033 D02 General U-NII Test Procedures New Rules v02r01

FCC Part 15.407		
FCC standard	Test Item	Results
15.207	AC Conducted Emission	PASS
§ 15.407 (2) (26 dB) / § 15.407 (e) (6 dB) / § 15.407 (a) (99%)	26dB/6dB & 99% Bandwidth	PASS
15.407(a) (1).(2).(3).(4).(5)	Maximum Conducted Output Power	PASS
15.407(b)	Peak Excursion Ratio	PASS
15.407(b) & 15.209	Radiated Emission And (bandedge Emissions) Measurement	PASS
15.407(b)7	Conducted Emission And (bandedge Emissions) Measurement	PASS
15.407(a) (1).(2).(3).(4).(5)	Power Spectral Density	PASS
15.407(c)	Automatically Discontinue Transmission	PASS
15.203/15.204	Antenna Requirement	PASS

NOTE:

(1) "N/A" denotes test is not applicable in this Test Report

(2) all tests are according to ANSI C63.10-2013



1.1 TEST FACTORY

Shenzhen STS Test Services Co., Ltd.

Add. : 1/F., Building B, Zhuoke Science Park, No.190, Chongqing Road,
Fuyong Street, Bao'an District, Shenzhen, Guangdong, China

CNAS Registration No.: L7649; FCC Registration No.: 625569

IC Registration No.: 12108A; A2LA Certificate No.: 4338.01;

1.2 MEASUREMENT UNCERTAINTY

The reported uncertainty of measurement $y \pm U$, where expanded uncertainty U is based on a standard uncertainty multiplied by a coverage factor of $k=2$, providing a level of confidence of approximately **95 %**.

No.	Item	Uncertainty
1	Conducted Emission (9KHz-150KHz)	$\pm 2.88\text{dB}$
2	Conducted Emission (150KHz-30MHz)	$\pm 2.67\text{dB}$
3	RF power,conducted	$\pm 0.71\text{dB}$
4	Spurious emissions,conducted	$\pm 0.63\text{dB}$
5	All emissions,radiated(<1G) 30MHz-200MHz	$\pm 3.80\text{dB}$
6	All emissions,radiated(<1G) 200MHz-1000MHz	$\pm 3.97\text{dB}$
7	All emissions,radiated(>1G)	$\pm 3.03\text{dB}$



2. GENERAL INFORMATION

2.1 GENERAL DESCRIPTION OF EUT

Product Name	VR virtual reality helmet	
Trade Name	Shadow Creator	
Model Name	Shadow V01	
Series Model	N/A	
Model Difference	N/A	
Product Description	The EUT is VR virtual reality helmet	
	Operation Frequency:	IEEE 802.11a/ n/ac(HT20)5.745GHz-5.825GHz IEEE 802.11a/ n/ac(HT40)5.755GHz-5.795GHz IEEE 802.11ac(HT80) 5.775GHz
	Modulation Type:	802.11a(OFDM):BPSK,QPSK,16-QAM,64-QAM 802.11n(OFDM):BPSK,QPSK,16-QAM,64-QAM 802.11ac(OFDM):BPSK,QPSK,16-QAM,64-QAM
	Antenna Designation:	See Note 3
	Max.Output Power(Conducted):	19.339dBm
	Duty Cycle:	>98%
	More details of EUT technical specification, please refer to the User's Manual.	
Test Channel	Please refer to the Note 2.	
Adapter	Power supply and ADP(rating): Input: AC 100V-240V, 0.45A, 50-60Hz Output: DC 5.2V, 2A	
Battery	Battery(rating): Rated Voltage: 3.6V Charge Limit: 4.2V Capacity: 3400mAh	
Hardware version number	V01_MAIN_SCH_V1.0	
Software version number	SW_V01_YC_A_V1.7.1_180813	
Connecting I/O Port(s)	Please refer to the User's Manual	

Note:For a more detailed features description, please refer to the manufacturer's specifications or the User's Manual.



1. Operation Frequency of channel
5.745GHz-5.825GHz

Channel	Channel
149	149
151	151
153	153
157	157
159	159
161	161
165	165

Note:

In section 15.31(m), regards to the operating frequency range over 10 MHz, the Lowest frequency, the middle frequency, and the highest frequency of channel were selected to perform the test, and the selected channel see below:

Carrier Frequency Channel

5GHz:

For 802.11a/n/ac (HT20)	
Channel	Freq.(MHz)
149	5745
157	5785
165	5825

For 802.11n/ac (HT40)	
Channel	Freq.(MHz)
151	5755
159	5795

For 802.11ac (HT80)	
Channel	Freq.(MHz)
155	5775



2. KDB 662911 D01 Multiple Transmitter Output v02r01

2) Directional Gain Calculations for In-Band Measurements

a) Basic methodology with NANT transmit antennas, each with the same directional gain G_{ANT} dBi, being driven by NANT transmitter outputs of equal power. Directional gain is to be computed as follows:

(i) If any transmit signals are correlated with each other,

$$\text{Directional gain} = G_{ANT} + 10 \log(NANT) \text{ dBi}$$

(ii) If all transmit signals are completely uncorrelated with each other,

$$\text{Directional gain} = G_{ANT}$$

ANT A=-2.8 dBi

ANT B=-2.8 dBi

$$G_{ANT} + 10 \log(NANT) \text{ dBi}$$

$$\text{Directional gain} = -2.8 + 10 \log 2 = 0.21 \text{ dBi}$$

Ant.	Brand	Model Name	Ant. Type	Connector	Gain (dBi)	NOTE
A	Shadow Creator	Shadow V01	PIFA Antenna	N/A	ANT A: -2.8dBi ANT B: -2.8dBi	WLAN Ant.



2.2 DESCRIPTION OF TEST MODES

To investigate the maximum EMI emission characteristics generated from EUT, the test system was pre-scanning tested based on the consideration of following EUT operation mode or test configuration mode which possibly have effect on EMI emission level. Each of these EUT operation mode(s) or test configuration mode(s) mentioned above was evaluated respectively.

Worst Mode	Description	Data Rate
Mode 1	TX IEEE 802.11a HT20 CH149&CH157&CH165	6 Mbps
Mode 2	TX IEEE 802.11n HT20 CH149&CH157&CH165	MCS 0
Mode 3	TX IEEE 802.11ac HT20 CH149&CH157&CH165	NSS1 MCS0
Mode 4	TX IEEE 802.11ac HT40 CH151&CH159	MCS 0
Mode 5	TX IEEE 802.11ac HT40 CH151&CH159	NSS1 MCS0
Mode 6	TX IEEE 802.11ac HT80 CH155	NSS1 MCS0

- Note: (1) The measurements are performed at the highest, middle, lowest available channels.
 (2) The measurements are performed at all Bit Rate of Transmitter, the worst data was reported
 (3) We have been tested for all available U.S. voltage and frequencies (For 120V, 50/60Hz and 240V, 50/60Hz) for which the device is capable of operation, and the worst case of 120V/60Hz is shown in the report

AC Conducted Emission

Test Case	
AC Conducted Emission	Mode 7: Keeping TX + WLAN Link

2.3 BLOCK DIGRAM SHOWING THE CONFIGURATION OF SYSTEM TESTED

Radiation Test Set

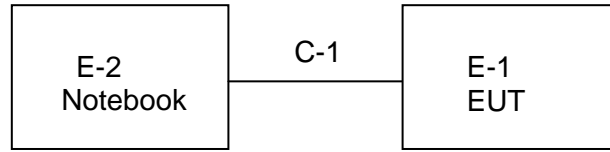

conduction Test Set

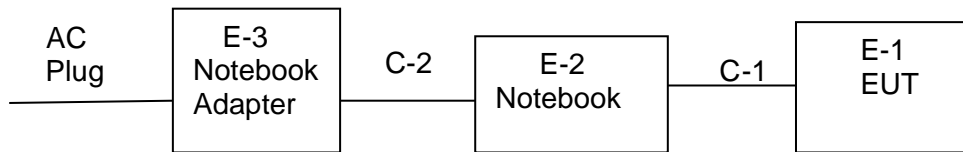

2.4 DESCRIPTION OF SUPPORT UNITS(CONDUCTED MODE)

The EUT has been tested as an independent unit together with other necessary accessories or support units. The following support units or accessories were used to form a representative test configuration during the tests.

Item	Equipment	Mfr/Brand	Model/Type No.	Series No.	Note
E-2	Notebook	HP	500-320cx	N/A	N/A
E-3	Notebook Adapter	HP	HSTNN-CA15	N/A	N/A

Item	Shielded Type	Ferrite Core	Length	Note
C-1	USB Cable	NO	100cm	N/A
C-2	DC Cable	NO	110cm	N/A

Note:

- (1) The support equipment was authorized by Declaration of Confirmation.
- (2) For detachable type I/O cable should be specified the length in cm in 『Length』 column.
- (3) “YES” is means “shielded” “with core”; “NO” is means “unshielded” “without core”.

2.5 EQUIPMENTS LIST FOR ALL TEST ITEMS

Radiation Test equipment

Kind of Equipment	Manufacturer	Type No.	Serial No.	Last calibration	Calibrated until
EMI Test Receiver	R&S	ESCI	102086	2017.10.15	2018.10.14
Bilog Antenna	TESEQ	CBL6111D	34678	2017.11.02	2018.11.01
Horn Antenna	Schwarzbeck	BBHA 9120D	9120D-1343	2017.10.27	2018.10.26
Horn Antenna	Schwarzbeck	BBHA 9170	9170-0741	2016.03.06	2019.03.03
PreAmplifier	Agilent	8449B	60538	2017.10.15	2018.10.14
Passive Loop (9K--30MHz)	ZHNAN	ZN3090C	16035	2018.03.11	2019.03.10
Low frequency cable	EM	R01	N/A	NCR	NCR
High frequency cable	SCHWARZBECK	AK9515H	SN-96286/96287	NCR	NCR
EMI Test Receiver	R&S	ESW44	101535	2018.07.10	2019.07.09

Conduction Test equipment

Kind of Equipment	Manufacturer	Type No.	Serial No.	Last calibration	Calibrated until
Test Receiver	R&S	ESCI	101427	2017.10.15	2018.10.14
LISN	R&S	ENV216	101242	2017.10.15	2018.10.14
Conduction Cable	EM	C01	N/A	2018.03.11	2019.03.10

RF Connected Test

Kind of Equipment	Manufacturer	Type No.	Serial No.	Last calibration	Calibrated until
USB RF power sensor	DARE	RPR3006W	15I00041SNO03	2017.10.15	2018.10.14
Spectrum Analyzer	Agilent	N9020A	MY51110105	2018.03.08	2019.03.07
Signal Analyzer	Agilent	N9020A	MY49100060	2017.10.15	2018.10.14



3. EMC EMISSION TEST

3.1 CONDUCTED EMISSION MEASUREMENT

3.1.1 POWER LINE CONDUCTED EMISSION Limits (Frequency Range 150KHz-30MHz)

FREQUENCY (MHz)	Class B (dBuV)		Standard
	Quasi-peak	Average	
0.15 -0.5	66 - 56 *	56 - 46 *	CISPR
0.50 -5.0	56.00	46.00	CISPR
5.0 -30.0	60.00	50.00	CISPR

0.15 -0.5	66 - 56 *	56 - 46 *	FCC
0.50 -5.0	56.00	46.00	FCC
5.0 -30.0	60.00	50.00	FCC

Note:

- (1) The tighter limit applies at the band edges.
- (2) The limit of " * " marked band means the limitation decreases linearly with the logarithm of the frequency in the range.

The following table is the setting of the receiver

Receiver Parameters	Setting
Attenuation	10 dB
Start Frequency	0.15 MHz
Stop Frequency	30 MHz
IF Bandwidth	9 kHz

3.1.2 TEST PROCEDURE

- a. The EUT was placed 0.8 meters from the horizontal ground plane with EUT being connected to the power mains through a line impedance stabilization network (LISN). All other support equipments powered from additional LISN(s). The LISN provide 50 Ohm/ 50uH of coupling impedance for the measuring instrument.
- b. Interconnecting cables that hang closer than 40 cm to the ground plane shall be folded back and forth in the center forming a bundle 30 to 40 cm long.
- c. I/O cables that are not connected to a peripheral shall be bundled in the center. The end of the cable may be terminated, if required, using the correct terminating impedance. The overall length shall not exceed 1 m.
- d. LISN at least 80 cm from nearest part of EUT chassis.
- e. For the actual test configuration, please refer to the related Item –EUT Test Photos.

3.1.3 DEVIATION FROM TEST STANDARD

No deviation

3.1.4 TEST SETUP

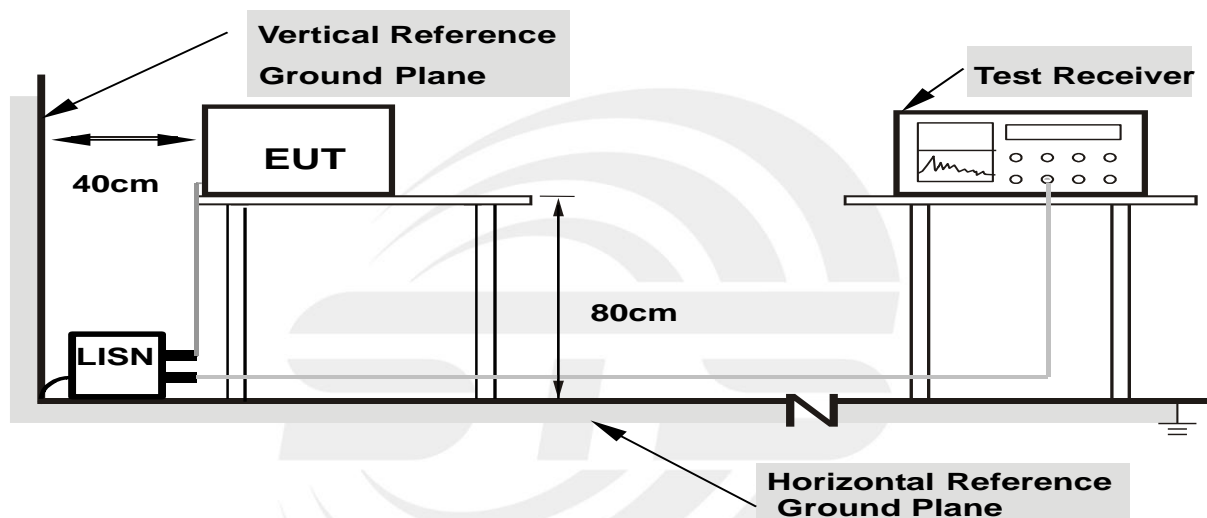

- Note: 1.Support units were connected to second LISN.**
2.Both of LISNs (AMN) are 80 cm from EUT and at least 80 cm from other units and other metal planes

3.1.5 EUT OPERATING CONDITIONS

The EUT was configured for testing in a typical fashion (as a customer would normally use it). The EUT has been programmed to continuously transmit during test. This operating condition was tested and used to collect the included data.



3.1.6 TEST RESULTS

Temperature:	25.5 °C	Relative Humidity:	66%
Test Voltage:	AC 120V/60Hz	Phase:	L
Test Mode :	Mode 7		

Frequency (MHz)	Reading (dBUV)	Correct Factor(dB)	Result (dBUV)	Limit (dBUV)	Margin (dB)	Remark
0.1580	49.51	9.79	59.30	65.57	-6.27	QP
0.1580	32.00	9.79	41.79	55.57	-13.78	AVG
0.2180	38.13	9.86	47.99	62.89	-14.90	QP
0.2180	19.98	9.86	29.84	52.89	-23.05	AVG
0.3260	30.41	10.18	40.59	59.55	-18.96	QP
0.3260	14.30	10.18	24.48	49.55	-25.07	AVG
0.4740	26.77	10.03	36.80	56.44	-19.64	QP
0.4740	10.33	10.03	20.36	46.44	-26.08	AVG
3.5780	27.89	9.82	37.71	56.00	-18.29	QP
3.5780	12.24	9.82	22.06	46.00	-23.94	AVG
9.2740	30.75	10.13	40.88	60.00	-19.12	QP
9.2740	19.94	10.13	30.07	50.00	-19.93	AVG

Remark:

1. Margin = Result (Result =Reading + Factor) –Limit

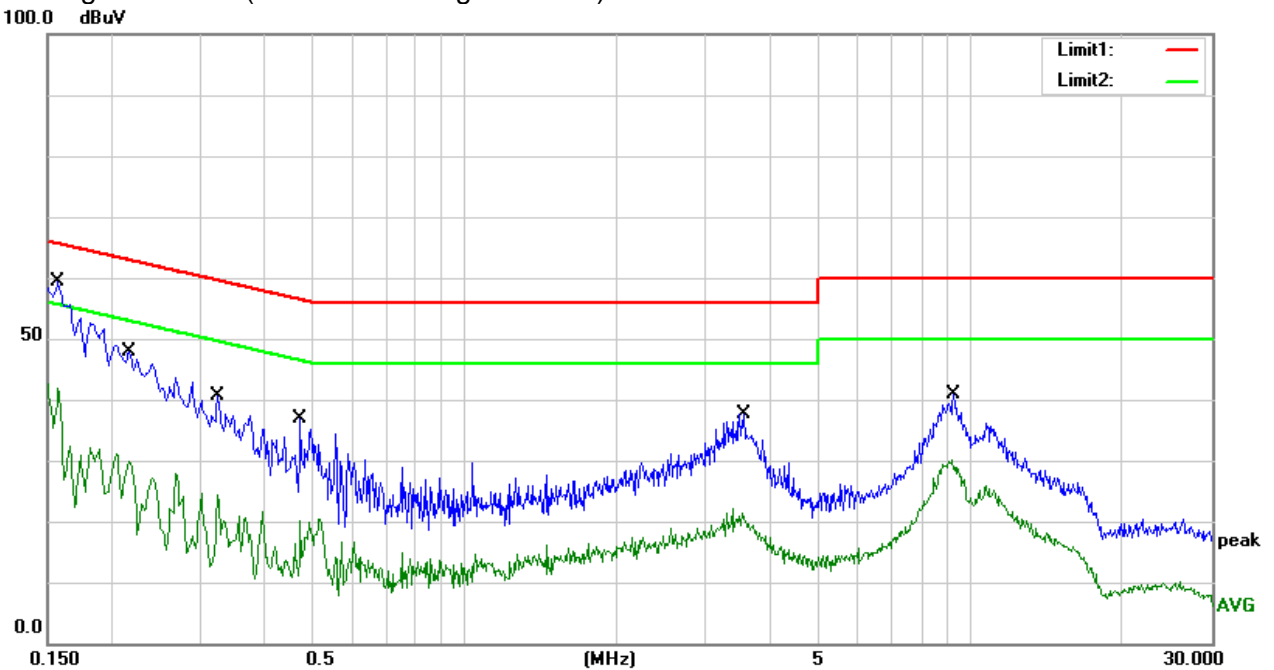



Temperature:	25.5 °C	Relative Humidity:	66%
Test Voltage :	AC 120V/60Hz	Phase:	N
Test Mode :	Mode 10		

Frequency (MHz)	Reading (dBUV)	Correct Factor(dB)	Result (dBUV)	Limit (dBUV)	Margin (dB)	Remark
0.1620	48.59	9.78	58.37	65.36	-6.99	QP
0.1620	31.12	9.78	40.90	55.36	-14.46	AVG
0.2100	37.90	9.91	47.81	63.21	-15.40	QP
0.2100	19.89	9.91	29.80	53.21	-23.41	AVG
0.3220	29.90	10.22	40.12	59.66	-19.54	QP
0.3220	13.81	10.22	24.03	49.66	-25.63	AVG
0.5100	24.89	9.97	34.86	56.00	-21.14	QP
0.5100	11.22	9.97	21.19	46.00	-24.81	AVG
3.4180	27.71	9.92	37.63	56.00	-18.37	QP
3.4180	11.68	9.92	21.60	46.00	-24.40	AVG
9.0940	30.10	9.91	40.01	60.00	-19.99	QP
9.0940	20.21	9.91	30.12	50.00	-19.88	AVG

Remark:

1. Margin = Result (Result =Reading + Factor)-Limit

100.0 dBUV

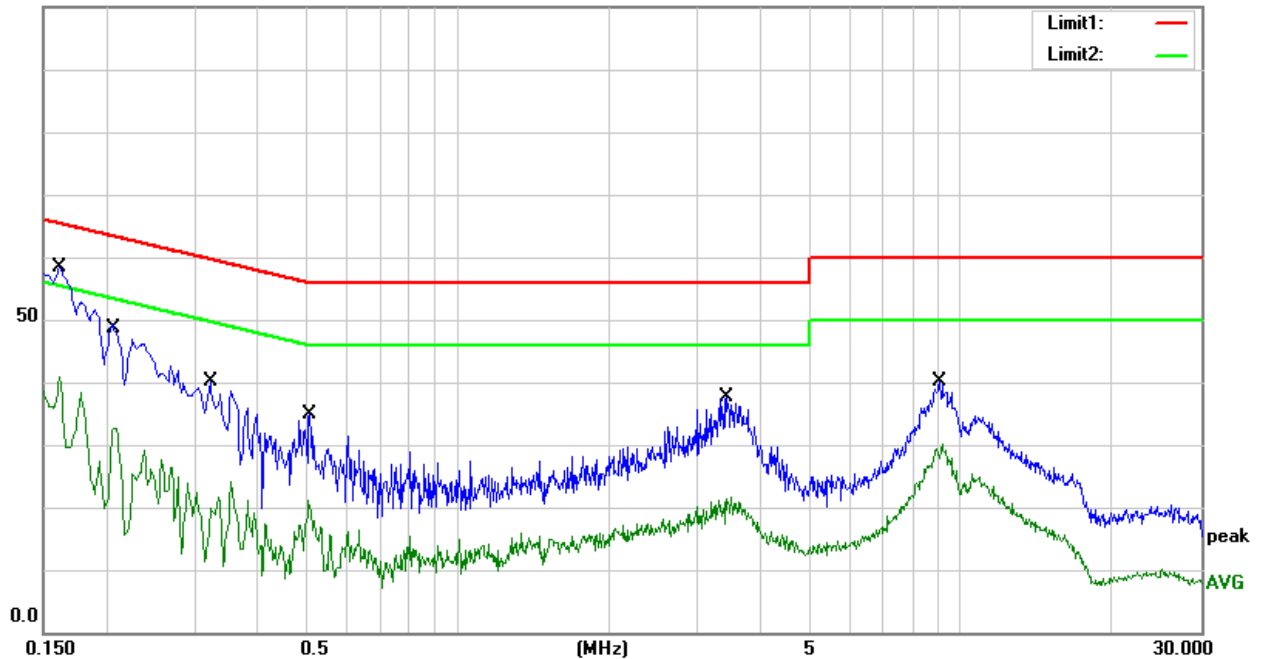



3.2 RADIATED EMISSION AND (BANDEDGE) MEASUREMENT

3.2.1 RADIATED EMISSION LIMITS (Frequency Range 9kHz-1000MHz)

In case the emission fall within the restricted band specified on 15.407(b)7& 15.205/209(a), then the (a); limit in the table below has to be followed.

Frequencies (MHz)	Field Strength (microrvolts/meter)	Measurement Distance (meters)
0.009~0.490	2400/F(KHz)	300
0.490~1.705	24000/F(KHz)	30
1.705~30.0	30	30
30~88	100	3
88~216	150	3
216~960	200	3
Above 960	500	3

LIMITS OF RADIATED EMISSION MEASUREMENT (Above 1000MHz)

FREQUENCY (MHz)	Class B (dBuV/m) (at 3M)	
	PEAK	AVERAGE
Above 1000	74	54

Notes:

- (1) The limit for radiated test was performed according to FCC PART 15E.
- (2) The tighter limit applies at the band edges.
- (3) Emission level (dBuV/m)=20log Emission level (uV/m).

Spectrum Parameter	Setting
Attenuation	Auto
Detector	Peak
Start Frequency	1000 MHz(Peak/AV)
Stop Frequency	10th carrier harmonic(Peak/AV)
RB / VB (emission in restricted band)	1 MHz / 1 MHz, AV=1 MHz /3 MHz

For Band edge

Spectrum Parameter	Setting
Detector	Peak
RB / VB (emission in restricted band)	1 MHz / 1 MHz, AV=1 MHz /3 MHz



Receiver Parameter	Setting
Attenuation	Auto
Start ~ Stop Frequency	9kHz~90kHz / RB 200Hz for PK & AV
Start ~ Stop Frequency	90kHz~110kHz / RB 200Hz for QP
Start ~ Stop Frequency	110kHz~490kHz / RB 200Hz for PK & AV
Start ~ Stop Frequency	490kHz~30MHz / RB 9kHz for QP
Start ~ Stop Frequency	30MHz~1000MHz / RB 120kHz for QP

3.2.2 TEST PROCEDURE

- a. The measuring distance of at 3 m shall be used for measurements at frequency 0.009MHz up to 1GHz. For frequencies above 1GHz, any suitable measuring distance may be used.
- b. The EUT was placed on the top of a rotating table 0.8 meters(above 1GHz is 1.5 m) above the ground at a 3 meter anechoic chamber. The table was rotated 360 degrees to determine the position of the highest radiation.
- c. The height of the equipment shall be 0.8 m(above 1GHz is 1.5 m); the height of the test antenna shall vary between 1 m to 4 m. Horizontal and vertical polarizations of the antenna are set to make the measurement
- d. The initial step in collecting conducted emission data is a spectrum analyzer peak detector mode pre-scanning the measurement frequency range. Significant peaks are then marked and then Quasi Peak detector mode re-measured.
- e. If the Peak Mode measured value compliance with and lower than Quasi Peak Mode Limit, the EUT shall be deemed to meet QP Limits and then no additional QP Mode measurement performed.
- f. For the actual test configuration, please refer to the related Item –EUT Test Photos.

Note:

Both horizontal and vertical antenna polarities were tested and performed test to three orthogonal axis. The worst case emissions were reported

3.2.3 DEVIATION FROM TEST STANDARD

No deviation

3.2.4 TEST SETUP

(A) Radiated Emission Test-Up Frequency Below 30MHz

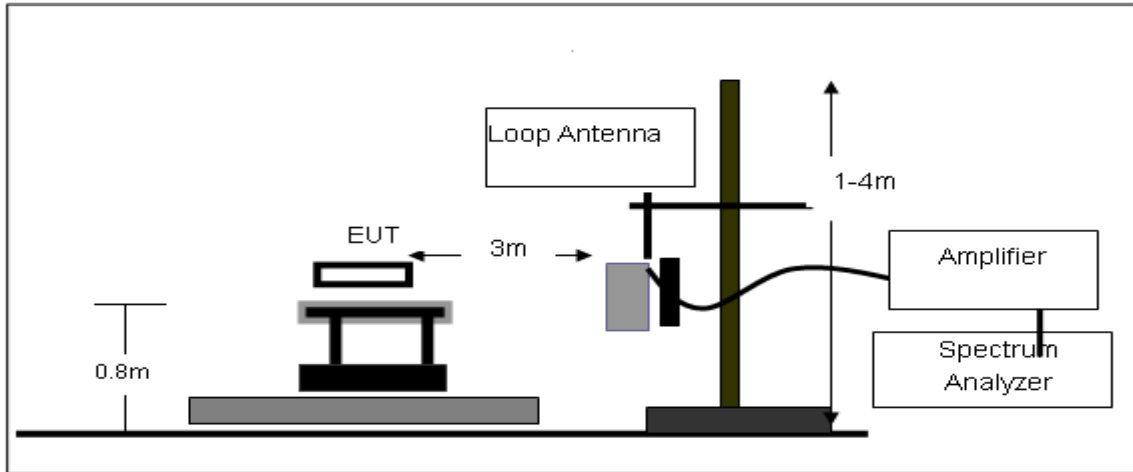

(B) Radiated Emission Test-Up Frequency 30MHz~1GHz

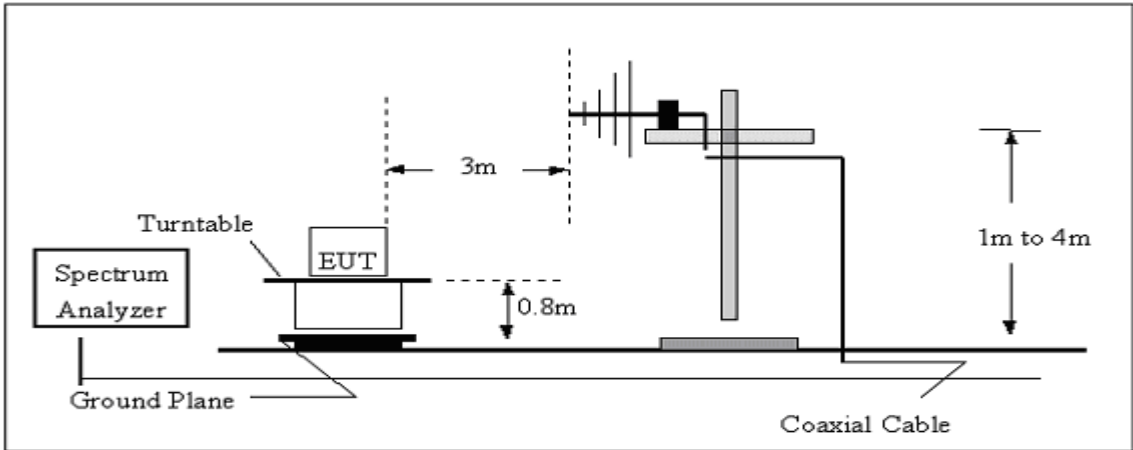

(C) Radiated Emission Test-Up Frequency Above 1GHz

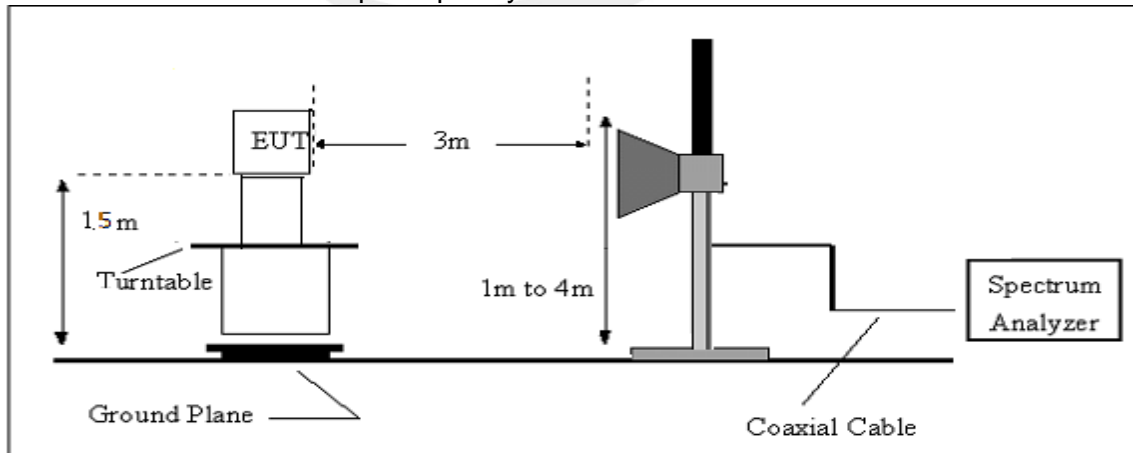

3.2.5 EUT OPERATING CONDITIONS

The EUT tested system was configured as the statements of 2.4 Unless otherwise a special operating condition is specified in the follows during the testing.



3.2.6 FIELD STRENGTH CALCULATION

The field strength is calculated by adding the Antenna Factor and Cable Factor and subtracting the Amplifier Gain and Duty Cycle Correction Factor (if any) from the measured reading. The basic equation with a sample calculation is as follows:

$$FS = RA + AF + CL - AG$$

Where

FS = Field Strength

CL = Cable Attenuation Factor (Cable Loss)

RA = Reading Amplitude

AG = Amplifier Gain

AF = Antenna Factor

For example

Frequency (MHz)	FS (dB μ V/m)	RA (dB μ V/m)	AF (dB)	CL (dB)	AG (dB)	Factor (dB)
300	40	58.1	12.2	1.6	31.9	-18.1

$$\text{Factor} = \text{AF} + \text{CL} - \text{AG}$$

3.2.7 TEST RESULTS (Between 9KHz – 30 MHz)

Temperature:	26.4 °C	Relative Humidity:	55%
Test Mode :	TX Mode	Test Voltage :	DC 3.6V
Polarization :	--		

Freq. (MHz)	Reading (dB μ V/m)	Limit (dB μ V/m)	Margin (dB)	State P/F
--	--	--	--	PASS
--	--	--	--	PASS

Note:

The amplitude of spurious emissions which are attenuated by more than 20dB below the permissible value has no need to be reported.

Distance extrapolation factor = 40 log (specific distance/test distance)(dB);

Limit line = specific limits(dB μ v) + distance extrapolation factor.



3.2.8 TEST RESULTS (Between 30MHz – 1GHz)

Temperature	26.4 °C	Relative Humidity	55%
Test Voltage	DC 3.6V	Polarization	Horizontal
Test Mode	Mode 1-6(Mode 2 worst mode)		

Frequency (MHz)	Reading (dBuV)	Correct Factor(dB/m)	Result (dBuV/m)	Limit (dBuV/m)	Margin (dB)	Remark
31.6202	33.29	-12.02	21.27	40.00	-18.73	QP
68.8721	44.53	-24.13	20.40	40.00	-19.60	QP
117.3602	35.52	-17.86	17.66	43.50	-25.84	QP
259.2336	34.28	-15.15	19.13	46.00	-26.87	QP
528.2458	50.13	-8.09	42.04	46.00	-3.96	QP
909.6666	34.71	-1.93	32.78	46.00	-13.22	QP

Remark:

1. Margin = Result (Result =Reading + Factor)–Limit

80.0 dBuV/m

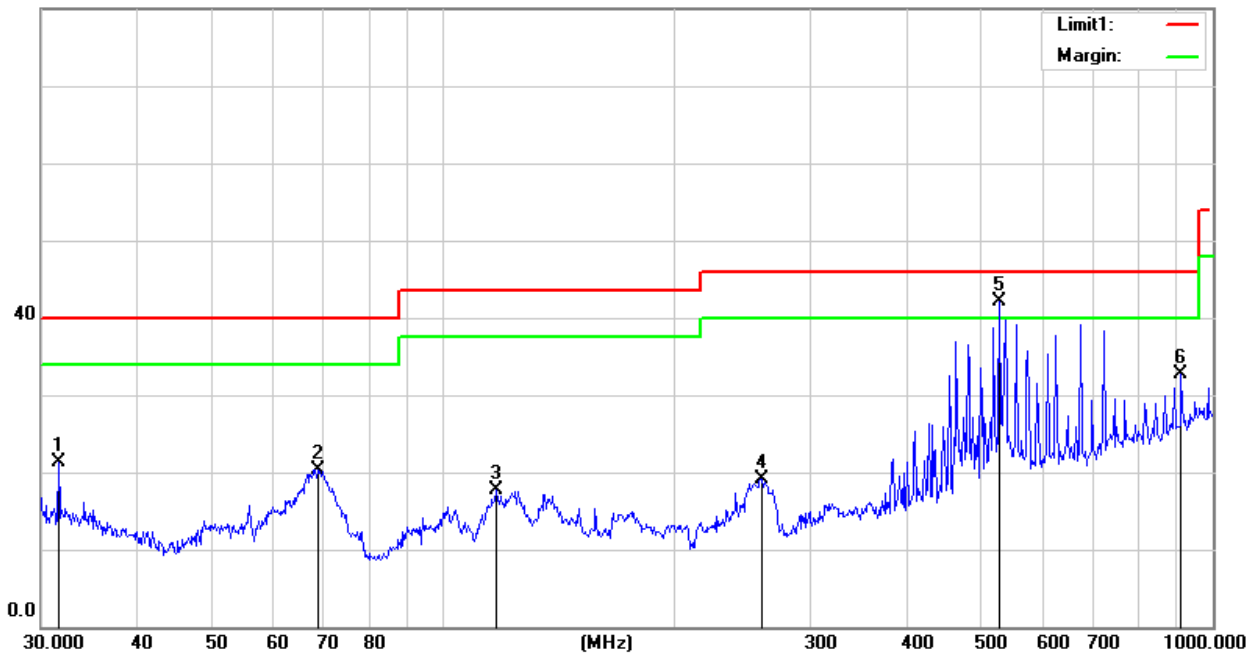



Temperature	26.4 °C	Relative Humidity	55%
Test Voltage	DC 3.6V	Polarization	Vertical
Test Mode	Mode 1-6(Mode 2 worst mode)		

Frequency (MHz)	Reading (dBuV)	Correct Factor(dB/m)	Result (dBuV/m)	Limit (dBuV/m)	Margin (dB)	Remark
34.6385	33.12	-13.57	19.55	40.00	-20.45	QP
68.8721	42.39	-24.13	18.26	40.00	-21.74	QP
122.8340	39.03	-17.65	21.38	43.50	-22.12	QP
263.8190	32.32	-15.22	17.10	46.00	-28.90	QP
574.6258	48.56	-6.67	41.89	46.00	-4.11	QP
768.7481	41.50	-3.39	38.11	46.00	-7.89	QP

Remark:

1. Margin = Result (Result =Reading + Factor)-Limit

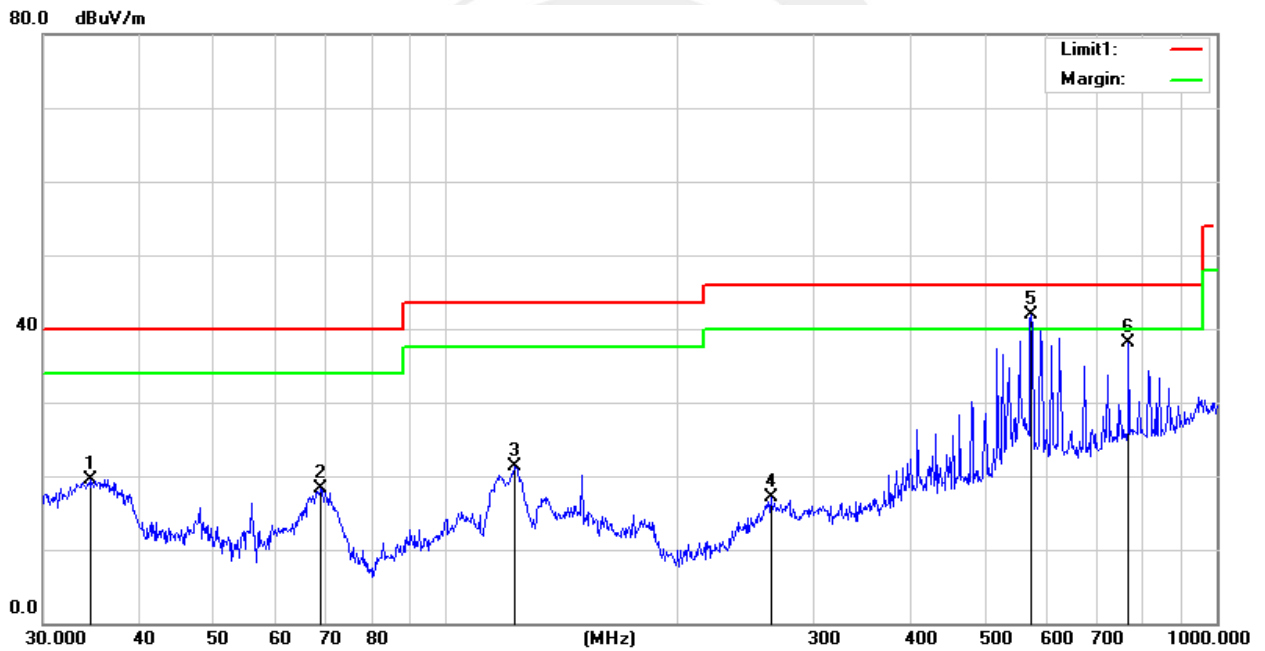



3.2.9 TEST RESULTS (Above 1000 MHz)
Band IV(5.725-5.850) GHz

Band IV(5.725-5.85) GHz										
Frequency (MHz)	Reading	Amplifier	Loss	Antenna Factor	Orrected Factor	Emission Level	Limit (dBuV/m)	Margin	Detector	Comment
	(dBuV)	(dB)	(dB)	(dB/m)	(dB)	(dBuV/m)		(dB)		
Low Channel (802.11 n20/ 5745 MHz)										
3250.82	44.84	44.70	6.70	28.20	-9.80	35.04	74.00	-38.96	PK	Vertical
3250.82	41.05	44.70	6.70	28.20	-9.80	31.25	54.00	-22.75	AV	Vertical
3264.63	44.20	44.70	6.70	28.20	-9.80	34.40	74.00	-39.60	PK	Horizontal
3264.63	41.60	44.70	6.70	28.20	-9.80	31.80	54.00	-22.20	AV	Horizontal
3995.38	39.78	44.20	7.90	29.70	-6.60	33.18	74.00	-40.82	PK	Vertical
3995.38	36.61	44.20	7.90	29.70	-6.60	30.01	54.00	-23.99	AV	Vertical
3998.54	39.24	44.20	7.90	29.70	-6.60	32.64	74.00	-41.36	PK	Horizontal
3998.54	36.48	44.20	7.90	29.70	-6.60	29.88	54.00	-24.12	AV	Horizontal
7224.31	37.86	43.50	11.40	35.50	3.40	41.26	74.00	-32.74	PK	Vertical
7224.31	33.99	43.50	11.40	35.50	3.40	37.39	54.00	-16.61	AV	Vertical
7226.05	37.74	43.50	11.40	35.50	3.40	41.14	74.00	-32.86	PK	Horizontal
7226.05	34.20	43.50	11.40	35.50	3.40	37.60	54.00	-16.40	AV	Horizontal
10507.12	38.88	44.50	13.90	38.80	8.20	47.08	74.00	-26.92	PK	Vertical
10507.12	35.91	44.50	13.90	38.80	8.20	44.11	54.00	-9.89	AV	Vertical
10506.37	39.41	44.50	13.90	38.80	8.20	47.61	74.00	-26.39	PK	Horizontal
10506.37	36.61	44.50	13.90	38.80	8.20	44.81	54.00	-9.19	AV	Horizontal
11490.39	33.90	43.60	14.30	39.50	10.20	44.10	74.00	-29.90	PK	Vertical
11490.39	29.77	43.60	14.30	39.50	10.20	39.97	54.00	-14.03	AV	Vertical
11490.23	33.00	43.60	14.30	39.50	10.20	43.20	74.00	-30.80	PK	Horizontal
11490.23	30.05	43.60	14.30	39.50	10.20	40.25	54.00	-13.75	AV	Horizontal
13285.53	31.94	42.60	15.90	38.90	12.20	44.14	74.00	-29.86	PK	Vertical
13285.53	29.94	42.60	15.90	38.90	12.20	42.14	54.00	-11.86	AV	Vertical
13295.44	32.81	42.60	15.90	38.90	12.20	45.01	74.00	-28.99	PK	Horizontal
13295.44	29.20	42.60	15.90	38.90	12.20	41.40	54.00	-12.60	AV	Horizontal



Mid Channel (802.11 n20/ 5785 MHz)										
3264.55	45.04	44.70	6.70	28.20	-9.80	35.24	74.00	-38.76	PK	Vertical
3264.55	42.07	44.70	6.70	28.20	-9.80	32.27	54.00	-21.73	AV	Vertical
3252.12	44.27	44.70	6.70	28.20	-9.80	34.47	74.00	-39.53	PK	Horizontal
3252.12	41.16	44.70	6.70	28.20	-9.80	31.36	54.00	-22.64	AV	Horizontal
3994.51	39.93	44.20	7.90	29.70	-6.60	33.33	74.00	-40.67	PK	Vertical
3994.51	36.38	44.20	7.90	29.70	-6.60	29.78	54.00	-24.22	AV	Vertical
3998.79	39.89	44.20	7.90	29.70	-6.60	33.29	74.00	-40.71	PK	Horizontal
3998.79	36.16	44.20	7.90	29.70	-6.60	29.56	54.00	-24.44	AV	Horizontal
7218.96	37.71	43.50	11.40	35.50	3.40	41.11	74.00	-32.89	PK	Vertical
7218.96	34.60	43.50	11.40	35.50	3.40	38.00	54.00	-16.00	AV	Vertical
7230.58	37.06	43.50	11.40	35.50	3.40	40.46	74.00	-33.54	PK	Horizontal
7230.58	34.29	43.50	11.40	35.50	3.40	37.69	54.00	-16.31	AV	Horizontal
10596.57	40.11	44.50	13.80	38.80	8.10	48.21	74.00	-25.79	PK	Vertical
10596.57	36.00	44.50	13.80	38.80	8.10	44.10	54.00	-9.90	AV	Vertical
10581.96	39.59	44.50	13.80	38.80	8.10	47.69	74.00	-26.31	PK	Horizontal
10581.96	37.15	44.50	13.80	38.80	8.10	45.25	54.00	-8.75	AV	Horizontal
11570.00	33.94	43.60	14.30	39.50	10.20	44.14	74.00	-29.86	PK	Vertical
11570.00	30.75	43.60	14.30	39.50	10.20	40.95	54.00	-13.05	AV	Vertical
11570.19	33.57	43.60	14.30	39.50	10.20	43.77	74.00	-30.23	PK	Horizontal
11570.19	30.49	43.60	14.30	39.50	10.20	40.69	54.00	-13.31	AV	Horizontal
13284.82	31.81	42.60	15.90	38.90	12.20	44.01	74.00	-29.99	PK	Vertical
13284.82	28.98	42.60	15.90	38.90	12.20	41.18	54.00	-12.82	AV	Vertical
13283.71	32.43	42.60	15.90	38.90	12.20	44.63	74.00	-29.37	PK	Horizontal
13283.71	28.69	42.60	15.90	38.90	12.20	40.89	54.00	-13.11	AV	Horizontal



Mid Channel (802.11 n20/ 5825 MHz)										
3263.58	43.89	44.70	6.70	28.20	-9.80	34.09	74.00	-39.91	PK	Vertical
3263.58	40.95	44.70	6.70	28.20	-9.80	31.15	54.00	-22.85	AV	Vertical
3249.07	44.29	44.70	6.70	28.20	-9.80	34.49	74.00	-39.51	PK	Horizontal
3249.07	41.81	44.70	6.70	28.20	-9.80	32.01	54.00	-21.99	AV	Horizontal
3988.49	39.79	44.20	7.90	29.70	-6.60	33.19	74.00	-40.81	PK	Vertical
3988.49	37.07	44.20	7.90	29.70	-6.60	30.47	54.00	-23.53	AV	Vertical
3991.20	39.49	44.20	7.90	29.70	-6.60	32.89	74.00	-41.11	PK	Horizontal
3991.20	35.68	44.20	7.90	29.70	-6.60	29.08	54.00	-24.92	AV	Horizontal
7224.86	36.82	43.50	11.40	35.50	3.40	40.22	74.00	-33.78	PK	Vertical
7224.86	34.46	43.50	11.40	35.50	3.40	37.86	54.00	-16.14	AV	Vertical
7231.84	36.54	43.50	11.40	35.50	3.40	39.94	74.00	-34.06	PK	Horizontal
7231.84	33.93	43.50	11.40	35.50	3.40	37.33	54.00	-16.67	AV	Horizontal
10621.03	38.79	44.50	13.80	38.80	8.10	46.89	74.00	-27.11	PK	Vertical
10621.03	36.44	44.50	13.80	38.80	8.10	44.54	54.00	-9.46	AV	Vertical
10640.21	40.03	44.50	13.80	38.80	8.10	48.13	74.00	-25.87	PK	Horizontal
10640.21	35.80	44.50	13.80	38.80	8.10	43.90	54.00	-10.10	AV	Horizontal
11650.30	34.15	43.60	14.30	39.50	10.20	44.35	74.00	-29.65	PK	Vertical
11650.30	30.71	43.60	14.30	39.50	10.20	40.91	54.00	-13.09	AV	Vertical
11650.25	32.69	43.60	14.30	39.50	10.20	42.89	74.00	-31.11	PK	Horizontal
11650.25	31.12	43.60	14.30	39.50	10.20	41.32	54.00	-12.68	AV	Horizontal
13288.16	31.90	42.70	18.00	37.10	12.40	44.30	74.00	-29.70	PK	Vertical
13288.16	29.74	42.70	18.00	37.10	12.40	42.14	54.00	-11.86	AV	Vertical
13291.65	31.76	42.70	18.00	37.10	12.40	44.16	74.00	-29.84	PK	Horizontal
13291.65	29.42	42.70	18.00	37.10	12.40	41.82	54.00	-12.18	AV	Horizontal

Remark:

1. Factor = Antenna Factor + Cable Loss – Pre-amplifier.
2. Scan with 802.11a, 802.11n (HT-20), 802.11n (HT-40), 802.11ac (HT-20), 802.11ac (HT-40), 802.11ac (HT-80) the worst case is 802.11n (HT-20).
3. The frequency emission of peak points that did not show above the forms are at least 20dB below the limit, the frequency emission is mainly from the environment noise.
4. Pre-scan both the SISO and MIMO mode, only the worst-case results were reported.



3.2.10 Band Edge
Band IV(5.725-5.85 GHz)

Band IV(5.725-5.85 GHz)										
Frequency	Meter Reading	Amplifier	Loss	Antenna Factor	Orrected Factor	Emission Level	Limits	Margin	Detector	Comment
(MHz)	(dBμV)	(dB)	(dB)	(dB/m)	(dB)	(dBμV/m)	(dBμV/m)	(dB)	Type	
802.11a BW20MHz										
5725	39.22	44.20	10.00	32.00	-2.20	37.02	74	-36.98	Peak	Vertical
5725	31.46	44.20	10.00	32.00	-2.20	29.26	54	-24.74	AVG	Vertical
5725	39.59	44.20	10.00	32.00	-2.20	37.39	74	-36.61	Peak	Horizontal
5725	29.50	44.20	10.00	32.00	-2.20	27.30	54	-26.70	AVG	Horizontal
5850	46.86	44.20	10.20	32.00	-2.00	44.86	74	-29.14	Peak	Vertical
5850	27.63	44.20	10.20	32.00	-2.00	25.63	54	-28.37	AVG	Vertical
5850	38.36	44.20	10.20	32.00	-2.00	36.36	74	-37.64	Peak	Horizontal
5850	31.90	44.20	10.20	32.00	-2.00	29.90	54	-24.10	AVG	Horizontal
802.11n BW20MHz										
5725	39.63	44.20	10.00	32.00	-2.20	37.43	74	-36.57	Peak	Vertical
5725	31.74	44.20	10.00	32.00	-2.20	29.54	54	-24.46	AVG	Vertical
5725	40.01	44.20	10.00	32.00	-2.20	37.81	74	-36.19	Peak	Horizontal
5725	29.05	44.20	10.00	32.00	-2.20	26.85	54	-27.15	AVG	Horizontal
5850	42.89	44.20	10.20	32.00	-2.00	40.89	74	-33.11	Peak	Vertical
5850	30.95	44.20	10.20	32.00	-2.00	28.95	54	-25.05	AVG	Vertical
5850	38.72	44.20	10.20	32.00	-2.00	36.72	74	-37.28	Peak	Horizontal
5850	27.91	44.20	10.20	32.00	-2.00	25.91	54	-28.09	AVG	Horizontal
802.11n BW40MHz										
5725	39.14	44.20	10.00	32.00	-2.20	36.94	74	-37.06	Peak	Vertical
5725	29.47	44.20	10.00	32.00	-2.20	27.27	54	-26.73	AVG	Vertical
5725	38.81	44.20	10.00	32.00	-2.20	36.61	74	-37.39	Peak	Horizontal
5725	29.82	44.20	10.00	32.00	-2.20	27.62	54	-26.38	AVG	Horizontal
5850	45.34	44.20	10.20	32.00	-2.00	43.34	74	-30.66	Peak	Vertical
5850	31.66	44.20	10.20	32.00	-2.00	29.66	54	-24.34	AVG	Vertical
5850	40.83	44.20	10.20	32.00	-2.00	38.83	74	-35.17	Peak	Horizontal
5850	31.02	44.20	10.20	32.00	-2.00	29.02	54	-24.98	AVG	Horizontal



802.11ac BW20MHz										
5725	41.28	44.20	10.00	32.00	-2.20	39.08	74	-34.92	Peak	Vertical
5725	29.30	44.20	10.00	32.00	-2.20	27.10	54	-26.90	AVG	Vertical
5725	39.06	44.20	10.00	32.00	-2.20	36.86	74	-37.14	Peak	Horizontal
5725	29.88	44.20	10.00	32.00	-2.20	27.68	54	-26.32	AVG	Horizontal
5850	46.47	44.20	10.20	32.00	-2.00	44.47	74	-29.53	Peak	Vertical
5850	28.73	44.20	10.20	32.00	-2.00	26.73	54	-27.27	AVG	Vertical
5850	39.09	44.20	10.20	32.00	-2.00	37.09	74	-36.91	Peak	Horizontal
5850	31.27	44.20	10.20	32.00	-2.00	29.27	54	-24.73	AVG	Horizontal
802.11ac BW40MHz										
5725	39.89	44.20	10.00	32.00	-2.20	37.69	74	-36.31	Peak	Vertical
5725	27.97	44.20	10.00	32.00	-2.20	25.77	54	-28.23	AVG	Vertical
5725	42.25	44.20	10.00	32.00	-2.20	40.05	74	-33.95	Peak	Horizontal
5725	29.72	44.20	10.00	32.00	-2.20	27.52	54	-26.48	AVG	Horizontal
5850	46.36	44.20	10.20	32.00	-2.00	44.36	74	-29.64	Peak	Vertical
5850	28.17	44.20	10.20	32.00	-2.00	26.17	54	-27.83	AVG	Vertical
5850	39.59	44.20	10.20	32.00	-2.00	37.59	74	-36.41	Peak	Horizontal
5850	32.06	44.20	10.20	32.00	-2.00	30.06	54	-23.94	AVG	Horizontal
802.11ac BW80MHz										
5725	41.97	44.20	10.00	32.00	-2.20	39.77	74	-34.23	Peak	Vertical
5725	27.85	44.20	10.00	32.00	-2.20	25.65	54	-28.35	AVG	Vertical
5725	41.04	44.20	10.00	32.00	-2.20	38.84	74	-35.16	Peak	Horizontal
5725	29.48	44.20	10.00	32.00	-2.20	27.28	54	-26.72	AVG	Horizontal
5850	46.38	44.20	10.20	32.00	-2.00	44.38	74	-29.62	Peak	Vertical
5850	30.00	44.20	10.20	32.00	-2.00	28.00	54	-26.00	AVG	Vertical
5850	41.25	44.20	10.20	32.00	-2.00	39.25	74	-34.75	Peak	Horizontal
5850	32.05	44.20	10.20	32.00	-2.00	30.05	54	-23.95	AVG	Horizontal

4. CONDUCTED SPURIOUS EMISSIONS AND BANDEDGE

4.1 APPLIED PROCEDURES / LIMIT

Undesirable emission limits. Except as shown in paragraph (b)(7) of this section, the maximum emissions outside of the frequency bands of operation shall be attenuated in accordance with the following limits:

- (1) For transmitters operating in the 5.15-5.25 GHz band: All emissions outside of the 5.15-5.35 GHz band shall not exceed an e.i.r.p. of -27 dBm/MHz.
- (2) For transmitters operating in the 5.25-5.35 GHz band: All emissions outside of the 5.15-5.35 GHz band shall not exceed an e.i.r.p. of -27 dBm/MHz.
- (3) For transmitters operating in the 5.47-5.725 GHz band: All emissions outside of the 5.47-5.725 GHz band shall not exceed an e.i.r.p. of -27 dBm/MHz.
- (4) For transmitters operating in the 5.725-5.85 GHz band:
 - (i) All emissions shall be limited to a level of -27 dBm/MHz at 75 MHz or more above or below the band edge increasing linearly to 10 dBm/MHz at 25 MHz above or below the band edge, and from 25 MHz above or below the band edge increasing linearly to a level of 15.6 dBm/MHz at 5 MHz above or below the band edge, and from 5 MHz above or below the band edge increasing linearly to a level of 27 dBm/MHz at the band edge.

4.1.1 TEST PROCEDURE

Spectrum Parameter	Setting
Detector	Peak
Start/Stop Frequency	30 MHz to 10th carrier harmonic
RB / VB (emission in restricted band)	1000 KHz/3000 KHz
Trace-Mode:	Max hold

For Band edge

Spectrum Parameter	Setting
Detector	Peak
Start/Stop Frequency	Lower Band Edge: 5700 to 5725 MHz Upper Band Edge: 5850 to 5870 MHz
RB / VB (emission in restricted band)	1000 KHz/3000 KHz
Trace-Mode:	Max hold

4.1.2 DEVIATION FROM STANDARD

No deviation.

4.1.3 TEST SETUP

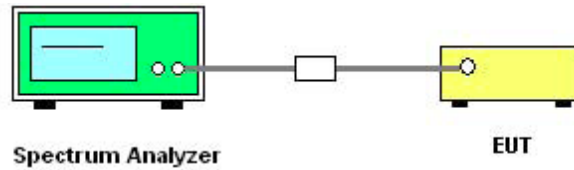

The EUT which is powered by the Battery, is coupled to the Spectrum Analyzer; the RF load attached to the EUT antenna terminal is 50Ohm; the path loss as the factor is calibrated to correct the reading.

Make the measurement with the spectrum analyzer's resolution bandwidth (RBW) = 1000 kHz. In order to make an accurate measurement, set the span greater than RBW.

4.1.4 EUT OPERATION CONDITIONS

The EUT tested system was configured as the statements of 2.3 Unless otherwise a special operating condition is specified in the follows during the testing.

4.1.5 TEST RESULTS

Data See Appendix A





5. POWER SPECTRAL DENSITY TEST

5.1 APPLIED PROCEDURES / LIMIT

1. For mobile and portable client devices in the 5.15-5.25 GHz band, , the maximum power spectral density shall not exceed 11 dBm in any 1 megahertz band. If transmitting antennas of directional gain greater than 6 dBi are used, both the maximum conducted output power and the maximum power spectral density shall be reduced by the amount in dB that the directional gain of the antenna exceeds 6 dBi.
2. For the 5.25-5.35 GHz and 5.47-5.725 GHz bands, the maximum power spectral density shall not exceed 11 dBm in any 1 megahertz band. If transmitting antennas of directional gain greater than 6 dBi are used, both the maximum conducted output power and the maximum power spectral density shall be reduced by the amount in dB that the directional gain of the antenna exceeds 6 dBi.
3. For the band 5.725-5.850 GHz, the peak power spectral density shall not exceed 30 dBm in any 500KHz band. If transmitting antenna directional gain is greater than 6 dBi, both the maximum conducted output power and the peak power spectral density shall be reduced by the amount in dB that the directional gain of the antenna exceeds 6 dBi.

5.1.1 TEST PROCEDURE

1. The setting follows Method SA-1 of FCC KDB D02 General UNII Test Procedures New Rules v01r03.

For devices operating in the band, the rules specify a measurement bandwidth of 500 kHz.

Many spectrum analyzers do not have 500 kHz RBW, thus a narrower RBW may need to be used.

The rules permit the use of a RBWs less than 1 MHz, or 500 kHz, "provided that the measured power is integrated over the full reference bandwidth" to show the total power over the specified measurement bandwidth (*i.e.*, 1 MHz, or 500 kHz). If measurements are performed using a reduced resolution bandwidth (< 1 MHz, or < 500 kHz) and integrated over 1 MHz, or 500 KHz bandwidth, the following adjustments to the procedures apply:

- a) Set $RBW \geq 1/T$, where T is defined in section II.B.1.a).
- b) Set $VBW \geq 3 RBW$.
- c) If measurement bandwidth of Maximum PSD is specified in 500 kHz, add $10 \log (500\text{kHz}/RBW)$ to the measured result, whereas $RBW (< 500 \text{ kHz})$ is the reduced resolution bandwidth of the spectrum analyzer set during measurement.
- d) If measurement bandwidth of Maximum PSD is specified in 1 MHz, add $10 \log (1\text{MHz}/RBW)$ to the measured result, whereas $RBW (< 1 \text{ MHz})$ is the reduced resolution bandwidth of spectrum analyzer set during measurement.
- e) Care must be taken to ensure that the measurements are performed during a period of continuous transmission or are corrected upward for duty cycle.

Note: As a practical matter, it is recommended to use reduced RBW of 100 kHz for the sections 5.c) and 5.d) above, since $RBW=100 \text{ KHZ}$ is available on nearly all spectrum analyzers.

5.1.2 DEVIATION FROM STANDARD

No deviation.

5.1.3 TEST SETUP



5.1.4 EUT OPERATION CONDITIONS

The EUT tested system was configured as the statements of 2.1 Unless otherwise a special operating condition is specified in the follows during the testing.

5.1.5 TEST RESULTS

Data see Appendix B



6. BANDWIDTH MEASUREMENT

6.1 EMISSION BANDWIDTH (EBW) 26 BANDWID PROCEDURES / LIMIT

See list of measuring instruments of this test report.

6.1.1 TEST PROCEDURE

1. The testing follows FCC KDB 789033 D02 General UNII Test Procedures New Rules v02r01
2. Set RBW = approximately 1% of the emission bandwidth.
3. Set the VBW \geq RBW.
4. Detector = Peak.
5. Trace mode = max hold.
6. Measure the maximum width of the emission that is 26 dB down from the peak of the emission. Compare this with the RBW setting of the analyzer. Readjust RBW and repeat measurement as needed until the RBW/EBW ratio is approximately 1%.

6.1.2 DEVIATION FROM STANDARD

No deviation.

6.1.3 TEST SETUP

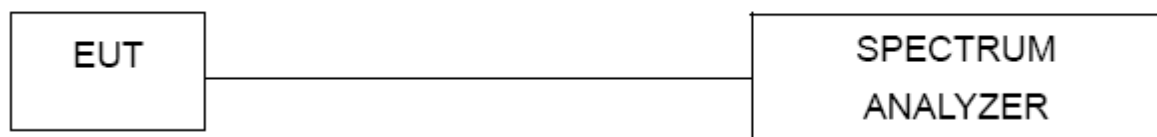

6.1.4 EUT OPERATION CONDITIONS

The EUT tested system was configured as the statements of 2.4 Unless otherwise a special operating condition is specified in the follows during the testing.

6.1.5 TEST RESULTS

Data see Appendix C



6.2 OCCUPIED BANDWIDTH (99%) TEST APPLIED PROCEDURES / LIMIT

The following procedure shall be used for measuring (99 %) power bandwidth:

6.2.1 TEST PROCEDURE

1. The testing follows FCC KDB 789033 D02 General UNII Test Procedures v02r01.

The following procedure shall be used for measuring (99 %) power bandwidth:

1. Set center frequency to the nominal EUT channel center frequency.
2. Set span = 1.5 times to 5.0 times the OBW.
3. Set RBW = 1 % to 5 % of the OBW
4. Set VBW $\geq 3 \cdot$ RBW
5. Video averaging is not permitted. Where practical, a sample detection and single sweep mode shall be used. Otherwise, peak detection and max hold mode (until the trace stabilizes) shall be used.
6. Use the 99 % power bandwidth function of the instrument (if available).
7. If the instrument does not have a 99 % power bandwidth function, the trace data points are recovered and directly summed in power units. The recovered amplitude data points, beginning at the lowest frequency, are placed in a running sum until 0.5 % of the total is reached; that frequency is recorded as the lower frequency. The process is repeated until 99.5 % of the total is reached; that frequency is recorded as the upper frequency. The 99% occupied bandwidth is the difference between these two frequencies.

6.2.2 DEVIATION FROM STANDARD

No deviation.

6.2.3 TEST SETUP

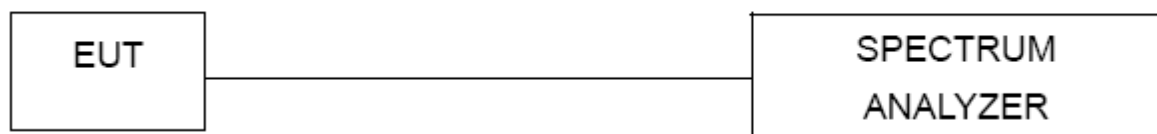

6.2.4 EUT OPERATION CONDITIONS

The EUT tested system was configured as the statements of 2.4 Unless otherwise a special operating condition is specified in the follows during the testing.

6.2.5 TEST RESULTS

Data See Appendix C

6.3 MINIMUM EMISSION BANDWIDTH(6 DB) PROCEDURES / LIMIT

Section 15.407(e) specifies the minimum 6 dB emission bandwidth of at least 500 KHz for the band 5.725-5.85 GHz. The following procedure shall be used for measuring this bandwidth:

6.3.1 TEST PROCEDURE

1. The testing follows FCC KDB 789033 D02 General UNII Test Procedures v02r01.
 - a) Set RBW = 100 kHz.
 - b) Set the video bandwidth (VBW) $\geq 3 \times$ RBW.
 - c) Detector = Peak.
 - d) Trace mode = max hold.
 - e) Sweep = auto couple.
 - f) Allow the trace to stabilize.
 - g) Measure the maximum width of the emission that is constrained by the frequencies associated with the two outermost amplitude points (upper and lower frequencies) that are attenuated by 6 dB relative to the maximum level measured in the fundamental emission.

6.3.2 DEVIATION FROM STANDARD

No deviation.

6.3.3 TEST SETUP



6.3.4 EUT OPERATION CONDITIONS

The EUT tested system was configured as the statements of 2.4 Unless otherwise a special operating condition is specified in the follows during the testing.

6.3.5 TEST RESULTS

Data see Appendix D

7. MAXIMUM CONDUCTED OUTPUT POWER

7.1 APPLIED PROCEDURES / LIMIT

For mobile and portable client devices in the 5.15-5.25 GHz band, the maximum conducted output power over the frequency band of operation shall not exceed 250 mW provided the maximum antenna gain does not exceed 6 dBi. If transmitting antennas of directional gain greater than 6 dBi are used, both the maximum conducted output power and the maximum power spectral density shall be reduced by the amount in dB that the directional gain of the antenna exceeds 6 dBi.

For the 5.25-5.35 GHz and 5.47-5.725 GHz bands, the maximum conducted output power over the frequency bands of operation shall not exceed the lesser of 250 mW or 11 dBm + 10 log B, where B is the 26 dB emission bandwidth in megahertz, If transmitting antennas of directional gain greater than 6 dBi are used.

For the band 5.725-5.85 GHz, the maximum conducted output power over the frequency band of operation shall not exceed 1 W. If transmitting antennas of directional gain greater than 6 dBi are used.

FCC Part15 (15.407) , Subpart E				
Section	Test Item	Limit	Frequency Range (MHz)	Result
15.407(a) (1) (iv)	Peak Output Power	0.25 watt	5150-5250	PASS
		The lesser of 250 mW or 11 dBm + 10 log (26 dB emission bandwidth)	5250-5350	
5470-5725				
15.407(a) (3)		1 watt	5725-5825	

7.1.1 TEST PROCEDURE

The EUT was connected the Power Sensor&PC to tested the 20MHz, 40MHz mode, connected the spectrum analyzer&PC to tested the 80MHz mode.

7.1.2 DEVIATION FROM STANDARD

No deviation.

7.1.3 TEST SETUP

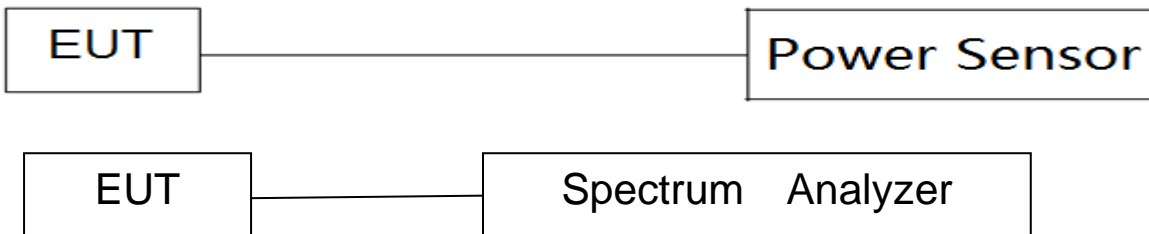

7.1.4 EUT OPERATION CONDITIONS

The EUT tested system was configured as the statements of 5 Unless otherwise a special operating condition is specified in the follows during the testing.

**7.1.5 TEST RESULTS**

- NOTE: 1. Antenna B Power > Antenna A Power, Both antenna A and B have been test
2. 802.11a model can't transmit at the same time.

Band IV (5.725-5.85GHz)

Band IV (5.725-5.85GHz)								
Test Channel	Frequency (MHz)	PK Power A(dBm)	PK Power B(dBm)	PK Power Total(dBm)	AV Power (dBm)	AV Power B(dBm)	AV Power Total(dBm)	LIMIT (dBm)
802.11a								
149	5745	14.55	18.34	--	12.25	16.23	--	30
157	5785	14.27	17.85	--	12.69	15.91	--	30
165	5825	14.06	17.64	--	11.92	15.20	--	30
802.11n(HT20)								
149	5745	14.27	17.72	19.339	12.58	15.44	17.252	30
157	5785	14.01	17.45	19.072	11.78	15.78	17.235	30
165	5825	13.89	17.24	18.891	11.74	15.51	17.032	30
802.11n(HT40)								
151	5755	13.47	17.09	18.657	11.01	14.61	16.183	30
159	5795	13.17	16.84	18.392	11.17	15.30	16.719	30
802.11ac(HT20)								
149	5745	14.02	17.51	19.117	11.65	16.00	17.359	30
157	5785	13.92	17.33	18.962	11.99	15.28	16.950	30
165	5825	13.77	17.02	18.702	12.11	15.07	16.848	30
802.11ac(HT40)								
151	5755	13.36	16.97	18.540	11.67	14.84	16.548	30
159	5795	13.09	16.50	18.132	10.85	14.16	15.823	30
802.11ac(HT80)								
155	5775	12.40	16.85	18.182	10.10	14.65	15.956	30

Note:

- For the band 5.745-5.850 GHz, the maximum conducted output power over the frequency band of operation shall not exceed the lesser of 1 W.



802.11ac HT80(5775MHz)

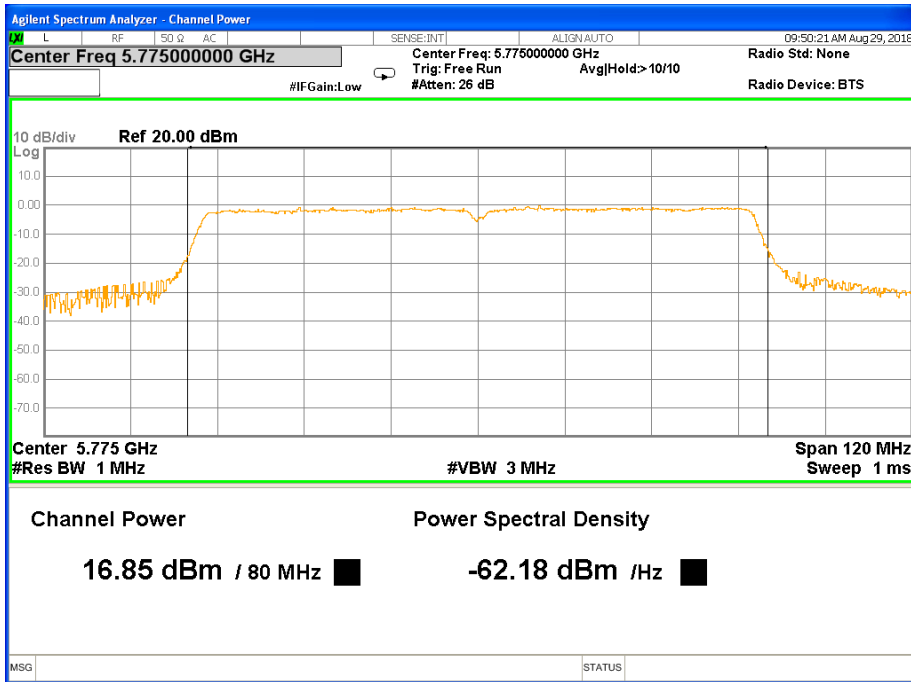



8. AUTOMATICALLY DISCONTINUE TRANSMISSION

8.1 LIMIT OF AUTOMATICALLY DISCONTINUE TRANSMISSION

The device shall automatically discontinue transmission in case of either absence of information to transmit or operational failure. These provisions are not intended to preclude the transmission of control or signaling information or the use of repetitive codes used by certain digital technologies to complete frame or burst intervals. Applicants shall include in their application for equipment authorization to describe how this requirement is met.

8.2 TEST RESULT OF AUTOMATICALLY DISCONTINUE TRANSMISSION

During no any information transmission, the EUT can automatically discontinue transmission and become standby mode for power saving. The EUT can detect the controlling signal of ACK message transmitting from remote device and verify whether it shall resend or discontinue transmission





9. ANTENNA REQUIREMENT

9.1 STANDARD REQUIREMENT

15.203 requirement: For intentional device, according to 15.203: an intentional radiator shall be designed to ensure that no antenna other than that furnished by the responsible party shall be used with the device.

9.2 EUT ANTENNA

The EUT antenna is PIFA Antenna. It comply with the standard requirement.



APPENDIX - PHOTOS OF TEST SETUP

Radiated Measurement Photos

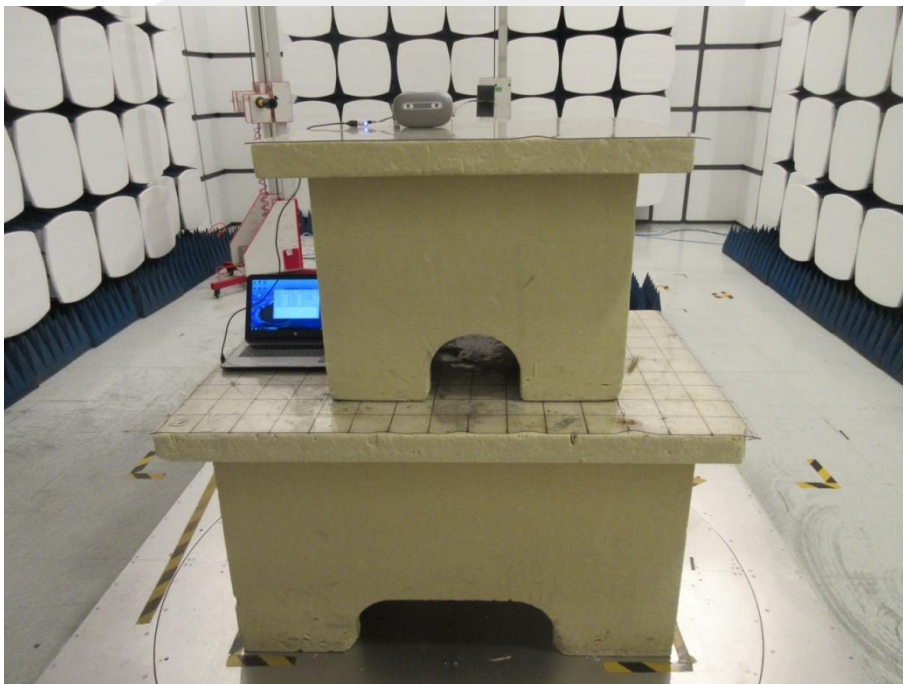
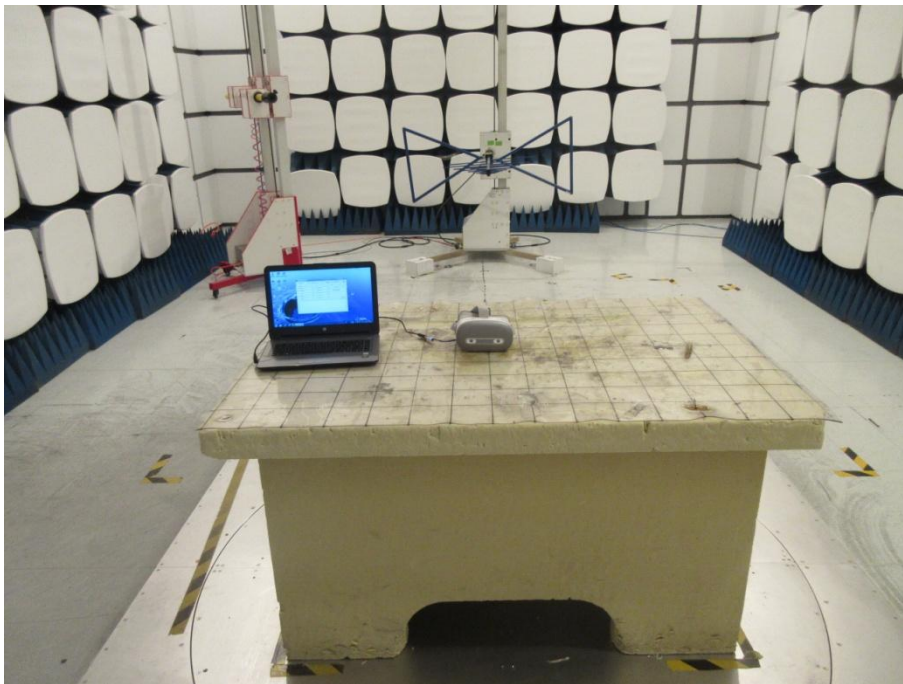

Conducted Measurement Photos



*****END OF THE REPORT*****