

# TEST REPORT

**Reference No.**..... : WTS18S08120417-4W  
**FCC ID** ..... : 2AQYLPT-V01  
**Applicant**..... : Iotech Management LLC  
**Address**..... : 3111 N University Dr Suite 105, Coral Spring, FL 33065, USA  
**Manufacturer** ..... : The same as above  
**Address**..... : The same as above  
**Product**..... : Pets Tracker  
**Model(s)** ..... : PT-v01  
**Brand Name**..... : iotech  
**Standards**..... : FCC CFR47 Part 27: 2017  
**Date of Receipt sample** .... : 2018-08-07  
**Date of Test** ..... : 2018-08-08 to 2018-10-11  
**Date of Issue**..... : 2018-10-12  
**Test Result**..... : **Pass**

Remarks:

The results shown in this test report refer only to the sample(s) tested, this test report cannot be reproduced, except in full, without prior written permission of the company. The report would be invalid without specific stamp of test institute and the signatures of compiler and approver.

**Prepared By:**

**Waltek Services (Shenzhen) Co., Ltd.**

**Address: 1/F., Fukangtai Building, West Baima Road, Songgang Street, Baoan District, Shenzhen, Guangdong, China**

**Tel :+86-755-83551033**

**Fax:+86-755-83552400**

Compiled by:

*Ford Wang*

Ford Wang / Project Engineer

Approved by:



*Philo Zhong*

Philo Zhong / Manager

## 2 Laboratories Introduction

**Waltek Services (Shenzhen) Co., Ltd** is a professional third-party testing and certification laboratory with multi-year product testing and certification experience, established strictly in accordance with ISO/IEC 17025 requirements, and accredited by ILAC (International Laboratory Accreditation Cooperation) member. A2LA (American Association for Laboratory Accreditation, the certification number is 4243.01) of USA, CNAS (China National Accreditation Service for Conformity Assessment, the registration number is L3110) of China. Meanwhile, Waltek has got recognition as registration and accreditation laboratory from EMSD (Electrical and Mechanical Services Department), and American Energy star, FCC (The Federal Communications Commission), CEC (California energy efficiency), ISED (Innovation, Science and Economic Development Canada). It's the strategic partner and data recognition laboratory of international authoritative organizations, such as Intertek (ETL-SEMKO), TÜV Rheinland, TÜV SÜD, etc.

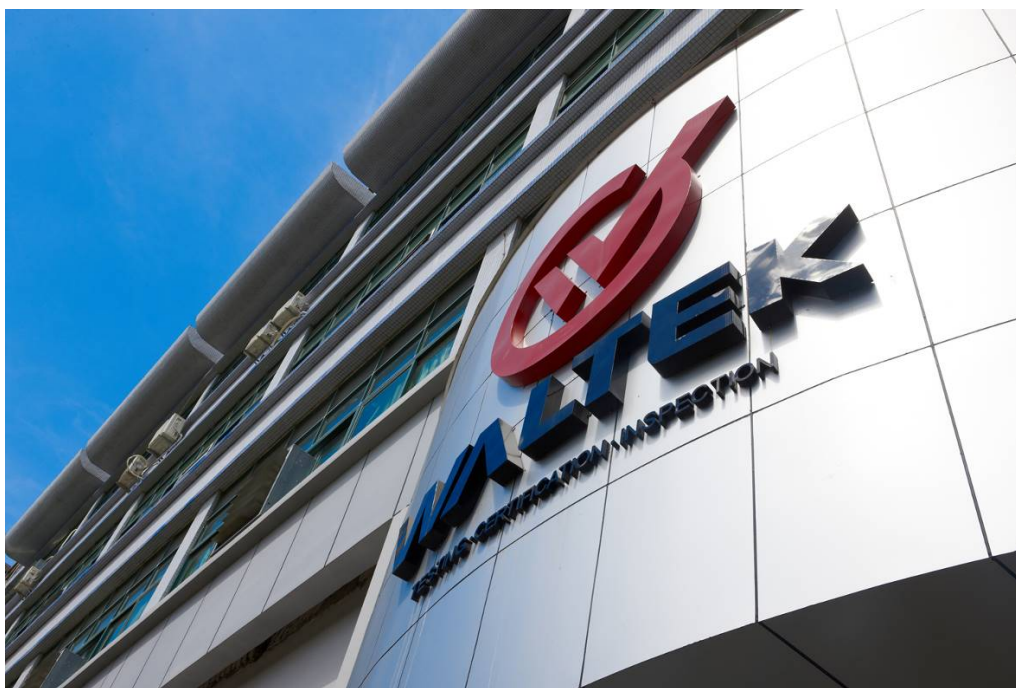

Waltek Services (Shenzhen) Co., Ltd is one of the largest and the most comprehensive third party testing laboratory in China. Our test capability covered four large fields: safety test. Electro Magnetic Compatibility (EMC), and energy performance, wireless radio. As a professional, comprehensive, justice international test organization, we still keep the scientific and rigorous work attitude to help each client satisfy the international standards and assist their product enter into globe market smoothly.

**Test Facility:****A. Accreditations for Conformity Assessment (International)**

Country/Region	Scope Covered By	Scope	Note
USA	ISO/IEC 17025	FCC ID \ DOC \ VOC	1
Canada		IC ID \ VOC	2
Japan		MIC-T \ MIC-R	-
Europe		EMCD \ RED	-
Taiwan		NCC	-
Hong Kong		OFCA	-
Australia		RCM	-
India		WPC	-
Thailand		NTC	-
Singapore		IDA	-
Note: 1. FCC Designation No.: CN1201. Test Firm Registration No.: 523476. 2. ISED Canada Registration No.: 7760A			

**B. TCBs and Notify Bodies Recognized Testing Laboratory.**

Recognized Testing Laboratory of ...	Notify body number
TUV Rheinland	Optional.
Intertek	
TUV SUD	
SGS	
Phoenix Testlab GmbH	0700
Element Materials Technology Warwick Ltd	0891
Timco Engineering, Inc.	1177
Eurofins Product Service GmbH	0681

### 3 Contents

	<b>Page</b>
<b>1 COVER PAGE.....</b>	<b>1</b>
<b>2 LABORATORIES INTRODUCTION.....</b>	<b>2</b>
<b>3 CONTENTS.....</b>	<b>4</b>
<b>4 REVISION HISTORY.....</b>	<b>6</b>
<b>5 GENERAL INFORMATION.....</b>	<b>7</b>
5.1 GENERAL DESCRIPTION OF E.U.T. ....	7
5.2 DETAILS OF E.U.T. ....	7
5.3 TEST MODE.....	9
<b>6 TEST SUMMARY.....</b>	<b>10</b>
<b>7 EQUIPMENT USED DURING TEST.....</b>	<b>11</b>
7.1 EQUIPMENTS LIST.....	11
7.2 DESCRIPTION OF SUPPORT UNITS.....	12
7.3 MEASUREMENT UNCERTAINTY.....	12
7.4 TEST EQUIPMENT CALIBRATION.....	12
<b>8 RF OUTPUT POWER.....</b>	<b>13</b>
8.1 EUT OPERATION.....	13
8.2 TEST PROCEDURE.....	13
8.3 TEST RESULT.....	14
<b>9 PEAK-TO-AVERAGE RATIO.....</b>	<b>29</b>
9.1 EUT OPERATION.....	29
9.2 TEST PROCEDURE.....	29
9.3 TEST RESULT.....	29
<b>10 BANDWIDTH.....</b>	<b>30</b>
10.1 EUT OPERATION.....	30
10.2 TEST PROCEDURE.....	30
10.3 TEST RESULT.....	31
<b>11 SPURIOUS EMISSIONS AT ANTENNA TERMINALS.....</b>	<b>43</b>
11.1 EUT OPERATION.....	43
11.2 TEST PROCEDURE.....	43
11.3 TEST RESULT.....	43
<b>12 SPURIOUS RADIATED EMISSIONS.....</b>	<b>44</b>
12.1 EUT OPERATION.....	44
12.2 TEST SETUP.....	44
12.3 SPECTRUM ANALYZER SETUP.....	45
12.4 TEST PROCEDURE.....	46
12.5 SUMMARY OF TEST RESULTS.....	47
<b>13 BAND EDGE MEASUREMENT.....</b>	<b>49</b>
13.1 EUT OPERATION.....	49
13.2 TEST PROCEDURE.....	49
13.3 TEST RESULT.....	50
<b>14 FREQUENCY STABILITY.....</b>	<b>51</b>
14.1 EUT OPERATION.....	51
14.2 TEST PROCEDURE.....	51

14.3	TEST RESULT .....	52
<b>15</b>	<b>RF EXPOSURE.....</b>	<b>62</b>
<b>16</b>	<b>PHOTOGRAPHS OF TEST SETUP AND EUT.....</b>	<b>63</b>

#### 4 Revision History

Test report No.	Date of Receipt sample	Date of Test	Date of Issue	Purpose	Comment	Approved
WTS18S08120 417-4W	2018-08-07	2018-08-08 to 2018-10- 11	2018-10-12	original	-	Valid

## 5 General Information

### 5.1 General Description of E.U.T.

Product:	Pets Tracker
Model(s):	PT-v01
Model Description:	N/A
GSM Band(s):	GSM 850/900/1800/1900MHz
GPRS/EGPRS Class:	12
WCDMA Band(s):	FDD Band II/V
LTE Band(s):	FDD Band 4/7
Wi-Fi Specification:	2.4G-802.11b/g/n HT20
Bluetooth Version:	Bluetooth v4.0 with BLE
GPS:	Support
NFC:	N/A
Hardware Version:	G79-MB-V2.1
Software Version:	g79_37T_240_5m_tdw_petDog_cn_pr_20180821
Highest frequency (Exclude Radio):	1.25GHz
Storage Location:	Internal Storage

### 5.2 Details of E.U.T.

Operation Frequency:	LTE Band 4: 1710~1755MHz LTE Band 7: 2500~2570MHz
Max. RF output power:	LTE Band 4: 22.74dBm LTE Band 7: 21.98dBm
Type of Modulation:	LTE: QPSK, 16QAM
Antenna installation:	LTE: internal permanent antenna
Antenna Gain:	LTE Band 4: 0.5dBi LTE Band 7: 0.5dBi
Ratings:	Battery DC 3.7V, 650mAh DC 5V , charging from USB
Type of Emission:	LTE Band 4 1.4MHz: 1M09G7D(QPSK), 1M09W7D(16QAM) LTE Band 4 3MHz: 2M73G7D(QPSK), 2M73W7D(16QAM) LTE Band 4 5MHz: 4M50G7D(QPSK), 4M50W7D(16QAM) LTE Band 4 10 MHz: 8M93G7D(QPSK), 8M93W7D(16QAM) LTE Band 4 15MHz: 13M5G7D(QPSK), 13M5W7D(16QAM) LTE Band 4 20MHz: 17M9G7D(QPSK), 17M9W7D(16QAM) LTE Band 7 5MHz: 4M50G7D(QPSK), 4M50W7D(16QAM) LTE Band 7 10 MHz: 8M94G7D(QPSK), 8M93W7D(16QAM)

LTE Band 7 15MHz: 13M5G7D(QPSK), 13M5W7D(16QAM)

LTE Band 7 20MHz: 17M9G7D(QPSK), 17M9W7D(16QAM)



### 5.3 Test Mode

All test mode(s) and condition(s) mentioned were considered and evaluated respectively by performing full tests, the worst data were recorded and reported.

Support Band	Test Mode BW(MHz)	Channel Frequency	Channel Number
LTE Band 4	1.4	1710.7 MHz	19957
		1732.5 MHz	20175
		1754.3 MHz	20393
	3	1711.5 MHz	19965
		1732.5 MHz	20175
		1753.5 MHz	20385
	5	1712.5 MHz	19975
		1732.5 MHz	20175
		1752.5 MHz	20375
	10	1715.0 MHz	20000
		1732.5 MHz	20175
		1750.0 MHz	20350
	15	1717.5 MHz	20025
		1732.5 MHz	20175
		1747.5 MHz	20325
20	1720.0 MHz	20050	
	1732.5 MHz	20175	
	1745.0 MHz	20300	
LTE Band 7	5	2502.5 MHz	20775
		2535.0 MHz	21100
		2567.5 MHz	21425
	10	2505.0 MHz	20800
		2535.0 MHz	21100
		2565.0 MHz	21400
	15	2507.5 MHz	20825
		2535.0 MHz	21100
		2562.5 MHz	21375
	20	2510.0 MHz	20850
		2535.0 MHz	21100
		2560.0 MHz	21350
Remark: All mode(s) were tested and the worst data was recorded.			

## 6 Test Summary

Test Items	Test Requirement	Result
RF Output Power	2.1046 27.50(h.2) 27.50(d.4)	PASS
Peak-to-Average Ratio	27.50(d)	PASS
Bandwidth	2.1049 27.53(a)	PASS
Spurious Emissions at Antenna Terminal	2.1051 27.53(h) 27.53(m)(4)	PASS
Field Strength of Spurious Radiation	2.1053 27.53(h) 27.53(m)(4)	PASS
Out of band emission	27.53(h) 27.53(m)(4)	PASS
Frequency Stability	2.1055 27.5(h) 27.54	PASS
Maximum Permissible Exposure (SAR)	1.1307 2.1093	PASS

## 7 Equipment Used during Test

### 7.1 Equipments List

Conducted Emissions Test Site 1#						
Item	Equipment	Manufacturer	Model No.	Serial No.	Last Calibration Date	Calibration Due Date
1.	EMI Test Receiver	R&S	ESCI	100947	2018-09-12	2019-09-11
2.	LISN	R&S	ENV216	101215	2018-09-12	2019-09-11
3.	Cable	Top	TYPE16(3.5M)	-	2018-09-12	2019-09-11
Conducted Emissions Test Site 2#						
Item	Equipment	Manufacturer	Model No.	Serial No.	Last Calibration Date	Calibration Due Date
1.	EMI Test Receiver	R&S	ESCI	101155	2018-09-12	2019-09-11
2.	LISN	SCHWARZBECK	NSLK 8128	8128-289	2018-09-12	2019-09-11
3.	Limiter	York	MTS-IMP-136	261115-001-0024	2018-09-12	2019-09-11
4.	Cable	LARGE	RF300	-	2018-09-12	2019-09-11
3m Semi-anechoic Chamber for Radiation Emissions Test site 1#						
Item	Equipment	Manufacturer	Model No.	Serial No.	Last Calibration Date	Calibration Due Date
1	Spectrum Analyzer	R&S	FSP	100091	2018-04-29	2019-04-28
2	Active Loop Antenna	Beijing Dazhi	ZN30900A	-	2018-04-09	2019-04-08
3	Trilog Broadband Antenna	SCHWARZBECK	VULB9163	336	2018-04-09	2019-04-08
4	Coaxial Cable (below 1GHz)	Top	TYPE16(13M)	-	2018-09-12	2019-09-11
5	Broad-band Horn Antenna	SCHWARZBECK	BBHA 9120 D	667	2018-04-09	2019-04-08
6	Broad-band Horn Antenna	SCHWARZBECK	BBHA 9170	335	2018-04-09	2019-04-08
7	Broadband Preamplifier	COMPLIANCE DIRECTION	PAP-1G18	2004	2018-04-13	2019-04-12
8	Coaxial Cable (above 1GHz)	Top	1GHz-25GHz	EW02014-7	2018-04-13	2019-04-12
9	Signal Generator	R&S	SMR20	100046	2018-09-12	2019-09-11
10	Smart Antenna	SCHWARZBECK	HA08	-	2018-04-09	2019-04-08
3m Semi-anechoic Chamber for Radiation Emissions Test site 2#						
Item	Equipment	Manufacturer	Model No.	Serial No	Last Calibration Date	Calibration Due Date
1	Test Receiver	R&S	ESCI	101296	2018-04-13	2019-04-12
2	Trilog Broadband Antenna	SCHWARZBECK	VULB9160	9160-3325	2018-04-09	2019-04-08

3	Amplifier	Compliance pirection systems inc	PAP-0203	22024	2018-04-13	2019-04-12
4	Cable	HUBER+SUHNER	CBL2	525178	2018-04-13	2019-04-12
<b>RF Conducted Testing</b>						
Item	Equipment	Manufacturer	Model No.	Serial No.	Last Calibration Date	Calibration Due Date
1.	EMC Analyzer (9k~26.5GHz)	Agilent	E7405A	MY45114943	2018-09-12	2019-09-11
2.	Spectrum Analyzer	Agilent	N9020A	MY49100060	2018-09-12	2019-09-11
3.	Universal Radio Communication Tester	R&S	CMW 500	127818	2018-04-13	2019-04-12
4	Signal Analyzer (9k~26.5GHz)	Agilent	N9010A	MY50520207	2018-09-12	2019-09-11

## 7.2 Description of Support Units

Equipment	Manufacturer	Model No.	Series No.
MacBook Air	APPLE	A1465	C17KTQDNF5N7
Power Supply	LPS DELTA ELECTRNICS UIANG CO.,LTD	ADP-45GD	-

## 7.3 Measurement Uncertainty

Parameter	Uncertainty
Conducted Emission	± 3.64 dB(AC mains 150KHz~30MHz)
Radiated Spurious Emissions	± 5.08 dB (Bilog antenna 30M~1000MHz)
	± 5.47 dB (Horn antenna 1000M~25000MHz)
Radio Frequency	± 1 x 10 <sup>-7</sup> Hz
RF Power	± 0.42 dB
RF Power Density	± 0.7dB
Conducted Spurious Emissions	± 2.76 dB (9kHz~26500MHz)
Confidence interval: 95%. Confidence factor:k=2	

## 7.4 Test Equipment Calibration

All the test equipments used are valid and calibrated by CEPREI Certification Body that address is No.110 Dongguan Zhuang RD. Guangzhou, P.R.China.

## 8 RF OUTPUT POWER

Test Requirement:	FCC Part 2.1046, 27.50(h.2); 27.50(d.4);
Test Method:	TIA/EIA-603-D:2010 KDB971168 D01 v03
Test Mode:	TX transmitting

### 8.1 EUT Operation

Operating Environment :

Temperature:	22.5 °C
Humidity:	52.1 % RH
Atmospheric Pressure:	101.2kPa

### 8.2 Test Procedure

Conducted method:

The RF output of the transmitter was connected to the wireless test set and the spectrum analyzer through sufficient attenuation.



Radiated method:

1. The setup of EUT is according with per TIA/EIA Standard 603D:2010.
2. The measurement antenna was placed at a distance of 3 meters from the EUT. During the tests, the antenna height and polarization as well as EUT azimuth were varied in order to identify the maximum level of emissions from the EUT. The test was performed by placing the EUT on 3-orthogonal axis.
3. The frequency range up to tenth harmonic of the fundamental frequency was investigated.
4. Remove the EUT and replace it with substitution antenna. A signal generator was connected to the substitution antenna by a non-radiating cable. The absolute levels of the spurious emissions were measured by the substitution.

## 8.3 Test Result

## Conducted Power

## LTE Band 4:

BW(MHz)	Ch	Freq(MHz)	Mode	UL RB Allocation	UL RB Offset	Average Power (dbm)	Tune up limited(dBm)	MPR (dB)
1.4MHz	19957	1710.7	QPSK	1	0	22.13	22.0±1	/
				1	2	22.12	22.0±1	/
				1	5	22.09	22.0±1	/
				3	0	22.12	22.0±1	/
				3	1	22.12	22.0±1	/
				3	2	22.1	22.0±1	/
			6	0	21.08	21.0±1	1.0	
			16QAM	1	0	21.14	21.0±1	1.0
				1	2	21.19	21.0±1	1.0
				1	5	21.16	21.0±1	1.0
				3	0	21.11	21.0±1	1.0
				3	1	21.11	21.0±1	1.0
	3	2		21.13	21.0±1	1.0		
	20175	1732.5	QPSK	6	0	20.17	21.0±1	1.0
				1	0	22.1	22.0±1	/
				1	2	22.15	22.0±1	/
				1	5	22.08	22.0±1	/
				3	0	22.03	22.0±1	/
				3	1	22.07	22.0±1	/
			3	2	22.02	22.0±1	/	
			16QAM	6	0	21.11	21.0±1	1.0
				1	0	21.3	21.0±1	1.0
				1	2	21.3	21.0±1	1.0
				1	5	21.26	21.0±1	1.0
3				0	21.12	21.0±1	1.0	
3	1	21.11		21.0±1	1.0			
20393	1754.3	QPSK	3	2	21.07	21.0±1	1.0	
			6	0	20.88	21.0±1	1.0	
			1	0	21.85	22.0±1	/	
			1	2	21.94	22.0±1	/	
			1	5	21.9	22.0±1	/	
			3	0	21.8	22.0±1	/	
		16QAM	3	1	21.8	22.0±1	/	
			3	2	21.8	22.0±1	/	
			6	0	20.8	21.0±1	1.0	
			1	0	20.67	21.0±1	1.0	
			1	2	20.72	21.0±1	1.0	
			1	5	20.71	21.0±1	1.0	
3	0	20.85	21.0±1	1.0				
3	1	20.8	21.0±1	1.0				
3	2	20.82	21.0±1	1.0				
6	0	20.85	21.0±1	1.0				

BW(MHz)	Ch	Freq(MHz)	Mode	UL RB Allocation	UL RB Offset	Average Power (dbm)	Tune up limited(dBm)	MPR (dB)
3MHz	19965	1711.5	QPSK	1	0	22.16	22.0±1	/
				1	8	22.18	22.0±1	/
				1	14	22.15	22.0±1	/
				6	0	21.26	21.0±1	1.0
				6	4	21.26	21.0±1	1.0
				6	9	21.26	21.0±1	1.0
				15	0	21.2	21.0±1	1.0
			16QAM	1	0	20.98	21.0±1	1.0
				1	8	21.02	21.0±1	1.0
				1	14	20.94	21.0±1	1.0
				8	0	20.31	21.0±1	1.0
				8	4	20.27	21.0±1	1.0
				8	9	20.25	21.0±1	1.0
				15	0	20.18	21.0±1	1.0
	20175	1732.5	QPSK	1	0	22.09	22.0±1	/
				1	8	22.11	22.0±1	/
				1	14	22.05	22.0±1	/
				6	0	21.19	21.0±1	1.0
				6	4	21.19	21.0±1	1.0
				6	9	21.17	21.0±1	1.0
				15	0	21.04	21.0±1	1.0
			16QAM	1	0	21.23	21.0±1	1.0
				1	8	21.24	21.0±1	1.0
				1	14	21.19	21.0±1	1.0
				6	0	20.09	21.0±1	1.0
				6	4	20.13	21.0±1	1.0
				6	9	20.09	21.0±1	1.0
				15	0	20.04	21.0±1	1.0
	20385	1753.5	QPSK	1	0	21.88	22.0±1	/
				1	8	21.94	22.0±1	/
1				14	21.92	22.0±1	/	
6				0	20.9	21.0±1	1.0	
6				4	20.93	21.0±1	1.0	
6				9	20.89	21.0±1	1.0	
15				0	20.81	21.0±1	1.0	
16QAM			1	0	20.69	21.0±1	1.0	
			1	8	20.7	21.0±1	1.0	
			1	14	20.64	21.0±1	1.0	
			8	0	20.84	21.0±1	1.0	
			8	4	20.82	21.0±1	1.0	
			8	9	20.81	21.0±1	1.0	
			15	0	20.71	21.0±1	1.0	

BW(MHz)	Ch	Freq(MHz)	Mode	UL RB Allocation	UL RB Offset	Average Power (dbm)	Tune up limited(dBm)	MPR (dB)
5MHz	19975	1712.5	QPSK	1	0	22.27	22.0±1	/
				1	49	22.19	22.0±1	/
				1	99	22.2	22.0±1	/
				12	0	21.28	21.0±1	1.0
				12	24	21.26	21.0±1	1.0
				12	49	21.26	21.0±1	1.0
				25	0	21.21	21.0±1	1.0
			16QAM	1	0	21.39	21.0±1	1.0
				1	49	21.31	21.0±1	1.0
				1	99	21.31	21.0±1	1.0
				12	0	20.32	21.0±1	1.0
				12	24	20.29	21.0±1	1.0
				12	49	20.28	21.0±1	1.0
				25	0	20.19	21.0±1	1.0
	20175	1732.5	QPSK	1	0	22.23	22.0±1	/
				1	49	22.19	22.0±1	/
				1	99	22.09	22.0±1	/
				12	0	21.12	21.0±1	1.0
				12	24	21.06	21.0±1	1.0
				12	49	21.04	21.0±1	1.0
				25	0	21.01	21.0±1	1.0
			16QAM	1	0	21.47	21.0±1	1.0
				1	49	21.44	21.0±1	1.0
				1	99	21.38	21.0±1	1.0
				12	0	20.16	21.0±1	1.0
				12	24	20.14	21.0±1	1.0
				12	49	20.1	21.0±1	1.0
25				0	20.03	21.0±1	1.0	
20375	1752.5	QPSK	1	0	21.89	22.0±1	/	
			1	49	21.92	22.0±1	/	
			1	99	21.95	22.0±1	/	
			12	0	20.86	21.0±1	1.0	
			12	24	20.86	21.0±1	1.0	
			12	49	20.84	21.0±1	1.0	
			25	0	20.81	21.0±1	1.0	
		16QAM	1	0	20.87	21.0±1	1.0	
			1	49	20.84	21.0±1	1.0	
			1	99	20.85	21.0±1	1.0	
			12	0	20.83	21.0±1	1.0	
			12	24	20.81	21.0±1	1.0	
			12	49	20.81	21.0±1	1.0	
			25	0	20.69	21.0±1	1.0	



BW(MHz)	Ch	Freq(MHz)	Mode	UL RB Allocation	UL RB Offset	Average Power (dbm)	Tune up limited(dBm)	MPR (dB)
10MHz	20000	1715	QPSK	1	0	21.62	22.0±1	/
				1	49	21.87	22.0±1	/
				1	99	21.97	22.0±1	/
				25	0	20.86	21.0±1	1.0
				25	24	20.56	21.0±1	1.0
				25	49	20.49	21.0±1	1.0
				50	0	20.5	21.0±1	1.0
			16QAM	1	0	20.93	21.0±1	1.0
				1	49	20.3	21.0±1	1.0
				1	99	20.5	21.0±1	1.0
				25	0	20.91	21.0±1	1.0
				25	24	20.02	21.0±1	1.0
				25	49	20.27	21.0±1	1.0
				50	0	20.27	21.0±1	1.0
	20175	1732.5	QPSK	1	0	22.35	22.0±1	/
				1	49	22.18	22.0±1	/
				1	99	21.71	22.0±1	/
				25	0	21.19	21.0±1	1.0
				25	24	21.17	21.0±1	1.0
				25	49	21.14	21.0±1	1.0
				50	0	21.14	21.0±1	1.0
			16QAM	1	0	21.44	21.0±1	1.0
				1	49	21.4	21.0±1	1.0
				1	99	21.07	21.0±1	1.0
				25	0	20.11	21.0±1	1.0
				25	24	20.09	21.0±1	1.0
				25	49	20.08	21.0±1	1.0
50				0	20.09	21.0±1	1.0	
20350	1750	QPSK	1	0	22	22.0±1	/	
			1	49	22.02	22.0±1	/	
			1	99	22.02	22.0±1	/	
			25	0	20.92	21.0±1	1.0	
			25	24	20.9	21.0±1	1.0	
			25	49	20.91	21.0±1	1.0	
			50	0	20.93	21.0±1	1.0	
		16QAM	1	0	20.87	21.0±1	1.0	
			1	49	20.82	21.0±1	1.0	
			1	99	20.82	21.0±1	1.0	
			25	0	20.98	21.0±1	1.0	
			25	24	20.95	21.0±1	1.0	
			25	49	20.95	21.0±1	1.0	
			50	0	20.9	21.0±1	1.0	

BW(MHz)	Ch	Freq(MHz)	Mode	UL RB Allocation	UL RB Offset	Average Power (dbm)	Tune up limited(dBm)	MPR (dB)
15MHz	20025	1717.5	QPSK	1	0	21.63	22.0±1	/
				1	49	22.19	22.0±1	/
				1	99	22.32	22.0±1	/
				36	0	21.12	21.0±1	1.0
				36	24	21.4	21.0±1	1.0
				36	49	21.48	21.0±1	1.0
				75	0	21.32	21.0±1	1.0
			16QAM	1	0	20.51	21.0±1	1.0
				1	49	21.08	21.0±1	1.0
				1	99	21.09	21.0±1	1.0
				36	0	20.07	21.0±1	1.0
				36	24	20.33	21.0±1	1.0
				36	49	20.31	21.0±1	1.0
				75	0	20.3	21.0±1	1.0
	20175	1732.5	QPSK	1	0	22.2	22.0±1	/
				1	49	22.32	22.0±1	/
				1	99	22.44	22.0±1	/
				36	0	20.75	21.0±1	1.0
				36	24	20.28	21.0±1	1.0
				36	49	20.84	21.0±1	1.0
				75	0	20.4	21.0±1	1.0
			16QAM	1	0	20.86	21.0±1	1.0
				1	49	20.33	21.0±1	1.0
				1	99	20.83	21.0±1	1.0
				36	0	20.62	21.0±1	1.0
				36	24	20.43	21.0±1	1.0
				36	49	20.09	21.0±1	1.0
				75	0	20.42	21.0±1	1.0
	20325	1747.5	QPSK	1	0	21.72	22.0±1	/
				1	49	21.04	22.0±1	/
1				99	21.15	22.0±1	/	
36				0	20.01	21.0±1	1.0	
36				24	20.21	21.0±1	1.0	
36				49	20.42	21.0±1	1.0	
75				0	20.16	21.0±1	1.0	
16QAM			1	0	20.99	21.0±1	1.0	
			1	49	20.29	21.0±1	1.0	
			1	99	20.36	21.0±1	1.0	
			36	0	20.94	21.0±1	1.0	
			36	24	20.2	21.0±1	1.0	
			36	49	20.38	21.0±1	1.0	
			75	0	20.21	21.0±1	1.0	

BW(MHz)	Ch	Freq(MHz)	Mode	UL RB Allocation	UL RB Offset	Average Power (dbm)	Tune up limited(dBm)	MPR (dB)
20MHz	20050	1720	QPSK	1	0	22.49	22.0±1	/
				1	49	22.12	22.0±1	/
				1	99	21.74	22.0±1	/
				50	0	21.11	21.0±1	1.0
				50	24	21.29	21.0±1	1.0
				50	49	21.28	21.0±1	1.0
				100	0	21.26	21.0±1	1.0
			16QAM	1	0	20.98	21.0±1	1.0
				1	49	21.66	21.0±1	1.0
				1	99	21.27	21.0±1	1.0
				50	0	20.19	21.0±1	1.0
				50	24	20.27	21.0±1	1.0
				50	49	20.24	21.0±1	1.0
				100	0	20.28	21.0±1	1.0
	20175	1732.5	QPSK	1	0	22.29	22.0±1	/
				1	49	22.74	22.0±1	/
				1	99	21.89	22.0±1	/
				50	0	21.22	21.0±1	1.0
				50	24	21.87	21.0±1	1.0
				50	49	21.41	21.0±1	1.0
				100	0	20.9	21.0±1	1.0
			16QAM	1	0	21.58	21.0±1	1.0
				1	49	20.96	21.0±1	1.0
				1	99	20.42	21.0±1	1.0
				50	0	20.18	21.0±1	1.0
				50	24	20.02	21.0±1	1.0
				50	49	20.53	21.0±1	1.0
				100	0	20.04	21.0±1	1.0
	20300	1745	QPSK	1	0	21.39	22.0±1	/
				1	49	21.56	22.0±1	/
1				99	21.76	22.0±1	/	
50				0	20.62	21.0±1	1.0	
50				24	20.72	21.0±1	1.0	
50				49	20.04	21.0±1	1.0	
100				0	20.73	21.0±1	1.0	
16QAM			1	0	20.81	21.0±1	1.0	
			1	49	20.82	21.0±1	1.0	
			1	99	20.58	21.0±1	1.0	
			50	0	20.46	21.0±1	1.0	
			50	24	20.53	21.0±1	1.0	
			50	49	20.8	21.0±1	1.0	
			100	0	20.67	21.0±1	1.0	

**LTE Band 7:**

BW(MHz)	Ch	Freq(MHz)	Mode	UL RB Allocation	UL RB Offset	Average Power (dbm)	Tune up limited(dBm)	MPR (dB)
5MHz	20775	2502.5	QPSK	1	0	21.91	21.0±1	/
				1	49	21.42	21.0±1	/
				1	99	21.71	21.0±1	/
				12	0	20.94	20.0±1	1.0
				12	24	20.95	20.0±1	1.0
				12	49	20.94	20.0±1	1.0
				25	0	20.92	20.0±1	1.0
			16QAM	1	0	20.12	20.0±1	1.0
				1	49	20.1	20.0±1	1.0
				1	99	20.04	20.0±1	1.0
				12	0	20.08	20.0±1	1.0
				12	24	20.07	20.0±1	1.0
				12	49	20.07	20.0±1	1.0
				25	0	20	20.0±1	1.0
	21100	2535	QPSK	1	0	21.8	21.0±1	/
				1	49	21.32	21.0±1	/
				1	99	21.7	21.0±1	/
				12	0	20.76	20.0±1	1.0
				12	24	20.78	20.0±1	1.0
				12	49	20.78	20.0±1	1.0
				25	0	20.73	20.0±1	1.0
			16QAM	1	0	20.19	20.0±1	1.0
				1	49	20.2	20.0±1	1.0
				1	99	20.2	20.0±1	1.0
				12	0	19.89	20.0±1	1.0
				12	24	19.92	20.0±1	1.0
				12	49	19.93	20.0±1	1.0
25				0	19.82	20.0±1	1.0	
21425	2567.5	QPSK	1	0	21.54	21.0±1	/	
			1	49	20.82	21.0±1	/	
			1	99	20.86	21.0±1	/	
			12	0	19.85	20.0±1	1.0	
			12	24	19.59	20.0±1	1.0	
			12	49	19.54	20.0±1	1.0	
			25	0	19.65	20.0±1	1.0	
		16QAM	1	0	20.27	20.0±1	1.0	
			1	49	19.61	20.0±1	1.0	
			1	99	19.71	20.0±1	1.0	
			12	0	19.79	20.0±1	1.0	
			12	24	19.79	20.0±1	1.0	
			12	49	19.8	20.0±1	1.0	
			25	0	19.66	20.0±1	1.0	

BW(MHz)	Ch	Freq(MHz)	Mode	UL RB Allocation	UL RB Offset	Average Power (dbm)	Tune up limited(dBm)	MPR (dB)
10MHz	20800	2505	QPSK	1	0	21.91	21.0±1	/
				1	49	21.87	21.0±1	/
				1	99	21.85	21.0±1	/
				25	0	20.98	20.0±1	1.0
				25	24	20.93	20.0±1	1.0
				25	49	20.9	20.0±1	1.0
				50	0	20.95	20.0±1	1.0
			16QAM	1	0	20.91	20.0±1	1.0
				1	49	20.87	20.0±1	1.0
				1	99	20.78	20.0±1	1.0
				25	0	20.06	20.0±1	1.0
				25	24	20	20.0±1	1.0
				25	49	19.99	20.0±1	1.0
				50	0	20	20.0±1	1.0
	21100	2535	QPSK	1	0	21.75	21.0±1	/
				1	49	21.81	21.0±1	/
				1	99	21.42	21.0±1	/
				25	0	20.75	20.0±1	1.0
				25	24	20.78	20.0±1	1.0
				25	49	20.81	20.0±1	1.0
				50	0	20.78	20.0±1	1.0
			16QAM	1	0	20.98	20.0±1	1.0
				1	49	20.09	20.0±1	1.0
				1	99	20.09	20.0±1	1.0
				25	0	19.76	20.0±1	1.0
				25	24	19.8	20.0±1	1.0
				25	49	19.82	20.0±1	1.0
				50	0	19.79	20.0±1	1.0
	21400	2565	QPSK	1	0	21.72	21.0±1	/
				1	49	21.6	21.0±1	/
1				99	20.75	21.0±1	/	
25				0	20.74	20.0±1	1.0	
25				24	20.72	20.0±1	1.0	
25				49	20.45	20.0±1	1.0	
50				0	20.73	20.0±1	1.0	
16QAM			1	0	20.62	20.0±1	1.0	
			1	49	20.51	20.0±1	1.0	
			1	99	19.79	20.0±1	1.0	
			25	0	19.78	20.0±1	1.0	
			25	24	19.8	20.0±1	1.0	
			25	49	19.8	20.0±1	1.0	
			50	0	19.75	20.0±1	1.0	

BW(MHz)	Ch	Freq(MHz)	Mode	UL RB Allocation	UL RB Offset	Average Power (dbm)	Tune up limited(dBm)	MPR (dB)
15MHz	20825	2507.5	QPSK	1	0	21.89	21.0±1	/
				1	49	21.83	21.0±1	/
				1	99	21.99	21.0±1	/
				36	0	20.1	20.0±1	1.0
				36	24	20.03	20.0±1	1.0
				36	49	20.98	20.0±1	1.0
				75	0	20.06	20.0±1	1.0
			16QAM	1	0	20.92	20.0±1	1.0
				1	49	20.81	20.0±1	1.0
				1	99	20.69	20.0±1	1.0
				36	0	20.07	20.0±1	1.0
				36	24	20.01	20.0±1	1.0
				36	49	19.97	20.0±1	1.0
				75	0	20.04	20.0±1	1.0
	21100	2535	QPSK	1	0	21.75	21.0±1	/
				1	49	21.7	21.0±1	/
				1	99	21.32	21.0±1	/
				36	0	20.94	20.0±1	1.0
				36	24	20.96	20.0±1	1.0
				36	49	20.89	20.0±1	1.0
				75	0	20.94	20.0±1	1.0
			16QAM	1	0	20.96	20.0±1	1.0
				1	49	20.09	20.0±1	1.0
				1	99	20.12	20.0±1	1.0
				36	0	19.86	20.0±1	1.0
				36	24	19.94	20.0±1	1.0
				36	49	19.9	20.0±1	1.0
75				0	19.9	20.0±1	1.0	
21375	2562.5	QPSK	1	0	21.69	21.0±1	/	
			1	49	21.63	21.0±1	/	
			1	99	20.75	21.0±1	/	
			36	0	20.93	20.0±1	1.0	
			36	24	20.96	20.0±1	1.0	
			36	49	20.91	20.0±1	1.0	
			75	0	20.91	20.0±1	1.0	
		16QAM	1	0	20.87	20.0±1	1.0	
			1	49	20.93	20.0±1	1.0	
			1	99	20.25	20.0±1	1.0	
			36	0	19.75	20.0±1	1.0	
			36	24	19.79	20.0±1	1.0	
			36	49	19.8	20.0±1	1.0	
			75	0	19.81	20.0±1	1.0	

BW(MHz)	Ch	Freq(MHz)	Mode	UL RB Allocation	UL RB Offset	Average Power (dbm)	Tune up limited(dBm)	MPR (dB)
20MHz	20850	2510	QPSK	1	0	21.97	21.0±1	/
				1	49	21.97	21.0±1	/
				1	99	21.76	21.0±1	/
				50	0	20.02	20.0±1	1.0
				50	24	20.9	20.0±1	1.0
				50	49	20.86	20.0±1	1.0
				100	0	20.91	20.0±1	1.0
			16QAM	1	0	20.57	20.0±1	1.0
				1	49	20.41	20.0±1	1.0
				1	99	20.28	20.0±1	1.0
				50	0	20.07	20.0±1	1.0
				50	24	19.96	20.0±1	1.0
				50	49	19.9	20.0±1	1.0
				100	0	19.97	20.0±1	1.0
	21100	2535	QPSK	1	0	21.71	21.0±1	/
				1	49	21.98	21.0±1	/
				1	99	21.3	21.0±1	/
				50	0	20.77	20.0±1	1.0
				50	24	20.99	20.0±1	1.0
				50	49	20.83	20.0±1	1.0
				100	0	20.79	20.0±1	1.0
			16QAM	1	0	20.96	20.0±1	1.0
				1	49	20.13	20.0±1	1.0
				1	99	20.18	20.0±1	1.0
				50	0	19.76	20.0±1	1.0
				50	24	19.82	20.0±1	1.0
				50	49	19.85	20.0±1	1.0
100				0	19.79	20.0±1	1.0	
21350	2560	QPSK	1	0	21.67	21.0±1	/	
			1	49	21.76	21.0±1	/	
			1	99	20.91	21.0±1	/	
			50	0	20.7	20.0±1	1.0	
			50	24	20.75	20.0±1	1.0	
			50	49	20.77	20.0±1	1.0	
			100	0	20.74	20.0±1	1.0	
		16QAM	1	0	20.98	20.0±1	1.0	
			1	49	20.94	20.0±1	1.0	
			1	99	20.14	20.0±1	1.0	
			50	0	19.64	20.0±1	1.0	
			50	24	19.66	20.0±1	1.0	
			50	49	19.73	20.0±1	1.0	
			100	0	19.71	20.0±1	1.0	

## ERP and EIRP

## LTE Band 4

Frequency (MHz)	Receiver Reading (dBμV)	Turn table Angle Degree	RX Antenna		Substituted			Absolute Level (dBm)	Part 27	
			Height (m)	Polar (H/V)	SG Level (dBm)	Cable (dB)	Antenna Gain (dB)		Limit (dBm)	Margin (dB)
LTE Band 4 Channel 19957 – 1.4MHz – QPSK										
1710.70	88.54	166	2.3	H	14.43	0.30	9.40	23.53	30	-6.47
1710.70	88.01	184	1.7	V	14.48	0.30	9.40	23.58	30	-6.42
LTE Band 4 Channel 20175 – 1.4MHz – QPSK										
1732.50	88.50	36	2.2	H	14.39	0.30	9.40	23.49	30	-6.51
1732.50	87.70	14	2.1	V	14.17	0.30	9.40	23.27	30	-6.73
LTE Band 4 Channel 20393 – 1.4MHz – QPSK										
1754.30	88.35	123	1.5	H	14.24	0.30	9.40	23.34	30	-6.66
1754.30	87.69	148	1.8	V	14.16	0.30	9.40	23.26	30	-6.74
LTE Band 4 Channel 19957 – 1.4MHz – 16QAM										
1710.70	88.37	5	1.5	H	14.26	0.30	9.40	23.36	30	-6.64
1710.70	87.80	183	2.4	V	14.27	0.30	9.40	23.37	30	-6.63
LTE Band 4 Channel 20175 – 1.4MHz – 16QAM										
1732.50	88.45	11	1.6	H	14.34	0.30	9.40	23.44	30	-6.56
1732.50	87.79	170	1.9	V	14.26	0.30	9.40	23.36	30	-6.64
LTE Band 4 Channel 20393 – 1.4MHz – 16QAM										
1754.30	88.41	42	2.0	H	14.30	0.30	9.40	23.40	30	-6.60
1754.30	87.75	251	1.5	V	14.22	0.30	9.40	23.32	30	-6.68
LTE Band 4 Channel 19965 – 3MHz – QPSK										
1711.50	88.46	280	2.0	H	14.35	0.30	9.40	23.45	30	-6.55
1711.50	87.73	39	1.1	V	14.20	0.30	9.40	23.30	30	-6.70
LTE Band 4 Channel 20175 – 3MHz – QPSK										
1732.50	88.44	187	2.4	H	14.33	0.30	9.40	23.43	30	-6.57
1732.50	87.79	71	1.3	V	14.26	0.30	9.40	23.36	30	-6.64
LTE Band 4 Channel 20385 – 3MHz – QPSK										
1753.50	88.36	97	2.1	H	14.25	0.30	9.40	23.35	30	-6.65
1753.50	87.82	160	1.3	V	14.29	0.30	9.40	23.39	30	-6.61
LTE Band 4 Channel 19965 – 3MHz – 16QAM										
1711.50	88.40	306	2.1	H	14.29	0.30	9.40	23.39	30	-6.61
1711.50	87.86	168	1.4	V	14.33	0.30	9.40	23.43	30	-6.57
LTE Band 4 Channel 20175 – 3MHz – 16QAM										
1732.50	88.46	29	1.0	H	14.35	0.30	9.40	23.45	30	-6.55
1732.50	87.88	199	2.3	V	14.35	0.30	9.40	23.45	30	-6.55
LTE Band 4 Channel 20385 – 3MHz – 16QAM										
1753.50	88.39	190	2.0	H	14.28	0.30	9.40	23.38	30	-6.62
1753.50	87.89	204	1.3	V	14.36	0.30	9.40	23.46	30	-6.54
LTE Band 4 Channel 19975 – 5MHz – QPSK										
1712.50	88.42	38	1.2	H	14.31	0.30	9.40	23.41	30	-6.59
1712.50	87.80	242	1.5	V	14.27	0.30	9.40	23.37	30	-6.63
LTE Band 4 Channel 20175 – 5MHz – QPSK										



1732.50	88.55	278	1.3	H	14.44	0.30	9.40	23.54	30	-6.46
1732.50	87.84	294	2.0	V	14.31	0.30	9.40	23.41	30	-6.59
LTE Band 4 Channel 20375 – 5MHz – QPSK										
1752.50	88.59	259	1.5	H	14.48	0.30	9.40	23.58	30	-6.42
1752.50	87.90	91	2.2	V	14.37	0.30	9.40	23.47	30	-6.53
LTE Band 4 Channel 19975 – 5MHz – 16QAM										
1712.50	88.86	49	1.8	H	14.75	0.30	9.40	23.85	30	-6.15
1712.50	87.94	169	2.5	V	14.41	0.30	9.40	23.51	30	-6.49
LTE Band 4 Channel 20175 – 5MHz – 16QAM										
1732.50	88.87	345	2.0	H	14.76	0.30	9.40	23.86	30	-6.14
1732.50	87.95	22	1.5	V	14.42	0.30	9.40	23.52	30	-6.48
LTE Band 4 Channel 20375 – 5MHz – 16QAM										
1752.50	88.86	87	1.5	H	14.75	0.30	9.40	23.85	30	-6.15
1752.50	87.91	163	1.1	V	14.38	0.30	9.40	23.48	30	-6.52
LTE Band 4 Channel 20000 – 10MHz – QPSK										
1715.00	88.53	191	1.6	H	14.42	0.30	9.40	23.52	30	-6.48
1715.00	87.92	262	2.2	V	14.39	0.30	9.40	23.49	30	-6.51
LTE Band 4 Channel 20175 – 10MHz – QPSK										
1732.50	88.51	276	1.9	H	14.40	0.30	9.40	23.50	30	-6.50
1732.50	87.93	77	1.2	V	14.40	0.30	9.40	23.50	30	-6.50
LTE Band 4 Channel 20350 – 10MHz – QPSK										
1750.00	88.69	124	2.4	H	14.58	0.30	9.40	23.68	30	-6.32
1750.00	87.86	82	1.8	V	14.33	0.30	9.40	23.43	30	-6.57
LTE Band 4 Channel 20000 – 10MHz – 16QAM										
1715.00	88.66	357	1.4	H	14.55	0.30	9.40	23.65	30	-6.35
1715.00	87.68	329	1.9	V	14.15	0.30	9.40	23.25	30	-6.75
LTE Band 4 Channel 20175 – 10MHz – 16QAM										
1732.50	88.71	267	1.7	H	14.60	0.30	9.40	23.70	30	-6.30
1732.50	87.69	41	2.3	V	14.16	0.30	9.40	23.26	30	-6.74
LTE Band 4 Channel 20350 – 10MHz – 16QAM										
1750.00	88.75	274	2.0	H	14.64	0.30	9.40	23.74	30	-6.26
1750.00	87.63	187	1.8	V	14.10	0.30	9.40	23.20	30	-6.80
LTE Band 4 Channel 20025 – 15MHz – QPSK										
1717.50	88.74	178	1.1	H	14.63	0.30	9.40	23.73	30	-6.27
1717.50	87.60	219	2.2	V	14.07	0.30	9.40	23.17	30	-6.83
LTE Band 4 Channel 20175 – 15MHz – QPSK										
1732.50	88.76	78	1.2	H	14.65	0.30	9.40	23.75	30	-6.25
1732.50	87.65	157	2.1	V	14.12	0.30	9.40	23.22	30	-6.78
LTE Band 4 Channel 20325 – 15MHz – QPSK										
1747.50	88.74	207	1.4	H	14.63	0.30	9.40	23.73	30	-6.27
1747.50	87.63	254	2.4	V	14.10	0.30	9.40	23.20	30	-6.80
LTE Band 4 Channel 20025 – 15MHz – 16QAM										
1717.50	88.79	300	2.2	H	14.68	0.30	9.40	23.78	30	-6.22
1717.50	87.69	309	1.2	V	14.16	0.30	9.40	23.26	30	-6.74
LTE Band 4 Channel 20175 – 15MHz – 16QAM										
1732.50	88.86	211	2.1	H	14.75	0.30	9.40	23.85	30	-6.15
1732.50	87.66	127	1.2	V	14.13	0.30	9.40	23.23	30	-6.77

LTE Band 4 Channel 20325 – 15MHz – 16QAM										
1747.50	88.91	147	2.4	H	14.80	0.30	9.40	23.90	30	-6.10
1747.50	87.49	206	1.4	V	13.96	0.30	9.40	23.06	30	-6.94
LTE Band 4 Channel 20050 – 20MHz – QPSK										
1720.00	88.87	302	2.1	H	14.76	0.30	9.40	23.86	30	-6.14
1720.00	87.45	336	2.3	V	13.92	0.30	9.40	23.02	30	-6.98
LTE Band 4 Channel 20175 – 20MHz – QPSK										
1732.50	88.92	129	1.4	H	14.81	0.30	9.40	23.91	30	-6.09
1732.50	87.41	305	1.7	V	13.88	0.30	9.40	22.98	30	-7.02
LTE Band 4 Channel 20300 – 20MHz – QPSK										
1745.00	88.98	112	1.0	H	14.87	0.30	9.40	23.97	30	-6.03
1745.00	87.54	291	1.4	V	14.01	0.30	9.40	23.11	30	-6.89
LTE Band 4 Channel 20050 – 20MHz – 16QAM										
1720.00	88.65	61	1.2	H	14.54	0.30	9.40	23.64	30	-6.36
1720.00	87.53	60	1.8	V	14.00	0.30	9.40	23.10	30	-6.90
LTE Band 4 Channel 20175 – 20MHz – 16QAM										
1732.50	88.54	164	2.2	H	14.43	0.30	9.40	23.53	30	-6.47
1732.50	87.66	249	1.7	V	14.13	0.30	9.40	23.23	30	-6.77
LTE Band 4 Channel 20300 – 20MHz – 16QAM										
1745.00	88.77	88	1.2	H	14.66	0.30	9.40	23.76	30	-6.24
1745.00	87.49	245	1.1	V	13.96	0.30	9.40	23.06	30	-6.94

## LTE Band 7

Frequency (MHz)	Receiver Reading (dBμV)	Turn table Angle Degree	RX Antenna		Substituted			Absolute Level (dBm)	Part 27	
			Height (m)	Polar (H/V)	SG Level (dBm)	Cable (dB)	Antenna Gain (dB)		Limit (dBm)	Margin (dB)
LTE Band 7 Channel 20775 – 5MHz – QPSK										
2502.50	86.35	45	1.9	H	12.35	0.43	10.60	22.52	33	-10.48
2502.50	82.42	280	2.1	V	12.14	0.43	10.60	22.31	33	-10.69
LTE Band 7 Channel 21100 – 5MHz – QPSK										
2535.00	86.30	70	2.3	H	12.30	0.43	10.60	22.47	33	-10.53
2535.00	82.45	290	2.2	V	12.17	0.43	10.60	22.34	33	-10.66
LTE Band 7 Channel 21425 – 5MHz – QPSK										
2567.50	86.31	331	1.7	H	12.20	0.43	10.60	22.37	33	-10.63
2567.50	82.47	117	2.2	V	12.28	0.43	10.60	22.45	33	-10.55
LTE Band 7 Channel 20775 – 5MHz – 16QAM										
2502.50	86.34	303	1.5	H	12.34	0.43	10.60	22.51	33	-10.49
2502.50	82.44	60	1.4	V	12.16	0.43	10.60	22.33	33	-10.67
LTE Band 7 Channel 21100 – 5MHz – 16QAM										
2535.00	86.32	177	1.6	H	12.32	0.43	10.60	22.49	33	-10.51
2535.00	82.47	315	1.2	V	12.19	0.43	10.60	22.36	33	-10.64
LTE Band 7 Channel 21425 – 5MHz – 16QAM										
2567.50	86.39	250	1.3	H	12.28	0.43	10.60	22.45	33	-10.55
2567.50	82.41	44	2.3	V	12.22	0.43	10.60	22.39	33	-10.61
LTE Band 7 Channel 20800 – 10MHz – QPSK										
2505.00	86.29	121	1.4	H	12.29	0.43	10.60	22.46	33	-10.54
2505.00	82.40	357	1.6	V	12.12	0.43	10.60	22.29	33	-10.71
LTE Band 7 Channel 21100 – 10MHz – QPSK										
2535.00	86.23	33	1.4	H	12.23	0.43	10.60	22.40	33	-10.60
2535.00	82.48	65	2.3	V	12.20	0.43	10.60	22.37	33	-10.63
LTE Band 7 Channel 21400 – 10MHz – QPSK										
2565.00	86.25	315	1.0	H	12.14	0.43	10.60	22.31	33	-10.69
2565.00	82.46	197	2.1	V	12.27	0.43	10.60	22.44	33	-10.56
LTE Band 7 Channel 20800 – 10MHz – 16QAM										
2505.00	86.28	121	2.1	H	12.28	0.43	10.60	22.45	33	-10.55
2505.00	82.43	269	2.2	V	12.15	0.43	10.60	22.32	33	-10.68
LTE Band 7 Channel 21100 – 10MHz – 16QAM										
2535.00	86.20	189	2.2	H	12.20	0.43	10.60	22.37	33	-10.63
2535.00	82.44	116	1.5	V	12.16	0.43	10.60	22.33	33	-10.67
LTE Band 7 Channel 21400 – 10MHz – 16QAM										
2565.00	86.22	70	2.5	H	12.11	0.43	10.60	22.28	33	-10.72
2565.00	82.43	183	1.1	V	12.24	0.43	10.60	22.41	33	-10.59
LTE Band 7 Channel 20825 – 15MHz – QPSK										
2507.50	86.23	351	1.4	H	12.23	0.43	10.60	22.40	33	-10.60
2507.50	82.51	307	1.8	V	12.23	0.43	10.60	22.40	33	-10.60
LTE Band 7 Channel 21100 – 15MHz – QPSK										
2535.00	86.25	23	1.8	H	12.25	0.43	10.60	22.42	33	-10.58

2535.00	82.52	4	1.8	V	12.24	0.43	10.60	22.41	33	-10.59
LTE Band 7 Channel 21375 – 15MHz – QPSK										
2562.50	86.30	106	1.1	H	12.19	0.43	10.60	22.36	33	-10.64
2562.50	82.53	326	1.1	V	12.34	0.43	10.60	22.51	33	-10.49
LTE Band 7 Channel 20825 – 15MHz – 16QAM										
2507.50	86.36	321	1.6	H	12.36	0.43	10.60	22.53	33	-10.47
2507.50	82.54	283	1.2	V	12.26	0.43	10.60	22.43	33	-10.57
LTE Band 7 Channel 21100 – 15MHz – 16QAM										
2535.00	86.36	79	1.1	H	12.36	0.43	10.60	22.53	33	-10.47
2535.00	82.56	135	1.8	V	12.28	0.43	10.60	22.45	33	-10.55
LTE Band 7 Channel 21375 – 15MHz – 16QAM										
2562.50	86.37	122	1.6	H	12.26	0.43	10.60	22.43	33	-10.57
2562.50	82.57	136	2.4	V	12.38	0.43	10.60	22.55	33	-10.45
LTE Band 7 Channel 20850 – 20MHz – QPSK										
2510.00	86.38	28	1.1	H	12.38	0.43	10.60	22.55	33	-10.45
2510.00	82.54	168	1.5	V	12.26	0.43	10.60	22.43	33	-10.57
LTE Band 7 Channel 21100 – 20MHz – QPSK										
2535.00	86.39	340	1.6	H	12.39	0.43	10.60	22.56	33	-10.44
2535.00	82.57	184	1.6	V	12.29	0.43	10.60	22.46	33	-10.54
LTE Band 7 Channel 21350 – 20MHz – QPSK										
2560.00	86.34	19	1.7	H	12.23	0.43	10.60	22.40	33	-10.60
2560.00	82.59	194	2.2	V	12.40	0.43	10.60	22.57	33	-10.43
LTE Band 7 Channel 20850 – 20MHz – 16QAM										
2510.00	86.36	59	1.8	H	12.36	0.43	10.60	22.53	33	-10.47
2510.00	82.58	56	1.1	V	12.30	0.43	10.60	22.47	33	-10.53
LTE Band 7 Channel 21100 – 20MHz – 16QAM										
2535.00	86.38	354	1.6	H	12.38	0.43	10.60	22.55	33	-10.45
2535.00	82.59	70	1.6	V	12.31	0.43	10.60	22.48	33	-10.52
LTE Band 7 Channel 21350 – 20MHz – 16QAM										
2560.00	86.39	244	1.1	H	12.28	0.43	10.60	22.45	33	-10.55
2560.00	82.55	336	2.3	V	12.36	0.43	10.60	22.53	33	-10.47

## 9 Peak-to-Average Ratio

Test Requirement:	27.50(d)
Test Method:	N/A
Test Mode:	TX transmitting

### 9.1 EUT Operation

Operating Environment :

Temperature:	22.5 °C
Humidity:	52.3% RH
Atmospheric Pressure:	101.2kPa

### 9.2 Test Procedure

1. The EUT was connected to spectrum analyzer and system simulator via a power divider.
2. Set EUT to transmit at maximum output power.
3. When the duty cycle is less than 98%, then signal gating will be implemented on the spectrum analyzer by triggering from the system simulator.
4. Set the CCDF (Complementary Cumulative Distribution Function) option of the spectrum analyzer. Record the maximum PAPR level associated with a probability of 0.1%.

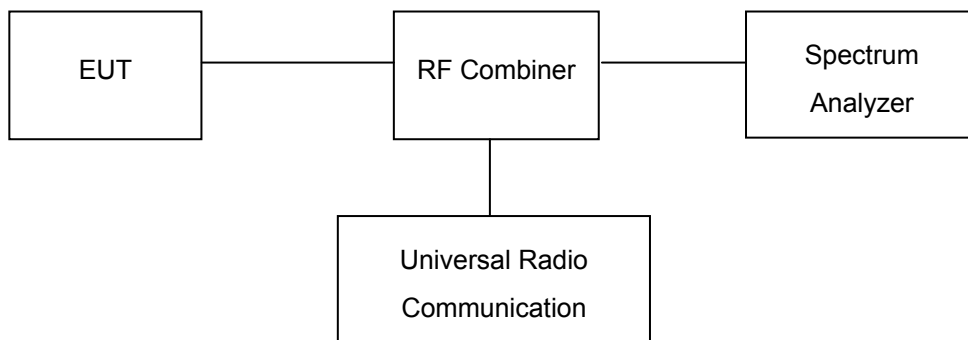

### 9.3 Test Result

PASS

#### LTE Band

Please refer to the Appendix Band 4/7 LTE Peak to Average Ratio.

## 10 BANDWIDTH

Test Requirement:	FCC Part 2.1049, 27.53(a)
Test Method:	TIA/EIA-603-D:2010 KDB971168 D01 v03
Test Mode:	TX transmitting

### 10.1 EUT Operation

Operating Environment :

Temperature:	22.5 °C
Humidity:	52.3% RH
Atmospheric Pressure:	101.2kPa

### 10.2 Test Procedure

The RF output of the transmitter was connected to the wireless test set and the spectrum analyzer through sufficient attenuation.

The resolution bandwidth of the spectrum analyzer was set in the range of 1 to 5 % of the anticipated OBW and the 26 dB & 99%bandwidth was recorded.

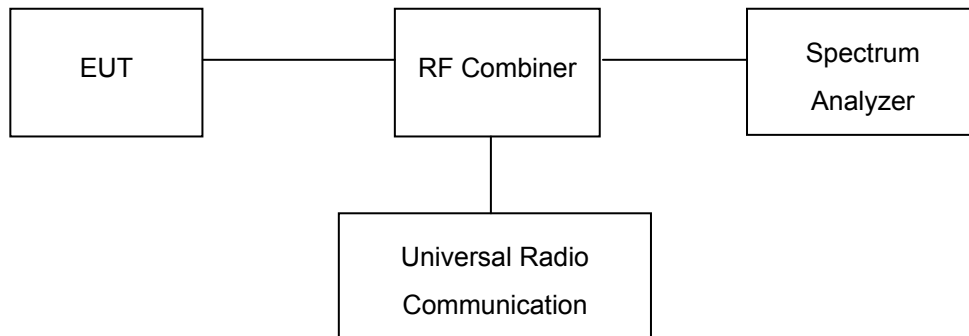

### 10.3 Test Result

#### LTE Band 4 (Part 27):

BW(MHz)	Channel	Frequency (MHz)	Modulation	99% Occupied Bandwidth (MHz)	26 dB Bandwidth (MHz)
1.4	19957	1710.7	QPSK	1.09	1.25
			16QAM	1.09	1.26
1.4	2.175	1732.5	QPSK	1.09	1.26
			16QAM	1.09	1.23
1.4	20393	1754.3	QPSK	1.09	1.28
			16QAM	1.09	1.27
3	19965	1711.5	QPSK	2.72	2.97
			16QAM	2.72	2.96
3	2.175	1732.5	QPSK	2.73	2.97
			16QAM	2.73	2.97
3	2.385	1753.5	QPSK	2.73	2.98
			16QAM	2.72	2.97
5	19975	1712.5	QPSK	4.5	4.89
			16QAM	4.5	4.85
5	20175	1732.5	QPSK	4.5	4.87
			16QAM	4.5	4.89
5	20375	1752.5	QPSK	4.5	4.88
			16QAM	4.5	4.88
10	2000	1715	QPSK	8.92	9.42
			16QAM	8.92	9.4
10	20175	1732.5	QPSK	8.91	9.41
			16QAM	8.91	9.39
10	20350	1750	QPSK	8.93	9.39
			16QAM	8.93	9.42
15	20025	1717.5	QPSK	13.46	14.27
			16QAM	13.46	14.25
15	20175	1732.5	QPSK	13.46	14.31
			16QAM	13.45	14.28
15	20325	1747.5	QPSK	13.48	14.29
			16QAM	13.48	14.28
20	20050	1720	QPSK	17.9	18.77

			16QAM	17.9	18.77
20	20175	1732.5	QPSK	17.88	18.78
			16QAM	17.87	18.78
20	20300	1745	QPSK	17.92	18.78
			16QAM	17.93	18.8

**LTE Band 7 (Part 27):**

BW(MHz)	Channel	Frequency (MHz)	Modulation	99% Occupied Bandwidth (MHz)	26 dB Bandwidth (MHz)
5	20775	2502.5	QPSK	4.5	4.83
			16QAM	4.5	4.85
5	21100	2535	QPSK	4.5	4.89
			16QAM	4.5	4.87
5	21425	2567.5	QPSK	4.5	4.85
			16QAM	4.5	4.87
10	20850	2510	QPSK	8.94	9.43
			16QAM	8.93	9.4
10	21100	2535	QPSK	8.92	9.36
			16QAM	8.91	9.37
10	21400	2565	QPSK	8.92	9.38
			16QAM	8.92	9.38
15	20800	2505	QPSK	13.49	14.28
			16QAM	13.49	14.29
15	21100	2535	QPSK	13.46	14.26
			16QAM	13.44	14.26
15	21375	2562.5	QPSK	13.44	14.33
			16QAM	13.44	14.28
20	20825	2507.5	QPSK	17.92	18.78
			16QAM	17.92	18.79
20	21100	2535	QPSK	17.88	18.77
			16QAM	17.88	18.77
20	21350	2560	QPSK	17.86	18.78
			16QAM	17.87	18.79



**Test Plots  
LTE Band 4 (Part 27)**

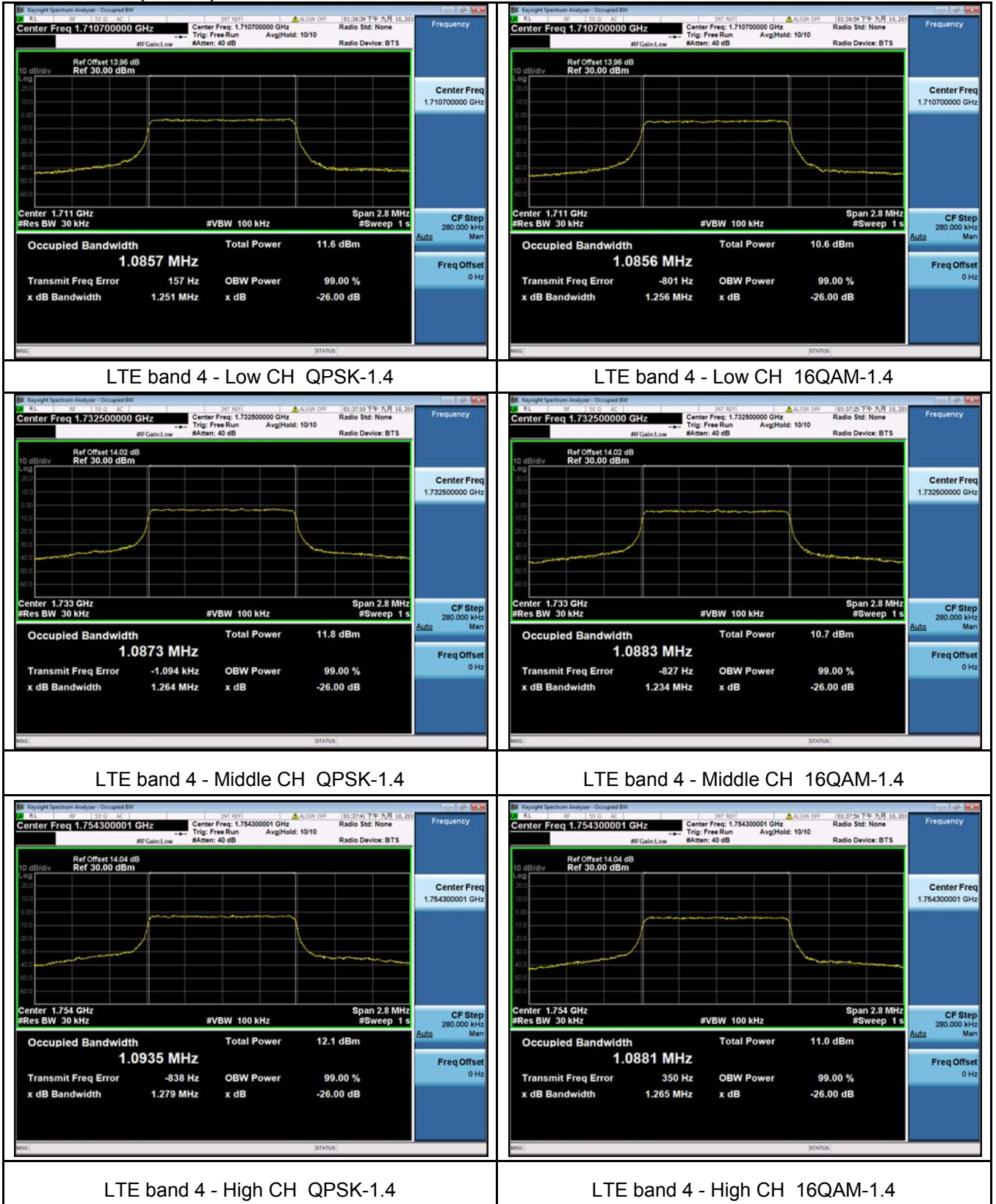

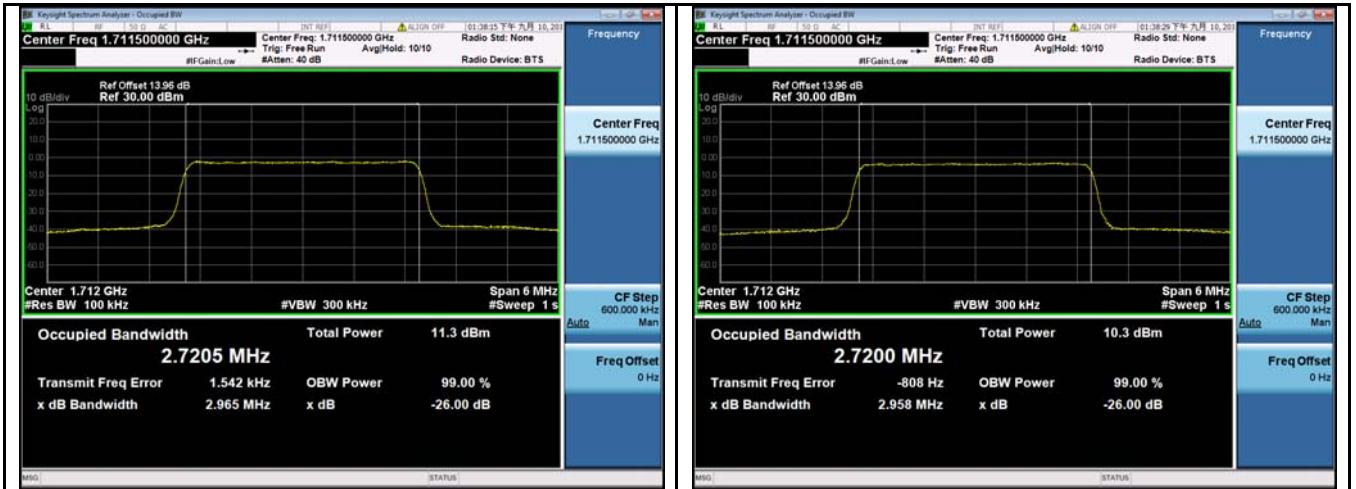

LTE band 4 - Low CH QPSK-3

LTE band 4 - Low CH 16QAM-3

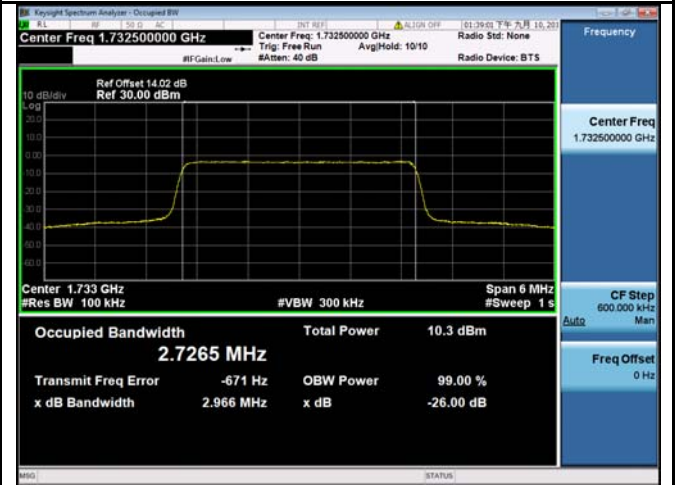
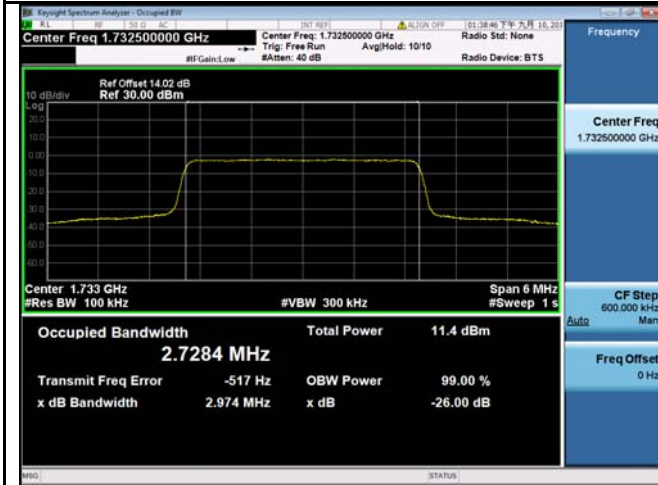

LTE band 4 - Middle CH QPSK-3

LTE band 4 - Middle CH 16QAM-3

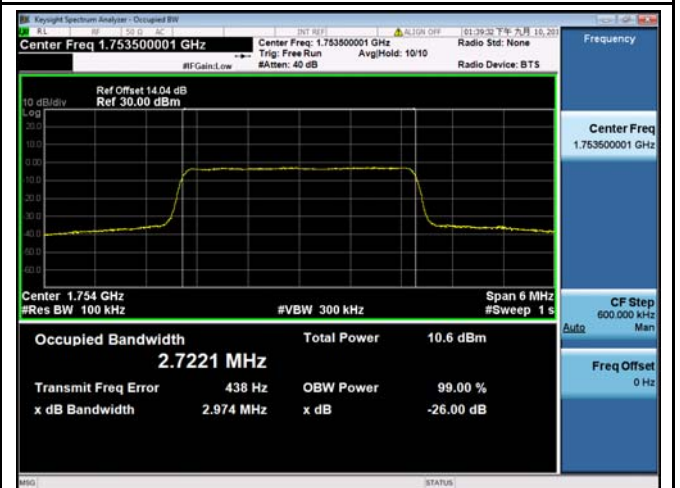
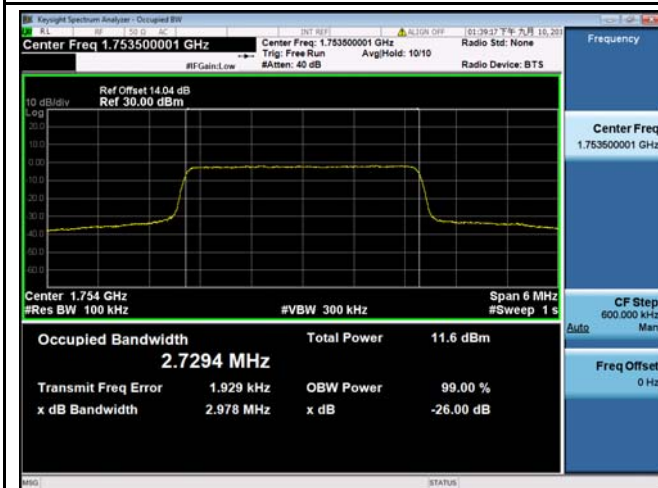

LTE band 4 - High CH QPSK-3

LTE band 4 - High CH 16QAM-3

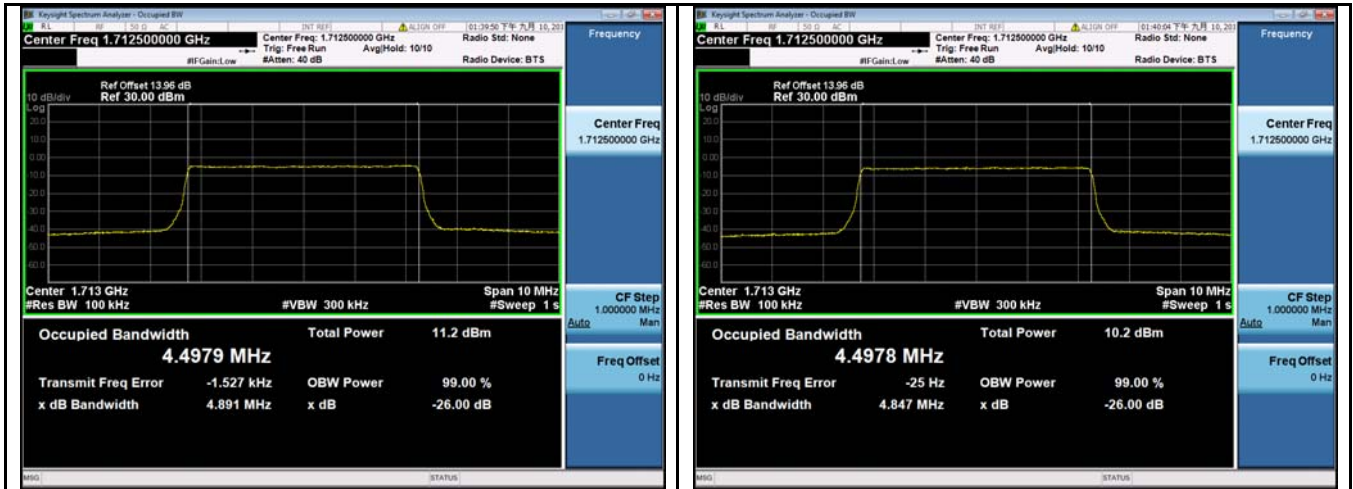

LTE band 4 - Low CH QPSK-5

LTE band 4 - Low CH 16QAM-5

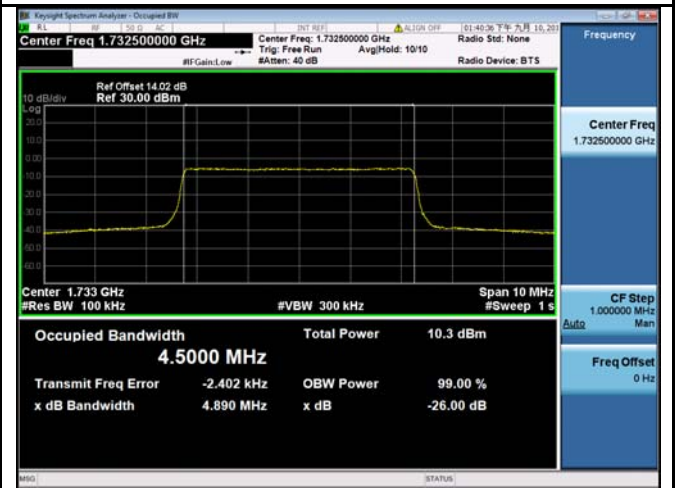
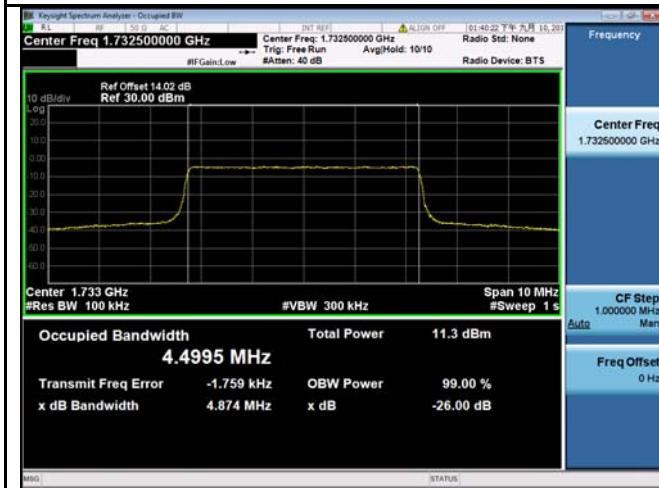

LTE band 4 - Middle CH QPSK-5

LTE band 4 - Middle CH 16QAM-5

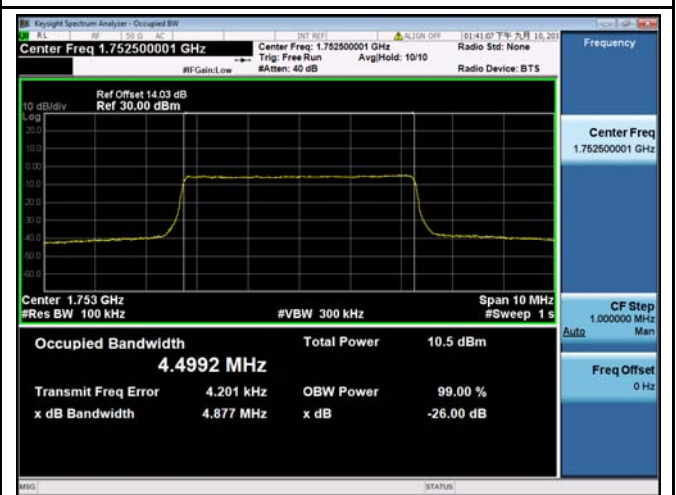
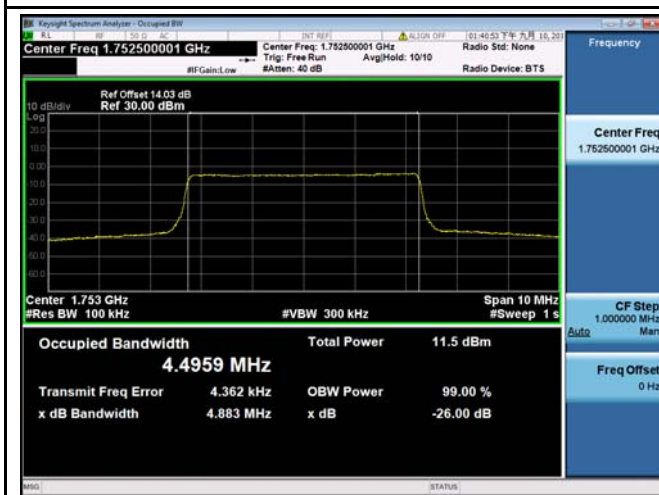

LTE band 4 - High CH QPSK-5

LTE band 4 - High CH 16QAM-5



LTE band 4 - Low CH QPSK-10

LTE band 4 - Low CH 16QAM-10

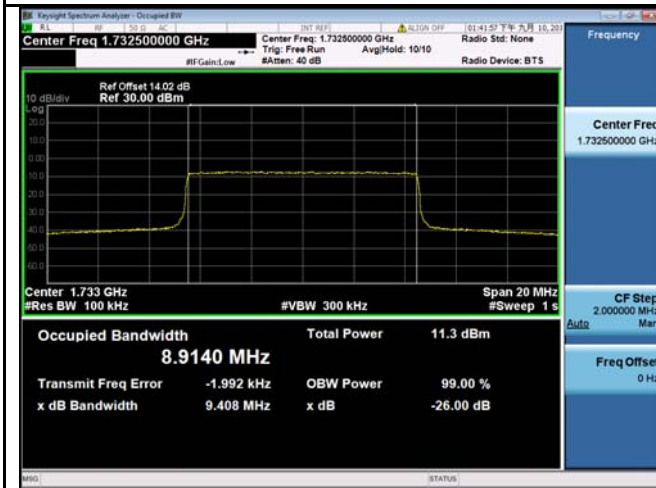

LTE band 4 - Middle CH QPSK-10

LTE band 4 - Middle CH 16QAM-10

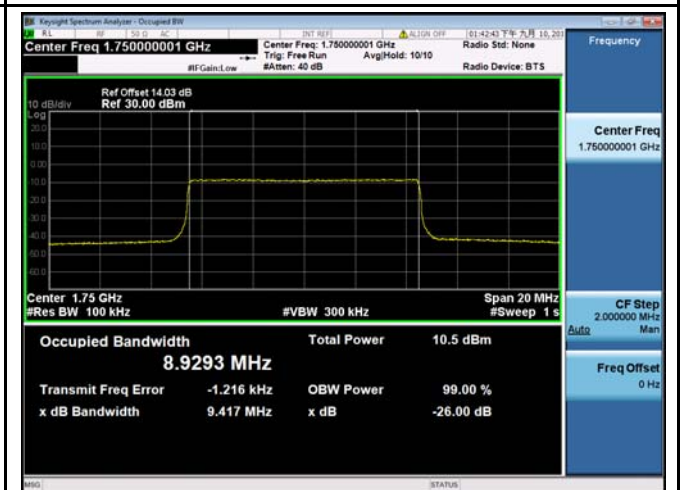
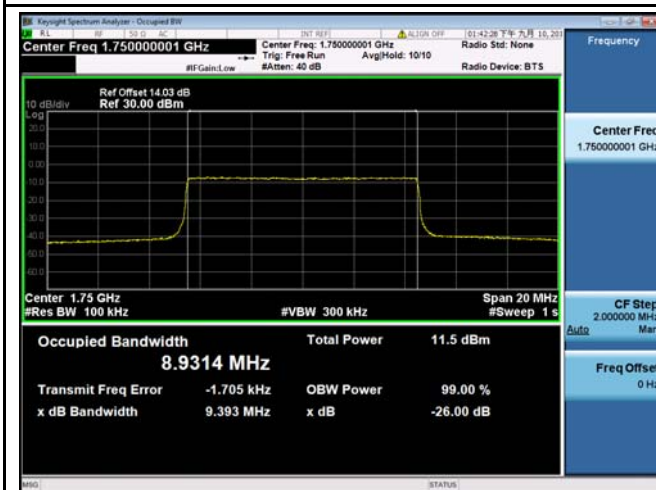

LTE band 4 - High CH QPSK-10

LTE band 4 - High CH 16QAM-10



LTE band 4 - Low CH QPSK-15

LTE band 4 - Low CH 16QAM-15

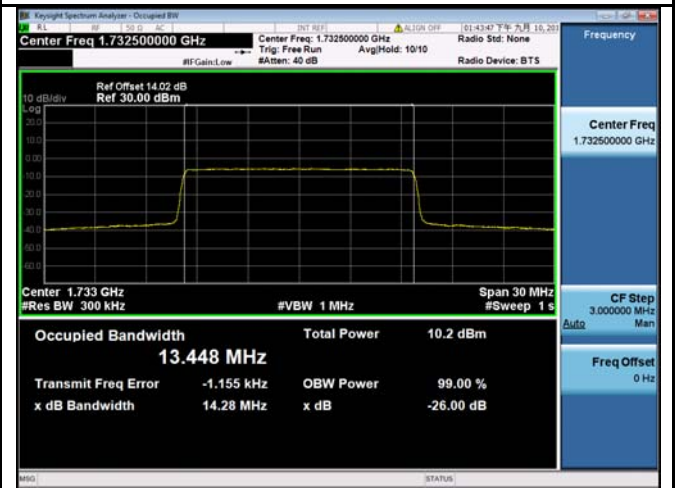
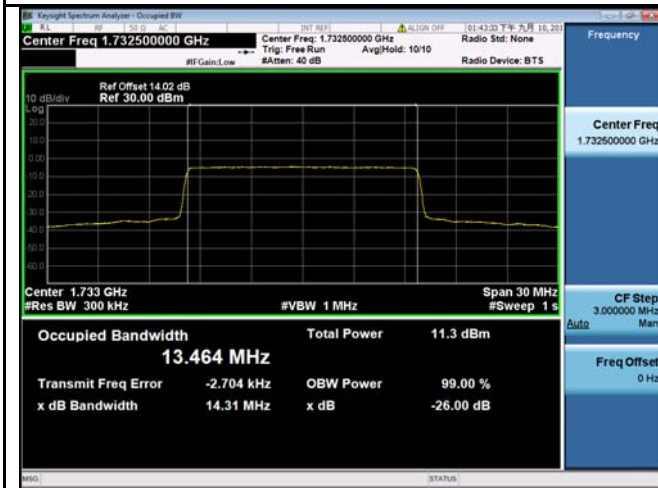

LTE band 4 - Middle CH QPSK-15

LTE band 4 - Middle CH 16QAM-15

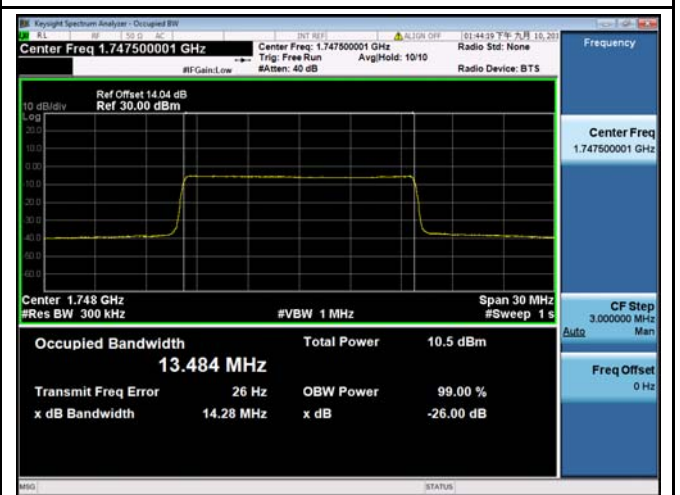
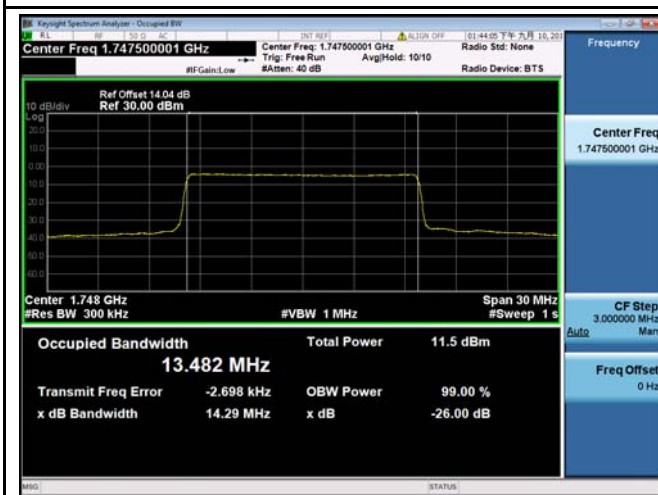

LTE band 4 - High CH QPSK-15

LTE band 4 - High CH 16QAM-15



LTE band 4 - Low CH QPSK-20

LTE band 4 - Low CH 16QAM-20



LTE band 4 - Middle CH QPSK-20

LTE band 4 - Middle CH 16QAM-20



LTE band 4 - High CH QPSK-20

LTE band 4 - High CH 16QAM-20

LTE Band 7 (Part 27)





LTE band 7 - Low CH QPSK-10

LTE band 7 - Low CH 16QAM-10



LTE band 7 - Middle CH QPSK-10

LTE band 7 - Middle CH 16QAM-10

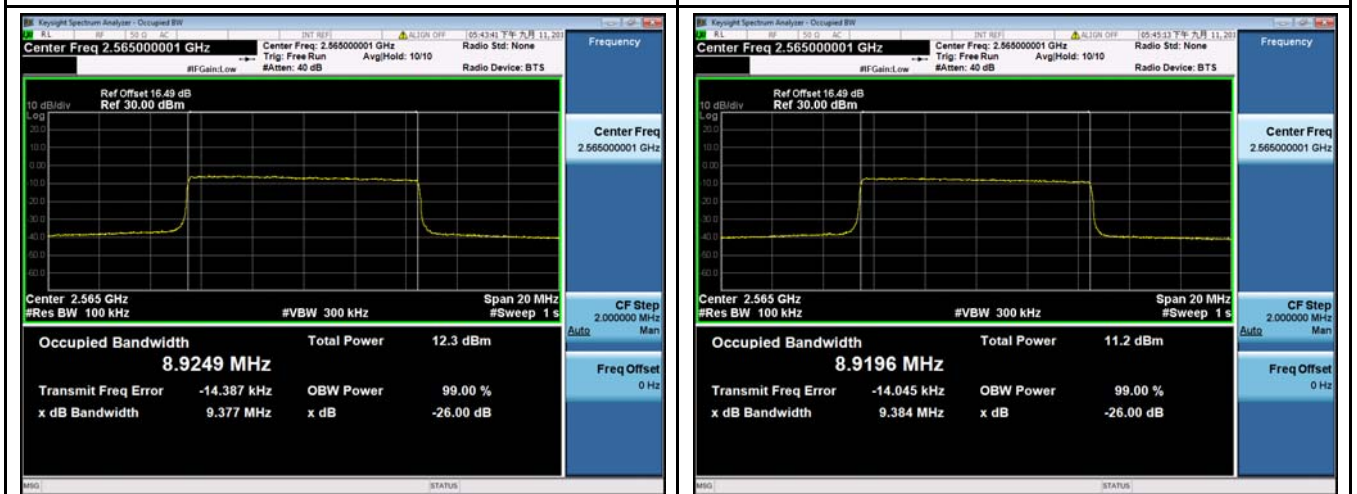

LTE band 7 - High CH QPSK-10

LTE band 7 - High CH 16QAM-10





LTE band 7 - Low CH QPSK-15

LTE band 7 - Low CH 16QAM-15

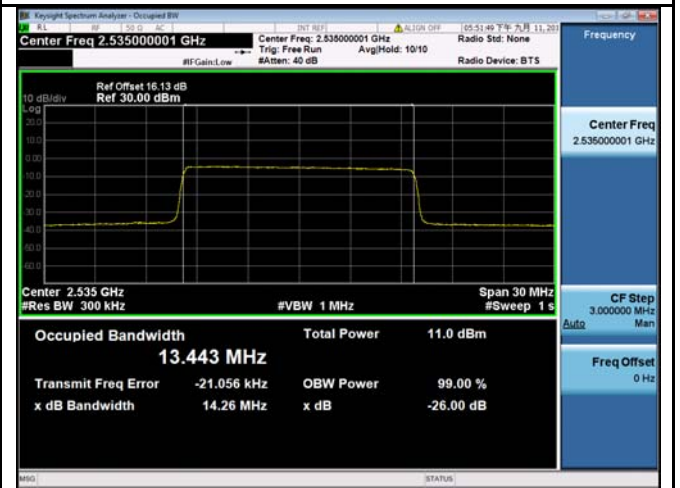
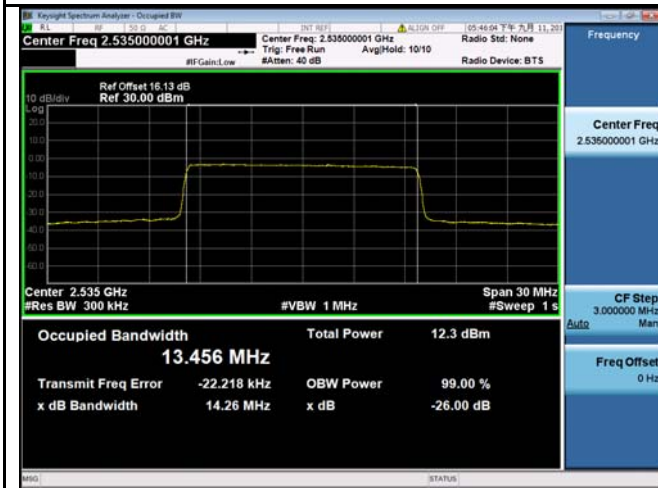

LTE band 7 - Middle CH QPSK-15

LTE band 7 - Middle CH 16QAM-15

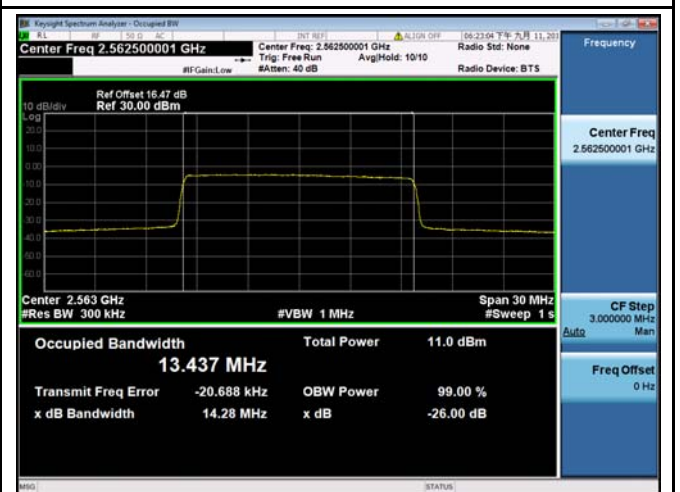

LTE band 7 - High CH QPSK-15

LTE band 7 - High CH 16QAM-15



LTE band 7 - Low CH QPSK-20

LTE band 7 - Low CH 16QAM-20



LTE band 7 - Middle CH QPSK-20

LTE band 7 - Middle CH 16QAM-20

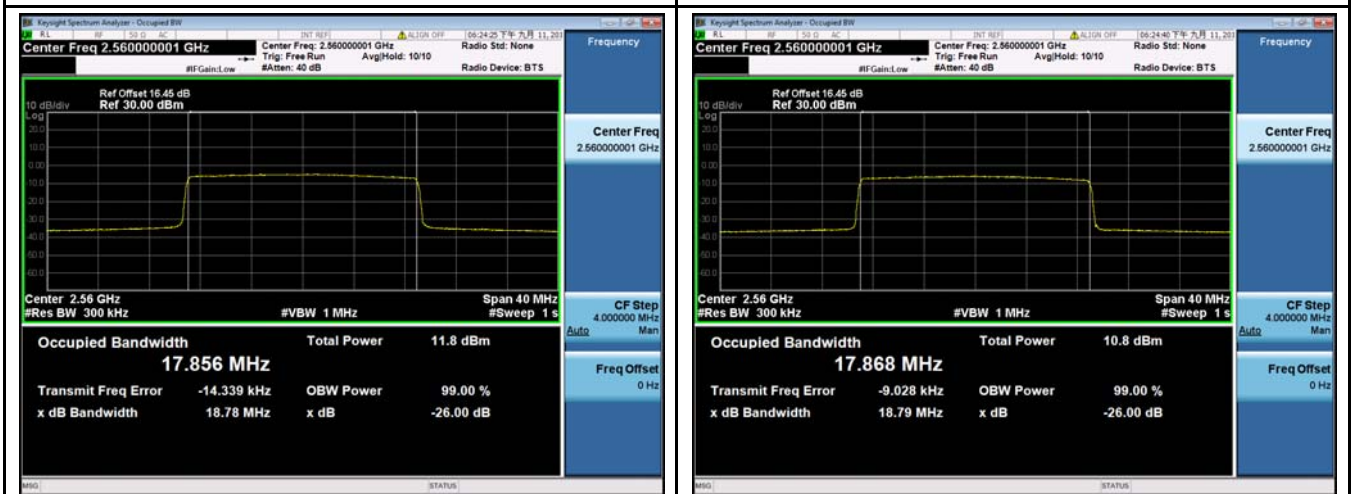

LTE band 7 - High CH QPSK-20

LTE band 7 - High CH 16QAM-20

## 11 SPURIOUS EMISSIONS AT ANTENNA TERMINALS

Test Requirement:	FCC Part 2.1051, 27.53(h), 27.53(m)(4)
Test Method:	TIA/EIA-603-D:2010 KDB971168 D01 v03
Test Mode:	TX transmitting

### 11.1 EUT Operation

Operating Environment :

Temperature:	23.5 °C
Humidity:	52.1 % RH
Atmospheric Pressure:	101.3kPa

### 11.2 Test Procedure

The RF output of the transceiver was connected to a spectrum analyzer and simulator through appropriate attenuation. The resolution bandwidth of the spectrum analyzer was set at 1MHz. Sufficient scans were taken to show any out of band emissions up to 10th harmonics.

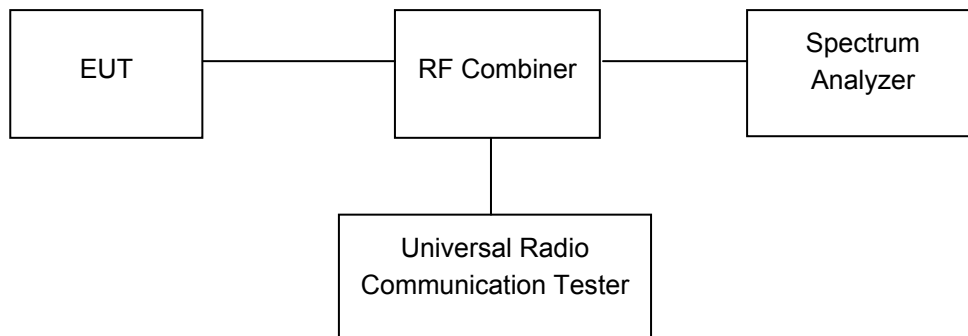

### 11.3 Test Result

PASS

#### LTE Band

Please refer to the Appendix Band 4/7 LTE Transmitter Spurious Emissions.

## 12 SPURIOUS RADIATED EMISSIONS

Test Requirement:	FCC Part 2.1053, 27.53(h), 27.53(m)(4)
Test Method:	TIA/EIA-603-D:2010 KDB971168 D01 v03
Test Mode:	TX transmitting

### 12.1 EUT Operation

Operating Environment :	
Temperature:	23.5 °C
Humidity:	52.1 % RH
Atmospheric Pressure:	101.2kPa

### 12.2 Test Setup

The radiated emission tests were performed in the 3m Semi- Anechoic Chamber test site. The test setup for emission measurement from 30 MHz to 1 GHz.

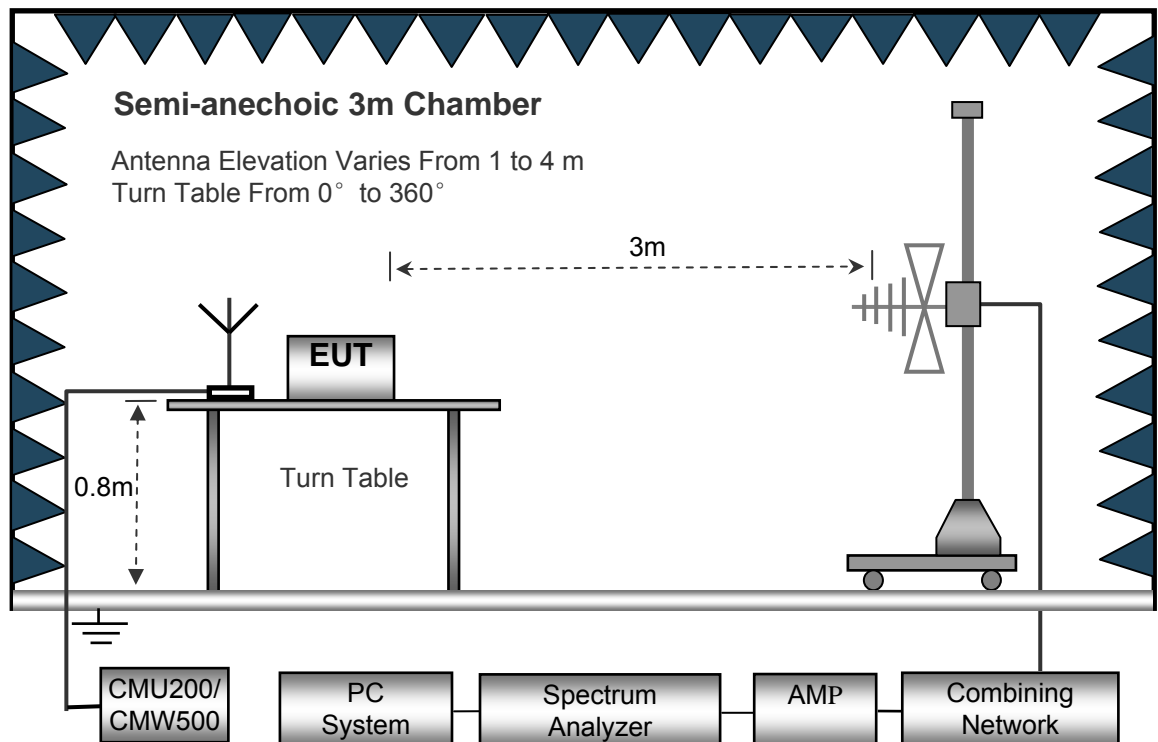

The test setup for emission measurement above 1 GHz.

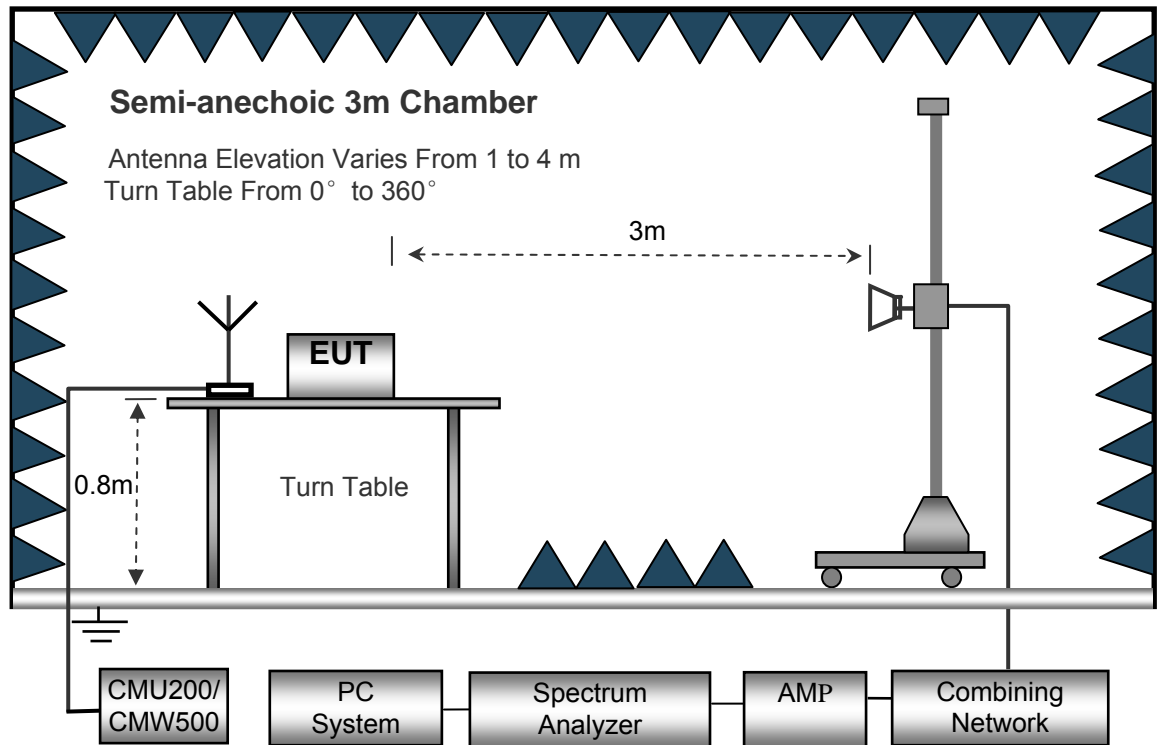

### 12.3 Spectrum Analyzer Setup

30MHz ~ 1GHz

Sweep Speed ..... Auto  
 Detector ..... PK  
 Resolution Bandwidth..... 100kHz  
 Video Bandwidth..... 300kHz

Above 1GHz

Sweep Speed ..... Auto  
 Detector ..... PK  
 Resolution Bandwidth..... 1MHz  
 Video Bandwidth..... 3MHz  
 Detector ..... Ave.  
 Resolution Bandwidth..... 1MHz  
 Video Bandwidth..... 10Hz

## 12.4 Test Procedure

1. The EUT is placed on a turntable, which is 0.8m above ground plane.
2. The turntable shall be rotated for 360 degrees to determine the position of maximum emission level.
3. EUT is set 3m away from the receiving antenna, which is moved from 1m to 4m to find out the maximum emissions. The spectrum was investigated from 30MHz up to the tenth harmonic of the highest fundamental frequency.
4. Maximum procedure was performed on the six highest emissions to ensure EUT compliance.
5. And also, each emission was to be maximized by changing the polarization of receiving antenna both horizontal and vertical.
6. The radiation measurements are tested under 3-axes(X,Y,Z) position(X denotes lying on the table, Y denotes side stand and Z denotes vertical stand), After pre-test, It was found that the worse radiation emission was get at the Z position. So the data shown was the Z position only.
7. Remove the EUT and replace it with substitution antenna. A signal generator was connected to the substitution antenna by a non-radiating cable. The absolute levels of the spurious emissions were measured by the substitution.  
Spurious emissions in dB =  $10 \lg (\text{TXpwr in Watts}/0.001)$  – the absolute level  
Spurious attenuation limit in dB =  $43 + 10 \text{Log}10 (\text{power out in Watts})$
8. Repeat above procedures until the measurements for all frequencies are completed.

## 12.5 Summary of Test Results

Remark: Test performed from 30MHz to 10<sup>th</sup> harmonics with low/middle/high channels, only the worst data were recorded.

### LTE Band 4

Frequency (MHz)	Receiver Reading (dBμV)	Turn table Angle Degree	RX Antenna		Substituted			Absolute Level (dBm)	Result	
			Height (m)	Polar (H/V)	SG Level (dBm)	Cable (dB)	Antenna Gain (dB)		Limit (dBm)	Margin (dB)
LTE BAND 4 Channel 19957										
223.12	38.41	252	2.0	H	-72.10	0.15	0.00	-72.25	-13.00	-59.25
223.12	31.16	308	2.0	V	-76.43	0.15	0.00	-76.58	-13.00	-63.58
3421.40	65.95	126	1.2	H	-47.10	2.34	12.40	-37.04	-13.00	-24.04
3421.40	59.98	237	1.9	V	-51.17	2.34	12.40	-41.11	-13.00	-28.11
5132.10	53.58	258	1.9	H	-55.83	2.79	12.70	-45.92	-13.00	-32.92
5132.10	44.73	345	1.2	V	-64.04	2.79	12.70	-54.13	-13.00	-41.13
LTE BAND 4 Channel 20175										
223.12	38.09	265	1.1	H	-72.42	0.15	0.00	-72.57	-13.00	-59.57
223.12	30.71	238	2.1	V	-76.88	0.15	0.00	-77.03	-13.00	-64.03
3465.00	59.12	8	1.3	H	-53.93	2.37	12.50	-43.80	-13.00	-30.80
3465.00	53.62	60	1.6	V	-57.53	2.37	12.50	-47.40	-13.00	-34.40
5197.50	45.70	108	1.3	H	-63.71	2.79	12.70	-53.80	-13.00	-40.80
5197.50	37.67	222	1.6	V	-71.10	2.79	12.70	-61.19	-13.00	-48.19
LTE BAND 4 Channel 20393										
223.12	37.18	35	1.3	H	-73.33	0.15	0.00	-73.48	-13.00	-60.48
223.12	30.68	201	2.1	V	-76.91	0.15	0.00	-77.06	-13.00	-64.06
3508.60	52.27	132	1.4	H	-60.37	2.37	12.50	-50.24	-13.00	-37.24
3508.60	46.88	351	2.0	V	-63.85	2.37	12.50	-53.72	-13.00	-40.72
5262.90	38.31	3	1.8	H	-71.27	2.81	12.80	-61.28	-13.00	-48.28
5262.90	31.03	197	2.1	V	-77.77	2.81	12.80	-67.78	-13.00	-54.78

## LTE Band 7

Frequency	Receiver Reading	Turn table Angle	RX Antenna		Substituted			Absolute Level	Result	
			Height	Polar	SG Level	Cable	Antenna Gain		Limit	Margin
(MHz)	(dBμV)	Degree	(m)	(H/V)	(dBm)	(dB)	(dB)	(dBm)	(dBm)	(dB)
LTE BAND 7 Channel 20775										
223.12	37.56	276	1.2	H	-72.95	0.15	0.00	-73.10	-25.00	-48.10
223.12	30.90	276	1.9	V	-76.69	0.15	0.00	-76.84	-25.00	-51.84
5005.00	65.95	209	1.6	H	-43.29	2.79	12.70	-33.38	-25.00	-8.38
5005.00	59.98	157	2.2	V	-48.79	2.79	12.70	-38.88	-25.00	-13.88
7507.50	53.58	261	1.9	H	-52.96	3.12	11.50	-44.58	-25.00	-19.58
7507.50	44.73	160	1.3	V	-60.70	3.12	11.50	-52.32	-25.00	-27.32
LTE BAND 7 Channel 21100										
223.12	37.39	86	1.7	H	-73.12	0.15	0.00	-73.27	-25.00	-48.27
223.12	31.01	345	1.6	V	-76.58	0.15	0.00	-76.73	-25.00	-51.73
5070.00	58.57	131	1.9	H	-50.67	2.37	12.50	-40.54	-25.00	-15.54
5070.00	52.91	132	1.7	V	-55.86	2.37	12.50	-45.73	-25.00	-20.73
7605.00	45.92	215	1.6	H	-60.62	3.12	11.50	-52.24	-25.00	-27.24
7605.00	37.78	33	1.3	V	-67.65	3.12	11.50	-59.27	-25.00	-34.27
LTE BAND 7 Channel 21425										
223.12	37.39	349	1.5	H	-73.12	0.15	0.00	-73.27	-25.00	-48.27
223.12	30.15	81	1.0	V	-77.44	0.15	0.00	-77.59	-25.00	-52.59
5135.00	50.93	128	1.6	H	-58.48	2.37	12.50	-48.35	-25.00	-23.35
5135.00	46.77	121	2.0	V	-62.00	2.37	12.50	-51.87	-25.00	-26.87
7702.50	39.08	270	2.1	H	-66.15	3.12	11.50	-57.77	-25.00	-32.77
7702.50	31.09	258	1.0	V	-73.80	3.12	11.50	-65.42	-25.00	-40.42

Note: 1) Absolute Level = SG Level - Cable loss + Antenna Gain

2) Margin = Absolute Level - Limit



## 13 Band Edge Measurement

Test Requirement:	FCC Part 2.1051, 27.53(h), 27.53(m)(4)
Test Method:	TIA/EIA-603-D:2010 KDB971168 D01 v03
Test Mode:	TX transmitting

### 13.1 EUT Operation

Operating Environment :

Temperature:	23.5 °C
Humidity:	52.3 % RH
Atmospheric Pressure:	101.3kPa

### 13.2 Test Procedure

The RF output of the transmitter was connected to the input of the spectrum analyzer through sufficient attenuation.

According to FCC Part 22.917(a), the power of any emissions outside of the authorized operating frequency ranges must be attenuated below the TX transmitting power (P) by a factor of at least  $43 + 10 \log(P)$  dB.

According to FCC Part 24.238(a), the power of any emissions outside of the authorized operating frequency ranges must be attenuated below the TX transmitting power (P) by a factor of at least  $43 + 10 \log(P)$  dB.

According to FCC Part 27.53(h), Except as otherwise specified below, for operations in the 1695-1710 MHz, 1710-1755 MHz, 1755-1780 MHz, 1915-1920 MHz, 1995-2000 MHz, 2000-2020 MHz, 2110-2155 MHz, 2155-2180 MHz, and 2180-2200 bands, the power of any emission outside a licensee's frequency block shall be attenuated below the transmitter power (P) in watts by at least  $43 + 10 \log_{10}(P)$  dB.

According to FCC Part 27.53(m)(4), For mobile digital stations, the attenuation factor shall be not less than  $40 + 10 \log(P)$  dB on all frequencies between the channel edge and 5 megahertz from the channel edge,  $43 + 10 \log(P)$  dB on all frequencies between 5 megahertz and X megahertz from the channel edge, and  $55 + 10 \log(P)$  dB on all frequencies more than X megahertz from the channel edge, where X is the greater of 6 megahertz or the actual emission bandwidth as defined in paragraph (m)(6) of this section. In addition, the attenuation factor shall not be less than  $43 + 10 \log(P)$  dB on all frequencies between 2490.5 MHz and 2496 MHz and  $55 + 10 \log(P)$  dB at or below 2490.5 MHz. Mobile Satellite Service licensees operating on frequencies below 2495 MHz may also submit a documented interference complaint against BRS licensees operating on channel BRS Channel 1 on the same terms and conditions as adjacent channel BRS or EBS licensees.

The center of the spectrum analyzer was set to block edge frequency  
Waltek Services (Shenzhen) Co.,Ltd.  
<http://www.waltek.com.cn>

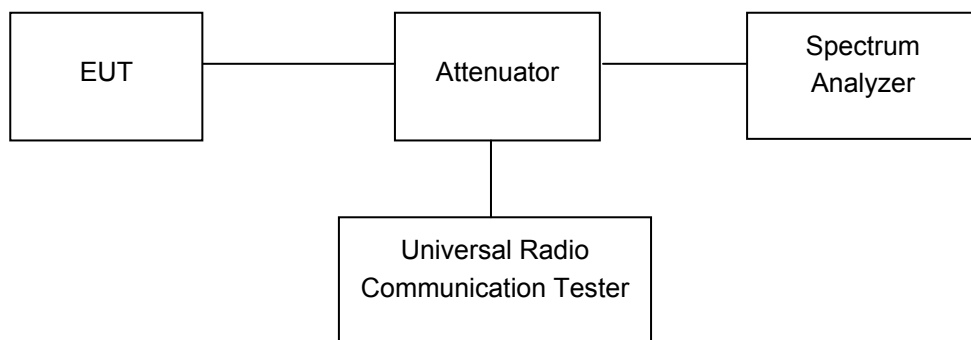

### 13.3 Test Result

PASS

#### LTE Band

Please refer to the Appendix Band 4/7 LTE Band Edge.

## 14 FREQUENCY STABILITY

Test Requirement:	FCC Part 2.1055, 27.5(h),27.54
Test Method:	TIA/EIA-603-D:2010 KDB971168 D01 v03
Test Mode:	TX transmitting

### 14.1 EUT Operation

Operating Environment :	
Temperature:	22.9 °C
Humidity:	52.0 % RH
Atmospheric Pressure:	101.3kPa

### 14.2 Test Procedure

Frequency Stability vs. Temperature: The equipment under test was connected to an external DC power supply and the RF output was connected to communication test set via feed-through attenuators. The EUT was placed inside the temperature chamber. The DC leads and RF output cable exited the chamber through an opening made for the purpose.

After the temperature stabilized for approximately 20 minutes, the frequency output was recorded from the communication test set.

Frequency Stability vs. Voltage: For hand carried, battery powered equipment; reduce primary supply voltage to the battery operating end point which shall be specified by the manufacturer.

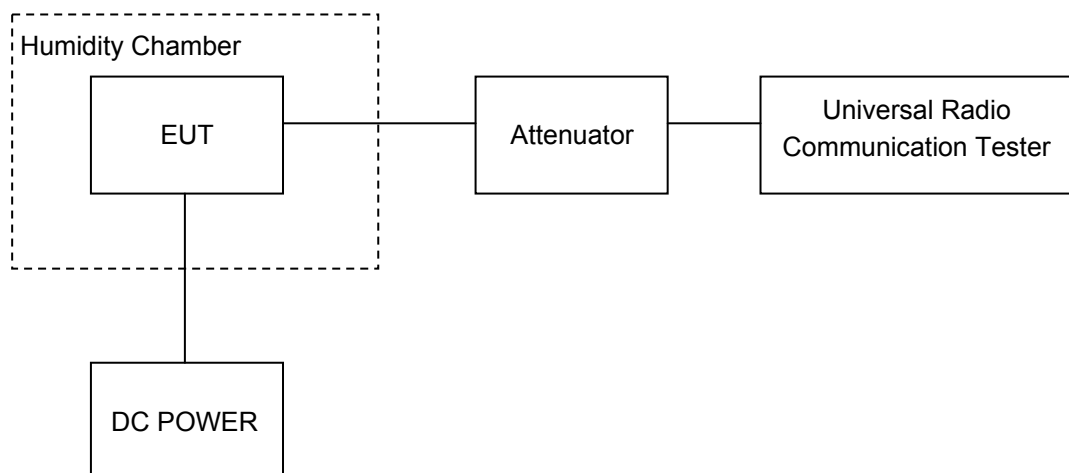

### 14.3 Test Result

LTE Band 4

Test Frequency:1732.5MHz QPSK 1.4MHz				
Temperature (°C)	Power Supply (VDC)	Frequency Error (Hz)	Frequency Error (ppm)	Limit (ppm)
50	3.7	7	0.0040	2.5
40		6	0.0035	2.5
30		9	0.0052	2.5
20		2	0.0010	2.5
10		-1	-0.0006	2.5
0		-1	-0.0006	2.5
-10		6	0.0035	2.5
-20		7	0.0040	2.5
-30		-5	-0.0029	2.5
20		3.3	-3	-0.0017
20	4.1	9	0.0052	2.5

Test Frequency:1732.5MHz 16QAM 1.4MHz				
Temperature (°C)	Power Supply (VDC)	Frequency Error (Hz)	Frequency Error (ppm)	Limit (ppm)
50	3.7	6	0.0035	2.5
40		5	0.0029	2.5
30		-5	-0.0029	2.5
20		3	0.0017	2.5
10		10	0.0058	2.5
0		11	0.0063	2.5
-10		2	0.0012	2.5
-20		7	0.0040	2.5
-30		-4	-0.0023	2.5
20		3.3	8	0.0046
20	4.1	-2	-0.0012	2.5

## LTE Band 4

Test Frequency:1732.5MHz QPSK 3MHz				
Temperature (°C)	Power Supply (VDC)	Frequency Error (Hz)	Frequency Error (ppm)	Limit (ppm)
50	3.7	1	0.0006	2.5
40		4	0.0023	2.5
30		4	0.0023	2.5
20		5	0.0029	2.5
10		7	0.0040	2.5
0		12	0.0069	2.5
-10		13	0.0075	2.5
-20		11	0.0063	2.5
-30		-3	-0.0017	2.5
20		3.3	14	0.0081
20	4.1	4	0.0023	2.5

Test Frequency:1732.5MHz 16QAM 3MHz				
Temperature (°C)	Power Supply (VDC)	Frequency Error (Hz)	Frequency Error (ppm)	Limit (ppm)
50	3.7	6	0.0035	2.5
40		1	0.0006	2.5
30		4	0.0023	2.5
20		0	0.0000	2.5
10		8	0.0046	2.5
0		-2	-0.0012	2.5
-10		6	0.0035	2.5
-20		9	0.0052	2.5
-30		2	0.0012	2.5
20		3.3	-9	-0.0052
20	4.1	-3	-0.0017	2.5

## LTE Band 4

Test Frequency:1732.5MHz QPSK 5MHz				
Temperature (°C)	Power Supply (VDC)	Frequency Error (Hz)	Frequency Error (ppm)	Limit (ppm)
50	3.7	(Hz)	(ppm)	(ppm)
40		4	0.0023	2.5
30		0	0.0000	2.5
20		13	0.0075	2.5
10		5	0.0029	2.5
0		12	0.0069	2.5
-10		11	0.0063	2.5
-20		10	0.0058	2.5
-30		2	0.0012	2.5
20		3.3	6	0.0035
20	4.1	3	0.0017	2.5

Test Frequency:1732.5MHz 16QAM 5MHz				
Temperature (°C)	Power Supply (VDC)	Frequency Error (Hz)	Frequency Error (ppm)	Limit (ppm)
50	3.7	1	0.0006	2.5
40		-2	-0.0012	2.5
30		7	0.0040	2.5
20		6	0.0035	2.5
10		0	0.0000	2.5
0		4	0.0023	2.5
-10		-1	-0.0006	2.5
-20		5	0.0029	2.5
-30		-1	-0.0006	2.5
20		3.3	9	0.0052
20	4.1	9	0.0052	2.5

## LTE Band 4

Test Frequency:1732.5MHz QPSK 10MHz				
Temperature (°C)	Power Supply (VDC)	Frequency Error (Hz)	Frequency Error (ppm)	Limit (ppm)
50	3.7	13	0.0075	2.5
40		13	0.0075	2.5
30		-2	-0.0012	2.5
20		7	0.0040	2.5
10		13	0.0075	2.5
0		2	0.0012	2.5
-10		0	0.0000	2.5
-20		5	0.0029	2.5
-30		3	0.0017	2.5
20		3.3	15	0.0087
20	4.1	8	0.0046	2.5

Test Frequency:1732.5MHz 16QAM 10MHz				
Temperature (°C)	Power Supply (VDC)	Frequency Error (Hz)	Frequency Error (ppm)	Limit (ppm)
50	3.7	-7	-0.0040	2.5
40		-2	-0.0012	2.5
30		1	0.0006	2.5
20		-1	-0.0006	2.5
10		-9	-0.0052	2.5
0		-8	-0.0046	2.5
-10		-5	-0.0029	2.5
-20		8	0.0046	2.5
-30		-2	-0.0012	2.5
20		3.3	6	0.0035
20	4.1	-6	-0.0035	2.5

## LTE Band 4

Test Frequency:1732.5MHz QPSK 15MHz				
Temperature (°C)	Power Supply (VDC)	Frequency Error (Hz)	Frequency Error (ppm)	Limit (ppm)
50	3.7	1	0.0006	2.5
40		7	0.0040	2.5
30		6	0.0035	2.5
20		-2	-0.0012	2.5
10		-2	-0.0012	2.5
0		-7	-0.0040	2.5
-10		-8	-0.0046	2.5
-20		-10	-0.0058	2.5
-30		-10	-0.0058	2.5
20		3.3	-6	-0.0035
20	4.1	-1	-0.0006	2.5

Test Frequency:1732.5MHz 16QAM 15MHz				
Temperature (°C)	Power Supply (VDC)	Frequency Error (Hz)	Frequency Error (ppm)	Limit (ppm)
50	3.7	1	0.0006	2.5
40		-5	-0.0029	2.5
30		-9	-0.0052	2.5
20		-3	-0.0017	2.5
10		-5	-0.0029	2.5
0		-6	-0.0035	2.5
-10		-3	-0.0017	2.5
-20		-4	-0.0023	2.5
-30		4	0.0023	2.5
20		3.3	-6	-0.0035
20	4.1	-6	-0.0035	2.5



## LTE Band 4

Test Frequency:1732.5MHz QPSK 20MHz				
Temperature (°C)	Power Supply (VDC)	Frequency Error (Hz)	Frequency Error (ppm)	Limit (ppm)
50	3.7	-11	-0.0063	2.5
40		-13	-0.0075	2.5
30		-1	-0.0006	2.5
20		-4	-0.0023	2.5
10		-11	-0.0063	2.5
0		-4	-0.0023	2.5
-10		-12	-0.0069	2.5
-20		2	0.0012	2.5
-30		3	0.0017	2.5
20		3.3	3	0.0017
20	4.1	-7	-0.0040	2.5

Test Frequency:1732.5MHz 16QAM 20MHz				
Temperature (°C)	Power Supply (VDC)	Frequency Error (Hz)	Frequency Error (ppm)	Limit (ppm)
50	3.7	-5	-0.0029	2.5
40		0	0.0000	2.5
30		-2	-0.0012	2.5
20		-5	-0.0029	2.5
10		-7	-0.0040	2.5
0		-9	-0.0052	2.5
-10		-4	-0.0023	2.5
-20		-13	-0.0075	2.5
-30		-2	-0.0012	2.5
20		3.3	-9	-0.0052
20	4.1	-10	-0.0058	2.5

## LTE Band 7

Test Frequency:2535MHz QPSK 5MHz				
Temperature (°C)	Power Supply (VDC)	Frequency Error (Hz)	Frequency Error (ppm)	Limit (ppm)
50	3.7	2	0.0008	2.5
40		5	0.0020	2.5
30		9	0.0036	2.5
20		3	0.0012	2.5
10		8	0.0032	2.5
0		5	0.0020	2.5
-10		4	0.0016	2.5
-20		0	0.0000	2.5
-30		9	0.0036	2.5
20		3.3	0	0.0000
20	4.1	-5	-0.0020	2.5

Test Frequency:2535MHz 16QAM 5MHz				
Temperature (°C)	Power Supply (VDC)	Frequency Error (Hz)	Frequency Error (ppm)	Limit (ppm)
50	3.7	-8	-0.0032	2.5
40		-1	-0.0004	2.5
30		2	0.0008	2.5
20		0	0.0000	2.5
10		0	0.0000	2.5
0		-4	-0.0016	2.5
-10		-5	-0.0020	2.5
-20		0	0.0000	2.5
-30		-4	-0.0016	2.5
20		3.3	6	0.0024
20	4.1	8	0.0032	2.5

## LTE Band 7

Test Frequency:2535MHz QPSK 10MHz				
Temperature (°C)	Power Supply (VDC)	Frequency Error (Hz)	Frequency Error (ppm)	Limit (ppm)
50	3.7	6	0.0024	(ppm)
40		6	0.0024	2.5
30		14	0.0055	2.5
20		6	0.0024	2.5
10		0	0.0000	2.5
0		15	0.0059	2.5
-10		-1	-0.0004	2.5
-20		13	0.0051	2.5
-30		8	0.0032	2.5
20		3.3	-3	-0.0012
20	4.1	1	0.0004	2.5

Test Frequency:2535MHz 16QAM 10MHz				
Temperature (°C)	Power Supply (VDC)	Frequency Error (Hz)	Frequency Error (ppm)	Limit (ppm)
50	3.7	0	0.0000	2.5
40		9	0.0036	2.5
30		-2	-0.0008	2.5
20		5	0.0020	2.5
10		5	0.0020	2.5
0		7	0.0028	2.5
-10		6	0.0024	2.5
-20		10	0.0039	2.5
-30		14	0.0055	2.5
20		3.3	0	0.0000
20	4.1	6	0.0024	2.5

## LTE Band 7

Test Frequency:2535MHz QPSK 15MHz				
Temperature (°C)	Power Supply (VDC)	Frequency Error (Hz)	Frequency Error (ppm)	Limit (ppm)
50	3.7	-8	-0.0032	2.5
40		4	0.0016	2.5
30		4	0.0016	2.5
20		0	0.0000	2.5
10		-5	-0.0020	2.5
0		-5	-0.0020	2.5
-10		-9	-0.0036	2.5
-20		0	0.0000	2.5
-30		2	0.0008	2.5
20		3.3	7	0.0028
20	4.1	6	0.0024	2.5

Test Frequency:2535MHz 16QAM 15MHz				
Temperature (°C)	Power Supply (VDC)	Frequency Error (Hz)	Frequency Error (ppm)	Limit (ppm)
50	3.7	10	0.0039	2.5
40		1	0.0004	2.5
30		16	0.0063	2.5
20		8	0.0032	2.5
10		8	0.0032	2.5
0		4	0.0016	2.5
-10		-1	-0.0004	2.5
-20		8	0.0032	2.5
-30		5	0.0020	2.5
20		3.3	4	0.0016
20	4.1	10	0.0039	2.5

## LTE Band 7

Test Frequency:2535MHz QPSK 20MHz				
Temperature (°C)	Power Supply (VDC)	Frequency Error (Hz)	Frequency Error (ppm)	Limit (ppm)
50	3.7	4	0.0016	2.5
40		-9	-0.0036	2.5
30		-4	-0.0016	2.5
20		-1	-0.0004	2.5
10		5	0.0020	2.5
0		7	0.0028	2.5
-10		-7	-0.0028	2.5
-20		5	0.0020	2.5
-30		-5	-0.0020	2.5
20		3.3	3	0.0012
20	4.1	-5	-0.0020	2.5

Test Frequency:2535MHz 16QAM 20MHz				
Temperature (°C)	Power Supply (VDC)	Frequency Error (Hz)	Frequency Error (ppm)	Limit (ppm)
50	3.7	-6	-0.0024	2.5
40		2	0.0008	2.5
30		-9	-0.0036	2.5
20		-2	-0.0008	2.5
10		5	0.0020	2.5
0		2	0.0008	2.5
-10		4	0.0016	2.5
-20		4	0.0016	2.5
-30		4	0.0016	2.5
20		3.3	0	0.0000
20	4.1	0	0.0000	2.5

## **15 RF Exposure**

Remark: refer to SAR test report: WTS18S08120418W.

## **16 Photographs of test setup and EUT.**

Note: Please refer to appendix: WTS18S08120417W\_Photo.

=====  
===== End of Report =====  
=====