



T8e USER MANUAL

WARNING

1. Use this unit only for its intended use as described in this manual.
2. Unplug this unit during lightning storms or when unused for long periods of time.
3. The unit should be situated away from direct sunlight or heat sources such as radiators, electric heaters, heat registers, stoves, or other units (including amplifiers) that produce heat. Avoid placing on top of stereo equipment that radiates heat.
4. Never block the air openings of the unit with materials such as plastic bags, clothing or papers, or place it on a soft surface such as a bed or a couch, where the air openings may be blocked. Doing so may result in overheating and damage to the unit.
5. Do not overload electrical outlet. Use only the power source as indicated.
6. Never operate this unit if it has a damaged cord or plug, if it is not working properly, or if it has been dropped or damaged, or dropped into water. If the unit's power supply cord or plug is damaged, do not attempt to fix it yourself.
7. To avoid the risk of electric shock, do not disassemble or attempt to repair the unit. Incorrect repair can cause risk of electric shock or injury to persons when unit is used.
8. Keep product out of reach of children.
9. Never dispose of the product in fire or water, which may result in explosion and/or injury.

IN THE BOX

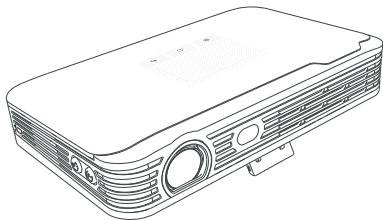

Projector

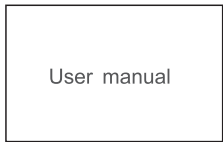

User manual

User manual

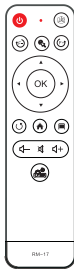

Remote



HDMI (optional)



AV (optional)



Adapter



AC cable

PRODUCT OVERVIEW

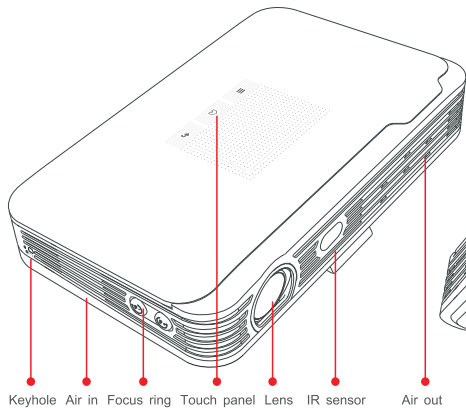

① power key operation instructions:

- long press on the power button > 2s, the projector start work.
- short press on the power button 500ms to 1s, start 5V OUT mode.

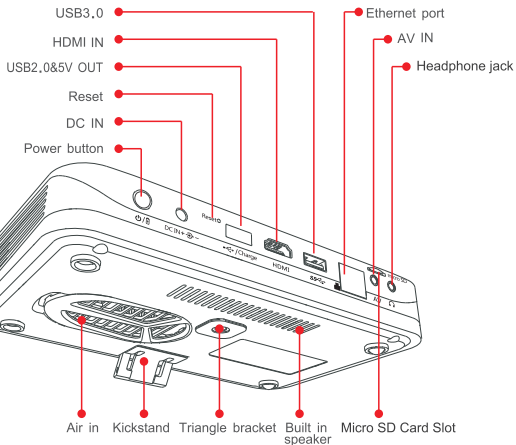

① power button light:

- Power mode: charging(light red), charge complete(light purple)
Battery mode: working(light blue)
OUT 5V mode: the battery power is full, blue light flash.
the battery power is low, red light flash, and pls charge in time.

DEVICE CONNECTION

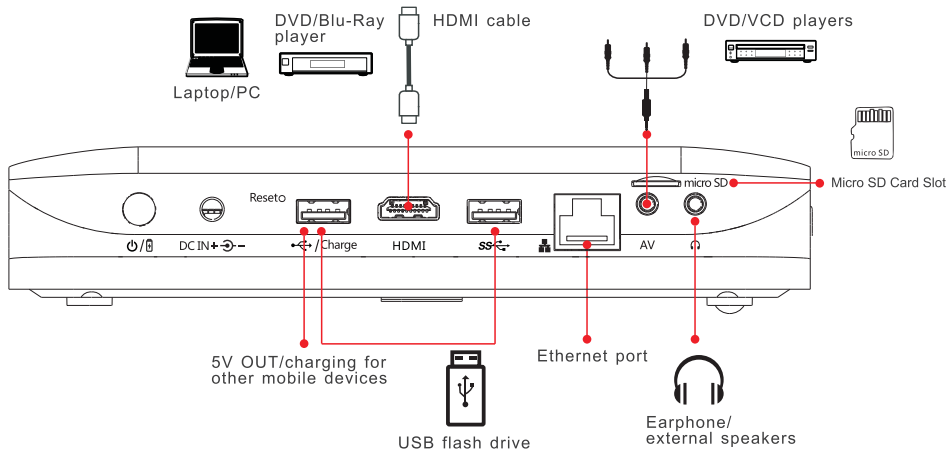

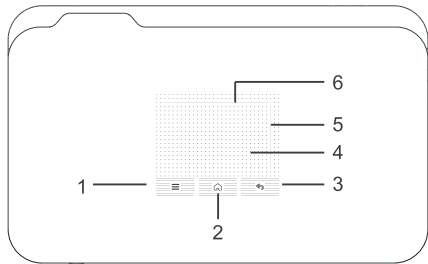

- 1. Menu
- 2. Home
- 3. Return
- 4. Touch panel
- 5. Scroll vertical
- 6. Scroll horizontal



Mouse (optional) helps control the smart projector conveniently.

1. Click the Left button to enter the menu.
2. Click the Right button to close the window.

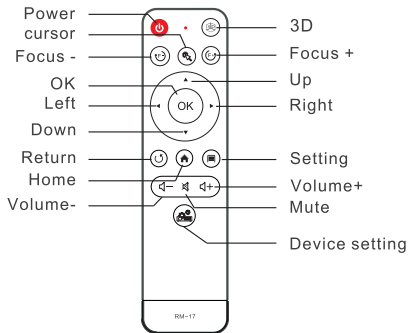

Notice: In order to reduce radiation exposure, using the remote is much recommended.

POWERING ON/OFF

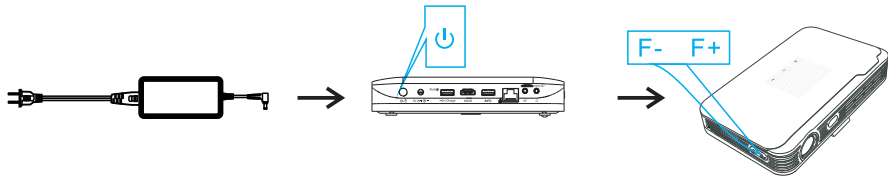

1. Connect to the power/electricity:

Plug the AC adapter into the DC IN power socket on your projector;
Plug the AC adapter into an electrical outlet.

2. Turn On/Turn Off:

Press and hold Power button on your projector for 2 seconds to turn it on.
Press the Power button on your projector twice to turn it off or press Power button on the Remote to turn it off.

3. Manual Focus:

Slide the Focus ring on the right side of your projector to sharpen the image.

HOME SCREEN



Wi-Fi

Connecting to Wi-Fi

Wi-Fi is a wireless networking technology that can provide wireless Internet access.

1. Enter *Home Screen* > *Wi-Fi*.
2. Slide the Wi-Fi switch to the ON position to turn on Wi-Fi.
3. The projector will scan for available Wi-Fi networks.
4. Choose a network name to connect to it.
5. If the network is secured, enter the password and enter Connect.



NOTES: Your projector automatically connects to the previously used Wi-Fi network when they are in range. When Wi-Fi is connected, your projector can notify you by showing * () in the status bar.

Adding a Wi-Fi network

You can add a Wi-Fi network if the network does not broadcast its name (SSID), or add a Wi-Fi network when you are out of range. To connect to a secured network, you first need the security details from the network administrator.

Connecting to Bluetooth Devices

Bluetooth is a short-range wireless communication technology. Phones or other devices with Bluetooth capabilities can exchange information wirelessly.

1. Enter *Home Screen* > *Bluetooth*.
2. Slide the Bluetooth switch to the NO position.

NOTES:When Bluetooth is on, the  icon will appear in the status bar.

Changing the Device name

1. Enter *Home Screen* > *Bluetooth*.
2. Slide the Bluetooth switch to the ON position to turn on Bluetooth.
3. Set name and password.
4. Enter Save.



SETTING

Enter *Home Screen* > *Setting* to find all the tools for customizing and configuring your projector.

WIFI, Bluetooth, System, Device, Ethernet Connection, Personalize, Software Update and About.

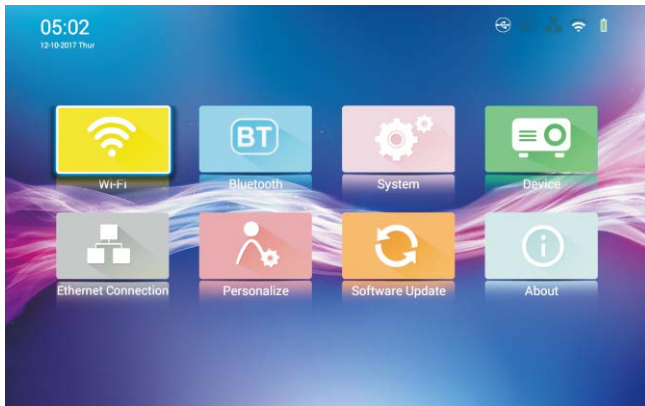

Applications manage: View and manage apps on your projector. You can stop the down loading app, uninstall or disable the app, or clear data and cache.

Language and Input: Select your language and configure text input settings. (NOTES: The model only supports English language.)

Date and Time: Set date, time, time zone and how date and time are displayed. You can also use network-provided data. Your projector can be controlled by a Timing Switch to shut down and restart automatically.

Miracast: You can project media wirelessly from a Miracast-capable (Wi-Fi display capable) device to the projector.

Recovery: Reset your projector to factory default settings. All your personal data on the internal storage will be erased.



DEVICE SETTINGS

Keystone: Close AUTO Keystone, then you can configure AUTO Keystone.

AUTO Keystone: Auto keystone allows your projector to make the output image rectangular automatically.

Projection Mode: Close AUTO Rotate, then you can configure Projection Mode.

AUTO Rotate: AUTO rotate allows your projector to automatically change the orientation of some on-screen content based on the position of the device.

Digital Zoom/Horizontal Scale/Vertical Scale: Adjustable screen scaling percentage to meet your needs for all occasions.

Brightness Mode: AUTO/Standard/Warm/Cool/Eco

NOTES:

All of above is Quick Setting, more settings please use "Device Setting" key to set on Remote.



Wallpaper / Screensaver: Select a background image for the home screen.

Source Options: You can keep your projector in the same source every time it starts up.

HDMI: Your projector will project the HDMI source every time it starts up.

AV: Your projector will project the AV source every time it starts up.

Auto: Your projector will project any available source every time it starts up.

Auto Shutdown if no signal: Your projector will shut down automatically if none signal detected within 10 minutes.



ETHERNET CONNECTION

Your projector can connect to a wired network with the Ethernet cables connection.

SOFTWARE UPDATE

Check for available updates for software installed on your device and manage the update process. There are two ways to update your projector software, Online Update and Local Update.

Online Update: You can update the system by downloading the newest software online.

Local Update: You need to ask for help from the technical supporting about this firmware update.

ABOUT

View the device status, legal information and other information. You can also update your system with an updated package copied into the USB flash disk.

Projecting an HDMI Source or an Apple Device

You can project an HDMI source when connecting your projector to a laptop, PC, tablet or Blu-ray player, DVD player. If you have an Apple device, you need to get a Lighting Digital AV Adapter (not included).

1. Turn on the projector.
 2. Connect your projector to the laptop or other devices via the supplied HDMI cable. For Apple devices, connect the devices to the HDMI cable with the Lighting Digital AV Adapter, then connect the HDMI cable to the projector.
 3. Enter *Home Screen* > *HDMI*.
 4. Operate your laptop, or Apple device to select the content you want to project.
-

Projecting a AV Source

You can project an AV source when connecting your projector to a TV STB (set top box) or DVD player.

1. Turn on the projector.
2. Connect your projector to the TV STB or DVD player via the supplied AV cable.
3. Enter *Home Screen* > *AV*.
4. Operate your TV STB or DVD player to select the content you want to project.

3D SETTING

3D

You can press the 3D button to set on the remote, then use your projector to watch 3D videos with active 3D glasses (3D glasses is optional).

3D setting

LR View Switch: You can adjust the images for left eye and right eye to match the frequency of the displayed images until you feel better.

3D Format

1. Your projector can finish the format conversion after detecting a 3D video, and then present a ready 3D video if you are using the native player to play videos.
2. If you are watching 3D videos online or from other source, like HDMI, you can adjust the video mode into 2D Mode, or 3D-LR (Left-and-right), or 3D-UD (Up-and-down), 3D-2D-LR (Left-and-right), or 3D-2D-UD (Up-and-down) manually here.

For Left-and-right format video, please select 3D-UD to watch 3D videos;

For Up-and-down format video, please select 3D-LR to watch 3D videos.

If you want to back to Non-3D video, please select 2D or 3D-2D-LR, or 3D-2D-UD.



Ushare&AirPlay Mirroring

Ushare is an application through which wireless connection between your phone / tablet / PC and the projector can be achieved. You can stream music, photos, and videos from your phone / tablet / PC to your projector. And with Ushare or AirPlay Mirroring, you can display your phone / tablet / PC screen on your projector.

NOTES: Please make sure your device and your projector connect to the same Wi-Fi network.

Use Ushare

1. Enter *Home Screen > Apps > Ushare*
2. Use your phone to download and install the Ushare Application by scanning the QR-code or visiting the website shown on the bottom of the projection screen; also shown on the bottom left of the Home Screen.
3. Connect your phone and your projector to the same Wi-Fi network (see Connecting to Wi-Fi).
4. Enter installed Ushare application on your phone and connect to the device name shown on bottom left of the Home Screen, then select the content you want to project.

USHARE

NOTES:

To use Ushare Mirroring, your smart phone's system version suggest to above Android OS 5.0.



1. Connect your device to "concox007-5g"
2. Visit "<http://192.168.1.57>" with web browser or scan the QR-code to download app.
3. Launch UShare and click "UShare-1736" to connect.

For iOS device's mirroring, please reference to Use AirPlay below.

Use AirPlay

1. Connect your iOS device and your projector to the same Wi-Fi network.
2. On your iOS device, swipe up from the bottom of your screen to open Control Center.
3. Tap AirPlay
4. Tap the name of the device you want to stream content to.

NOTES:

When you choose an AirPlay device, audio, photos, and videos from your iOS device will play on your projector.

If you turn on Mirroring, you'll see your entire iOS screen on the projection screen.

To use AirPlay, you need one of these devices: iPhone 5 or later for AirPlay Mirroring; iPad 2 or later for AirPlay Mirroring; iPod touch (5th generation or later) for AirPlay Mirroring.



PROJECTED DIMENSION

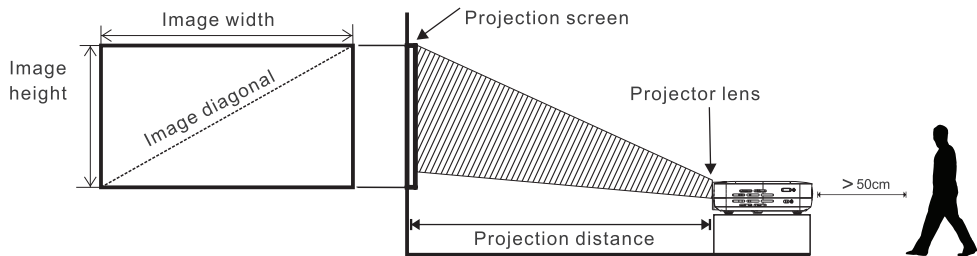

Notice: When you use projector, please keep the distance away from 50cm.

Projection distance (cm)	Image width (cm)	Image height (cm)	Image diagonal (inch)
50	42	26	19
100	83	52	39
150	125	78	58
200	167	104	76
250	208	130	97
300	250	156	116

Safety Information and Notices

Failure to comply with the following precautions may be dangerous or illegal.

Do not use projector in damp areas (bathroom, swimming pool...).

Protect it from liquids and other moisture.

Do not expose projector to extreme temperatures lower than 0°C and higher than 35°C.

Please carefully read and observe the terms below:

Adapter

Adapter shall be installed near the equipment and shall be easily accessible.

Please read the instructions carefully before using this product, and properly kept for future reference.



SAFETY INSTRUCTIONS

This product built-in battery, do not use in high temperature and high humidity conditions. Product sit idle for a long time, ensure that three months a charge!

Notice: The distance must always be greater than 50cm when it is in battery mode.

Shenzhen WOWOTO Technology Co.,Ltd.

Floor 4th, Gaoxingqi Industrial Park, Liuxian 1st Road,
district 67, Bao'an, Shenzhen, China

Web: www.iwowoto.com

Made in China



www.iwowoto.com

Hereby, Guizhou CVIM Technology Co., Ltd. declares that the radio equipment type Smart Projektor, T8e is in compliance with Directive 2014/53/EU.

The full text of the EU declaration of conformity is available at the following internet address:
<http://www.cvim.cc/>

Operating Temperature: -10°~45°C

Class BR&EDR: 2402MHz~2480MHz

Output power:6dBm

BLE: 2402MHz~2480MHz

Outputpower:-4dBm

2.4G WIFI.2412-2472MHz, 2422-2462MHz

Outputpower:Wifi:18dBm

5G:Tx Frequency Range: 5.15GHz~5.25GHz

Output power: 20dBm

5.8G: Tx Frequency Range:5.725 GHz-5.825GHz

Output power: 14dBm

The device is restricted to indoor use when operated in the European Community using frequency in 5150MHz~5250MHz to reduce the potential for interference.

Restriction in BE, BG, CZ, DK, DE, EE, IE, EL, ES, FR, HR, IT, CY, LV, LT, LU, HU, MT, NL, AT, PL, PT, RO, SI, SK, FI, SE, 

RF exposure statement

RF exposure information: The Maximum Permissible Exposure (MPE) level has been calculated based on a distance of d=20 cm between the device and the human body. To maintain compliance with RF exposure requirement, use product that maintain a 20cm distance between the device and human body.

FCC Statement

This device complies with Part 15 of the FCC Rules. Operation is subject to the following two conditions:

- (1) This device may not cause harmful interference.
- (2) This device must accept any interference received, including interference that may cause undesired operation.

Note: The grantee is not responsible for any changes or modifications not expressly approved by the party responsible for compliance. Such modifications could void the user's authority to operate the equipment.

NOTE: This equipment has been tested and found to comply with the limits for a Class B digital device, pursuant to part 15 of the FCC Rules. These limits are designed to provide reasonable protection against harmful interference in a residential installation.

This equipment generates uses and can radiate radio frequency energy and, if not installed and used in accordance with the instructions, may cause harmful interference to radio communications. However, there is no guarantee that interference will not occur in a particular installation. If this equipment does cause harmful interference to radio or television reception, which can be determined by turning the equipment off and on, the user is encouraged to try to correct the interference by one or more of the following measures:

- Reorient or relocate the receiving antenna.
- Increase the separation between the equipment and receiver.
- Connect the equipment into an outlet on a circuit different from that to which the receiver is connected.
- Consult the dealer or an experienced radio/TV technician for help.