

30MHz~3GHz_Band17_10MHz_QPSK_1_0_LowCH23780-709



3GHz~10GHz_Band17_10MHz_QPSK_1_0_MidCH23790-710



3GHz~10GHz_Band17_10MHz_QPSK_1_0_LowCH23780-709

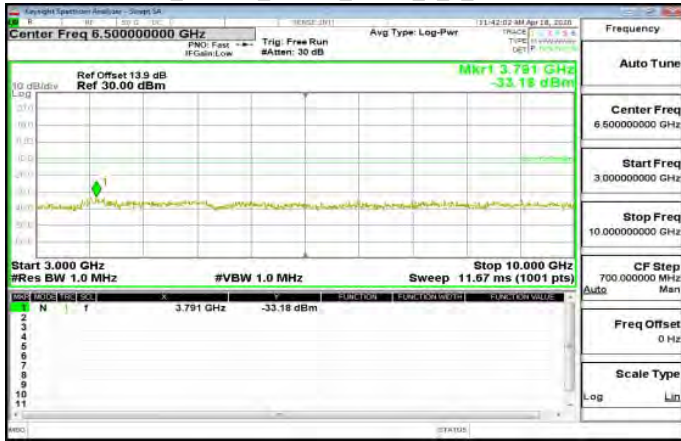

30MHz~3GHz_Band17_10MHz_QPSK_1_0_HighCH23800-711

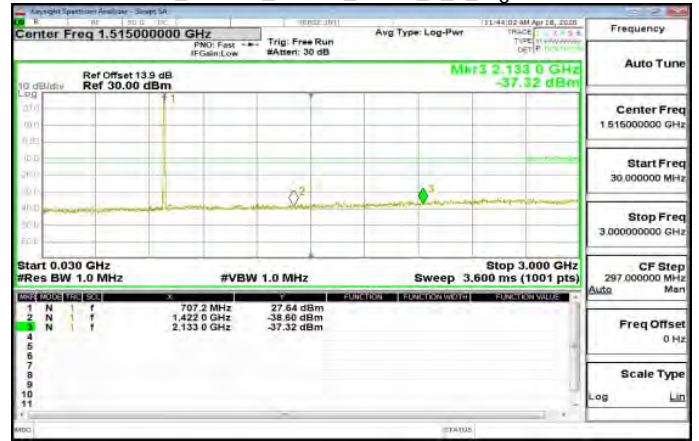

30MHz~3GHz_Band17_10MHz_QPSK_1_0_MidCH23790-710

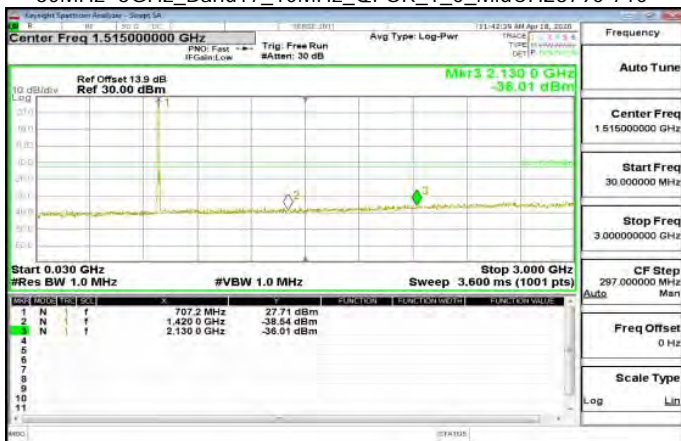

3GHz~10GHz_Band17_10MHz_QPSK_1_0_HighCH23800-711

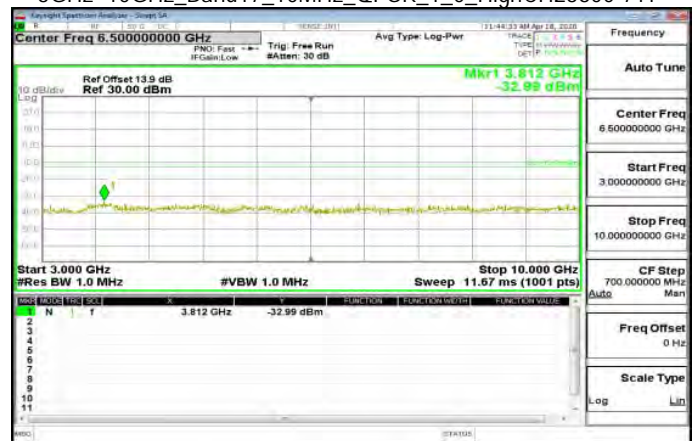

Unless otherwise stated the results shown in this test report refer only to the sample(s) tested and such sample(s) are retained for 90 days only.

除非另有說明，此報告結果僅對測試之樣品負責，同時此樣品僅保留90天。本報告未經本公司書面許可，不可部份複製。

This document is issued by the Company subject to its General Conditions of Service printed overleaf, available on request or accessible at <http://www.sgs.com.tw/Terms-and-Conditions> and for electronic format documents, subject to Terms and Conditions for Electronic Documents at <http://www.sgs.com.tw/Terms-and-Conditions>. Attention is drawn to the limitation of liability, indemnification and jurisdiction issues defined therein. Any holder of this document is advised that information contained hereon reflects the Company's findings at the time of its intervention only and within the limits of Client's instructions, if any. The Company's sole responsibility is to its Client and this document does not exonerate parties to a transaction from exercising all their rights and obligations under the transaction documents. This document cannot be reproduced except in full, without prior written approval of the Company. Any unauthorized alteration, forgery or falsification of the content or appearance of this document is unlawful and offenders may be prosecuted to the fullest extent of the law.

9 FIELD STRENGTH OF SPURIOUS RADIATION MEASUREMENT

9.1 Standard Applicable

According to FCC §2.1053,
FCC §22.917(a), §24.238(a)

Out of band emissions. The power of any emission outside of the authorized operating frequency ranges must be attenuated below the transmitting power (P) by a factor of at least $43 + 10 \log(P)$ dB.

FCC §27.53(g)

Compliance for operations in the 600 MHz, 698-746 MHz, 746-758 MHz and the 776-788 MHz band with this provision is based on the use of measurement instrumentation employing a resolution bandwidth of 100 kilohertz or greater. However, in the 100 kilohertz bands immediately outside and adjacent to a licensee's frequency block, a resolution bandwidth of at least 30 kHz may be employed.

Table 2 — Unwanted Emissions for Mobile, Portable and Low-Power Fixed Subscriber Equipment

Frequency (MHz)	Attenuation (dB)
<2200	$43 + 10 \log_{10}(p)$
2200 - 2288	$70 + 10 \log_{10}(p)$
2288 - 2292	$67 + 10 \log_{10}(p)$
2292 - 2296	$61 + 10 \log_{10}(p)$
2296 - 2300	$55 + 10 \log_{10}(p)$
2300 - 2305	$43 + 10 \log_{10}(p)$
2305 - 2320	$43 + 10 \log_{10}(p)$ ^{Note}
2320 - 2324	$55 + 10 \log_{10}(p)$
2324 - 2328	$61 + 10 \log_{10}(p)$
2328 - 2337	$67 + 10 \log_{10}(p)$
2337 - 2341	$61 + 10 \log_{10}(p)$
2341 - 2345	$55 + 10 \log_{10}(p)$
2345 - 2360	$43 + 10 \log_{10}(p)$ ^{Note}
2360 - 2365	$43 + 10 \log_{10}(p)$
2365 - 2395	$70 + 10 \log_{10}(p)$
>2395	$43 + 10 \log_{10}(p)$

Note: Measured at the edges of the highest and lowest frequency range(s) in which the equipment is designed to operate. See Section 1.2 for the permitted frequency ranges for various equipment types.

Unless otherwise stated the results shown in this test report refer only to the sample(s) tested and such sample(s) are retained for 90 days only.
 除非另有說明，此報告結果僅對測試之樣品負責，同時此樣品僅保留90天。本報告未經本公司書面許可，不可部份複製。

This document is issued by the Company subject to its General Conditions of Service printed overleaf, available on request or accessible at <http://www.sgs.com.tw/Terms-and-Conditions> and for electronic format documents, subject to Terms and Conditions for Electronic Documents at <http://www.sgs.com.tw/Terms-and-Conditions>. Attention is drawn to the limitation of liability, indemnification and jurisdiction issues defined therein. Any holder of this document is advised that information contained hereon reflects the Company's findings at the time of its intervention only and within the limits of Client's instructions, if any. The Company's sole responsibility is to its Client and this document does not exonerate parties to a transaction from exercising all their rights and obligations under the transaction documents. This document cannot be reproduced except in full, without prior written approval of the Company. Any unauthorized alteration, forgery or falsification of the content or appearance of this document is unlawful and offenders may be prosecuted to the fullest extent of the law.

9.2 EUT Setup

Radiated Emission Test Set-Up, Frequency Below 1000MHz

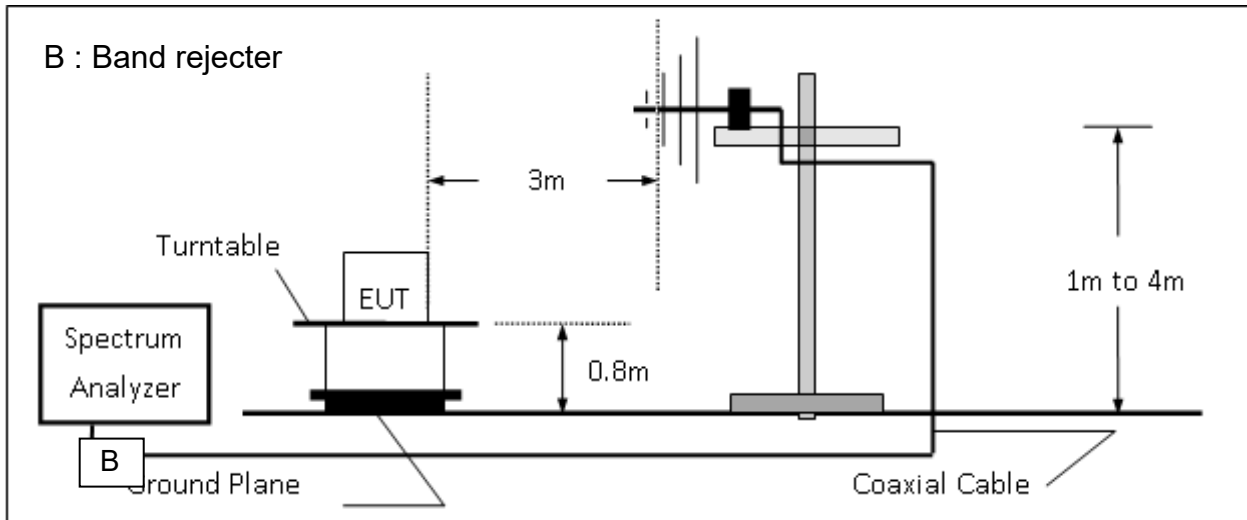

Radiated Emission Test Set-UP Frequency Over 1 GHz

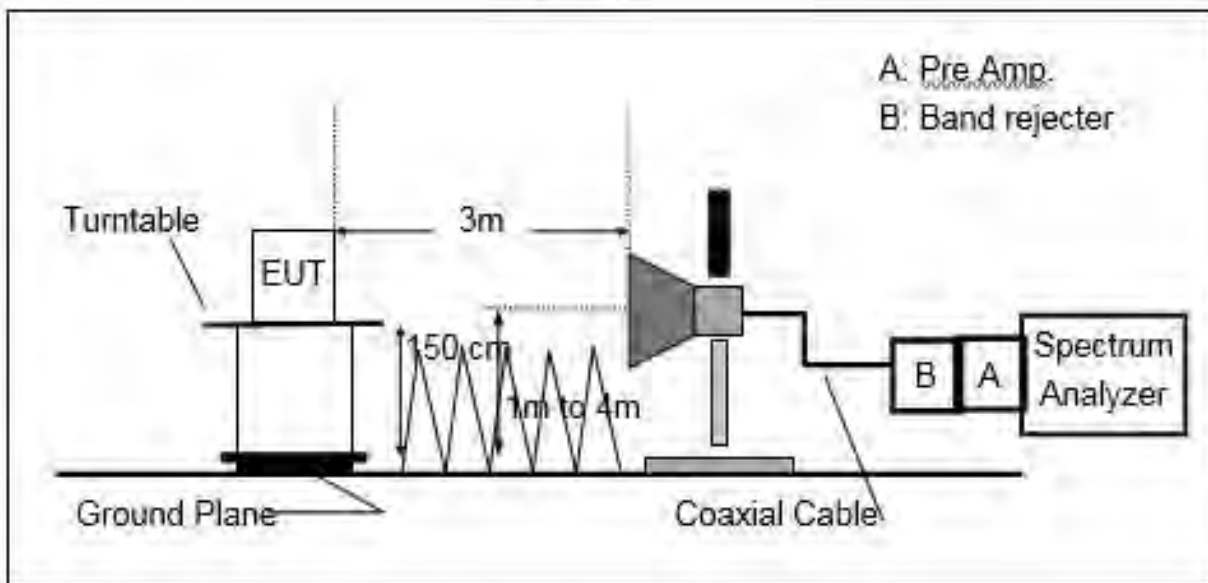

Unless otherwise stated the results shown in this test report refer only to the sample(s) tested and such sample(s) are retained for 90 days only.
除非另有說明，此報告結果僅對測試之樣品負責，同時此樣品僅保留90天。本報告未經本公司書面許可，不可部份複製。

This document is issued by the Company subject to its General Conditions of Service printed overleaf, available on request or accessible at <http://www.sgs.com.tw/Terms-and-Conditions> and for electronic format documents, subject to Terms and Conditions for Electronic Documents at <http://www.sgs.com.tw/Terms-and-Conditions>. Attention is drawn to the limitation of liability, indemnification and jurisdiction issues defined therein. Any holder of this document is advised that information contained hereon reflects the Company's findings at the time of its intervention only and within the limits of Client's instructions, if any. The Company's sole responsibility is to its Client and this document does not exonerate parties to a transaction from exercising all their rights and obligations under the transaction documents. This document cannot be reproduced except in full, without prior written approval of the Company. Any unauthorized alteration, forgery or falsification of the content or appearance of this document is unlawful and offenders may be prosecuted to the fullest extent of the law.

9.3 Measurement Procedure:

The EUT was placed on a non-conductive; the measurement antenna was placed at a distance of 3 meters from the EUT. During the tests, the antenna height and the EUT azimuth were varied in order to identify the maximum level of emissions from the EUT. This maximization process was repeated with the EUT positioned in each of its three orthogonal orientations.

The frequency range up to tenth harmonic was investigated for each of three fundamental frequencies (low, middle and high channels). Once spurious emission was identified, the power of the emission was determined using the substitution method.

The spurious emissions attenuation was calculated as the difference between radiated power at the fundamental frequency and the spurious emissions frequency.

$$\text{ERP (dBm)} = \text{SG Level(dBm)} + \text{Antenna Gain(dBd)} + \text{Cable Loss(dB)}$$

$$\text{EIRP (dBm)} = \text{SG Level(dBm)} + \text{Antenna Gain(dBi)} + \text{Cable Loss(dB)}$$

Unless otherwise stated the results shown in this test report refer only to the sample(s) tested and such sample(s) are retained for 90 days only.
除非另有說明，此報告結果僅對測試之樣品負責，同時此樣品僅保留90天。本報告未經本公司書面許可，不可部份複製。

This document is issued by the Company subject to its General Conditions of Service printed overleaf, available on request or accessible at <http://www.sgs.com.tw/Terms-and-Conditions> and for electronic format documents, subject to Terms and Conditions for Electronic Documents at <http://www.sgs.com.tw/Terms-and-Conditions>. Attention is drawn to the limitation of liability, indemnification and jurisdiction issues defined therein. Any holder of this document is advised that information contained hereon reflects the Company's findings at the time of its intervention only and within the limits of Client's instructions, if any. The Company's sole responsibility is to its Client and this document does not exonerate parties to a transaction from exercising all their rights and obligations under the transaction documents. This document cannot be reproduced except in full, without prior written approval of the Company. Any unauthorized alteration, forgery or falsification of the content or appearance of this document is unlawful and offenders may be prosecuted to the fullest extent of the law.

9.4 Measurement Equipment Used:

ERP, EIRP MEASUREMENT EQUIPMENT List 966 Chamber					
EQUIPMENT TYPE	MFR	MODEL NUMBER	SERIAL NUMBER	LAST CAL.	CAL DUE.
Bi-log Antenna	SCHWAZBECK	VULB9168	378	Jan. 3rd, 2020	Jan. 2nd, 2021
Horn Antenna	Schwarzbeck	BBHA9120D	1441	Aug. 20th, 2019	Aug. 19th, 2020
Horn Antenna	Schwarzbeck	BBHA9170	184	Dec. 25th, 2019	Dec. 24th, 2020
Horn Antenna	Schwarzbeck	BBHA9170	185	Aug. 7th, 2019	Aug. 6th, 2020
Horn Antenna	Schwarzbeck	BBHA9120D	D803	Dec. 20th, 2019	Dec. 19th, 2020
Bi-log Antenna	TESEO	CBL 6112D	35242 & AT-N0555	Jan. 13th, 2020	Jan. 12th, 2021
PXA Spectrum Analyzer	Agilent	N9030A	MY53120760	Apr. 22nd, 2019	Apr. 21st, 2020
Signal Generator	Agilent	N5183A	MY50140591	Dec. 20th, 2019	Dec. 19th, 2020
Pre-Amplifier	HP	8449B	3008A00578	Jan. 2nd, 2020	Jan. 1st, 2021
Pre-Amplifier	HP	8447D	2944A07676	Jan. 2nd, 2020	Jan. 1st, 2021
Pre-Amplifier	EMC Instruments	EMC184045B	980135	Jan. 2nd, 2020	Jan. 1st, 2021
Filter 635-920	Micro-Tronics	WI	4	Jan. 2nd, 2020	Jan. 1st, 2021
Filter 800-1000	Micro-Tronics	EWT	M1	Jan. 2nd, 2020	Jan. 1st, 2021
Filter 1700-2000	Micro-Tronics	EWT	M3	Jan. 2nd, 2020	Jan. 1st, 2021
1GHz High Pass Filter	Micro-Tronics	HPM50108	32	Jan. 2nd, 2020	Jan. 1st, 2021
2GHz High Pass Filter	Micro-Tronics	HPM50110	36	Jan. 2nd, 2020	Jan. 1st, 2021
Low Loss Cable	Huber Suhner	966_RX	9	Jan. 2nd, 2020	Jan. 1st, 2021
Low Loss Cable	Huber Suhner	966_TX	1	Jan. 2nd, 2020	Jan. 1st, 2021
Radio Communication Analyzer	Anritsu	MT8820C	6200995019	Apr. 1st, 2020	Mar. 31st, 2021
Radio Communication Analyzer	Anritsu	MT8815B	6200711454	Apr. 1st, 2020	Mar. 31st, 2021

Unless otherwise stated the results shown in this test report refer only to the sample(s) tested and such sample(s) are retained for 90 days only.

除非另有說明，此報告結果僅對測試之樣品負責，同時此樣品僅保留90天。本報告未經本公司書面許可，不可部份複製。

This document is issued by the Company subject to its General Conditions of Service printed overleaf, available on request or accessible at <http://www.sgs.com.tw/Terms-and-Conditions> and for electronic format documents, subject to Terms and Conditions for Electronic Documents at <http://www.sgs.com.tw/Terms-and-Conditions>. Attention is drawn to the limitation of liability, indemnification and jurisdiction issues defined therein. Any holder of this document is advised that information contained hereon reflects the Company's findings at the time of its intervention only and within the limits of Client's instructions, if any. The Company's sole responsibility is to its Client and this document does not exonerate parties to a transaction from exercising all their rights and obligations under the transaction documents. This document cannot be reproduced except in full, without prior written approval of the Company. Any unauthorized alteration, forgery or falsification of the content or appearance of this document is unlawful and offenders may be prosecuted to the fullest extent of the law.

9.5 Measurement Result:

Report Number	:ER-2020-40010	Test Date	:2020-04-17
Operation Mode	:GSM 850	Temp./Humi.	:22.6/66
Test Mode	:Tx CH Low	Antenna Pol.	:VERTICAL
EUT Pol	:H Plane	Engineer	:Nick
Test Frequency	:824.2 MHz		

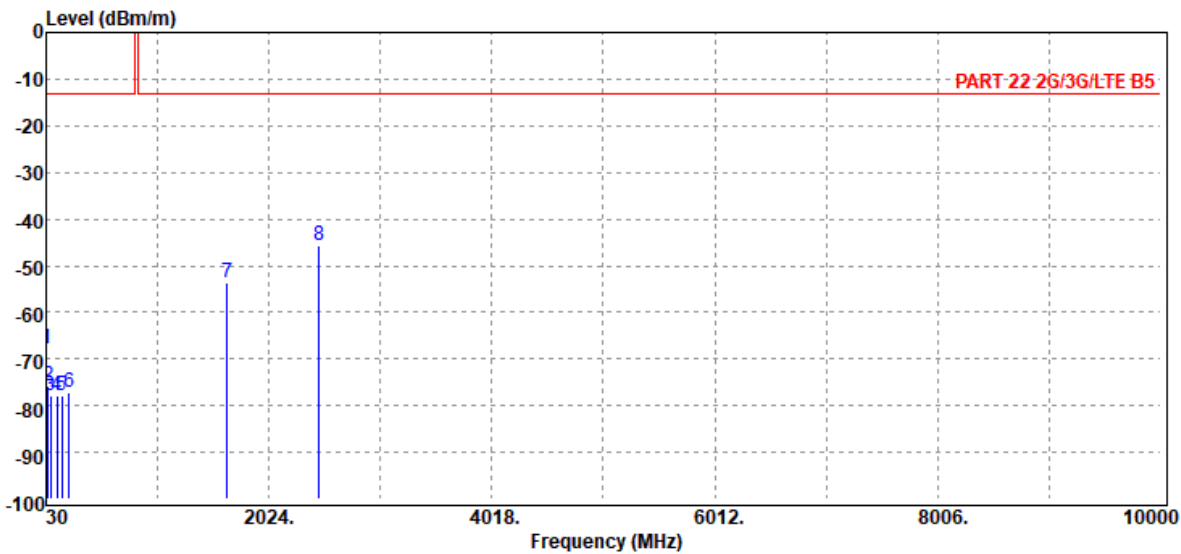

Freq. MHz	EIRP/ERP dBm	SG Output Level dBm	Antenna Gain dBi/dBd	Cable Loss dB	Limit dBm	Margin dB
30.00	-67.68	-39.86	-27.28	-0.54	-13.00	-54.68
49.40	-75.80	-62.43	-12.77	-0.60	-13.00	-62.80
68.80	-77.85	-69.97	-7.07	-0.81	-13.00	-64.85
128.94	-77.70	-69.59	-7.12	-0.99	-13.00	-64.70
172.59	-77.76	-74.17	-2.33	-1.26	-13.00	-64.76
233.70	-77.10	-74.10	-1.55	-1.45	-13.00	-64.10
1648.40	-53.59	-59.62	9.89	-3.86	-13.00	-40.59
2472.60	-45.83	-51.65	10.59	-4.77	-13.00	-32.83

Unless otherwise stated the results shown in this test report refer only to the sample(s) tested and such sample(s) are retained for 90 days only.
除非另有說明，此報告結果僅對測試之樣品負責，同時此樣品僅保留90天。本報告未經本公司書面許可，不可部份複製。

This document is issued by the Company subject to its General Conditions of Service printed overleaf, available on request or accessible at <http://www.sgs.com.tw/Terms-and-Conditions> and for electronic format documents, subject to Terms and Conditions for Electronic Documents at <http://www.sgs.com.tw/Terms-and-Conditions>. Attention is drawn to the limitation of liability, indemnification and jurisdiction issues defined therein. Any holder of this document is advised that information contained hereon reflects the Company's findings at the time of its intervention only and within the limits of Client's instructions, if any. The Company's sole responsibility is to its Client and this document does not exonerate parties to a transaction from exercising all their rights and obligations under the transaction documents. This document cannot be reproduced except in full, without prior written approval of the Company. Any unauthorized alteration, forgery or falsification of the content or appearance of this document is unlawful and offenders may be prosecuted to the fullest extent of the law.

Report Number :ER-2020-40010
 Operation Mode :GSM 850
 Test Mode :Tx CH Low
 EUT Pol :H Plane
 Test Frequency :824.2 MHz

Test Date :2020-04-17
 Temp./Humi. :22.6/66
 Antenna Pol. :HORIZONTAL
 Engineer :Nick

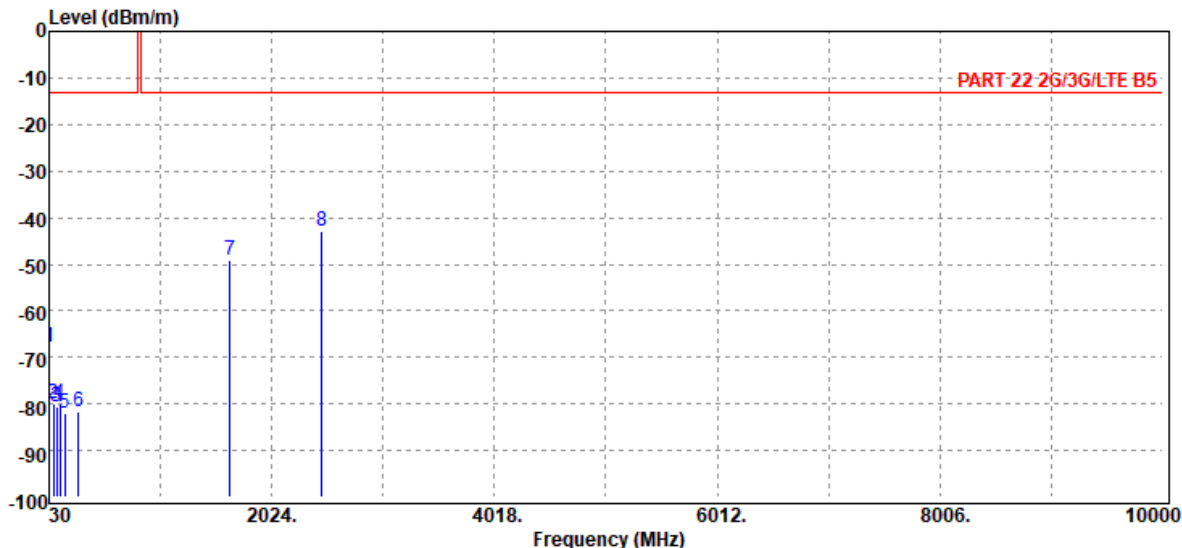

Freq. MHz	EIRP/ERP dBm	SG Output Level dBm	Antenna Gain dBi/dBd	Cable Loss dB	Limit dBm	Margin dB
30.00	-67.67	-39.85	-27.28	-0.54	-13.00	-54.67
68.80	-79.88	-72.00	-7.07	-0.81	-13.00	-66.88
94.99	-80.61	-71.81	-7.87	-0.93	-13.00	-67.61
128.94	-79.96	-71.85	-7.12	-0.99	-13.00	-66.96
172.59	-82.05	-78.46	-2.33	-1.26	-13.00	-69.05
289.96	-81.53	-78.43	-1.48	-1.62	-13.00	-68.53
1648.40	-49.19	-55.22	9.89	-3.86	-13.00	-36.19
2472.60	-43.01	-48.83	10.59	-4.77	-13.00	-30.01

Unless otherwise stated the results shown in this test report refer only to the sample(s) tested and such sample(s) are retained for 90 days only.

除非另有說明，此報告結果僅對測試之樣品負責，同時此樣品僅保留90天。本報告未經本公司書面許可，不可部份複製。

This document is issued by the Company subject to its General Conditions of Service printed overleaf, available on request or accessible at <http://www.sgs.com.tw/Terms-and-Conditions> and for electronic format documents, subject to Terms and Conditions for Electronic Documents at <http://www.sgs.com.tw/Terms-and-Conditions>. Attention is drawn to the limitation of liability, indemnification and jurisdiction issues defined therein. Any holder of this document is advised that information contained hereon reflects the Company's findings at the time of its intervention only and within the limits of Client's instructions, if any. The Company's sole responsibility is to its Client and this document does not exonerate parties to a transaction from exercising all their rights and obligations under the transaction documents. This document cannot be reproduced except in full, without prior written approval of the Company. Any unauthorized alteration, forgery or falsification of the content or appearance of this document is unlawful and offenders may be prosecuted to the fullest extent of the law.

Report Number :ER-2020-40010
 Operation Mode :GSM 850
 Test Mode :Tx CH Mid
 EUT Pol :H Plane
 Test Frequency :836.6 MHz

Test Date :2020-04-17
 Temp./Humi. :22.6/66
 Antenna Pol. :VERTICAL
 Engineer :Nick

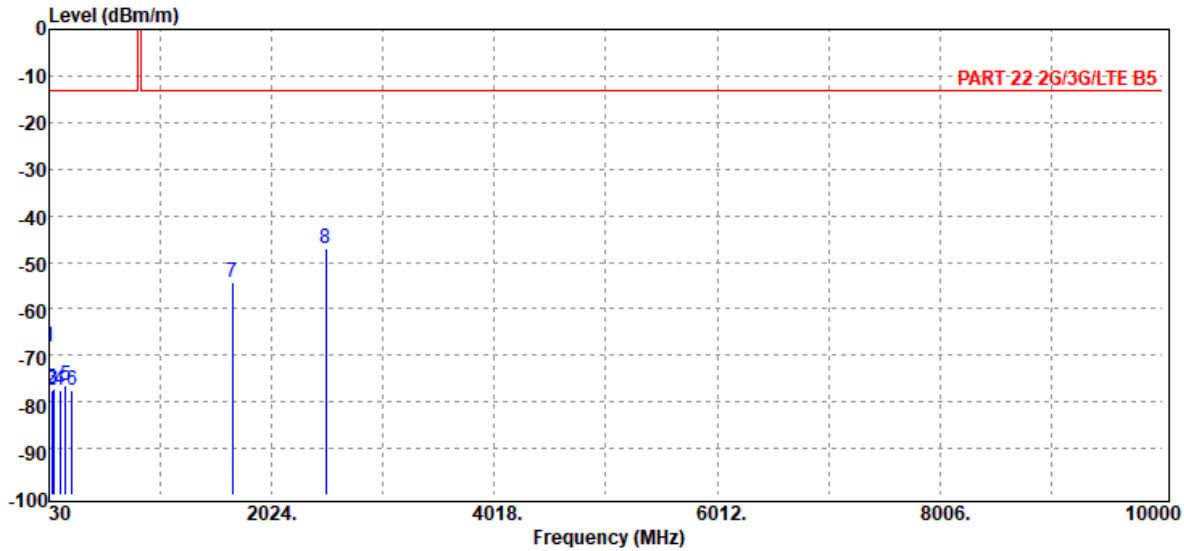

Freq. MHz	EIRP/ERP dBm	SG Output Level dBm	Antenna Gain dBi/dBd	Cable Loss dB	Limit dBm	Margin dB
30.00	-68.30	-40.48	-27.28	-0.54	-13.00	-55.30
52.31	-77.59	-65.73	-11.22	-0.64	-13.00	-64.59
68.80	-77.25	-69.37	-7.07	-0.81	-13.00	-64.25
128.94	-77.46	-69.35	-7.12	-0.99	-13.00	-64.46
175.50	-76.50	-73.22	-2.04	-1.24	-13.00	-63.50
232.73	-77.54	-74.59	-1.51	-1.44	-13.00	-64.54
1673.20	-54.25	-60.30	9.95	-3.90	-13.00	-41.25
2509.80	-46.94	-52.86	10.74	-4.82	-13.00	-33.94

Unless otherwise stated the results shown in this test report refer only to the sample(s) tested and such sample(s) are retained for 90 days only.
 除非另有說明，此報告結果僅對測試之樣品負責，同時此樣品僅保留90天。本報告未經本公司書面許可，不可部份複製。

This document is issued by the Company subject to its General Conditions of Service printed overleaf, available on request or accessible at <http://www.sgs.com.tw/Terms-and-Conditions> and for electronic format documents, subject to Terms and Conditions for Electronic Documents at <http://www.sgs.com.tw/Terms-and-Conditions>. Attention is drawn to the limitation of liability, indemnification and jurisdiction issues defined therein. Any holder of this document is advised that information contained hereon reflects the Company's findings at the time of its intervention only and within the limits of Client's instructions, if any. The Company's sole responsibility is to its Client and this document does not exonerate parties to a transaction from exercising all their rights and obligations under the transaction documents. This document cannot be reproduced except in full, without prior written approval of the Company. Any unauthorized alteration, forgery or falsification of the content or appearance of this document is unlawful and offenders may be prosecuted to the fullest extent of the law.

Report Number :ER-2020-40010
Operation Mode :GSM 850
Test Mode :Tx CH Mid
EUT Pol :H Plane
Test Frequency :836.6 MHz

Test Date :2020-04-17
Temp./Humi. :22.6/66
Antenna Pol. :HORIZONTAL
Engineer :Nick

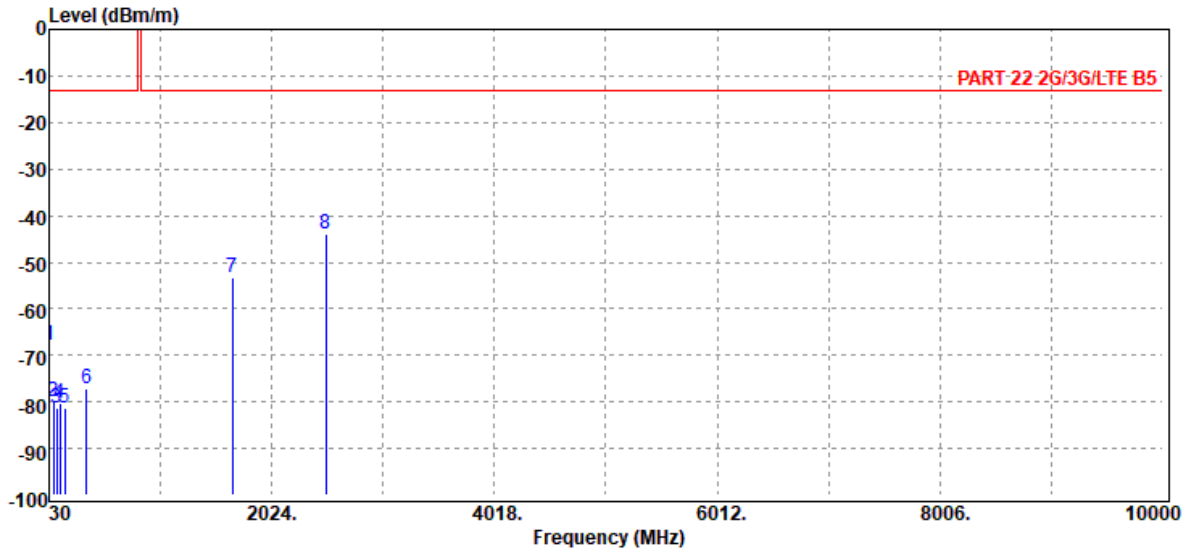

Freq. MHz	EIRP/ERP dBm	SG Output Level dBm	Antenna Gain dBi/dBd	Cable Loss dB	Limit dBm	Margin dB
30.00	-67.65	-39.83	-27.28	-0.54	-13.00	-54.65
66.86	-79.98	-72.05	-7.14	-0.79	-13.00	-66.98
94.99	-81.17	-72.37	-7.87	-0.93	-13.00	-68.17
128.94	-80.40	-72.29	-7.12	-0.99	-13.00	-67.40
168.71	-81.26	-77.22	-2.78	-1.26	-13.00	-68.26
366.59	-77.00	-73.76	-1.51	-1.73	-13.00	-64.00
1673.20	-53.27	-59.32	9.95	-3.90	-13.00	-40.27
2509.80	-43.86	-49.78	10.74	-4.82	-13.00	-30.86

Unless otherwise stated the results shown in this test report refer only to the sample(s) tested and such sample(s) are retained for 90 days only.
除非另有說明，此報告結果僅對測試之樣品負責，同時此樣品僅保留90天。本報告未經本公司書面許可，不可部份複製。

This document is issued by the Company subject to its General Conditions of Service printed overleaf, available on request or accessible at <http://www.sgs.com.tw/Terms-and-Conditions> and for electronic format documents, subject to Terms and Conditions for Electronic Documents at <http://www.sgs.com.tw/Terms-and-Conditions>. Attention is drawn to the limitation of liability, indemnification and jurisdiction issues defined therein. Any holder of this document is advised that information contained hereon reflects the Company's findings at the time of its intervention only and within the limits of Client's instructions, if any. The Company's sole responsibility is to its Client and this document does not exonerate parties to a transaction from exercising all their rights and obligations under the transaction documents. This document cannot be reproduced except in full, without prior written approval of the Company. Any unauthorized alteration, forgery or falsification of the content or appearance of this document is unlawful and offenders may be prosecuted to the fullest extent of the law.

Report Number :ER-2020-40010
 Operation Mode :GSM 850
 Test Mode :Tx CH High
 EUT Pol :H Plane
 Test Frequency :848.8 MHz

Test Date :2020-04-17
 Temp./Humi. :22.6/66
 Antenna Pol. :VERTICAL
 Engineer :Nick

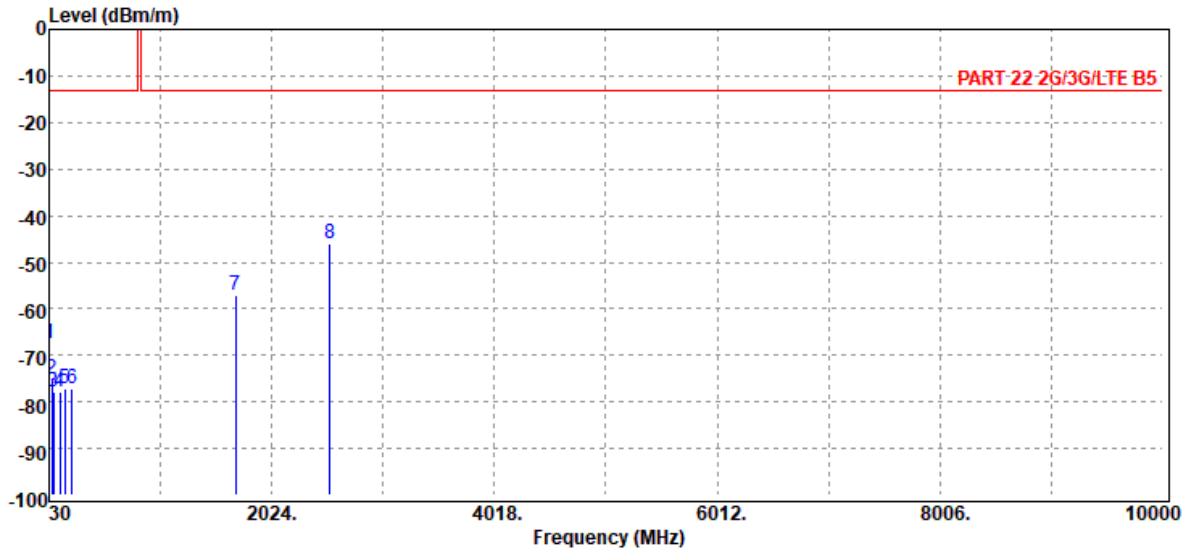

Freq. MHz	EIRP/ERP dBm	SG Output Level dBm	Antenna Gain dBi/dBd	Cable Loss dB	Limit dBm	Margin dB
30.00	-67.58	-39.76	-27.28	-0.54	-13.00	-54.58
52.31	-75.24	-63.38	-11.22	-0.64	-13.00	-62.24
66.86	-78.00	-70.07	-7.14	-0.79	-13.00	-65.00
128.94	-77.83	-69.72	-7.12	-0.99	-13.00	-64.83
172.59	-77.22	-73.63	-2.33	-1.26	-13.00	-64.22
233.70	-77.11	-74.11	-1.55	-1.45	-13.00	-64.11
1697.60	-57.00	-63.07	10.00	-3.93	-13.00	-44.00
2546.40	-45.90	-51.93	10.89	-4.86	-13.00	-32.90

Unless otherwise stated the results shown in this test report refer only to the sample(s) tested and such sample(s) are retained for 90 days only.
 除非另有說明，此報告結果僅對測試之樣品負責，同時此樣品僅保留90天。本報告未經本公司書面許可，不可部份複製。

This document is issued by the Company subject to its General Conditions of Service printed overleaf, available on request or accessible at <http://www.sgs.com.tw/Terms-and-Conditions> and for electronic format documents, subject to Terms and Conditions for Electronic Documents at <http://www.sgs.com.tw/Terms-and-Conditions>. Attention is drawn to the limitation of liability, indemnification and jurisdiction issues defined therein. Any holder of this document is advised that information contained hereon reflects the Company's findings at the time of its intervention only and within the limits of Client's instructions, if any. The Company's sole responsibility is to its Client and this document does not exonerate parties to a transaction from exercising all their rights and obligations under the transaction documents. This document cannot be reproduced except in full, without prior written approval of the Company. Any unauthorized alteration, forgery or falsification of the content or appearance of this document is unlawful and offenders may be prosecuted to the fullest extent of the law.

Report Number :ER-2020-40010
Operation Mode :GSM 850
Test Mode :Tx CH High
EUT Pol :H Plane
Test Frequency :848.8 MHz

Test Date :2020-04-17
Temp./Humi. :22.6/66
Antenna Pol. :HORIZONTAL
Engineer :Nick

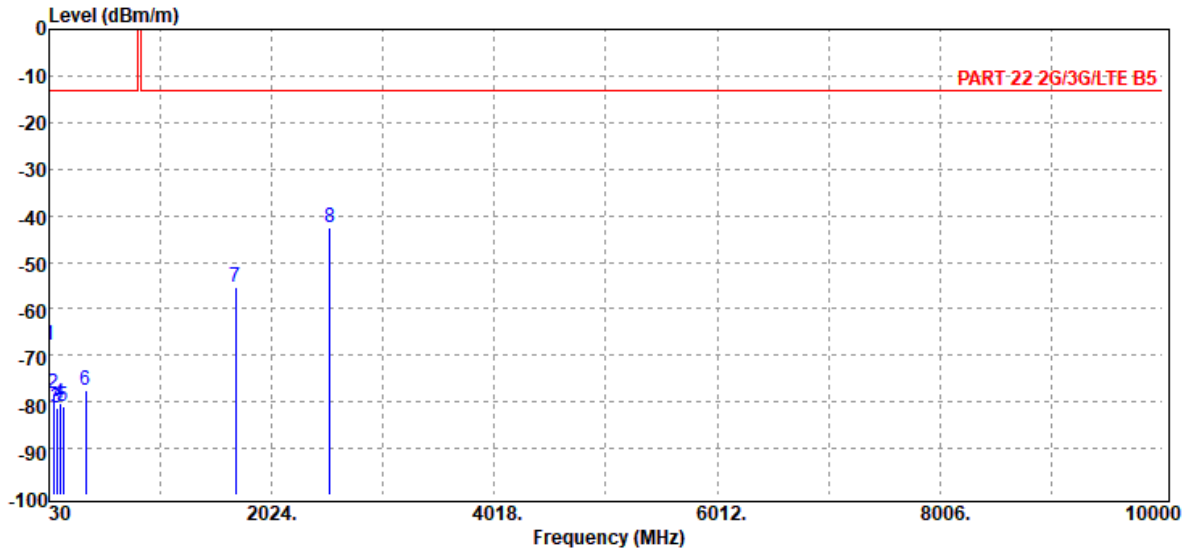

Freq. MHz	EIRP/ERP dBm	SG Output Level dBm	Antenna Gain dBi/dBd	Cable Loss dB	Limit dBm	Margin dB
30.00	-67.67	-39.85	-27.28	-0.54	-13.00	-54.67
66.86	-78.20	-70.27	-7.14	-0.79	-13.00	-65.20
94.99	-81.17	-72.37	-7.87	-0.93	-13.00	-68.17
127.00	-80.30	-72.04	-7.25	-1.01	-13.00	-67.30
153.19	-81.11	-75.39	-4.50	-1.22	-13.00	-68.11
359.80	-77.41	-74.00	-1.70	-1.71	-13.00	-64.41
1697.60	-55.42	-61.49	10.00	-3.93	-13.00	-42.42
2546.40	-42.69	-48.72	10.89	-4.86	-13.00	-29.69

Unless otherwise stated the results shown in this test report refer only to the sample(s) tested and such sample(s) are retained for 90 days only.
除非另有說明，此報告結果僅對測試之樣品負責，同時此樣品僅保留90天。本報告未經本公司書面許可，不可部份複製。

This document is issued by the Company subject to its General Conditions of Service printed overleaf, available on request or accessible at <http://www.sgs.com.tw/Terms-and-Conditions> and for electronic format documents, subject to Terms and Conditions for Electronic Documents at <http://www.sgs.com.tw/Terms-and-Conditions>. Attention is drawn to the limitation of liability, indemnification and jurisdiction issues defined therein. Any holder of this document is advised that information contained hereon reflects the Company's findings at the time of its intervention only and within the limits of Client's instructions, if any. The Company's sole responsibility is to its Client and this document does not exonerate parties to a transaction from exercising all their rights and obligations under the transaction documents. This document cannot be reproduced except in full, without prior written approval of the Company. Any unauthorized alteration, forgery or falsification of the content or appearance of this document is unlawful and offenders may be prosecuted to the fullest extent of the law.

Report Number :ER-2020-40010
 Operation Mode :GSM 1900
 Test Mode :Tx CH Low
 EUT Pol :H Plane
 Test Frequency :1850.2 MHz

Test Date :2020-04-17
 Temp./Humi. :22.6/66
 Antenna Pol. :VERTICAL
 Engineer :Nick

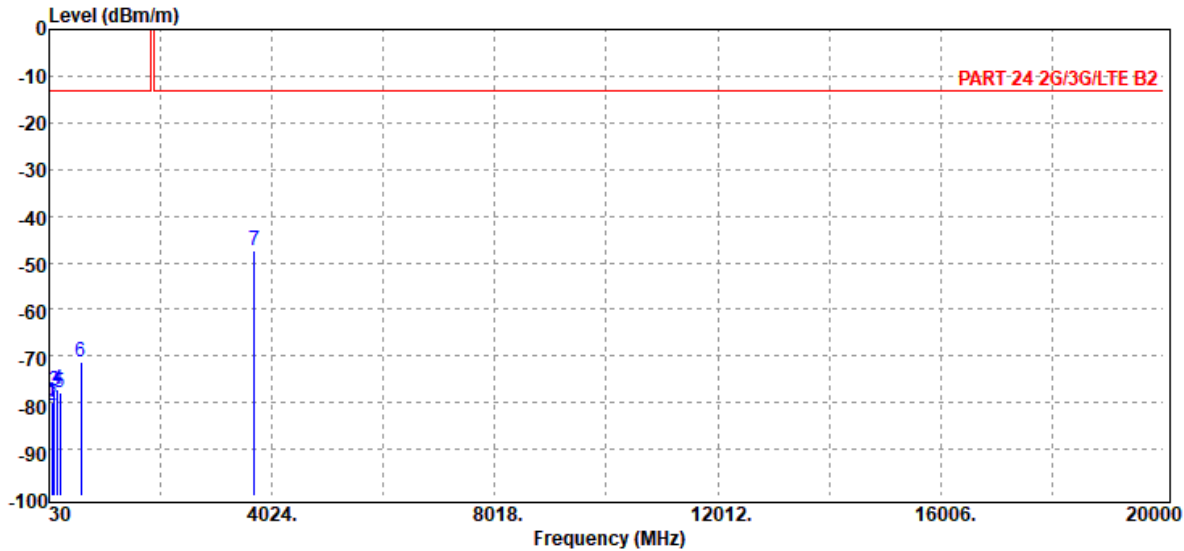

Freq. MHz	EIRP/ERP dBm	SG Output Level dBm	Antenna Gain dBi/dBd	Cable Loss dB	Limit dBm	Margin dB
73.65	-79.97	-72.43	-6.71	-0.83	-13.00	-66.97
86.26	-80.76	-73.22	-6.66	-0.88	-13.00	-67.76
128.94	-77.41	-69.30	-7.12	-0.99	-13.00	-64.41
175.50	-77.15	-73.87	-2.04	-1.24	-13.00	-64.15
231.76	-77.74	-74.83	-1.47	-1.44	-13.00	-64.74
602.30	-71.21	-68.33	-0.68	-2.20	-13.00	-58.21
3700.40	-47.43	-53.97	12.40	-5.86	-13.00	-34.43

Unless otherwise stated the results shown in this test report refer only to the sample(s) tested and such sample(s) are retained for 90 days only.
 除非另有說明，此報告結果僅對測試之樣品負責，同時此樣品僅保留90天。本報告未經本公司書面許可，不可部份複製。

This document is issued by the Company subject to its General Conditions of Service printed overleaf, available on request or accessible at <http://www.sgs.com.tw/Terms-and-Conditions> and for electronic format documents, subject to Terms and Conditions for Electronic Documents at <http://www.sgs.com.tw/Terms-and-Conditions>. Attention is drawn to the limitation of liability, indemnification and jurisdiction issues defined therein. Any holder of this document is advised that information contained hereon reflects the Company's findings at the time of its intervention only and within the limits of Client's instructions, if any. The Company's sole responsibility is to its Client and this document does not exonerate parties to a transaction from exercising all their rights and obligations under the transaction documents. This document cannot be reproduced except in full, without prior written approval of the Company. Any unauthorized alteration, forgery or falsification of the content or appearance of this document is unlawful and offenders may be prosecuted to the fullest extent of the law.

Report Number :ER-2020-40010
Operation Mode :GSM 1900
Test Mode :Tx CH Low
EUT Pol :H Plane
Test Frequency :1850.2 MHz

Test Date :2020-04-17
Temp./Humi. :22.6/66
Antenna Pol. :HORIZONTAL
Engineer :Nick

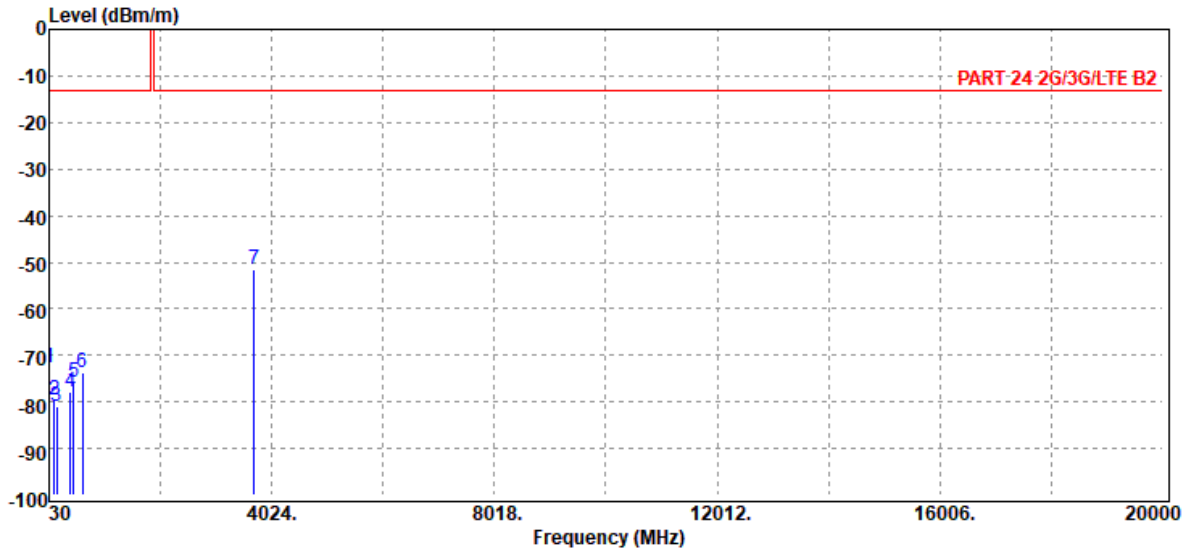

Freq. MHz	EIRP/ERP dBm	SG Output Level dBm	Antenna Gain dBi/dBd	Cable Loss dB	Limit dBm	Margin dB
31.94	-72.83	-46.32	-25.96	-0.55	-13.00	-59.83
127.00	-79.56	-71.30	-7.25	-1.01	-13.00	-66.56
163.86	-81.01	-76.43	-3.35	-1.23	-13.00	-68.01
410.24	-77.73	-73.87	-1.98	-1.88	-13.00	-64.73
464.56	-75.82	-72.79	-1.09	-1.94	-13.00	-62.82
623.64	-73.71	-71.00	-0.56	-2.15	-13.00	-60.71
3700.40	-51.63	-58.17	12.40	-5.86	-13.00	-38.63

Unless otherwise stated the results shown in this test report refer only to the sample(s) tested and such sample(s) are retained for 90 days only.
除非另有說明，此報告結果僅對測試之樣品負責，同時此樣品僅保留90天。本報告未經本公司書面許可，不可部份複製。

This document is issued by the Company subject to its General Conditions of Service printed overleaf, available on request or accessible at <http://www.sgs.com.tw/Terms-and-Conditions> and for electronic format documents, subject to Terms and Conditions for Electronic Documents at <http://www.sgs.com.tw/Terms-and-Conditions>. Attention is drawn to the limitation of liability, indemnification and jurisdiction issues defined therein. Any holder of this document is advised that information contained hereon reflects the Company's findings at the time of its intervention only and within the limits of Client's instructions, if any. The Company's sole responsibility is to its Client and this document does not exonerate parties to a transaction from exercising all their rights and obligations under the transaction documents. This document cannot be reproduced except in full, without prior written approval of the Company. Any unauthorized alteration, forgery or falsification of the content or appearance of this document is unlawful and offenders may be prosecuted to the fullest extent of the law.

Report Number :ER-2020-40010
Operation Mode :GSM 1900
Test Mode :Tx CH Mid
EUT Pol :H Plane
Test Frequency :1880.0 MHz

Test Date :2020-04-17
Temp./Humi. :22.6/66
Antenna Pol. :VERTICAL
Engineer :Nick

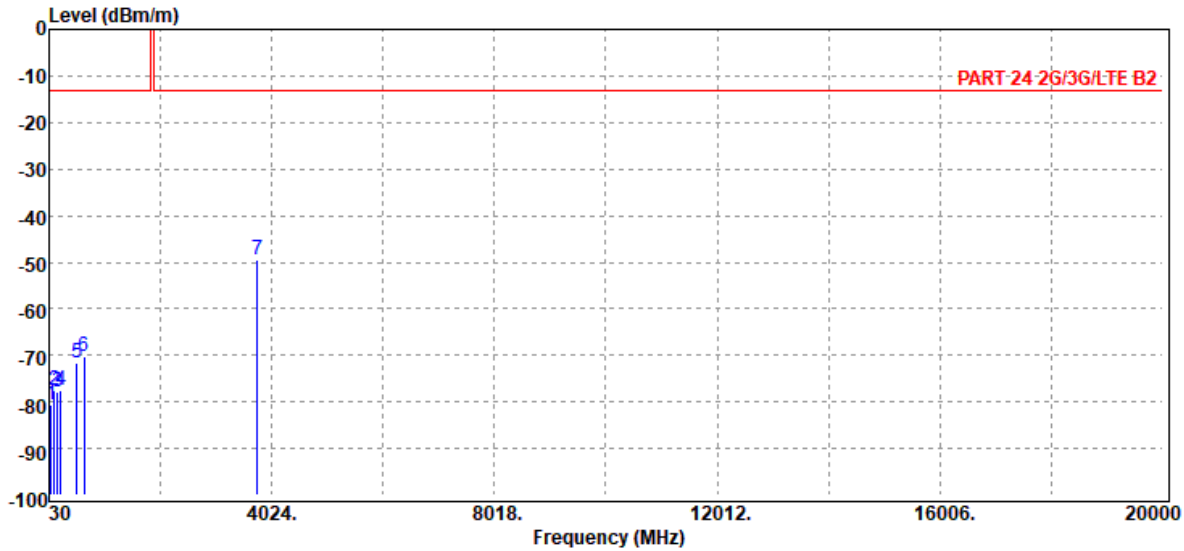

Freq. MHz	EIRP/ERP dBm	SG Output Level dBm	Antenna Gain dBi/dBd	Cable Loss dB	Limit dBm	Margin dB
69.77	-80.57	-72.96	-6.80	-0.81	-13.00	-67.57
128.94	-77.56	-69.45	-7.12	-0.99	-13.00	-64.56
177.44	-77.83	-74.69	-1.90	-1.24	-13.00	-64.83
238.55	-77.51	-74.28	-1.76	-1.47	-13.00	-64.51
524.70	-71.70	-68.87	-0.83	-2.00	-13.00	-58.70
657.59	-70.27	-67.26	-0.37	-2.64	-13.00	-57.27
3760.00	-49.40	-56.06	12.40	-5.74	-13.00	-36.40

Unless otherwise stated the results shown in this test report refer only to the sample(s) tested and such sample(s) are retained for 90 days only.

除非另有說明，此報告結果僅對測試之樣品負責，同時此樣品僅保留90天。本報告未經本公司書面許可，不可部份複製。

This document is issued by the Company subject to its General Conditions of Service printed overleaf, available on request or accessible at <http://www.sgs.com.tw/Terms-and-Conditions> and for electronic format documents, subject to Terms and Conditions for Electronic Documents at <http://www.sgs.com.tw/Terms-and-Conditions>. Attention is drawn to the limitation of liability, indemnification and jurisdiction issues defined therein. Any holder of this document is advised that information contained hereon reflects the Company's findings at the time of its intervention only and within the limits of Client's instructions, if any. The Company's sole responsibility is to its Client and this document does not exonerate parties to a transaction from exercising all their rights and obligations under the transaction documents. This document cannot be reproduced except in full, without prior written approval of the Company. Any unauthorized alteration, forgery or falsification of the content or appearance of this document is unlawful and offenders may be prosecuted to the fullest extent of the law.

Report Number :ER-2020-40010
Operation Mode :GSM 1900
Test Mode :Tx CH Mid
EUT Pol :H Plane
Test Frequency :1880.0 MHz

Test Date :2020-04-17
Temp./Humi. :22.6/66
Antenna Pol. :HORIZONTAL
Engineer :Nick

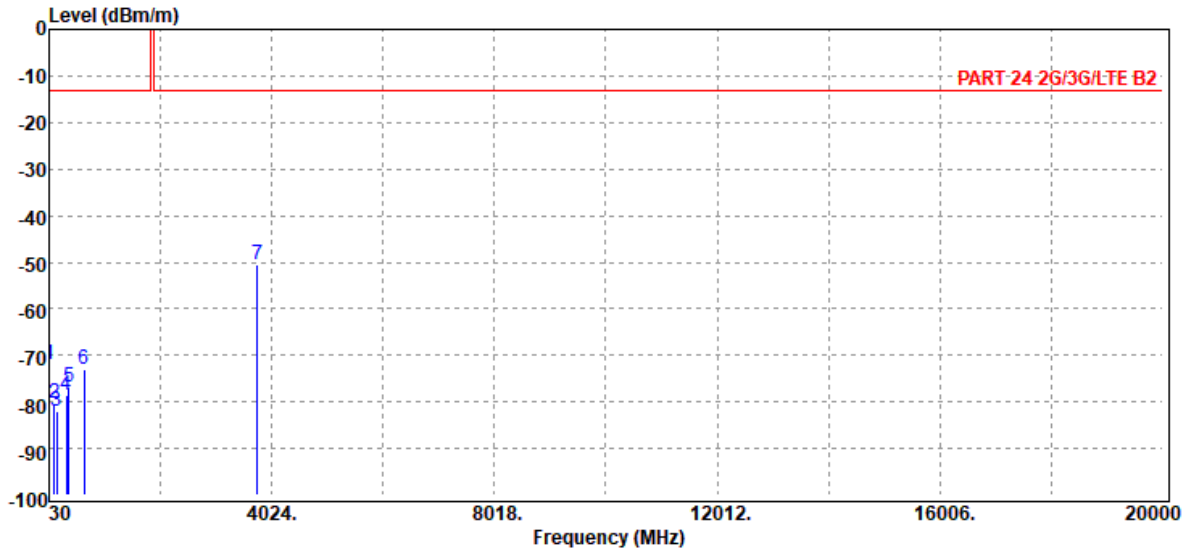

Freq. MHz	EIRP/ERP dBm	SG Output Level dBm	Antenna Gain dBi/dBd	Cable Loss dB	Limit dBm	Margin dB
30.00	-72.13	-44.31	-27.28	-0.54	-13.00	-59.13
127.00	-80.21	-71.95	-7.25	-1.01	-13.00	-67.21
167.74	-81.91	-77.79	-2.86	-1.26	-13.00	-68.91
342.34	-78.38	-75.19	-1.33	-1.86	-13.00	-65.38
379.20	-76.94	-73.91	-1.23	-1.80	-13.00	-63.94
660.50	-73.07	-70.04	-0.34	-2.69	-13.00	-60.07
3760.00	-50.43	-57.09	12.40	-5.74	-13.00	-37.43

Unless otherwise stated the results shown in this test report refer only to the sample(s) tested and such sample(s) are retained for 90 days only.

除非另有說明，此報告結果僅對測試之樣品負責，同時此樣品僅保留90天。本報告未經本公司書面許可，不可部份複製。

This document is issued by the Company subject to its General Conditions of Service printed overleaf, available on request or accessible at <http://www.sgs.com.tw/Terms-and-Conditions> and for electronic format documents, subject to Terms and Conditions for Electronic Documents at <http://www.sgs.com.tw/Terms-and-Conditions>. Attention is drawn to the limitation of liability, indemnification and jurisdiction issues defined therein. Any holder of this document is advised that information contained hereon reflects the Company's findings at the time of its intervention only and within the limits of Client's instructions, if any. The Company's sole responsibility is to its Client and this document does not exonerate parties to a transaction from exercising all their rights and obligations under the transaction documents. This document cannot be reproduced except in full, without prior written approval of the Company. Any unauthorized alteration, forgery or falsification of the content or appearance of this document is unlawful and offenders may be prosecuted to the fullest extent of the law.

Report Number :ER-2020-40010
 Operation Mode :GSM 1900
 Test Mode :Tx CH High
 EUT Pol :H Plane
 Test Frequency :1909.8 MHz

Test Date :2020-04-17
 Temp./Humi. :22.6/66
 Antenna Pol. :VERTICAL
 Engineer :Nick

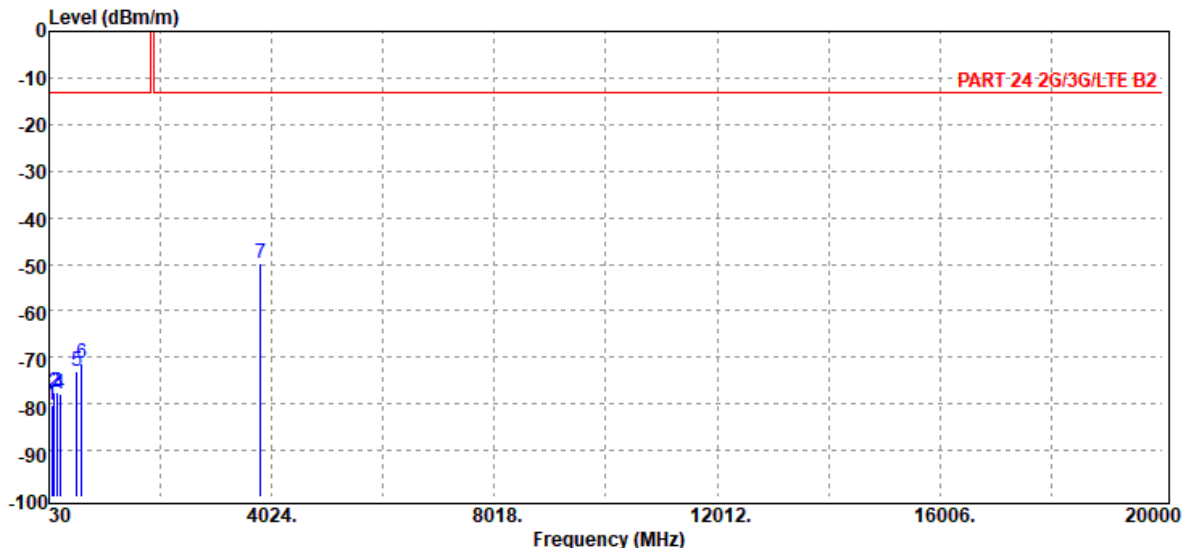

Freq. MHz	EIRP/ERP dBm	SG Output Level dBm	Antenna Gain dBi/dBd	Cable Loss dB	Limit dBm	Margin dB
86.26	-80.30	-72.76	-6.66	-0.88	-13.00	-67.30
128.94	-77.51	-69.40	-7.12	-0.99	-13.00	-64.51
175.50	-77.51	-74.23	-2.04	-1.24	-13.00	-64.51
228.85	-77.78	-75.04	-1.32	-1.42	-13.00	-64.78
529.55	-73.16	-70.48	-0.84	-1.84	-13.00	-60.16
616.85	-71.33	-68.64	-0.66	-2.03	-13.00	-58.33
3819.60	-49.86	-56.47	12.40	-5.79	-13.00	-36.86

Unless otherwise stated the results shown in this test report refer only to the sample(s) tested and such sample(s) are retained for 90 days only.

除非另有說明，此報告結果僅對測試之樣品負責，同時此樣品僅保留90天。本報告未經本公司書面許可，不可部份複製。

This document is issued by the Company subject to its General Conditions of Service printed overleaf, available on request or accessible at <http://www.sgs.com.tw/Terms-and-Conditions> and for electronic format documents, subject to Terms and Conditions for Electronic Documents at <http://www.sgs.com.tw/Terms-and-Conditions>. Attention is drawn to the limitation of liability, indemnification and jurisdiction issues defined therein. Any holder of this document is advised that information contained hereon reflects the Company's findings at the time of its intervention only and within the limits of Client's instructions, if any. The Company's sole responsibility is to its Client and this document does not exonerate parties to a transaction from exercising all their rights and obligations under the transaction documents. This document cannot be reproduced except in full, without prior written approval of the Company. Any unauthorized alteration, forgery or falsification of the content or appearance of this document is unlawful and offenders may be prosecuted to the fullest extent of the law.

Report Number :ER-2020-40010
 Operation Mode :GSM 1900
 Test Mode :Tx CH High
 EUT Pol :H Plane
 Test Frequency :1909.8 MHz

Test Date :2020-04-17
 Temp./Humi. :22.6/66
 Antenna Pol. :HORIZONTAL
 Engineer :Nick

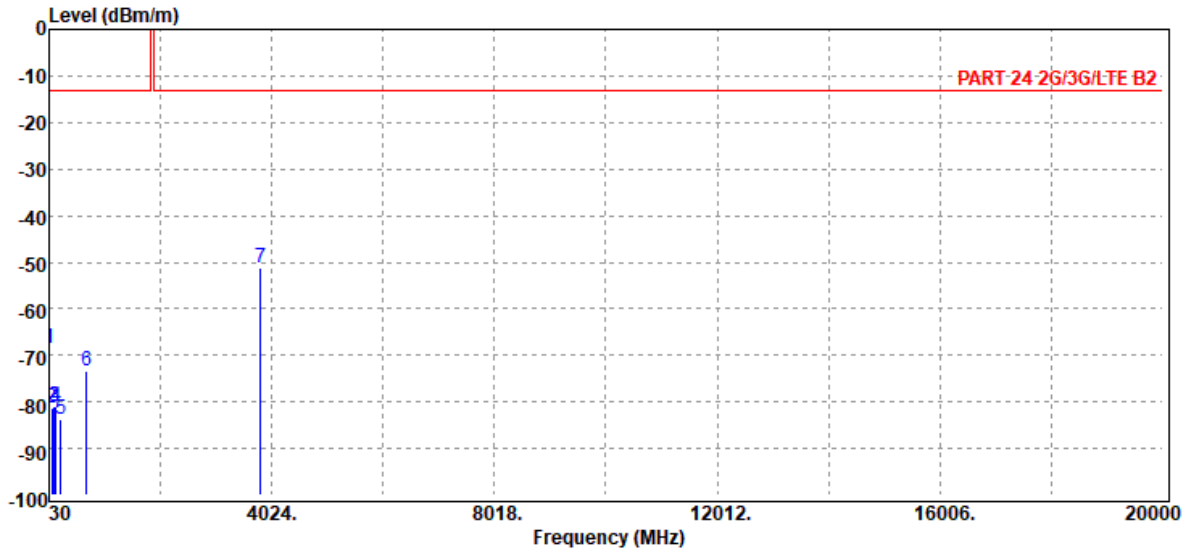

Freq. MHz	EIRP/ERP dBm	SG Output Level dBm	Antenna Gain dBi/dBd	Cable Loss dB	Limit dBm	Margin dB
31.94	-68.35	-41.84	-25.96	-0.55	-13.00	-55.35
80.44	-81.35	-73.98	-6.52	-0.85	-13.00	-68.35
127.00	-80.87	-72.61	-7.25	-1.01	-13.00	-67.87
149.31	-80.97	-74.92	-4.84	-1.21	-13.00	-67.97
238.55	-83.67	-80.44	-1.76	-1.47	-13.00	-70.67
696.39	-73.44	-71.08	-0.20	-2.16	-13.00	-60.44
3819.60	-51.22	-57.83	12.40	-5.79	-13.00	-38.22

Unless otherwise stated the results shown in this test report refer only to the sample(s) tested and such sample(s) are retained for 90 days only.

除非另有說明，此報告結果僅對測試之樣品負責，同時此樣品僅保留90天。本報告未經本公司書面許可，不可部份複製。

This document is issued by the Company subject to its General Conditions of Service printed overleaf, available on request or accessible at <http://www.sgs.com.tw/Terms-and-Conditions> and for electronic format documents, subject to Terms and Conditions for Electronic Documents at <http://www.sgs.com.tw/Terms-and-Conditions>. Attention is drawn to the limitation of liability, indemnification and jurisdiction issues defined therein. Any holder of this document is advised that information contained hereon reflects the Company's findings at the time of its intervention only and within the limits of Client's instructions, if any. The Company's sole responsibility is to its Client and this document does not exonerate parties to a transaction from exercising all their rights and obligations under the transaction documents. This document cannot be reproduced except in full, without prior written approval of the Company. Any unauthorized alteration, forgery or falsification of the content or appearance of this document is unlawful and offenders may be prosecuted to the fullest extent of the law.

Report Number :ER-2020-40010
 Operation Mode :WCDMA B5
 Test Mode :Tx CH Low
 EUT Pol :H Plane
 Test Frequency :826.4 MHz

Test Date :2020-04-17
 Temp./Humi. :22.6/66
 Antenna Pol. :VERTICAL
 Engineer :Nick

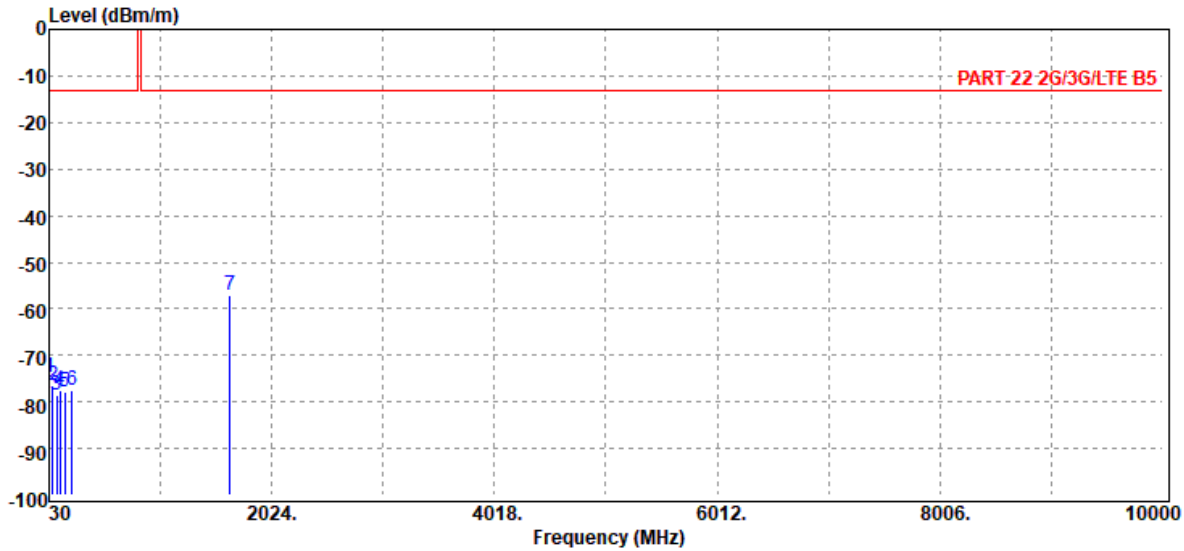

Freq. MHz	EIRP/ERP dBm	SG Output Level dBm	Antenna Gain dBi/dBd	Cable Loss dB	Limit dBm	Margin dB
36.79	-74.57	-52.01	-21.97	-0.59	-13.00	-61.57
65.89	-76.63	-68.49	-7.35	-0.79	-13.00	-63.63
94.99	-78.60	-69.80	-7.87	-0.93	-13.00	-65.60
128.94	-77.66	-69.55	-7.12	-0.99	-13.00	-64.66
167.74	-77.69	-73.57	-2.86	-1.26	-13.00	-64.69
233.70	-77.57	-74.57	-1.55	-1.45	-13.00	-64.57
1652.80	-57.09	-63.13	9.91	-3.87	-13.00	-44.09

Unless otherwise stated the results shown in this test report refer only to the sample(s) tested and such sample(s) are retained for 90 days only.
 除非另有說明，此報告結果僅對測試之樣品負責，同時此樣品僅保留90天。本報告未經本公司書面許可，不可部份複製。

This document is issued by the Company subject to its General Conditions of Service printed overleaf, available on request or accessible at <http://www.sgs.com.tw/Terms-and-Conditions> and for electronic format documents, subject to Terms and Conditions for Electronic Documents at <http://www.sgs.com.tw/Terms-and-Conditions>. Attention is drawn to the limitation of liability, indemnification and jurisdiction issues defined therein. Any holder of this document is advised that information contained hereon reflects the Company's findings at the time of its intervention only and within the limits of Client's instructions, if any. The Company's sole responsibility is to its Client and this document does not exonerate parties to a transaction from exercising all their rights and obligations under the transaction documents. This document cannot be reproduced except in full, without prior written approval of the Company. Any unauthorized alteration, forgery or falsification of the content or appearance of this document is unlawful and offenders may be prosecuted to the fullest extent of the law.

Report Number :ER-2020-40010
Operation Mode :WCDMA B5
Test Mode :Tx CH Low
EUT Pol :H Plane
Test Frequency :826.4 MHz

Test Date :2020-04-17
Temp./Humi. :22.6/66
Antenna Pol. :HORIZONTAL
Engineer :Nick

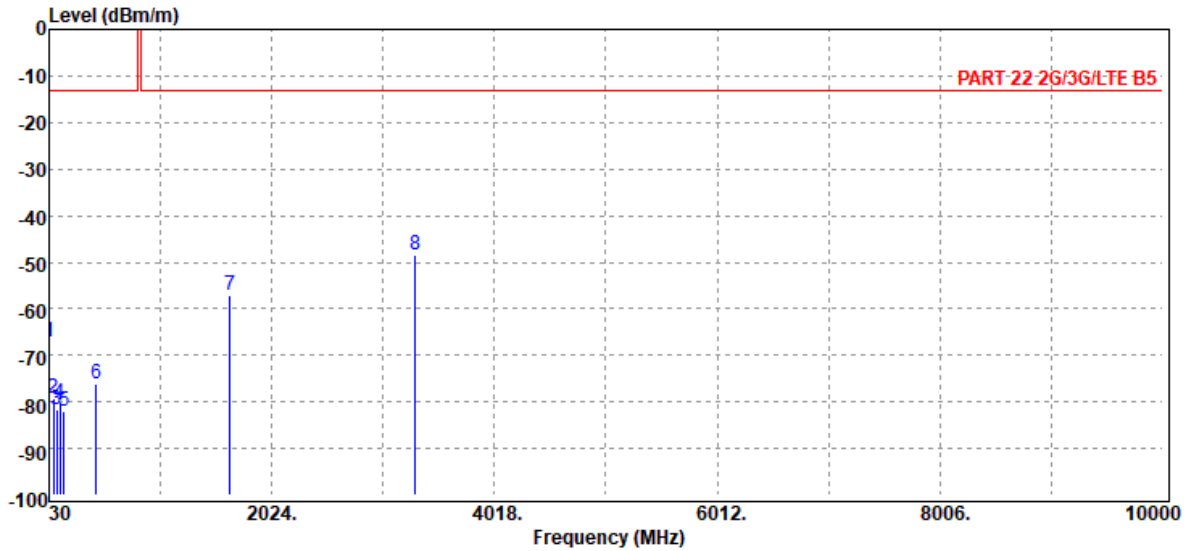

Freq. MHz	EIRP/ERP dBm	SG Output Level dBm	Antenna Gain dBi/dBd	Cable Loss dB	Limit dBm	Margin dB
30.00	-67.22	-39.40	-27.28	-0.54	-13.00	-54.22
66.86	-79.21	-71.28	-7.14	-0.79	-13.00	-66.21
94.99	-81.59	-72.79	-7.87	-0.93	-13.00	-68.59
127.00	-80.24	-71.98	-7.25	-1.01	-13.00	-67.24
160.95	-82.00	-77.10	-3.69	-1.21	-13.00	-69.00
453.89	-76.28	-73.38	-1.07	-1.83	-13.00	-63.28
1652.80	-57.05	-63.09	9.91	-3.87	-13.00	-44.05
3305.60	-48.56	-54.79	12.43	-6.20	-13.00	-35.56

Unless otherwise stated the results shown in this test report refer only to the sample(s) tested and such sample(s) are retained for 90 days only.
除非另有說明，此報告結果僅對測試之樣品負責，同時此樣品僅保留90天。本報告未經本公司書面許可，不可部份複製。

This document is issued by the Company subject to its General Conditions of Service printed overleaf, available on request or accessible at <http://www.sgs.com.tw/Terms-and-Conditions> and for electronic format documents, subject to Terms and Conditions for Electronic Documents at <http://www.sgs.com.tw/Terms-and-Conditions>. Attention is drawn to the limitation of liability, indemnification and jurisdiction issues defined therein. Any holder of this document is advised that information contained hereon reflects the Company's findings at the time of its intervention only and within the limits of Client's instructions, if any. The Company's sole responsibility is to its Client and this document does not exonerate parties to a transaction from exercising all their rights and obligations under the transaction documents. This document cannot be reproduced except in full, without prior written approval of the Company. Any unauthorized alteration, forgery or falsification of the content or appearance of this document is unlawful and offenders may be prosecuted to the fullest extent of the law.

Report Number :ER-2020-40010
 Operation Mode :WCDMA B5
 Test Mode :Tx CH Mid
 EUT Pol :H Plane
 Test Frequency :836.6 MHz

Test Date :2020-04-17
 Temp./Humi. :22.6/66
 Antenna Pol. :VERTICAL
 Engineer :Nick

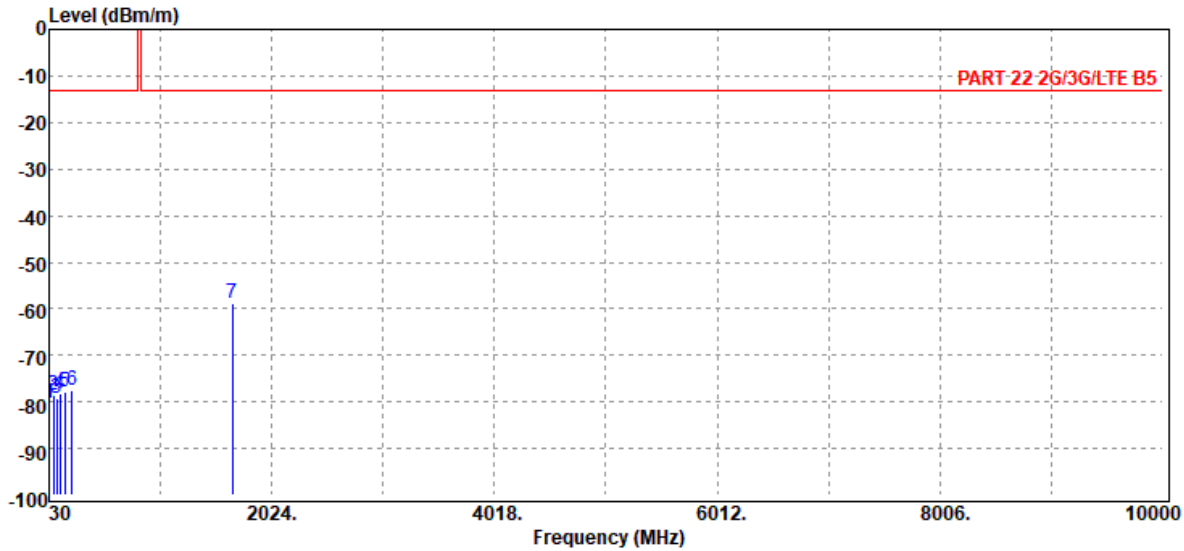

Freq. MHz	EIRP/ERP dBm	SG Output Level dBm	Antenna Gain dBi/dBd	Cable Loss dB	Limit dBm	Margin dB
30.00	-80.23	-52.41	-27.28	-0.54	-13.00	-67.23
68.80	-78.54	-70.66	-7.07	-0.81	-13.00	-65.54
94.99	-79.30	-70.50	-7.87	-0.93	-13.00	-66.30
128.94	-78.16	-70.05	-7.12	-0.99	-13.00	-65.16
172.59	-77.80	-74.21	-2.33	-1.26	-13.00	-64.80
235.64	-77.63	-74.54	-1.63	-1.46	-13.00	-64.63
1673.20	-58.90	-64.95	9.95	-3.90	-13.00	-45.90

Unless otherwise stated the results shown in this test report refer only to the sample(s) tested and such sample(s) are retained for 90 days only.

除非另有說明，此報告結果僅對測試之樣品負責，同時此樣品僅保留90天。本報告未經本公司書面許可，不可部份複製。

This document is issued by the Company subject to its General Conditions of Service printed overleaf, available on request or accessible at <http://www.sgs.com.tw/Terms-and-Conditions> and for electronic format documents, subject to Terms and Conditions for Electronic Documents at <http://www.sgs.com.tw/Terms-and-Conditions>. Attention is drawn to the limitation of liability, indemnification and jurisdiction issues defined therein. Any holder of this document is advised that information contained hereon reflects the Company's findings at the time of its intervention only and within the limits of Client's instructions, if any. The Company's sole responsibility is to its Client and this document does not exonerate parties to a transaction from exercising all their rights and obligations under the transaction documents. This document cannot be reproduced except in full, without prior written approval of the Company. Any unauthorized alteration, forgery or falsification of the content or appearance of this document is unlawful and offenders may be prosecuted to the fullest extent of the law.

Report Number :ER-2020-40010
 Operation Mode :WCDMA B5
 Test Mode :Tx CH Mid
 EUT Pol :H Plane
 Test Frequency :836.6 MHz

Test Date :2020-04-17
 Temp./Humi. :22.6/66
 Antenna Pol. :HORIZONTAL
 Engineer :Nick

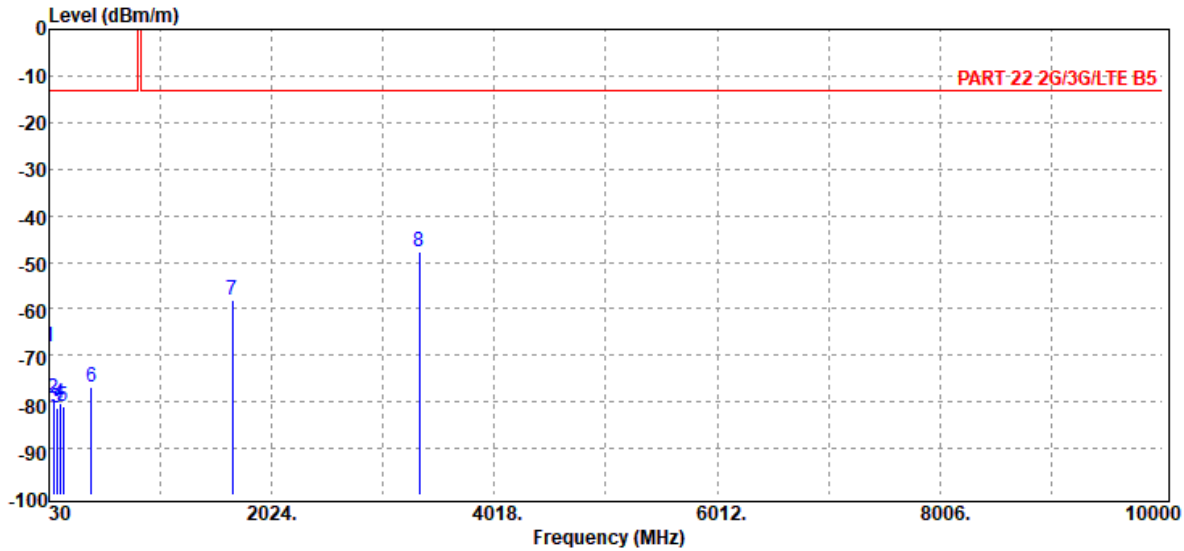

Freq. MHz	EIRP/ERP dBm	SG Output Level dBm	Antenna Gain dBi/dBd	Cable Loss dB	Limit dBm	Margin dB
30.00	-68.22	-40.40	-27.28	-0.54	-13.00	-55.22
68.80	-79.30	-71.42	-7.07	-0.81	-13.00	-66.30
94.99	-81.23	-72.43	-7.87	-0.93	-13.00	-68.23
128.94	-80.24	-72.13	-7.12	-0.99	-13.00	-67.24
153.19	-80.96	-75.24	-4.50	-1.22	-13.00	-67.96
408.30	-76.96	-73.22	-1.87	-1.87	-13.00	-63.96
1673.20	-58.22	-64.27	9.95	-3.90	-13.00	-45.22
3346.40	-47.71	-54.74	12.68	-5.65	-13.00	-34.71

Unless otherwise stated the results shown in this test report refer only to the sample(s) tested and such sample(s) are retained for 90 days only.
 除非另有說明，此報告結果僅對測試之樣品負責，同時此樣品僅保留90天。本報告未經本公司書面許可，不可部份複製。

This document is issued by the Company subject to its General Conditions of Service printed overleaf, available on request or accessible at <http://www.sgs.com.tw/Terms-and-Conditions> and for electronic format documents, subject to Terms and Conditions for Electronic Documents at <http://www.sgs.com.tw/Terms-and-Conditions>. Attention is drawn to the limitation of liability, indemnification and jurisdiction issues defined therein. Any holder of this document is advised that information contained hereon reflects the Company's findings at the time of its intervention only and within the limits of Client's instructions, if any. The Company's sole responsibility is to its Client and this document does not exonerate parties to a transaction from exercising all their rights and obligations under the transaction documents. This document cannot be reproduced except in full, without prior written approval of the Company. Any unauthorized alteration, forgery or falsification of the content or appearance of this document is unlawful and offenders may be prosecuted to the fullest extent of the law.

Report Number :ER-2020-40010
 Operation Mode :WCDMA B5
 Test Mode :Tx CH High
 EUT Pol :H Plane
 Test Frequency :846.6 MHz

Test Date :2020-04-17
 Temp./Humi. :22.6/66
 Antenna Pol. :VERTICAL
 Engineer :Nick

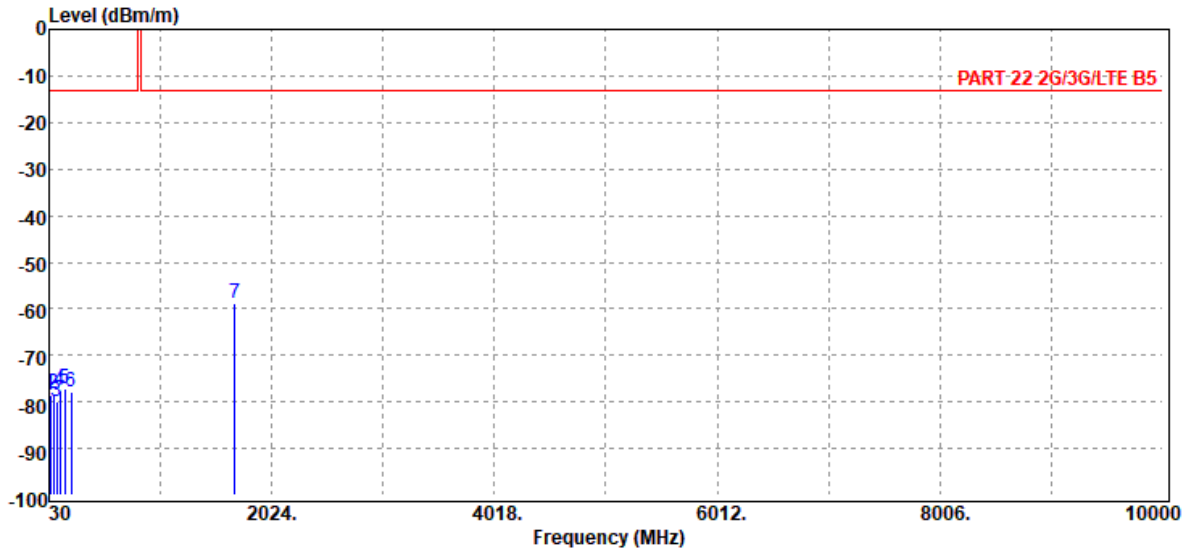

Freq. MHz	EIRP/ERP dBm	SG Output Level dBm	Antenna Gain dBi/dBd	Cable Loss dB	Limit dBm	Margin dB
37.76	-78.43	-56.83	-21.00	-0.60	-13.00	-65.43
68.80	-78.13	-70.25	-7.07	-0.81	-13.00	-65.13
94.99	-79.96	-71.16	-7.87	-0.93	-13.00	-66.96
128.94	-77.60	-69.49	-7.12	-0.99	-13.00	-64.60
172.59	-77.11	-73.52	-2.33	-1.26	-13.00	-64.11
230.79	-77.81	-74.95	-1.43	-1.43	-13.00	-64.81
1693.20	-58.99	-65.06	9.99	-3.92	-13.00	-45.99

Unless otherwise stated the results shown in this test report refer only to the sample(s) tested and such sample(s) are retained for 90 days only.

除非另有說明，此報告結果僅對測試之樣品負責，同時此樣品僅保留90天。本報告未經本公司書面許可，不可部份複製。

This document is issued by the Company subject to its General Conditions of Service printed overleaf, available on request or accessible at <http://www.sgs.com.tw/Terms-and-Conditions> and for electronic format documents, subject to Terms and Conditions for Electronic Documents at <http://www.sgs.com.tw/Terms-and-Conditions>. Attention is drawn to the limitation of liability, indemnification and jurisdiction issues defined therein. Any holder of this document is advised that information contained hereon reflects the Company's findings at the time of its intervention only and within the limits of Client's instructions, if any. The Company's sole responsibility is to its Client and this document does not exonerate parties to a transaction from exercising all their rights and obligations under the transaction documents. This document cannot be reproduced except in full, without prior written approval of the Company. Any unauthorized alteration, forgery or falsification of the content or appearance of this document is unlawful and offenders may be prosecuted to the fullest extent of the law.

Report Number :ER-2020-40010
 Operation Mode :WCDMA B5
 Test Mode :Tx CH High
 EUT Pol :H Plane
 Test Frequency :846.6 MHz

Test Date :2020-04-17
 Temp./Humi. :22.6/66
 Antenna Pol. :HORIZONTAL
 Engineer :Nick

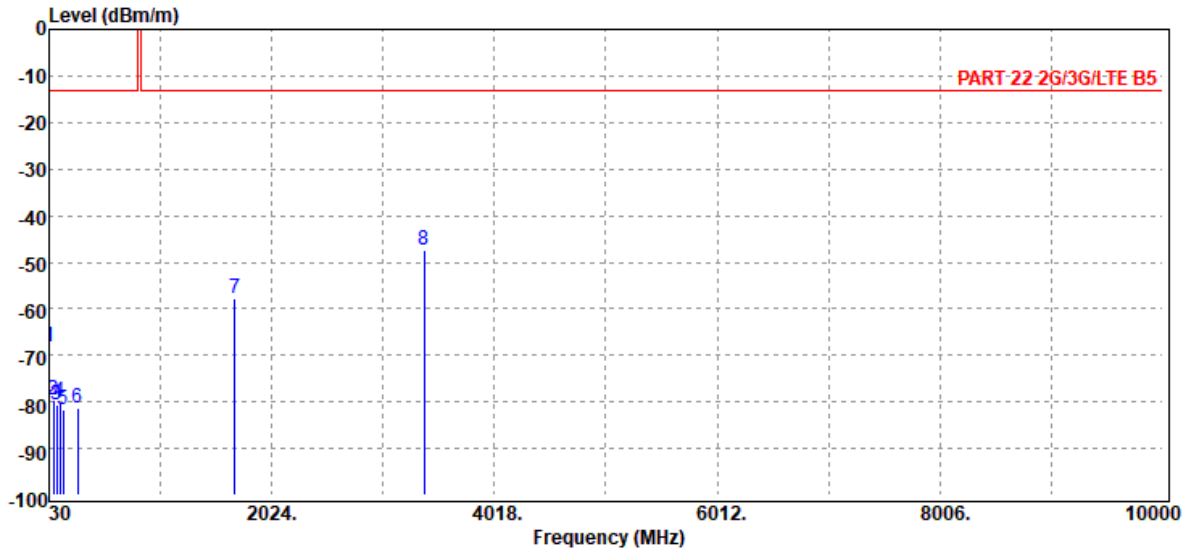

Freq. MHz	EIRP/ERP dBm	SG Output Level dBm	Antenna Gain dBi/dBd	Cable Loss dB	Limit dBm	Margin dB
30.00	-68.05	-40.23	-27.28	-0.54	-13.00	-55.05
66.86	-79.54	-71.61	-7.14	-0.79	-13.00	-66.54
94.99	-80.78	-71.98	-7.87	-0.93	-13.00	-67.78
127.00	-79.99	-71.73	-7.25	-1.01	-13.00	-66.99
157.07	-81.81	-76.59	-4.01	-1.21	-13.00	-68.81
288.99	-81.21	-78.11	-1.49	-1.61	-13.00	-68.21
1693.20	-57.95	-64.02	9.99	-3.92	-13.00	-44.95
3386.40	-47.57	-55.16	12.70	-5.11	-13.00	-34.57

Unless otherwise stated the results shown in this test report refer only to the sample(s) tested and such sample(s) are retained for 90 days only.
 除非另有說明，此報告結果僅對測試之樣品負責，同時此樣品僅保留90天。本報告未經本公司書面許可，不可部份複製。

This document is issued by the Company subject to its General Conditions of Service printed overleaf, available on request or accessible at <http://www.sgs.com.tw/Terms-and-Conditions> and for electronic format documents, subject to Terms and Conditions for Electronic Documents at <http://www.sgs.com.tw/Terms-and-Conditions>. Attention is drawn to the limitation of liability, indemnification and jurisdiction issues defined therein. Any holder of this document is advised that information contained hereon reflects the Company's findings at the time of its intervention only and within the limits of Client's instructions, if any. The Company's sole responsibility is to its Client and this document does not exonerate parties to a transaction from exercising all their rights and obligations under the transaction documents. This document cannot be reproduced except in full, without prior written approval of the Company. Any unauthorized alteration, forgery or falsification of the content or appearance of this document is unlawful and offenders may be prosecuted to the fullest extent of the law.

Report Number :ER-2020-40010
Operation Mode :LTE B5
Test Mode :Tx CH Low
EUT Pol :H Plane
Test Frequency :829.0 MHz

Test Date :2020-04-17
Temp./Humi. :22.6/66
Antenna Pol. :VERTICAL
Engineer :Nick

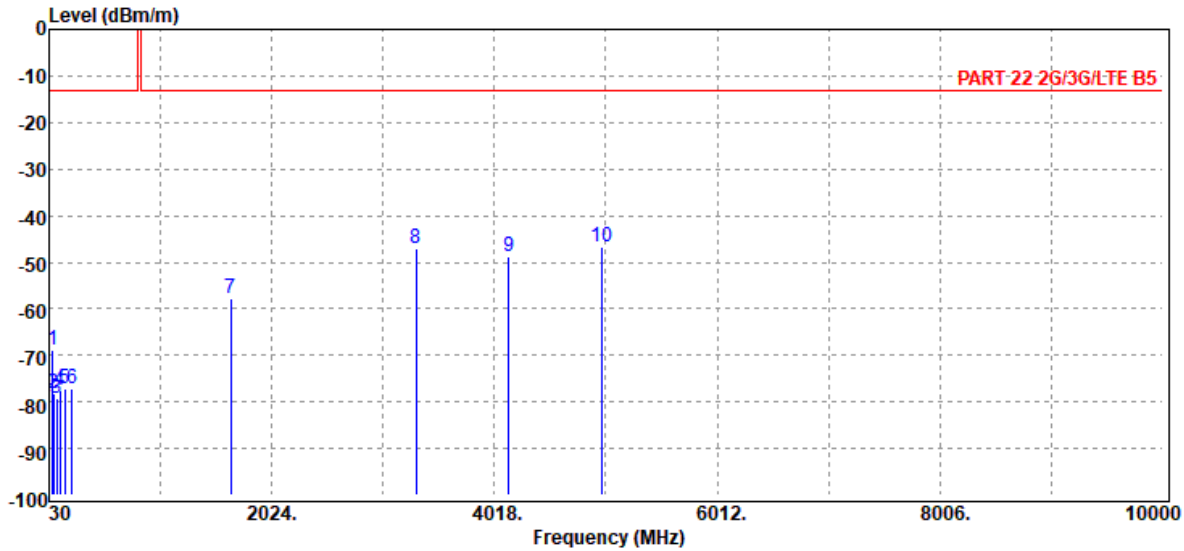

Freq. MHz	EIRP/ERP dBm	SG Output Level dBm	Antenna Gain dBi/dBd	Cable Loss dB	Limit dBm	Margin dB
61.04	-68.86	-59.80	-8.31	-0.75	-13.00	-55.86
68.80	-78.13	-70.25	-7.07	-0.81	-13.00	-65.13
94.99	-79.25	-70.45	-7.87	-0.93	-13.00	-66.25
128.94	-77.44	-69.33	-7.12	-0.99	-13.00	-64.44
172.59	-77.32	-73.73	-2.33	-1.26	-13.00	-64.32
233.70	-77.08	-74.08	-1.55	-1.45	-13.00	-64.08
1658.00	-57.84	-63.88	9.92	-3.88	-13.00	-44.84
3316.00	-47.13	-53.57	12.50	-6.06	-13.00	-34.13
4145.00	-48.91	-55.57	12.80	-6.14	-13.00	-35.91
4974.00	-46.83	-52.69	12.70	-6.84	-13.00	-33.83

Unless otherwise stated the results shown in this test report refer only to the sample(s) tested and such sample(s) are retained for 90 days only.

除非另有說明，此報告結果僅對測試之樣品負責，同時此樣品僅保留90天。本報告未經本公司書面許可，不可部份複製。

This document is issued by the Company subject to its General Conditions of Service printed overleaf, available on request or accessible at <http://www.sgs.com.tw/Terms-and-Conditions> and for electronic format documents, subject to Terms and Conditions for Electronic Documents at <http://www.sgs.com.tw/Terms-and-Conditions>. Attention is drawn to the limitation of liability, indemnification and jurisdiction issues defined therein. Any holder of this document is advised that information contained hereon reflects the Company's findings at the time of its intervention only and within the limits of Client's instructions, if any. The Company's sole responsibility is to its Client and this document does not exonerate parties to a transaction from exercising all their rights and obligations under the transaction documents. This document cannot be reproduced except in full, without prior written approval of the Company. Any unauthorized alteration, forgery or falsification of the content or appearance of this document is unlawful and offenders may be prosecuted to the fullest extent of the law.

Report Number :ER-2020-40010
 Operation Mode :LTE B5
 Test Mode :Tx CH Low
 EUT Pol :H Plane
 Test Frequency :829.0 MHz

Test Date :2020-04-17
 Temp./Humi. :22.6/66
 Antenna Pol. :HORIZONTAL
 Engineer :Nick

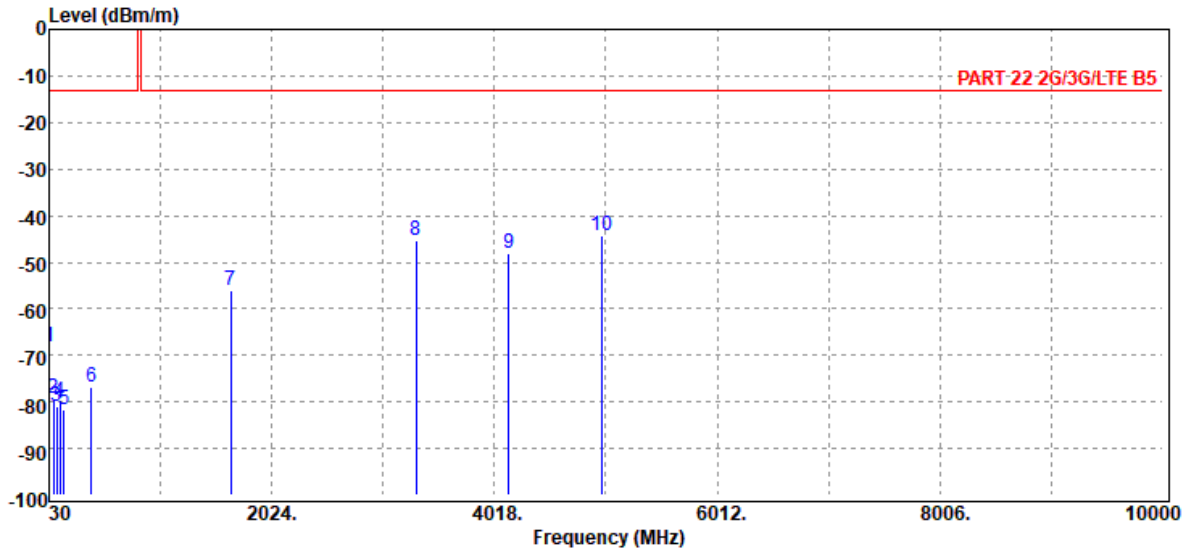

Freq. MHz	EIRP/ERP dBm	SG Output Level dBm	Antenna Gain dBi/dBd	Cable Loss dB	Limit dBm	Margin dB
30.00	-68.22	-40.40	-27.28	-0.54	-13.00	-55.22
68.80	-79.36	-71.48	-7.07	-0.81	-13.00	-66.36
94.99	-81.13	-72.33	-7.87	-0.93	-13.00	-68.13
127.00	-79.91	-71.65	-7.25	-1.01	-13.00	-66.91
162.89	-81.62	-76.91	-3.49	-1.22	-13.00	-68.62
408.30	-76.75	-73.01	-1.87	-1.87	-13.00	-63.75
1658.00	-55.91	-61.95	9.92	-3.88	-13.00	-42.91
3316.00	-45.28	-51.72	12.50	-6.06	-13.00	-32.28
4145.00	-48.03	-54.69	12.80	-6.14	-13.00	-35.03
4974.00	-44.37	-50.23	12.70	-6.84	-13.00	-31.37

Unless otherwise stated the results shown in this test report refer only to the sample(s) tested and such sample(s) are retained for 90 days only.
 除非另有說明，此報告結果僅對測試之樣品負責，同時此樣品僅保留90天。本報告未經本公司書面許可，不可部份複製。

This document is issued by the Company subject to its General Conditions of Service printed overleaf, available on request or accessible at <http://www.sgs.com.tw/Terms-and-Conditions> and for electronic format documents, subject to Terms and Conditions for Electronic Documents at <http://www.sgs.com.tw/Terms-and-Conditions>. Attention is drawn to the limitation of liability, indemnification and jurisdiction issues defined therein. Any holder of this document is advised that information contained hereon reflects the Company's findings at the time of its intervention only and within the limits of Client's instructions, if any. The Company's sole responsibility is to its Client and this document does not exonerate parties to a transaction from exercising all their rights and obligations under the transaction documents. This document cannot be reproduced except in full, without prior written approval of the Company. Any unauthorized alteration, forgery or falsification of the content or appearance of this document is unlawful and offenders may be prosecuted to the fullest extent of the law.

Report Number :ER-2020-40010
Operation Mode :LTE B5
Test Mode :Tx CH Mid
EUT Pol :H Plane
Test Frequency :836.5 MHz

Test Date :2020-04-17
Temp./Humi. :22.6/66
Antenna Pol. :VERTICAL
Engineer :Nick

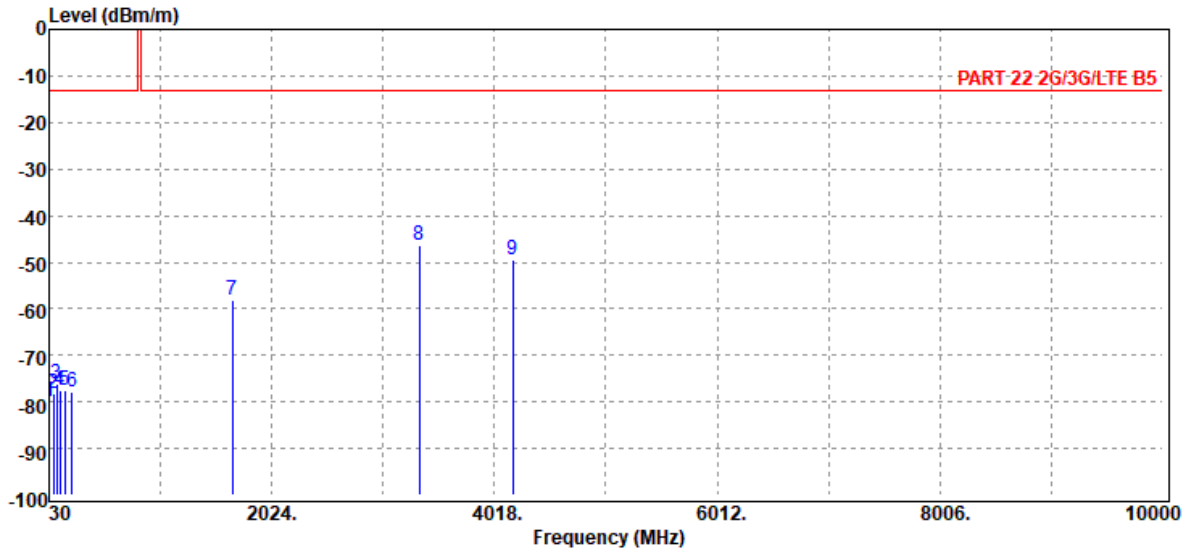

Freq. MHz	EIRP/ERP dBm	SG Output Level dBm	Antenna Gain dBi/dBd	Cable Loss dB	Limit dBm	Margin dB
30.00	-79.89	-52.07	-27.28	-0.54	-13.00	-66.89
68.80	-78.21	-70.33	-7.07	-0.81	-13.00	-65.21
95.96	-76.12	-67.12	-8.07	-0.93	-13.00	-63.12
128.94	-77.63	-69.52	-7.12	-0.99	-13.00	-64.63
173.56	-77.35	-73.86	-2.24	-1.25	-13.00	-64.35
233.70	-77.73	-74.73	-1.55	-1.45	-13.00	-64.73
1673.00	-58.12	-64.17	9.95	-3.90	-13.00	-45.12
3346.00	-46.50	-53.53	12.68	-5.65	-13.00	-33.50
4182.50	-49.34	-55.80	12.80	-6.34	-13.00	-36.34

Unless otherwise stated the results shown in this test report refer only to the sample(s) tested and such sample(s) are retained for 90 days only.

除非另有說明，此報告結果僅對測試之樣品負責，同時此樣品僅保留90天。本報告未經本公司書面許可，不可部份複製。

This document is issued by the Company subject to its General Conditions of Service printed overleaf, available on request or accessible at <http://www.sgs.com.tw/Terms-and-Conditions> and for electronic format documents, subject to Terms and Conditions for Electronic Documents at <http://www.sgs.com.tw/Terms-and-Conditions>. Attention is drawn to the limitation of liability, indemnification and jurisdiction issues defined therein. Any holder of this document is advised that information contained hereon reflects the Company's findings at the time of its intervention only and within the limits of Client's instructions, if any. The Company's sole responsibility is to its Client and this document does not exonerate parties to a transaction from exercising all their rights and obligations under the transaction documents. This document cannot be reproduced except in full, without prior written approval of the Company. Any unauthorized alteration, forgery or falsification of the content or appearance of this document is unlawful and offenders may be prosecuted to the fullest extent of the law.

Report Number :ER-2020-40010
 Operation Mode :LTE B5
 Test Mode :Tx CH Mid
 EUT Pol :H Plane
 Test Frequency :836.5 MHz

Test Date :2020-04-17
 Temp./Humi. :22.6/66
 Antenna Pol. :HORIZONTAL
 Engineer :Nick

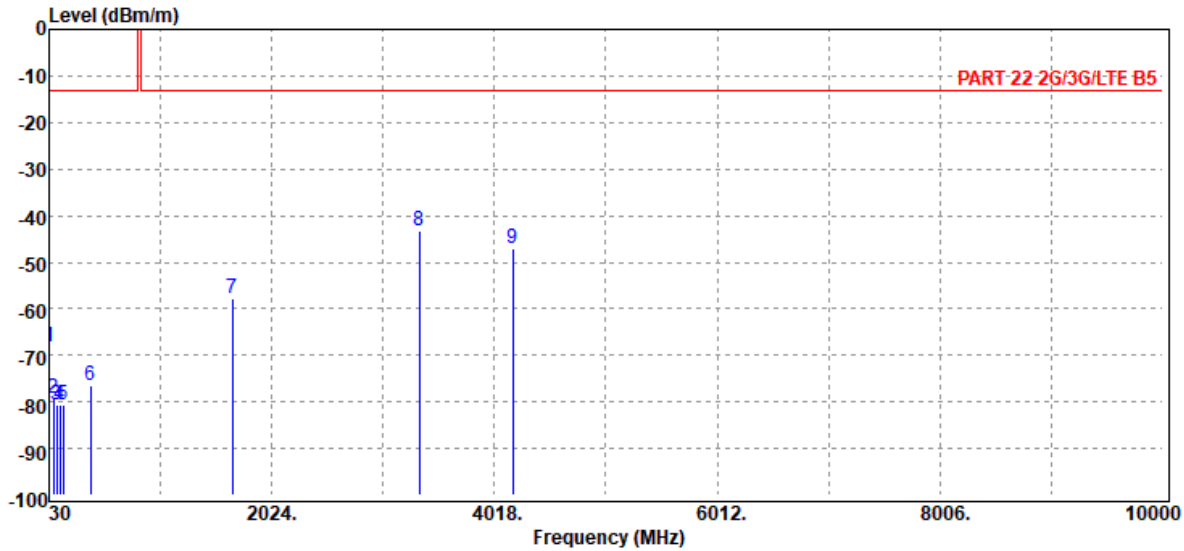

Freq. MHz	EIRP/ERP dBm	SG Output Level dBm	Antenna Gain dBi/dBd	Cable Loss dB	Limit dBm	Margin dB
30.00	-68.08	-40.26	-27.28	-0.54	-13.00	-55.08
66.86	-79.31	-71.38	-7.14	-0.79	-13.00	-66.31
94.99	-80.64	-71.84	-7.87	-0.93	-13.00	-67.64
127.00	-80.77	-72.51	-7.25	-1.01	-13.00	-67.77
154.16	-80.71	-75.12	-4.37	-1.22	-13.00	-67.71
403.45	-76.64	-73.12	-1.65	-1.87	-13.00	-63.64
1673.00	-57.75	-63.80	9.95	-3.90	-13.00	-44.75
3346.00	-43.30	-50.33	12.68	-5.65	-13.00	-30.30
4182.50	-47.02	-53.48	12.80	-6.34	-13.00	-34.02

Unless otherwise stated the results shown in this test report refer only to the sample(s) tested and such sample(s) are retained for 90 days only.
 除非另有說明，此報告結果僅對測試之樣品負責，同時此樣品僅保留90天。本報告未經本公司書面許可，不可部份複製。

This document is issued by the Company subject to its General Conditions of Service printed overleaf, available on request or accessible at <http://www.sgs.com.tw/Terms-and-Conditions> and for electronic format documents, subject to Terms and Conditions for Electronic Documents at <http://www.sgs.com.tw/Terms-and-Conditions>. Attention is drawn to the limitation of liability, indemnification and jurisdiction issues defined therein. Any holder of this document is advised that information contained hereon reflects the Company's findings at the time of its intervention only and within the limits of Client's instructions, if any. The Company's sole responsibility is to its Client and this document does not exonerate parties to a transaction from exercising all their rights and obligations under the transaction documents. This document cannot be reproduced except in full, without prior written approval of the Company. Any unauthorized alteration, forgery or falsification of the content or appearance of this document is unlawful and offenders may be prosecuted to the fullest extent of the law.

Report Number :ER-2020-40010
 Operation Mode :LTE B5
 Test Mode :Tx CH High
 EUT Pol :H Plane
 Test Frequency :844.0 MHz

Test Date :2020-04-17
 Temp./Humi. :22.6/66
 Antenna Pol. :VERTICAL
 Engineer :Nick

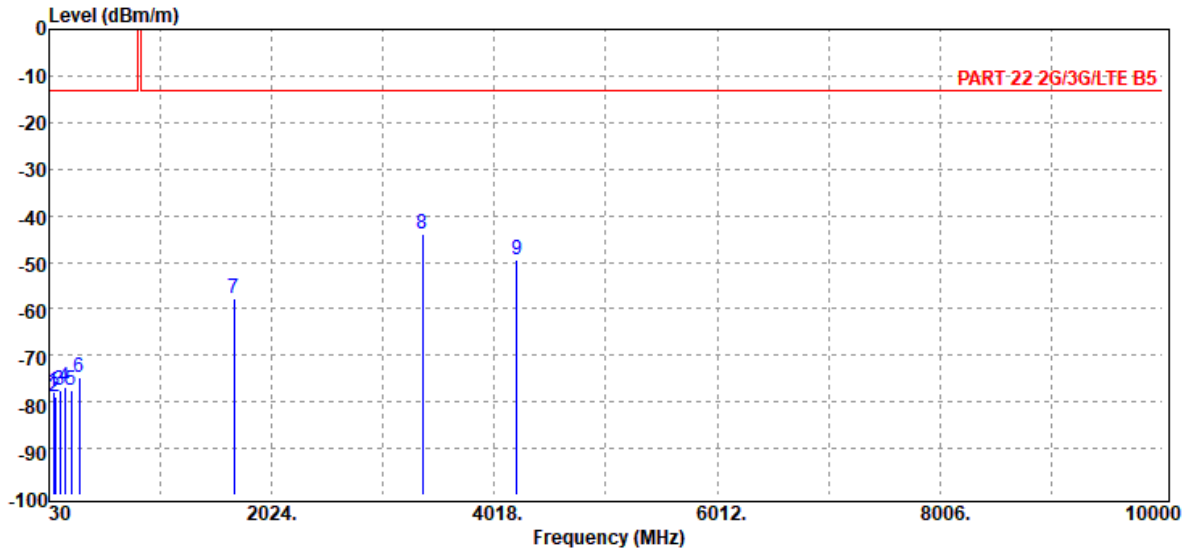

Freq. MHz	EIRP/ERP dBm	SG Output Level dBm	Antenna Gain dBi/dBd	Cable Loss dB	Limit dBm	Margin dB
68.80	-77.97	-70.09	-7.07	-0.81	-13.00	-64.97
83.35	-78.92	-71.57	-6.48	-0.87	-13.00	-65.92
128.94	-77.57	-69.46	-7.12	-0.99	-13.00	-64.57
172.59	-76.75	-73.16	-2.33	-1.26	-13.00	-63.75
225.94	-77.66	-75.12	-1.14	-1.40	-13.00	-64.66
299.66	-74.82	-71.81	-1.39	-1.62	-13.00	-61.82
1688.00	-57.85	-63.91	9.98	-3.92	-13.00	-44.85
3376.00	-43.86	-51.31	12.70	-5.25	-13.00	-30.86
4220.00	-49.60	-56.02	12.80	-6.38	-13.00	-36.60

Unless otherwise stated the results shown in this test report refer only to the sample(s) tested and such sample(s) are retained for 90 days only.

除非另有說明，此報告結果僅對測試之樣品負責，同時此樣品僅保留90天。本報告未經本公司書面許可，不可部份複製。

This document is issued by the Company subject to its General Conditions of Service printed overleaf, available on request or accessible at <http://www.sgs.com.tw/Terms-and-Conditions> and for electronic format documents, subject to Terms and Conditions for Electronic Documents at <http://www.sgs.com.tw/Terms-and-Conditions>. Attention is drawn to the limitation of liability, indemnification and jurisdiction issues defined therein. Any holder of this document is advised that information contained hereon reflects the Company's findings at the time of its intervention only and within the limits of Client's instructions, if any. The Company's sole responsibility is to its Client and this document does not exonerate parties to a transaction from exercising all their rights and obligations under the transaction documents. This document cannot be reproduced except in full, without prior written approval of the Company. Any unauthorized alteration, forgery or falsification of the content or appearance of this document is unlawful and offenders may be prosecuted to the fullest extent of the law.

Report Number :ER-2020-40010
 Operation Mode :LTE B5
 Test Mode :Tx CH High
 EUT Pol :H Plane
 Test Frequency :844.0 MHz

Test Date :2020-04-17
 Temp./Humi. :22.6/66
 Antenna Pol. :HORIZONTAL
 Engineer :Nick

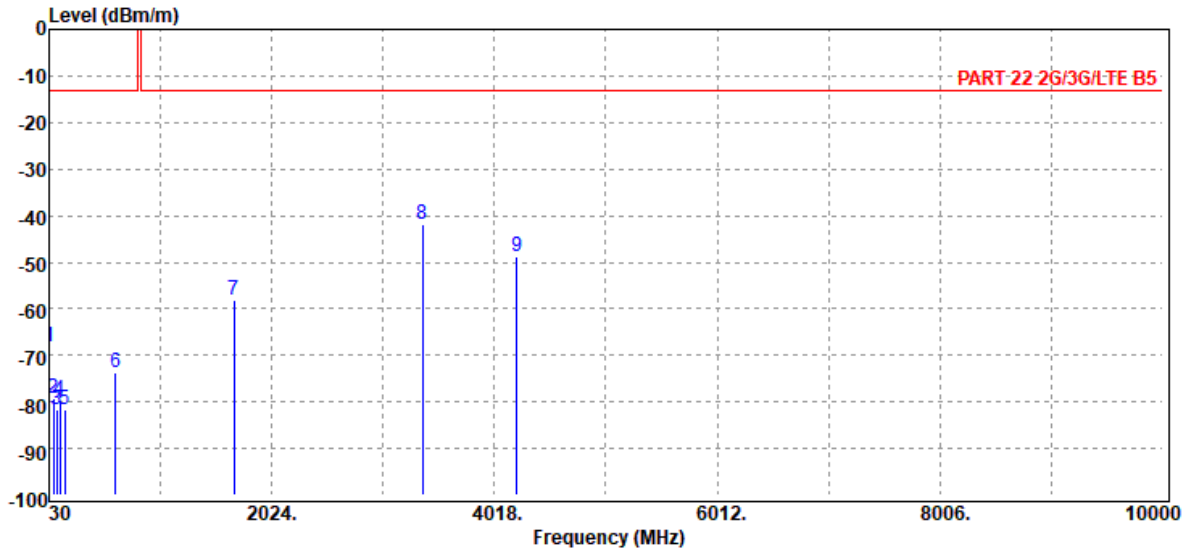

Freq. MHz	EIRP/ERP dBm	SG Output Level dBm	Antenna Gain dBi/dBd	Cable Loss dB	Limit dBm	Margin dB
30.00	-68.31	-40.49	-27.28	-0.54	-13.00	-55.31
66.86	-79.32	-71.39	-7.14	-0.79	-13.00	-66.32
94.99	-81.54	-72.74	-7.87	-0.93	-13.00	-68.54
125.06	-79.46	-71.15	-7.29	-1.02	-13.00	-66.46
172.59	-81.52	-77.93	-2.33	-1.26	-13.00	-68.52
621.70	-73.81	-71.09	-0.62	-2.10	-13.00	-60.81
1688.00	-58.00	-64.06	9.98	-3.92	-13.00	-45.00
3376.00	-41.76	-49.21	12.70	-5.25	-13.00	-28.76
4220.00	-48.68	-55.10	12.80	-6.38	-13.00	-35.68

Unless otherwise stated the results shown in this test report refer only to the sample(s) tested and such sample(s) are retained for 90 days only.
 除非另有說明，此報告結果僅對測試之樣品負責，同時此樣品僅保留90天。本報告未經本公司書面許可，不可部份複製。

This document is issued by the Company subject to its General Conditions of Service printed overleaf, available on request or accessible at <http://www.sgs.com.tw/Terms-and-Conditions> and for electronic format documents, subject to Terms and Conditions for Electronic Documents at <http://www.sgs.com.tw/Terms-and-Conditions>. Attention is drawn to the limitation of liability, indemnification and jurisdiction issues defined therein. Any holder of this document is advised that information contained hereon reflects the Company's findings at the time of its intervention only and within the limits of Client's instructions, if any. The Company's sole responsibility is to its Client and this document does not exonerate parties to a transaction from exercising all their rights and obligations under the transaction documents. This document cannot be reproduced except in full, without prior written approval of the Company. Any unauthorized alteration, forgery or falsification of the content or appearance of this document is unlawful and offenders may be prosecuted to the fullest extent of the law.

Report Number :ER-2020-40010
Operation Mode :LTE B12
Test Mode :Tx CH Low
EUT Pol :H Plane
Test Frequency :704.0 MHz

Test Date :2020-04-17
Temp./Humi. :22.6/66
Antenna Pol. :VERTICAL
Engineer :Nick

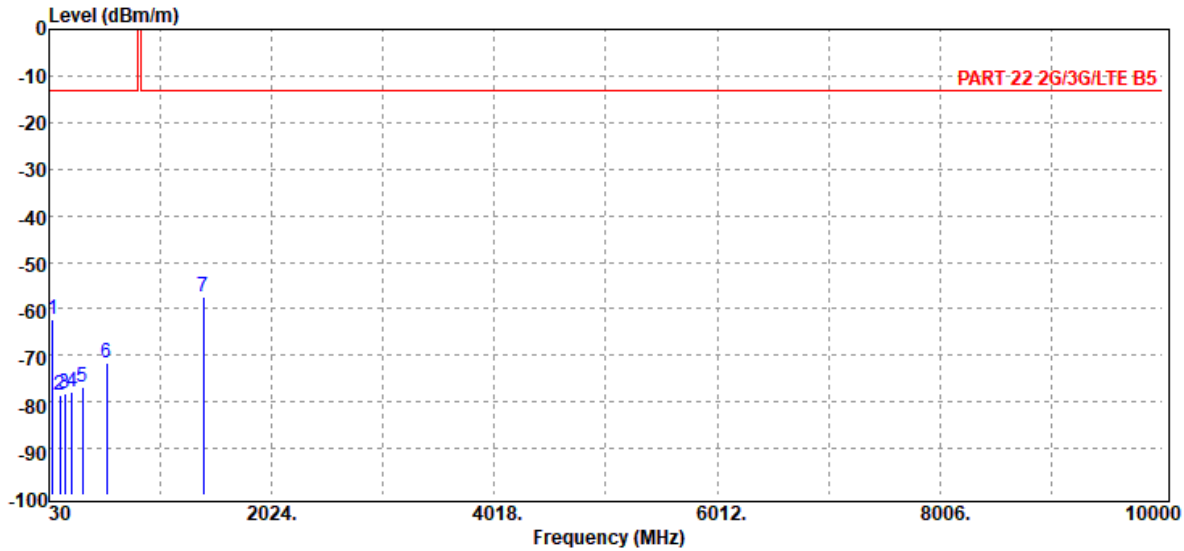

Freq. MHz	EIRP/ERP dBm	SG Output Level dBm	Antenna Gain dBi/dBd	Cable Loss dB	Limit dBm	Margin dB
61.04	-62.26	-53.20	-8.31	-0.75	-13.00	-49.26
128.94	-78.53	-70.42	-7.12	-0.99	-13.00	-65.53
172.59	-78.13	-74.54	-2.33	-1.26	-13.00	-65.13
233.70	-77.73	-74.73	-1.55	-1.45	-13.00	-64.73
332.64	-76.82	-73.89	-1.19	-1.74	-13.00	-63.82
548.95	-71.69	-68.48	-1.04	-2.17	-13.00	-58.69
1408.00	-57.33	-61.70	7.95	-3.58	-13.00	-44.33

Unless otherwise stated the results shown in this test report refer only to the sample(s) tested and such sample(s) are retained for 90 days only.

除非另有說明，此報告結果僅對測試之樣品負責，同時此樣品僅保留90天。本報告未經本公司書面許可，不可部份複製。

This document is issued by the Company subject to its General Conditions of Service printed overleaf, available on request or accessible at <http://www.sgs.com.tw/Terms-and-Conditions> and for electronic format documents, subject to Terms and Conditions for Electronic Documents at <http://www.sgs.com.tw/Terms-and-Conditions>. Attention is drawn to the limitation of liability, indemnification and jurisdiction issues defined therein. Any holder of this document is advised that information contained hereon reflects the Company's findings at the time of its intervention only and within the limits of Client's instructions, if any. The Company's sole responsibility is to its Client and this document does not exonerate parties to a transaction from exercising all their rights and obligations under the transaction documents. This document cannot be reproduced except in full, without prior written approval of the Company. Any unauthorized alteration, forgery or falsification of the content or appearance of this document is unlawful and offenders may be prosecuted to the fullest extent of the law.

Report Number :ER-2020-40010
 Operation Mode :LTE B12
 Test Mode :Tx CH Low
 EUT Pol :H Plane
 Test Frequency :704.0 MHz

Test Date :2020-04-17
 Temp./Humi. :22.6/66
 Antenna Pol. :HORIZONTAL
 Engineer :Nick

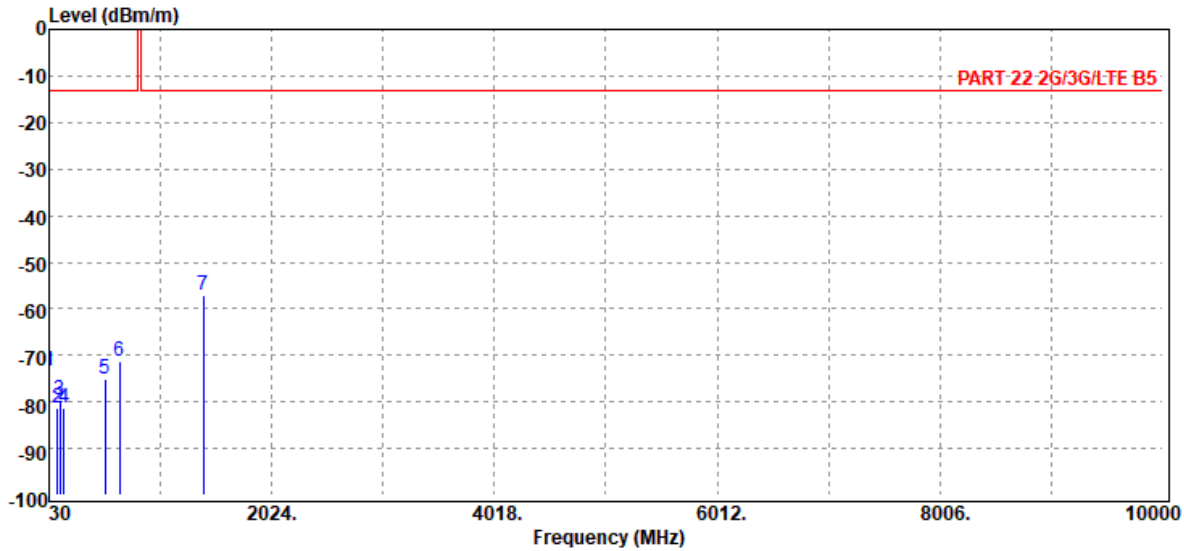

Freq. MHz	EIRP/ERP dBm	SG Output Level dBm	Antenna Gain dBi/dBd	Cable Loss dB	Limit dBm	Margin dB
30.00	-73.39	-45.57	-27.28	-0.54	-13.00	-60.39
105.66	-81.24	-72.01	-8.25	-0.98	-13.00	-68.24
125.06	-79.63	-71.32	-7.29	-1.02	-13.00	-66.63
160.95	-81.35	-76.45	-3.69	-1.21	-13.00	-68.35
534.40	-75.04	-72.22	-0.95	-1.87	-13.00	-62.04
659.53	-71.40	-68.38	-0.34	-2.68	-13.00	-58.40
1408.00	-57.10	-61.47	7.95	-3.58	-13.00	-44.10

Unless otherwise stated the results shown in this test report refer only to the sample(s) tested and such sample(s) are retained for 90 days only.

除非另有說明，此報告結果僅對測試之樣品負責，同時此樣品僅保留90天。本報告未經本公司書面許可，不可部份複製。

This document is issued by the Company subject to its General Conditions of Service printed overleaf, available on request or accessible at <http://www.sgs.com.tw/Terms-and-Conditions> and for electronic format documents, subject to Terms and Conditions for Electronic Documents at <http://www.sgs.com.tw/Terms-and-Conditions>. Attention is drawn to the limitation of liability, indemnification and jurisdiction issues defined therein. Any holder of this document is advised that information contained hereon reflects the Company's findings at the time of its intervention only and within the limits of Client's instructions, if any. The Company's sole responsibility is to its Client and this document does not exonerate parties to a transaction from exercising all their rights and obligations under the transaction documents. This document cannot be reproduced except in full, without prior written approval of the Company. Any unauthorized alteration, forgery or falsification of the content or appearance of this document is unlawful and offenders may be prosecuted to the fullest extent of the law.

Report Number :ER-2020-40010
 Operation Mode :LTE B12
 Test Mode :Tx CH Mid
 EUT Pol :H Plane
 Test Frequency :707.5 MHz

Test Date :2020-04-17
 Temp./Humi. :22.6/66
 Antenna Pol. :VERTICAL
 Engineer :Nick

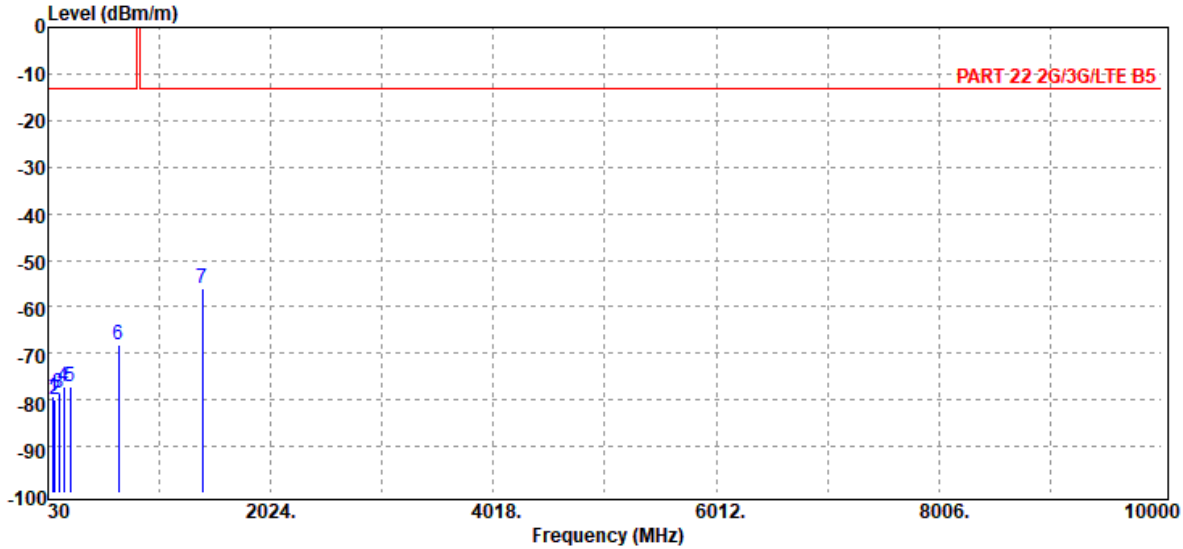

Freq. MHz	EIRP/ERP dBm	SG Output Level dBm	Antenna Gain dBi/dBd	Cable Loss dB	Limit dBm	Margin dB
73.65	-79.21	-71.67	-6.71	-0.83	-13.00	-66.21
90.14	-79.81	-71.67	-7.24	-0.90	-13.00	-66.81
128.94	-78.43	-70.32	-7.12	-0.99	-13.00	-65.43
170.65	-77.16	-73.31	-2.58	-1.27	-13.00	-64.16
231.76	-77.30	-74.39	-1.47	-1.44	-13.00	-64.30
659.53	-68.24	-65.22	-0.34	-2.68	-13.00	-55.24
1415.00	-56.16	-60.56	7.99	-3.59	-13.00	-43.16

Unless otherwise stated the results shown in this test report refer only to the sample(s) tested and such sample(s) are retained for 90 days only.
 除非另有說明，此報告結果僅對測試之樣品負責，同時此樣品僅保留90天。本報告未經本公司書面許可，不可部份複製。

This document is issued by the Company subject to its General Conditions of Service printed overleaf, available on request or accessible at <http://www.sgs.com.tw/Terms-and-Conditions> and for electronic format documents, subject to Terms and Conditions for Electronic Documents at <http://www.sgs.com.tw/Terms-and-Conditions>. Attention is drawn to the limitation of liability, indemnification and jurisdiction issues defined therein. Any holder of this document is advised that information contained hereon reflects the Company's findings at the time of its intervention only and within the limits of Client's instructions, if any. The Company's sole responsibility is to its Client and this document does not exonerate parties to a transaction from exercising all their rights and obligations under the transaction documents. This document cannot be reproduced except in full, without prior written approval of the Company. Any unauthorized alteration, forgery or falsification of the content or appearance of this document is unlawful and offenders may be prosecuted to the fullest extent of the law.

Report Number :ER-2020-40010
Operation Mode :LTE B12
Test Mode :Tx CH Mid
EUT Pol :H Plane
Test Frequency :707.5 MHz

Test Date :2020-04-17
Temp./Humi. :22.6/66
Antenna Pol. :HORIZONTAL
Engineer :Nick

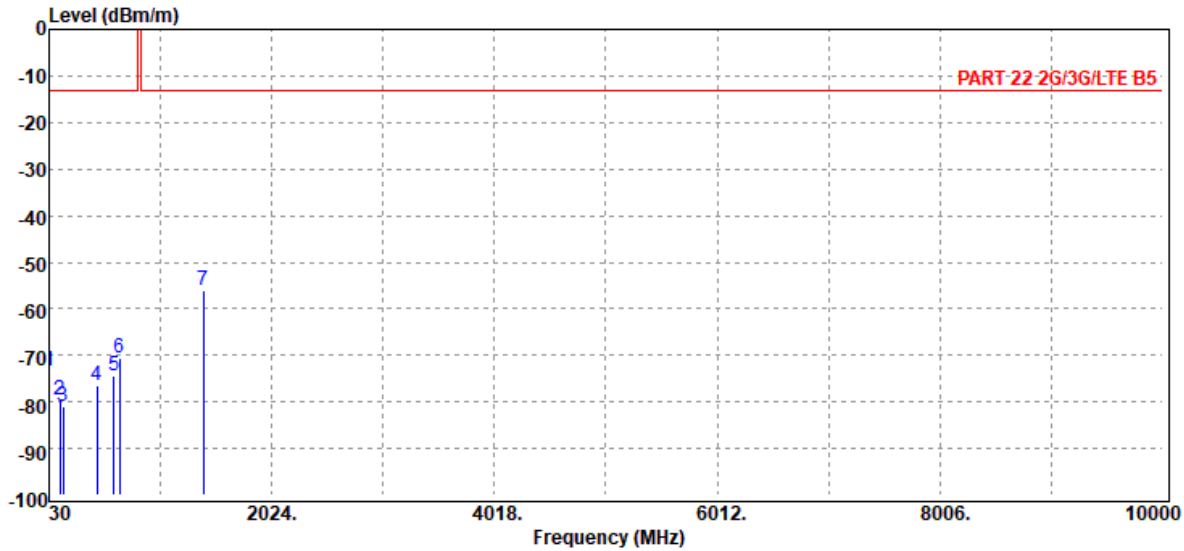

Freq. MHz	EIRP/ERP dBm	SG Output Level dBm	Antenna Gain dBi/dBd	Cable Loss dB	Limit dBm	Margin dB
30.00	-73.25	-45.43	-27.28	-0.54	-13.00	-60.25
127.00	-79.65	-71.39	-7.25	-1.01	-13.00	-66.65
156.10	-80.88	-75.43	-4.24	-1.21	-13.00	-67.88
461.65	-76.52	-73.48	-1.14	-1.90	-13.00	-63.52
609.09	-74.33	-71.71	-0.63	-1.99	-13.00	-61.33
658.56	-70.65	-67.64	-0.35	-2.66	-13.00	-57.65
1415.00	-56.17	-60.57	7.99	-3.59	-13.00	-43.17

Unless otherwise stated the results shown in this test report refer only to the sample(s) tested and such sample(s) are retained for 90 days only.

除非另有說明，此報告結果僅對測試之樣品負責，同時此樣品僅保留90天。本報告未經本公司書面許可，不可部份複製。

This document is issued by the Company subject to its General Conditions of Service printed overleaf, available on request or accessible at <http://www.sgs.com.tw/Terms-and-Conditions> and for electronic format documents, subject to Terms and Conditions for Electronic Documents at <http://www.sgs.com.tw/Terms-and-Conditions>. Attention is drawn to the limitation of liability, indemnification and jurisdiction issues defined therein. Any holder of this document is advised that information contained hereon reflects the Company's findings at the time of its intervention only and within the limits of Client's instructions, if any. The Company's sole responsibility is to its Client and this document does not exonerate parties to a transaction from exercising all their rights and obligations under the transaction documents. This document cannot be reproduced except in full, without prior written approval of the Company. Any unauthorized alteration, forgery or falsification of the content or appearance of this document is unlawful and offenders may be prosecuted to the fullest extent of the law.

Report Number :ER-2020-40010
 Operation Mode :LTE B12
 Test Mode :Tx CH High
 EUT Pol :H Plane
 Test Frequency :711.0 MHz

Test Date :2020-04-17
 Temp./Humi. :22.6/66
 Antenna Pol. :VERTICAL
 Engineer :Nick

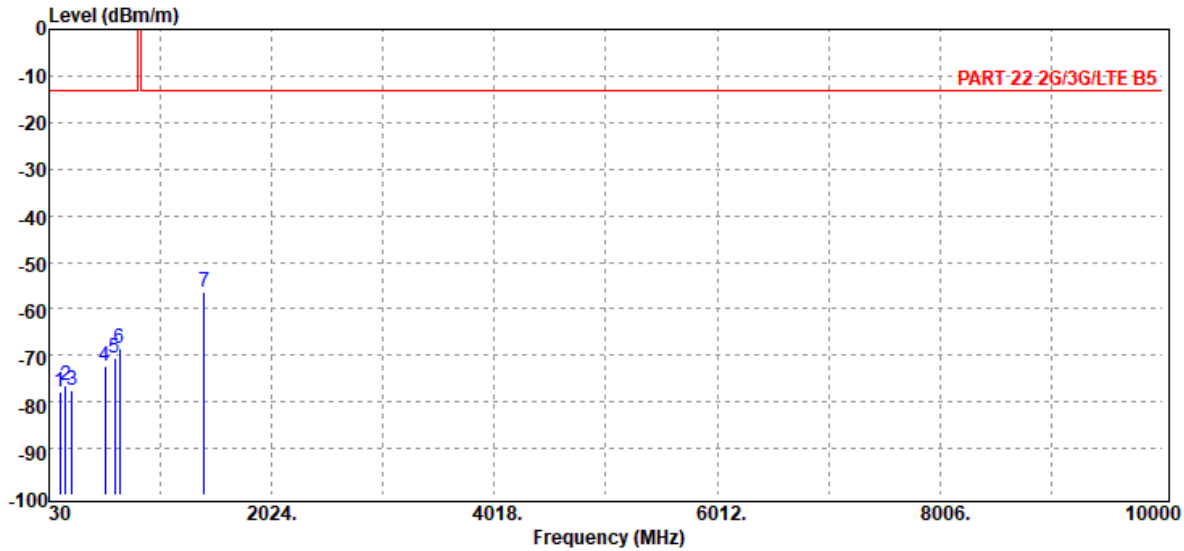

Freq. MHz	EIRP/ERP dBm	SG Output Level dBm	Antenna Gain dBi/dBd	Cable Loss dB	Limit dBm	Margin dB
128.94	-78.00	-69.89	-7.12	-0.99	-13.00	-65.00
175.50	-76.40	-73.12	-2.04	-1.24	-13.00	-63.40
233.70	-77.57	-74.57	-1.55	-1.45	-13.00	-64.57
531.49	-72.17	-69.45	-0.88	-1.84	-13.00	-59.17
618.79	-70.59	-67.88	-0.67	-2.04	-13.00	-57.59
659.53	-68.50	-65.48	-0.34	-2.68	-13.00	-55.50
1422.00	-56.57	-61.01	8.03	-3.59	-13.00	-43.57

Unless otherwise stated the results shown in this test report refer only to the sample(s) tested and such sample(s) are retained for 90 days only.

除非另有說明，此報告結果僅對測試之樣品負責，同時此樣品僅保留90天。本報告未經本公司書面許可，不可部份複製。

This document is issued by the Company subject to its General Conditions of Service printed overleaf, available on request or accessible at <http://www.sgs.com.tw/Terms-and-Conditions> and for electronic format documents, subject to Terms and Conditions for Electronic Documents at <http://www.sgs.com.tw/Terms-and-Conditions>. Attention is drawn to the limitation of liability, indemnification and jurisdiction issues defined therein. Any holder of this document is advised that information contained hereon reflects the Company's findings at the time of its intervention only and within the limits of Client's instructions, if any. The Company's sole responsibility is to its Client and this document does not exonerate parties to a transaction from exercising all their rights and obligations under the transaction documents. This document cannot be reproduced except in full, without prior written approval of the Company. Any unauthorized alteration, forgery or falsification of the content or appearance of this document is unlawful and offenders may be prosecuted to the fullest extent of the law.

Report Number :ER-2020-40010
 Operation Mode :LTE B12
 Test Mode :Tx CH High
 EUT Pol :H Plane
 Test Frequency :711.0 MHz

Test Date :2020-04-17
 Temp./Humi. :22.6/66
 Antenna Pol. :HORIZONTAL
 Engineer :Nick

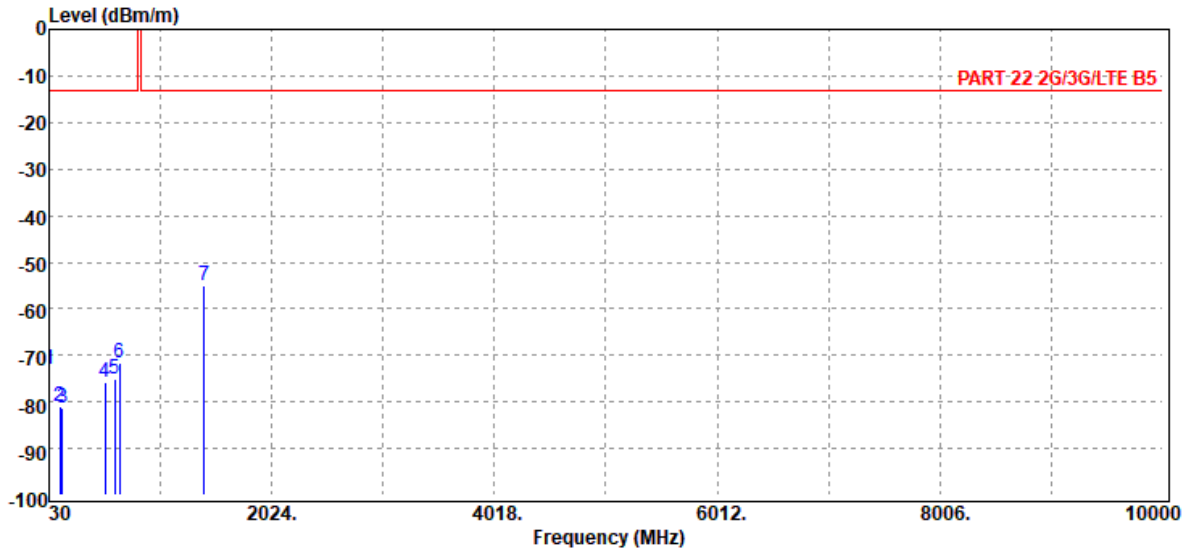

Freq. MHz	EIRP/ERP dBm	SG Output Level dBm	Antenna Gain dBi/dBd	Cable Loss dB	Limit dBm	Margin dB
30.00	-73.16	-45.34	-27.28	-0.54	-13.00	-60.16
125.06	-81.03	-72.72	-7.29	-1.02	-13.00	-68.03
149.31	-81.46	-75.41	-4.84	-1.21	-13.00	-68.46
529.55	-75.69	-73.01	-0.84	-1.84	-13.00	-62.69
614.91	-75.00	-72.34	-0.65	-2.01	-13.00	-62.00
659.53	-71.72	-68.70	-0.34	-2.68	-13.00	-58.72
1422.00	-55.03	-59.47	8.03	-3.59	-13.00	-42.03

Unless otherwise stated the results shown in this test report refer only to the sample(s) tested and such sample(s) are retained for 90 days only.
 除非另有說明，此報告結果僅對測試之樣品負責，同時此樣品僅保留90天。本報告未經本公司書面許可，不可部份複製。

This document is issued by the Company subject to its General Conditions of Service printed overleaf, available on request or accessible at <http://www.sgs.com.tw/Terms-and-Conditions> and for electronic format documents, subject to Terms and Conditions for Electronic Documents at <http://www.sgs.com.tw/Terms-and-Conditions>. Attention is drawn to the limitation of liability, indemnification and jurisdiction issues defined therein. Any holder of this document is advised that information contained hereon reflects the Company's findings at the time of its intervention only and within the limits of Client's instructions, if any. The Company's sole responsibility is to its Client and this document does not exonerate parties to a transaction from exercising all their rights and obligations under the transaction documents. This document cannot be reproduced except in full, without prior written approval of the Company. Any unauthorized alteration, forgery or falsification of the content or appearance of this document is unlawful and offenders may be prosecuted to the fullest extent of the law.

Report Number :ER-2020-40010
 Operation Mode :LTE B17
 Test Mode :Tx CH Low
 EUT Pol :H Plane
 Test Frequency :709.0 MHz

Test Date :2020-04-17
 Temp./Humi. :22.6/66
 Antenna Pol. :VERTICAL
 Engineer :Nick

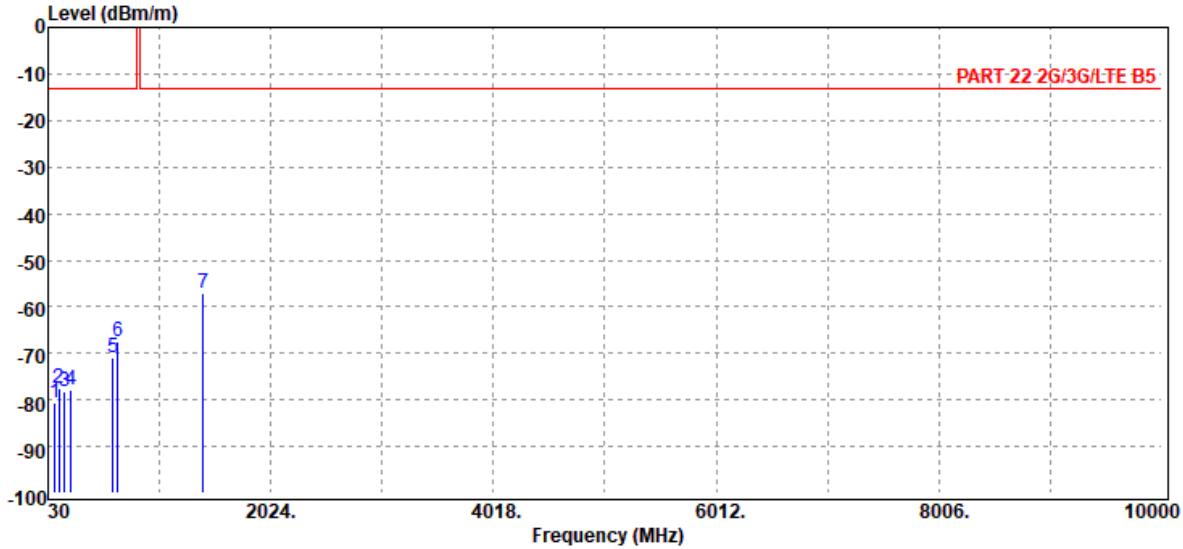

Freq. MHz	EIRP/ERP dBm	SG Output Level dBm	Antenna Gain dBi/dBd	Cable Loss dB	Limit dBm	Margin dB
91.11	-80.53	-72.35	-7.27	-0.91	-13.00	-67.53
128.94	-77.39	-69.28	-7.12	-0.99	-13.00	-64.39
175.50	-78.05	-74.77	-2.04	-1.24	-13.00	-65.05
238.55	-77.82	-74.59	-1.76	-1.47	-13.00	-64.82
613.94	-70.94	-68.30	-0.64	-2.00	-13.00	-57.94
655.65	-67.35	-64.36	-0.39	-2.60	-13.00	-54.35
1418.00	-56.99	-61.41	8.01	-3.59	-13.00	-43.99

Unless otherwise stated the results shown in this test report refer only to the sample(s) tested and such sample(s) are retained for 90 days only.
 除非另有說明，此報告結果僅對測試之樣品負責，同時此樣品僅保留90天。本報告未經本公司書面許可，不可部份複製。

This document is issued by the Company subject to its General Conditions of Service printed overleaf, available on request or accessible at <http://www.sgs.com.tw/Terms-and-Conditions> and for electronic format documents, subject to Terms and Conditions for Electronic Documents at <http://www.sgs.com.tw/Terms-and-Conditions>. Attention is drawn to the limitation of liability, indemnification and jurisdiction issues defined therein. Any holder of this document is advised that information contained hereon reflects the Company's findings at the time of its intervention only and within the limits of Client's instructions, if any. The Company's sole responsibility is to its Client and this document does not exonerate parties to a transaction from exercising all their rights and obligations under the transaction documents. This document cannot be reproduced except in full, without prior written approval of the Company. Any unauthorized alteration, forgery or falsification of the content or appearance of this document is unlawful and offenders may be prosecuted to the fullest extent of the law.

Report Number :ER-2020-40010
Operation Mode :LTE B17
Test Mode :Tx CH Low
EUT Pol :H Plane
Test Frequency :709.0 MHz

Test Date :2020-04-17
Temp./Humi. :22.6/66
Antenna Pol. :HORIZONTAL
Engineer :Nick

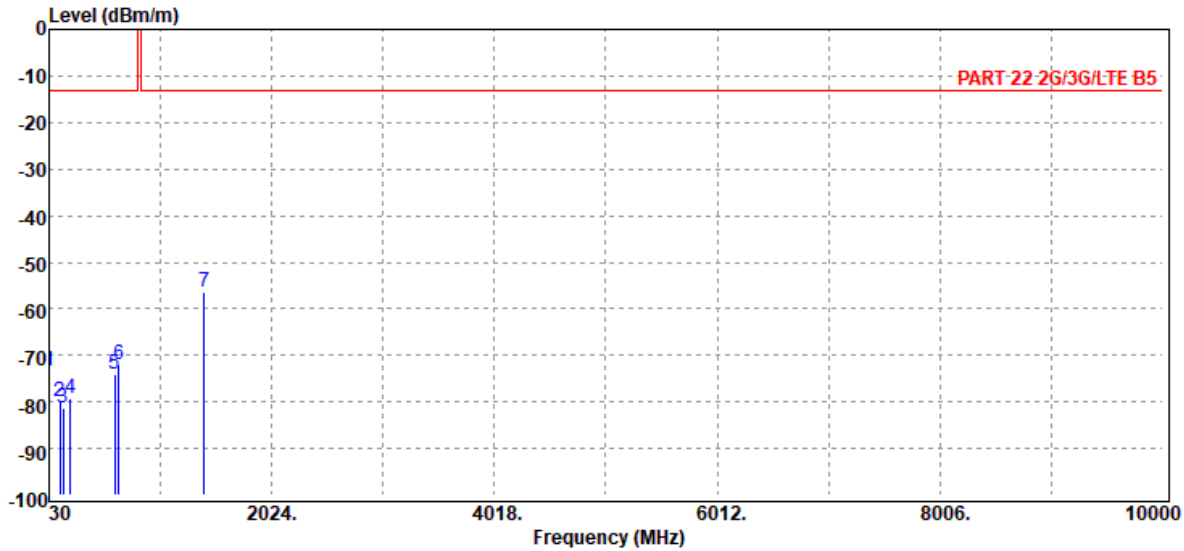

Freq. MHz	EIRP/ERP dBm	SG Output Level dBm	Antenna Gain dBi/dBd	Cable Loss dB	Limit dBm	Margin dB
30.00	-73.50	-45.68	-27.28	-0.54	-13.00	-60.50
125.06	-79.89	-71.58	-7.29	-1.02	-13.00	-66.89
154.16	-81.28	-75.69	-4.37	-1.22	-13.00	-68.28
219.15	-79.40	-77.06	-0.98	-1.36	-13.00	-66.40
614.91	-74.10	-71.44	-0.65	-2.01	-13.00	-61.10
655.65	-71.80	-68.81	-0.39	-2.60	-13.00	-58.80
1418.00	-56.43	-60.85	8.01	-3.59	-13.00	-43.43

Unless otherwise stated the results shown in this test report refer only to the sample(s) tested and such sample(s) are retained for 90 days only.
除非另有說明，此報告結果僅對測試之樣品負責，同時此樣品僅保留90天。本報告未經本公司書面許可，不可部份複製。

This document is issued by the Company subject to its General Conditions of Service printed overleaf, available on request or accessible at <http://www.sgs.com.tw/Terms-and-Conditions> and for electronic format documents, subject to Terms and Conditions for Electronic Documents at <http://www.sgs.com.tw/Terms-and-Conditions>. Attention is drawn to the limitation of liability, indemnification and jurisdiction issues defined therein. Any holder of this document is advised that information contained hereon reflects the Company's findings at the time of its intervention only and within the limits of Client's instructions, if any. The Company's sole responsibility is to its Client and this document does not exonerate parties to a transaction from exercising all their rights and obligations under the transaction documents. This document cannot be reproduced except in full, without prior written approval of the Company. Any unauthorized alteration, forgery or falsification of the content or appearance of this document is unlawful and offenders may be prosecuted to the fullest extent of the law.

Report Number :ER-2020-40010
 Operation Mode :LTE B17
 Test Mode :Tx CH Mid
 EUT Pol :H Plane
 Test Frequency :710.0 MHz

Test Date :2020-04-17
 Temp./Humi. :22.6/66
 Antenna Pol. :VERTICAL
 Engineer :Nick

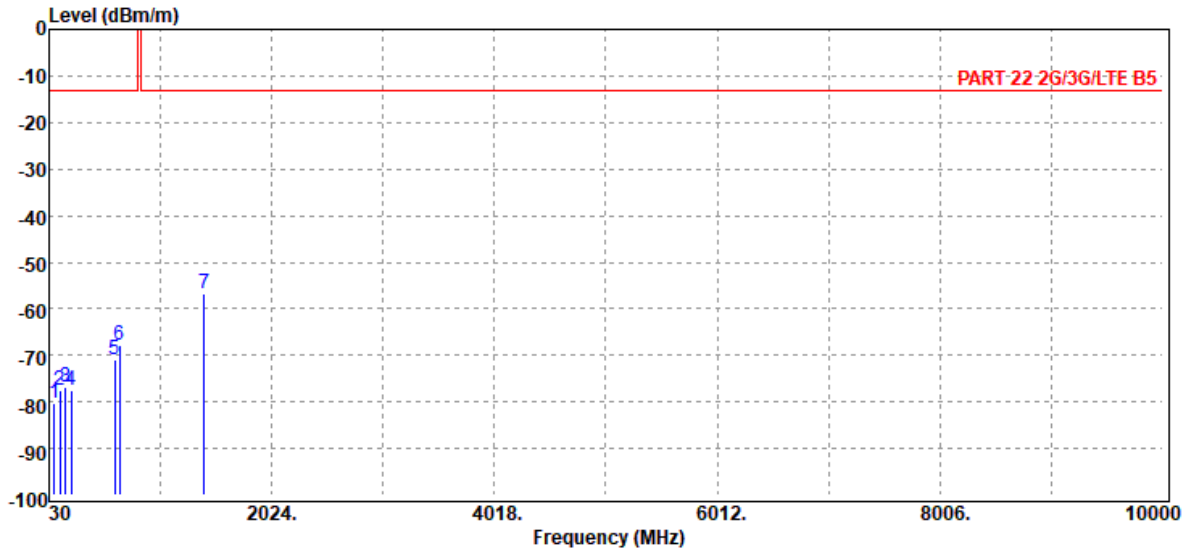

Freq. MHz	EIRP/ERP dBm	SG Output Level dBm	Antenna Gain dBi/dBd	Cable Loss dB	Limit dBm	Margin dB
76.56	-80.24	-72.80	-6.60	-0.84	-13.00	-67.24
128.94	-77.61	-69.50	-7.12	-0.99	-13.00	-64.61
178.41	-76.92	-73.89	-1.80	-1.23	-13.00	-63.92
230.79	-77.35	-74.49	-1.43	-1.43	-13.00	-64.35
619.76	-70.76	-68.03	-0.68	-2.05	-13.00	-57.76
658.56	-67.75	-64.74	-0.35	-2.66	-13.00	-54.75
1420.00	-56.74	-61.17	8.02	-3.59	-13.00	-43.74

Unless otherwise stated the results shown in this test report refer only to the sample(s) tested and such sample(s) are retained for 90 days only.
 除非另有說明，此報告結果僅對測試之樣品負責，同時此樣品僅保留90天。本報告未經本公司書面許可，不可部份複製。

This document is issued by the Company subject to its General Conditions of Service printed overleaf, available on request or accessible at <http://www.sgs.com.tw/Terms-and-Conditions> and for electronic format documents, subject to Terms and Conditions for Electronic Documents at <http://www.sgs.com.tw/Terms-and-Conditions>. Attention is drawn to the limitation of liability, indemnification and jurisdiction issues defined therein. Any holder of this document is advised that information contained hereon reflects the Company's findings at the time of its intervention only and within the limits of Client's instructions, if any. The Company's sole responsibility is to its Client and this document does not exonerate parties to a transaction from exercising all their rights and obligations under the transaction documents. This document cannot be reproduced except in full, without prior written approval of the Company. Any unauthorized alteration, forgery or falsification of the content or appearance of this document is unlawful and offenders may be prosecuted to the fullest extent of the law.

Report Number :ER-2020-40010
 Operation Mode :LTE B17
 Test Mode :Tx CH Mid
 EUT Pol :H Plane
 Test Frequency :710.0 MHz

Test Date :2020-04-17
 Temp./Humi. :22.6/66
 Antenna Pol. :HORIZONTAL
 Engineer :Nick

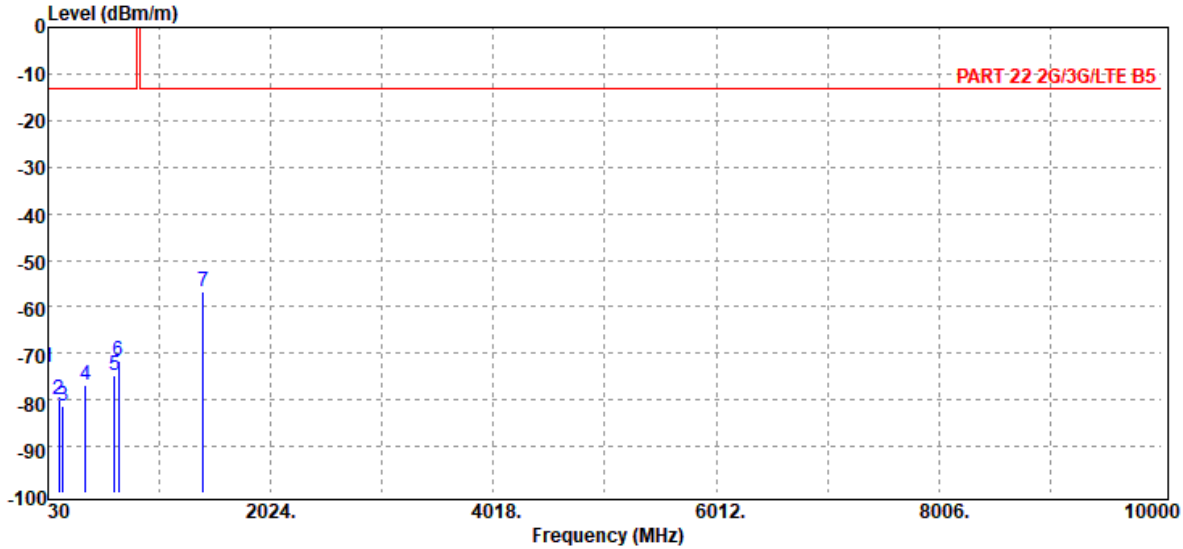

Freq. MHz	EIRP/ERP dBm	SG Output Level dBm	Antenna Gain dBi/dBd	Cable Loss dB	Limit dBm	Margin dB
31.94	-72.93	-46.42	-25.96	-0.55	-13.00	-59.93
128.94	-80.08	-71.97	-7.12	-0.99	-13.00	-67.08
162.89	-81.43	-76.72	-3.49	-1.22	-13.00	-68.43
366.59	-76.74	-73.50	-1.51	-1.73	-13.00	-63.74
624.61	-74.77	-72.07	-0.52	-2.18	-13.00	-61.77
659.53	-71.70	-68.68	-0.34	-2.68	-13.00	-58.70
1420.00	-56.70	-61.13	8.02	-3.59	-13.00	-43.70

Unless otherwise stated the results shown in this test report refer only to the sample(s) tested and such sample(s) are retained for 90 days only.
 除非另有說明，此報告結果僅對測試之樣品負責，同時此樣品僅保留90天。本報告未經本公司書面許可，不可部份複製。

This document is issued by the Company subject to its General Conditions of Service printed overleaf, available on request or accessible at <http://www.sgs.com.tw/Terms-and-Conditions> and for electronic format documents, subject to Terms and Conditions for Electronic Documents at <http://www.sgs.com.tw/Terms-and-Conditions>. Attention is drawn to the limitation of liability, indemnification and jurisdiction issues defined therein. Any holder of this document is advised that information contained hereon reflects the Company's findings at the time of its intervention only and within the limits of Client's instructions, if any. The Company's sole responsibility is to its Client and this document does not exonerate parties to a transaction from exercising all their rights and obligations under the transaction documents. This document cannot be reproduced except in full, without prior written approval of the Company. Any unauthorized alteration, forgery or falsification of the content or appearance of this document is unlawful and offenders may be prosecuted to the fullest extent of the law.

Report Number :ER-2020-40010
 Operation Mode :LTE B17
 Test Mode :Tx CH High
 EUT Pol :H Plane
 Test Frequency :711.0 MHz

Test Date :2020-04-17
 Temp./Humi. :22.6/66
 Antenna Pol. :VERTICAL
 Engineer :Nick

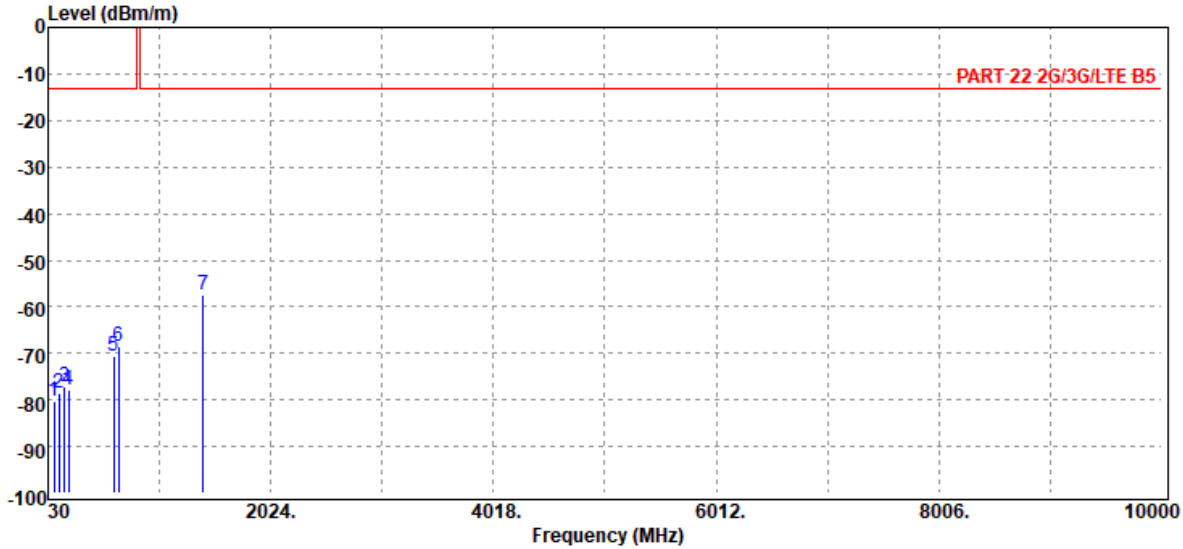

Freq. MHz	EIRP/ERP dBm	SG Output Level dBm	Antenna Gain dBi/dBd	Cable Loss dB	Limit dBm	Margin dB
83.35	-80.24	-72.89	-6.48	-0.87	-13.00	-67.24
128.94	-78.40	-70.29	-7.12	-0.99	-13.00	-65.40
177.44	-77.11	-73.97	-1.90	-1.24	-13.00	-64.11
216.24	-77.85	-75.50	-0.98	-1.37	-13.00	-64.85
618.79	-70.66	-67.95	-0.67	-2.04	-13.00	-57.66
660.50	-68.55	-65.52	-0.34	-2.69	-13.00	-55.55
1422.00	-57.31	-61.75	8.03	-3.59	-13.00	-44.31

Unless otherwise stated the results shown in this test report refer only to the sample(s) tested and such sample(s) are retained for 90 days only.
 除非另有說明，此報告結果僅對測試之樣品負責，同時此樣品僅保留90天。本報告未經本公司書面許可，不可部份複製。

This document is issued by the Company subject to its General Conditions of Service printed overleaf, available on request or accessible at <http://www.sgs.com.tw/Terms-and-Conditions> and for electronic format documents, subject to Terms and Conditions for Electronic Documents at <http://www.sgs.com.tw/Terms-and-Conditions>. Attention is drawn to the limitation of liability, indemnification and jurisdiction issues defined therein. Any holder of this document is advised that information contained hereon reflects the Company's findings at the time of its intervention only and within the limits of Client's instructions, if any. The Company's sole responsibility is to its Client and this document does not exonerate parties to a transaction from exercising all their rights and obligations under the transaction documents. This document cannot be reproduced except in full, without prior written approval of the Company. Any unauthorized alteration, forgery or falsification of the content or appearance of this document is unlawful and offenders may be prosecuted to the fullest extent of the law.

Report Number :ER-2020-40010
 Operation Mode :LTE B17
 Test Mode :Tx CH High
 EUT Pol :H Plane
 Test Frequency :711.0 MHz

Test Date :2020-04-17
 Temp./Humi. :22.6/66
 Antenna Pol. :HORIZONTAL
 Engineer :Nick

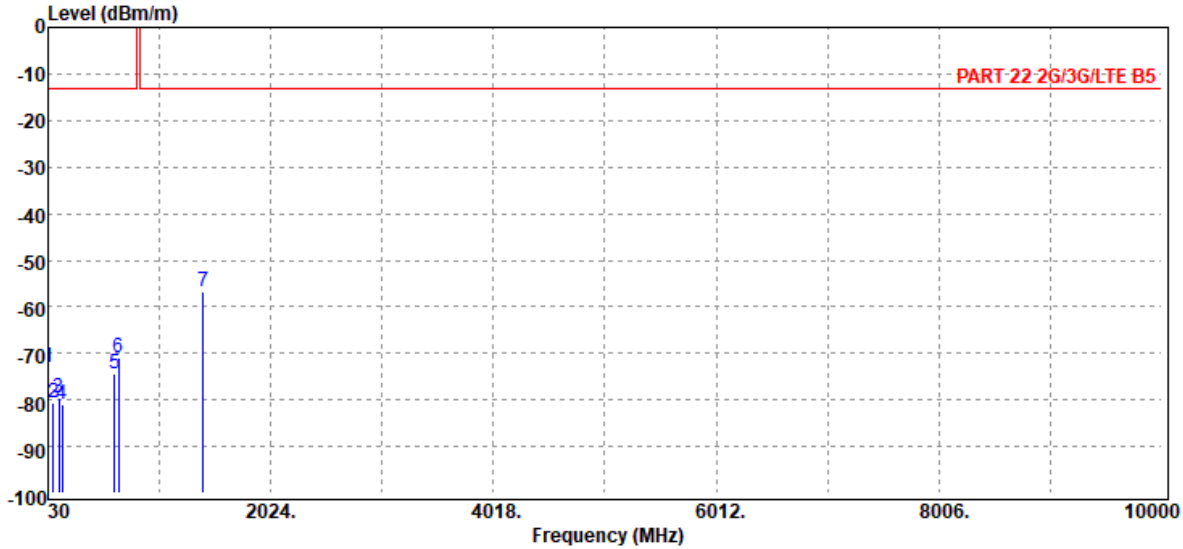

Freq. MHz	EIRP/ERP dBm	SG Output Level dBm	Antenna Gain dBi/dBd	Cable Loss dB	Limit dBm	Margin dB
30.00	-72.94	-45.12	-27.28	-0.54	-13.00	-59.94
73.65	-80.75	-73.21	-6.71	-0.83	-13.00	-67.75
128.94	-79.53	-71.42	-7.12	-0.99	-13.00	-66.53
153.19	-80.91	-75.19	-4.50	-1.22	-13.00	-67.91
626.55	-74.29	-71.54	-0.52	-2.23	-13.00	-61.29
660.50	-70.99	-67.96	-0.34	-2.69	-13.00	-57.99
1422.00	-56.64	-61.08	8.03	-3.59	-13.00	-43.64

Unless otherwise stated the results shown in this test report refer only to the sample(s) tested and such sample(s) are retained for 90 days only.
 除非另有說明，此報告結果僅對測試之樣品負責，同時此樣品僅保留90天。本報告未經本公司書面許可，不可部份複製。

This document is issued by the Company subject to its General Conditions of Service printed overleaf, available on request or accessible at <http://www.sgs.com.tw/Terms-and-Conditions> and for electronic format documents, subject to Terms and Conditions for Electronic Documents at <http://www.sgs.com.tw/Terms-and-Conditions>. Attention is drawn to the limitation of liability, indemnification and jurisdiction issues defined therein. Any holder of this document is advised that information contained hereon reflects the Company's findings at the time of its intervention only and within the limits of Client's instructions, if any. The Company's sole responsibility is to its Client and this document does not exonerate parties to a transaction from exercising all their rights and obligations under the transaction documents. This document cannot be reproduced except in full, without prior written approval of the Company. Any unauthorized alteration, forgery or falsification of the content or appearance of this document is unlawful and offenders may be prosecuted to the fullest extent of the law.

10 FREQUENCY STABILITY MEASUREMENT

10.1 Standard Applicabl

The frequency stability shall be sufficient to ensure that the fundamental emission stays within the authorized frequency block.

10.2 Test Set-up

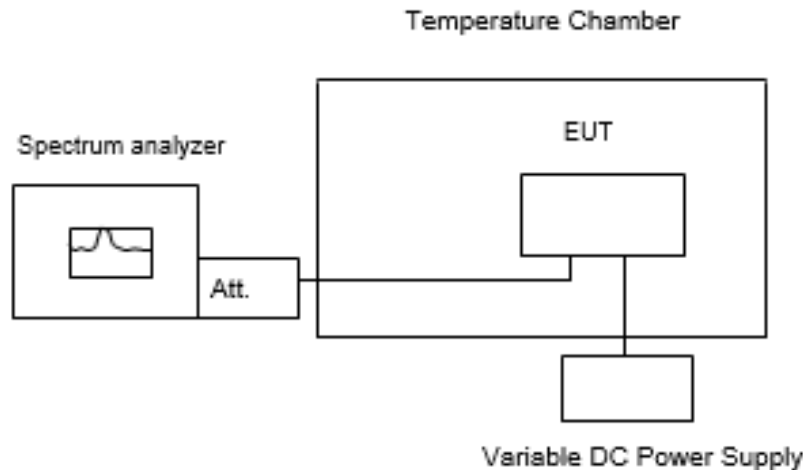

Note: Measurement setup for testing on Antenna connector

10.3 Measurement Procedure

The equipment under test was connected to an external AC or DC power supply and input rated voltage. RF output was connected to a frequency counter or spectrum analyzer via feed through attenuators. The EUT was placed inside the temperature chamber. Set the spectrum analyzer RBW low enough to obtain the desired frequency resolution and measure EUT 25°C operating frequency as reference frequency. Turn EUT off and set the chamber temperature to -30°C. After the temperature stabilized for approximately 30 minutes recorded the frequency. Repeat step measure with 10°C increased per stage until the highest temperature of +50°C reached.

Set chamber temperature to 25°C. Use a variable AC power supply / DC power source to power the EUT and set the voltage to rated voltage. Set the spectrum analyzer RBW low enough to obtain the desired frequency resolution and recorded the frequency.

Reduce the input voltage to specify extreme voltage variation (+/- 15%) and endpoint as declared by the manufacturer, record the maximum frequency change.

Unless otherwise stated the results shown in this test report refer only to the sample(s) tested and such sample(s) are retained for 90 days only.
除非另有說明，此報告結果僅對測試之樣品負責，同時此樣品僅保留90天。本報告未經本公司書面許可，不可部份複製。

This document is issued by the Company subject to its General Conditions of Service printed overleaf, available on request or accessible at <http://www.sgs.com.tw/Terms-and-Conditions> and for electronic format documents, subject to Terms and Conditions for Electronic Documents at <http://www.sgs.com.tw/Terms-and-Conditions>. Attention is drawn to the limitation of liability, indemnification and jurisdiction issues defined therein. Any holder of this document is advised that information contained hereon reflects the Company's findings at the time of its intervention only and within the limits of Client's instructions, if any. The Company's sole responsibility is to its Client and this document does not exonerate parties to a transaction from exercising all their rights and obligations under the transaction documents. This document cannot be reproduced except in full, without prior written approval of the Company. Any unauthorized alteration, forgery or falsification of the content or appearance of this document is unlawful and offenders may be prosecuted to the fullest extent of the law.

10.4 Measurement Equipment Used

Conducted Emission (measured at antenna port) Test Site					
EQUIPMENT TYPE	MFR	MODEL NUMBER	SERIAL NUMBER	LAST CAL.	CAL DUE.
EXA Spectrum Analyzer	KEYSIGHT	N9010A	MY54200716	Apr. 1st, 2020	Mar. 31st, 2021
Radio Communication Analyzer	Anritsu	MT8820C	6200995019	Apr. 1st, 2020	Mar. 31st, 2021
DC Power Supply	Agilent	E3640A	MY40000811	Dec. 23th, 2019	Dec. 22nd, 2020
Radio Communication Analyzer	Anritsu	MT8815B	6200711454	Apr. 1st, 2020	Mar. 31st, 2021
Attenuator	Mini-Circuit	BW-S10W2 +	2	Jan. 2nd, 2020	Jan. 1st, 2021
Splitter	RF-LAMBAD	RFLT2W1G18G	11-JSPF412-018	Jan. 2nd, 2020	Jan. 1st, 2021
Coaxial Cable	Huber Suhner	SUCOFLEX 102EPA	MY2616/2	Jan. 2nd, 2020	Jan. 1st, 2021

10.5 Measurement Result

Note: The battery is rated 3.8Vdc.

GPRS 850 Mid Channel 836.6 MHz				
Limit: +/- 2.5 ppm				
Vdc	Temp. (°C)	Freq. (MHz)	Delta (Hz)	Limit (Hz)
FREQUENCY ERROR vs. VOLTAGE				
4.29	20	836.600005	5	2091
3.8	20	836.599992	-8	2091
3.51	20	836.600011	11	2091
2.8 (End point)	20	836.600002	2	2091
FREQUENCY ERROR vs. Temp.				
3.8	50	836.599985	-15	2091
3.8	40	836.599998	-2	2091
3.8	30	836.599993	-7	2091
3.8	20	836.599999	-1	2091
3.8	10	836.600017	17	2091
3.8	0	836.600005	5	2091
3.8	-10	836.599996	-4	2091
3.8	-20	836.600009	9	2091
3.8	-30	836.599995	-5	2091

Unless otherwise stated the results shown in this test report refer only to the sample(s) tested and such sample(s) are retained for 90 days only.

除非另有說明，此報告結果僅對測試之樣品負責，同時此樣品僅保留90天。本報告未經本公司書面許可，不可部份複製。

This document is issued by the Company subject to its General Conditions of Service printed overleaf, available on request or accessible at <http://www.sgs.com.tw/Terms-and-Conditions> and for electronic format documents, subject to Terms and Conditions for Electronic Documents at <http://www.sgs.com.tw/Terms-and-Conditions>. Attention is drawn to the limitation of liability, indemnification and jurisdiction issues defined therein. Any holder of this document is advised that information contained hereon reflects the Company's findings at the time of its intervention only and within the limits of Client's instructions, if any. The Company's sole responsibility is to its Client and this document does not exonerate parties to a transaction from exercising all their rights and obligations under the transaction documents. This document cannot be reproduced except in full, without prior written approval of the Company. Any unauthorized alteration, forgery or falsification of the content or appearance of this document is unlawful and offenders may be prosecuted to the fullest extent of the law.

GPRS 1900 Mid Channel		1880	MHz	
Limit: +/- 2.5 ppm				
Vdc	Temp. (°C)	Freq. (MHz)	Delta (Hz)	Limit (Hz)
FREQUENCY ERROR vs. VOLTAGE				
4.29	20	1880.000003	3	4700
3.8	20	1880.000009	9	4700
3.51	20	1880.000015	15	4700
2.8 (End point)	20	1879.999986	-14	4700
FREQUENCY ERROR vs. Temp.				
3.8	50	1879.999992	-8	4700
3.8	40	1880.000017	17	4700
3.8	30	1879.999999	-1	4700
3.8	20	1880.000007	7	4700
3.8	10	1879.999995	-5	4700
3.8	0	1880.000012	12	4700
3.8	-10	1879.999994	-6	4700
3.8	-20	1879.999992	-8	4700
3.8	-30	1880.000003	3	4700

WCDMA V Mid Channel		836.6	MHz	
Limit: +/- 2.5 ppm				
Vdc	Temp. (°C)	Freq. (MHz)	Delta (Hz)	Limit (Hz)
FREQUENCY ERROR vs. VOLTAGE				
4.29	20	836.599999	-1	2091
3.8	20	836.600003	3	2091
3.51	20	836.599992	-8	2091
2.8 (End point)	20	836.600011	11	2091
FREQUENCY ERROR vs. Temp.				
3.8	50	836.599995	-5	2091
3.8	40	836.599991	-9	2091
3.8	30	836.599993	-7	2091
3.8	20	836.600004	4	2091
3.8	10	836.599984	-16	2091
3.8	0	836.600005	5	2091
3.8	-10	836.600008	8	2091
3.8	-20	836.600003	3	2091
3.8	-30	836.599994	-6	2091

Unless otherwise stated the results shown in this test report refer only to the sample(s) tested and such sample(s) are retained for 90 days only.
 除非另有說明，此報告結果僅對測試之樣品負責，同時此樣品僅保留90天。本報告未經本公司書面許可，不可部份複製。

This document is issued by the Company subject to its General Conditions of Service printed overleaf, available on request or accessible at <http://www.sgs.com.tw/Terms-and-Conditions> and for electronic format documents, subject to Terms and Conditions for Electronic Documents at <http://www.sgs.com.tw/Terms-and-Conditions>. Attention is drawn to the limitation of liability, indemnification and jurisdiction issues defined therein. Any holder of this document is advised that information contained hereon reflects the Company's findings at the time of its intervention only and within the limits of Client's instructions, if any. The Company's sole responsibility is to its Client and this document does not exonerate parties to a transaction from exercising all their rights and obligations under the transaction documents. This document cannot be reproduced except in full, without prior written approval of the Company. Any unauthorized alteration, forgery or falsification of the content or appearance of this document is unlawful and offenders may be prosecuted to the fullest extent of the law.

Reference Freq.:		LTE B5 Mid Channel		836.5	MHz 10M QPSK CH 20525
Power Supply Vdc	Temp. (°C)	Freq. (MHz)	Delta (Hz)	Limit = +/- 2.5 ppm (Hz)	
Freq. ERROR vs. VOLTAGE					
4.29	25	836.500011	11	2091	
3.8	25	836.499994	-6	2091	
3.51	25	836.500013	13	2091	
2.8 (End Point)	25	836.499990	-10	2091	
Freq. ERROR vs. Temp.					
3.8	-30	836.500004	4	2091	
3.8	-20	836.499992	-8	2091	
3.8	-10	836.499987	-13	2091	
3.8	0	836.500005	5	2091	
3.8	10	836.499988	-12	2091	
3.8	20	836.500017	17	2091	
3.8	30	836.500006	6	2091	
3.8	40	836.500002	2	2091	
3.8	50	836.500007	7	2091	

Reference Freq.:		LTE B12 Mid Channel		707.5	MHz 10M QPSK CH 23095
Power Supply Vdc	Temp. (°C)	Freq. (MHz)	Delta (Hz)	Limit = +/- 2.5 ppm (Hz)	
Freq. ERROR vs. VOLTAGE					
4.29	25	707.499994	-6	1769	
3.8	25	707.499999	-1	1769	
3.51	25	707.500009	9	1769	
2.8 (End Point)	25	707.500015	15	1769	
Freq. ERROR vs. Temp.					
3.8	-30	707.500001	1	1769	
3.8	-20	707.500008	8	1769	
3.8	-10	707.500017	17	1769	
3.8	0	707.499982	-18	1769	
3.8	10	707.499999	-1	1769	
3.8	20	707.499991	-9	1769	
3.8	30	707.499995	-5	1769	
3.8	40	707.500003	3	1769	
3.8	50	707.500007	7	1769	

Unless otherwise stated the results shown in this test report refer only to the sample(s) tested and such sample(s) are retained for 90 days only.
除非另有說明，此報告結果僅對測試之樣品負責，同時此樣品僅保留90天。本報告未經本公司書面許可，不可部份複製。

This document is issued by the Company subject to its General Conditions of Service printed overleaf, available on request or accessible at <http://www.sgs.com.tw/Terms-and-Conditions> and for electronic format documents, subject to Terms and Conditions for Electronic Documents at <http://www.sgs.com.tw/Terms-and-Conditions>. Attention is drawn to the limitation of liability, indemnification and jurisdiction issues defined therein. Any holder of this document is advised that information contained hereon reflects the Company's findings at the time of its intervention only and within the limits of Client's instructions, if any. The Company's sole responsibility is to its Client and this document does not exonerate parties to a transaction from exercising all their rights and obligations under the transaction documents. This document cannot be reproduced except in full, without prior written approval of the Company. Any unauthorized alteration, forgery or falsification of the content or appearance of this document is unlawful and offenders may be prosecuted to the fullest extent of the law.

Reference Freq.:		LTE B17 Mid Channel		710	MHz 10M QPSK CH 23790
Power Supply Vdc	Temp. (°C)	Freq. (MHz)	Delta (Hz)	Limit = +/- 2.5 ppm (Hz)	
Freq. ERROR vs. VOLTAGE					
4.29	25	710.000002	2	1775	
3.8	25	709.999992	-8	1775	
3.51	25	710.000009	9	1775	
2.8 (End Point)	25	709.999989	-11	1775	
Freq. ERROR vs. Temp.					
3.8	-30	709.999994	-6	1775	
3.8	-20	710.000002	2	1775	
3.8	-10	710.000009	9	1775	
3.8	0	709.999993	-7	1775	
3.8	10	709.999989	-11	1775	
3.8	20	709.999984	-16	1775	
3.8	30	710.000001	1	1775	
3.8	40	710.000006	6	1775	
3.8	50	709.999991	-9	1775	

Unless otherwise stated the results shown in this test report refer only to the sample(s) tested and such sample(s) are retained for 90 days only.

除非另有說明，此報告結果僅對測試之樣品負責，同時此樣品僅保留90天。本報告未經本公司書面許可，不可部份複製。

This document is issued by the Company subject to its General Conditions of Service printed overleaf, available on request or accessible at <http://www.sgs.com.tw/Terms-and-Conditions> and for electronic format documents, subject to Terms and Conditions for Electronic Documents at <http://www.sgs.com.tw/Terms-and-Conditions>. Attention is drawn to the limitation of liability, indemnification and jurisdiction issues defined therein. Any holder of this document is advised that information contained hereon reflects the Company's findings at the time of its intervention only and within the limits of Client's instructions, if any. The Company's sole responsibility is to its Client and this document does not exonerate parties to a transaction from exercising all their rights and obligations under the transaction documents. This document cannot be reproduced except in full, without prior written approval of the Company. Any unauthorized alteration, forgery or falsification of the content or appearance of this document is unlawful and offenders may be prosecuted to the fullest extent of the law.

11 PEAK TO AVERAGE RATIO

11.1 Standard Applicable

The peak-to-average ratio (PAR) of the transmission may not exceed 13dB.

11.2 Test SET-UP

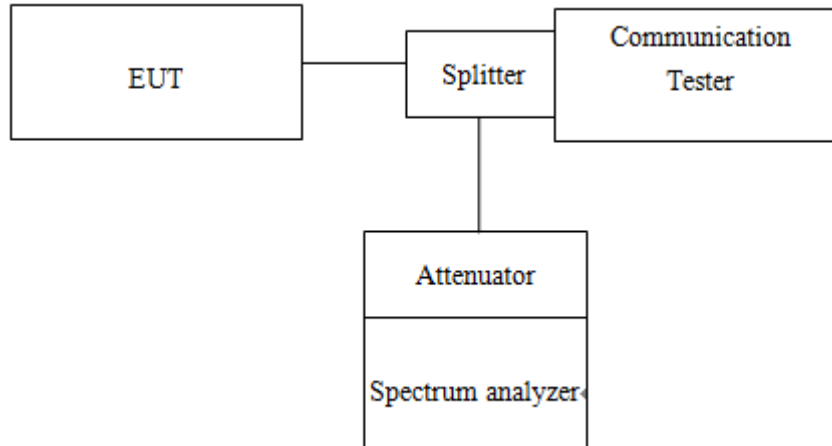

11.3 Measurement Procedure

1. KDB 971168 D01 is employed as the following procedure is proper adjusted accordingly:
2. Set resolution/measurement bandwidth \geq signal's occupied bandwidth; & internal =1ms
3. Set the number of counts to a value that stabilizes the measured CCDF curve.

11.4 Measurement Equipment Used

Conducted Emission (measured at antenna port) Test Site					
EQUIPMENT TYPE	MFR	MODEL NUMBER	SERIAL NUMBER	LAST CAL.	CAL DUE.
EXA Spectrum Analyzer	KEYSIGHT	N9010A	MY54200716	Apr. 1st, 2020	Mar. 31st, 2021
Radio Communication Analyer	Anritsu	MT8820C	6200995019	Apr. 1st, 2020	Mar. 31st, 2021
DC Power Supply	Agilent	E3640A	MY40000811	Dec. 23th, 2019	Dec. 22nd, 2020
Radio Communication Analyer	Anritsu	MT8815B	6200711454	Apr. 1st, 2020	Mar. 31st, 2021
Attenuator	Mini-Circuit	BW-S10W2 +	2	Jan. 2nd, 2020	Jan. 1st, 2021
Splitter	RF-LAMBAD	RFLT2W1G 18G	11-JSPF412-018	Jan. 2nd, 2020	Jan. 1st, 2021
Coaxial Cable	Huber Suhner	SUCOFLEX 102EPA	MY2616/2	Jan. 2nd, 2020	Jan. 1st, 2021

Unless otherwise stated the results shown in this test report refer only to the sample(s) tested and such sample(s) are retained for 90 days only.

除非另有說明，此報告結果僅對測試之樣品負責，同時此樣品僅保留90天。本報告未經本公司書面許可，不可部份複製。

This document is issued by the Company subject to its General Conditions of Service printed overleaf, available on request or accessible at <http://www.sgs.com.tw/Terms-and-Conditions> and for electronic format documents, subject to Terms and Conditions for Electronic Documents at <http://www.sgs.com.tw/Terms-and-Conditions>. Attention is drawn to the limitation of liability, indemnification and jurisdiction issues defined therein. Any holder of this document is advised that information contained hereon reflects the Company's findings at the time of its intervention only and within the limits of Client's instructions, if any. The Company's sole responsibility is to its Client and this document does not exonerate parties to a transaction from exercising all their rights and obligations under the transaction documents. This document cannot be reproduced except in full, without prior written approval of the Company. Any unauthorized alteration, forgery or falsification of the content or appearance of this document is unlawful and offenders may be prosecuted to the fullest extent of the law.

11.5 Measurement Result

Freq. (MHz)	CH	Peak-to-Average	
		GSM 850	GPRS 850
824.2	128	10.38	10.34
836.6	190	9.64	10.12
848.8	251	9.92	10.4
Freq. (MHz)	CH	Peak-to-Average	
		GSM 1900	GPRS 1900
1850.2	512	10.6	10.45
1880	661	8.46	10.41
1909.8	810	10.5	9.56

Freq. (MHz)	CH	Peak-to-Average Ratio (dB)		
		WCDMA V	HSDPA V	HSUPA V
826.4	4132	3.05	3.99	3.97
836.6	4183	2.92	3.59	3.86
846.6	4233	3.09	3.82	3.95

LTE BAND 5							
Channel bandwidth: 1.4MHz				Channel bandwidth: 3MHz			
Freq. (MHz)	CH	PAPR (dB)		Freq. (MHz)	CH	PAPR (dB)	
		16QAM	Limit			16QAM	Limit
824.7	20407	5.99	13	825.5	20415	6.14	13
836.5	20525	6.19	13	836.5	20525	6.25	13
848.3	20643	6.27	13	847.5	20635	6.26	13

LTE BAND 5							
Channel bandwidth: 5MHz				Channel bandwidth: 10MHz			
Freq. (MHz)	CH	PAPR (dB)		Freq. (MHz)	CH	PAPR (dB)	
		16QAM	Limit			16QAM	Limit
826.5	20425	5.99	13	829.0	20450	6.17	13
836.5	20525	6.13	13	836.5	20525	6.15	13
846.5	20625	6.19	13	844.0	20600	6.03	13

Unless otherwise stated the results shown in this test report refer only to the sample(s) tested and such sample(s) are retained for 90 days only.
 除非另有說明，此報告結果僅對測試之樣品負責，同時此樣品僅保留90天。本報告未經本公司書面許可，不可部份複製。

This document is issued by the Company subject to its General Conditions of Service printed overleaf, available on request or accessible at <http://www.sgs.com.tw/Terms-and-Conditions> and for electronic format documents, subject to Terms and Conditions for Electronic Documents at <http://www.sgs.com.tw/Terms-and-Conditions>. Attention is drawn to the limitation of liability, indemnification and jurisdiction issues defined therein. Any holder of this document is advised that information contained hereon reflects the Company's findings at the time of its intervention only and within the limits of Client's instructions, if any. The Company's sole responsibility is to its Client and this document does not exonerate parties to a transaction from exercising all their rights and obligations under the transaction documents. This document cannot be reproduced except in full, without prior written approval of the Company. Any unauthorized alteration, forgery or falsification of the content or appearance of this document is unlawful and offenders may be prosecuted to the fullest extent of the law.

LTE BAND 12							
Channel bandwidth: 1.4MHz				Channel bandwidth: 3MHz			
Freq. (MHz)	CH	PAPR (dB)		Freq. (MHz)	CH	PAPR (dB)	
		16QAM	Limit			16QAM	Limit
699.7	23017	6.45	13	700.5	23025	6.29	13
707.5	23095	6.29	13	707.5	23095	6.41	13
715.3	23173	6.22	13	714.5	23165	6.30	13

LTE BAND 12							
Channel bandwidth: 5MHz				Channel bandwidth: 10MHz			
Freq. (MHz)	CH	PAPR (dB)		Freq. (MHz)	CH	PAPR (dB)	
		16QAM	Limit			16QAM	Limit
701.5	23035	6.13	13	704.0	23060	6.30	13
707.5	23095	6.28	13	707.5	23095	6.32	13
713.5	23155	6.13	13	711.0	23130	6.15	13

LTE BAND 17							
Channel bandwidth: 1.4MHz				Channel bandwidth: 3MHz			
Freq. (MHz)	CH	PAPR (dB)		Freq. (MHz)	CH	PAPR (dB)	
		16QAM	Limit			16QAM	Limit
706.5	23755	6.71	13	709.0	23780	6.13	13
710.0	23790	6.19	13	710.0	23790	6.20	13
713.5	23825	6.25	13	711.0	23800	6.15	13

Unless otherwise stated the results shown in this test report refer only to the sample(s) tested and such sample(s) are retained for 90 days only.

除非另有說明，此報告結果僅對測試之樣品負責，同時此樣品僅保留90天。本報告未經本公司書面許可，不可部份複製。

This document is issued by the Company subject to its General Conditions of Service printed overleaf, available on request or accessible at <http://www.sgs.com.tw/Terms-and-Conditions> and for electronic format documents, subject to Terms and Conditions for Electronic Documents at <http://www.sgs.com.tw/Terms-and-Conditions>. Attention is drawn to the limitation of liability, indemnification and jurisdiction issues defined therein. Any holder of this document is advised that information contained hereon reflects the Company's findings at the time of its intervention only and within the limits of Client's instructions, if any. The Company's sole responsibility is to its Client and this document does not exonerate parties to a transaction from exercising all their rights and obligations under the transaction documents. This document cannot be reproduced except in full, without prior written approval of the Company. Any unauthorized alteration, forgery or falsification of the content or appearance of this document is unlawful and offenders may be prosecuted to the fullest extent of the law.

GSM 850MHz LowCH128-824.2

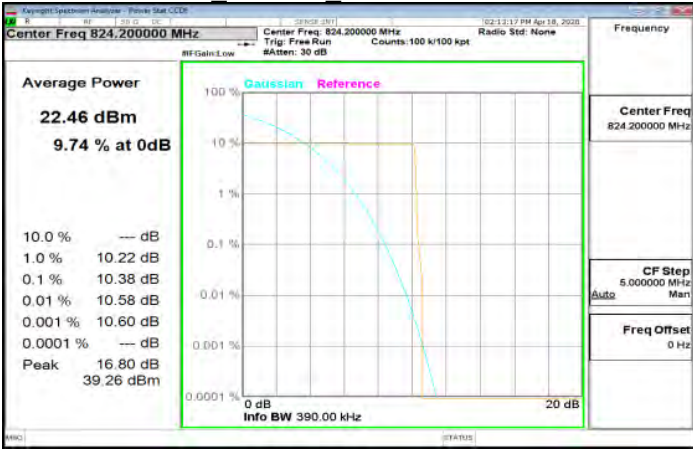

GPRS 850MHz LowCH128-824.2

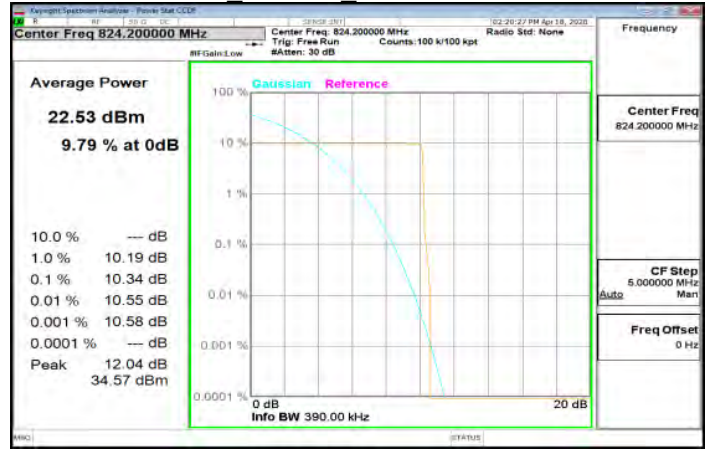

GSM 850MHz MidCH190-836.6



GPRS 850MHz MidCH190-836.6

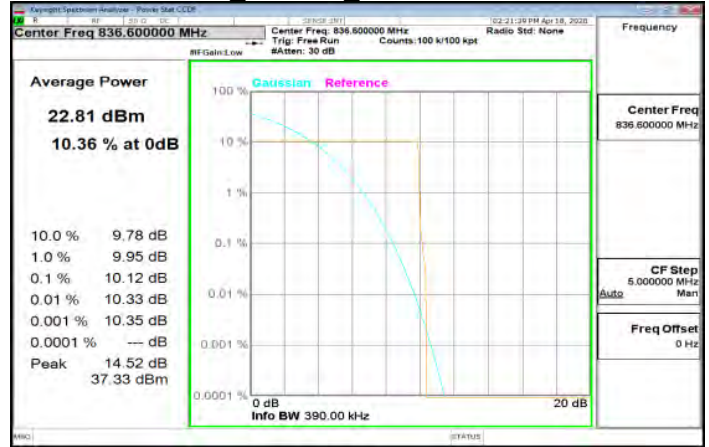

GSM 850MHz HighCH251-848.8



GPRS 850MHz HighCH251-848.8



Unless otherwise stated the results shown in this test report refer only to the sample(s) tested and such sample(s) are retained for 90 days only.
除非另有說明，此報告結果僅對測試之樣品負責，同時此樣品僅保留90天。本報告未經本公司書面許可，不可部份複製。

This document is issued by the Company subject to its General Conditions of Service printed overleaf, available on request or accessible at <http://www.sgs.com.tw/Terms-and-Conditions> and for electronic format documents, subject to Terms and Conditions for Electronic Documents at <http://www.sgs.com.tw/Terms-and-Conditions>. Attention is drawn to the limitation of liability, indemnification and jurisdiction issues defined therein. Any holder of this document is advised that information contained hereon reflects the Company's findings at the time of its intervention only and within the limits of Client's instructions, if any. The Company's sole responsibility is to its Client and this document does not exonerate parties to a transaction from exercising all their rights and obligations under the transaction documents. This document cannot be reproduced except in full, without prior written approval of the Company. Any unauthorized alteration, forgery or falsification of the content or appearance of this document is unlawful and offenders may be prosecuted to the fullest extent of the law.

GSM 1900MHz LowCH512-1850.2

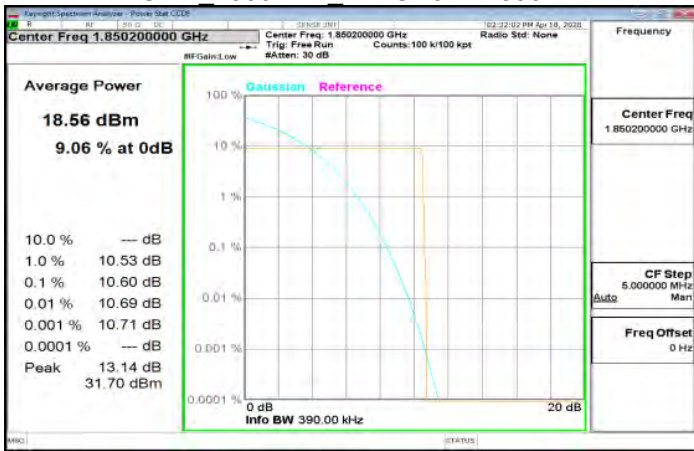

GPRS 1900MHz LowCH512-1850.2

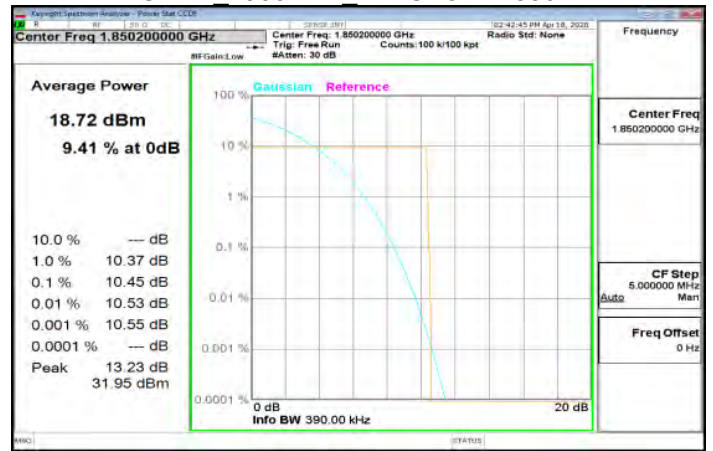

GSM 1900MHz MidCH661-1880



GPRS 1900MHz MidCH661-1880

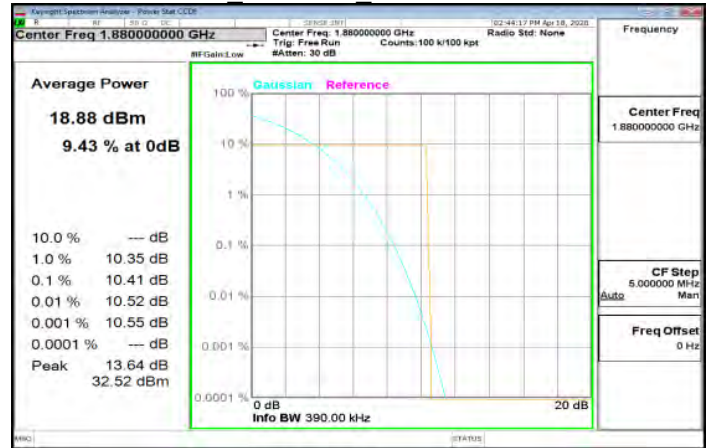

GSM 1900MHz HighCH810-1909.8



GPRS 1900MHz HighCH810-1909.8



Unless otherwise stated the results shown in this test report refer only to the sample(s) tested and such sample(s) are retained for 90 days only.

除非另有說明，此報告結果僅對測試之樣品負責，同時此樣品僅保留90天。本報告未經本公司書面許可，不可部份複製。

This document is issued by the Company subject to its General Conditions of Service printed overleaf, available on request or accessible at <http://www.sgs.com.tw/Terms-and-Conditions> and for electronic format documents, subject to Terms and Conditions for Electronic Documents at <http://www.sgs.com.tw/Terms-and-Conditions>. Attention is drawn to the limitation of liability, indemnification and jurisdiction issues defined therein. Any holder of this document is advised that information contained hereon reflects the Company's findings at the time of its intervention only and within the limits of Client's instructions, if any. The Company's sole responsibility is to its Client and this document does not exonerate parties to a transaction from exercising all their rights and obligations under the transaction documents. This document cannot be reproduced except in full, without prior written approval of the Company. Any unauthorized alteration, forgery or falsification of the content or appearance of this document is unlawful and offenders may be prosecuted to the fullest extent of the law.

WCDMA B5 LowCH4132-826.4

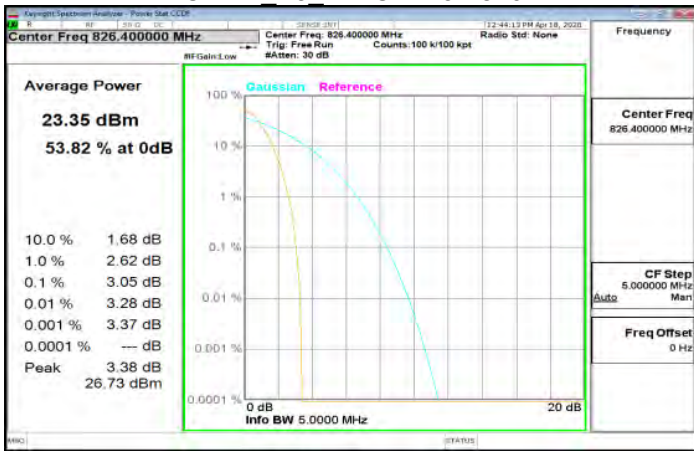

HSDPA B5 LowCH4132-826.4

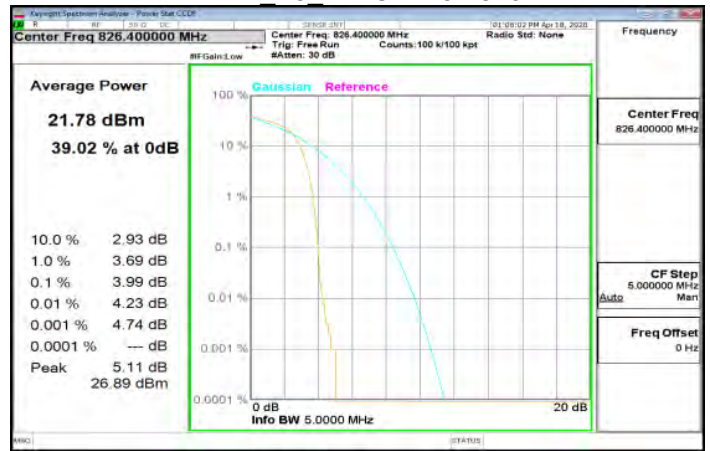

WCDMA B5 MidCH4183-836.6

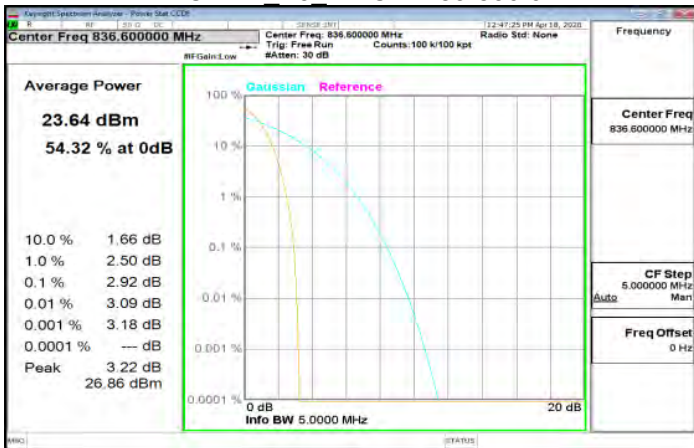

HSDPA B5 MidCH4183-836.6

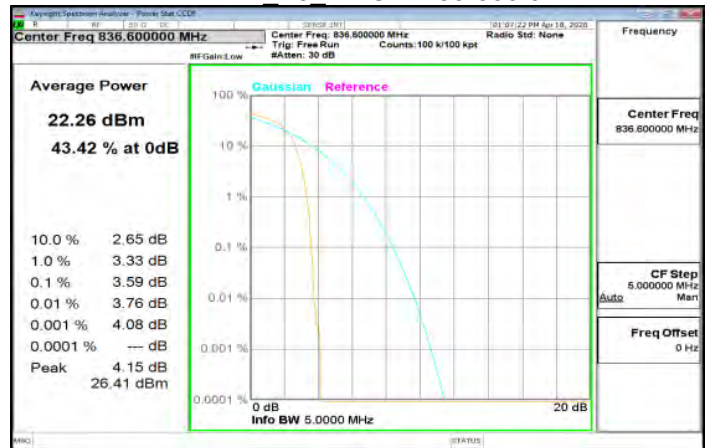

WCDMA B5 HighCH4233-846.6

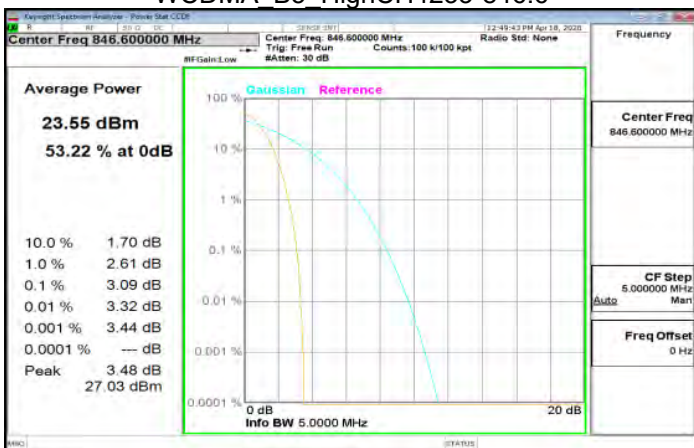

HSDPA B5 HighCH4233-846.6



Unless otherwise stated the results shown in this test report refer only to the sample(s) tested and such sample(s) are retained for 90 days only.

除非另有說明，此報告結果僅對測試之樣品負責，同時此樣品僅保留90天。本報告未經本公司書面許可，不可部份複製。

This document is issued by the Company subject to its General Conditions of Service printed overleaf, available on request or accessible at <http://www.sgs.com.tw/Terms-and-Conditions> and for electronic format documents, subject to Terms and Conditions for Electronic Documents at <http://www.sgs.com.tw/Terms-and-Conditions>. Attention is drawn to the limitation of liability, indemnification and jurisdiction issues defined therein. Any holder of this document is advised that information contained hereon reflects the Company's findings at the time of its intervention only and within the limits of Client's instructions, if any. The Company's sole responsibility is to its Client and this document does not exonerate parties to a transaction from exercising all their rights and obligations under the transaction documents. This document cannot be reproduced except in full, without prior written approval of the Company. Any unauthorized alteration, forgery or falsification of the content or appearance of this document is unlawful and offenders may be prosecuted to the fullest extent of the law.

HSUPA B5 LowCH4132-826.4

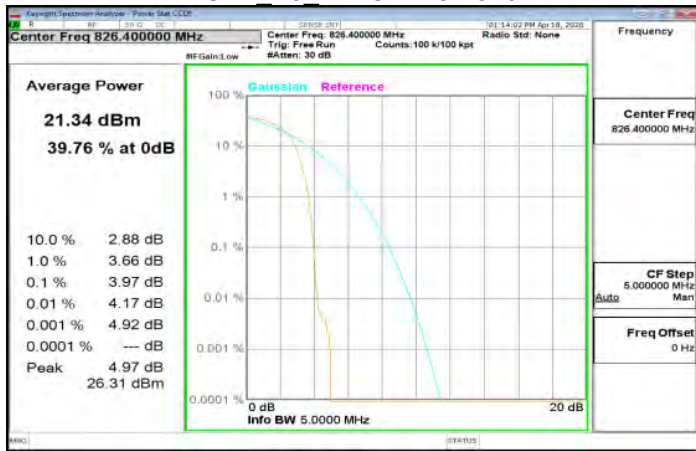

LTE Band5 1 4MHz 16QAM 6 0 LowCH20407-824.7

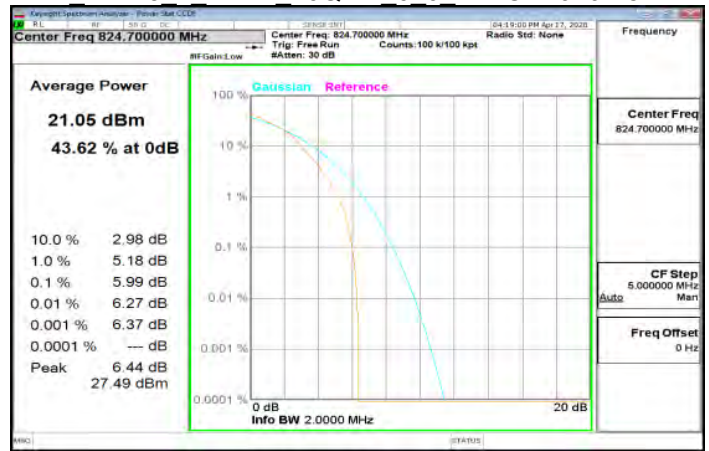

HSUPA B5 MidCH4183-836.6

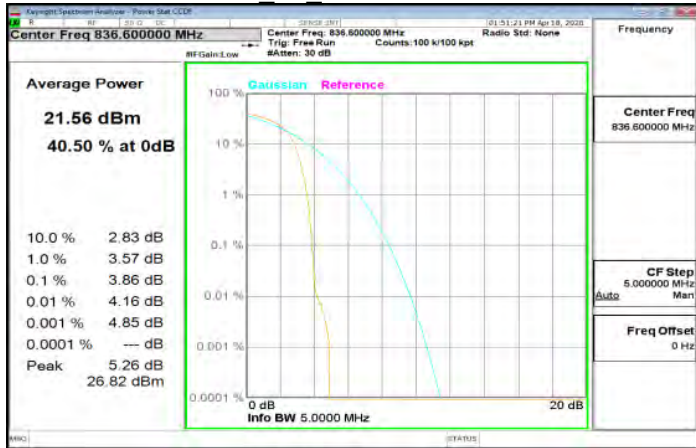

LTE Band5 1 4MHz 16QAM 6 0 MidCH20525-836.5

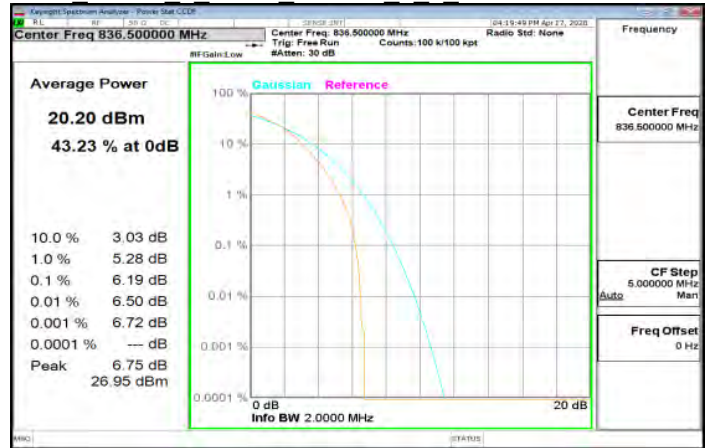

HSUPA B5 HighCH4233-846.6



LTE Band5 1 4MHz 16QAM 6 0 HighCH20643-848.3

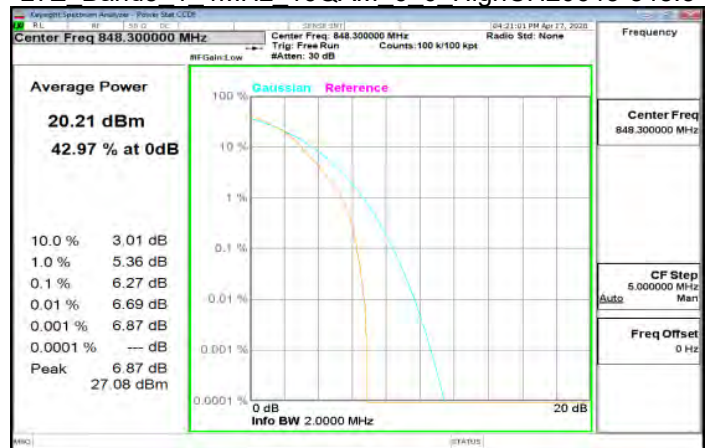

Unless otherwise stated the results shown in this test report refer only to the sample(s) tested and such sample(s) are retained for 90 days only.

除非另有說明，此報告結果僅對測試之樣品負責，同時此樣品僅保留90天。本報告未經本公司書面許可，不可部份複製。

This document is issued by the Company subject to its General Conditions of Service printed overleaf, available on request or accessible at <http://www.sgs.com.tw/Terms-and-Conditions> and for electronic format documents, subject to Terms and Conditions for Electronic Documents at <http://www.sgs.com.tw/Terms-and-Conditions>. Attention is drawn to the limitation of liability, indemnification and jurisdiction issues defined therein. Any holder of this document is advised that information contained hereon reflects the Company's findings at the time of its intervention only and within the limits of Client's instructions, if any. The Company's sole responsibility is to its Client and this document does not exonerate parties to a transaction from exercising all their rights and obligations under the transaction documents. This document cannot be reproduced except in full, without prior written approval of the Company. Any unauthorized alteration, forgery or falsification of the content or appearance of this document is unlawful and offenders may be prosecuted to the fullest extent of the law.

LTE Band5 3MHz 16QAM 15 0 LowCH20415-825.5

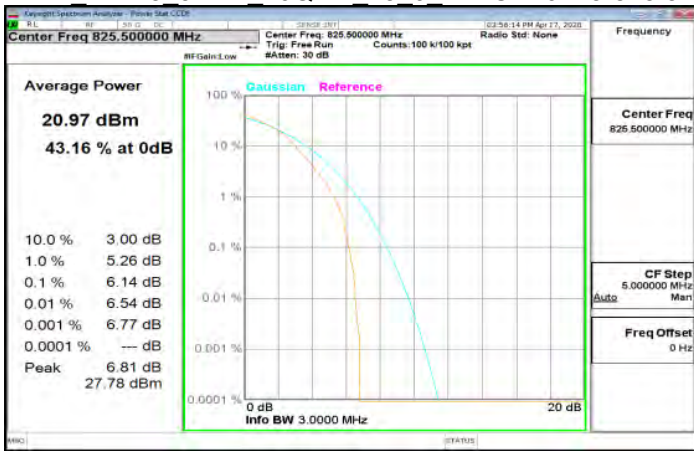

LTE Band5 5MHz 16QAM 25 0 LowCH20425-826.5

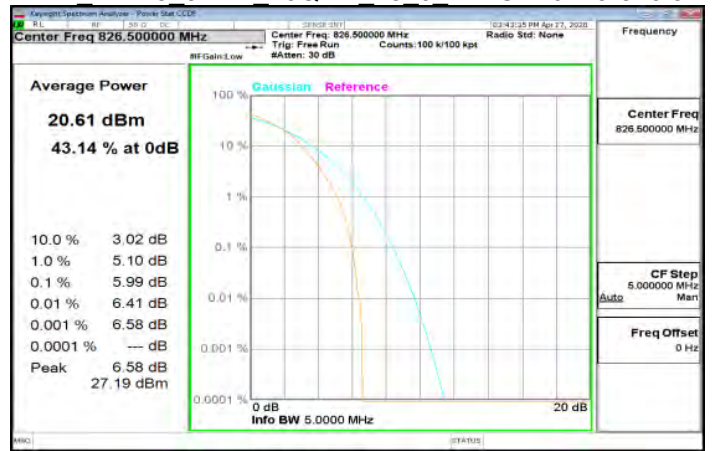

LTE Band5 3MHz 16QAM 15 0 MidCH20525-836.5

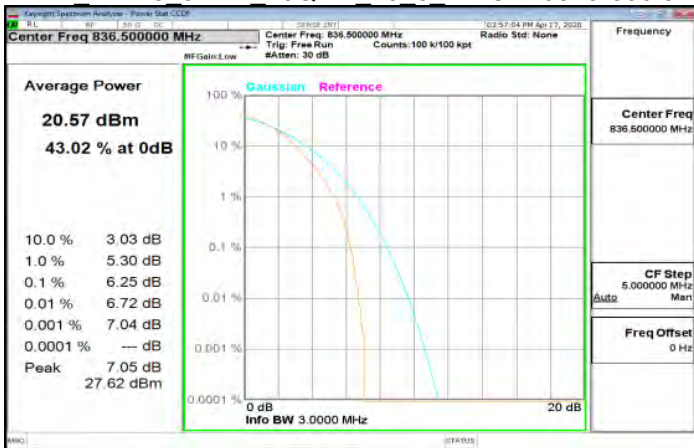

LTE Band5 5MHz 16QAM 25 0 MidCH20525-836.5

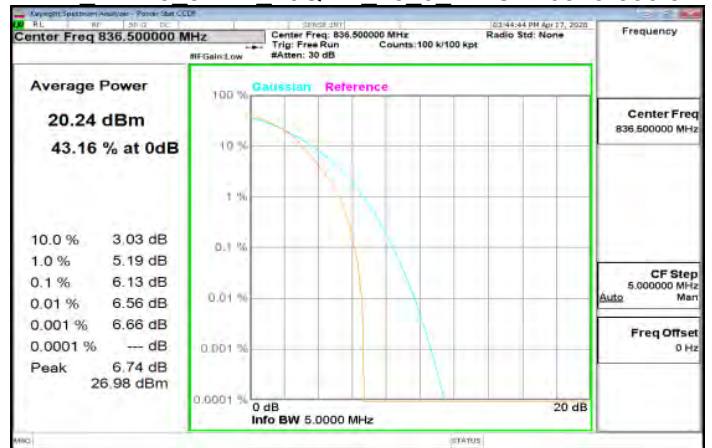

LTE Band5 3MHz 16QAM 15 0 HighCH20635-847.5

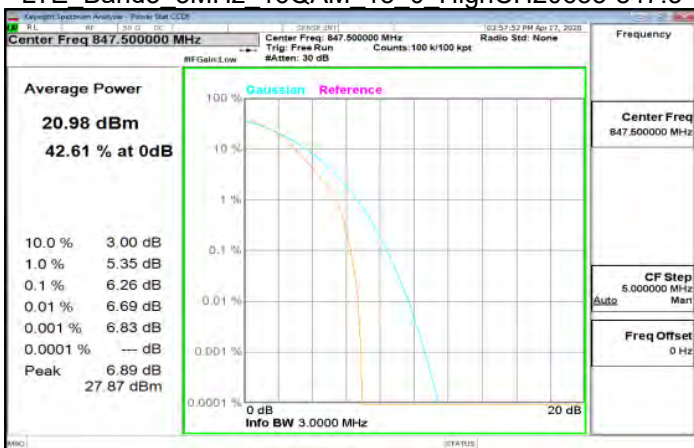

LTE Band5 5MHz 16QAM 25 0 HighCH20625-846.5

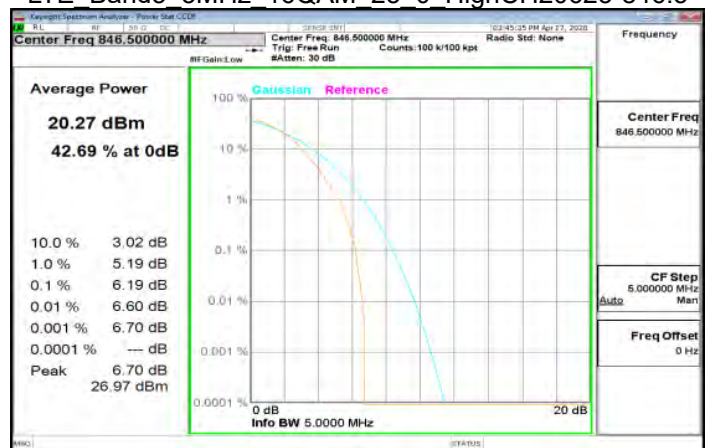

Unless otherwise stated the results shown in this test report refer only to the sample(s) tested and such sample(s) are retained for 90 days only.

除非另有說明，此報告結果僅對測試之樣品負責，同時此樣品僅保留90天。本報告未經本公司書面許可，不可部份複製。

This document is issued by the Company subject to its General Conditions of Service printed overleaf, available on request or accessible at <http://www.sgs.com.tw/Terms-and-Conditions> and for electronic format documents, subject to Terms and Conditions for Electronic Documents at <http://www.sgs.com.tw/Terms-and-Conditions>. Attention is drawn to the limitation of liability, indemnification and jurisdiction issues defined therein. Any holder of this document is advised that information contained hereon reflects the Company's findings at the time of its intervention only and within the limits of Client's instructions, if any. The Company's sole responsibility is to its Client and this document does not exonerate parties to a transaction from exercising all their rights and obligations under the transaction documents. This document cannot be reproduced except in full, without prior written approval of the Company. Any unauthorized alteration, forgery or falsification of the content or appearance of this document is unlawful and offenders may be prosecuted to the fullest extent of the law.

LTE Band5 10MHz 16QAM 50 0 LowCH20450-829

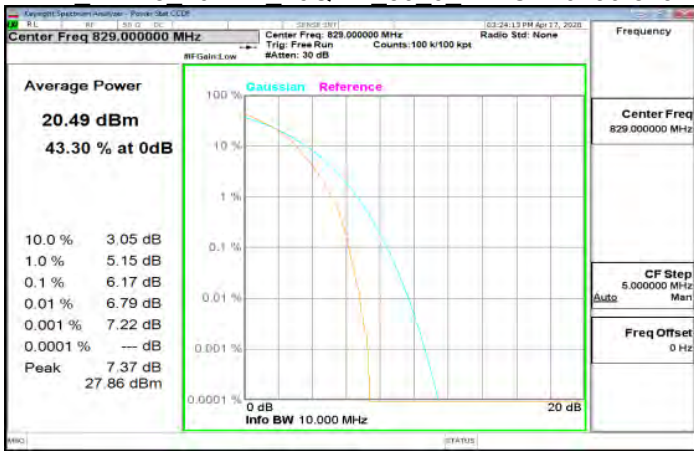

LTE Band12 1 4MHz 16QAM 6 0 LowCH23017-699.7

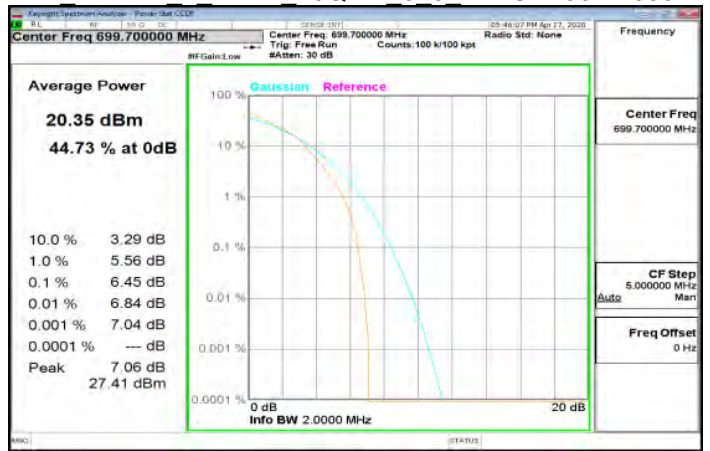

LTE Band5 10MHz 16QAM 50 0 MidCH20525-836.5

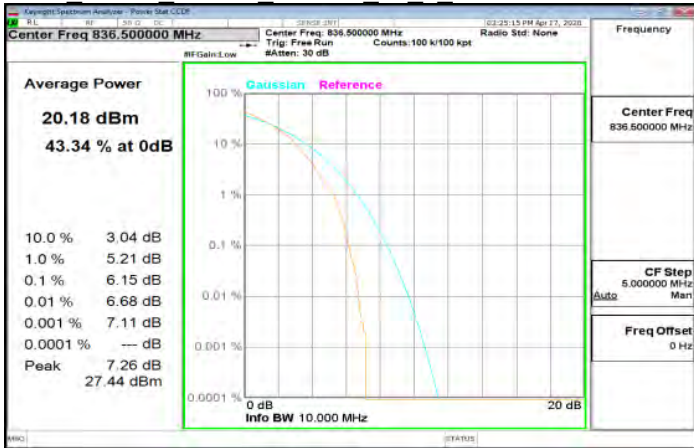

LTE Band12 1 4MHz 16QAM 6 0 MidCH23095-707.5

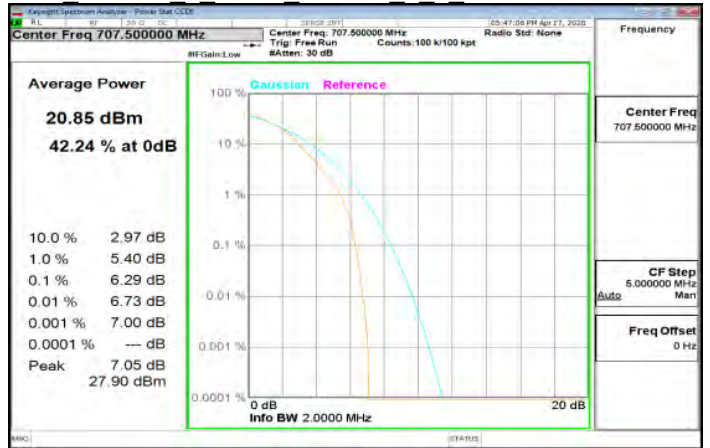

LTE Band5 10MHz 16QAM 50 0 HighCH20600-844

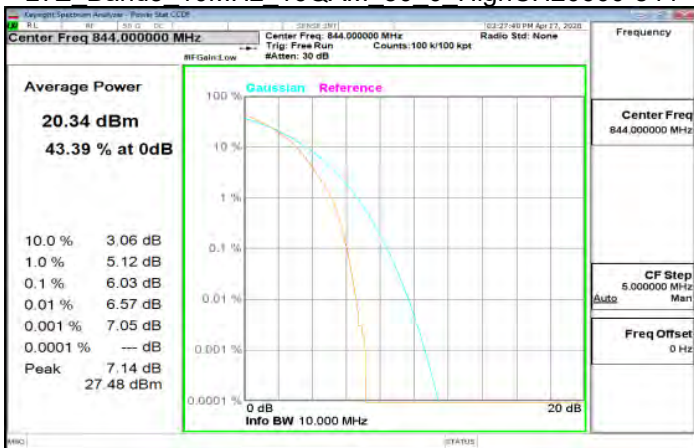

LTE Band12 1 4MHz 16QAM 6 0 HighCH23173-715.3

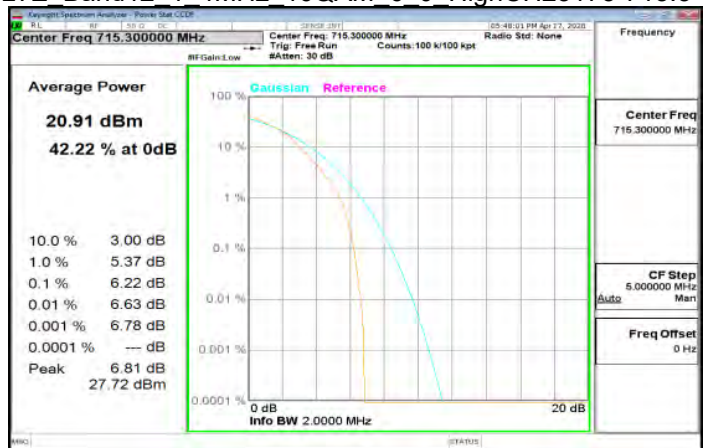

Unless otherwise stated the results shown in this test report refer only to the sample(s) tested and such sample(s) are retained for 90 days only.

除非另有說明，此報告結果僅對測試之樣品負責，同時此樣品僅保留90天。本報告未經本公司書面許可，不可部份複製。

This document is issued by the Company subject to its General Conditions of Service printed overleaf, available on request or accessible at <http://www.sgs.com.tw/Terms-and-Conditions> and for electronic format documents, subject to Terms and Conditions for Electronic Documents at <http://www.sgs.com.tw/Terms-and-Conditions>. Attention is drawn to the limitation of liability, indemnification and jurisdiction issues defined therein. Any holder of this document is advised that information contained hereon reflects the Company's findings at the time of its intervention only and within the limits of Client's instructions, if any. The Company's sole responsibility is to its Client and this document does not exonerate parties to a transaction from exercising all their rights and obligations under the transaction documents. This document cannot be reproduced except in full, without prior written approval of the Company. Any unauthorized alteration, forgery or falsification of the content or appearance of this document is unlawful and offenders may be prosecuted to the fullest extent of the law.

LTE Band12 3MHz 16QAM 15 0 LowCH23025-700.5

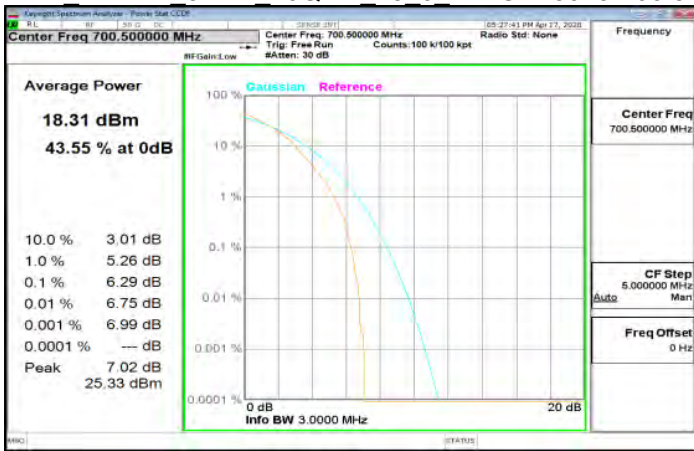

LTE Band12 5MHz 16QAM 25 0 LowCH23035-701.5

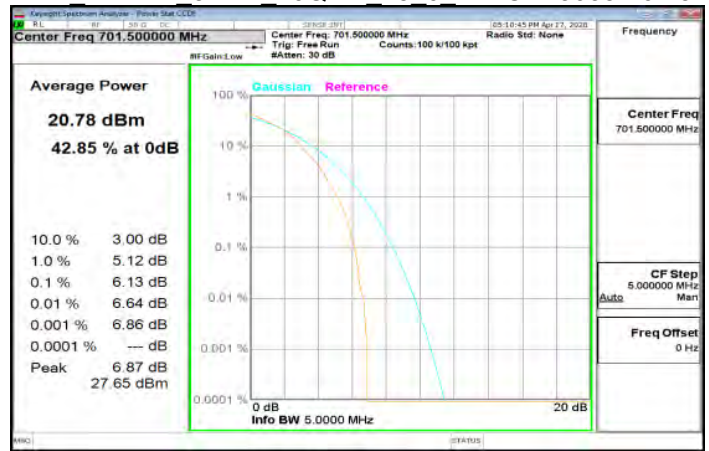

LTE Band12 3MHz 16QAM 15 0 MidCH23095-707.5

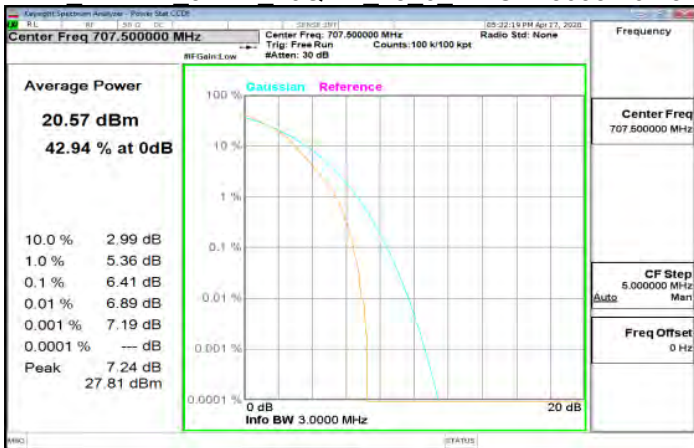

LTE Band12 5MHz 16QAM 25 0 MidCH23095-707.5

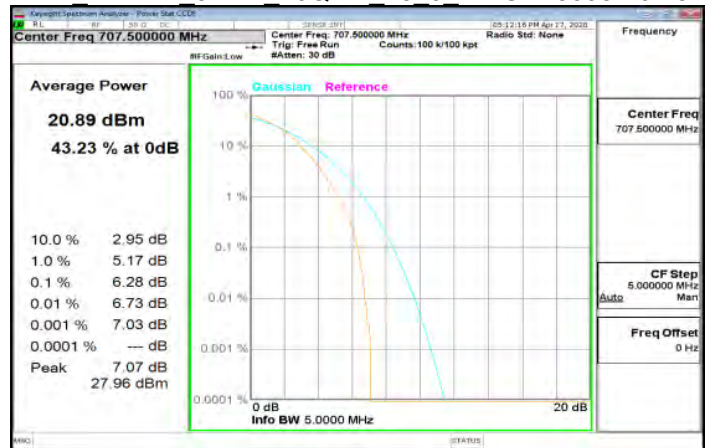

LTE Band12 3MHz 16QAM 15 0 HighCH23165-714.5



LTE Band12 5MHz 16QAM 25 0 HighCH23155-713.5

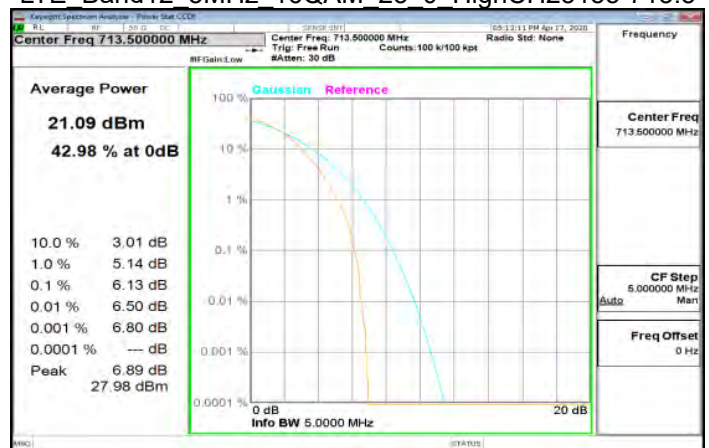

Unless otherwise stated the results shown in this test report refer only to the sample(s) tested and such sample(s) are retained for 90 days only.

除非另有說明，此報告結果僅對測試之樣品負責，同時此樣品僅保留90天。本報告未經本公司書面許可，不可部份複製。

This document is issued by the Company subject to its General Conditions of Service printed overleaf, available on request or accessible at <http://www.sgs.com.tw/Terms-and-Conditions> and for electronic format documents, subject to Terms and Conditions for Electronic Documents at <http://www.sgs.com.tw/Terms-and-Conditions>. Attention is drawn to the limitation of liability, indemnification and jurisdiction issues defined therein. Any holder of this document is advised that information contained hereon reflects the Company's findings at the time of its intervention only and within the limits of Client's instructions, if any. The Company's sole responsibility is to its Client and this document does not exonerate parties to a transaction from exercising all their rights and obligations under the transaction documents. This document cannot be reproduced except in full, without prior written approval of the Company. Any unauthorized alteration, forgery or falsification of the content or appearance of this document is unlawful and offenders may be prosecuted to the fullest extent of the law.

LTE Band12 10MHz 16QAM 50 0 LowCH23060-704

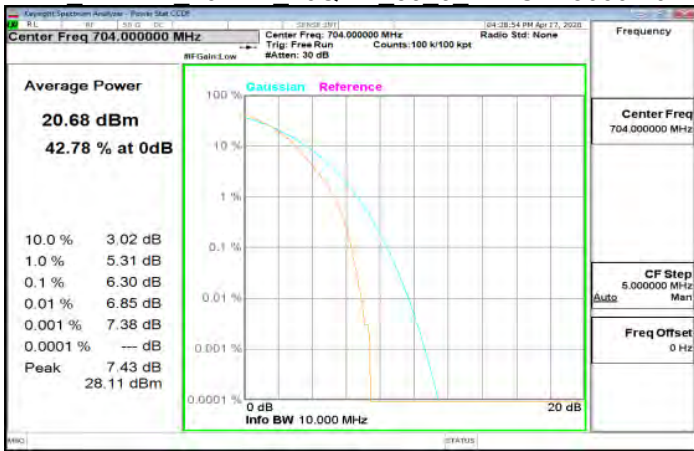

LTE Band17 5MHz 16QAM 25 0 LowCH23755-706.5

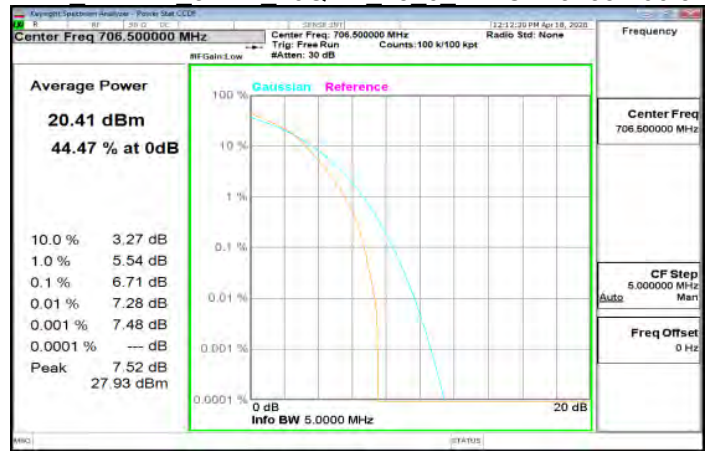

LTE Band12 10MHz 16QAM 50 0 MidCH23095-707.5

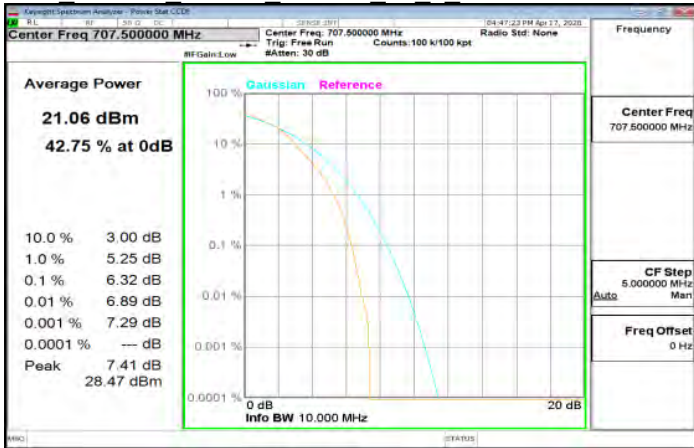

LTE Band17 5MHz 16QAM 25 0 MidCH23790-710

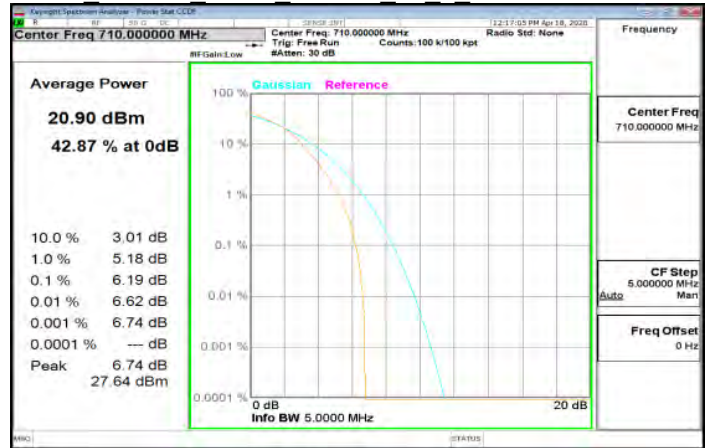

LTE Band12 10MHz 16QAM 50 0 HighCH23130-711

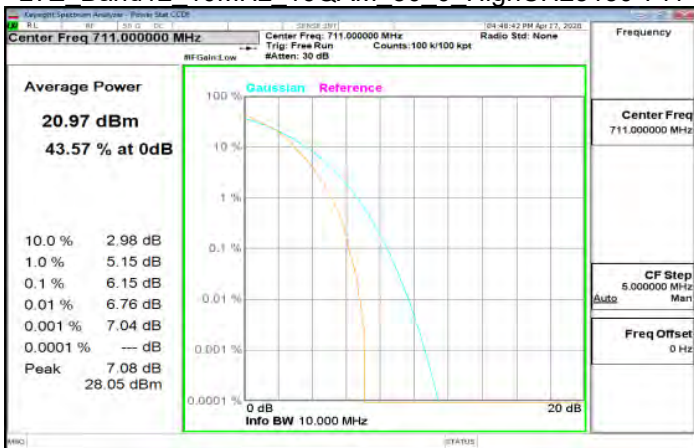

LTE Band17 5MHz 16QAM 25 0 HighCH23825-713.5

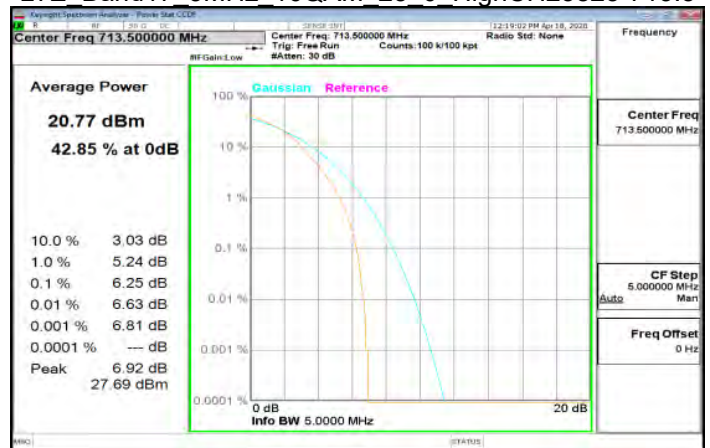

Unless otherwise stated the results shown in this test report refer only to the sample(s) tested and such sample(s) are retained for 90 days only.
除非另有說明，此報告結果僅對測試之樣品負責，同時此樣品僅保留90天。本報告未經本公司書面許可，不可部份複製。

This document is issued by the Company subject to its General Conditions of Service printed overleaf, available on request or accessible at <http://www.sgs.com.tw/Terms-and-Conditions> and for electronic format documents, subject to Terms and Conditions for Electronic Documents at <http://www.sgs.com.tw/Terms-and-Conditions>. Attention is drawn to the limitation of liability, indemnification and jurisdiction issues defined therein. Any holder of this document is advised that information contained hereon reflects the Company's findings at the time of its intervention only and within the limits of Client's instructions, if any. The Company's sole responsibility is to its Client and this document does not exonerate parties to a transaction from exercising all their rights and obligations under the transaction documents. This document cannot be reproduced except in full, without prior written approval of the Company. Any unauthorized alteration, forgery or falsification of the content or appearance of this document is unlawful and offenders may be prosecuted to the fullest extent of the law.

LTE Band17 10MHz 16QAM 50 0 LowCH23780-709

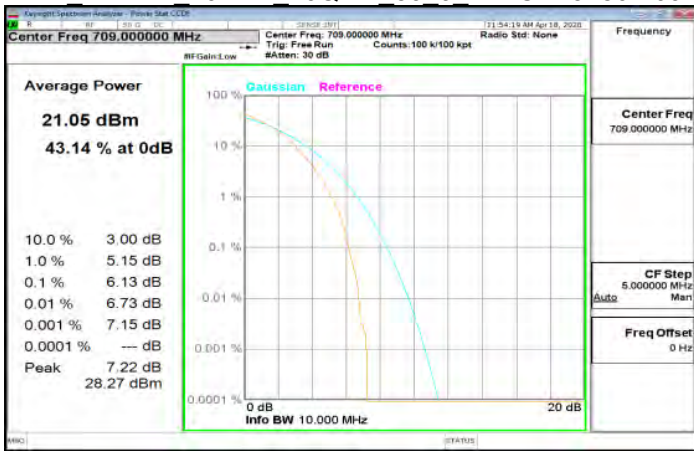

LTE Band17 10MHz 16QAM 50 0 HighCH23800-711

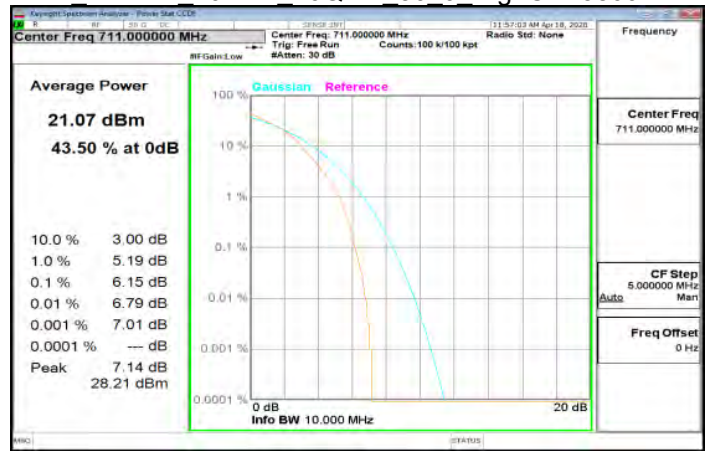

LTE Band17 10MHz 16QAM 50 0 MidCH23790-710

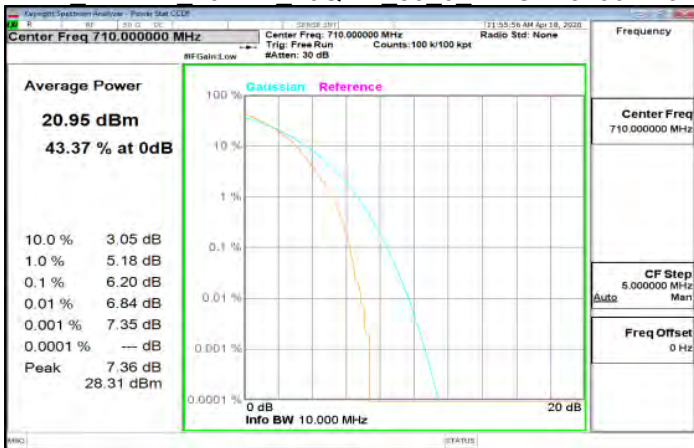

Unless otherwise stated the results shown in this test report refer only to the sample(s) tested and such sample(s) are retained for 90 days only.

除非另有說明，此報告結果僅對測試之樣品負責，同時此樣品僅保留90天。本報告未經本公司書面許可，不可部份複製。

This document is issued by the Company subject to its General Conditions of Service printed overleaf, available on request or accessible at <http://www.sgs.com.tw/Terms-and-Conditions> and for electronic format documents, subject to Terms and Conditions for Electronic Documents at <http://www.sgs.com.tw/Terms-and-Conditions>. Attention is drawn to the limitation of liability, indemnification and jurisdiction issues defined therein. Any holder of this document is advised that information contained hereon reflects the Company's findings at the time of its intervention only and within the limits of Client's instructions, if any. The Company's sole responsibility is to its Client and this document does not exonerate parties to a transaction from exercising all their rights and obligations under the transaction documents. This document cannot be reproduced except in full, without prior written approval of the Company. Any unauthorized alteration, forgery or falsification of the content or appearance of this document is unlawful and offenders may be prosecuted to the fullest extent of the law.

~ End of Report ~

Unless otherwise stated the results shown in this test report refer only to the sample(s) tested and such sample(s) are retained for 90 days only.
除非另有說明，此報告結果僅對測試之樣品負責，同時此樣品僅保留90天。本報告未經本公司書面許可，不可部份複製。

This document is issued by the Company subject to its General Conditions of Service printed overleaf, available on request or accessible at <http://www.sgs.com.tw/Terms-and-Conditions> and for electronic format documents, subject to Terms and Conditions for Electronic Documents at <http://www.sgs.com.tw/Terms-and-Conditions>. Attention is drawn to the limitation of liability, indemnification and jurisdiction issues defined therein. Any holder of this document is advised that information contained hereon reflects the Company's findings at the time of its intervention only and within the limits of Client's instructions, if any. The Company's sole responsibility is to its Client and this document does not exonerate parties to a transaction from exercising all their rights and obligations under the transaction documents. This document cannot be reproduced except in full, without prior written approval of the Company. Any unauthorized alteration, forgery or falsification of the content or appearance of this document is unlawful and offenders may be prosecuted to the fullest extent of the law.