



# FCC SAR TEST REPORT

**FCC ID** : 2AQYEFMP177  
**Equipment** : Mobile Phone  
**Brand Name** : FUJITSU  
**Model Name** : F-41A  
**Applicant** : FUJITSU CONNECTED TECHNOLOGIES Ltd.  
Chuorinkan 7-10-1 Yamato, Kanagawa 242-0007, Japan.  
**Manufacturer** : FUJITSU CONNECTED TECHNOLOGIES Ltd.  
Chuorinkan 7-10-1 Yamato, Kanagawa 242-0007, Japan.  
**Standard** : FCC 47 CFR Part 2 (2.1093)  
ANSI/IEEE C95.1-1992  
IEEE 1528-2013

The product was received on Feb. 10, 2020 and testing was started from Mar. 03, 2020 and completed on Mar. 10, 2020. We, SPORTON INTERNATIONAL INC., would like to declare that the tested sample has been evaluated in accordance with the test procedures and has been in compliance with the applicable technical standards.

The report must not be used by the client to claim product certification, approval, or endorsement by TAF or any agency of government.

The test results in this report apply exclusively to the tested model / sample. Without written approval of SPORTON INTERNATIONAL INC. EMC & Wireless Communications Laboratory, the test report shall not be reproduced except in full.

Approved by: Cona Huang / Deputy Manager

**SPORTON INTERNATIONAL INC. EMC & Wireless Communications Laboratory**  
No. 52, Huaya 1st Rd., Guishan Dist., Taoyuan City, Taiwan (R.O.C.)



**Table of Contents**

**1. Statement of Compliance ..... 4**

**2. Guidance Applied..... 4**

**3. Equipment Under Test (EUT) Information ..... 5**

    3.1 General Information ..... 5

    3.2 General LTE SAR Test and Reporting Considerations ..... 6

**4. RF Exposure Limits..... 7**

    4.1 Uncontrolled Environment..... 7

    4.2 Controlled Environment..... 7

**5. Specific Absorption Rate (SAR)..... 8**

    5.1 Introduction ..... 8

    5.2 SAR Definition..... 8

**6. System Description and Setup ..... 9**

    6.1 E-Field Probe ..... 10

    6.2 Data Acquisition Electronics (DAE) ..... 10

    6.3 Phantom..... 11

    6.4 Device Holder..... 12

**7. Measurement Procedures ..... 13**

    7.1 Spatial Peak SAR Evaluation ..... 13

    7.2 Power Reference Measurement..... 14

    7.3 Area Scan ..... 14

    7.4 Zoom Scan..... 15

    7.5 Volume Scan Procedures..... 15

    7.6 Power Drift Monitoring..... 15

**8. Test Equipment List ..... 16**

**9. System Verification ..... 17**

    9.1 Tissue Simulating Liquids..... 17

    9.2 Tissue Verification ..... 18

    9.3 System Performance Check Results..... 19

**10. RF Exposure Positions ..... 20**

    10.1 Ear and handset reference point ..... 20

    10.2 Definition of the cheek position ..... 21

    10.3 Definition of the tilt position ..... 22

    10.4 Body Worn Accessory ..... 23

    10.5 Wireless Router..... 23

**11. GSM/UMTS/CDMA/LTE Output Power (Unit: dBm)..... 24**

**12. WiFi/Bluetooth Output Power (Unit: dBm) ..... 34**

**13. RF exposure position consideration ..... 39**

**14. SAR Test Results ..... 39**

    14.1 Head SAR ..... 41

    14.2 Hotspot SAR ..... 43

    14.3 Body Worn Accessory SAR..... 44

    14.4 Repeated SAR Measurement ..... 45

**15. Simultaneous Transmission Analysis ..... 46**

    15.1 Head Exposure Conditions ..... 47

    15.2 Hotspot Exposure Conditions..... 48

    15.3 Body-Worn Accessory Exposure Conditions ..... 48

**16. Uncertainty Assessment ..... 49**

**17. References..... 49**

**Appendix A. Plots of System Performance Check**

**Appendix B. Plots of High SAR Measurement**

**Appendix C. DASYS Calibration Certificate**

**Appendix D. Test Setup Photos**





1. Statement of Compliance

The maximum results of Specific Absorption Rate (SAR) found during testing for FUJITSU CONNECTED TECHNOLOGIES Ltd., Mobile Phone, F-41A, are as follows.

Table with 7 columns: Equipment Class, Frequency Band, Highest SAR Summary (Head, Body-worn, Hotspot), Highest Simultaneous Transmission 1g SAR (W/kg) of head, Highest Simultaneous Transmission 1g SAR (W/kg) of body. Includes rows for Licensed, DTS, NII, DSS and a Remark section.

Sporton Lab is accredited to ISO 17025 by Taiwan Accreditation Foundation (TAF code: 1190) and the FCC designation No. TW1190 under the FCC 2.948(e) by Mutual Recognition Agreement (MRA) in FCC test. This device is in compliance with Specific Absorption Rate (SAR) for general population/uncontrolled exposure limits (1.6 W/kg) specified in FCC 47 CFR part 2 (2.1093) and ANSI/IEEE C95.1-1992, and had been tested in accordance with the measurement methods and procedures specified in IEEE 1528-2013 and FCC KDB publications.

Reviewed by: Eric Huang
Report Producer: Daisy Peng

2. Guidance Applied

The Specific Absorption Rate (SAR) testing specification, method, and procedure for this device is in accordance with the following standards:

- FCC 47 CFR Part 2 (2.1093)
ANSI/IEEE C95.1-1992
IEEE 1528-2013
FCC KDB 865664 D01 SAR Measurement 100 MHz to 6 GHz v01r04
FCC KDB 865664 D02 SAR Reporting v01r02
FCC KDB 447498 D01 General RF Exposure Guidance v06
FCC KDB 648474 D04 SAR Evaluation Considerations for Wireless Handsets v01r03
FCC KDB 248227 D01 802.11 Wi-Fi SAR v02r02
FCC KDB 941225 D01 3G SAR Procedures v03r01
FCC KDB 941225 D05 SAR for LTE Devices v02r05
FCC KDB 941225 D06 Hotspot Mode SAR v02r01



3. Equipment Under Test (EUT) Information

3.1 General Information

Product Feature & Specification	
Equipment Name	Mobile Phone
Brand Name	FUJITSU
Model Name	F-41A
FCC ID	2AQYEFMP177
Wireless Technology and Frequency Range	GSM850: 824.2 MHz ~ 848.8 MHz GSM1900: 1850.2 MHz ~ 1909.8 MHz WCDMA Band V: 826.4 MHz ~ 846.6 MHz LTE Band 5: 824.7 MHz ~ 848.3 MHz LTE Band 12: 699.7 MHz ~ 715.3 MHz LTE Band 17: 706.5 MHz ~ 713.5 MHz WLAN 2.4GHz Band: 2412 MHz ~ 2462 MHz WLAN 5.2GHz Band: 5180 MHz ~ 5240 MHz WLAN 5.3GHz Band: 5260 MHz ~ 5320 MHz WLAN 5.5GHz Band: 5500 MHz ~ 5720 MHz Bluetooth: 2402 MHz ~ 2480 MHz NFC : 13.56 MHz
Mode	GSM/GPRS RMC/AMR 12.2Kbps HSDPA HSUPA LTE: QPSK, 16QAM WLAN: 802.11a/b/g/n/ac HT20 / HT40 / VHT20 / VHT40 / VHT80 Bluetooth BR/EDR/LE NFC:ASK
GSM / (E)GPRS Transfer mode	Class B – EUT cannot support Packet Switched and Circuit Switched Network simultaneously but can automatically switch between Packet and Circuit Switched Network.
EUT Stage	Identical Prototype



**3.2 General LTE SAR Test and Reporting Considerations**

Summarized necessary items addressed in KDB 941225 D05 v02r05								
FCC ID	2AQYEFMP177							
Equipment Name	Mobile Phone							
Operating Frequency Range of each LTE transmission band	LTE Band 5: 824.7 MHz ~ 848.3 MHz LTE Band 12: 699.7 MHz ~ 715.3 MHz LTE Band 17: 706.5 MHz ~ 713.5 MHz							
Channel Bandwidth	LTE Band 05: 1.4MHz, 3MHz, 5MHz, 10MHz LTE Band 12: 1.4MHz, 3MHz, 5MHz, 10MHz LTE Band 17: 5MHz, 10MHz							
uplink modulations used	QPSK / 16QAM							
LTE Voice / Data requirements	Data only							
LTE MPR permanently built-in by design	<b>Table 6.2.3-1: Maximum Power Reduction (MPR) for Power Class 1, 2 and 3</b>							
	Modulation	Channel bandwidth / Transmission bandwidth (N <sub>RB</sub> )						MPR (dB)
		1.4 MHz	3.0 MHz	5 MHz	10 MHz	15 MHz	20 MHz	
	QPSK	> 5	> 4	> 8	> 12	> 16	> 18	≤ 1
	16 QAM	≤ 5	≤ 4	≤ 8	≤ 12	≤ 16	≤ 18	≤ 1
	16 QAM	> 5	> 4	> 8	> 12	> 16	> 18	≤ 2
	64 QAM	≤ 5	≤ 4	≤ 8	≤ 12	≤ 16	≤ 18	≤ 2
64 QAM	> 5	> 4	> 8	> 12	> 16	> 18	≤ 3	
256 QAM	≥ 1						≤ 5	
LTE A-MPR	In the base station simulator configuration, Network Setting value is set to NS_01 to disable A-MPR during SAR testing and the LTE SAR tests was transmitting on all TTI frames (Maximum TTI)							
Spectrum plots for RB configuration	A properly configured base station simulator was used for the SAR and power measurement; therefore, spectrum plots for each RB allocation and offset configuration are not included in the SAR report.							
Transmission (H, M, L) channel numbers and frequencies in each LTE band								
LTE Band 5								
	Bandwidth 1.4 MHz		Bandwidth 3 MHz		Bandwidth 5 MHz		Bandwidth 10 MHz	
	Ch. #	Freq. (MHz)	Ch. #	Freq. (MHz)	Ch. #	Freq. (MHz)	Ch. #	Freq. (MHz)
L	20407	824.7	20415	825.5	20425	826.5	20450	829
M	20525	836.5	20525	836.5	20525	836.5	20525	836.5
H	20643	848.3	20635	847.5	20625	846.5	20600	844
LTE Band 12								
	Bandwidth 1.4 MHz		Bandwidth 3 MHz		Bandwidth 5 MHz		Bandwidth 10 MHz	
	Ch. #	Freq. (MHz)	Ch. #	Freq. (MHz)	Ch. #	Freq. (MHz)	Ch. #	Freq. (MHz)
L	23017	699.7	23025	700.5	23035	701.5	23060	704
M	23095	707.5	23095	707.5	23095	707.5	23095	707.5
H	23173	715.3	23165	714.5	23155	713.5	23130	711
LTE Band 17								
	Bandwidth 5 MHz				Bandwidth 10 MHz			
	Channel #		Freq. (MHz)		Channel #		Freq. (MHz)	
L	23755		706.5		23780		709	
M	23790		710		23790		710	
H	23825		713.5		23800		711	

**4. RF Exposure Limits**

**4.1 Uncontrolled Environment**

Uncontrolled Environments are defined as locations where there is the exposure of individuals who have no knowledge or control of their exposure. The general population/uncontrolled exposure limits are applicable to situations in which the general public may be exposed or in which persons who are exposed as a consequence of their employment may not be made fully aware of the potential for exposure or cannot exercise control over their exposure. Members of the general public would come under this category when exposure is not employment-related; for example, in the case of a wireless transmitter that exposes persons in its vicinity.

**4.2 Controlled Environment**

Controlled Environments are defined as locations where there is exposure that may be incurred by persons who are aware of the potential for exposure, (i.e. as a result of employment or occupation). In general, occupational/controlled exposure limits are applicable to situations in which persons are exposed as a consequence of their employment, who have been made fully aware of the potential for exposure and can exercise control over their exposure. The exposure category is also applicable when the exposure is of a transient nature due to incidental passage through a location where the exposure levels may be higher than the general population/uncontrolled limits, but the exposed person is fully aware of the potential for exposure and can exercise control over his or her exposure by leaving the area or by some other appropriate means.

**Limits for Occupational/Controlled Exposure (W/kg)**

Whole-Body	Partial-Body	Hands, Wrists, Feet and Ankles
0.4	8.0	20.0

**Limits for General Population/Uncontrolled Exposure (W/kg)**

Whole-Body	Partial-Body	Hands, Wrists, Feet and Ankles
0.08	1.6	4.0

1. Whole-Body SAR is averaged over the entire body, partial-body SAR is averaged over any 1gram of tissue defined as a tissue volume in the shape of a cube. SAR for hands, wrists, feet and ankles is averaged over any 10 grams of tissue defined as a tissue volume in the shape of a cube.

## **5. Specific Absorption Rate (SAR)**

### **5.1 Introduction**

SAR is related to the rate at which energy is absorbed per unit mass in an object exposed to a radio field. The SAR distribution in a biological body is complicated and is usually carried out by experimental techniques or numerical modeling. The standard recommends limits for two tiers of groups, occupational/controlled and general population/uncontrolled, based on a person's awareness and ability to exercise control over his or her exposure. In general, occupational/controlled exposure limits are higher than the limits for general population/uncontrolled.

### **5.2 SAR Definition**

The SAR definition is the time derivative (rate) of the incremental energy (dW) absorbed by (dissipated in) an incremental mass (dm) contained in a volume element (dv) of a given density ( $\rho$ ). The equation description is as below:

$$SAR = \frac{d}{dt} \left( \frac{dW}{dm} \right) = \frac{d}{dt} \left( \frac{dW}{\rho dv} \right)$$

SAR is expressed in units of Watts per kilogram (W/kg)

$$SAR = \frac{\sigma |E|^2}{\rho}$$

Where:  $\sigma$  is the conductivity of the tissue,  $\rho$  is the mass density of the tissue and E is the RMS electrical field strength.



## **6. System Description and Setup**

The DASY system used for performing compliance tests consists of the following items:

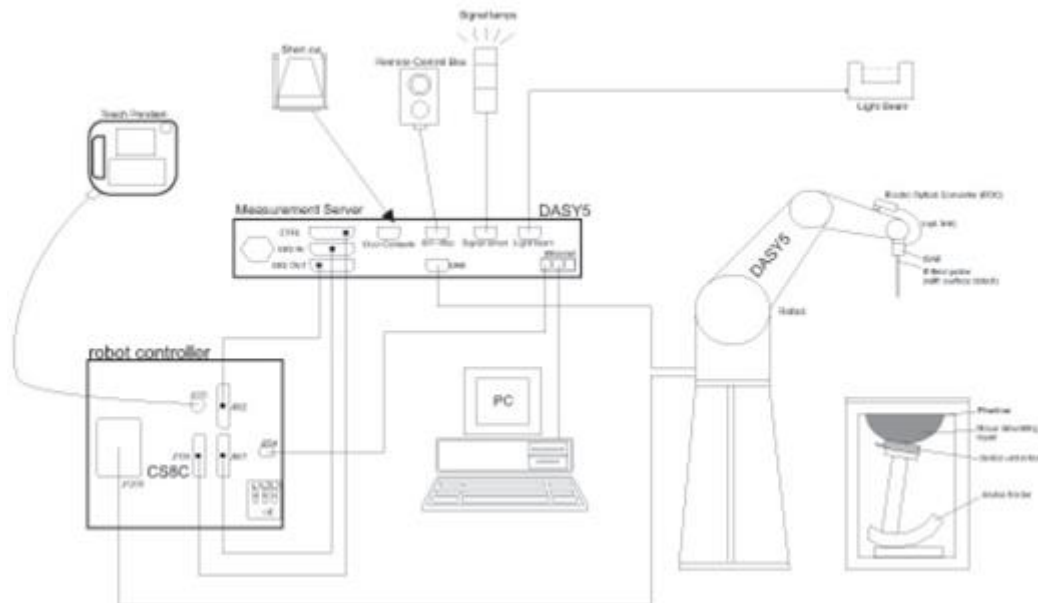

- A standard high precision 6-axis robot with controller, teach pendant and software. An arm extension for accommodating the data acquisition electronics (DAE).
- An isotropic Field probe optimized and calibrated for the targeted measurement.
- A data acquisition electronics (DAE) which performs the signal amplification, signal multiplexing, AD-conversion, offset measurements, mechanical surface detection, collision detection, etc. The unit is battery powered with standard or rechargeable batteries. The signal is optically transmitted to the EOC.
- The Electro-optical converter (EOC) performs the conversion from optical to electrical signals for the digital communication to the DAE. To use optical surface detection, a special version of the EOC is required. The EOC signal is transmitted to the measurement server.
- The function of the measurement server is to perform the time critical tasks such as signal filtering, control of the robot operation and fast movement interrupts.
- The Light Beam used is for probe alignment. This improves the (absolute) accuracy of the probe positioning.
- A computer running WinXP or Win7 and the DASY5 software.
- Remote control and teach pendant as well as additional circuitry for robot safety such as warning lamps, etc.
- The phantom, the device holder and other accessories according to the targeted measurement.

**6.1 E-Field Probe**

The SAR measurement is conducted with the dosimetric probe (manufactured by SPEAG).The probe is specially designed and calibrated for use in liquid with high permittivity. The dosimetric probe has special calibration in liquid at different frequency. This probe has a built in optical surface detection system to prevent from collision with phantom.

**<ES3DV3 Probe>**

<b>Construction</b>	Symmetric design with triangular core Interleaved sensors Built-in shielding against static charges PEEK enclosure material (resistant to organic solvents, e.g., DGBE)	
<b>Frequency</b>	10 MHz – 4 GHz; Linearity: $\pm 0.2$ dB (30 MHz – 4 GHz)	
<b>Directivity</b>	$\pm 0.2$ dB in TSL (rotation around probe axis) $\pm 0.3$ dB in TSL (rotation normal to probe axis)	
<b>Dynamic Range</b>	5 $\mu$ W/g – >100 mW/g; Linearity: $\pm 0.2$ dB	
<b>Dimensions</b>	Overall length: 337 mm (tip: 20 mm) Tip diameter: 3.9 mm (body: 12 mm) Distance from probe tip to dipole centers: 3.0 mm	

**<EX3DV4 Probe>**

<b>Construction</b>	Symmetric design with triangular core Built-in shielding against static charges PEEK enclosure material (resistant to organic solvents, e.g., DGBE)	
<b>Frequency</b>	10 MHz – >6 GHz Linearity: $\pm 0.2$ dB (30 MHz – 6 GHz)	
<b>Directivity</b>	$\pm 0.3$ dB in TSL (rotation around probe axis) $\pm 0.5$ dB in TSL (rotation normal to probe axis)	
<b>Dynamic Range</b>	10 $\mu$ W/g – >100 mW/g Linearity: $\pm 0.2$ dB (noise: typically <1 $\mu$ W/g)	
<b>Dimensions</b>	Overall length: 337 mm (tip: 20 mm) Tip diameter: 2.5 mm (body: 12 mm) Typical distance from probe tip to dipole centers: 1 mm	

**6.2 Data Acquisition Electronics (DAE)**

The data acquisition electronics (DAE) consists of a highly sensitive electrometer-grade preamplifier with auto-zeroing, a channel and gain-switching multiplexer, a fast 16 bit AD-converter and a command decoder and control logic unit. Transmission to the measurement server is accomplished through an optical downlink for data and status information as well as an optical uplink for commands and the clock.

The input impedance of the DAE is 200 MOhm; the inputs are symmetrical and floating. Common mode rejection is above 80 dB.



**Fig 5.1 Photo of DAE**

**6.3 Phantom**

**<SAM Twin Phantom>**

<b>Shell Thickness</b>	2 ± 0.2 mm; Center ear point: 6 ± 0.2 mm	
<b>Filling Volume</b>	Approx. 25 liters	
<b>Dimensions</b>	Length: 1000 mm; Width: 500 mm; Height: adjustable feet	
<b>Measurement Areas</b>	Left Hand, Right Hand, Flat Phantom	

The bottom plate contains three pair of bolts for locking the device holder. The device holder positions are adjusted to the standard measurement positions in the three sections. A white cover is provided to tap the phantom during off-periods to prevent water evaporation and changes in the liquid parameters. On the phantom top, three reference markers are provided to identify the phantom position with respect to the robot.

**<ELI Phantom>**

<b>Shell Thickness</b>	2 ± 0.2 mm (sagging: <1%)	
<b>Filling Volume</b>	Approx. 30 liters	
<b>Dimensions</b>	Major ellipse axis: 600 mm Minor axis: 400 mm	

The ELI phantom is intended for compliance testing of handheld and body-mounted wireless devices in the frequency range of 30 MHz to 6 GHz. ELI4 is fully compatible with standard and all known tissue simulating liquids.

## **6.4 Device Holder**

### **<Mounting Device for Hand-Held Transmitter>**

In combination with the Twin SAM V5.0/V5.0c or ELI phantoms, the Mounting Device for Hand-Held Transmitters enables rotation of the mounted transmitter device to specified spherical coordinates. At the heads, the rotation axis is at the ear opening. Transmitter devices can be easily and accurately positioned according to IEC 62209-1, IEEE 1528, FCC, or other specifications. The device holder can be locked for positioning at different phantom sections (left head, right head, flat). And upgrade kit to Mounting Device to enable easy mounting of wider devices like big smart-phones, e-books, small tablets, etc. It holds devices with width up to 140 mm.



Mounting Device for Hand-Held Transmitters



Mounting Device Adaptor for Wide-Phones

### **<Mounting Device for Laptops and other Body-Worn Transmitters>**

The extension is lightweight and made of POM, acrylic glass and foam. It fits easily on the upper part of the mounting device in place of the phone positioned. The extension is fully compatible with the SAM Twin and ELI phantoms.



Mounting Device for Laptops

## **7. Measurement Procedures**

The measurement procedures are as follows:

### <Conducted power measurement>

- (a) For WWAN power measurement, use base station simulator to configure EUT WWAN transmission in conducted connection with RF cable, at maximum power in each supported wireless interface and frequency band.
- (b) Read the WWAN RF power level from the base station simulator.
- (c) For WLAN/BT power measurement, use engineering software to configure EUT WLAN/BT continuously transmission, at maximum RF power in each supported wireless interface and frequency band
- (d) Connect EUT RF port through RF cable to the power meter, and measure WLAN/BT output power

### <SAR measurement>

- (a) Use base station simulator to configure EUT WWAN transmission in radiated connection, and engineering software to configure EUT WLAN/BT continuously transmission, at maximum RF power, in the highest power channel.
- (b) Place the EUT in the positions as Appendix D demonstrates.
- (c) Set scan area, grid size and other setting on the DASY software.
- (d) Measure SAR results for the highest power channel on each testing position.
- (e) Find out the largest SAR result on these testing positions of each band
- (f) Measure SAR results for other channels in worst SAR testing position if the reported SAR of highest power channel is larger than 0.8 W/kg

According to the test standard, the recommended procedure for assessing the peak spatial-average SAR value consists of the following steps:

- (a) Power reference measurement
- (b) Area scan
- (c) Zoom scan
- (d) Power drift measurement

### **7.1 Spatial Peak SAR Evaluation**

The procedure for spatial peak SAR evaluation has been implemented according to the test standard. It can be conducted for 1g and 10g, as well as for user-specific masses. The DASY software includes all numerical procedures necessary to evaluate the spatial peak SAR value.

The base for the evaluation is a "cube" measurement. The measured volume must include the 1g and 10g cubes with the highest averaged SAR values. For that purpose, the center of the measured volume is aligned to the interpolated peak SAR value of a previously performed area scan.

The entire evaluation of the spatial peak values is performed within the post-processing engine (SEMCAD). The system always gives the maximum values for the 1g and 10g cubes. The algorithm to find the cube with highest averaged SAR is divided into the following stages:

- (a) Extraction of the measured data (grid and values) from the Zoom Scan
- (b) Calculation of the SAR value at every measurement point based on all stored data (A/D values and measurement parameters)
- (c) Generation of a high-resolution mesh within the measured volume
- (d) Interpolation of all measured values from the measurement grid to the high-resolution grid
- (e) Extrapolation of the entire 3-D field distribution to the phantom surface over the distance from sensor to surface
- (f) Calculation of the averaged SAR within masses of 1g and 10g



**7.2 Power Reference Measurement**

The Power Reference Measurement and Power Drift Measurements are for monitoring the power drift of the device under test in the batch process. The minimum distance of probe sensors to surface determines the closest measurement point to phantom surface. This distance cannot be smaller than the distance of sensor calibration points to probe tip as defined in the probe properties.

**7.3 Area Scan**

The area scan is used as a fast scan in two dimensions to find the area of high field values, before doing a fine measurement around the hot spot. The sophisticated interpolation routines implemented in DASY software can find the maximum found in the scanned area, within a range of the global maximum. The range (in dB0 is specified in the standards for compliance testing. For example, a 2 dB range is required in IEEE standard 1528 and IEC 62209 standards, whereby 3 dB is a requirement when compliance is assessed in accordance with the ARIB standard (Japan), if only one zoom scan follows the area scan, then only the absolute maximum will be taken as reference. For cases where multiple maximums are detected, the number of zoom scans has to be increased accordingly.

Area scan parameters extracted from FCC KDB 865664 D01v01r04 SAR measurement 100 MHz to 6 GHz.

	≤ 3 GHz	> 3 GHz
Maximum distance from closest measurement point (geometric center of probe sensors) to phantom surface	5 ± 1 mm	$\frac{1}{2} \cdot \delta \cdot \ln(2) \pm 0.5$ mm
Maximum probe angle from probe axis to phantom surface normal at the measurement location	30° ± 1°	20° ± 1°
Maximum area scan spatial resolution: $\Delta x_{Area}, \Delta y_{Area}$	≤ 2 GHz: ≤ 15 mm 2 – 3 GHz: ≤ 12 mm	3 – 4 GHz: ≤ 12 mm 4 – 6 GHz: ≤ 10 mm
	When the x or y dimension of the test device, in the measurement plane orientation, is smaller than the above, the measurement resolution must be ≤ the corresponding x or y dimension of the test device with at least one measurement point on the test device.	

**7.4 Zoom Scan**

Zoom scans are used assess the peak spatial SAR values within a cubic averaging volume containing 1 gram and 10 gram of simulated tissue. The zoom scan measures points (refer to table below) within a cube shoes base faces are centered on the maxima found in a preceding area scan job within the same procedure. When the measurement is done, the zoom scan evaluates the averaged SAR for 1 gram and 10 gram and displays these values next to the job's label.

Zoom scan parameters extracted from FCC KDB 865664 D01v01r04 SAR measurement 100 MHz to 6 GHz.

		≤ 3 GHz	> 3 GHz	
Maximum zoom scan spatial resolution: $\Delta x_{Zoom}, \Delta y_{Zoom}$		$\leq 2$ GHz: $\leq 8$ mm 2 – 3 GHz: $\leq 5$ mm*	3 – 4 GHz: $\leq 5$ mm* 4 – 6 GHz: $\leq 4$ mm*	
Maximum zoom scan spatial resolution, normal to phantom surface	uniform grid: $\Delta z_{Zoom}(n)$	$\leq 5$ mm	3 – 4 GHz: $\leq 4$ mm 4 – 5 GHz: $\leq 3$ mm 5 – 6 GHz: $\leq 2$ mm	
	graded grid	$\Delta z_{Zoom}(1)$ : between 1 <sup>st</sup> two points closest to phantom surface	$\leq 4$ mm	3 – 4 GHz: $\leq 3$ mm 4 – 5 GHz: $\leq 2.5$ mm 5 – 6 GHz: $\leq 2$ mm
		$\Delta z_{Zoom}(n>1)$ : between subsequent points	$\leq 1.5 \cdot \Delta z_{Zoom}(n-1)$	
Minimum zoom scan volume	x, y, z	$\geq 30$ mm	3 – 4 GHz: $\geq 28$ mm 4 – 5 GHz: $\geq 25$ mm 5 – 6 GHz: $\geq 22$ mm	
Note: $\delta$ is the penetration depth of a plane-wave at normal incidence to the tissue medium; see draft standard IEEE P1528-2011 for details. * When zoom scan is required and the <i>reported</i> SAR from the <i>area scan based 1-g SAR estimation</i> procedures of KDB 447498 is $\leq 1.4$ W/kg, $\leq 8$ mm, $\leq 7$ mm and $\leq 5$ mm zoom scan resolution may be applied, respectively, for 2 GHz to 3 GHz, 3 GHz to 4 GHz and 4 GHz to 6 GHz.				

**7.5 Volume Scan Procedures**

The volume scan is used for assess overlapping SAR distributions for antennas transmitting in different frequency bands. It is equivalent to an oversized zoom scan used in standalone measurements. The measurement volume will be used to enclose all the simultaneous transmitting antennas. For antennas transmitting simultaneously in different frequency bands, the volume scan is measured separately in each frequency band. In order to sum correctly to compute the 1g aggregate SAR, the EUT remain in the same test position for all measurements and all volume scan use the same spatial resolution and grid spacing. When all volume scan were completed, the software, SEMCAD postprocessor can combine and subsequently superpose these measurement data to calculating the multiband SAR.

**7.6 Power Drift Monitoring**

All SAR testing is under the EUT install full charged battery and transmit maximum output power. In DASY measurement software, the power reference measurement and power drift measurement procedures are used for monitoring the power drift of EUT during SAR test. Both these procedures measure the field at a specified reference position before and after the SAR testing. The software will calculate the field difference in dB. If the power drifts more than 5%, the SAR will be retested.



### 8. Test Equipment List

Manufacturer	Name of Equipment	Type/Model	Serial Number	Calibration	
				Last Cal.	Due Date
SPEAG	750MHz System Validation Kit	D750V3	1107	Mar. 08, 2019	Mar. 07, 2020
SPEAG	835MHz System Validation Kit	D835V2	4d167	Nov. 25, 2019	Nov. 24, 2020
SPEAG	1900MHz System Validation Kit	D1900V2	5d185	Mar. 07, 2019	Mar. 06, 2020
SPEAG	2450MHz System Validation Kit	D2450V2	736	Aug. 31, 2018	Aug. 29, 2020
SPEAG	5GHz System Validation Kit	D5GHzV2	1006	Sep. 27, 2018	Sep. 25, 2020
SPEAG	Data Acquisition Electronics	DAE3	495	May. 21, 2019	May. 20, 2020
SPEAG	Data Acquisition Electronics	DAE3	577	Sep. 17, 2019	Sep. 16, 2020
SPEAG	Dosimetric E-Field Probe	EX3DV4	3728	Feb. 04, 2020	Feb. 03, 2021
SPEAG	Dosimetric E-Field Probe	EX3DV4	7306	Jul. 22, 2019	Jul. 21, 2020
RCPTWN	Thermometer	HTC-1	TM685-1	Nov. 12, 2019	Nov. 11, 2020
RCPTWN	Thermometer	HTC-1	TM560-2	Nov. 12, 2019	Nov. 11, 2020
Anritsu	Radio Communication Analyzer	MT8821C	6201341950	Oct. 31, 2019	Oct. 30, 2020
Agilent	Wireless Communication Test Set	E5515C	MY50267236	Apr. 01, 2019	Mar. 31, 2020
R&S	BT Base Station	CBT32	100522	Mar. 18, 2019	Mar. 17, 2020
SPEAG	Device Holder	N/A	N/A	N/A	N/A
Anritsu	Signal Generator	MG3710A	6201502524	Nov. 20, 2019	Nov. 19, 2020
Agilent	ENA Network Analyzer	E5071C	MY46104758	Sep. 06, 2019	Sep. 05, 2020
SPEAG	Dielectric Probe Kit	DAK-3.5	1126	Sep. 18, 2019	Sep. 17, 2020
LINE SEIKI	Digital Thermometer	DTM3000-spezial	3169	Sep. 10, 2019	Sep. 09, 2020
Anritsu	Power Meter	ML2495A	1036004	Aug. 08, 2019	Aug. 07, 2020
Anritsu	Power Sensor	MA2411B	1027253	Aug. 08, 2019	Aug. 07, 2020
Anritsu	Power Meter	ML2495A	1419002	May. 29, 2019	May. 28, 2020
Anritsu	Power Sensor	MA2411B	1339124	May. 29, 2019	May. 28, 2020
Agilent	Spectrum Analyzer	E4408B	MY44211028	Aug. 27, 2019	Aug. 26, 2020
Anritsu	Spectrum Analyzer	MS2830A	6201396378	Jun. 27, 2019	Jun. 26, 2020
Mini-Circuits	Power Amplifier	ZVE-8G+	6418	Oct. 16, 2019	Oct. 15, 2020
Mini-Circuits	Power Amplifier	ZVE-8G+	6382	Aug. 12, 2019	Aug. 11, 2020
ATM	Dual Directional Coupler	C122H-10	P610410z-02	Note 1	
Woken	Attenuator 1	WK0602-XX	N/A	Note 1	
PE	Attenuator 2	PE7005-10	N/A	Note 1	
PE	Attenuator 3	PE7005-3	N/A	Note 1	

**General Note:**

1. Prior to system verification and validation, the path loss from the signal generator to the system check source and the power meter, which includes the amplifier, cable, attenuator and directional coupler, was measured by the network analyzer. The reading of the power meter was offset by the path loss difference between the path to the power meter and the path to the system check source to monitor the actual power level fed to the system check source.
2. Referring to KDB 865664 D01v01r04, the dipole calibration interval can be extended to 3 years with justification. The dipoles are also not physically damaged, or repaired during the interval.
3. The justification data of dipole D5GHzV2, SN: 1006, D2450V2, SN: 736 can be found in appendix C. The return loss is < -20dB, within 20% of prior calibration, the impedance is within 5 ohm of prior calibration.



## **9. System Verification**

### **9.1 Tissue Simulating Liquids**

For the measurement of the field distribution inside the SAM phantom with DASY, the phantom must be filled with around 25 liters of homogeneous body tissue simulating liquid. For head SAR testing, the liquid height from the ear reference point (ERP) of the phantom to the liquid top surface is larger than 15 cm, which is shown in Fig. 10.1. For body SAR testing, the liquid height from the center of the flat phantom to the liquid top surface is larger than 15 cm, which is shown in Fig. 10.2.

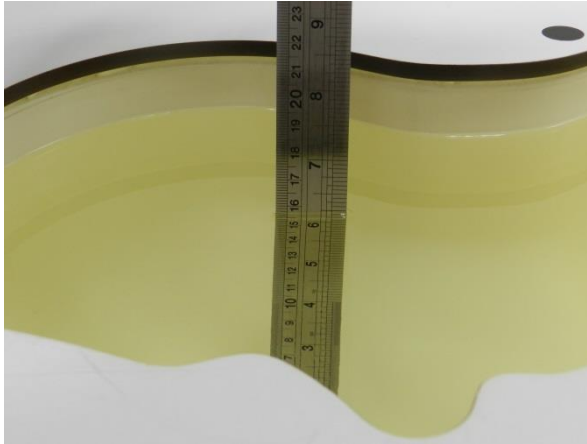

**Fig 10.1** Photo of Liquid Height for Head SAR

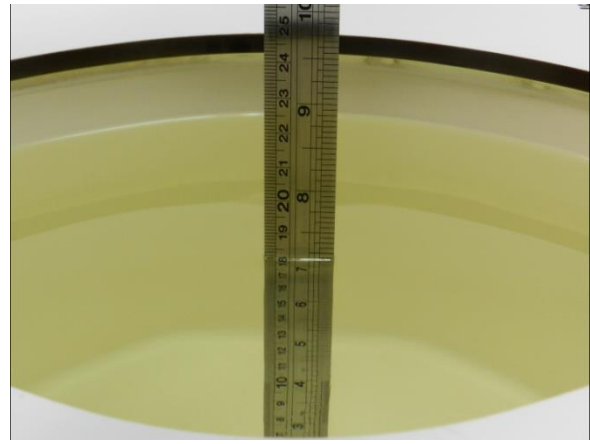

**Fig 10.2** Photo of Liquid Height for Body SAR



**9.2 Tissue Verification**

The following tissue formulations are provided for reference only as some of the parameters have not been thoroughly verified. The composition of ingredients may be modified accordingly to achieve the desired target tissue parameters required for routine SAR evaluation.

Frequency (MHz)	Water (%)	Sugar (%)	Cellulose (%)	Salt (%)	Preventol (%)	DGBE (%)	Conductivity ( $\sigma$ )	Permittivity ( $\epsilon_r$ )
750	41.1	57.0	0.2	1.4	0.2	0	0.89	41.9
835	40.3	57.9	0.2	1.4	0.2	0	0.90	41.5
900	40.3	57.9	0.2	1.4	0.2	0	0.97	41.5
1800, 1900, 2000	55.2	0	0	0.3	0	44.5	1.40	40.0
2450	55.0	0	0	0	0	45.0	1.80	39.2
2600	54.8	0	0	0.1	0	45.1	1.96	39.0

**Simulating Liquid for 5GHz, Manufactured by SPEAG**

Ingredients	(% by weight)
Water	64~78%
Mineral oil	11~18%
Emulsifiers	9~15%
Additives and Salt	2~3%

**<Tissue Dielectric Parameter Check Results>**

Frequency (MHz)	Liquid Temp. (°C)	Conductivity ( $\sigma$ )	Permittivity ( $\epsilon_r$ )	Conductivity Target ( $\sigma$ )	Permittivity Target ( $\epsilon_r$ )	Delta ( $\sigma$ ) (%)	Delta ( $\epsilon_r$ ) (%)	Limit (%)	Date
750	22.4	0.898	41.246	0.89	41.90	0.90	-1.56	±5	2020/3/5
835	22.4	0.894	42.284	0.90	41.50	-0.67	1.89	±5	2020/3/8
1900	22.4	1.403	40.614	1.40	40.00	0.21	1.53	±5	2020/3/6
2450	22.6	1.818	39.796	1.80	39.20	1.00	1.52	±5	2020/3/3
5250	22.6	4.665	36.313	4.71	35.95	-0.96	1.01	±5	2020/3/10
5600	22.6	5.002	35.853	5.07	35.50	-1.34	0.99	±5	2020/3/10

**9.3 System Performance Check Results**

Comparing to the original SAR value provided by SPEAG, the verification data should be within its specification of 10 %. Below table shows the target SAR and measured SAR after normalized to 1W input power. The table below indicates the system performance check can meet the variation criterion and the plots can be referred to Appendix A of this report.

Date	Frequency (MHz)	Input Power (mW)	Dipole S/N	Probe S/N	DAE S/N	Measured 1g SAR (W/kg)	Targeted 1g SAR (W/kg)	Normalized 1g SAR (W/kg)	Deviation (%)
2020/3/5	750	250	D750V3-1107	EX3DV4 - SN3728	DAE3 Sn495	2.12	8.32	8.48	1.92
2020/3/8	835	250	D835V2-4d167	EX3DV4 - SN3728	DAE3 Sn495	2.36	9.55	9.44	-1.15
2020/3/6	1900	250	D1900V2-5d185	EX3DV4 - SN3728	DAE3 Sn495	9.89	39.40	39.56	0.41
2020/3/3	2450	250	D2450V2-736	EX3DV4 - SN7306	DAE3 Sn577	14.10	52.70	56.4	7.02
2020/3/10	5250	100	D5GHzV2-1006-5250	EX3DV4 - SN7306	DAE3 Sn577	7.87	80.70	78.7	-2.48
2020/3/10	5600	100	D5GHzV2-1006-5600	EX3DV4 - SN7306	DAE3 Sn577	8.07	83.30	80.7	-3.12

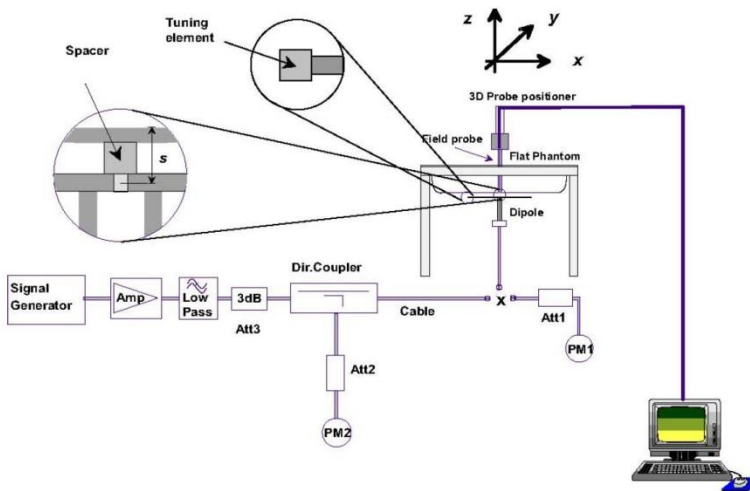

**Fig 8.3.1 System Performance Check Setup**



**Fig 8.3.2 Setup Photo**

## 10. RF Exposure Positions

### 10.1 Ear and handset reference point

Figure 9.1.1 shows the front, back, and side views of the SAM phantom. The center-of-mouth reference point is labeled “M,” the left ear reference point (ERP) is marked “LE,” and the right ERP is marked “RE.” Each ERP is 15 mm along the B-M (back-mouth) line behind the entrance-to-ear-canal (EEC) point, as shown in Figure 9.1.2 The Reference Plane is defined as passing through the two ear reference points and point M. The line N-F (neck-front), also called the reference pivoting line, is normal to the Reference Plane and perpendicular to both a line passing through RE and LE and the B-M line (see Figure 9.1.3). Both N-F and B-M lines should be marked on the exterior of the phantom shell to facilitate handset positioning. Posterior to the N-F line the ear shape is a flat surface with 6 mm thickness at each ERP, and forward of the N-F line the ear is truncated, as illustrated in Figure 9.1.2. The ear truncation is introduced to preclude the ear lobe from interfering with handset tilt, which could lead to unstable positioning at the cheek.

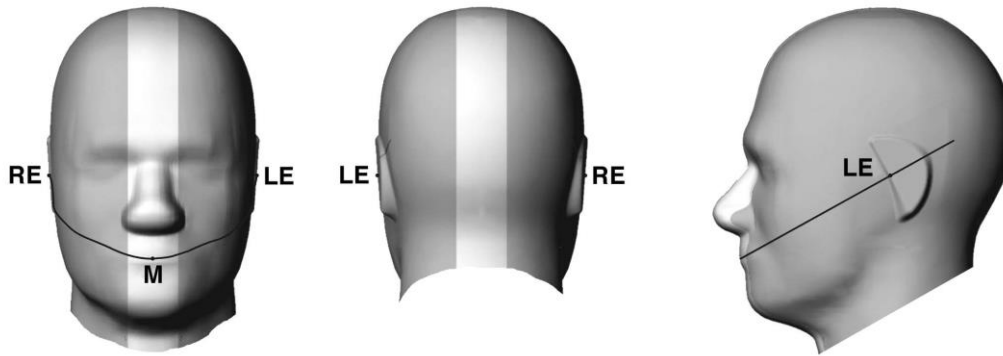

Fig 9.1.1 Front, back, and side views of SAM twin phantom

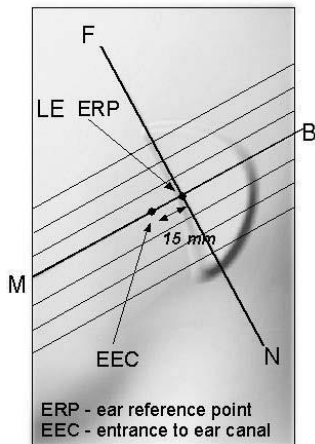

Fig 9.1.2 Close-up side view of phantom showing the ear region.

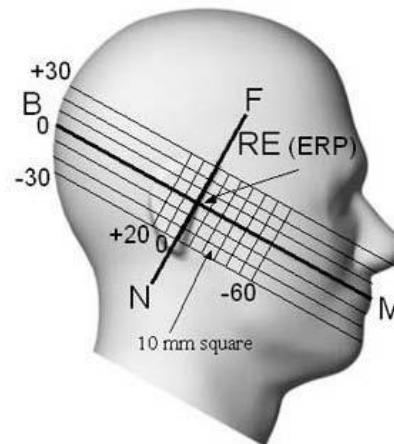
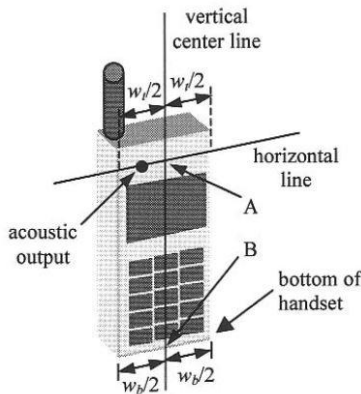

Fig 9.1.3 Side view of the phantom showing relevant markings and seven cross-sectional plane locations

**10.2 Definition of the cheek position**

1. Ready the handset for talk operation, if necessary. For example, for handsets with a cover piece (flip cover), open the cover. If the handset can transmit with the cover closed, both configurations must be tested.
2. Define two imaginary lines on the handset—the vertical centerline and the horizontal line. The vertical centerline passes through two points on the front side of the handset—the midpoint of the width  $w_t$  of the handset at the level of the acoustic output (point A in Figure 9.2.1 and Figure 9.2.2), and the midpoint of the width  $w_b$  of the bottom of the handset (point B). The horizontal line is perpendicular to the vertical centerline and passes through the center of the acoustic output (see Figure 9.2.1). The two lines intersect at point A. Note that for many handsets, point A coincides with the center of the acoustic output; however, the acoustic output may be located elsewhere on the horizontal line. Also note that the vertical centerline is not necessarily parallel to the front face of the handset (see Figure 9.2.2), especially for clamshell handsets, handsets with flip covers, and other irregularly-shaped handsets.
3. Position the handset close to the surface of the phantom such that point A is on the (virtual) extension of the line passing through points RE and LE on the phantom (see Figure 9.2.3), such that the plane defined by the vertical centerline and the horizontal line of the handset is approximately parallel to the sagittal plane of the phantom.
4. Translate the handset towards the phantom along the line passing through RE and LE until handset point A touches the pinna at the ERP.
5. While maintaining the handset in this plane, rotate it around the LE-RE line until the vertical centerline is in the plane normal to the plane containing B-M and N-F lines, i.e., the Reference Plane.
6. Rotate the handset around the vertical centerline until the handset (horizontal line) is parallel to the N-F line.
7. While maintaining the vertical centerline in the Reference Plane, keeping point A on the line passing through RE and LE, and maintaining the handset contact with the pinna, rotate the handset about the N-F line until any point on the handset is in contact with a phantom point below the pinna on the cheek. See Figure 9.2.3. The actual rotation angles should be documented in the test report.



**Fig 9.2.1 Handset vertical and horizontal reference lines—“fixed case”**

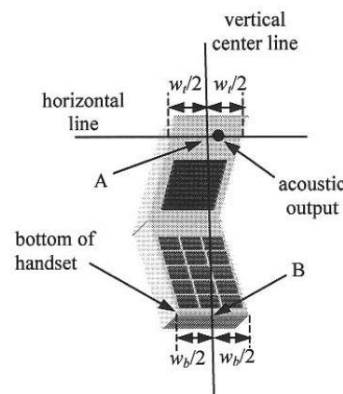

**Fig 9.2.2 Handset vertical and horizontal reference lines—“clam-shell case”**

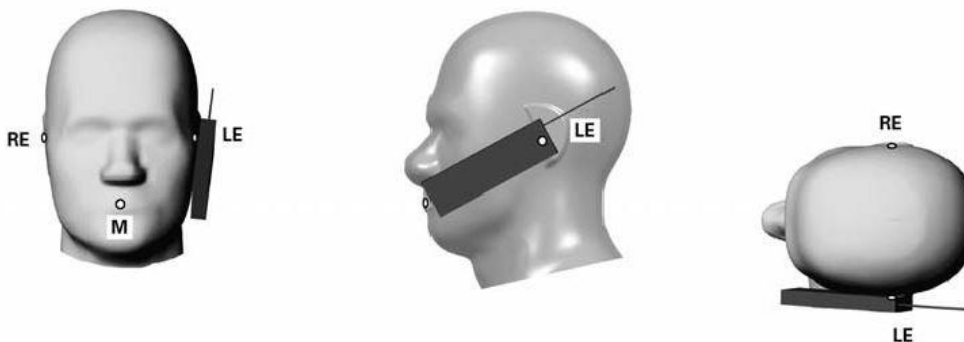

**Fig 9.2.3 cheek or touch position. The reference points for the right ear (RE), left ear (LE), and mouth (M), which establish the Reference Plane for handset positioning, are indicated.**

**10.3 Definition of the tilt position**

1. Ready the handset for talk operation, if necessary. For example, for handsets with a cover piece (flip cover), open the cover. If the handset can transmit with the cover closed, both configurations must be tested.
2. While maintaining the orientation of the handset, move the handset away from the pinna along the line passing through RE and LE far enough to allow a rotation of the handset away from the cheek by 15°.
3. Rotate the handset around the horizontal line by 15°.
4. While maintaining the orientation of the handset, move the handset towards the phantom on the line passing through RE and LE until any part of the handset touches the ear. The tilt position is obtained when the contact point is on the pinna. See Figure 9.3.1. If contact occurs at any location other than the pinna, e.g., the antenna at the back of the phantom head, the angle of the handset should be reduced. In this case, the tilt position is obtained if any point on the handset is in contact with the pinna and a second point

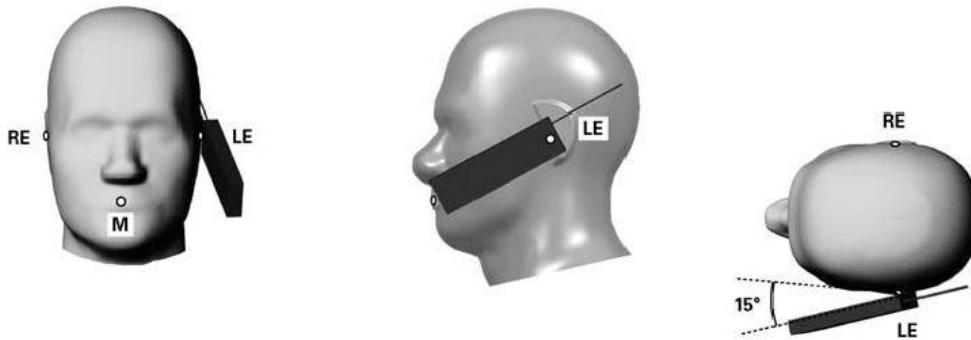
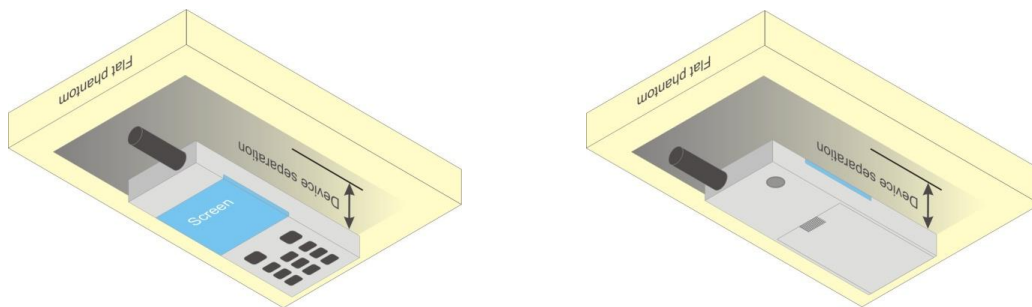

**Fig 9.3.1 Tilt position. The reference points for the right ear (RE), left ear (LE), and mouth (M), which define the Reference Plane for handset positioning, are indicated.**

**10.4 Body Worn Accessory**

Body-worn operating configurations are tested with the belt-clips and holsters attached to the device and positioned against a flat phantom in a normal use configuration (see Figure 9.4). Per KDB648474 D04v01r03, body-worn accessory exposure is typically related to voice mode operations when handsets are carried in body-worn accessories. The body-worn accessory procedures in FCC KDB 447498 D01v06 should be used to test for body-worn accessory SAR compliance, without a headset connected to it. This enables the test results for such configuration to be compatible with that required for hotspot mode when the body-worn accessory test separation distance is greater than or equal to that required for hotspot mode, when applicable. When the reported SAR for body-worn accessory, measured without a headset connected to the handset is > 1.2 W/kg, the highest reported SAR configuration for that wireless mode and frequency band should be repeated for that body-worn accessory with a headset attached to the handset.

Accessories for body-worn operation configurations are divided into two categories: those that do not contain metallic components and those that do contain metallic components. When multiple accessories that do not contain metallic components are supplied with the device, the device is tested with only the accessory that dictates the closest spacing to the body. Then multiple accessories that contain metallic components are test with the device with each accessory. If multiple accessories share an identical metallic component (i.e. the same metallic belt-chip used with different holsters with no other metallic components) only the accessory that dictates the closest spacing to the body is tested.



**Fig 9.4 Body Worn Position**

**10.5 Wireless Router**

Some battery-operated handsets have the capability to transmit and receive user through simultaneous transmission of WIFI simultaneously with a separate licensed transmitter. The FCC has provided guidance in FCC KDB Publication 941225 D06 v02r01 where SAR test considerations for handsets (L x W ≥ 9 cm x 5 cm) are based on a composite test separation distance of 10mm from the front, back and edges of the device containing transmitting antennas within 2.5cm of their edges, determined from general mixed use conditions for this type of devices. Since the hotspot SAR results may overlap with the body-worn accessory SAR requirements, the more conservative configurations can be considered, thus excluding some body-worn accessory SAR tests.

When the user enables the personal wireless router functions for the handset, actual operations include simultaneous transmission of both the WIFI transmitter and another licensed transmitter. Both transmitters often do not transmit at the same transmitting frequency and thus cannot be evaluated for SAR under actual use conditions due to the limitations of the SAR assessment probes. Therefore, SAR must be evaluated for each frequency transmission and mode separately and spatially summed with the WIFI transmitter according to FCC KDB Publication 447498 D01v06 publication procedures. The "Portable Hotspot" feature on the handset was NOT activated during SAR assessments, to ensure the SAR measurements were evaluated for a single transmission frequency RF signal at a time.

**11. GSM/UMTS/CDMA/LTE Output Power (Unit: dBm)**

**<GSM Conducted Power>**

**General Note:**

1. Per KDB 447498 D01v06, the maximum output power channel is used for SAR testing and for further SAR test reduction.
2. Per KDB 941225 D01v03r01, for SAR test reduction for GSM / GPRS modes is determined by the source-based time-averaged output power including tune-up tolerance. The mode with highest specified time-averaged output power should be tested for SAR compliance in the applicable exposure conditions. For modes with the same specified maximum output power and tolerance, the higher number time-slot configuration should be tested. Therefore, the GPRS (4Tx slots) for GSM850/GSM1900 is considered as the primary mode.
3. Other configurations of GSM / GPRS are considered as secondary modes. The 3G SAR test reduction procedure is applied, when the maximum output power and tune-up tolerance specified for production units in a secondary mode is  $\leq \frac{1}{4}$  dB higher than the primary mode, SAR measurement is not required for the secondary mode

GSM850 TX Channel	Burst Average Power (dBm)			Tune-up Limit (dBm)	Frame-Average Power (dBm)			Tune-up Limit (dBm)
	128	189	251		128	189	251	
Frequency (MHz)	824.2	836.4	848.8		824.2	836.4	848.8	
GSM 1 Tx slot	32.21	32.43	32.17	33.00	23.21	23.43	23.17	24.00
GPRS 1 Tx slot	32.30	32.35	32.12	33.00	23.30	23.35	23.12	24.00
GPRS 2 Tx slots	30.38	30.43	30.58	31.00	24.38	24.43	24.58	25.00
GPRS 3 Tx slots	28.72	28.84	28.64	29.00	24.46	24.58	24.38	24.74
GPRS 4 Tx slots	27.05	27.64	27.34	28.00	24.05	24.64	24.34	25.00

GSM1900 TX Channel	Burst Average Power (dBm)			Tune-up Limit (dBm)	Frame-Average Power (dBm)			Tune-up Limit (dBm)
	512	661	810		512	661	810	
Frequency (MHz)	1850.2	1880	1909.8		1850.2	1880	1909.8	
GSM 1 Tx slot	29.76	29.95	29.74	30.00	20.76	20.95	20.74	21.00
GPRS 1 Tx slot	29.77	29.93	29.72	30.00	20.77	20.93	20.72	21.00
GPRS 2 Tx slots	26.81	26.82	26.59	27.00	20.81	20.82	20.59	21.00
GPRS 3 Tx slots	24.93	24.71	24.64	25.00	20.67	20.45	20.38	20.74
GPRS 4 Tx slots	23.66	23.52	23.44	24.00	20.66	20.52	20.44	21.00



**<WCDMA Conducted Power>**

1. The following tests were conducted according to the test requirements outlines in 3GPP TS 34.121 specification.
2. The procedures in KDB 941225 D01v03r01 are applied for 3GPP Rel. 6 HSPA to configure the device in the required sub-test mode(s) to determine SAR test exclusion.

A summary of these settings are illustrated below:

**HSDPA Setup Configuration:**

- a. The EUT was connected to Base Station Agilent E5515C referred to the Setup Configuration.
- b. The RF path losses were compensated into the measurements.
- c. A call was established between EUT and Base Station with following setting:
  - i. Set Gain Factors ( $\beta_c$  and  $\beta_d$ ) and parameters were set according to each
  - ii. Specific sub-test in the following table, C10.1.4, quoted from the TS 34.121
  - iii. Set RMC 12.2Kbps + HSDPA mode.
  - iv. Set Cell Power = -86 dBm
  - v. Set HS-DSCH Configuration Type to FRC (H-set 1, QPSK)
  - vi. Select HSDPA Uplink Parameters
  - vii. Set Delta ACK, Delta NACK and Delta CQI = 8
  - viii. Set Ack-Nack Repetition Factor to 3
  - ix. Set CQI Feedback Cycle (k) to 4 ms
  - x. Set CQI Repetition Factor to 2
  - xi. Power Ctrl Mode = All Up bits
- d. The transmitted maximum output power was recorded.

**Table C.10.1.4:  $\beta$  values for transmitter characteristics tests with HS-DPCCH**

Sub-test	$\beta_c$	$\beta_d$	$\beta_d$ (SF)	$\beta_c/\beta_d$	$\beta_{HS}$ (Note 1, Note 2)	CM (dB) (Note 3)	MPR (dB) (Note 3)
1	2/15	15/15	64	2/15	4/15	0.0	0.0
2	12/15 (Note 4)	15/15 (Note 4)	64	12/15 (Note 4)	24/15	1.0	0.0
3	15/15	8/15	64	15/8	30/15	1.5	0.5
4	15/15	4/15	64	15/4	30/15	1.5	0.5

Note 1:  $\Delta_{ACK}, \Delta_{NACK}$  and  $\Delta_{CQI} = 30/15$  with  $\beta_{HS} = 30/15 * \beta_c$ .

Note 2: For the HS-DPCCH power mask requirement test in clause 5.2C, 5.7A, and the Error Vector Magnitude (EVM) with HS-DPCCH test in clause 5.13.1A, and HSDPA EVM with phase discontinuity in clause 5.13.1AA,  $\Delta_{ACK}$  and  $\Delta_{NACK} = 30/15$  with  $\beta_{HS} = 30/15 * \beta_c$ , and  $\Delta_{CQI} = 24/15$  with  $\beta_{HS} = 24/15 * \beta_c$ .

Note 3: CM = 1 for  $\beta_c/\beta_d = 12/15, \beta_{HS}/\beta_c = 24/15$ . For all other combinations of DPDCCH, DPCCH and HS-DPCCH the MPR is based on the relative CM difference. This is applicable for only UEs that support HSDPA in release 6 and later releases.

Note 4: For subtest 2 the  $\beta_c/\beta_d$  ratio of 12/15 for the TFC during the measurement period (TF1, TF0) is achieved by setting the signalled gain factors for the reference TFC (TF1, TF1) to  $\beta_c = 11/15$  and  $\beta_d = 15/15$ .

**Setup Configuration**

**HSUPA Setup Configuration:**

- a. The EUT was connected to Base Station Agilent E5515C referred to the Setup Configuration.
- b. The RF path losses were compensated into the measurements.
- c. A call was established between EUT and Base Station with following setting \* :
  - i. Call Configs = 5.2B, 5.9B, 5.10B, and 5.13.2B with QPSK
  - ii. Set the Gain Factors ( $\beta_c$  and  $\beta_d$ ) and parameters (AG Index) were set according to each specific sub-test in the following table, C11.1.3, quoted from the TS 34.121
  - iii. Set Cell Power = -86 dBm
  - iv. Set Channel Type = 12.2k + HSPA
  - v. Set UE Target Power
  - vi. Power Ctrl Mode= Alternating bits
  - vii. Set and observe the E-TFCl
  - viii. Confirm that E-TFCl is equal to the target E-TFCl of 75 for sub-test 1, and other subtest's E-TFCl
- d. The transmitted maximum output power was recorded.

**Table C.11.1.3:  $\beta$  values for transmitter characteristics tests with HS-DPCCH and E-DCH**

Sub-test	$\beta_c$	$\beta_d$	$\beta_d$ (SF)	$\beta_c/\beta_d$	$\beta_{HS}$ (Note1)	$\beta_{ec}$	$\beta_{ed}$ (Note 4) (Note 5)	$\beta_{ed}$ (SF)	$\beta_{ed}$ (Codes)	CM (dB) (Note 2)	MPR (dB) (Note 2) (Note 6)	AG Index (Note 5)	E-TFCl
1	11/15 (Note 3)	15/15 (Note 3)	64	11/15 (Note 3)	22/15	209/25	1309/225	4	1	1.0	0.0	20	75
2	6/15	15/15	64	6/15	12/15	12/15	94/75	4	1	3.0	2.0	12	67
3	15/15	9/15	64	15/9	30/15	30/15	$\beta_{ed1}: 47/15$ $\beta_{ed2}: 47/15$	4 4	2	2.0	1.0	15	92
4	2/15	15/15	64	2/15	4/15	2/15	56/75	4	1	3.0	2.0	17	71
5	15/15	0	-	-	5/15	5/15	47/15	4	1	1.0	0.0	12	67

Note 1: For sub-test 1 to 4,  $\Delta_{ACK}$ ,  $\Delta_{NACK}$  and  $\Delta_{CQI} = 30/15$  with  $\beta_{hs} = 30/15 * \beta_c$ . For sub-test 5,  $\Delta_{ACK}$ ,  $\Delta_{NACK}$  and  $\Delta_{CQI} = 5/15$  with  $\beta_{hs} = 5/15 * \beta_c$ .

Note 2: CM = 1 for  $\beta_c/\beta_d = 12/15$ ,  $\beta_{hs}/\beta_c = 24/15$ . For all other combinations of DPDCH, DPCCH, HS-DPCCH, E-DPDCH and E-DPCCH the MPR is based on the relative CM difference.

Note 3: For subtest 1 the  $\beta_c/\beta_d$  ratio of 11/15 for the TFC during the measurement period (TF1, TF0) is achieved by setting the signalled gain factors for the reference TFC (TF1, TF1) to  $\beta_c = 10/15$  and  $\beta_d = 15/15$ .

Note 4: In case of testing by UE using E-DPDCH Physical Layer category 1, Sub-test 3 is omitted according to TS25.306 Table 5.1g.

Note 5:  $\beta_{ed}$  can not be set directly; it is set by Absolute Grant Value.

Note 6: For subtests 2, 3 and 4, UE may perform E-DPDCH power scaling at max power which could results in slightly smaller MPR values.

**Setup Configuration**



**<WCDMA Conducted Power>**

**General Note:**

1. Per KDB 941225 D01v03r01, for SAR testing is measured using a 12.2 kbps RMC with TPC bits configured to all "1's".
2. Per KDB 941225 D01v03r01, RMC 12.2kbps setting is used to evaluate SAR. The maximum output power and tune-up tolerance specified for production units in HSDPA / HSUPA is  $\leq \frac{1}{4}$  dB higher than RMC 12.2Kbps or when the highest reported SAR of the RMC12.2Kbps is scaled by the ratio of specified maximum output power and tune-up tolerance of HSDPA / HSUPA to RMC12.2Kbps and the adjusted SAR is  $\leq 1.2$  W/kg, SAR measurement is not required for HSDPA / HSUPA, and according to the following RF output power, the output power results of the secondary modes (HSUPA, HSDPA) are less than  $\frac{1}{4}$  dB higher than the primary modes; therefore, SAR measurement is not required for HSDPA / HSUPA.

Band		WCDMA V			Tune-up Limit (dBm)
TX Channel		4132	4182	4233	
Rx Channel		4357	4407	4458	
Frequency (MHz)		826.4	836.4	846.6	
3GPP Rel 99	AMR 12.2Kbps	23.03	23.09	23.08	24.00
3GPP Rel 99	RMC 12.2Kbps	23.08	23.13	23.12	24.00
3GPP Rel 6	HSDPA Subtest-1	22.16	22.23	22.28	23.00
3GPP Rel 6	HSDPA Subtest-2	22.28	22.34	22.42	23.00
3GPP Rel 6	HSDPA Subtest-3	21.78	21.84	21.91	22.50
3GPP Rel 6	HSDPA Subtest-4	21.78	21.85	21.92	22.50
3GPP Rel 6	HSUPA Subtest-1	22.26	22.25	22.29	23.00
3GPP Rel 6	HSUPA Subtest-2	20.23	20.32	20.27	21.00
3GPP Rel 6	HSUPA Subtest-3	21.25	21.34	21.29	22.00
3GPP Rel 6	HSUPA Subtest-4	20.24	20.30	20.36	21.00
3GPP Rel 6	HSUPA Subtest-5	22.20	22.30	22.40	23.00



**<LTE Conducted Power>**

**General Note:**

1. Anritsu MT8820C base station simulator was used to setup the connection with EUT; the frequency band, channel bandwidth, RB allocation configuration, modulation type are set in the base station simulator to configure EUT transmitting at maximum power and at different configurations which are requested to be reported to FCC, for conducted power measurement and SAR testing.
2. Per KDB 941225 D05v02r05, when a properly configured base station simulator is used for the SAR and power measurements, spectrum plots for each RB allocation and offset configuration is not required.
3. Per KDB 941225 D05v02r05, start with the largest channel bandwidth and measure SAR for QPSK with 1 RB allocation, using the RB offset and required test channel combination with the highest maximum output power for RB offsets at the upper edge, middle and lower edge of each required test channel.
4. Per KDB 941225 D05v02r05, 50% RB allocation for QPSK SAR testing follows 1RB QPSK allocation procedure.
5. Per KDB 941225 D05v02r05, For QPSK with 100% RB allocation, SAR is not required when the highest maximum output power for 100 % RB allocation is less than the highest maximum output power in 50% and 1 RB allocations and the highest reported SAR for 1 RB and 50% RB allocation are  $\leq 0.8$  W/kg. Otherwise, SAR is measured for the highest output power channel; and if the reported SAR is  $> 1.45$  W/kg, the remaining required test channels must also be tested.
6. Per KDB 941225 D05v02r05, 16QAM output power for each RB allocation configuration is  $>$  not  $\frac{1}{2}$  dB higher than the same configuration in QPSK and the reported SAR for the QPSK configuration is  $\leq 1.45$  W/kg; Per KDB 941225 D05v02r05, 16QAM SAR testing is not required.
7. Per KDB 941225 D05v02r05, Smaller bandwidth output power for each RB allocation configuration is  $>$  not  $\frac{1}{2}$  dB higher than the same configuration in the largest supported bandwidth, and the reported SAR for the largest supported bandwidth is  $\leq 1.45$  W/kg; Per KDB 941225 D05v02r05, smaller bandwidth SAR testing is not required.
8. For LTE B5 / B12 / B17 the maximum bandwidth does not support three non-overlapping channels, per KDB 941225 D05v02r05, when a device supports overlapping channel assignment in a channel bandwidth configuration, the middle channel of the group of overlapping channels should be selected for testing.
9. LTE band 17 SAR test was covered by Band 12; according to April 2015 TCB workshop, SAR test for overlapping LTE bands can be reduced if
  - a. the maximum output power, including tolerance, for the smaller band is  $\leq$  the larger band to qualify for the SAR test exclusion
  - b. the channel bandwidth and other operating parameters for the smaller band are fully supported by the larger band



<LTE Band 5>

BW [MHz]	Modulation	RB Size	RB Offset	Power Low Ch. / Freq.	Power Middle Ch. / Freq.	Power High Ch. / Freq.	Tune-up limit (dBm)	MPR (dB)		
Channel				20450	20525	20600				
Frequency (MHz)				829	836.5	844				
10	QPSK	1	0	22.55	22.54	22.65	24	0		
10	QPSK	1	25	23.05	23.25	23.15				
10	QPSK	1	49	22.54	22.85	22.64				
10	QPSK	25	0	21.93	21.97	22.08	23	1		
10	QPSK	25	12	21.96	22.13	22.09				
10	QPSK	25	25	22.04	22.14	22.08				
10	QPSK	50	0	21.98	22.01	22.08	23	1		
10	16QAM	1	0	21.75	21.73	21.77				
10	16QAM	1	25	21.92	22.05	22.03				
10	16QAM	1	49	21.71	21.86	21.81	22	2		
10	16QAM	25	0	20.94	20.98	21.33				
10	16QAM	25	12	20.98	21.29	21.35				
10	16QAM	25	25	21.02	21.15	21.29	22	2		
10	16QAM	50	0	20.78	21.03	21.03				
Channel				20425	20525	20625			Tune-up limit (dBm)	MPR (dB)
Frequency (MHz)				826.5	836.5	846.5				
5	QPSK	1	0	22.58	22.81	22.60				
5	QPSK	1	12	23.19	23.20	23.12	24	0		
5	QPSK	1	24	22.46	22.77	22.54				
5	QPSK	12	0	21.93	22.00	22.02				
5	QPSK	12	7	21.99	22.06	22.10	23	1		
5	QPSK	12	13	21.93	21.99	22.03				
5	QPSK	25	0	21.93	22.04	22.00				
5	16QAM	1	0	21.68	21.67	21.73	23	1		
5	16QAM	1	12	21.64	21.80	21.71				
5	16QAM	1	24	21.65	21.79	21.66				
5	16QAM	12	0	20.95	20.72	20.94	22	2		
5	16QAM	12	7	21.12	21.17	21.02				
5	16QAM	12	13	20.96	21.00	21.04				
5	16QAM	25	0	20.95	21.05	21.21	22	2		
Channel				20415	20525	20635			Tune-up limit (dBm)	MPR (dB)
Frequency (MHz)				825.5	836.5	847.5				
3	QPSK	1	0	22.66	22.59	23.03				
3	QPSK	1	8	22.71	22.80	22.72	24	0		
3	QPSK	1	14	22.75	22.84	22.81				
3	QPSK	8	0	21.90	22.10	22.16				
3	QPSK	8	4	22.01	22.08	22.07	23	1		
3	QPSK	8	7	21.94	22.03	22.08				
3	QPSK	15	0	21.90	22.00	21.96				
3	16QAM	1	0	21.70	21.83	21.84	23	1		
3	16QAM	1	8	21.60	21.76	21.71				
3	16QAM	1	14	21.74	21.81	21.82				
3	16QAM	8	0	20.96	20.66	21.02	22	2		
3	16QAM	8	4	20.87	20.95	21.04				
3	16QAM	8	7	21.18	21.09	21.15				



**FCC SAR TEST REPORT**

**Report No. : FA8D1724-01**

3	16QAM	15	0	20.93	20.75	20.95		
Channel				20407	20525	20643	Tune-up limit (dBm)	MPR (dB)
Frequency (MHz)				824.7	836.5	848.3		
1.4	QPSK	1	0	22.64	22.87	22.96	24	0
1.4	QPSK	1	3	22.98	22.97	22.97		
1.4	QPSK	1	5	22.87	22.87	22.88		
1.4	QPSK	3	0	22.99	23.00	23.08		
1.4	QPSK	3	1	22.92	23.15	22.91		
1.4	QPSK	3	3	22.97	23.10	23.13		
1.4	QPSK	6	0	21.84	21.96	21.94	23	1
1.4	16QAM	1	0	21.72	21.80	21.83	23	1
1.4	16QAM	1	3	21.88	22.08	22.21		
1.4	16QAM	1	5	21.72	21.82	22.19		
1.4	16QAM	3	0	21.89	21.93	21.84		
1.4	16QAM	3	1	21.89	21.97	21.94		
1.4	16QAM	3	3	21.97	21.97	22.15		
1.4	16QAM	6	0	21.01	21.01	20.97	22	2



<LTE Band 12>

BW [MHz]	Modulation	RB Size	RB Offset	Power Low Ch. / Freq.	Power Middle Ch. / Freq.	Power High Ch. / Freq.	Tune-up limit (dBm)	MPR (dB)
Channel				23060	23095	23130		
Frequency (MHz)				704	707.5	711		
10	QPSK	1	0	22.69	22.80	22.72	24	0
10	QPSK	1	25	23.11	23.26	23.07		
10	QPSK	1	49	22.83	22.86	22.90		
10	QPSK	25	0	22.10	22.10	21.96	23	1
10	QPSK	25	12	22.08	22.14	22.02		
10	QPSK	25	25	21.98	22.08	22.02		
10	QPSK	50	0	22.10	22.15	22.04	23	1
10	16QAM	1	0	21.69	21.79	21.72		
10	16QAM	1	25	22.06	22.11	21.94		
10	16QAM	1	49	21.73	21.83	21.71	22	2
10	16QAM	25	0	21.29	21.04	21.05		
10	16QAM	25	12	21.01	21.08	20.96		
10	16QAM	25	25	21.21	20.99	21.04	22	2
10	16QAM	25	0	21.13	21.12	21.07		
10	16QAM	50	0	21.13	21.12	21.07		
Channel				23035	23095	23155		
Frequency (MHz)				701.5	707.5	713.5		
5	QPSK	1	0	22.67	22.56	22.45	24	0
5	QPSK	1	12	23.21	23.22	23.07		
5	QPSK	1	24	22.80	22.57	22.57		
5	QPSK	12	0	22.12	22.07	21.96	23	1
5	QPSK	12	7	22.21	22.18	22.00		
5	QPSK	12	13	22.14	22.11	22.07		
5	QPSK	25	0	22.14	22.14	21.96	23	1
5	16QAM	1	0	21.82	21.76	21.62		
5	16QAM	1	12	21.91	21.85	21.76		
5	16QAM	1	24	21.91	21.68	21.57	22	2
5	16QAM	12	0	21.07	21.01	21.06		
5	16QAM	12	7	21.14	21.16	21.12		
5	16QAM	12	13	21.08	21.02	20.89	22	2
5	16QAM	12	0	21.29	21.08	20.99		
5	16QAM	25	0	21.29	21.08	20.99		
Channel				23025	23095	23165		
Frequency (MHz)				700.5	707.5	714.5		
3	QPSK	1	0	22.92	22.63	22.79	24	0
3	QPSK	1	8	22.91	22.68	22.79		
3	QPSK	1	14	22.66	22.64	22.63		
3	QPSK	8	0	22.06	22.00	22.10	23	1
3	QPSK	8	4	22.21	22.24	22.02		
3	QPSK	8	7	22.12	22.16	22.01		
3	QPSK	15	0	22.22	22.03	21.99	23	1
3	16QAM	1	0	22.17	21.85	21.85		
3	16QAM	1	8	21.81	21.85	21.74		
3	16QAM	1	14	21.97	21.76	21.81	22	2
3	16QAM	8	0	21.08	21.02	21.03		
3	16QAM	8	4	21.11	21.01	21.08		
3	16QAM	8	7	21.20	21.12	21.07	22	2
3	16QAM	8	0	21.08	21.02	21.03		
3	16QAM	8	4	21.11	21.01	21.08		



**FCC SAR TEST REPORT**

**Report No. : FA8D1724-01**

3	16QAM	15	0	20.85	20.89	21.02		
Channel				23017	23095	23173	Tune-up limit (dBm)	MPR (dB)
Frequency (MHz)				699.7	707.5	715.3		
1.4	QPSK	1	0	23.00	22.93	22.82	24	0
1.4	QPSK	1	3	23.14	23.02	23.02		
1.4	QPSK	1	5	23.13	23.00	22.96		
1.4	QPSK	3	0	23.04	23.02	23.04		
1.4	QPSK	3	1	23.19	23.17	23.04		
1.4	QPSK	3	3	23.17	23.17	23.10		
1.4	QPSK	6	0	22.09	22.12	22.01	23	1
1.4	16QAM	1	0	21.94	21.88	21.84	23	1
1.4	16QAM	1	3	22.14	22.05	22.00		
1.4	16QAM	1	5	22.24	22.24	21.81		
1.4	16QAM	3	0	22.17	22.04	21.99		
1.4	16QAM	3	1	22.15	22.08	21.99		
1.4	16QAM	3	3	22.14	22.19	22.00		
1.4	16QAM	6	0	21.18	21.02	21.01	22	2





<LTE Band 17>

BW [MHz]	Modulation	RB Size	RB Offset	Power Low Ch. / Freq.	Power Middle Ch. / Freq.	Power High Ch. / Freq.	Tune-up limit (dBm)	MPR (dB)
Channel				23780	23790	23800		
Frequency (MHz)				709	710	711		
10	QPSK	1	0	22.69	22.64	22.61	24	0
10	QPSK	1	25	23.15	23.29	22.85		
10	QPSK	1	49	22.79	22.65	22.69		
10	QPSK	25	0	22.08	22.03	22.07	23	1
10	QPSK	25	12	22.12	22.08	22.00		
10	QPSK	25	25	22.12	22.01	22.00		
10	QPSK	50	0	22.11	22.02	22.03	23	1
10	16QAM	1	0	21.81	21.60	21.63		
10	16QAM	1	25	22.05	21.98	21.98		
10	16QAM	1	49	21.92	21.77	21.40	22	2
10	16QAM	25	0	21.01	21.05	20.89		
10	16QAM	25	12	21.05	20.98	21.14		
10	16QAM	25	25	21.34	21.23	21.04	22	2
10	16QAM	50	0	21.14	20.94	20.96		
Channel				23755	23790	23825		
Frequency (MHz)				706.5	710	713.5		
5	QPSK	1	0	22.67	22.49	22.45	24	0
5	QPSK	1	12	23.27	23.12	23.11		
5	QPSK	1	24	22.70	22.61	22.60		
5	QPSK	12	0	21.96	22.08	22.03	23	1
5	QPSK	12	7	21.98	22.10	21.99		
5	QPSK	12	13	22.05	22.05	21.96		
5	QPSK	25	0	22.00	22.03	21.96	23	1
5	16QAM	1	0	21.71	21.66	21.71		
5	16QAM	1	12	21.65	21.72	21.70		
5	16QAM	1	24	21.71	21.74	21.74	22	2
5	16QAM	12	0	20.76	20.70	20.77		
5	16QAM	12	7	21.02	20.73	21.01		
5	16QAM	12	13	20.93	20.83	20.94	22	2
5	16QAM	25	0	21.04	20.86	21.20		



## **12. WiFi/Bluetooth Output Power (Unit: dBm)**

### **General Note:**

1. Per KDB 248227 D01v02r02, SAR test reduction is determined according to 802.11 transmission mode configurations and certain exposure conditions with multiple test positions. In the 2.4 GHz band, separate SAR procedures are applied to DSSS and OFDM configurations to simplify DSSS test requirements. For OFDM, in both 2.4 and 5 GHz bands, an initial test configuration must be determined for each standalone and aggregated frequency band, according to the transmission mode configuration with the highest maximum output power specified for production units to perform SAR measurements. If the same highest maximum output power applies to different combinations of channel bandwidths, modulations and data rates, additional procedures are applied to determine which test configurations require SAR measurement. When applicable, an initial test position may be applied to reduce the number of SAR measurements required for next to the ear, UMPC mini-tablet or hotspot mode configurations with multiple test positions.
2. For 2.4 GHz 802.11b DSSS, either the initial test position procedure for multiple exposure test positions or the DSSS procedure for fixed exposure position is applied; these are mutually exclusive. For 2.4 GHz and 5 GHz OFDM configurations, the initial test configuration is applied to measure SAR using either the initial test position procedure for multiple exposure test position configurations or the initial test configuration procedures for fixed exposure test conditions. Based on the reported SAR of the measured configurations and maximum output power of the transmission mode configurations that are not included in the initial test configuration, the subsequent test configuration and initial test position procedures are applied to determine if SAR measurements are required for the remaining OFDM transmission configurations. In general, the number of test channels that require SAR measurement is minimized based on maximum output power measured for the test sample(s).
3. For OFDM transmission configurations in the 2.4 GHz and 5 GHz bands, When the same maximum power is specified for multiple transmission modes in a frequency band, the largest channel bandwidth, lowest order modulation, lowest data rate and lowest order 802.11a/g/n/ac mode is used for SAR measurement, on the highest measured output power channel for each frequency band.
4. DSSS and OFDM configurations are considered separately according to the required SAR procedures. SAR is measured in the initial test position using the 802.11 transmission mode configuration required by the DSSS procedure or initial test configuration and subsequent test configuration(s) according to the OFDM procedures.<sup>18</sup> The initial test position procedure is described in the following:
  - a. When the reported SAR of the initial test position is  $\leq 0.4$  W/kg, further SAR measurement is not required for the other test positions in that exposure configuration and 802.11 transmission mode combinations within the frequency band or aggregated band.
  - b. When the reported SAR of the test position is  $> 0.4$  W/kg, SAR is repeated for the 802.11 transmission mode configuration tested in the initial test position to measure the subsequent next closet/smallest test separation distance and maximum coupling test position on the highest maximum output power channel, until the report SAR is  $\leq 0.8$  W/kg or all required test position are tested.
  - c. For all positions/configurations, when the reported SAR is  $> 0.8$  W/kg, SAR is measured for these test positions/configurations on the subsequent next highest measured output power channel(s) until the reported SAR is  $\leq 1.2$  W/kg or all required channels are tested.



<2.4GHz WLAN>

	Mode	Channel	Frequency (MHz)	Average power (dBm)	Tune-Up Limit	Duty Cycle %
2.4GHz WLAN	802.11b 1Mbps	1	2412	16.52	17.00	100.00
		6	2437	16.44	17.00	
		11	2462	16.89	17.00	
	802.11g 6Mbps	1	2412	16.44	17.00	100.00
		6	2437	16.51	17.00	
		11	2462	16.86	17.00	
	802.11n-HT20 MCS0	1	2412	16.65	17.00	100.00
		6	2437	16.54	17.00	
		11	2462	16.81	17.00	

<5GHz WLAN>

	Mode	Channel	Frequency (MHz)	Average power (dBm)	Tune-Up Limit	Duty Cycle %
5.2GHz WLAN	802.11a 6Mbps	36	5180	12.54	13.00	100.00
		40	5200	12.58	13.00	
		44	5220	12.42	13.00	
		48	5240	12.41	13.00	
	802.11n-HT20 MCS0	36	5180	12.47	13.00	99.98
		40	5200	12.55	13.00	
		44	5220	12.53	13.00	
		48	5240	12.49	13.00	
	802.11n-HT40 MCS0	38	5190	12.61	13.00	99.97
		46	5230	12.58	13.00	
	802.11ac-VHT20 MCS0	36	5180	12.49	13.00	99.35
		40	5200	12.46	13.00	
		44	5220	12.89	13.00	
	802.11ac-VHT40 MCS0	48	5240	12.94	13.00	99.42
		38	5190	12.63	13.00	
	802.11ac-VHT80 MCS0	46	5230	12.55	13.00	97.08
42		5210	12.81	13.00		



	Mode	Channel	Frequency (MHz)	Average power (dBm)	Tune-Up Limit	Duty Cycle %
5.3GHz WLAN	802.11a 6Mbps	52	5260	12.48	13.00	100.00
		56	5280	12.45	13.00	
		60	5300	12.95	13.00	
		64	5320	12.44	13.00	
	802.11n-HT20 MCS0	52	5260	12.45	13.00	99.98
		56	5280	12.56	13.00	
		60	5300	12.73	13.00	
		64	5320	12.52	13.00	
	802.11n-HT40 MCS0	54	5270	12.61	13.00	99.97
		62	5310	12.63	13.00	
	802.11ac-VHT20 MCS0	52	5260	12.46	13.00	99.35
		56	5280	12.52	13.00	
		60	5300	12.76	13.00	
		64	5320	12.51	13.00	
	802.11ac-VHT40 MCS0	54	5270	12.64	13.00	99.42
		62	5310	12.69	13.00	
802.11ac-VHT80 MCS0	58	5290	12.51	13.00	97.08	



	Mode	Channel	Frequency (MHz)	Average power (dBm)	Tune-Up Limit	Duty Cycle %
5.5GHz WLAN	802.11a 6Mbps	100	5500	12.58	13.00	100.00
		116	5580	12.63	13.00	
		124	5620	12.41	13.00	
		132	5660	12.39	13.00	
		144	5720	12.38	13.00	
	802.11n-HT20 MCS0	100	5500	12.48	13.00	99.98
		116	5580	12.56	13.00	
		124	5620	12.53	13.00	
		132	5660	12.49	13.00	
		144	5720	12.35	13.00	
	802.11n-HT40 MCS0	102	5510	12.56	13.00	99.97
		110	5550	12.54	13.00	
		126	5630	12.51	13.00	
		134	5670	12.48	13.00	
		142	5710	12.39	13.00	
	802.11ac-VHT20 MCS0	100	5500	12.46	13.00	99.35
		116	5580	12.59	13.00	
		124	5620	12.52	13.00	
		132	5660	12.51	13.00	
		144	5720	12.31	13.00	
	802.11ac-VHT40 MCS0	102	5510	12.53	13.00	99.42
		110	5550	12.61	13.00	
		126	5630	12.54	13.00	
		134	5670	12.46	13.00	
142		5710	12.28	13.00		
802.11ac-VHT80 MCS0	106	5530	12.42	13.00	97.08	
	122	5610	12.52	13.00		
	138	5690	12.24	13.00		

**<2.4GHz Bluetooth>**

Mode	Channel	Frequency (MHz)	Average power (dBm)		
			1Mbps	2Mbps	3Mbps
BR / EDR	CH 00	2402	10.29	8.11	8.10
	CH 39	2441	9.69	7.62	7.62
	CH 78	2480	9.61	7.46	7.46
Tune-up Limit			10.50	10.50	10.50

Mode	Channel	Frequency (MHz)	Average power (dBm)
			GFSK
LE	CH 00	2402	0.51
	CH 19	2440	-0.40
	CH 39	2480	-0.10
Tune-up Limit			1.00

**General Note:**

- For 2.4GHz Bluetooth SAR testing was selected 1Mbps due to its highest average power and duty cycle is 78.8% considered in SAR testing, and the duty cycle would be scaled to theoretical 83.3% in reported SAR calculation.

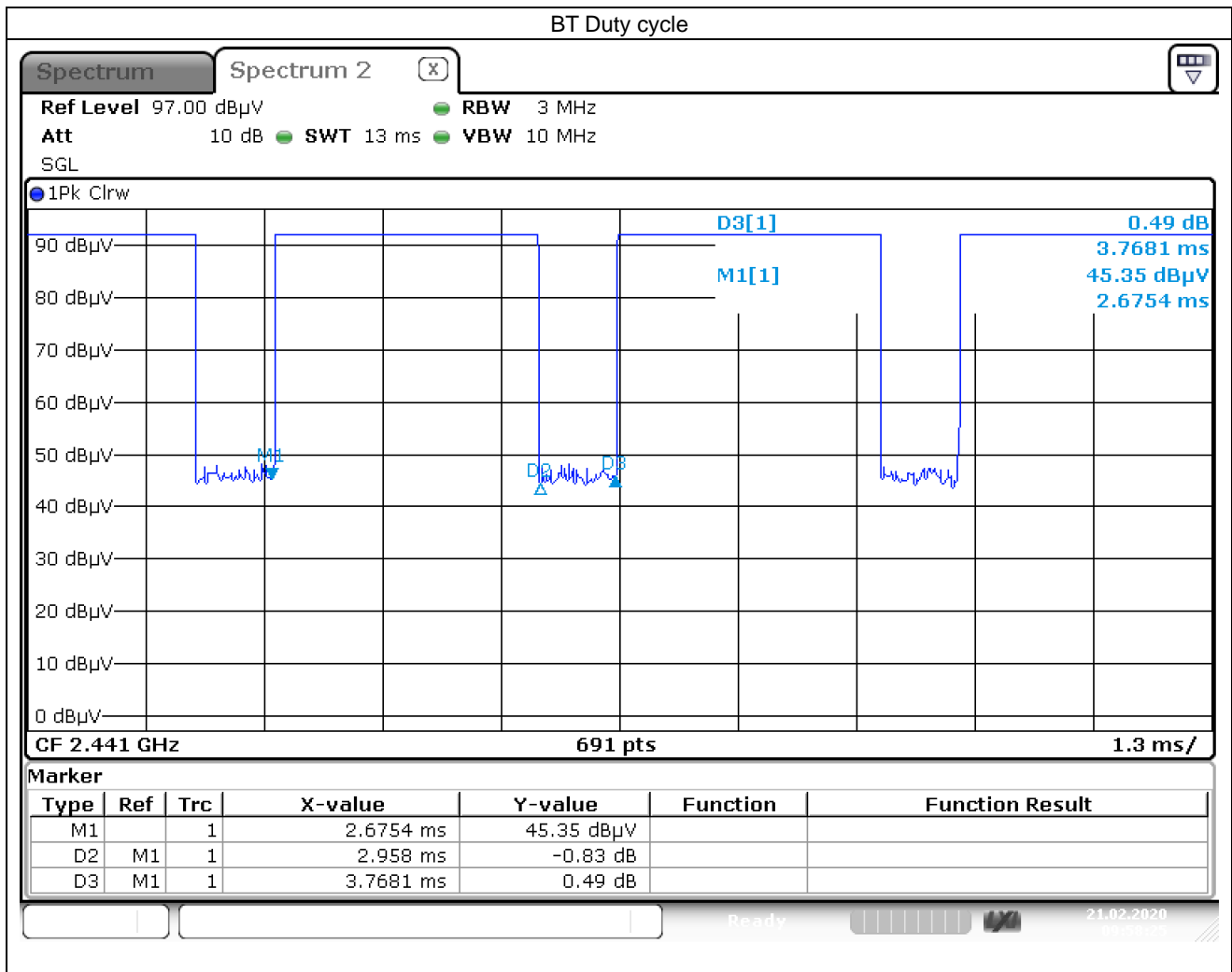

**13. RF exposure position consideration**

Distance of the Antenna to the EUT surface/edge						
Antennas	Back	Front	Top Side	Bottom Side	Right Side	Left Side
WWAN Main	≤ 25mm	≤ 25mm	>25mm	≤ 25mm	≤ 25mm	≤ 25mm
BT&WLAN	≤ 25mm	≤ 25mm	≤ 25mm	>25mm	≤ 25mm	>25mm

Positions for SAR tests; Hotspot mode						
Antennas	Back	Front	Top Side	Bottom Side	Right Side	Left Side
WWAN Main	Yes	Yes	No	Yes	Yes	Yes
BT&WLAN	Yes	Yes	Yes	No	Yes	No

**General Note:**

1. The detail antenna location refers to appendix D.
2. Referring to KDB 941225 D06 v02r01, when the overall device length and width are ≥ 9cm\*5cm, the test distance is 10 mm. SAR must be measured for all sides and surfaces with a transmitting antenna located within 25mm from that surface or edge

**14. SAR Test Results**

**General Note:**

1. Per KDB 447498 D01v06, the reported SAR is the measured SAR value adjusted for maximum tune-up tolerance.
  - a. Tune-up scaling Factor = tune-up limit power (mW) / EUT RF power (mW), where tune-up limit is the maximum rated power among all production units.
  - b. For SAR testing of WLAN signal with non-100% duty cycle, the measured SAR is scaled-up by the duty cycle scaling factor which is equal to "1/(duty cycle)"
  - c. For WWAN: Reported SAR(W/kg)= Measured SAR(W/kg)\*Tune-up Scaling Factor
  - d. For WLAN/Bluetooth: Reported SAR(W/kg)= Measured SAR(W/kg)\* Duty Cycle scaling factor \* Tune-up scaling factor
2. Per KDB 447498 D01v06, for each exposure position, testing of other required channels within the operating mode of a frequency band is not required when the *reported* 1-g or 10-g SAR for the mid-band or highest output power channel is:
  - ≤ 0.8 W/kg or 2.0 W/kg, for 1-g or 10-g respectively, when the transmission band is ≤ 100 MHz
  - ≤ 0.6 W/kg or 1.5 W/kg, for 1-g or 10-g respectively, when the transmission band is between 100 MHz and 200 MHz
  - ≤ 0.4 W/kg or 1.0 W/kg, for 1-g or 10-g respectively, when the transmission band is ≥ 200 MHz
3. Per KDB 865664 D01v01r04, for each frequency band, repeated SAR measurement is required only when the measured SAR is ≥0.8W/kg.
4. Per KDB 648474 D04v01r03, when the reported SAR for a body-worn accessory measured without a headset connected to the handset is ≤ 1.2 W/kg, SAR testing with a headset connected to the handset is not required.

**GSM Note:**

1. Per KDB 941225 D01v03r01, for SAR test reduction for GSM / GPRS modes is determined by the source-based time-averaged output power including tune-up tolerance. The mode with highest specified time-averaged output power should be tested for SAR compliance in the applicable exposure conditions. For modes with the same specified maximum output power and tolerance, the higher number time-slot configuration should be tested. Therefore, the GPRS (4Tx slots) for GSM850/GSM1900 is considered as the primary mode.
2. Other configurations of GSM / GPRS are considered as secondary modes. The 3G SAR test reduction procedure is applied, when the maximum output power and tune-up tolerance specified for production units in a secondary mode is ≤ ¼ dB higher than the primary mode, SAR measurement is not required for the secondary mode.

**UMTS Note:**

1. Per KDB 941225 D01v03r01, for SAR testing is measured using a 12.2 kbps RMC with TPC bits configured to all "1's".
2. Per KDB 941225 D01v03r01, RMC 12.2kbps setting is used to evaluate SAR. The maximum output power and tune-up tolerance specified for production units in HSDPA / HSUPA is  $\leq \frac{1}{4}$  dB higher than RMC 12.2Kbps or when the highest reported SAR of the RMC12.2Kbps is scaled by the ratio of specified maximum output power and tune-up tolerance of HSDPA / HSUPA to RMC12.2Kbps and the adjusted SAR is  $\leq 1.2$  W/kg, SAR measurement is not required for HSDPA / HSUPA, and according to the following RF output power, the output power results of the secondary modes (HSUPA, HSDPA, DC-HSDPA) are less than  $\frac{1}{4}$  dB higher than the primary modes; therefore, SAR measurement is not required for HSDPA / HSUPA.

**LTE Note:**

1. Per KDB 941225 D05v02r05, start with the largest channel bandwidth and measure SAR for QPSK with 1 RB allocation, using the RB offset and required test channel combination with the highest maximum output power for RB offsets at the upper edge, middle and lower edge of each required test channel.
2. Per KDB 941225 D05v02r05, 50% RB allocation for QPSK SAR testing follows 1RB QPSK allocation procedure.
3. Per KDB 941225 D05v02r05, For QPSK with 100% RB allocation, SAR is not required when the highest maximum output power for 100 % RB allocation is less than the highest maximum output power in 50% and 1 RB allocations and the highest reported SAR for 1 RB and 50% RB allocation are  $\leq 0.8$  W/kg. Otherwise, SAR is measured for the highest output power channel; and if the reported SAR is  $> 1.45$  W/kg, the remaining required test channels must also be tested.
4. Per KDB 941225 D05v02r05, 16QAM output power for each RB allocation configuration is  $>$  not  $\frac{1}{2}$  dB higher than the same configuration in QPSK and the reported SAR for the QPSK configuration is  $\leq 1.45$  W/kg; Per KDB 941225 D05v02r05, 16QAM SAR testing is not required.
5. Per KDB 941225 D05v02r05, Smaller bandwidth output power for each RB allocation configuration is  $>$  not  $\frac{1}{2}$  dB higher than the same configuration in the largest supported bandwidth, and the reported SAR for the largest supported bandwidth is  $\leq 1.45$  W/kg; Per KDB 941225 D05v02r05, smaller bandwidth SAR testing is not required.
6. For LTE B12 / B5 / B17 the maximum bandwidth does not support three non-overlapping channels, per KDB 941225 D05v02r05, when a device supports overlapping channel assignment in a channel bandwidth configuration, the middle channel of the group of overlapping channels should be selected for testing.
7. LTE band 17 SAR test was covered by Band 12; according to TCB workshop, SAR test for overlapping LTE bands can be reduced if
  - a. The maximum output power, including tolerance, for the smaller band is  $\leq$  the larger band to qualify for the SAR test exclusion.
  - b. The channel bandwidth and other operating parameters for the smaller band are fully supported by the larger band.

**WLAN Note:**

1. Per KDB 248227 D01v02r02, for 2.4GHz 802.11g/n SAR testing is not required when the highest reported SAR for DSSS is adjusted by the ratio of OFDM to DSSS specified maximum output power and the adjusted SAR is  $\leq 1.2$  W/kg.
2. Per KDB 248227 D01v02r02, U-NII-1 SAR testing is not required when the U-NII-2A band highest reported SAR for a test configuration is  $\leq 1.2$  W/kg, SAR is not required for U-NII-1 band.
3. When the reported SAR of the test position is  $> 0.4$  W/kg, SAR is repeated for the 802.11 transmission mode configuration tested in the initial test position to measure the subsequent next closest/smallest test separation distance and maximum coupling test position on the highest maximum output power channel, until the report SAR is  $\leq 0.8$  W/kg or all required test position are tested.
4. For all positions / configurations, when the reported SAR is  $> 0.8$  W/kg, SAR is measured for these test positions / configurations on the subsequent next highest measured output power channel(s) until the reported SAR is  $\leq 1.2$  W/kg or all required channels are tested.
5. During SAR testing the WLAN transmission was verified using a spectrum analyzer.



**14.1 Head SAR**
**<GSM SAR>**

Plot No.	Band	Mode	Test Position	Gap (mm)	Ch.	Freq. (MHz)	Average Power (dBm)	Tune-Up Limit (dBm)	Tune-up Scaling Factor	Power Drift (dB)	Measured 1g SAR (W/kg)	Reported 1g SAR (W/kg)
01	GSM850	GPRS (4 Tx slots)	Right Cheek	0mm	189	836.4	27.64	28.00	1.086	0.1	0.144	0.156
	GSM850	GPRS (4 Tx slots)	Right Tilted	0mm	189	836.4	27.64	28.00	1.086	0.05	0.084	0.091
	GSM850	GPRS (4 Tx slots)	Left Cheek	0mm	189	836.4	27.64	28.00	1.086	0.01	0.122	0.133
	GSM850	GPRS (4 Tx slots)	Left Tilted	0mm	189	836.4	27.64	28.00	1.086	0.02	0.073	0.079
	GSM1900	GPRS (4 Tx slots)	Right Cheek	0mm	512	1850.2	23.66	24.00	1.081	0.15	0.075	0.081
	GSM1900	GPRS (4 Tx slots)	Right Tilted	0mm	512	1850.2	23.66	24.00	1.081	-0.08	0.001	0.001
02	GSM1900	GPRS (4 Tx slots)	Left Cheek	0mm	512	1850.2	23.66	24.00	1.081	-0.13	0.137	0.148
	GSM1900	GPRS (4 Tx slots)	Left Tilted	0mm	512	1850.2	23.66	24.00	1.081	-0.11	0.050	0.054

**<WCDMA SAR>**

Plot No.	Band	Mode	Test Position	Gap (mm)	Ch.	Freq. (MHz)	Average Power (dBm)	Tune-Up Limit (dBm)	Tune-up Scaling Factor	Power Drift (dB)	Measured 1g SAR (W/kg)	Reported 1g SAR (W/kg)
03	WCDMA V	RMC 12.2Kbps	Right Cheek	0mm	4182	836.4	23.13	24.00	1.222	-0.13	0.218	0.266
	WCDMA V	RMC 12.2Kbps	Right Tilted	0mm	4182	836.4	23.13	24.00	1.222	0.07	0.132	0.161
	WCDMA V	RMC 12.2Kbps	Left Cheek	0mm	4182	836.4	23.13	24.00	1.222	-0.03	0.183	0.224
	WCDMA V	RMC 12.2Kbps	Left Tilted	0mm	4182	836.4	23.13	24.00	1.222	-0.18	0.127	0.155

**<LTE SAR>**

Plot No.	Band	BW (MHz)	Modulation	RB Size	RB offset	Test Position	Gap (mm)	Ch.	Freq. (MHz)	Average Power (dBm)	Tune-Up Limit (dBm)	Tune-up Scaling Factor	Power Drift (dB)	Measured 1g SAR (W/kg)	Reported 1g SAR (W/kg)
04	LTE Band 5	10M	QPSK	1	25	Right Cheek	0mm	20525	836.5	23.25	24.00	1.189	0.01	0.235	0.279
	LTE Band 5	10M	QPSK	25	25	Right Cheek	0mm	20525	836.5	22.14	23.00	1.219	-0.06	0.195	0.238
	LTE Band 5	10M	QPSK	1	25	Right Tilted	0mm	20525	836.5	23.25	24.00	1.189	0.02	0.136	0.162
	LTE Band 5	10M	QPSK	25	25	Right Tilted	0mm	20525	836.5	22.14	23.00	1.219	0.04	0.110	0.134
	LTE Band 5	10M	QPSK	1	25	Left Cheek	0mm	20525	836.5	23.25	24.00	1.189	-0.09	0.206	0.245
	LTE Band 5	10M	QPSK	25	25	Left Cheek	0mm	20525	836.5	22.14	23.00	1.219	-0.12	0.167	0.204
	LTE Band 5	10M	QPSK	1	25	Left Tilted	0mm	20525	836.5	23.25	24.00	1.189	0.18	0.136	0.162
	LTE Band 5	10M	QPSK	25	25	Left Tilted	0mm	20525	836.5	22.14	23.00	1.219	0.13	0.110	0.134
05	LTE Band 12	10M	QPSK	1	25	Right Cheek	0mm	23095	707.5	23.26	24.00	1.186	0.13	0.030	0.036
	LTE Band 12	10M	QPSK	25	12	Right Cheek	0mm	23095	707.5	22.14	23.00	1.219	0.06	0.023	0.028
	LTE Band 12	10M	QPSK	1	25	Right Tilted	0mm	23095	707.5	23.26	24.00	1.186	-0.06	0.015	0.018
	LTE Band 12	10M	QPSK	25	12	Right Tilted	0mm	23095	707.5	22.14	23.00	1.219	-0.04	0.011	0.013
	LTE Band 12	10M	QPSK	1	25	Left Cheek	0mm	23095	707.5	23.26	24.00	1.186	-0.12	0.025	0.030
	LTE Band 12	10M	QPSK	25	12	Left Cheek	0mm	23095	707.5	22.14	23.00	1.219	0.09	0.021	0.026
	LTE Band 12	10M	QPSK	1	25	Left Tilted	0mm	23095	707.5	23.26	24.00	1.186	0.07	0.007	0.008
	LTE Band 12	10M	QPSK	25	12	Left Tilted	0mm	23095	707.5	22.14	23.00	1.219	0.01	0.004	0.005



<WLAN SAR>

Plot No.	Band	Mode	Test Position	Gap (mm)	Ch.	Freq. (MHz)	Average Power (dBm)	Tune-Up Limit (dBm)	Tune-up Scaling Factor	Duty Cycle %	Duty Cycle Scaling Factor	Power Drift (dB)	Measured 1g SAR (W/kg)	Reported 1g SAR (W/kg)
	WLAN2.4GHz	802.11b 1Mbps	Right Cheek	0mm	11	2462	16.89	17.00	1.026	100	1.000	-0.03	0.636	0.652
	WLAN2.4GHz	802.11b 1Mbps	Right Tilted	0mm	11	2462	16.89	17.00	1.026	100	1.000	0.02	0.689	0.707
	WLAN2.4GHz	802.11b 1Mbps	Left Cheek	0mm	11	2462	16.89	17.00	1.026	100	1.000	0.06	0.906	0.929
06	WLAN2.4GHz	802.11b 1Mbps	Left Cheek	0mm	1	2412	16.52	17.00	1.117	100	1.000	-0.05	0.839	0.937
	WLAN2.4GHz	802.11b 1Mbps	Left Cheek	0mm	6	2437	16.44	17.00	1.138	100	1.000	0.03	0.717	0.816
	WLAN2.4GHz	802.11b 1Mbps	Left Tilted	0mm	11	2462	16.89	17.00	1.026	100	1.000	-0.15	0.845	0.867
	WLAN2.4GHz	802.11b 1Mbps	Left Tilted	0mm	1	2412	16.52	17.00	1.117	100	1.000	0.06	0.784	0.876
	WLAN2.4GHz	802.11b 1Mbps	Left Tilted	0mm	6	2437	16.44	17.00	1.138	100	1.000	0.13	0.652	0.742
	WLAN5GHz	802.11ac-VHT80 MCS0	Right Cheek	0mm	58	5290	12.51	13.00	1.119	97.08	1.030	0.05	0.231	0.266
	WLAN5GHz	802.11ac-VHT80 MCS0	Right Tilted	0mm	58	5290	12.51	13.00	1.119	97.08	1.030	0.02	0.207	0.239
07	WLAN5GHz	802.11ac-VHT80 MCS0	Left Cheek	0mm	58	5290	12.51	13.00	1.119	97.08	1.030	-0.01	0.323	0.372
	WLAN5GHz	802.11ac-VHT80 MCS0	Left Tilted	0mm	58	5290	12.51	13.00	1.119	97.08	1.030	-0.09	0.242	0.279
	WLAN5GHz	802.11ac-VHT80 MCS0	Right Cheek	0mm	122	5610	12.52	13.00	1.117	97.08	1.030	0.08	0.211	0.243
	WLAN5GHz	802.11ac-VHT80 MCS0	Right Tilted	0mm	122	5610	12.52	13.00	1.117	97.08	1.030	0.11	0.203	0.234
08	WLAN5GHz	802.11ac-VHT80 MCS0	Left Cheek	0mm	122	5610	12.52	13.00	1.117	97.08	1.030	0.19	0.329	0.378
	WLAN5GHz	802.11ac-VHT80 MCS0	Left Tilted	0mm	122	5610	12.52	13.00	1.117	97.08	1.030	0.09	0.198	0.228

<Bluetooth SAR>

Plot No.	Band	Mode	Test Position	Gap (mm)	Ch.	Freq. (MHz)	Average Power (dBm)	Tune-Up Limit (dBm)	Tune-up Scaling Factor	Duty Cycle %	Duty Cycle Scaling Factor	Power Drift (dB)	Measured 1g SAR (W/kg)	Reported 1g SAR (W/kg)
	Bluetooth	1Mbps	Right Cheek	0mm	0	2402	10.29	10.50	1.050	78.8	1.057	0.03	0.158	0.175
	Bluetooth	1Mbps	Right Tilted	0mm	0	2402	10.29	10.50	1.050	78.8	1.057	-0.05	0.143	0.159
09	Bluetooth	1Mbps	Left Cheek	0mm	0	2402	10.29	10.50	1.050	78.8	1.057	0.01	0.169	0.187
	Bluetooth	1Mbps	Left Tilted	0mm	0	2402	10.29	10.50	1.050	78.8	1.057	0.09	0.155	0.172



**14.2 Hotspot SAR**

**<GSM SAR>**

Plot No.	Band	Mode	Test Position	Gap (mm)	Ch.	Freq. (MHz)	Average Power (dBm)	Tune-Up Limit (dBm)	Tune-up Scaling Factor	Power Drift (dB)	Measured 1g SAR (W/kg)	Reported 1g SAR (W/kg)
	GSM850	GPRS (4 Tx slots)	Front	10mm	189	836.4	27.64	28.00	1.086	-0.03	0.107	0.116
10	GSM850	GPRS (4 Tx slots)	Back	10mm	189	836.4	27.64	28.00	1.086	0.11	0.187	0.203
	GSM850	GPRS (4 Tx slots)	Left Side	10mm	189	836.4	27.64	28.00	1.086	0.02	0.073	0.079
	GSM850	GPRS (4 Tx slots)	Right Side	10mm	189	836.4	27.64	28.00	1.086	0.03	0.049	0.053
	GSM850	GPRS (4 Tx slots)	Bottom Side	10mm	189	836.4	27.64	28.00	1.086	0.07	0.045	0.049
	GSM1900	GPRS (4 Tx slots)	Front	10mm	512	1850.2	23.66	24.00	1.081	-0.17	0.132	0.143
11	GSM1900	GPRS (4 Tx slots)	Back	10mm	512	1850.2	23.66	24.00	1.081	0.07	0.266	0.288
	GSM1900	GPRS (4 Tx slots)	Left Side	10mm	512	1850.2	23.66	24.00	1.081	-0.11	0.098	0.106
	GSM1900	GPRS (4 Tx slots)	Right Side	10mm	512	1850.2	23.66	24.00	1.081	-0.06	0.045	0.049
	GSM1900	GPRS (4 Tx slots)	Bottom Side	10mm	512	1850.2	23.66	24.00	1.081	-0.01	0.260	0.281

**<WCDMA SAR>**

Plot No.	Band	Mode	Test Position	Gap (mm)	Ch.	Freq. (MHz)	Average Power (dBm)	Tune-Up Limit (dBm)	Tune-up Scaling Factor	Power Drift (dB)	Measured 1g SAR (W/kg)	Reported 1g SAR (W/kg)
	WCDMA V	RMC 12.2Kbps	Front	10mm	4182	836.4	23.13	24.00	1.222	0.05	0.190	0.232
12	WCDMA V	RMC 12.2Kbps	Back	10mm	4182	836.4	23.13	24.00	1.222	0.04	0.297	0.363
	WCDMA V	RMC 12.2Kbps	Left Side	10mm	4182	836.4	23.13	24.00	1.222	0.08	0.109	0.133
	WCDMA V	RMC 12.2Kbps	Right Side	10mm	4182	836.4	23.13	24.00	1.222	-0.08	0.147	0.180
	WCDMA V	RMC 12.2Kbps	Bottom Side	10mm	4182	836.4	23.13	24.00	1.222	-0.05	0.075	0.092

**<LTE SAR>**

Plot No.	Band	BW (MHz)	Modulation	RB Size	RB offset	Test Position	Gap (mm)	Ch.	Freq. (MHz)	Average Power (dBm)	Tune-Up Limit (dBm)	Tune-up Scaling Factor	Power Drift (dB)	Measured 1g SAR (W/kg)	Reported 1g SAR (W/kg)
	LTE Band 5	10M	QPSK	1	25	Front	10mm	20525	836.5	23.25	24.00	1.189	0.19	0.193	0.229
	LTE Band 5	10M	QPSK	25	25	Front	10mm	20525	836.5	22.14	23.00	1.219	-0.05	0.162	0.197
13	LTE Band 5	10M	QPSK	1	25	Back	10mm	20525	836.5	23.25	24.00	1.189	-0.06	0.303	0.360
	LTE Band 5	10M	QPSK	25	25	Back	10mm	20525	836.5	22.14	23.00	1.219	-0.17	0.253	0.308
	LTE Band 5	10M	QPSK	1	25	Left Side	10mm	20525	836.5	23.25	24.00	1.189	0.02	0.116	0.138
	LTE Band 5	10M	QPSK	25	25	Left Side	10mm	20525	836.5	22.14	23.00	1.219	-0.13	0.108	0.132
	LTE Band 5	10M	QPSK	1	25	Right Side	10mm	20525	836.5	23.25	24.00	1.189	0.05	0.145	0.172
	LTE Band 5	10M	QPSK	25	25	Right Side	10mm	20525	836.5	22.14	23.00	1.219	-0.03	0.126	0.154
	LTE Band 5	10M	QPSK	1	25	Bottom Side	10mm	20525	836.5	23.25	24.00	1.189	-0.08	0.082	0.097
	LTE Band 5	10M	QPSK	25	25	Bottom Side	10mm	20525	836.5	22.14	23.00	1.219	0.14	0.061	0.074
	LTE Band 12	10M	QPSK	1	25	Front	10mm	23095	707.5	23.26	24.00	1.186	0.12	0.035	0.042
	LTE Band 12	10M	QPSK	25	12	Front	10mm	23095	707.5	22.14	23.00	1.219	0.01	0.027	0.033
14	LTE Band 12	10M	QPSK	1	25	Back	10mm	23095	707.5	23.26	24.00	1.186	-0.1	0.077	0.091
	LTE Band 12	10M	QPSK	25	12	Back	10mm	23095	707.5	22.14	23.00	1.219	-0.1	0.058	0.071
	LTE Band 12	10M	QPSK	1	25	Left Side	10mm	23095	707.5	23.26	24.00	1.186	0.03	0.004	0.005
	LTE Band 12	10M	QPSK	25	12	Left Side	10mm	23095	707.5	22.14	23.00	1.219	0.05	0.002	0.002
	LTE Band 12	10M	QPSK	1	25	Right Side	10mm	23095	707.5	23.26	24.00	1.186	0.02	0.004	0.005
	LTE Band 12	10M	QPSK	25	12	Right Side	10mm	23095	707.5	22.14	23.00	1.219	-0.06	0.002	0.002
	LTE Band 12	10M	QPSK	1	25	Bottom Side	10mm	23095	707.5	23.26	24.00	1.186	0.08	0.005	0.006
	LTE Band 12	10M	QPSK	25	12	Bottom Side	10mm	23095	707.5	22.14	23.00	1.219	-0.07	0.003	0.004

**<WLAN SAR>**

Plot No.	Band	Mode	Test Position	Gap (mm)	Ch.	Freq. (MHz)	Average Power (dBm)	Tune-Up Limit (dBm)	Tune-up Scaling Factor	Duty Cycle %	Duty Cycle Scaling Factor	Power Drift (dB)	Measured 1g SAR (W/kg)	Reported 1g SAR (W/kg)
	WLAN2.4GHz	802.11b 1Mbps	Front	10mm	11	2462	16.89	17.00	1.026	100	1.000	0.05	0.227	0.233
15	WLAN2.4GHz	802.11b 1Mbps	Back	10mm	11	2462	16.89	17.00	1.026	100	1.000	0.07	0.339	0.348
	WLAN2.4GHz	802.11b 1Mbps	Right Side	10mm	11	2462	16.89	17.00	1.026	100	1.000	-0.1	0.062	0.064
	WLAN2.4GHz	802.11b 1Mbps	Top Side	10mm	11	2462	16.89	17.00	1.026	100	1.000	0.09	0.216	0.221

**<Bluetooth SAR>**

Plot No.	Band	Mode	Test Position	Gap (mm)	Ch.	Freq. (MHz)	Average Power (dBm)	Tune-Up Limit (dBm)	Tune-up Scaling Factor	Duty Cycle %	Duty Cycle Scaling Factor	Power Drift (dB)	Measured 1g SAR (W/kg)	Reported 1g SAR (W/kg)
	Bluetooth	1Mbps	Front	10mm	0	2402	10.29	10.50	1.050	78.8	1.057	-0.05	0.032	0.035
16	Bluetooth	1Mbps	Back	10mm	0	2402	10.29	10.50	1.050	78.8	1.057	-0.01	0.057	0.063
	Bluetooth	1Mbps	Right Side	10mm	0	2402	10.29	10.50	1.050	78.8	1.057	0.1	0.006	0.007
	Bluetooth	1Mbps	Top Side	10mm	0	2402	10.29	10.50	1.050	78.8	1.057	0.08	0.030	0.033

**14.3 Body Worn Accessory SAR**

**<GSM SAR>**

Plot No.	Band	Mode	Test Position	Gap (mm)	Ch.	Freq. (MHz)	Average Power (dBm)	Tune-Up Limit (dBm)	Tune-up Scaling Factor	Power Drift (dB)	Measured 1g SAR (W/kg)	Reported 1g SAR (W/kg)
	GSM850	GPRS (4 Tx slots)	Front	10mm	189	836.4	27.64	28.00	1.086	-0.03	0.107	0.116
17	GSM850	GPRS (4 Tx slots)	Back	10mm	189	836.4	27.64	28.00	1.086	0.11	0.187	0.203
	GSM1900	GPRS (4 Tx slots)	Front	10mm	512	1850.2	23.66	24.00	1.081	-0.17	0.132	0.143
18	GSM1900	GPRS (4 Tx slots)	Back	10mm	512	1850.2	23.66	24.00	1.081	0.07	0.266	0.288

**<WCDMA SAR>**

Plot No.	Band	Mode	Test Position	Gap (mm)	Ch.	Freq. (MHz)	Average Power (dBm)	Tune-Up Limit (dBm)	Tune-up Scaling Factor	Power Drift (dB)	Measured 1g SAR (W/kg)	Reported 1g SAR (W/kg)
	WCDMA V	RMC 12.2Kbps	Front	10mm	4182	836.4	23.13	24.00	1.222	0.05	0.190	0.232
19	WCDMA V	RMC 12.2Kbps	Back	10mm	4182	836.4	23.13	24.00	1.222	0.04	0.297	0.363

**<LTE SAR>**

Plot No.	Band	BW (MHz)	Modulation	RB Size	RB offset	Test Position	Gap (mm)	Ch.	Freq. (MHz)	Average Power (dBm)	Tune-Up Limit (dBm)	Tune-up Scaling Factor	Power Drift (dB)	Measured 1g SAR (W/kg)	Reported 1g SAR (W/kg)
	LTE Band 5	10M	QPSK	1	25	Front	10mm	20525	836.5	23.25	24.00	1.189	0.19	0.193	0.229
	LTE Band 5	10M	QPSK	25	25	Front	10mm	20525	836.5	22.14	23.00	1.219	-0.05	0.162	0.197
20	LTE Band 5	10M	QPSK	1	25	Back	10mm	20525	836.5	23.25	24.00	1.189	-0.06	0.303	0.360
	LTE Band 5	10M	QPSK	25	25	Back	10mm	20525	836.5	22.14	23.00	1.219	-0.17	0.253	0.308
	LTE Band 12	10M	QPSK	1	25	Front	10mm	23095	707.5	23.26	24.00	1.186	0.12	0.035	0.042
	LTE Band 12	10M	QPSK	25	12	Front	10mm	23095	707.5	22.14	23.00	1.219	0.01	0.027	0.033
21	LTE Band 12	10M	QPSK	1	25	Back	10mm	23095	707.5	23.26	24.00	1.186	-0.1	0.077	0.091
	LTE Band 12	10M	QPSK	25	12	Back	10mm	23095	707.5	22.14	23.00	1.219	-0.1	0.058	0.071

**<WLAN SAR>**

Plot No.	Band	Mode	Test Position	Gap (mm)	Ch.	Freq. (MHz)	Average Power (dBm)	Tune-Up Limit (dBm)	Tune-up Scaling Factor	Duty Cycle %	Duty Cycle Scaling Factor	Power Drift (dB)	Measured 1g SAR (W/kg)	Reported 1g SAR (W/kg)
	WLAN2.4GHz	802.11b 1Mbps	Front	10mm	11	2462	16.89	17.00	1.026	100	1.000	0.05	0.227	0.233
22	WLAN2.4GHz	802.11b 1Mbps	Back	10mm	11	2462	16.89	17.00	1.026	100	1.000	0.07	0.339	0.348
	WLAN5GHz	802.11ac-VHT80 MCS0	Front	10mm	58	5290	12.51	13.00	1.119	97.08	1.030	-0.01	0.064	0.074
23	WLAN5GHz	802.11ac-VHT80 MCS0	Back	10mm	58	5290	12.51	13.00	1.119	97.08	1.030	-0.15	0.163	0.188
	WLAN5GHz	802.11ac-VHT80 MCS0	Front	10mm	122	5610	12.52	13.00	1.117	97.08	1.030	0.03	0.076	0.087
24	WLAN5GHz	802.11ac-VHT80 MCS0	Back	10mm	122	5610	12.52	13.00	1.117	97.08	1.030	-0.13	0.145	0.167

**<Bluetooth SAR>**

Plot No.	Band	Mode	Test Position	Gap (mm)	Ch.	Freq. (MHz)	Average Power (dBm)	Tune-Up Limit (dBm)	Tune-up Scaling Factor	Duty Cycle %	Duty Cycle Scaling Factor	Power Drift (dB)	Measured 1g SAR (W/kg)	Reported 1g SAR (W/kg)
	Bluetooth	1Mbps	Front	10mm	0	2402	10.29	10.50	1.050	78.8	1.057	-0.05	0.032	0.035
25	Bluetooth	1Mbps	Back	10mm	0	2402	10.29	10.50	1.050	78.8	1.057	-0.01	0.057	0.063

**14.4 Repeated SAR Measurement**

No.	Band	Mode	Test Position	Gap (mm)	Ch.	Freq. (MHz)	Average Power (dBm)	Tune-Up Limit (dBm)	Tune-up Scaling Factor	Duty Cycle %	Duty Cycle Scaling Factor	Power Drift (dB)	Measured 1g SAR (W/kg)	Ratio	Reported 1g SAR (W/kg)
1st	WLAN2.4GHz	802.11b 1Mbps	Left Cheek	0mm	11	2462	16.89	17.00	1.026	100	1.000	0.06	0.906	-	0.929
2nd	WLAN2.4GHz	802.11b 1Mbps	Left Cheek	0mm	11	2462	16.89	17.00	1.026	100	1.000	0.04	0.879	1.03	0.902

**General Note:**

1. Per KDB 865664 D01v01r04, for each frequency band, repeated SAR measurement is required only when the measured SAR is  $\geq 0.8W/kg$ .
2. Per KDB 865664 D01v01r04, if the ratio among the repeated measurement is  $\leq 1.2$  and the measured SAR  $< 1.45W/kg$ , only one repeated measurement is required.
3. The ratio is the difference in percentage between original and repeated *measured* SAR.
4. All measurement SAR result is scaled-up to account for tune-up tolerance and is compliant.

**15. Simultaneous Transmission Analysis**

NO.	Simultaneous Transmission Configurations	Portable Handset		
		Head	Body-worn	Hotspot
1.	GSM Voice + WLAN2.4GHz	Yes	Yes	
2.	GPRS + WLAN2.4GHz	Yes	Yes	Yes
3.	WCDMA + WLAN2.4GHz	Yes	Yes	Yes
4.	LTE + WLAN2.4GHz	Yes	Yes	Yes
5.	GSM Voice + Bluetooth	Yes	Yes	
6.	GPRS + Bluetooth	Yes	Yes	Yes
7.	WCDMA+ Bluetooth	Yes	Yes	Yes
8.	LTE + Bluetooth	Yes	Yes	Yes
9.	GSM Voice + WLAN5GHz	Yes	Yes	
10.	GPRS + WLAN5GHz	Yes	Yes	
11.	WCDMA + WLAN5GHz	Yes	Yes	
12.	LTE + WLAN5GHz	Yes	Yes	

**General Note:**

1. This device WLAN 2.4GHz supports Hotspot operation and Bluetooth support tethering applications.
2. WLAN and Bluetooth share the same antenna, and cannot transmit simultaneously.
3. All licensed modes share the same antenna part and cannot transmit simultaneously
4. EUT will choose either WLAN 2.4GHz or WLAN 5GHz according to the network signal condition; therefore, 2.4GHz WLAN and 5GHz WLAN will not operate simultaneously at any moment.
5. The Scaled SAR summation is calculated based on the same configuration and test position.
6. Per KDB 447498 D01v06, simultaneous transmission SAR is compliant if,
  - i) Scalar SAR summation < 1.6W/kg.
  - ii)  $SPLSR = (SAR1 + SAR2)^{1.5} / (\min. \text{ separation distance, mm})$ , and the peak separation distance is determined from the square root of  $[(x1-x2)^2 + (y1-y2)^2 + (z1-z2)^2]$ , where (x1, y1, z1) and (x2, y2, z2) are the coordinates of the extrapolated peak SAR locations in the zoom scan.
  - iii) If  $SPLSR \leq 0.04$ , simultaneously transmission SAR measurement is not necessary.
  - iv) Simultaneously transmission SAR measurement, and the reported multi-band SAR < 1.6W/kg.



**15.1 Head Exposure Conditions**

WWAN Band		Exposure Position	1	2	3	4	1+2 Summed 1g SAR (W/kg)	1+3 Summed 1g SAR (W/kg)	1+4 Summed 1g SAR (W/kg)
			WWAN 1g SAR (W/kg)	2.4GHz WLAN 1g SAR (W/kg)	5GHz WLAN 1g SAR (W/kg)	Bluetooth 1g SAR (W/kg)			
GSM	GSM850	Right Cheek	0.156	0.652	0.266	0.175	<b>0.808</b>	<b>0.422</b>	<b>0.331</b>
		Right Tilted	0.091	0.707	0.239	0.159	<b>0.798</b>	<b>0.330</b>	<b>0.250</b>
		Left Cheek	0.133	0.937	0.378	0.187	<b>1.070</b>	<b>0.511</b>	<b>0.320</b>
		Left Tilted	0.079	0.876	0.279	0.172	<b>0.955</b>	<b>0.358</b>	<b>0.251</b>
	GSM1900	Right Cheek	0.081	0.652	0.266	0.175	<b>0.733</b>	<b>0.347</b>	<b>0.256</b>
		Right Tilted	0.001	0.707	0.239	0.159	<b>0.708</b>	<b>0.240</b>	<b>0.160</b>
		Left Cheek	0.148	0.937	0.378	0.187	<b>1.085</b>	<b>0.526</b>	<b>0.335</b>
		Left Tilted	0.054	0.876	0.279	0.172	<b>0.930</b>	<b>0.333</b>	<b>0.226</b>
WCDMA	WCDMA V	Right Cheek	0.266	0.652	0.266	0.175	<b>0.918</b>	<b>0.532</b>	<b>0.441</b>
		Right Tilted	0.161	0.707	0.239	0.159	<b>0.868</b>	<b>0.400</b>	<b>0.320</b>
		Left Cheek	0.224	0.937	0.378	0.187	<b>1.161</b>	<b>0.602</b>	<b>0.411</b>
		Left Tilted	0.155	0.876	0.279	0.172	<b>1.031</b>	<b>0.434</b>	<b>0.327</b>
LTE	LTE Band 5	Right Cheek	0.279	0.652	0.266	0.175	<b>0.931</b>	<b>0.545</b>	<b>0.454</b>
		Right Tilted	0.162	0.707	0.239	0.159	<b>0.869</b>	<b>0.401</b>	<b>0.321</b>
		Left Cheek	0.245	0.937	0.378	0.187	<b>1.182</b>	<b>0.623</b>	<b>0.432</b>
		Left Tilted	0.162	0.876	0.279	0.172	<b>1.038</b>	<b>0.441</b>	<b>0.334</b>
	LTE Band 12	Right Cheek	0.036	0.652	0.266	0.175	<b>0.688</b>	<b>0.302</b>	<b>0.211</b>
		Right Tilted	0.018	0.707	0.239	0.159	<b>0.725</b>	<b>0.257</b>	<b>0.177</b>
		Left Cheek	0.030	0.937	0.378	0.187	<b>0.967</b>	<b>0.408</b>	<b>0.217</b>
		Left Tilted	0.008	0.876	0.279	0.172	<b>0.884</b>	<b>0.287</b>	<b>0.180</b>



**15.2 Hotspot Exposure Conditions**

WWAN Band		Exposure Position	1	2	4	1+2 Summed 1g SAR (W/kg)	1+4 Summed 1g SAR (W/kg)
			WWAN 1g SAR (W/kg)	2.4GHz WLAN 1g SAR (W/kg)	Bluetooth 1g SAR (W/kg)		
GSM	GSM850	Front	0.116	0.233	0.035	0.349	0.151
		Back	0.203	0.348	0.063	0.551	0.266
		Left side	0.079			0.079	0.079
		Right side	0.053	0.064	0.007	0.117	0.060
		Bottom side	0.049			0.049	0.049
	GSM1900	Front	0.143	0.233	0.035	0.376	0.178
		Back	0.288	0.348	0.063	0.636	0.351
		Left side	0.106			0.106	0.106
		Right side	0.049	0.064	0.007	0.113	0.056
		Bottom side	0.281			0.281	0.281
WCDMA	WCDMA V	Front	0.232	0.233	0.035	0.465	0.267
		Back	0.363	0.348	0.063	0.711	0.426
		Left side	0.133			0.133	0.133
		Right side	0.180	0.064	0.007	0.244	0.187
		Bottom side	0.092			0.092	0.092
LTE	LTE Band 5	Front	0.229	0.233	0.035	0.462	0.264
		Back	0.360	0.348	0.063	0.708	0.423
		Left side	0.138			0.138	0.138
		Right side	0.172	0.064	0.007	0.236	0.179
		Bottom side	0.097			0.097	0.097
	LTE Band 12	Front	0.042	0.233	0.035	0.275	0.077
		Back	0.091	0.348	0.063	0.439	0.154
		Left side	0.005			0.005	0.005
		Right side	0.005	0.064	0.007	0.069	0.012
		Bottom side	0.006			0.006	0.006

**15.3 Body-Worn Accessory Exposure Conditions**

WWAN Band		Exposure Position	1	2	3	4	1+2 Summed 1g SAR (W/kg)	1+3 Summed 1g SAR (W/kg)	1+4 Summed 1g SAR (W/kg)
			WWAN 1g SAR (W/kg)	2.4GHz WLAN 1g SAR (W/kg)	5GHz WLAN 1g SAR (W/kg)	Bluetooth 1g SAR (W/kg)			
GSM	GSM850	Front	0.116	0.233	0.087	0.035	0.349	0.203	0.151
		Back	0.203	0.348	0.188	0.063	0.551	0.391	0.266
	GSM1900	Front	0.143	0.233	0.087	0.035	0.376	0.230	0.178
		Back	0.288	0.348	0.188	0.063	0.636	0.476	0.351
WCDMA	WCDMA V	Front	0.232	0.233	0.087	0.035	0.465	0.319	0.267
		Back	0.363	0.348	0.188	0.063	0.711	0.551	0.426
LTE	LTE Band 5	Front	0.229	0.233	0.087	0.035	0.462	0.316	0.264
		Back	0.360	0.348	0.188	0.063	0.708	0.548	0.423
	LTE Band 12	Front	0.042	0.233	0.087	0.035	0.275	0.129	0.077
		Back	0.091	0.348	0.188	0.063	0.439	0.279	0.154

Test Engineer : Sing Lim





## **16. Uncertainty Assessment**

Per KDB 865664 D01 SAR measurement 100MHz to 6GHz, when the highest measured 1-g SAR within a frequency band is < 1.5 W/kg and the measured 10-g SAR within a frequency band is < 3.75 W/kg. The expanded SAR measurement uncertainty must be  $\leq 30\%$ , for a confidence interval of  $k = 2$ . If these conditions are met, extensive SAR measurement uncertainty analysis described in IEEE Std 1528-2013 is not required in SAR reports submitted for equipment approval. For this device, the highest measured 1-g SAR is less 1.5W/kg. Therefore, the measurement uncertainty table is not required in this report.

## **17. References**

- [1] FCC 47 CFR Part 2 "Frequency Allocations and Radio Treaty Matters; General Rules and Regulations"
- [2] ANSI/IEEE Std. C95.1-1992, "IEEE Standard for Safety Levels with Respect to Human Exposure to Radio Frequency Electromagnetic Fields, 3 kHz to 300 GHz", September 1992
- [3] IEEE Std. 1528-2013, "IEEE Recommended Practice for Determining the Peak Spatial-Average Specific Absorption Rate (SAR) in the Human Head from Wireless Communications Devices: Measurement Techniques", Sep 2013
- [4] SPEAG DASY System Handbook
- [5] FCC KDB 248227 D01 v02r02, "SAR Guidance for IEEE 802.11 (WiFi) Transmitters", Oct 2015.
- [6] FCC KDB 447498 D01 v06, "Mobile and Portable Device RF Exposure Procedures and Equipment Authorization Policies", Oct 2015
- [7] FCC KDB 648474 D04 v01r03, "SAR Evaluation Considerations for Wireless Handsets", Oct 2015.
- [8] FCC KDB 941225 D01 v03r01, "3G SAR MEAUREMENT PROCEDURES", Oct 2015
- [9] FCC KDB 941225 D05 v02r05, "SAR Evaluation Considerations for LTE Devices", Dec 2015
- [10] FCC KDB 941225 D06 v02r01, "SAR Evaluation Procedures for Portable Devices with Wireless Router Capabilities", Oct 2015.
- [11] FCC KDB 865664 D01 v01r04, "SAR Measurement Requirements for 100 MHz to 6 GHz", Aug 2015.
- [12] FCC KDB 865664 D02 v01r02, "RF Exposure Compliance Reporting and Documentation Considerations" Oct 2015.



---

**Appendix A. Plots of System Performance Check**

The plots are shown as follows.

## System Check\_Head\_750MHz

### DUT: D750V3-1107

Communication System: CW ; Frequency: 750 MHz;Duty Cycle: 1:1

Medium: HSL\_750\_200305 Medium parameters used:  $f = 750$  MHz;  $\sigma = 0.898$  S/m;  $\epsilon_r = 41.246$ ;  $\rho = 1000$  kg/m<sup>3</sup>

Ambient Temperature : 23.4 °C ; Liquid Temperature : 22.4 °C

DASY5 Configuration:

- Probe: EX3DV4 - SN3728; ConvF(9.67, 9.67, 9.67) @ 750 MHz; Calibrated: 2020/2/4
- Sensor-Surface: 1.4mm (Mechanical Surface Detection)
- Electronics: DAE3 Sn495; Calibrated: 2019/5/21
- Phantom: SAM\_Left; Type: QD000P40CD; Serial: 1719
- Measurement SW: DASY52, Version 52.10 (2);SEMCAD X Version 14.6.12 (7450)

**Pin=250mW/Area Scan (61x61x1):** Interpolated grid: dx=1.500 mm, dy=1.500 mm  
Maximum value of SAR (interpolated) = 2.87 W/kg

**Pin=250mW/Zoom Scan (5x5x7)/Cube 0:** Measurement grid: dx=8mm, dy=8mm, dz=5mm  
Reference Value = 60.83 V/m; Power Drift = -0.12 dB  
Peak SAR (extrapolated) = 3.56 W/kg  
**SAR(1 g) = 2.12 W/kg; SAR(10 g) = 1.36 W/kg**  
Maximum value of SAR (measured) = 3.02 W/kg

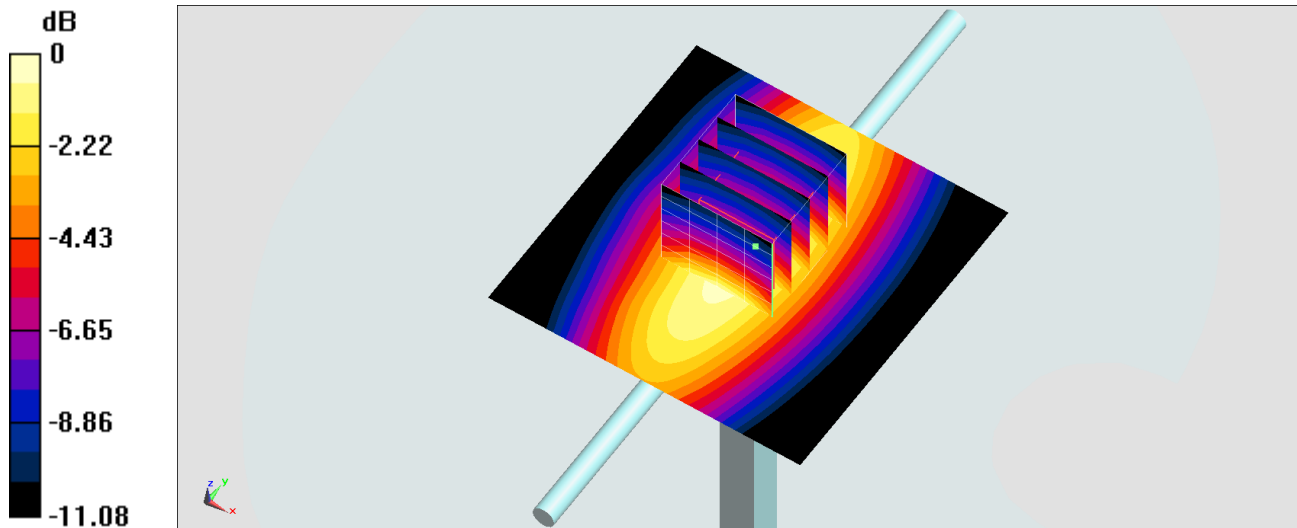

0 dB = 3.02 W/kg = 4.80 dBW/kg

## System Check\_Head\_835MHz

### DUT: D835V2-4d167

Communication System: CW; Frequency: 835 MHz; Duty Cycle: 1:1

Medium: HSL\_850\_200308 Medium parameters used:  $f = 835$  MHz;  $\sigma = 0.894$  S/m;  $\epsilon_r = 42.284$ ;  $\rho = 1000$  kg/m<sup>3</sup>

Ambient Temperature : 23.4 °C ; Liquid Temperature : 22.4 °C

### DASY5 Configuration:

- Probe: EX3DV4 - SN3728; ConvF(9.51, 9.51, 9.51) @ 835 MHz; Calibrated: 2020/2/4
- Sensor-Surface: 1.4mm (Mechanical Surface Detection)
- Electronics: DAE3 Sn495; Calibrated: 2019/5/21
- Phantom: SAM\_Left; Type: QD000P40CD; Serial: 1719
- Measurement SW: DASY52, Version 52.10 (2); SEMCAD X Version 14.6.12 (7450)

**Pin=250mW/Area Scan (61x61x1):** Interpolated grid: dx=1.500 mm, dy=1.500 mm  
Maximum value of SAR (interpolated) = 3.19 W/kg

**Pin=250mW/Zoom Scan (5x5x7)/Cube 0:** Measurement grid: dx=8mm, dy=8mm, dz=5mm  
Reference Value = 62.65 V/m; Power Drift = -0.03 dB  
Peak SAR (extrapolated) = 4.09 W/kg  
**SAR(1 g) = 2.36 W/kg; SAR(10 g) = 1.49 W/kg**  
Maximum value of SAR (measured) = 3.42 W/kg

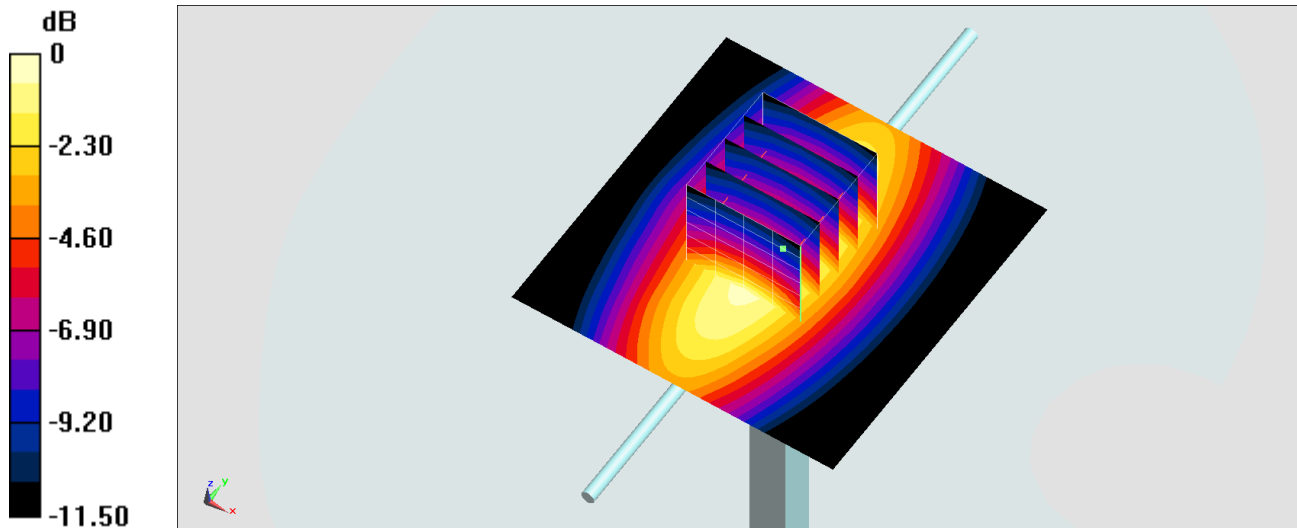

0 dB = 3.42 W/kg = 5.34 dBW/kg

## System Check\_Head\_1900MHz

### DUT: D1900V2-5d185

Communication System: CW ; Frequency: 1900 MHz;Duty Cycle: 1:1

Medium: HSL\_1900\_200306 Medium parameters used:  $f = 1900$  MHz;  $\sigma = 1.403$  S/m;  $\epsilon_r = 40.614$ ;  $\rho = 1000$  kg/m<sup>3</sup>

Ambient Temperature : 23.4 °C ; Liquid Temperature : 22.4 °C

DASY5 Configuration:

- Probe: EX3DV4 - SN3728; ConvF(7.82, 7.82, 7.82) @ 1900 MHz; Calibrated: 2020/2/4
- Sensor-Surface: 1.4mm (Mechanical Surface Detection)
- Electronics: DAE3 Sn495; Calibrated: 2019/5/21
- Phantom: SAM\_Right; Type: SAM; Serial: TP:1446
- Measurement SW: DASY52, Version 52.10 (2);SEMCAD X Version 14.6.12 (7450)

**Pin=250mW/Area Scan (61x61x1):** Interpolated grid: dx=1.500 mm, dy=1.500 mm  
Maximum value of SAR (interpolated) = 16.1 W/kg

**Pin=250mW/Zoom Scan (5x5x7)/Cube 0:** Measurement grid: dx=8mm, dy=8mm, dz=5mm  
Reference Value = 106.3 V/m; Power Drift = -0.04 dB  
Peak SAR (extrapolated) = 18.1 W/kg  
**SAR(1 g) = 9.89 W/kg; SAR(10 g) = 5.13 W/kg**  
Maximum value of SAR (measured) = 15.3 W/kg

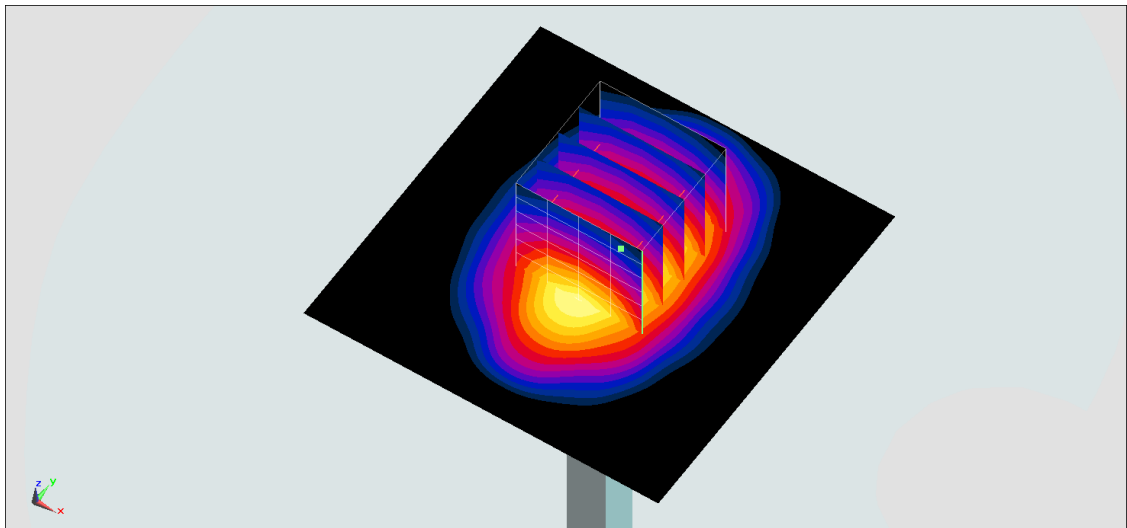
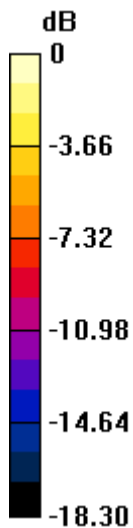

0 dB = 15.3 W/kg = 11.85 dBW/kg

## System Check\_Head\_2450MHz

### DUT: D2450V2-736

Communication System: CW; Frequency: 2450 MHz; Duty Cycle: 1:1

Medium: HSL2450\_200303 Medium parameters used:  $f = 2450$  MHz;  $\sigma = 1.818$  S/m;  $\epsilon_r = 39.796$ ;  $\rho = 1000$  kg/m<sup>3</sup>

Ambient Temperature : 23.6 °C ; Liquid Temperature : 22.6 °C

DASY5 Configuration:

- Probe: EX3DV4 - SN7306; ConvF(7.48, 7.48, 7.48) @ 2450 MHz; Calibrated: 2019/7/22
- Sensor-Surface: 1.4mm (Mechanical Surface Detection)
- Electronics: DAE3 Sn577; Calibrated: 2019/9/17
- Phantom: SAM\_Left; Type: QD000P40CD; Serial: 1719
- Measurement SW: DASY52, Version 52.10 (2); SEMCAD X Version 14.6.12 (7450)

**Pin=250mW/Area Scan (81x81x1):** Interpolated grid: dx=1.200 mm, dy=1.200 mm  
Maximum value of SAR (interpolated) = 26.2 W/kg

**Pin=250mW/Zoom Scan (7x7x7)/Cube 0:** Measurement grid: dx=5mm, dy=5mm, dz=5mm  
Reference Value = 116.6 V/m; Power Drift = 0.03 dB  
Peak SAR (extrapolated) = 29.5 W/kg  
**SAR(1 g) = 14.1 W/kg; SAR(10 g) = 6.48 W/kg**  
Maximum value of SAR (measured) = 23.6 W/kg

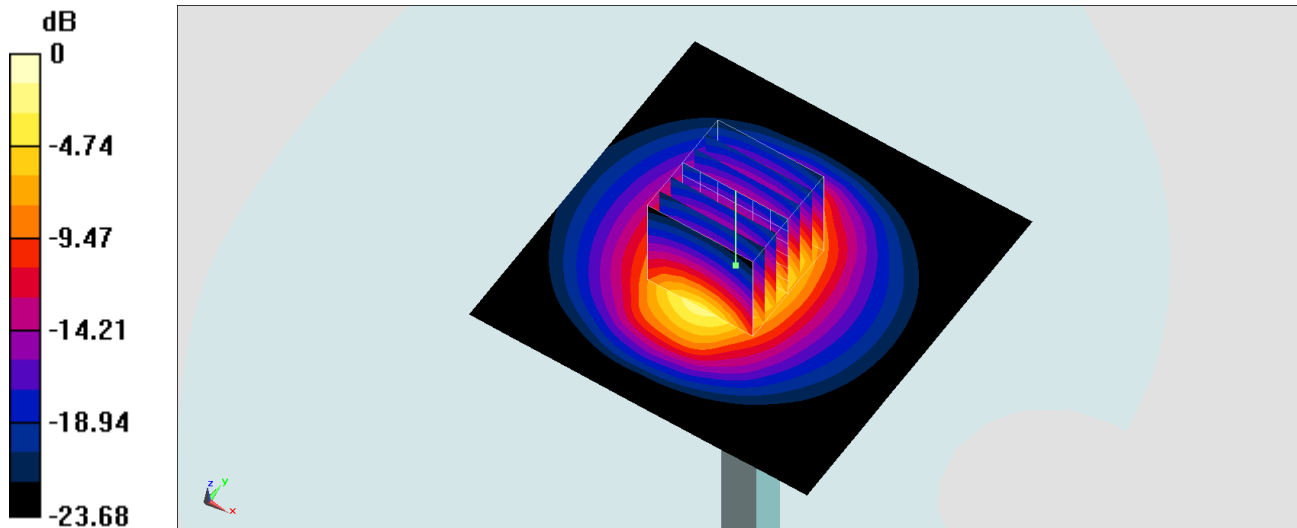

0 dB = 23.6 W/kg = 13.73 dBW/kg

## System Check\_Head\_5250MHz

### DUT: D5GHzV2-1006

Communication System: CW; Frequency: 5250 MHz; Duty Cycle: 1:1

Medium: HSL\_5G\_200310 Medium parameters used :  $f = 5250$  MHz;  $\sigma = 4.665$  S/m;  $\epsilon_r = 36.313$ ;  $\rho = 1000$  kg/m<sup>3</sup>

Ambient Temperature : 23.6 °C; Liquid Temperature : 22.6 °C

DASY5 Configuration:

- Probe: EX3DV4 - SN7306; ConvF(5.34, 5.34, 5.34) @ 5250 MHz; Calibrated: 2019/7/22
- Sensor-Surface: 1.4mm (Mechanical Surface Detection)
- Electronics: DAE3 Sn577; Calibrated: 2019/9/17
- Phantom: SAM\_Right; Type: SAM; Serial: TP:1446
- Measurement SW: DASY52, Version 52.10 (2); SEMCAD X Version 14.6.12 (7450)

**Pin=100mW/Area Scan (71x71x1):** Interpolated grid: dx=1.000 mm, dy=1.000 mm  
Maximum value of SAR (interpolated) = 18.6 W/kg

**Pin=100mW/Zoom Scan (7x7x7)/Cube 0:** Measurement grid: dx=4mm, dy=4mm, dz=1.4mm  
Reference Value = 71.51 V/m; Power Drift = -0.05 dB  
Peak SAR (extrapolated) = 31.1 W/kg  
**SAR(1 g) = 7.87 W/kg; SAR(10 g) = 2.26 W/kg**  
Maximum value of SAR (measured) = 19.5 W/kg

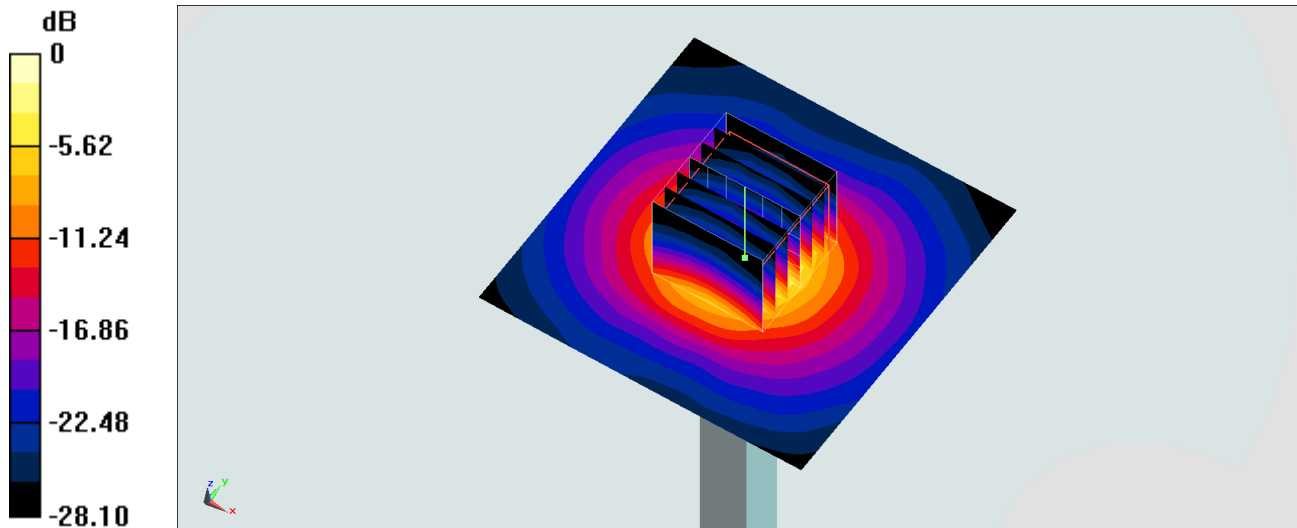

0 dB = 19.5 W/kg = 12.90 dBW/kg

## System Check\_Head\_5600MHz

### DUT: D5GHzV2-1006

Communication System: CW; Frequency: 5600 MHz; Duty Cycle: 1:1

Medium: HSL\_5G\_200310 Medium parameters used:  $f = 5600$  MHz;  $\sigma = 5.002$  S/m;  $\epsilon_r = 35.853$ ;  $\rho = 1000$  kg/m<sup>3</sup>

Ambient Temperature : 23.6 °C; Liquid Temperature : 22.6 °C

DASY5 Configuration:

- Probe: EX3DV4 - SN7306; ConvF(4.79, 4.79, 4.79) @ 5600 MHz; Calibrated: 2019/7/22
- Sensor-Surface: 1.4mm (Mechanical Surface Detection)
- Electronics: DAE3 Sn577; Calibrated: 2019/9/17
- Phantom: SAM\_Right; Type: SAM; Serial: TP:1446
- Measurement SW: DASY52, Version 52.10 (2); SEMCAD X Version 14.6.12 (7450)

**Pin=100mW/Area Scan (71x71x1):** Interpolated grid: dx=1.000 mm, dy=1.000 mm  
Maximum value of SAR (interpolated) = 20.6 W/kg

**Pin=100mW/Zoom Scan (7x7x7)/Cube 0:** Measurement grid: dx=4mm, dy=4mm, dz=1.4mm  
Reference Value = 70.95 V/m; Power Drift = -0.08 dB  
Peak SAR (extrapolated) = 33.5 W/kg  
**SAR(1 g) = 8.07 W/kg; SAR(10 g) = 2.32 W/kg**  
Maximum value of SAR (measured) = 20.6 W/kg

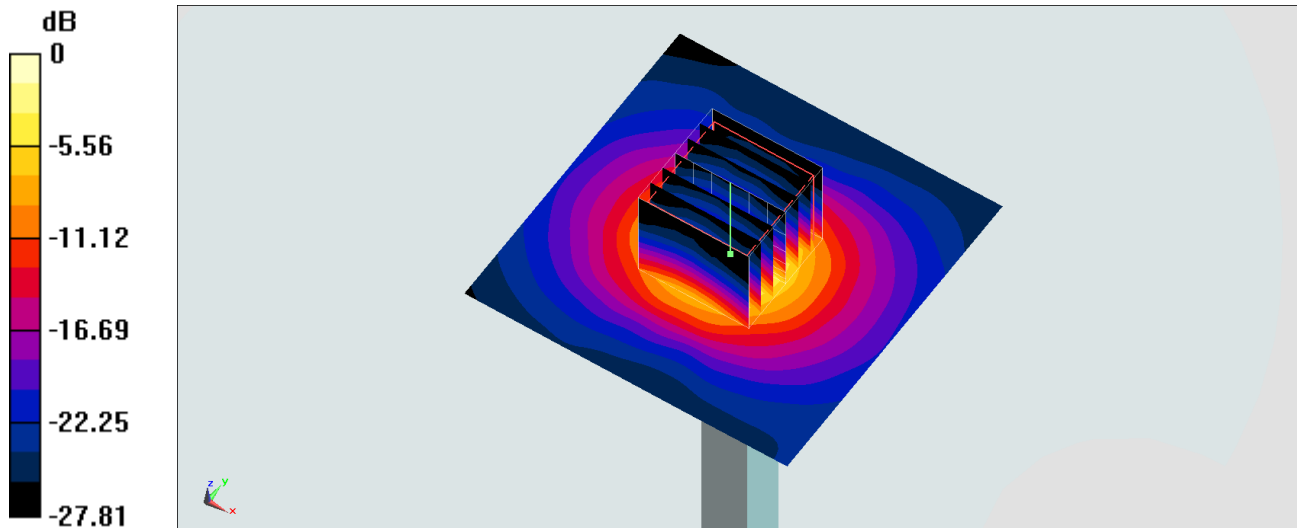

0 dB = 20.6 W/kg = 13.14 dBW/kg





**Appendix B. Plots of SAR Measurement**

The plots are shown as follows.

**#01\_GSM850\_GPRS (4 Tx slots)\_Right Cheek\_Ch189**

Communication System: GSM850; Frequency: 836.4 MHz; Duty Cycle: 1:2.08

Medium: HSL\_850\_200308 Medium parameters used :  $f = 836.4$  MHz;  $\sigma = 0.896$  S/m;  $\epsilon_r = 42.267$ ;  $\rho = 1000$  kg/m<sup>3</sup>

Ambient Temperature : 23.4 °C; Liquid Temperature : 22.4 °C

DASY5 Configuration:

- Probe: EX3DV4 - SN3728; ConvF(9.51, 9.51, 9.51) @ 836.4 MHz; Calibrated: 2020/2/4
- Sensor-Surface: 1.4mm (Mechanical Surface Detection)
- Electronics: DAE3 Sn495; Calibrated: 2019/5/21
- Phantom: SAM\_Left; Type: QD000P40CD; Serial: 1719
- Measurement SW: DASY52, Version 52.10 (2); SEMCAD X Version 14.6.12 (7450)

**Area Scan (61x121x1):** Interpolated grid: dx=1.500 mm, dy=1.500 mm

Maximum value of SAR (interpolated) = 0.168 W/kg

**Zoom Scan (5x5x7)/Cube 0:** Measurement grid: dx=8mm, dy=8mm, dz=5mm

Reference Value = 14.02 V/m; Power Drift = 0.10 dB

Peak SAR (extrapolated) = 0.178 W/kg

**SAR(1 g) = 0.144 W/kg; SAR(10 g) = 0.110 W/kg**

Maximum value of SAR (measured) = 0.168 W/kg

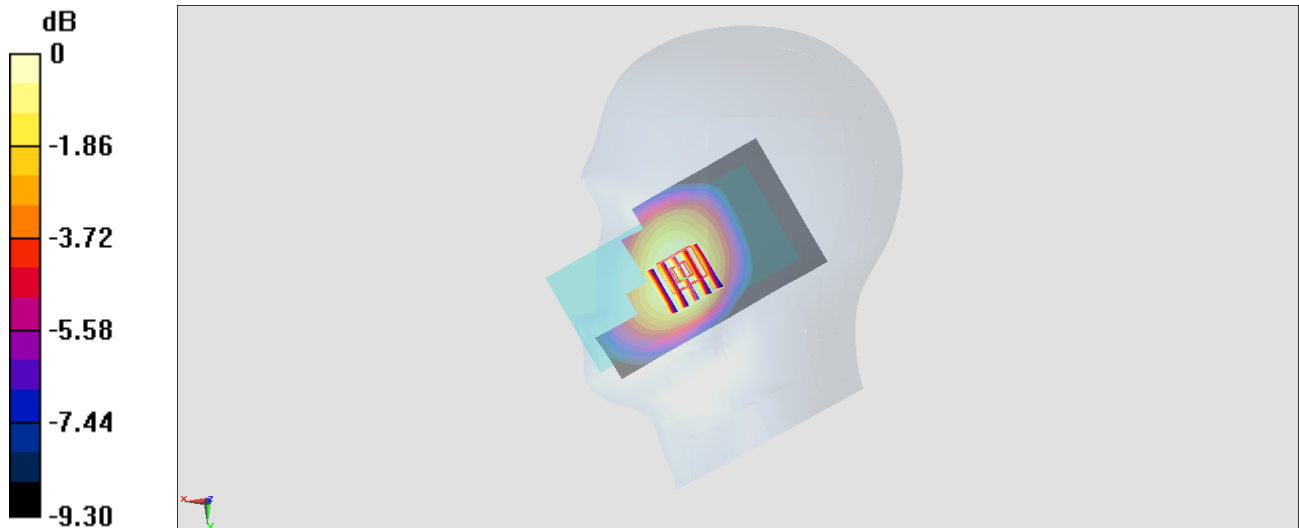

**#02\_GSM1900\_GPRS (4 Tx slots)\_Left Cheek\_Ch512**

Communication System: PCS; Frequency: 1850.2 MHz; Duty Cycle: 1:2.08

Medium: HSL\_1900\_200306 Medium parameters used :  $f = 1850.2$  MHz;  $\sigma = 1.354$  S/m;  $\epsilon_r = 40.795$ ;  $\rho = 1000$  kg/m<sup>3</sup>

Ambient Temperature : 23.4 °C ; Liquid Temperature : 22.4 °C

DASY5 Configuration:

- Probe: EX3DV4 - SN3728; ConvF(7.82, 7.82, 7.82) @ 1850.2 MHz; Calibrated: 2020/2/4
- Sensor-Surface: 1.4mm (Mechanical Surface Detection)
- Electronics: DAE3 Sn495; Calibrated: 2019/5/21
- Phantom: SAM\_Right; Type: SAM; Serial: TP:1446
- Measurement SW: DASY52, Version 52.10 (2); SEMCAD X Version 14.6.12 (7450)

**Area Scan (61x121x1):** Interpolated grid: dx=1.500 mm, dy=1.500 mm

Maximum value of SAR (interpolated) = 0.205 W/kg

**Zoom Scan (5x5x7)/Cube 0:** Measurement grid: dx=8mm, dy=8mm, dz=5mm

Reference Value = 8.795 V/m; Power Drift = -0.13 dB

Peak SAR (extrapolated) = 0.230 W/kg

**SAR(1 g) = 0.137 W/kg; SAR(10 g) = 0.083 W/kg**

Maximum value of SAR (measured) = 0.196 W/kg

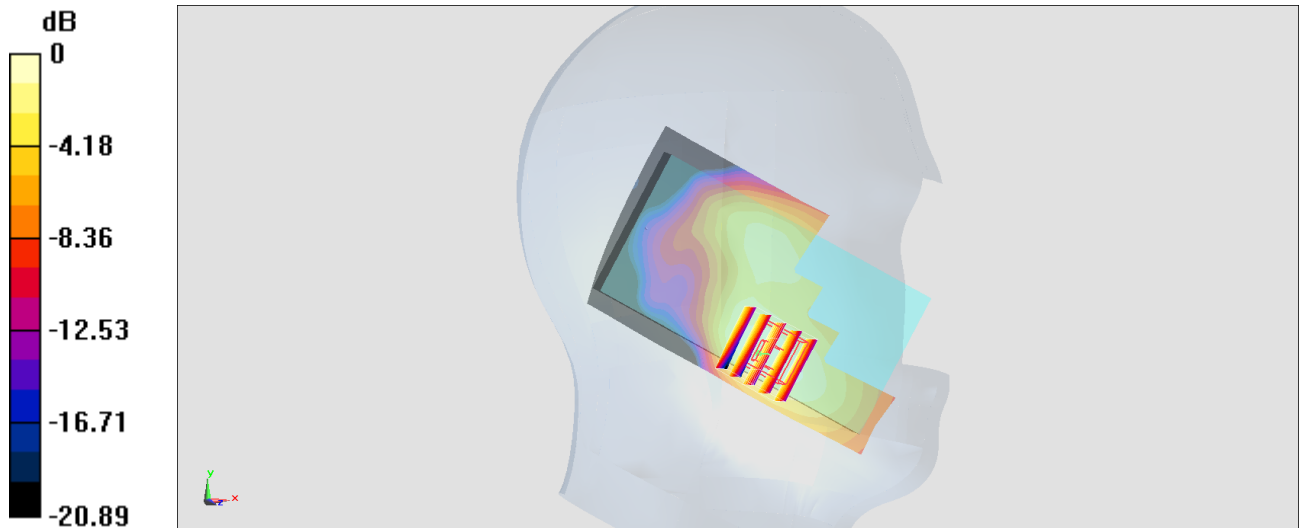

0 dB = 0.196 W/kg = -7.08 dBW/kg

**#03\_WCDMA V\_RMC 12.2Kbps\_Right Cheek\_Ch4182**

Communication System: WCDMA; Frequency: 836.4 MHz; Duty Cycle: 1:1

Medium: HSL\_850\_200308 Medium parameters used :  $f = 836.4$  MHz;  $\sigma = 0.896$  S/m;  $\epsilon_r = 42.267$ ;  $\rho = 1000$  kg/m<sup>3</sup>

Ambient Temperature : 23.4 °C; Liquid Temperature : 22.4 °C

DASY5 Configuration:

- Probe: EX3DV4 - SN3728; ConvF(9.51, 9.51, 9.51) @ 836.4 MHz; Calibrated: 2020/2/4
- Sensor-Surface: 1.4mm (Mechanical Surface Detection)
- Electronics: DAE3 Sn495; Calibrated: 2019/5/21
- Phantom: SAM\_Left; Type: QD000P40CD; Serial: 1719
- Measurement SW: DASY52, Version 52.10 (2); SEMCAD X Version 14.6.12 (7450)

**Area Scan (61x121x1):** Interpolated grid: dx=1.500 mm, dy=1.500 mm

Maximum value of SAR (interpolated) = 0.260 W/kg

**Zoom Scan (5x5x7)/Cube 0:** Measurement grid: dx=8mm, dy=8mm, dz=5mm

Reference Value = 17.82 V/m; Power Drift = -0.13 dB

Peak SAR (extrapolated) = 0.264 W/kg

**SAR(1 g) = 0.218 W/kg; SAR(10 g) = 0.167 W/kg**

Maximum value of SAR (measured) = 0.250 W/kg

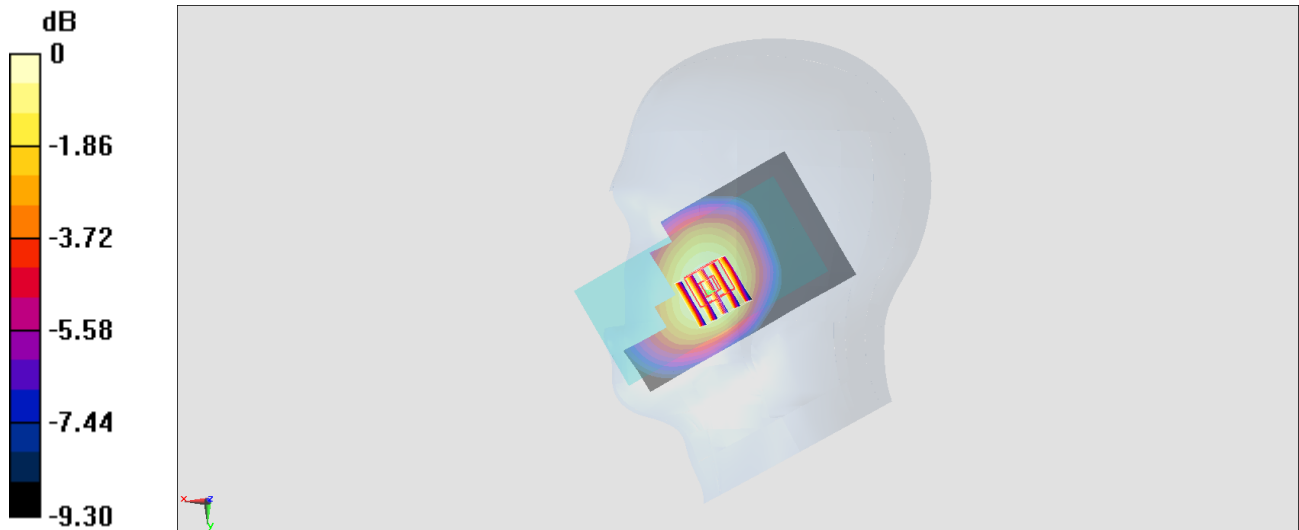

**#04\_LTE Band 5\_10M\_QPSK\_1\_25\_Right Cheek\_Ch20525**

Communication System: LTE; Frequency: 836.5 MHz; Duty Cycle: 1:1

Medium: HSL\_850\_200308 Medium parameters used :  $f = 836.5$  MHz;  $\sigma = 0.896$  S/m;  $\epsilon_r = 42.266$ ;  $\rho = 1000$  kg/m<sup>3</sup>

Ambient Temperature : 23.4 °C; Liquid Temperature : 22.4 °C

DASY5 Configuration:

- Probe: EX3DV4 - SN3728; ConvF(9.51, 9.51, 9.51) @ 836.5 MHz; Calibrated: 2020/2/4
- Sensor-Surface: 1.4mm (Mechanical Surface Detection)
- Electronics: DAE3 Sn495; Calibrated: 2019/5/21
- Phantom: SAM\_Left; Type: QD000P40CD; Serial: 1719
- Measurement SW: DASY52, Version 52.10 (2); SEMCAD X Version 14.6.12 (7450)

**Area Scan (61x121x1):** Interpolated grid: dx=1.500 mm, dy=1.500 mm

Maximum value of SAR (interpolated) = 0.269 W/kg

**Zoom Scan (5x5x7)/Cube 0:** Measurement grid: dx=8mm, dy=8mm, dz=5mm

Reference Value = 17.77 V/m; Power Drift = 0.01 dB

Peak SAR (extrapolated) = 0.289 W/kg

**SAR(1 g) = 0.235 W/kg; SAR(10 g) = 0.178 W/kg**

Maximum value of SAR (measured) = 0.271 W/kg

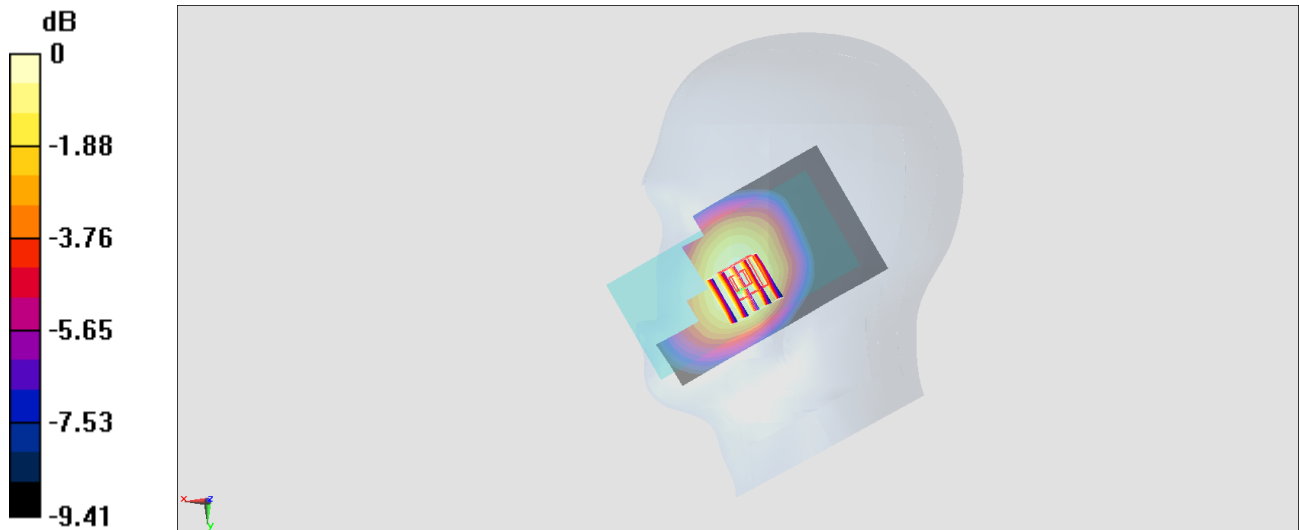

0 dB = 0.271 W/kg = -5.67 dBW/kg

**#05\_LTE Band 12\_10M\_QPSK\_1\_25\_Right Cheek\_Ch23095**

Communication System: LTE; Frequency: 707.5 MHz; Duty Cycle: 1:1

Medium: HSL\_750\_200305 Medium parameters used:  $f = 707.5$  MHz;  $\sigma = 0.858$  S/m;  $\epsilon_r = 41.601$ ;  $\rho = 1000$  kg/m<sup>3</sup>

Ambient Temperature : 23.4 °C ; Liquid Temperature : 22.4 °C

DASY5 Configuration:

- Probe: EX3DV4 - SN3728; ConvF(9.67, 9.67, 9.67) @ 707.5 MHz; Calibrated: 2020/2/4
- Sensor-Surface: 1.4mm (Mechanical Surface Detection)
- Electronics: DAE3 Sn495; Calibrated: 2019/5/21
- Phantom: SAM\_Left; Type: QD000P40CD; Serial: 1719
- Measurement SW: DASY52, Version 52.10 (2); SEMCAD X Version 14.6.12 (7450)

**Area Scan (61x121x1):** Interpolated grid: dx=1.500 mm, dy=1.500 mm

Maximum value of SAR (interpolated) = 0.0340 W/kg

**Zoom Scan (5x5x7)/Cube 0:** Measurement grid: dx=8mm, dy=8mm, dz=5mm

Reference Value = 6.526 V/m; Power Drift = 0.13 dB

Peak SAR (extrapolated) = 0.0350 W/kg

**SAR(1 g) = 0.030 W/kg; SAR(10 g) = 0.023 W/kg**

Maximum value of SAR (measured) = 0.0335 W/kg

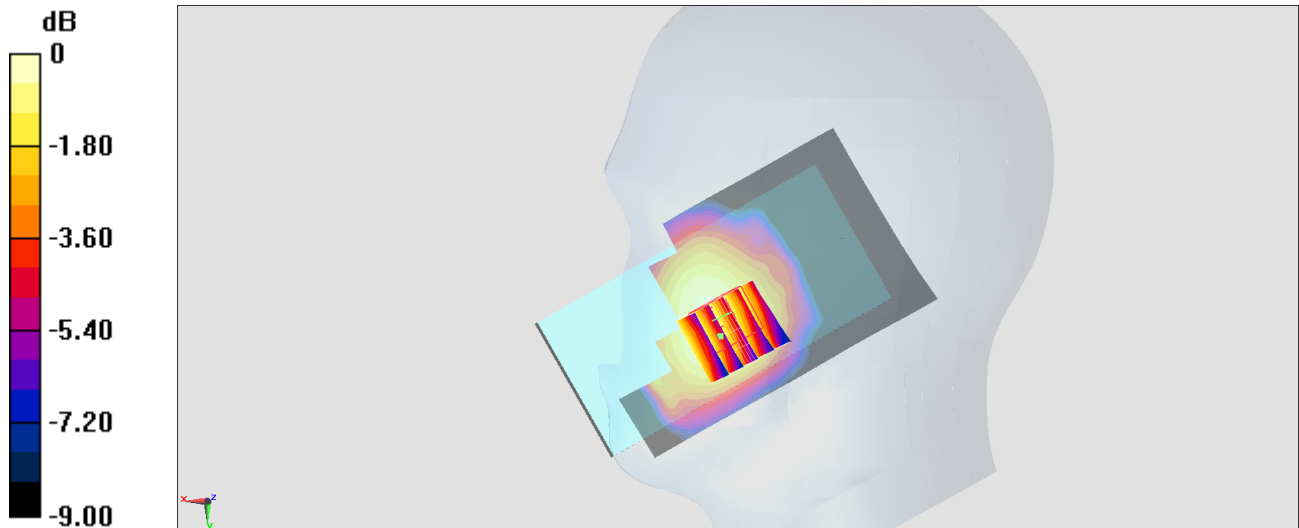

**#06\_WLAN2.4GHz\_802.11b 1Mbps\_Left Cheek\_Ch1**

Communication System: 802.11b; Frequency: 2412 MHz; Duty Cycle: 1:1

Medium: HSL2450\_200303 Medium parameters used:  $f = 2412$  MHz;  $\sigma = 1.777$  S/m;  $\epsilon_r = 39.917$ ;  $\rho = 1000$  kg/m<sup>3</sup>

Ambient Temperature : 23.6 °C ; Liquid Temperature : 22.6 °C

DASY5 Configuration:

- Probe: EX3DV4 - SN7306; ConvF(7.48, 7.48, 7.48) @ 2412 MHz; Calibrated: 2019/7/22
- Sensor-Surface: 1.4mm (Mechanical Surface Detection)
- Electronics: DAE3 Sn577; Calibrated: 2019/9/17
- Phantom: SAM\_Left; Type: QD000P40CD; Serial: 1719
- Measurement SW: DASY52, Version 52.10 (2); SEMCAD X Version 14.6.12 (7450)

**Area Scan (71x151x1):** Interpolated grid: dx=1.200 mm, dy=1.200 mm

Maximum value of SAR (interpolated) = 1.45 W/kg

**Zoom Scan (7x7x7)/Cube 0:** Measurement grid: dx=5mm, dy=5mm, dz=5mm

Reference Value = 21.88 V/m; Power Drift = -0.05 dB

Peak SAR (extrapolated) = 1.93 W/kg

**SAR(1 g) = 0.839 W/kg; SAR(10 g) = 0.367 W/kg**

Maximum value of SAR (measured) = 1.42 W/kg

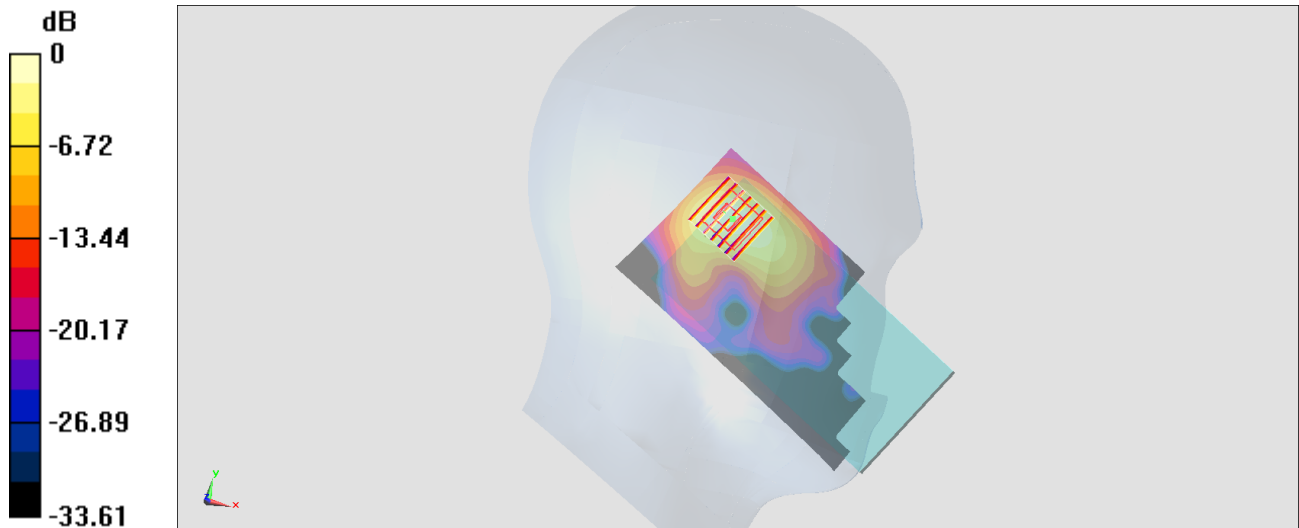

0 dB = 1.42 W/kg = 1.52 dBW/kg

**#07\_WLAN5GHz\_802.11ac-VHT80 MCS0\_Left Cheek\_Ch58**

Communication System: 802.11ac ; Frequency: 5290 MHz; Duty Cycle: 1:1.03

Medium: HSL\_5G\_200310 Medium parameters used :  $f = 5290$  MHz;  $\sigma = 4.697$  S/m;  $\epsilon_r = 36.262$ ;  $\rho = 1000$  kg/m<sup>3</sup>

Ambient Temperature : 23.6 °C ; Liquid Temperature : 22.6 °C

DASY5 Configuration:

- Probe: EX3DV4 - SN7306; ConvF(5.34, 5.34, 5.34) @ 5290 MHz; Calibrated: 2019/7/22
- Sensor-Surface: 1.4mm (Mechanical Surface Detection)
- Electronics: DAE3 Sn577; Calibrated: 2019/9/17
- Phantom: SAM\_Right; Type: SAM; Serial: TP:1446
- Measurement SW: DASY52, Version 52.10 (2); SEMCAD X Version 14.6.12 (7450)

**Area Scan (101x81x1):** Interpolated grid: dx=1.000 mm, dy=1.000 mm

Maximum value of SAR (interpolated) = 0.801 W/kg

**Zoom Scan (7x7x7)/Cube 0:** Measurement grid: dx=4mm, dy=4mm, dz=1.4mm

Reference Value = 10.65 V/m; Power Drift = -0.01 dB

Peak SAR (extrapolated) = 1.49 W/kg

**SAR(1 g) = 0.323 W/kg; SAR(10 g) = 0.108 W/kg**

Maximum value of SAR (measured) = 0.904 W/kg

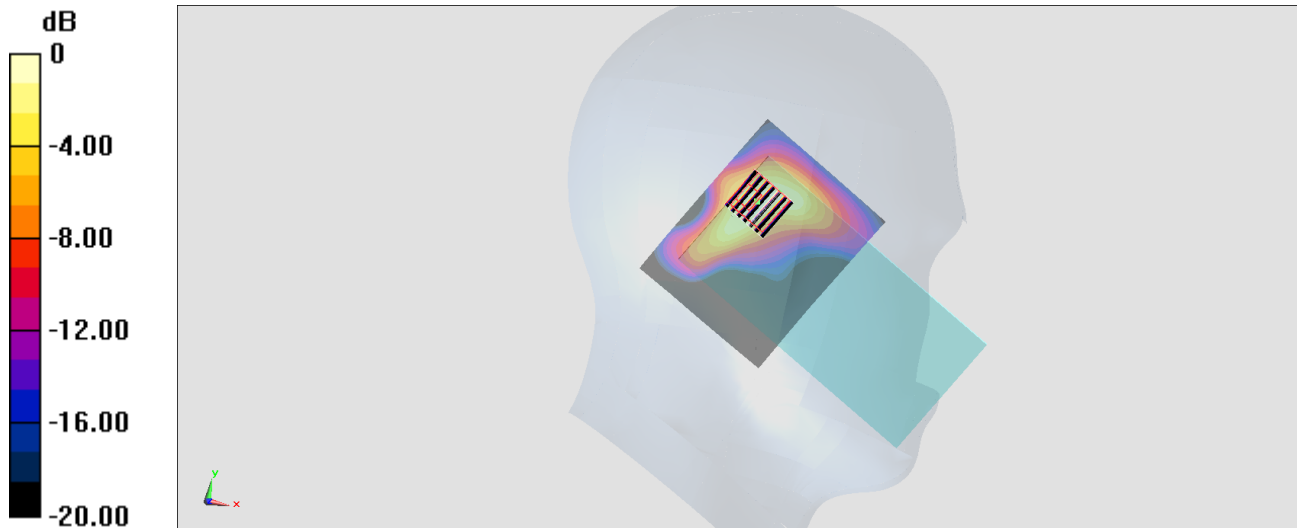



**#08\_WLAN5GHz\_802.11ac-VHT80 MCS0\_Left Cheek\_Ch122**

Communication System: 802.11ac ; Frequency: 5610 MHz;Duty Cycle: 1:1.03

Medium: HSL\_5G\_200310 Medium parameters used :  $f = 5610$  MHz;  $\sigma = 5.014$  S/m;  $\epsilon_r = 35.822$ ;  $\rho = 1000$  kg/m<sup>3</sup>

Ambient Temperature : 23.6 °C ; Liquid Temperature : 22.6 °C

DASY5 Configuration:

- Probe: EX3DV4 - SN7306; ConvF(4.79, 4.79, 4.79) @ 5610 MHz; Calibrated: 2019/7/22
- Sensor-Surface: 1.4mm (Mechanical Surface Detection)
- Electronics: DAE3 Sn577; Calibrated: 2019/9/17
- Phantom: SAM\_Right; Type: SAM; Serial: TP:1446
- Measurement SW: DASY52, Version 52.10 (2);SEMCAD X Version 14.6.12 (7450)

**Area Scan (101x101x1):** Interpolated grid: dx=1.000 mm, dy=1.000 mm

Maximum value of SAR (interpolated) = 0.853 W/kg

**Zoom Scan (7x7x7)/Cube 0:** Measurement grid: dx=4mm, dy=4mm, dz=1.4mm

Reference Value = 5.071 V/m; Power Drift = 0.19 dB

Peak SAR (extrapolated) = 1.44 W/kg

**SAR(1 g) = 0.329 W/kg; SAR(10 g) = 0.099 W/kg**

Maximum value of SAR (measured) = 0.818 W/kg

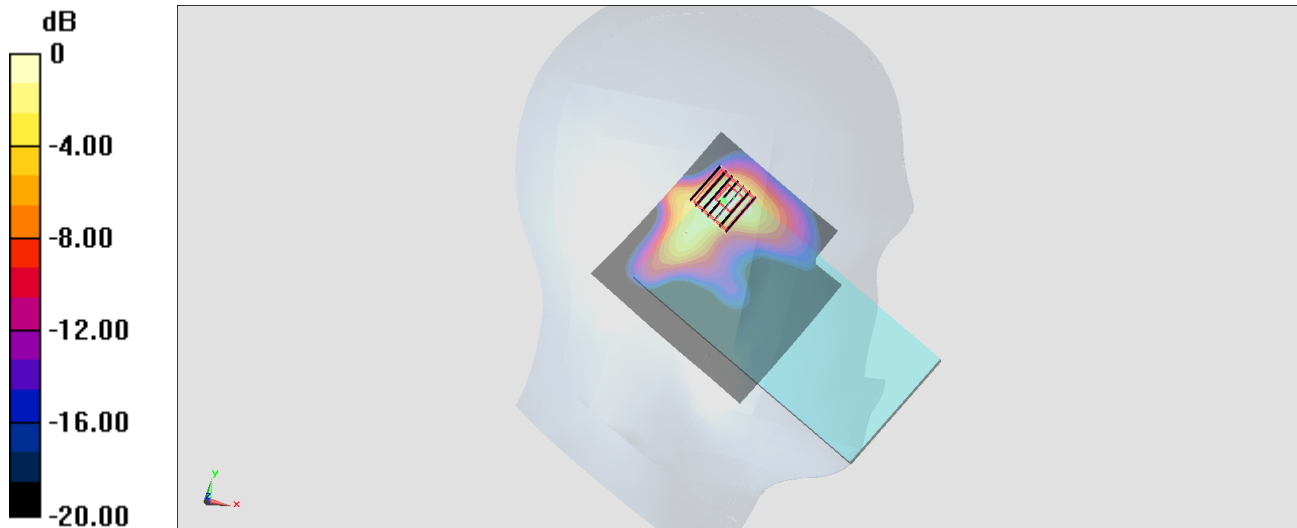

0 dB = 0.818 W/kg = -0.87 dBW/kg

## #09\_Bluetooth\_1Mbps\_Left Cheek\_Ch0

Communication System: Bluetooth; Frequency: 2402 MHz; Duty Cycle: 1:1.269

Medium: HSL2450\_200303 Medium parameters used:  $f = 2402$  MHz;  $\sigma = 1.767$  S/m;  $\epsilon_r = 39.948$ ;  $\rho = 1000$  kg/m<sup>3</sup>

Ambient Temperature : 23.6 °C ; Liquid Temperature : 22.6 °C

DASY5 Configuration:

- Probe: EX3DV4 - SN7306; ConvF(7.48, 7.48, 7.48) @ 2402 MHz; Calibrated: 2019/7/22
- Sensor-Surface: 1.4mm (Mechanical Surface Detection)
- Electronics: DAE3 Sn577; Calibrated: 2019/9/17
- Phantom: SAM\_Left; Type: QD000P40CD; Serial: 1719
- Measurement SW: DASY52, Version 52.10 (2); SEMCAD X Version 14.6.12 (7450)

**Area Scan (71x151x1):** Interpolated grid: dx=1.200 mm, dy=1.200 mm

Maximum value of SAR (interpolated) = 0.286 W/kg

**Zoom Scan (7x7x7)/Cube 0:** Measurement grid: dx=5mm, dy=5mm, dz=5mm

Reference Value = 9.246 V/m; Power Drift = 0.01 dB

Peak SAR (extrapolated) = 0.392 W/kg

**SAR(1 g) = 0.169 W/kg; SAR(10 g) = 0.073 W/kg**

Maximum value of SAR (measured) = 0.295 W/kg

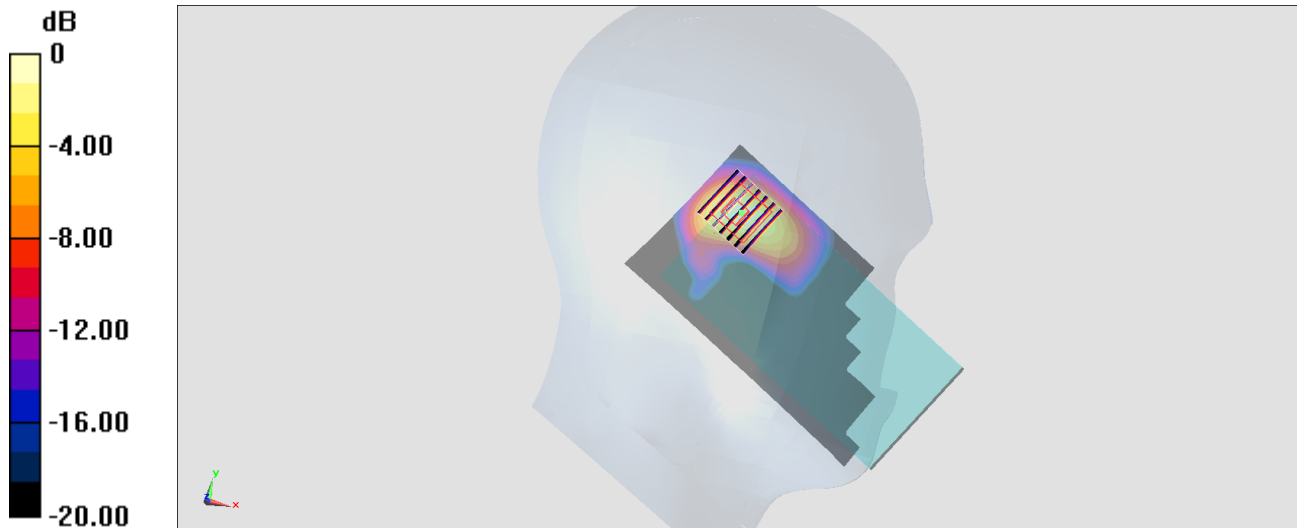

0 dB = 0.295 W/kg = -5.30 dBW/kg

## #10\_GSM850\_GPRS (4 Tx slots)\_Back\_10mm\_Ch189

Communication System: GSM850 ; Frequency: 836.4 MHz; Duty Cycle: 1:2.08

Medium: HSL\_850\_200308 Medium parameters used :  $f = 836.4$  MHz;  $\sigma = 0.896$  S/m;  $\epsilon_r = 42.267$ ;  $\rho = 1000$  kg/m<sup>3</sup>

Ambient Temperature : 23.4 °C ; Liquid Temperature : 22.4 °C

DASY5 Configuration:

- Probe: EX3DV4 - SN3728; ConvF(9.51, 9.51, 9.51) @ 836.4 MHz; Calibrated: 2020/2/4
- Sensor-Surface: 1.4mm (Mechanical Surface Detection)
- Electronics: DAE3 Sn495; Calibrated: 2019/5/21
- Phantom: SAM\_Left; Type: QD000P40CD; Serial: 1719
- Measurement SW: DASY52, Version 52.10 (2); SEMCAD X Version 14.6.12 (7450)

**Area Scan (71x121x1):** Interpolated grid: dx=1.500 mm, dy=1.500 mm

Maximum value of SAR (interpolated) = 0.265 W/kg

**Zoom Scan (5x5x7)/Cube 0:** Measurement grid: dx=8mm, dy=8mm, dz=5mm

Reference Value = 16.41 V/m; Power Drift = 0.11 dB

Peak SAR (extrapolated) = 0.334 W/kg

**SAR(1 g) = 0.187 W/kg; SAR(10 g) = 0.108 W/kg**

Maximum value of SAR (measured) = 0.277 W/kg

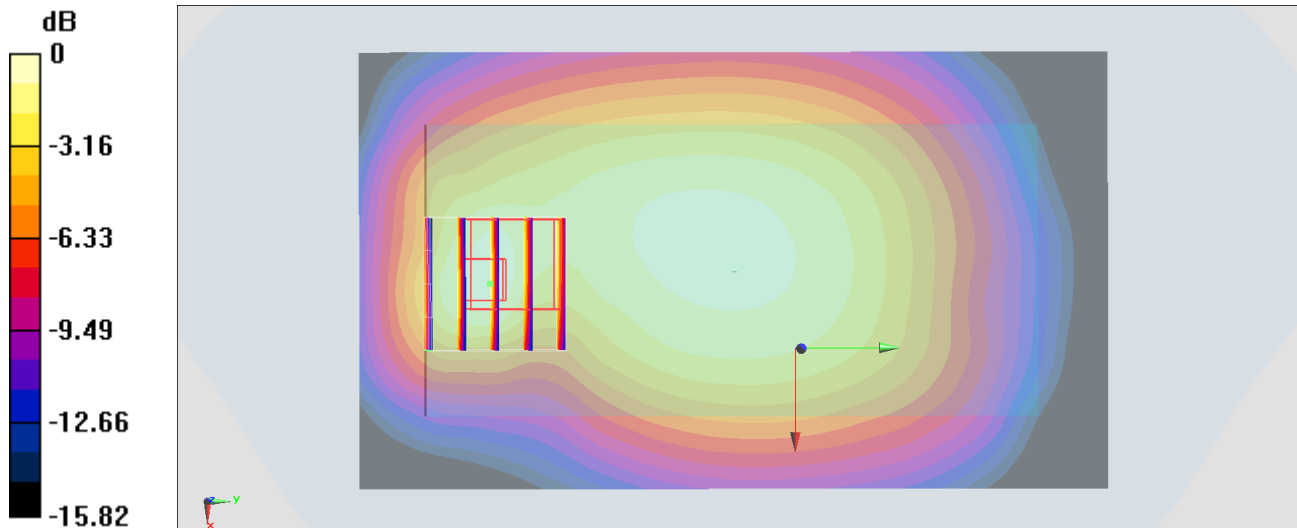

0 dB = 0.277 W/kg = -5.58 dBW/kg

**#11\_GSM1900\_GPRS (4 Tx slots)\_Back\_10mm\_Ch512**

Communication System: PCS; Frequency: 1850.2 MHz; Duty Cycle: 1:2.08

Medium: HSL\_1900\_200306 Medium parameters used :  $f = 1850.2$  MHz;  $\sigma = 1.354$  S/m;  $\epsilon_r = 40.795$ ;  $\rho = 1000$  kg/m<sup>3</sup>

Ambient Temperature : 23.4 °C ; Liquid Temperature : 22.4 °C

DASY5 Configuration:

- Probe: EX3DV4 - SN3728; ConvF(7.82, 7.82, 7.82) @ 1850.2 MHz; Calibrated: 2020/2/4
- Sensor-Surface: 1.4mm (Mechanical Surface Detection)
- Electronics: DAE3 Sn495; Calibrated: 2019/5/21
- Phantom: SAM\_Right; Type: SAM; Serial: TP:1446
- Measurement SW: DASY52, Version 52.10 (2); SEMCAD X Version 14.6.12 (7450)

**Area Scan (71x121x1):** Interpolated grid: dx=1.500 mm, dy=1.500 mm

Maximum value of SAR (interpolated) = 0.416 W/kg

**Zoom Scan (5x5x7)/Cube 0:** Measurement grid: dx=8mm, dy=8mm, dz=5mm

Reference Value = 6.965 V/m; Power Drift = 0.07 dB

Peak SAR (extrapolated) = 0.540 W/kg

**SAR(1 g) = 0.266 W/kg; SAR(10 g) = 0.135 W/kg**

Maximum value of SAR (measured) = 0.440 W/kg

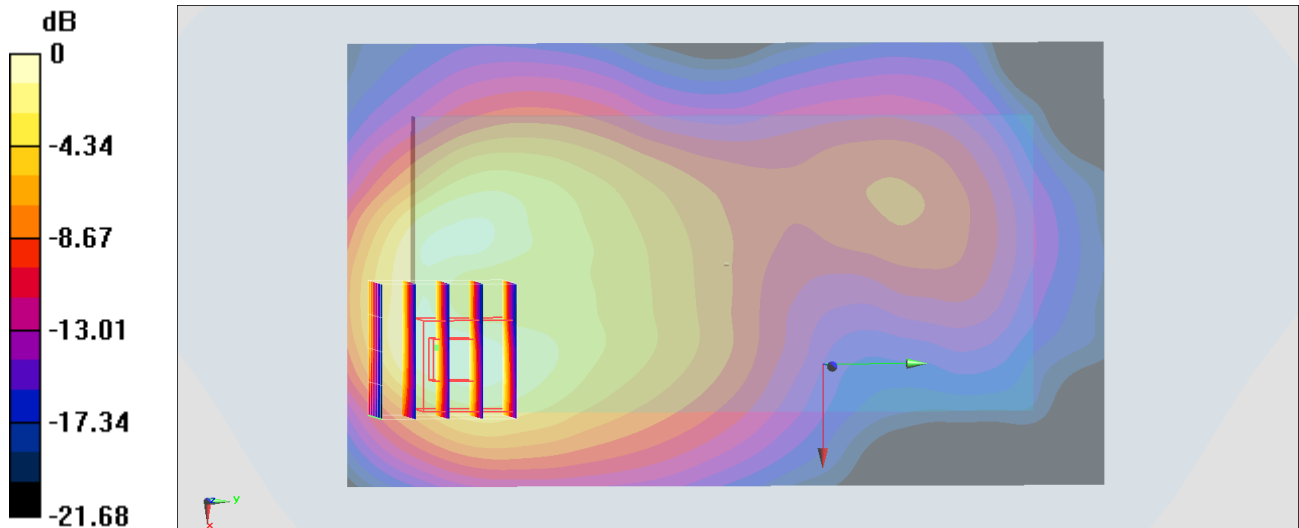

0 dB = 0.440 W/kg = -3.57 dBW/kg

## #12\_WCDMA V\_RMC 12.2Kbps\_Back\_10mm\_Ch4182

Communication System: WCDMA; Frequency: 836.4 MHz; Duty Cycle: 1:1

Medium: HSL\_850\_200308 Medium parameters used :  $f = 836.4$  MHz;  $\sigma = 0.896$  S/m;  $\epsilon_r = 42.267$ ;  $\rho = 1000$  kg/m<sup>3</sup>

Ambient Temperature : 23.4 °C ; Liquid Temperature : 22.4 °C

DASY5 Configuration:

- Probe: EX3DV4 - SN3728; ConvF(9.51, 9.51, 9.51) @ 836.4 MHz; Calibrated: 2020/2/4
- Sensor-Surface: 1.4mm (Mechanical Surface Detection)
- Electronics: DAE3 Sn495; Calibrated: 2019/5/21
- Phantom: SAM\_Left; Type: QD000P40CD; Serial: 1719
- Measurement SW: DASY52, Version 52.10 (2); SEMCAD X Version 14.6.12 (7450)

**Area Scan (61x121x1):** Interpolated grid: dx=1.500 mm, dy=1.500 mm

Maximum value of SAR (interpolated) = 0.455 W/kg

**Zoom Scan (5x5x7)/Cube 0:** Measurement grid: dx=8mm, dy=8mm, dz=5mm

Reference Value = 19.13 V/m; Power Drift = 0.04 dB

Peak SAR (extrapolated) = 0.519 W/kg

**SAR(1 g) = 0.297 W/kg; SAR(10 g) = 0.177 W/kg**

Maximum value of SAR (measured) = 0.318 W/kg

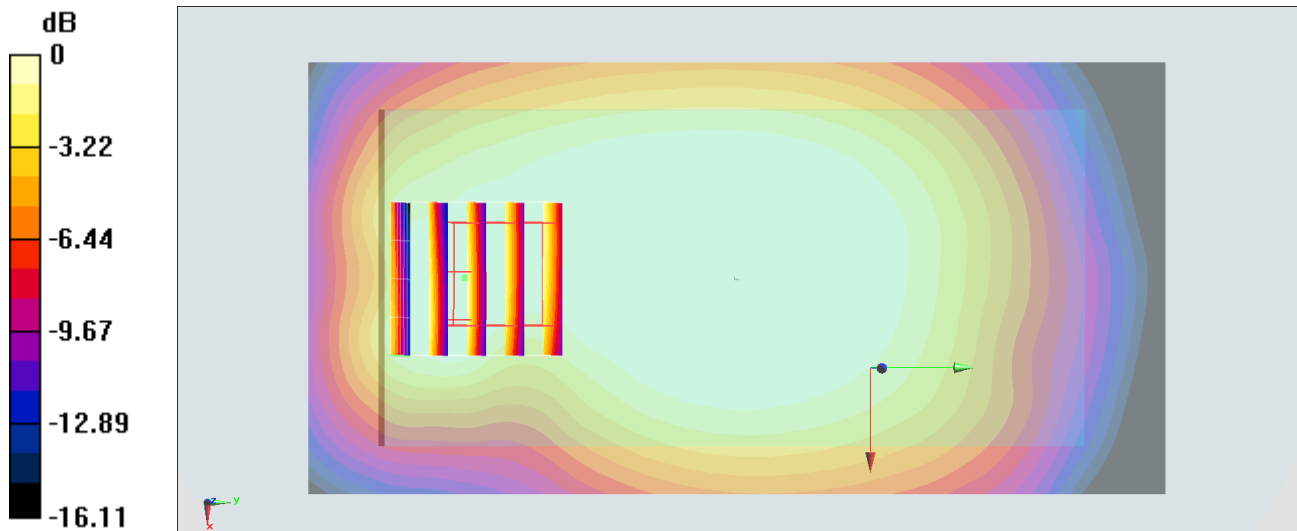

0 dB = 0.318 W/kg = -4.98 dBW/kg

**#13\_LTE Band 5\_10M\_QPSK\_1\_25\_Back\_10mm\_Ch20525**

Communication System: LTE ; Frequency: 836.5 MHz;Duty Cycle: 1:1

Medium: HSL\_850\_200308 Medium parameters used :  $f = 836.5$  MHz;  $\sigma = 0.896$  S/m;  $\epsilon_r = 42.266$ ;  $\rho = 1000$  kg/m<sup>3</sup>

Ambient Temperature : 23.4 °C ; Liquid Temperature : 22.4 °C

DASY5 Configuration:

- Probe: EX3DV4 - SN3728; ConvF(9.51, 9.51, 9.51) @ 836.5 MHz; Calibrated: 2020/2/4
- Sensor-Surface: 1.4mm (Mechanical Surface Detection)
- Electronics: DAE3 Sn495; Calibrated: 2019/5/21
- Phantom: SAM\_Left; Type: QD000P40CD; Serial: 1719
- Measurement SW: DASY52, Version 52.10 (2);SEMCAD X Version 14.6.12 (7450)

**Area Scan (61x121x1):** Interpolated grid: dx=1.500 mm, dy=1.500 mm

Maximum value of SAR (interpolated) = 0.427 W/kg

**Zoom Scan (5x5x7)/Cube 0:** Measurement grid: dx=8mm, dy=8mm, dz=5mm

Reference Value = 22.07 V/m; Power Drift = -0.06 dB

Peak SAR (extrapolated) = 0.530 W/kg

**SAR(1 g) = 0.303 W/kg; SAR(10 g) = 0.179 W/kg**

Maximum value of SAR (measured) = 0.438 W/kg

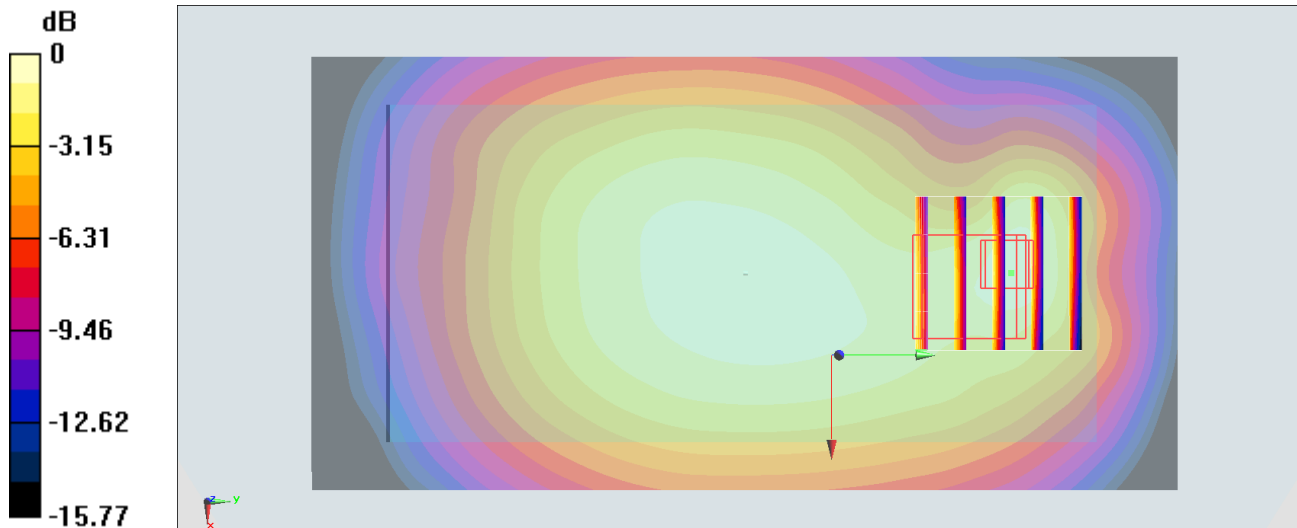

0 dB = 0.438 W/kg = -3.59 dBW/kg

**#14\_LTE Band 12\_10M\_QPSK\_1\_25\_Back\_10mm\_Ch23095**

Communication System: LTE; Frequency: 707.5 MHz; Duty Cycle: 1:1

Medium: HSL\_750\_200305 Medium parameters used :  $f = 707.5$  MHz;  $\sigma = 0.858$  S/m;  $\epsilon_r = 41.601$ ;  $\rho = 1000$  kg/m<sup>3</sup>

Ambient Temperature : 23.4 °C ; Liquid Temperature : 22.4 °C

DASY5 Configuration:

- Probe: EX3DV4 - SN3728; ConvF(9.67, 9.67, 9.67) @ 707.5 MHz; Calibrated: 2020/2/4
- Sensor-Surface: 1.4mm (Mechanical Surface Detection)
- Electronics: DAE3 Sn495; Calibrated: 2019/5/21
- Phantom: SAM\_Left; Type: QD000P40CD; Serial: 1719
- Measurement SW: DASY52, Version 52.10 (2); SEMCAD X Version 14.6.12 (7450)

**Area Scan (61x121x1):** Interpolated grid: dx=1.500 mm, dy=1.500 mm

Maximum value of SAR (interpolated) = 0.0923 W/kg

**Zoom Scan (5x5x7)/Cube 0:** Measurement grid: dx=8mm, dy=8mm, dz=5mm

Reference Value = 10.28 V/m; Power Drift = -0.10 dB

Peak SAR (extrapolated) = 0.0960 W/kg

**SAR(1 g) = 0.077 W/kg; SAR(10 g) = 0.060 W/kg**

Maximum value of SAR (measured) = 0.0809 W/kg

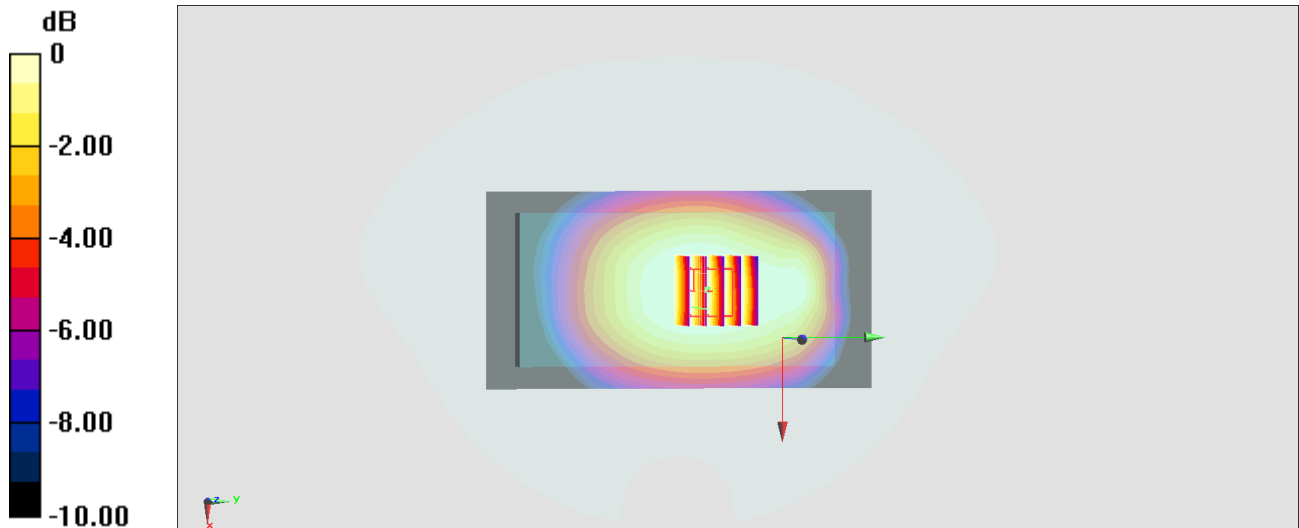

0 dB = 0.0809 W/kg = -10.92 dBW/kg

**#15\_WLAN2.4GHz\_802.11b 1Mbps\_Back\_10mm\_Ch11**

Communication System: 802.11b; Frequency: 2462 MHz; Duty Cycle: 1:1

Medium: HSL2450\_200303 Medium parameters used:  $f = 2462$  MHz;  $\sigma = 1.832$  S/m;  $\epsilon_r = 39.751$ ;  $\rho = 1000$  kg/m<sup>3</sup>

Ambient Temperature : 23.6 °C ; Liquid Temperature : 22.6 °C

DASY5 Configuration:

- Probe: EX3DV4 - SN7306; ConvF(7.48, 7.48, 7.48) @ 2462 MHz; Calibrated: 2019/7/22
- Sensor-Surface: 1.4mm (Mechanical Surface Detection)
- Electronics: DAE3 Sn577; Calibrated: 2019/9/17
- Phantom: SAM\_Left; Type: QD000P40CD; Serial: 1719
- Measurement SW: DASY52, Version 52.10 (2); SEMCAD X Version 14.6.12 (7450)

**Area Scan (71x101x1):** Interpolated grid: dx=1.200 mm, dy=1.200 mm

Maximum value of SAR (interpolated) = 0.572 W/kg

**Zoom Scan (7x7x7)/Cube 0:** Measurement grid: dx=5mm, dy=5mm, dz=5mm

Reference Value = 14.85 V/m; Power Drift = 0.07 dB

Peak SAR (extrapolated) = 0.712 W/kg

**SAR(1 g) = 0.339 W/kg; SAR(10 g) = 0.153 W/kg**

Maximum value of SAR (measured) = 0.571 W/kg

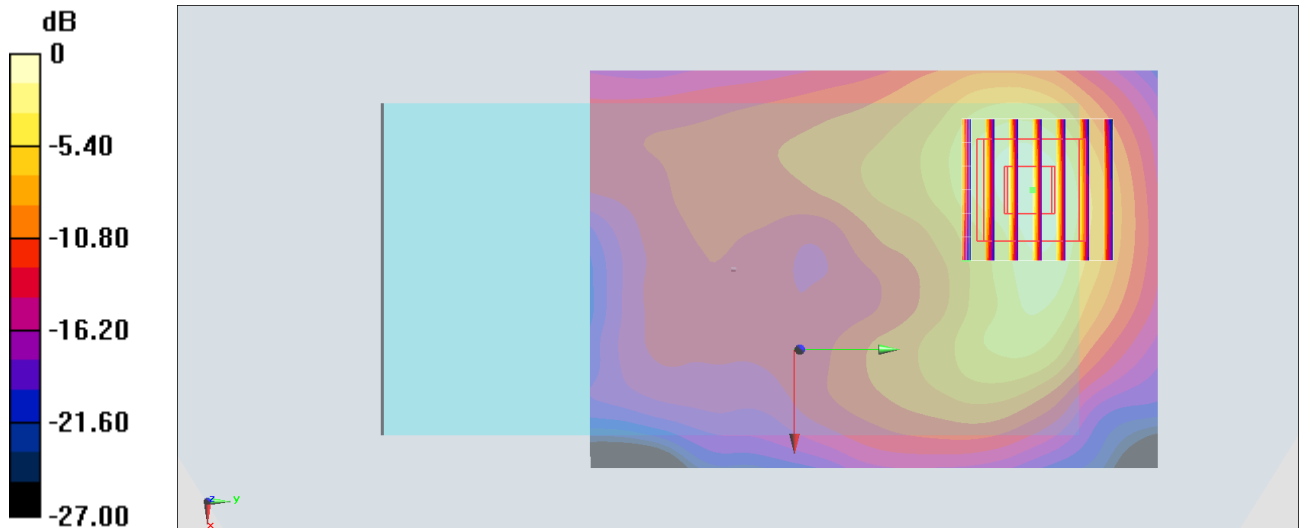

0 dB = 0.571 W/kg = -2.43 dBW/kg



## #16\_Bluetooth\_1Mbps\_Back\_10mm\_Ch0

Communication System: Bluetooth; Frequency: 2402 MHz; Duty Cycle: 1:1.269

Medium: HSL2450\_200303 Medium parameters used:  $f = 2402$  MHz;  $\sigma = 1.767$  S/m;  $\epsilon_r = 39.948$ ;  $\rho = 1000$  kg/m<sup>3</sup>

Ambient Temperature : 23.6 °C ; Liquid Temperature : 22.6 °C

DASY5 Configuration:

- Probe: EX3DV4 - SN7306; ConvF(7.48, 7.48, 7.48) @ 2402 MHz; Calibrated: 2019/7/22
- Sensor-Surface: 1.4mm (Mechanical Surface Detection)
- Electronics: DAE3 Sn577; Calibrated: 2019/9/17
- Phantom: SAM\_Left; Type: QD000P40CD; Serial: 1719
- Measurement SW: DASY52, Version 52.10 (2); SEMCAD X Version 14.6.12 (7450)

**Area Scan (71x101x1):** Interpolated grid: dx=1.200 mm, dy=1.200 mm

Maximum value of SAR (interpolated) = 0.101 W/kg

**Zoom Scan (7x7x7)/Cube 0:** Measurement grid: dx=5mm, dy=5mm, dz=5mm

Reference Value = 6.118 V/m; Power Drift = -0.01 dB

Peak SAR (extrapolated) = 0.120 W/kg

**SAR(1 g) = 0.057 W/kg; SAR(10 g) = 0.024 W/kg**

Maximum value of SAR (measured) = 0.0974 W/kg

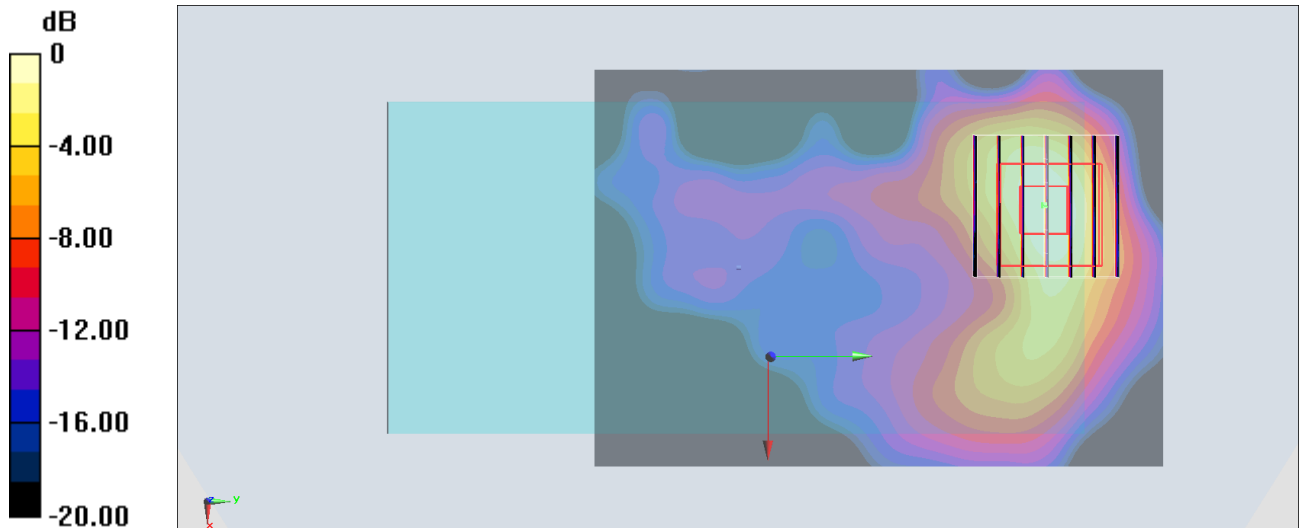

**#17\_GSM850\_GPRS (4 Tx slots)\_Back\_10mm\_Ch189**

Communication System: GSM850 ; Frequency: 836.4 MHz; Duty Cycle: 1:2.08

Medium: HSL\_850\_200308 Medium parameters used :  $f = 836.4$  MHz;  $\sigma = 0.896$  S/m;  $\epsilon_r = 42.267$ ;  $\rho = 1000$  kg/m<sup>3</sup>

Ambient Temperature : 23.4 °C ; Liquid Temperature : 22.4 °C

DASY5 Configuration:

- Probe: EX3DV4 - SN3728; ConvF(9.51, 9.51, 9.51) @ 836.4 MHz; Calibrated: 2020/2/4
- Sensor-Surface: 1.4mm (Mechanical Surface Detection)
- Electronics: DAE3 Sn495; Calibrated: 2019/5/21
- Phantom: SAM\_Left; Type: QD000P40CD; Serial: 1719
- Measurement SW: DASY52, Version 52.10 (2); SEMCAD X Version 14.6.12 (7450)

**Area Scan (71x121x1):** Interpolated grid: dx=1.500 mm, dy=1.500 mm

Maximum value of SAR (interpolated) = 0.265 W/kg

**Zoom Scan (5x5x7)/Cube 0:** Measurement grid: dx=8mm, dy=8mm, dz=5mm

Reference Value = 16.41 V/m; Power Drift = 0.11 dB

Peak SAR (extrapolated) = 0.334 W/kg

**SAR(1 g) = 0.187 W/kg; SAR(10 g) = 0.108 W/kg**

Maximum value of SAR (measured) = 0.277 W/kg

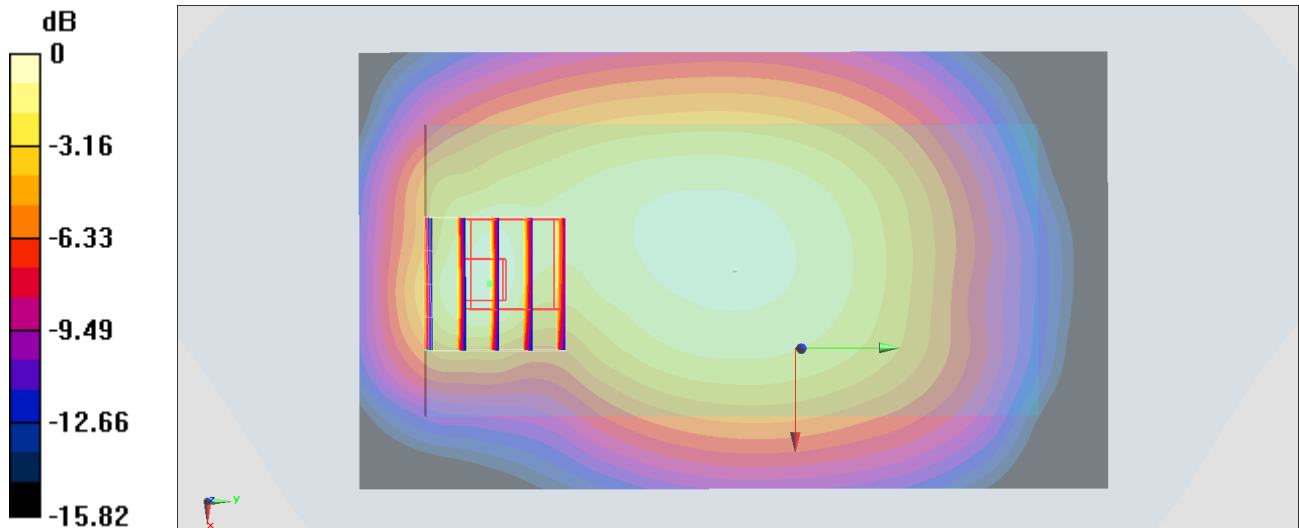

0 dB = 0.277 W/kg = -5.58 dBW/kg

**#18\_GSM1900\_GPRS (4 Tx slots)\_Back\_10mm\_Ch512**

Communication System: PCS; Frequency: 1850.2 MHz; Duty Cycle: 1:2.08

Medium: HSL\_1900\_200306 Medium parameters used :  $f = 1850.2$  MHz;  $\sigma = 1.354$  S/m;  $\epsilon_r = 40.795$ ;  $\rho = 1000$  kg/m<sup>3</sup>

Ambient Temperature : 23.4 °C; Liquid Temperature : 22.4 °C

DASY5 Configuration:

- Probe: EX3DV4 - SN3728; ConvF(7.82, 7.82, 7.82) @ 1850.2 MHz; Calibrated: 2020/2/4
- Sensor-Surface: 1.4mm (Mechanical Surface Detection)
- Electronics: DAE3 Sn495; Calibrated: 2019/5/21
- Phantom: SAM\_Right; Type: SAM; Serial: TP:1446
- Measurement SW: DASY52, Version 52.10 (2); SEMCAD X Version 14.6.12 (7450)

**Area Scan (71x121x1):** Interpolated grid: dx=1.500 mm, dy=1.500 mm

Maximum value of SAR (interpolated) = 0.416 W/kg

**Zoom Scan (5x5x7)/Cube 0:** Measurement grid: dx=8mm, dy=8mm, dz=5mm

Reference Value = 6.965 V/m; Power Drift = 0.07 dB

Peak SAR (extrapolated) = 0.540 W/kg

**SAR(1 g) = 0.266 W/kg; SAR(10 g) = 0.135 W/kg**

Maximum value of SAR (measured) = 0.440 W/kg

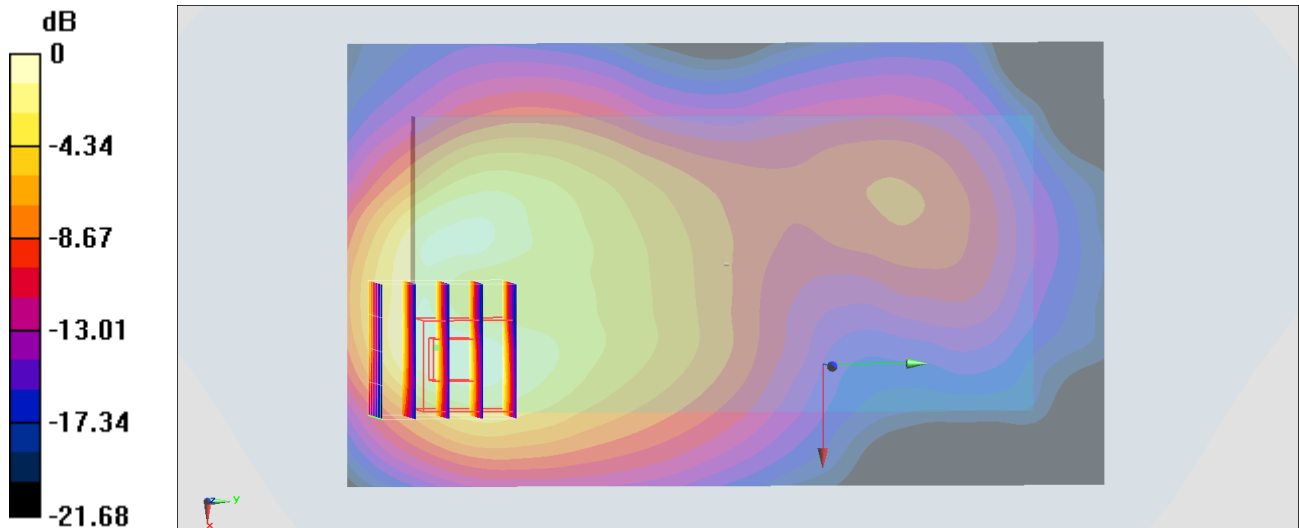

0 dB = 0.440 W/kg = -3.57 dBW/kg

## #19\_WCDMA V\_RMC 12.2Kbps\_Back\_10mm\_Ch4182

Communication System: WCDMA; Frequency: 836.4 MHz; Duty Cycle: 1:1

Medium: HSL\_850\_200308 Medium parameters used :  $f = 836.4$  MHz;  $\sigma = 0.896$  S/m;  $\epsilon_r = 42.267$ ;  $\rho = 1000$  kg/m<sup>3</sup>

Ambient Temperature : 23.4 °C ; Liquid Temperature : 22.4 °C

DASY5 Configuration:

- Probe: EX3DV4 - SN3728; ConvF(9.51, 9.51, 9.51) @ 836.4 MHz; Calibrated: 2020/2/4
- Sensor-Surface: 1.4mm (Mechanical Surface Detection)
- Electronics: DAE3 Sn495; Calibrated: 2019/5/21
- Phantom: SAM\_Left; Type: QD000P40CD; Serial: 1719
- Measurement SW: DASY52, Version 52.10 (2); SEMCAD X Version 14.6.12 (7450)

**Area Scan (61x121x1):** Interpolated grid: dx=1.500 mm, dy=1.500 mm

Maximum value of SAR (interpolated) = 0.455 W/kg

**Zoom Scan (5x5x7)/Cube 0:** Measurement grid: dx=8mm, dy=8mm, dz=5mm

Reference Value = 19.13 V/m; Power Drift = 0.04 dB

Peak SAR (extrapolated) = 0.519 W/kg

**SAR(1 g) = 0.297 W/kg; SAR(10 g) = 0.177 W/kg**

Maximum value of SAR (measured) = 0.318 W/kg

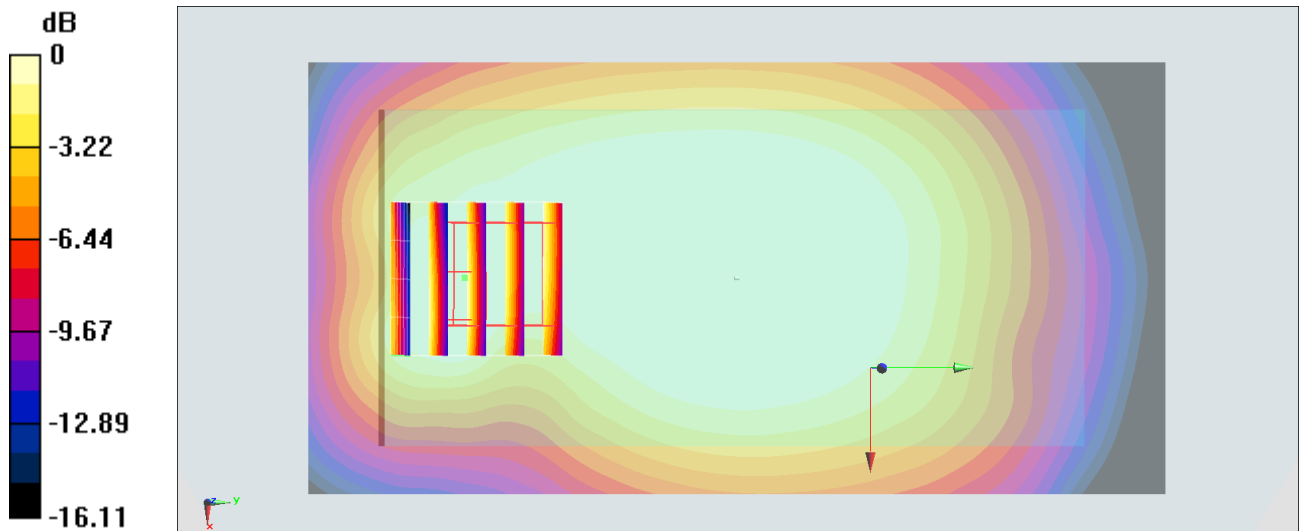

0 dB = 0.318 W/kg = -4.98 dBW/kg

## #20\_LTE Band 5\_10M\_QPSK\_1\_25\_Back\_10mm\_Ch20525

Communication System: LTE ; Frequency: 836.5 MHz; Duty Cycle: 1:1

Medium: HSL\_850\_200308 Medium parameters used :  $f = 836.5$  MHz;  $\sigma = 0.896$  S/m;  $\epsilon_r = 42.266$ ;  $\rho = 1000$  kg/m<sup>3</sup>

Ambient Temperature : 23.4 °C ; Liquid Temperature : 22.4 °C

DASY5 Configuration:

- Probe: EX3DV4 - SN3728; ConvF(9.51, 9.51, 9.51) @ 836.5 MHz; Calibrated: 2020/2/4
- Sensor-Surface: 1.4mm (Mechanical Surface Detection)
- Electronics: DAE3 Sn495; Calibrated: 2019/5/21
- Phantom: SAM\_Left; Type: QD000P40CD; Serial: 1719
- Measurement SW: DASY52, Version 52.10 (2); SEMCAD X Version 14.6.12 (7450)

**Area Scan (61x121x1):** Interpolated grid: dx=1.500 mm, dy=1.500 mm

Maximum value of SAR (interpolated) = 0.427 W/kg

**Zoom Scan (5x5x7)/Cube 0:** Measurement grid: dx=8mm, dy=8mm, dz=5mm

Reference Value = 22.07 V/m; Power Drift = -0.06 dB

Peak SAR (extrapolated) = 0.530 W/kg

**SAR(1 g) = 0.303 W/kg; SAR(10 g) = 0.179 W/kg**

Maximum value of SAR (measured) = 0.438 W/kg

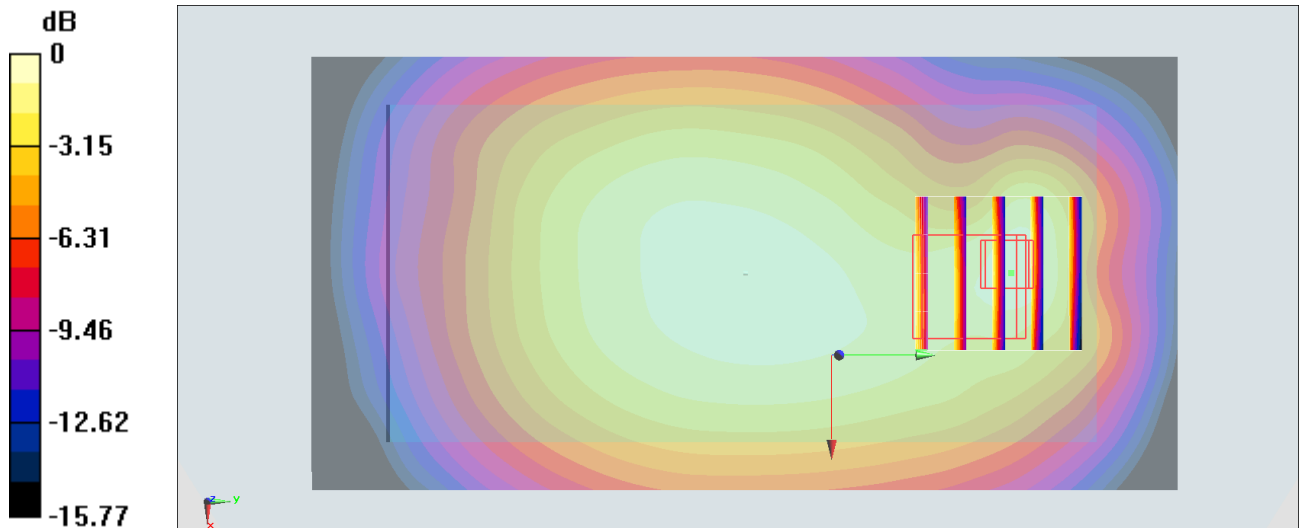

0 dB = 0.438 W/kg = -3.59 dBW/kg

**#21\_LTE Band 12\_10M\_QPSK\_1\_25\_Back\_10mm\_Ch23095**

Communication System: LTE; Frequency: 707.5 MHz; Duty Cycle: 1:1

Medium: HSL\_750\_200305 Medium parameters used :  $f = 707.5$  MHz;  $\sigma = 0.858$  S/m;  $\epsilon_r = 41.601$ ;  $\rho = 1000$  kg/m<sup>3</sup>

Ambient Temperature : 23.4 °C ; Liquid Temperature : 22.4 °C

DASY5 Configuration:

- Probe: EX3DV4 - SN3728; ConvF(9.67, 9.67, 9.67) @ 707.5 MHz; Calibrated: 2020/2/4
- Sensor-Surface: 1.4mm (Mechanical Surface Detection)
- Electronics: DAE3 Sn495; Calibrated: 2019/5/21
- Phantom: SAM\_Left; Type: QD000P40CD; Serial: 1719
- Measurement SW: DASY52, Version 52.10 (2); SEMCAD X Version 14.6.12 (7450)

**Area Scan (61x121x1):** Interpolated grid: dx=1.500 mm, dy=1.500 mm

Maximum value of SAR (interpolated) = 0.0923 W/kg

**Zoom Scan (5x5x7)/Cube 0:** Measurement grid: dx=8mm, dy=8mm, dz=5mm

Reference Value = 10.28 V/m; Power Drift = -0.10 dB

Peak SAR (extrapolated) = 0.0960 W/kg

**SAR(1 g) = 0.077 W/kg; SAR(10 g) = 0.060 W/kg**

Maximum value of SAR (measured) = 0.0809 W/kg

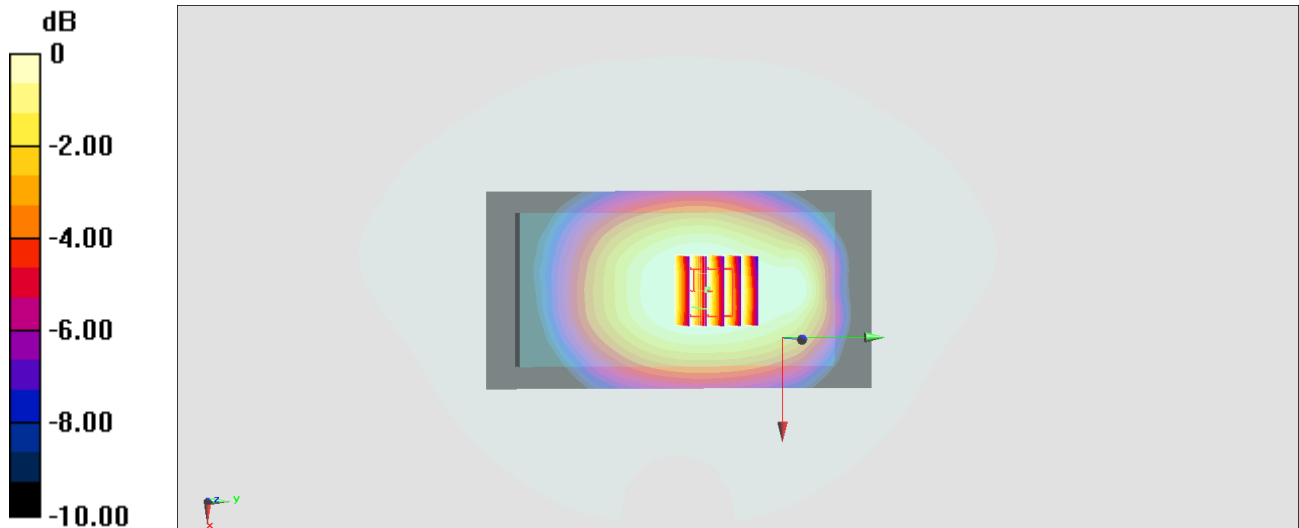

0 dB = 0.0809 W/kg = -10.92 dBW/kg

## #22\_WLAN2.4GHz\_802.11b 1Mbps\_Back\_10mm\_Ch11

Communication System: 802.11b; Frequency: 2462 MHz; Duty Cycle: 1:1

Medium: HSL2450\_200303 Medium parameters used:  $f = 2462$  MHz;  $\sigma = 1.832$  S/m;  $\epsilon_r = 39.751$ ;  $\rho = 1000$  kg/m<sup>3</sup>

Ambient Temperature : 23.6 °C ; Liquid Temperature : 22.6 °C

DASY5 Configuration:

- Probe: EX3DV4 - SN7306; ConvF(7.48, 7.48, 7.48) @ 2462 MHz; Calibrated: 2019/7/22
- Sensor-Surface: 1.4mm (Mechanical Surface Detection)
- Electronics: DAE3 Sn577; Calibrated: 2019/9/17
- Phantom: SAM\_Left; Type: QD000P40CD; Serial: 1719
- Measurement SW: DASY52, Version 52.10 (2); SEMCAD X Version 14.6.12 (7450)

**Area Scan (71x101x1):** Interpolated grid: dx=1.200 mm, dy=1.200 mm

Maximum value of SAR (interpolated) = 0.572 W/kg

**Zoom Scan (7x7x7)/Cube 0:** Measurement grid: dx=5mm, dy=5mm, dz=5mm

Reference Value = 14.85 V/m; Power Drift = 0.07 dB

Peak SAR (extrapolated) = 0.712 W/kg

**SAR(1 g) = 0.339 W/kg; SAR(10 g) = 0.153 W/kg**

Maximum value of SAR (measured) = 0.571 W/kg

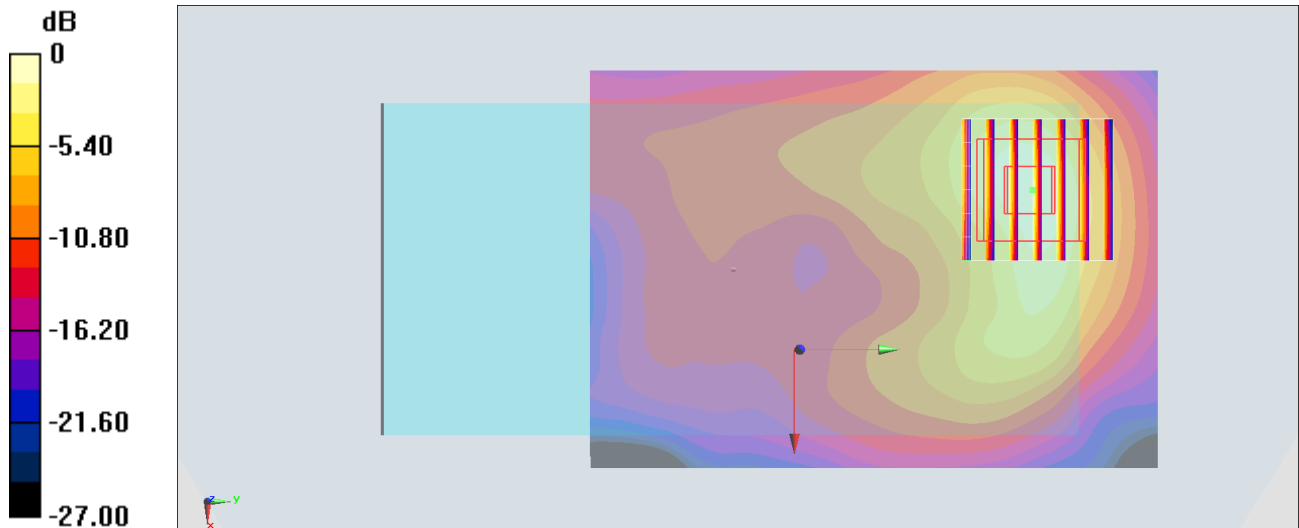

0 dB = 0.571 W/kg = -2.43 dBW/kg

**#23\_WLAN5GHz\_802.11ac-VHT80 MCS0\_Back\_10mm\_Ch58**

Communication System: 802.11ac; Frequency: 5290 MHz; Duty Cycle: 1:1.03

Medium: HSL\_5G\_200310 Medium parameters used :  $f = 5290$  MHz;  $\sigma = 4.697$  S/m;  $\epsilon_r = 36.262$ ;  $\rho = 1000$  kg/m<sup>3</sup>

Ambient Temperature : 23.6 °C ; Liquid Temperature : 22.6 °C

DASY5 Configuration:

- Probe: EX3DV4 - SN7306; ConvF(5.34, 5.34, 5.34) @ 5290 MHz; Calibrated: 2019/7/22
- Sensor-Surface: 1.4mm (Mechanical Surface Detection)
- Electronics: DAE3 Sn577; Calibrated: 2019/9/17
- Phantom: SAM\_Right; Type: SAM; Serial: TP:1446
- Measurement SW: DASY52, Version 52.10 (2); SEMCAD X Version 14.6.12 (7450)

**Area Scan (91x61x1):** Interpolated grid: dx=1.000 mm, dy=1.000 mm

Maximum value of SAR (interpolated) = 0.387 W/kg

**Zoom Scan (7x7x7)/Cube 0:** Measurement grid: dx=4mm, dy=4mm, dz=1.4mm

Reference Value = 7.835 V/m; Power Drift = -0.15 dB

Peak SAR (extrapolated) = 0.624 W/kg

**SAR(1 g) = 0.163 W/kg; SAR(10 g) = 0.054 W/kg**

Maximum value of SAR (measured) = 0.385 W/kg

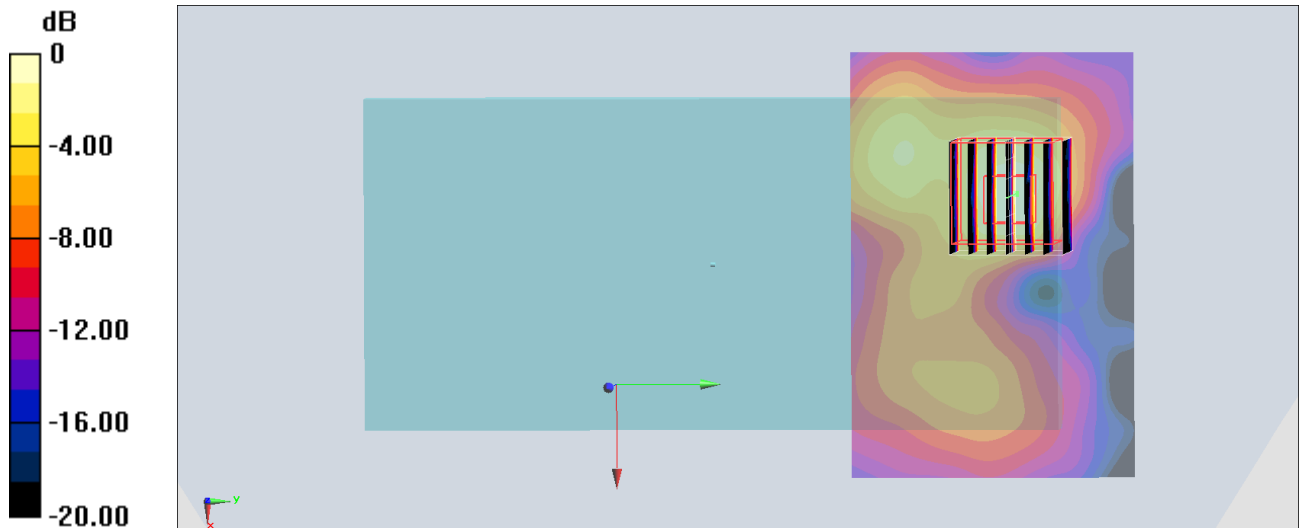

0 dB = 0.385 W/kg = -4.15 dBW/kg



## #24\_WLAN5GHz\_802.11ac-VHT80 MCS0\_Back\_10mm\_Ch122

Communication System: 802.11ac; Frequency: 5610 MHz; Duty Cycle: 1:1.03

Medium: HSL\_5G\_200310 Medium parameters used :  $f = 5610$  MHz;  $\sigma = 5.014$  S/m;  $\epsilon_r = 35.822$ ;  $\rho = 1000$  kg/m<sup>3</sup>

Ambient Temperature : 23.6 °C ; Liquid Temperature : 22.6 °C

DASY5 Configuration:

- Probe: EX3DV4 - SN7306; ConvF(4.79, 4.79, 4.79) @ 5610 MHz; Calibrated: 2019/7/22
- Sensor-Surface: 1.4mm (Mechanical Surface Detection)
- Electronics: DAE3 Sn577; Calibrated: 2019/9/17
- Phantom: SAM\_Right; Type: SAM; Serial: TP:1446
- Measurement SW: DASY52, Version 52.10 (2); SEMCAD X Version 14.6.12 (7450)

**Area Scan (91x61x1):** Interpolated grid: dx=1.000 mm, dy=1.000 mm

Maximum value of SAR (interpolated) = 0.335 W/kg

**Zoom Scan (7x7x7)/Cube 0:** Measurement grid: dx=4mm, dy=4mm, dz=1.4mm

Reference Value = 8.146 V/m; Power Drift = -0.13 dB

Peak SAR (extrapolated) = 0.589 W/kg

**SAR(1 g) = 0.145 W/kg; SAR(10 g) = 0.050 W/kg**

Maximum value of SAR (measured) = 0.340 W/kg

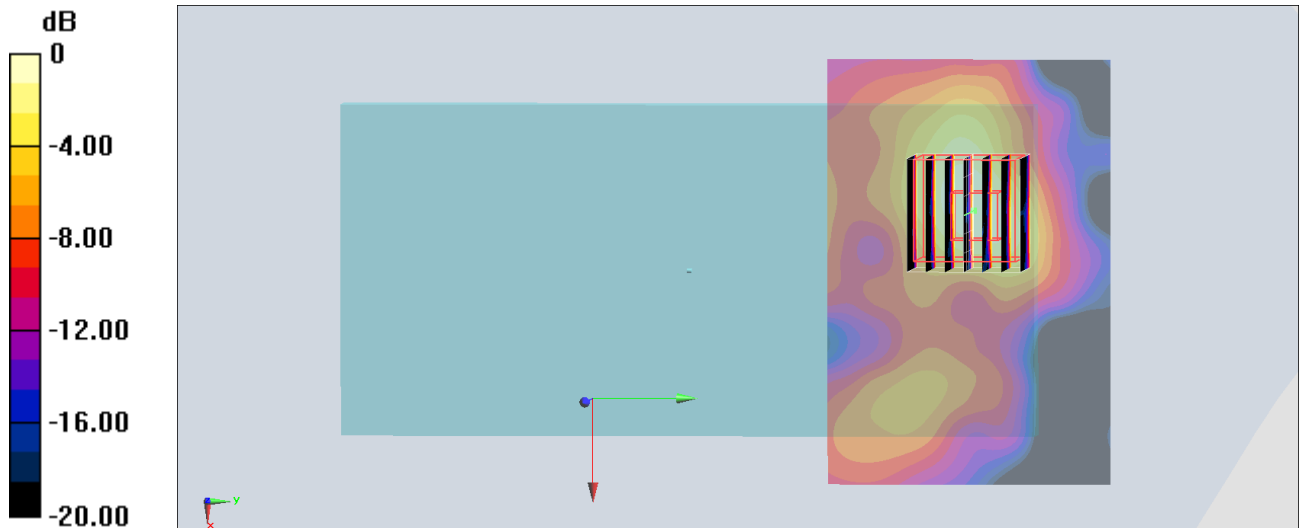

0 dB = 0.340 W/kg = -4.69 dBW/kg

## #25\_Bluetooth\_1Mbps\_Back\_10mm\_Ch0

Communication System: Bluetooth; Frequency: 2402 MHz; Duty Cycle: 1:1.269

Medium: HSL2450\_200303 Medium parameters used:  $f = 2402$  MHz;  $\sigma = 1.767$  S/m;  $\epsilon_r = 39.948$ ;  $\rho = 1000$  kg/m<sup>3</sup>

Ambient Temperature : 23.6 °C ; Liquid Temperature : 22.6 °C

DASY5 Configuration:

- Probe: EX3DV4 - SN7306; ConvF(7.48, 7.48, 7.48) @ 2402 MHz; Calibrated: 2019/7/22
- Sensor-Surface: 1.4mm (Mechanical Surface Detection)
- Electronics: DAE3 Sn577; Calibrated: 2019/9/17
- Phantom: SAM\_Left; Type: QD000P40CD; Serial: 1719
- Measurement SW: DASY52, Version 52.10 (2); SEMCAD X Version 14.6.12 (7450)

**Area Scan (71x101x1):** Interpolated grid: dx=1.200 mm, dy=1.200 mm

Maximum value of SAR (interpolated) = 0.101 W/kg

**Zoom Scan (7x7x7)/Cube 0:** Measurement grid: dx=5mm, dy=5mm, dz=5mm

Reference Value = 6.118 V/m; Power Drift = -0.01 dB

Peak SAR (extrapolated) = 0.120 W/kg

**SAR(1 g) = 0.057 W/kg; SAR(10 g) = 0.024 W/kg**

Maximum value of SAR (measured) = 0.0974 W/kg

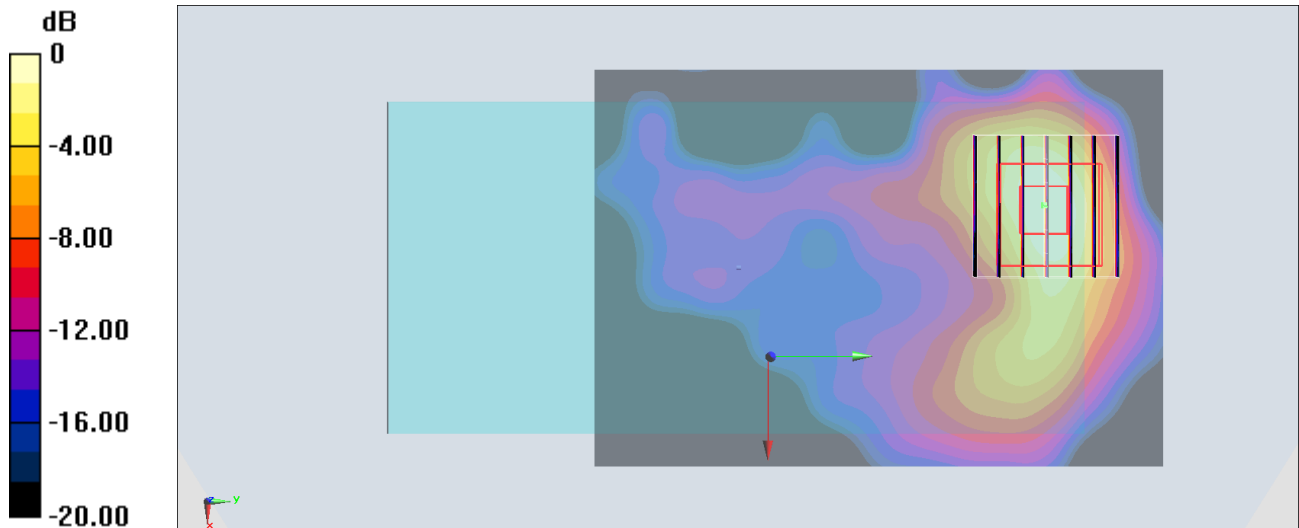

0 dB = 0.0974 W/kg = -10.11 dBW/kg



---

**Appendix C.    *DASY Calibration Certificate***

The DASY calibration certificates are shown as follows.



In Collaboration with  
**s p e a g**  
CALIBRATION LABORATORY



中国认可  
国际互认  
校准  
CALIBRATION  
CNAS L0570

Add: No.51 Xueyuan Road, Haidian District, Beijing, 100191, China  
Tel: +86-10-62304633-2079 Fax: +86-10-62304633-2504  
E-mail: cttl@chinattl.com http://www.chinattl.cn

Client **Sporton**

Certificate No: **Z19-60054**

## CALIBRATION CERTIFICATE

Object **D750V3 - SN: 1107**

Calibration Procedure(s) **FF-Z11-003-01**  
**Calibration Procedures for dipole validation kits**

Calibration date: **March 8, 2019**

This calibration Certificate documents the traceability to national standards, which realize the physical units of measurements(SI). The measurements and the uncertainties with confidence probability are given on the following pages and are part of the certificate.

All calibrations have been conducted in the closed laboratory facility: environment temperature(22±3)°C and humidity<70%.

Calibration Equipment used (M&TE critical for calibration)

Primary Standards	ID #	Cal Date(Calibrated by, Certificate No.)	Scheduled Calibration
Power Meter NRP2	106277	20-Aug-18 (CTTL, No.J18X06862)	Aug-19
Power sensor NRP8S	104291	20-Aug-18 (CTTL, No.J18X06862)	Aug-19
Reference Probe EX3DV4	SN 3617	31-Jan-19(SPEAG,No.EX3-3617_Jan19)	Jan-20
DAE4	SN 1331	06-Feb-19(SPEAG,No.DAE4-1331_Feb19)	Feb-20
Secondary Standards	ID #	Cal Date(Calibrated by, Certificate No.)	Scheduled Calibration
Signal Generator E4438C	MY49071430	23-Jan-19 (CTTL, No.J19X00336)	Jan-20
NetworkAnalyzer E5071C	MY46110673	24-Jan-19 (CTTL, No.J19X00547)	Jan-20

	Name	Function	Signature
Calibrated by:	Zhao Jing	SAR Test Engineer	
Reviewed by:	Yu Zongying	SAR Test Engineer	
Approved by:	Qi Dianyuan	SAR Project Leader	

Issued: March 10, 2019

This calibration certificate shall not be reproduced except in full without written approval of the laboratory.



Add: No.51 Xueyuan Road, Haidian District, Beijing, 100191, China  
Tel: +86-10-62304633-2079 Fax: +86-10-62304633-2504  
E-mail: cttl@chinattl.com http://www.chinattl.cn

### Glossary:

TSL	tissue simulating liquid
ConvF	sensitivity in TSL / NORM <sub>x,y,z</sub>
N/A	not applicable or not measured

### Calibration is Performed According to the Following Standards:

- IEEE Std 1528-2013, "IEEE Recommended Practice for Determining the Peak Spatial-Averaged Specific Absorption Rate (SAR) in the Human Head from Wireless Communications Devices: Measurement Techniques", June 2013
- IEC 62209-1, "Measurement procedure for assessment of specific absorption rate of human exposure to radio frequency fields from hand-held and body-mounted wireless communication devices- Part 1: Device used next to the ear (Frequency range of 300MHz to 6GHz)", July 2016
- IEC 62209-2, "Procedure to measure the Specific Absorption Rate (SAR) For wireless communication devices used in close proximity to the human body (frequency range of 30MHz to 6GHz)", March 2010
- KDB865664, SAR Measurement Requirements for 100 MHz to 6 GHz

### Additional Documentation:

- DASY4/5 System Handbook

### Methods Applied and Interpretation of Parameters:

- Measurement Conditions:** Further details are available from the Validation Report at the end of the certificate. All figures stated in the certificate are valid at the frequency indicated.
- Antenna Parameters with TSL:** The dipole is mounted with the spacer to position its feed point exactly below the center marking of the flat phantom section, with the arms oriented parallel to the body axis.
- Feed Point Impedance and Return Loss:** These parameters are measured with the dipole positioned under the liquid filled phantom. The impedance stated is transformed from the measurement at the SMA connector to the feed point. The Return Loss ensures low reflected power. No uncertainty required.
- Electrical Delay:** One-way delay between the SMA connector and the antenna feed point. No uncertainty required.
- SAR measured:** SAR measured at the stated antenna input power.
- SAR normalized:** SAR as measured, normalized to an input power of 1 W at the antenna connector.
- SAR for nominal TSL parameters:** The measured TSL parameters are used to calculate the nominal SAR result.

The reported uncertainty of measurement is stated as the standard uncertainty of Measurement multiplied by the coverage factor  $k=2$ , which for a normal distribution Corresponds to a coverage probability of approximately 95%.



Add: No.51 Xueyuan Road, Haidian District, Beijing, 100191, China  
Tel: +86-10-62304633-2079 Fax: +86-10-62304633-2504  
E-mail: cttl@chinattl.com http://www.chinattl.cn

### Measurement Conditions

DASY system configuration, as far as not given on page 1.

<b>DASY Version</b>	DASY52	52.10.2.1495
<b>Extrapolation</b>	Advanced Extrapolation	
<b>Phantom</b>	Triple Flat Phantom 5.1C	
<b>Distance Dipole Center - TSL</b>	15 mm	with Spacer
<b>Zoom Scan Resolution</b>	dx, dy, dz = 5 mm	
<b>Frequency</b>	750 MHz ± 1 MHz	

### Head TSL parameters

The following parameters and calculations were applied.

	Temperature	Permittivity	Conductivity
<b>Nominal Head TSL parameters</b>	22.0 °C	41.9	0.89 mho/m
<b>Measured Head TSL parameters</b>	(22.0 ± 0.2) °C	43.1 ± 6 %	0.86 mho/m ± 6 %
<b>Head TSL temperature change during test</b>	<1.0 °C	----	----

### SAR result with Head TSL

<b>SAR averaged over 1 cm<sup>3</sup> (1 g) of Head TSL</b>	Condition	
SAR measured	250 mW input power	2.02 W/kg
SAR for nominal Head TSL parameters	normalized to 1W	<b>8.32 W/kg ± 18.8 % (k=2)</b>
<b>SAR averaged over 10 cm<sup>3</sup> (10 g) of Head TSL</b>	Condition	
SAR measured	250 mW input power	1.37 W/kg
SAR for nominal Head TSL parameters	normalized to 1W	<b>5.61 W/kg ± 18.7 % (k=2)</b>

### Body TSL parameters

The following parameters and calculations were applied.

	Temperature	Permittivity	Conductivity
<b>Nominal Body TSL parameters</b>	22.0 °C	55.5	0.96 mho/m
<b>Measured Body TSL parameters</b>	(22.0 ± 0.2) °C	54.8 ± 6 %	0.94 mho/m ± 6 %
<b>Body TSL temperature change during test</b>	<1.0 °C	----	----

### SAR result with Body TSL

<b>SAR averaged over 1 cm<sup>3</sup> (1 g) of Body TSL</b>	Condition	
SAR measured	250 mW input power	2.09 W/kg
SAR for nominal Body TSL parameters	normalized to 1W	<b>8.45 W/kg ± 18.8 % (k=2)</b>
<b>SAR averaged over 10 cm<sup>3</sup> (10 g) of Body TSL</b>	Condition	
SAR measured	250 mW input power	1.40 W/kg
SAR for nominal Body TSL parameters	normalized to 1W	<b>5.65 W/kg ± 18.7 % (k=2)</b>



Add: No.51 Xueyuan Road, Haidian District, Beijing, 100191, China  
Tel: +86-10-62304633-2079 Fax: +86-10-62304633-2504  
E-mail: cttl@chinattl.com http://www.chinattl.cn

## Appendix (Additional assessments outside the scope of CNAS L0570)

### Antenna Parameters with Head TSL

Impedance, transformed to feed point	55.2Ω- 1.55jΩ
Return Loss	- 25.7dB

### Antenna Parameters with Body TSL

Impedance, transformed to feed point	48.4Ω- 3.30jΩ
Return Loss	- 28.6dB

### General Antenna Parameters and Design

Electrical Delay (one direction)	0.980 ns
----------------------------------	----------

After long term use with 100W radiated power, only a slight warming of the dipole near the feedpoint can be measured.

The dipole is made of standard semirigid coaxial cable. The center conductor of the feeding line is directly connected to the second arm of the dipole. The antenna is therefore short-circuited for DC-signals. On some of the dipoles, small end caps are added to the dipole arms in order to improve matching when loaded according to the position as explained in the "Measurement Conditions" paragraph. The SAR data are not affected by this change. The overall dipole length is still according to the Standard.

No excessive force must be applied to the dipole arms, because they might bend or the soldered connections near the feedpoint may be damaged.

### Additional EUT Data

Manufactured by	SPEAG
-----------------	-------



Add: No.51 Xueyuan Road, Haidian District, Beijing, 100191, China  
Tel: +86-10-62304633-2079 Fax: +86-10-62304633-2504  
E-mail: cttl@chinattl.com http://www.chinattl.cn

### DASY5 Validation Report for Head TSL

Date: 03.07.2019

Test Laboratory: CTTL, Beijing, China

**DUT: Dipole 750 MHz; Type: D750V3; Serial: D750V3 - SN: 1107**

Communication System: UID 0, CW; Frequency: 750 MHz; Duty Cycle: 1:1

Medium parameters used:  $f = 750$  MHz;  $\sigma = 0.864$  S/m;  $\epsilon_r = 43.14$ ;  $\rho = 1000$  kg/m<sup>3</sup>

Phantom section: Right Section

DASY5 Configuration:

- Probe: EX3DV4 - SN3617; ConvF(10.03, 10.03, 10.03) @ 750 MHz; Calibrated: 1/31/2019
- Sensor-Surface: 1.4mm (Mechanical Surface Detection)
- Electronics: DAE4 Sn1331; Calibrated: 2/6/2019
- Phantom: MFP\_V5.1C ; Type: QD 000 P51CA; Serial: 1062
- Measurement SW: DASY52, Version 52.10 (2); SEMCAD X Version 14.6.12 (7450)

**Dipole Calibration/Zoom Scan (7x7x7) (7x7x7)/Cube 0:** Measurement grid: dx=5mm, dy=5mm, dz=5mm

Reference Value = 54.80 V/m; Power Drift = -0.04 dB

Peak SAR (extrapolated) = 2.90 W/kg

**SAR(1 g) = 2.02 W/kg; SAR(10 g) = 1.37 W/kg**

Maximum value of SAR (measured) = 2.62 W/kg

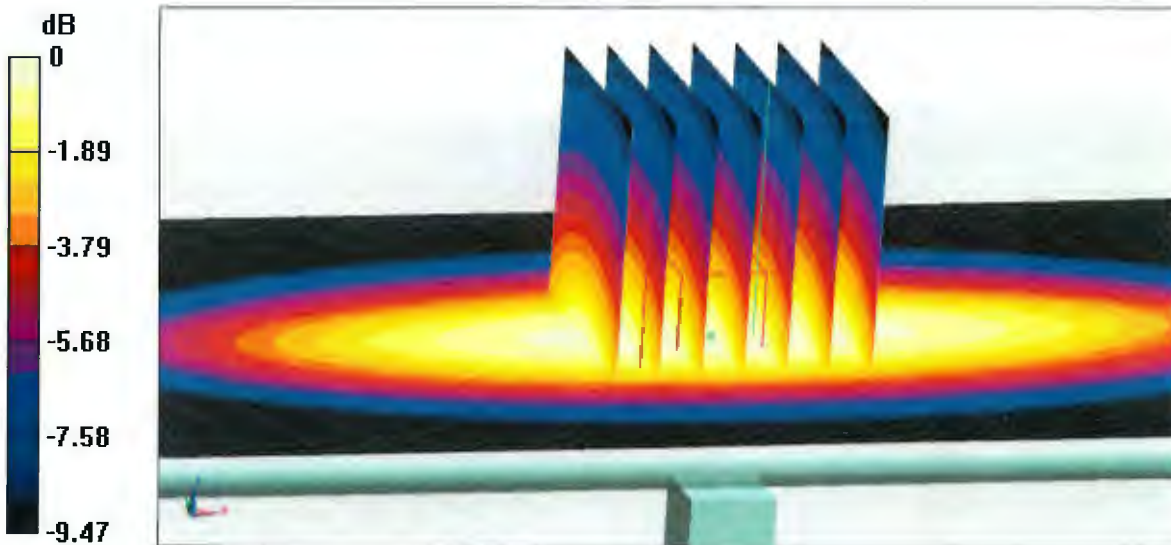

**0 dB = 2.62 W/kg = 4.18 dBW/kg**





Add: No.51 Xueyuan Road, Haidian District, Beijing, 100191, China  
Tel: +86-10-62304633-2079 Fax: +86-10-62304633-2504  
E-mail: ctl@chinattl.com http://www.chinattl.cn

### Impedance Measurement Plot for Head TSL

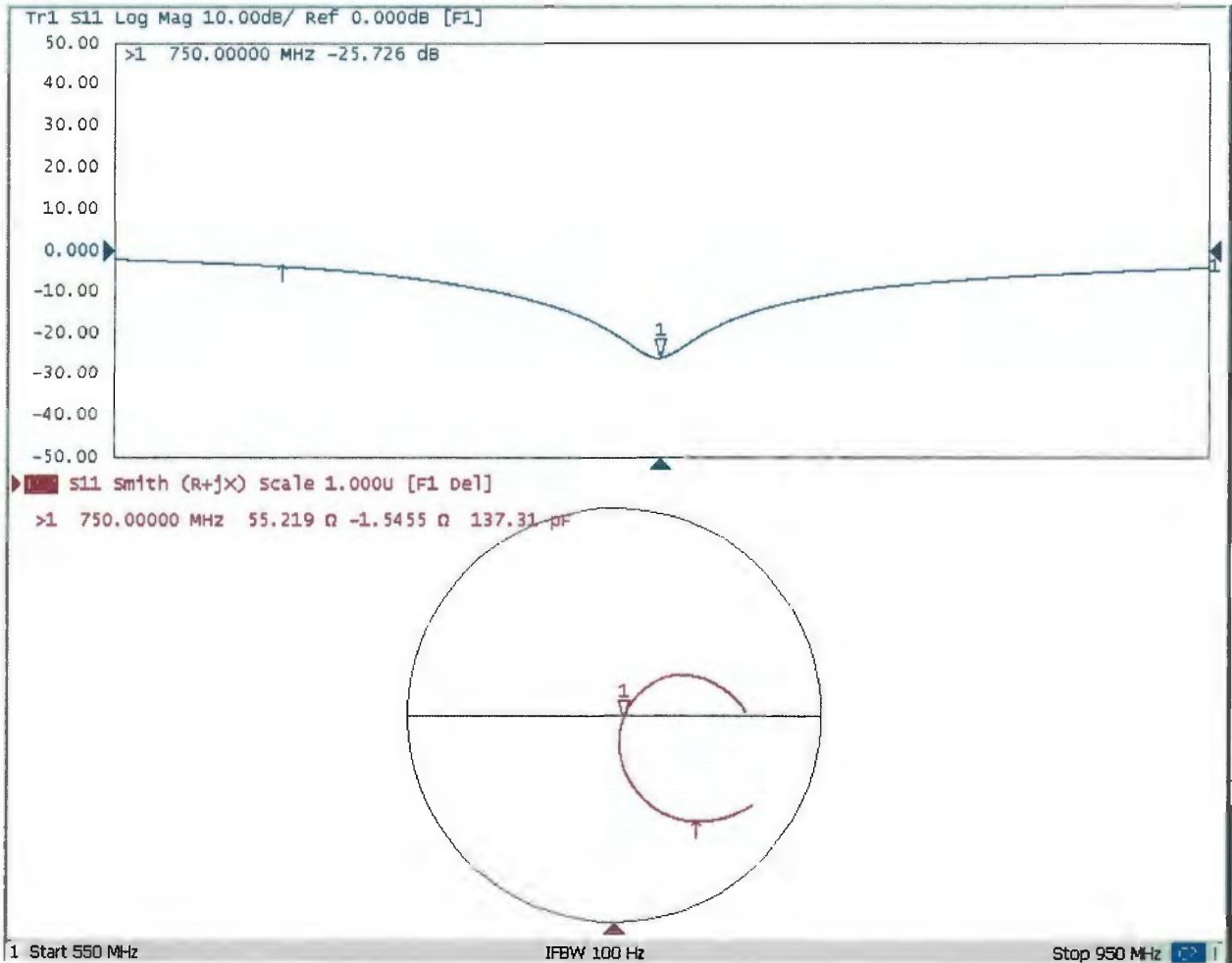



Add: No.51 Xueyuan Road, Haidian District, Beijing, 100191, China  
Tel: +86-10-62304633-2079 Fax: +86-10-62304633-2504  
E-mail: cttl@chinattl.com http://www.chinattl.cn

**DASY5 Validation Report for Body TSL**

Date: 03.07.2019

Test Laboratory: CTTL, Beijing, China

**DUT: Dipole 750 MHz; Type: D750V3; Serial: D750V3 - SN: 1107**

Communication System: UID 0, CW; Frequency: 750 MHz; Duty Cycle: 1:1

Medium parameters used:  $f = 750$  MHz;  $\sigma = 0.943$  S/m;  $\epsilon_r = 54.78$ ;  $\rho = 1000$  kg/m<sup>3</sup>

Phantom section: Center Section

DASY5 Configuration:

- Probe: EX3DV4 - SN3617; ConvF(9.85, 9.85, 9.85) @ 750 MHz; Calibrated: 1/31/2019
- Sensor-Surface: 1.4mm (Mechanical Surface Detection)
- Electronics: DAE4 Sn1331; Calibrated: 2/6/2019
- Phantom: MFP\_V5.1C ; Type: QD 000 P51CA; Serial: 1062
- Measurement SW: DASY52, Version 52.10 (2); SEMCAD X Version 14.6.12 (7450)

**Dipole Calibration/Zoom Scan (7x7x7) (7x7x7)/Cube 0:** Measurement grid: dx=5mm, dy=5mm, dz=5mm

Reference Value = 52.31 V/m; Power Drift = 0.00 dB

Peak SAR (extrapolated) = 3.09 W/kg

**SAR(1 g) = 2.09 W/kg; SAR(10 g) = 1.4 W/kg**

Maximum value of SAR (measured) = 2.75 W/kg

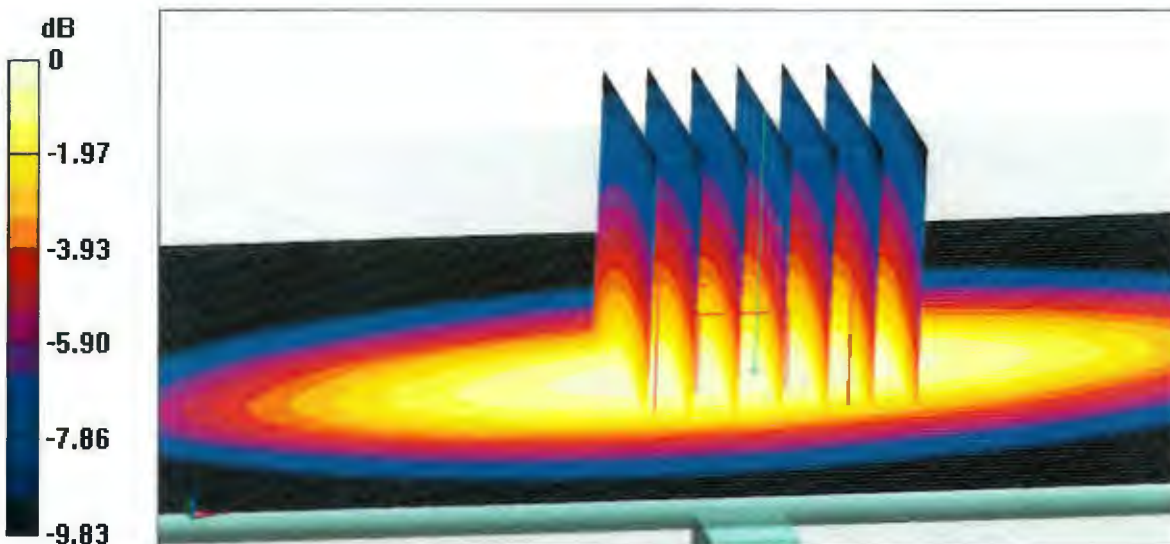

**0 dB = 2.75 W/kg = 4.39 dBW/kg**



Add: No.51 Xueyuan Road, Haidian District, Beijing, 100191, China  
Tel: +86-10-62304633-2079 Fax: +86-10-62304633-2504  
E-mail: cttl@chinattl.com http://www.chinattl.cn

### Impedance Measurement Plot for Body TSL

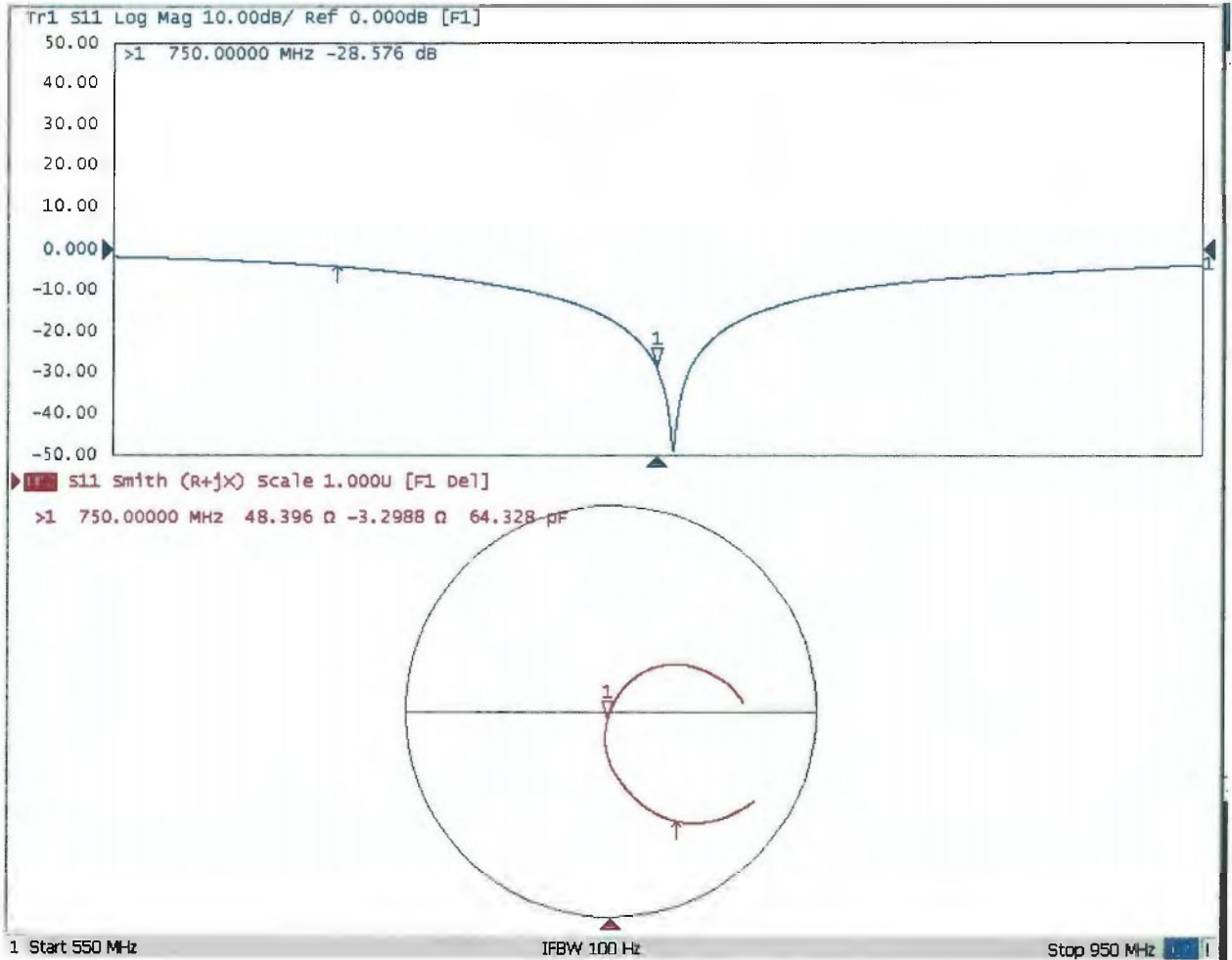

### D750V3, serial no. 1107 Extended Dipole Calibrations

Referring to KDB 450824, if dipoles are verified in return loss (<-20dB, within 20% of prior calibration), and in impedance (within 5 ohm of prior calibration), the annual calibration is not necessary and the calibration interval can be extended.

#### <Justification of the extended calibration>

D750V3 – serial no. 1107						
750MHZ						
Date of Measurement	Return-Loss (dB)	Delta (%)	Real Impedance (ohm)	Delta (ohm)	Imaginary Impedance (ohm)	Delta (ohm)
03.08.2019 (Cal. Report)	-25.726		55.219		-1.5455	
03.07.2020 (extended)	-25.760	0.13	59.446	-4.227	-3.2169	1.6714

The return loss is <-20dB, within 20% of prior calibration; the impedance is within 5 ohm of prior calibration. Therefore the verification result should support extended calibration.