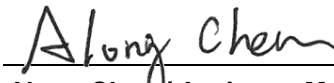

FCC Test Report

FCC ID : 2AQYEFMP176
Equipment : Mobile Phone
Model No. : F-51A
Brand Name : FUJITSU
Applicant : FUJITSU CONNECTED TECHNOLOGIES Ltd.
Address : Chuorinkan 7-10-1 Yamato, Kanagawa 242-0007,
Japan.
Standard : 47 CFR FCC Part 15.247
Received Date : Mar. 06, 2020
Tested Date : Apr. 13 ~ Apr. 29, 2020

We, International Certification Corp., would like to declare that the tested sample has been evaluated and in compliance with the requirement of the above standards. The test results contained in this report refer exclusively to the product. It may be duplicated completely for legal use with the approval of the applicant. It shall not be reproduced except in full without the written approval of our laboratory.

Reviewed by:

Along Chen / Assistant Manager

Approved by:

Gary Chang / Manager



Table of Contents

1	GENERAL DESCRIPTION	5
1.1	Information.....	5
1.2	Local Support Equipment List	11
1.3	Test Setup Chart	11
1.4	The Equipment List	12
1.5	Test Standards	13
1.6	Deviation from Test Standard and Measurement Procedure.....	13
1.7	Measurement Uncertainty	13
2	TEST CONFIGURATION	14
2.1	Testing Condition	14
2.2	The Worst Test Modes and Channel Details	14
3	TRANSMITTER TEST RESULTS.....	15
3.1	Conducted Emissions.....	15
3.2	6dB and Occupied Bandwidth	18
3.3	RF Output Power.....	37
3.4	Power Spectral Density	48
3.5	Unwanted Emissions into Restricted Frequency Bands	82
3.6	Emissions in Non-Restricted Frequency Bands.....	122
4	TEST LABORATORY INFORMATION	133

Release Record

Report No.	Version	Description	Issued Date
FR011605AC	Rev. 01	Initial issue	May 18, 2020

Summary of Test Results

FCC Rules	Test Items	Measured	Result
15.207	Conducted Emissions	[dBuV]: 0.510MHz 33.27 (Margin -12.73dB) - AV	Pass
15.247(d) 15.209	Radiated Emissions	[dBuV/m at 3m]: 7311.00MHz 49.87 (Margin -4.13dB) - AV	Pass
15.247(b)(3)	Maximum Output Power	Max Power [dBm]: 24.31	Pass
15.247(a)(2)	6dB Bandwidth	Meet the requirement of limit	Pass
15.247(e)	Power Spectral Density	Meet the requirement of limit	Pass
15.203	Antenna Requirement	Meet the requirement of limit	Pass

Declaration of Conformity:

The test results with all measurement uncertainty excluded are presented in accordance with the regulation limits or requirements declared by manufacturers.

Comments and Explanations:

The declared of product specification for EUT presented in the report are provided by the manufacturer, and the manufacturer takes all the responsibilities for the accuracy of product specification.

1 General Description

1.1 Information

1.1.1 Product Details

Product Name	Mobile Phone
Brand Name	FUJITSU
Model Name	F-51A
IMEI Code	353704110013257 / 353704110013364
H/W Version	v2.1.0
S/W Version	R047.4

1.1.2 Specification of the Equipment under Test (EUT)

RF General Information					
Frequency Range (MHz)	IEEE Std. 802.11	Ch. Freq. (MHz)	Channel Number	Transmit Chains (N _{TX})	Data Rate / MCS
2400-2483.5	b	2412-2462	1-11 [11]	1	1-11 Mbps
2400-2483.5	g	2412-2462	1-11 [11]	1	6-54 Mbps
2400-2483.5	n (HT20)	2412-2462	1-11 [11]	2	MCS 0-15
2400-2483.5	n (HT40)	2422-2452	3-9 [7]	2	MCS 0-15
2400-2483.5	ax (HE20)	2412-2462	1-11 [11]	2	MCS 0-11
2400-2483.5	ax (HE40)	2422-2452	3-9 [7]	2	MCS 0-11

Note 1: RF output power specifies that Maximum Conducted (Average) Output Power.
 Note 2: Chip feature :
 DSSS-DBPSK, DQPSK, CCK modulation
 OFDM/OFDMA- BPSK, QPSK, 16QAM, 64QAM, 256QAM and 1024QAM modulation.

1.1.3 Antenna Details

Ant. No.	Model	Type	Connector	Gain (dBi)
1	WLAN #1	Monopole	No	-6.0
2	WLAN #2	Monopole	No	-7.0

1.1.4 Power Supply Type of Equipment under Test (EUT)

Supply Voltage	3.83Vdc from battery: 9Vdc,1.5A from adapter (No bundle, support unit only)
-----------------------	--

1.1.5 Accessories

Accessories		
No.	Equipment	Description
1	Battery	Brand: FUJITSU CONNECTED TECHNOLOGIES LIMITED Model: CA54310-0079-A1 Rated: 4000mAh, 15.4Wh Typ. 4070mAh, 15.6Wh
2	Type-C <-> Earphone	9.5cm non-shielded without core

1.1.6 Channel List

Frequency band (MHz)		2400~2483.5	
802.11bg / n HT20 / ax HE20		802.11n HT40 / ax HE40	
Channel	Frequency(MHz)	Channel	Frequency(MHz)
1	2412	3	2422
2	2417	4	2427
3	2422	5	2432
4	2427	6	2437
5	2432	7	2442
6	2437	8	2447
7	2442	9	2452
8	2447	---	---
9	2452	---	---
10	2457	---	---
11	2462	---	---

1.1.7 Test Tool and Duty Cycle

Test Tool	QDART, V00071	
Modulation Mode	Duty Cycle Of Test Signal (%)	Duty Factor (dB)
11b	100.00%	0.00
11g	99.64%	0.02
HT20	100.00%	0.00
HT40	100.00%	0.00
ax (HE20)	100.00%	0.00
ax (HE40)	100.00%	0.00
ax HE20_RU26	100.00%	0.00
ax HE20_RU52	100.00%	0.00
ax HE20_RU106	100.00%	0.00
ax HE20_RU242	100.00%	0.00
ax HE40_RU26	100.00%	0.00
ax HE40_RU52	100.00%	0.00
ax HE40_RU106	100.00%	0.00
ax HE40_RU242	100.00%	0.00
ax HE40_RU484	100.00%	0.00

1.1.8 Power Index of Test Tool

OFDM Modulation		
Modulation Mode	Test Frequency (MHz)	Power Index
11b	2412	16
11b	2437	16
11b	2462	16
11g	2412	15.00
11g	2437	15.00
11g	2462	15.00
HT20	2412	13
HT20	2437	13
HT20	2462	13
HT40	2422	11.50
HT40	2437	11.50
HT40	2452	11.50
ax (HE20)	2412	11.50
ax (HE20)	2437	11.50
ax (HE20)	2462	11.50
ax (HE40)	2422	11.50
ax (HE40)	2437	11.50
ax (HE40)	2452	11.50

OFDMA Modulation				
Modulation Mode	RU Tone	Index	Test Frequency (MHz)	Power Index
ax (HE20)	26	4	2412	10
			2437	9
			2462	10
			2412	9.5
			2437	9.5
			2462	9.5
			2412	9
			2437	9.5
			2462	10
	52	38	2412	9.5
			2437	9
			2462	9.5
			2412	9.5
			2437	9
			2462	9.5
			2412	9
			2437	9.5
			2462	10
	106	54	2412	9.5
			2437	9
			2462	9.5
			2412	9.5
			2437	9.5
			2462	9.5
242	62	2412	9.5	
		2437	9.5	
		2462	9.5	

OFDMA Modulation				
Modulation Mode	RU Tone	Index	Test Frequency (MHz)	Power Index
ax (HE40)	26	9	2422	10
			2437	9.5
			2452	9
			2422	9.5
			2437	9
			2452	9
			2422	10
			2437	10
			2452	9.5
	52	41	2422	9.5
			2437	9.5
			2452	9
			2422	9
			2437	9
			2452	9
			2422	10
			2437	10
			2452	9.5
	106	54	2422	9.5
			2437	9
			2452	9
			2422	9
			2437	9
			2452	9
			2422	9
			2437	9.5
			2452	9
	242	62	2422	9.5
			2437	9
			2452	9
			2422	9
			2437	9
			2452	9
			2422	9
			2437	9
			2452	9
484	65	2422	9	
		2437	9	
		2452	9	

1.2 Local Support Equipment List

Support Equipment List					
No.	Equipment	Brand	Model	S/N	Remarks
1	AC Adapter	NTT docomo	AC Adapter 06	---	Provided by applicant.
2	Notebook	DELL	Latitude E5470	7BMHVF2	---

1.3 Test Setup Chart

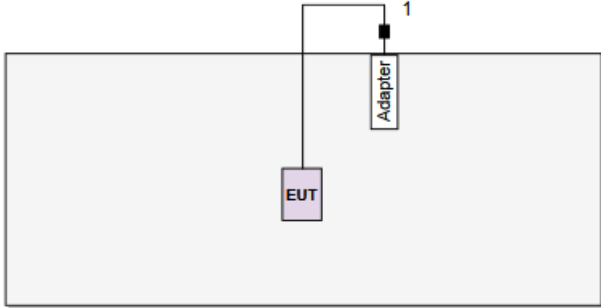
Test Setup Diagram	
	
No.	Signal cable / Length (m)
1	USB, 1.2m non-shielded with one core.

Note: The support notebook is disconnected from EUT and removed from test table after sending command to EUT to control EUT to transmit continuously.

1.4 The Equipment List

Test Item	Conducted Emission				
Test Site	Conduction room 1 / (CO01-WS)				
Instrument	Manufacturer	Model No.	Serial No.	Calibration Date	Calibration Until
Receiver	R&S	ESR3	101658	Dec. 12, 2019	Dec. 11, 2020
LISN	R&S	ENV216	101579	Mar. 12, 2020	Mar. 11, 2021
RF Cable-CON	Woken	CFD200-NL	CFD200-NL-001	Oct. 22, 2019	Oct. 21, 2020
Measurement Software	AUDIX	e3	6.120210k	NA	NA

Note: Calibration Interval of instruments listed above is one year.

Test Item	Radiated Emission				
Test Site	966 chamber1 / (03CH01-WS)				
Instrument	Manufacturer	Model No.	Serial No.	Calibration Date	Calibration Until
Spectrum Analyzer	R&S	FSV40	101498	Dec. 17, 2019	Dec. 16, 2020
Receiver	R&S	ESR3	101657	Feb. 14, 2020	Feb. 13, 2021
Bilog Antenna	SCHWARZBECK	VULB9168	VULB9168-522	Jul. 12, 2019	Jul. 11, 2020
Horn Antenna 1G-18G	SCHWARZBECK	BBHA 9120 D	BBHA 9120 D 1096	Dec. 12, 2019	Dec. 11, 2020
Horn Antenna 18G-40G	SCHWARZBECK	BBHA 9170	BBHA 9170517	Nov. 15, 2019	Nov. 14, 2020
Loop Antenna	R&S	HFH2-Z2	100330	Nov. 13, 2019	Nov. 12, 2020
Loop Antenna Cable	KOAX KABEL	101354-BW	101354-BW	Oct. 07, 2019	Oct. 06, 2020
Preamplifier	EMC	EMC02325	980225	Jul. 09, 2019	Jul. 08, 2020
Preamplifier	Agilent	83017A	MY39501308	Oct. 08, 2019	Oct. 07, 2020
Preamplifier	EMC	EMC184045B	980192	Aug. 01, 2019	Jul. 31, 2020
RF Cable	EMC	EMC104-SM-SM-8000	181106	Oct. 07, 2019	Oct. 06, 2020
RF Cable	HUBER+SUHNER	SUCOFLEX104	MY16019/4	Oct. 07, 2019	Oct. 06, 2020
RF Cable	HUBER+SUHNER	SUCOFLEX104	MY16014/4	Oct. 07, 2019	Oct. 06, 2020
LF cable 1M	EMC	EMCCFD400-NM-NM-1000	160502	Oct. 07, 2019	Oct. 06, 2020
LF cable 3M	Woken	CFD400NL-LW	CFD400NL-001	Oct. 07, 2019	Oct. 06, 2020
LF cable 10M	Woken	CFD400NL-LW	CFD400NL-002	Oct. 07, 2019	Oct. 06, 2020
Measurement Software	AUDIX	e3	6.120210g	NA	NA

Note: Calibration Interval of instruments listed above is one year.

Test Item	RF Conducted				
Test Site	(TH01-WS)				
Instrument	Manufacturer	Model No.	Serial No.	Calibration Date	Calibration Until
Spectrum Analyzer	R&S	FSV40	101499	Jan. 09, 2020	Jan. 08, 2021
Power Meter	Anritsu	ML2495A	1241002	Oct. 23, 2019	Oct. 22, 2020
Power Sensor	Anritsu	MA2411B	1207366	Oct. 23, 2019	Oct. 22, 2020
AC POWER SOURCE	APC	AFC-500W	F312060012	Dec. 02, 2019	Dec. 01, 2020
Measurement Software	--	SENSE-15247_DTS	V5.10.7	NA	NA
Note: Calibration Interval of instruments listed above is one year.					

1.5 Test Standards

According to the specification of EUT, the EUT must comply with following standards and KDB documents.

47 CFR FCC Part 15.247

ANSI C63.10-2013

FCC KDB 558074 D01 15.247 Meas Guidance v05r02

FCC KDB 662911 D01 Multiple Transmitter Output v02r01

1.6 Deviation from Test Standard and Measurement Procedure

None

1.7 Measurement Uncertainty

The measurement uncertainties given below are based on a 95% confidence level (based on a coverage factor ($k=2$))

Measurement Uncertainty	
Parameters	Uncertainty
Bandwidth	± 34.130 Hz
Conducted power	± 0.808 dB
Power density	± 0.583 dB
Conducted emission	± 2.715 dB
AC conducted emission	± 2.92 dB
Radiated emission ≤ 1 GHz	± 3.41 dB
Radiated emission > 1 GHz	± 4.59 dB

2 Test Configuration

2.1 Testing Condition

Test Item	Test Site	Ambient Condition	Tested By
AC Conduction	CO01-WS	23°C / 58%	Alex Tsai
Radiated Emissions	03CH01-WS	23-24°C / 65-67%	Roger Lu
RF Conducted	TH01-WS	21°C / 67%	Aska Huang

- FCC Designation No.: TW2732
- FCC site registration No.: 181692
- ISED#: 10807A
- CAB identifier: TW2732

2.2 The Worst Test Modes and Channel Details

Test item	Modulation Mode	Test Frequency (MHz)	Data Rate (Mbps) / MCS	Test Configuration
Conducted Emissions	11g	2412	6 Mbps	---
Radiated Emissions ≤1GHz	11g	2412	6 Mbps	---
Maximum Output Power	11b	2412 / 2437 / 2462	1 Mbps	---
	11g	2412 / 2437 / 2462	6 Mbps	
	ax HE20	2412 / 2437 / 2462	MCS 0	
	ax HE40	2422 / 2437 / 2452	MCS 0	
Maximum Output Power	ax HE20	2412 / 2437 / 2462	MCS 0	---
	ax HE40	2422 / 2437 / 2452	MCS 0	
Radiated Emissions >1GHz 6dB bandwidth Power spectral density	11b	2412 / 2437 / 2462	1 Mbps	---
	11g	2412 / 2437 / 2462	6 Mbps	
	ax HE20	2412 / 2437 / 2462	MCS 0	
	ax HE40	2422 / 2437 / 2452	MCS 0	

NOTE:

1. The EUT was pretested with 3 orientations placed on the table for the radiated emission measurement – X, Y, and Z-plane. The **Y-plane** results were found as the worst case and were shown in this report.

3 Transmitter Test Results

3.1 Conducted Emissions

3.1.1 Limit of Conducted Emissions

Conducted Emissions Limit		
Frequency Emission (MHz)	Quasi-Peak	Average
0.15-0.5	66 - 56 *	56 - 46 *
0.5-5	56	46
5-30	60	50

Note 1: * Decreases with the logarithm of the frequency.

3.1.2 Test Procedures

1. The device is placed on a test table, raised 80 cm above the reference ground plane. The vertical conducting plane is located 40 cm to the rear of the device.
2. The device is connected to line impedance stabilization network (LISN) and other accessories are connected to other LISN. Measured levels of AC power line conducted emission are across the 50 Ω LISN port.
3. AC conducted emission measurements is made over frequency range from 150 kHz to 30 MHz.
4. This measurement was performed with AC 120V / 60Hz.

3.1.3 Test Setup

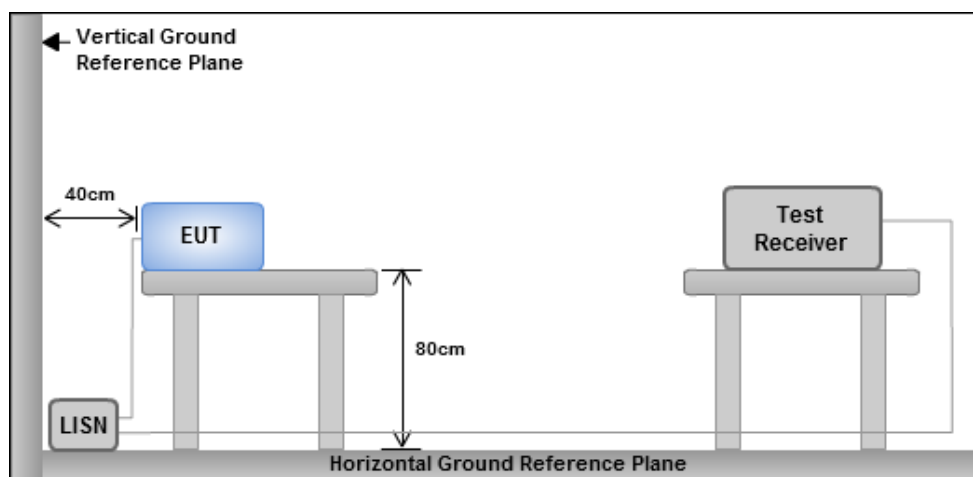

- Note: 1. Support units were connected to second LISN.
 2. Both of LISNs (AMN) are 80 cm from EUT and at least 80 cm from other units and other metal planes

3.1.4 Test Result of Conducted Emissions

Modulation	11g	Test Freq. (MHz)	2412
Power Phase	Line		

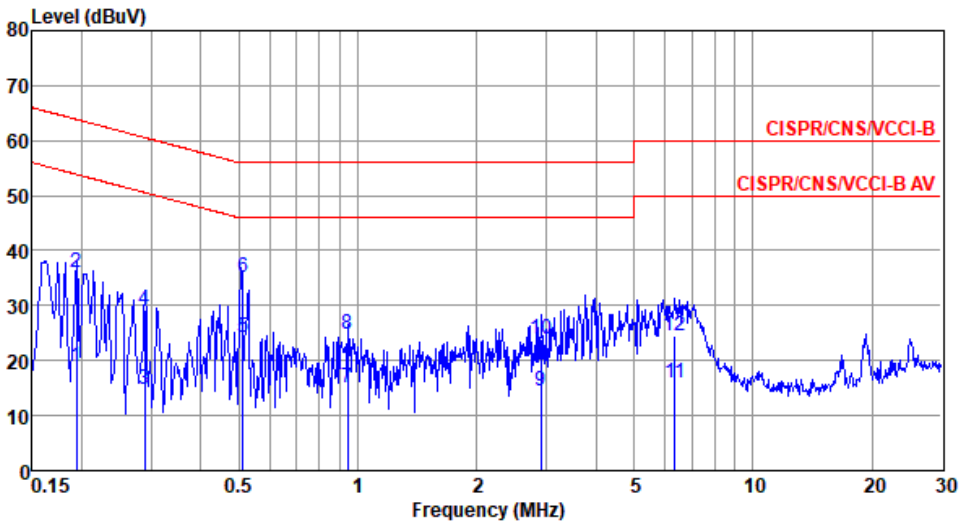

	Freq MHz	Level dBuV	Limit Line dBuV	Over Limit dB	Read Level dBuV	LISN factor dB	cable loss dB	Remark
1	0.194	18.80	53.84	-35.04	8.92	9.63	0.06	Average
2	0.194	36.02	63.84	-27.82	26.14	9.63	0.06	QP
3	0.289	14.68	50.54	-35.86	4.76	9.63	0.07	Average
4	0.289	29.18	60.54	-31.36	19.26	9.63	0.07	QP
5	0.513	24.15	46.00	-21.85	14.16	9.63	0.09	Average
6*	0.513	35.13	56.00	-20.87	25.14	9.63	0.09	QP
7	0.943	14.96	46.00	-31.04	4.89	9.63	0.12	Average
8	0.943	24.66	56.00	-31.34	14.59	9.63	0.12	QP
9	2.900	14.54	46.00	-31.46	4.29	9.65	0.24	Average
10	2.900	23.80	56.00	-32.20	13.55	9.65	0.24	QP
11	6.352	16.02	50.00	-33.98	5.62	9.67	0.34	Average
12	6.352	24.53	60.00	-35.47	14.13	9.67	0.34	QP

Note 1: Level (dBuV) = Read Level (dBuV) + LISN Factor (dB) + Cable Loss (dB).
 Note 2: Over Limit (dB) = Level (dBuV) – Limit Line (dBuV).

Modulation	11g	Test Freq. (MHz)	2412
Power Phase	Neutral		

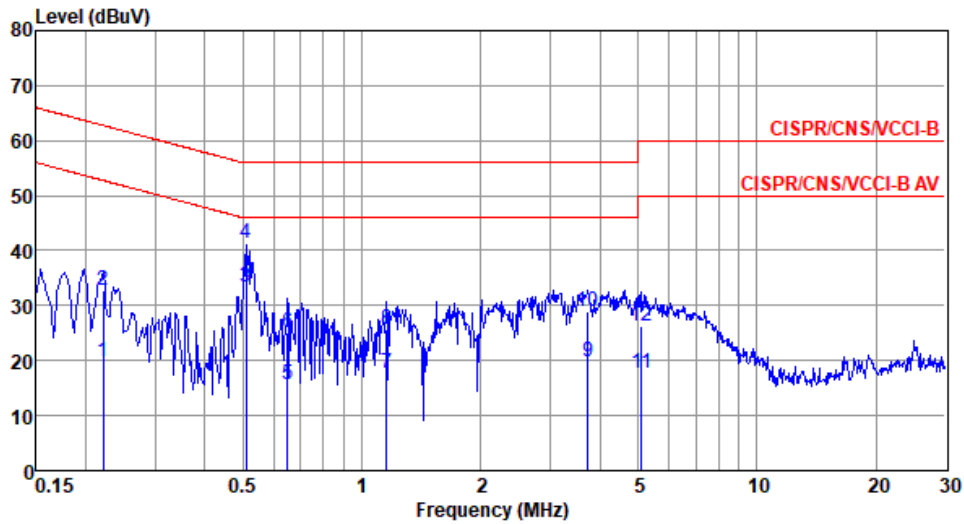

	Freq MHz	Level dBuV	Limit Line dBuV	Over Limit dB	Read Level dBuV	LISN factor dB	cable loss dB	Remark
1	0.222	19.74	52.74	-33.00	9.88	9.65	0.06	Average
2	0.222	32.78	62.74	-29.96	22.92	9.65	0.06	QP
3*	0.510	33.27	46.00	-12.73	23.35	9.65	0.09	Average
4	0.510	41.37	56.00	-14.63	31.45	9.65	0.09	QP
5	0.647	15.56	46.00	-30.44	5.62	9.65	0.10	Average
6	0.647	24.97	56.00	-31.03	15.03	9.65	0.10	QP
7	1.153	17.58	46.00	-28.42	7.59	9.65	0.13	Average
8	1.153	25.57	56.00	-30.43	15.58	9.65	0.13	QP
9	3.740	19.90	46.00	-26.10	9.69	9.67	0.28	Average
10	3.740	28.93	56.00	-27.07	18.72	9.67	0.28	QP
11	5.112	17.83	50.00	-32.17	7.54	9.69	0.32	Average
12	5.112	26.33	60.00	-33.67	16.04	9.69	0.32	QP

Note 1: Level (dBuV) = Read Level (dBuV) + LISN Factor (dB) + Cable Loss (dB).
 2: Over Limit (dB) = Level (dBuV) – Limit Line (dBuV).

3.2 6dB and Occupied Bandwidth

3.2.1 Limit of 6dB Bandwidth

The minimum 6dB bandwidth shall be at least 500 kHz.

3.2.2 Test Procedures

6dB Bandwidth

1. Set resolution bandwidth (RBW) = 100 kHz, Video bandwidth = 300 kHz.
2. Detector = Peak, Trace mode = max hold.
3. Sweep = auto couple, Allow the trace to stabilize.
4. Measure the maximum width of the emission that is constrained by the frequencies associated with the two outermost amplitude points (upper and lower) that are attenuated by 6dB relative to the maximum level measured in the fundamental emission.

Occupied Bandwidth

1. Set resolution bandwidth (RBW) = 1% ~ 5 % of OBW, Video bandwidth = 3 x RBW
2. Detector = Sample, Trace mode = max hold.
3. Sweep = auto couple, Allow the trace to stabilize.
4. Use the OBW measurement function of spectrum analyzer to measure the occupied bandwidth.

3.2.3 Test Setup

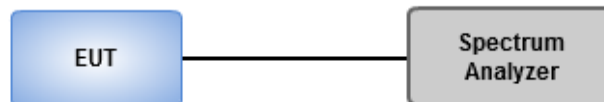

3.2.4 Test Result of 6dB and Occupied Bandwidth

Summary

Mode	Max-N dB (Hz)	Max-OBW (Hz)	ITU-Code	Min-N dB (Hz)	Min-OBW (Hz)
2.4-2.4835GHz	-	-	-	-	-
802.11b_Nss1,(1Mbps)_2TX	8.551M	13.365M	13M4G1D	8.043M	12.999M
802.11g_Nss1,(6Mbps)_2TX	16.304M	16.402M	16M4D1D	15.652M	16.291M
802.11n HT20_Nss1,(MCS0)_2TX	17.246M	17.548M	17M5D1D	16.232M	17.499M
802.11n HT40_Nss1,(MCS0)_2TX	36.232M	35.95M	35M9D1D	33.623M	35.858M
11AX20_Nss1,(MCS0)_2TX	18.841M	18.898M	18M9D1D	18.043M	18.824M
11AX40_Nss1,(MCS0)_2TX	37.826M	37.72M	37M7D1D	34.638M	37.591M

Max-N dB = Maximum 6dB down bandwidth; **Max-OBW** = Maximum 99% occupied bandwidth;
Min-N dB = Minimum 6dB down bandwidth; **Min-OBW** = Minimum 99% occupied bandwidth;

Result

Mode	Result	Limit (Hz)	Port 1-N dB (Hz)	Port 1-OBW (Hz)	Port 2-N dB (Hz)	Port 2-OBW (Hz)
802.11b_Nss1,(1Mbps)_2TX	-	-	-	-	-	-
2412MHz	Pass	500k	8.043M	13.085M	8.116M	13.145M
2437MHz	Pass	500k	8.551M	13.201M	8.551M	13.365M
2462MHz	Pass	500k	8.116M	12.999M	8.043M	13.044M
802.11g_Nss1,(6Mbps)_2TX	-	-	-	-	-	-
2412MHz	Pass	500k	16.304M	16.354M	16.304M	16.363M
2437MHz	Pass	500k	16.087M	16.321M	15.725M	16.402M
2462MHz	Pass	500k	15.652M	16.291M	16.014M	16.345M
802.11n HT20_Nss1,(MCS0)_2TX	-	-	-	-	-	-
2412MHz	Pass	500k	17.246M	17.539M	16.232M	17.548M
2437MHz	Pass	500k	16.304M	17.499M	17.246M	17.513M
2462MHz	Pass	500k	16.377M	17.51M	16.957M	17.529M
802.11n HT40_Nss1,(MCS0)_2TX	-	-	-	-	-	-
2422MHz	Pass	500k	35.797M	35.858M	35.797M	35.907M
2437MHz	Pass	500k	33.768M	35.882M	33.623M	35.897M
2452MHz	Pass	500k	36.232M	35.926M	36.087M	35.95M
11AX20_Nss1,(MCS0)_2TX	-	-	-	-	-	-
2412MHz	Pass	500k	18.116M	18.882M	18.841M	18.898M
2437MHz	Pass	500k	18.333M	18.847M	18.623M	18.862M
2462MHz	Pass	500k	18.623M	18.824M	18.043M	18.858M
11AX40_Nss1,(MCS0)_2TX	-	-	-	-	-	-
2422MHz	Pass	500k	36.812M	37.591M	36.812M	37.62M
2437MHz	Pass	500k	37.681M	37.631M	34.638M	37.695M
2452MHz	Pass	500k	37.826M	37.72M	37.101M	37.676M

Port X-N dB = Port X 6dB down bandwidth; **Port X-OBW** = Port X 99% occupied bandwidth;

802.11b_Nss1,(1Mbps)_2TX

EBW

2412MHz

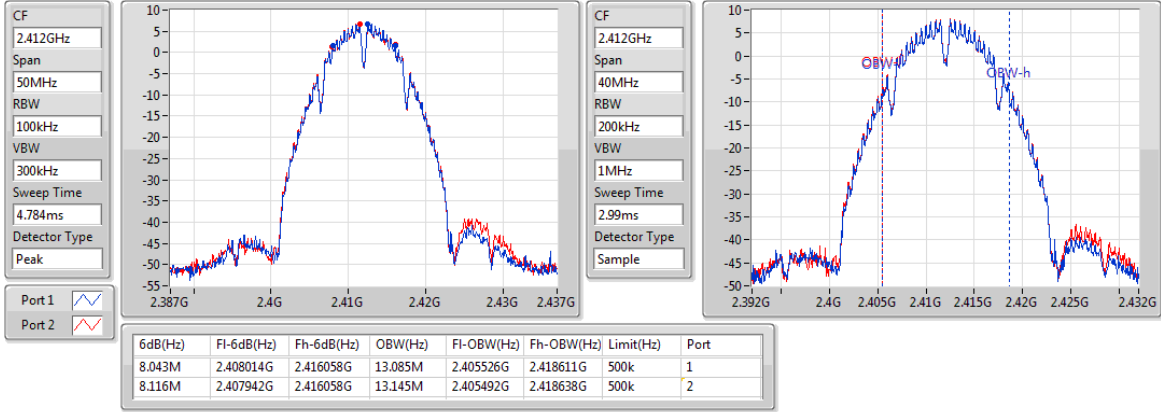

802.11b_Nss1,(1Mbps)_2TX

EBW

2437MHz

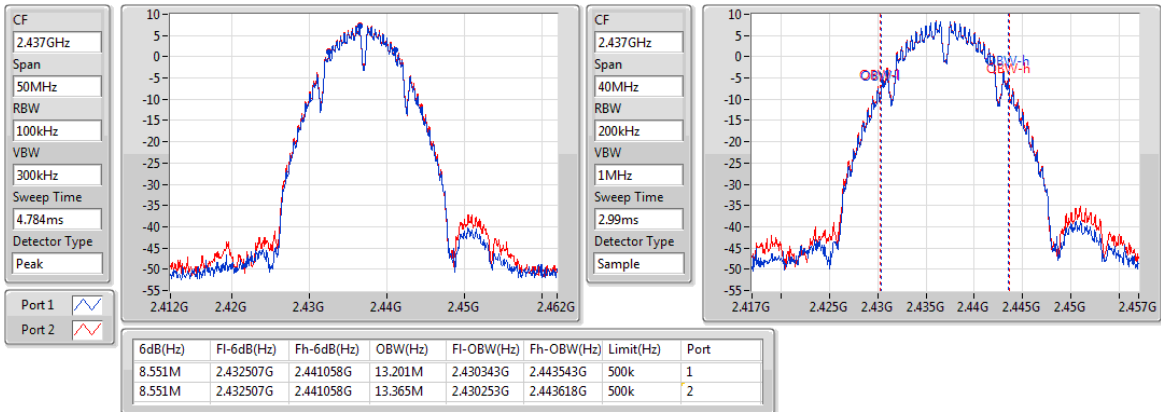

802.11b_Nss1,(1Mbps)_2TX

EBW

2462MHz

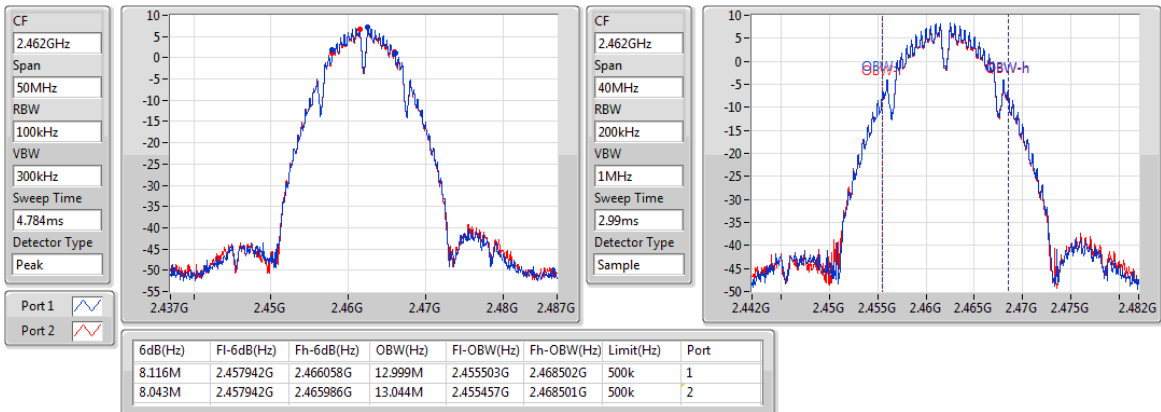

802.11g_Nss1,(6Mbps)_2TX

EBW

2412MHz

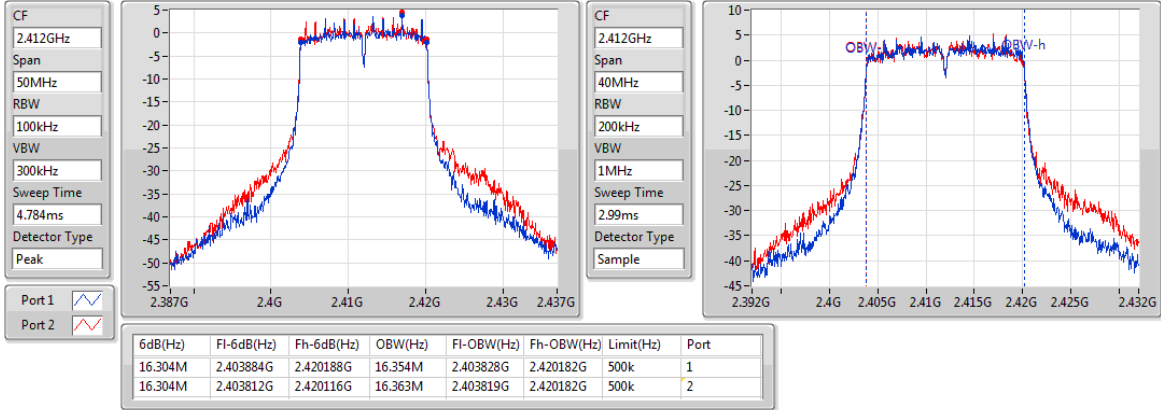

802.11g_Nss1,(6Mbps)_2TX

EBW

2437MHz

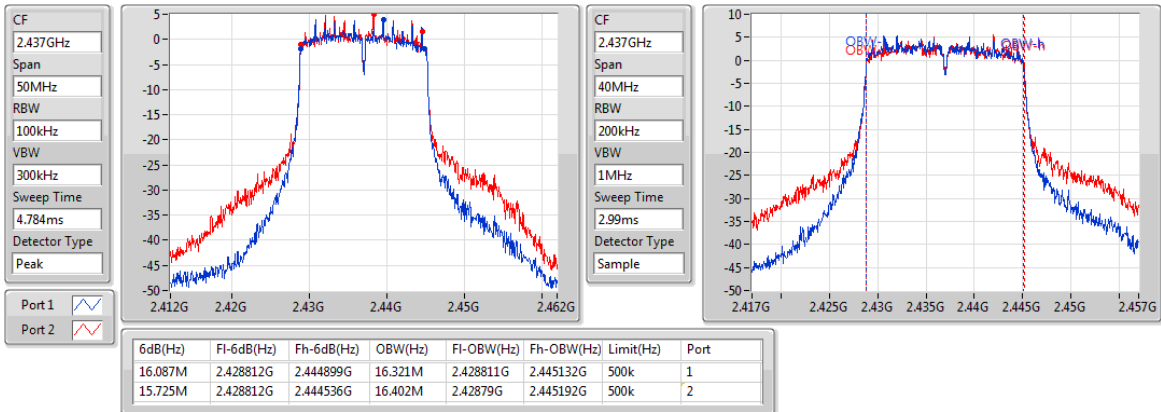

802.11g_Nss1,(6Mbps)_2TX

EBW

2462MHz

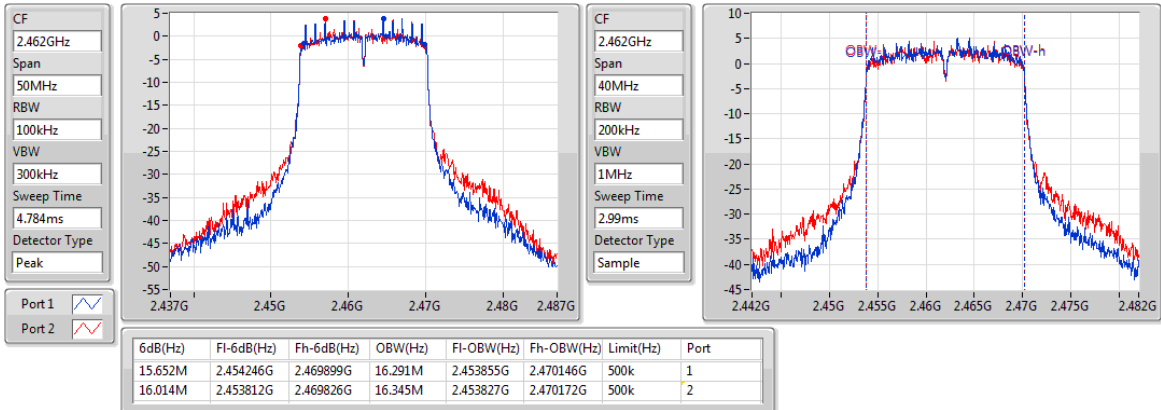

802.11n HT20_Nss1,(MCS0)_2TX

EBW

2412MHz

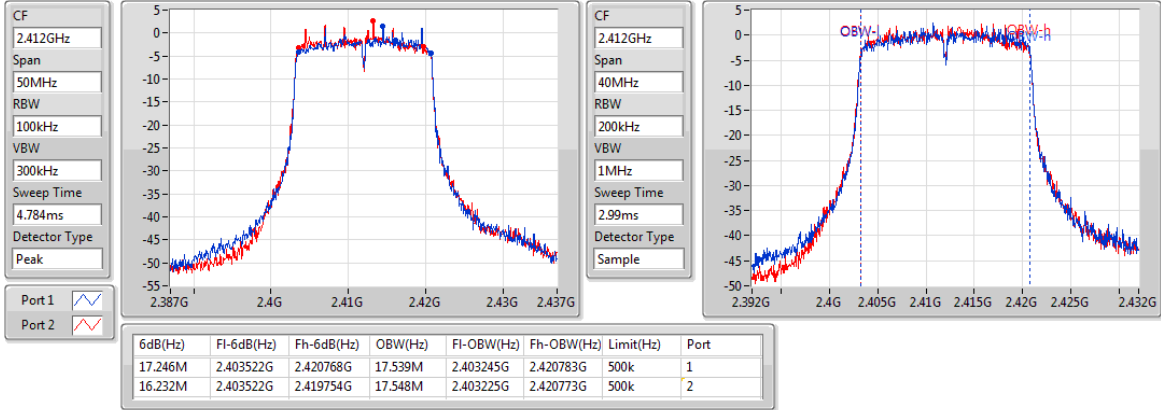

802.11n HT20_Nss1,(MCS0)_2TX

EBW

2437MHz

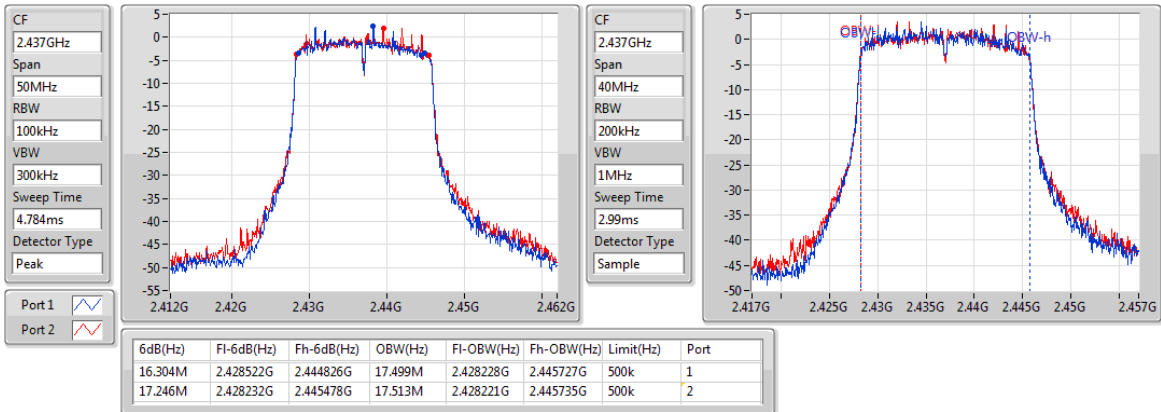

802.11n HT20_Nss1,(MCS0)_2TX

EBW

2462MHz

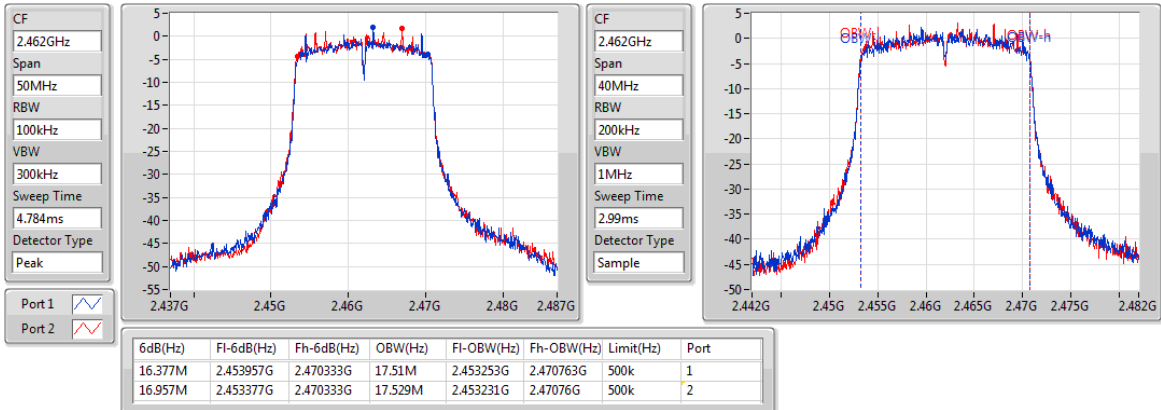

802.11n HT40_Nss1,(MCS0)_2TX

EBW

2422MHz

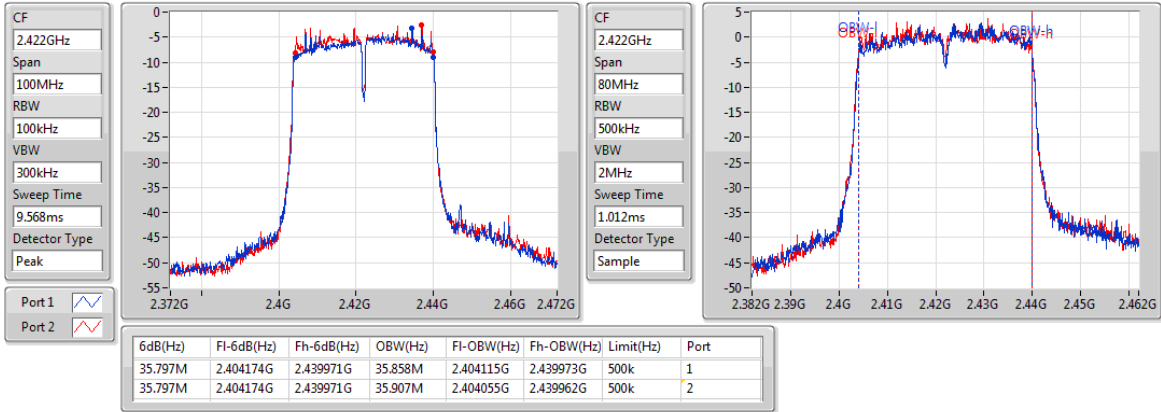

802.11n HT40_Nss1,(MCS0)_2TX

EBW

2437MHz

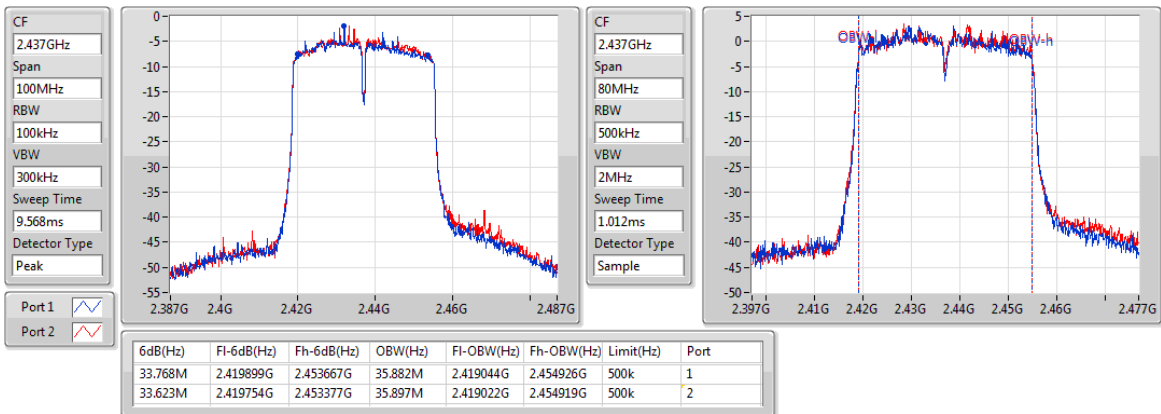

802.11n HT40_Nss1,(MCS0)_2TX

EBW

2452MHz

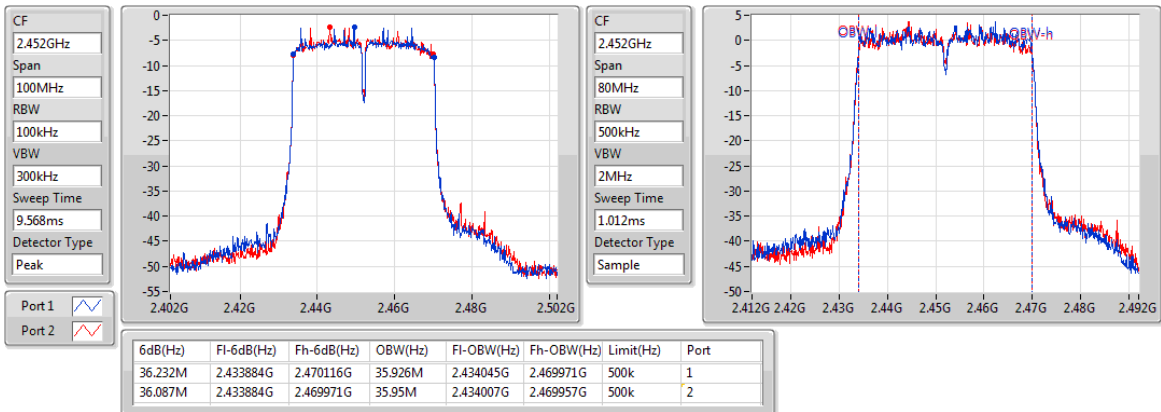

11AX20_Nss1,(MCS0)_2TX

EBW

2412MHz

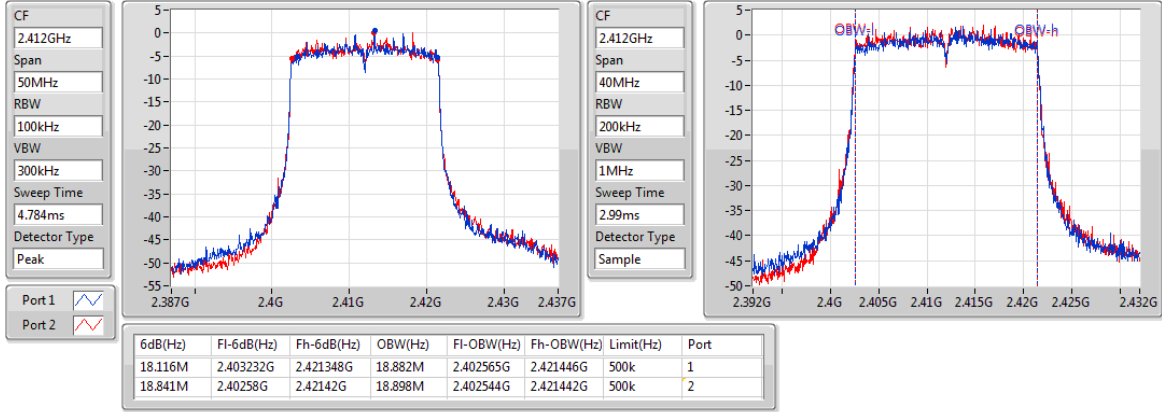

11AX20_Nss1,(MCS0)_2TX

EBW

2437MHz

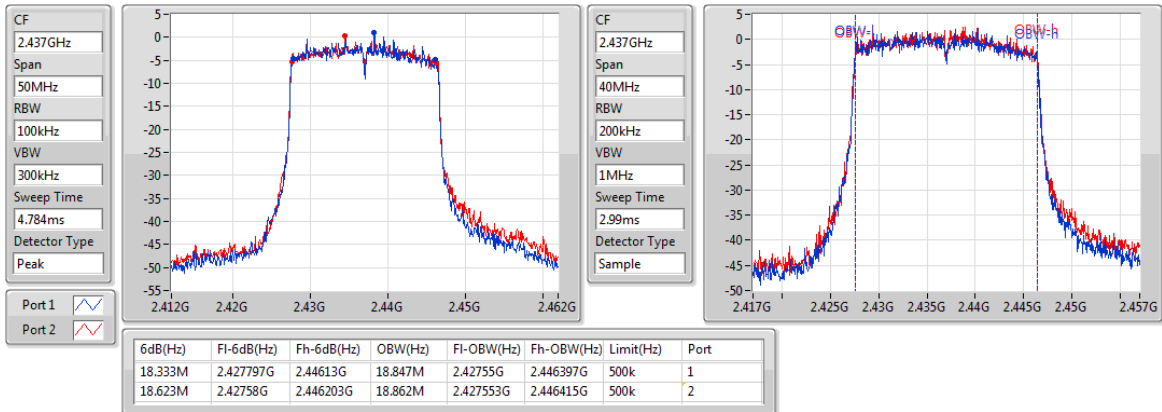

11AX20_Nss1,(MCS0)_2TX

EBW

2462MHz

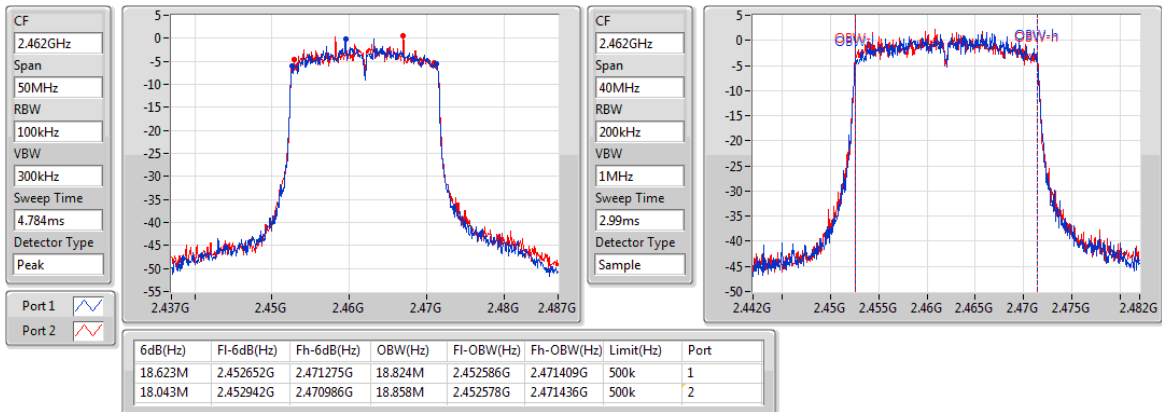

11AX40_Nss1,(MCS0)_2TX

EBW

2422MHz

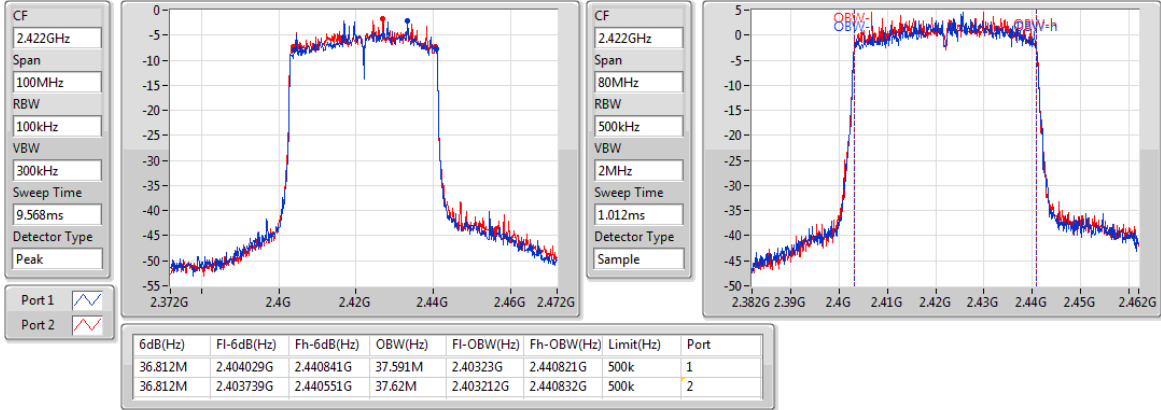

11AX40_Nss1,(MCS0)_2TX

EBW

2437MHz

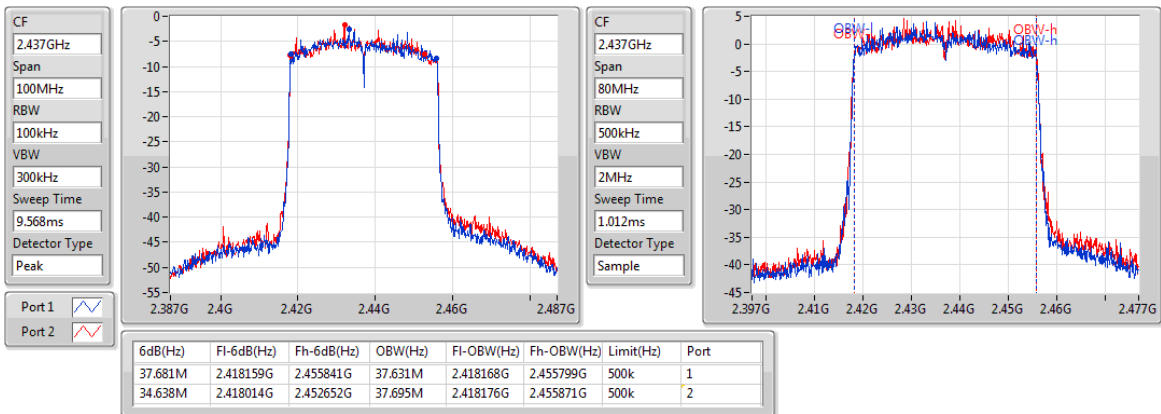

11AX40_Nss1,(MCS0)_2TX

EBW

2452MHz

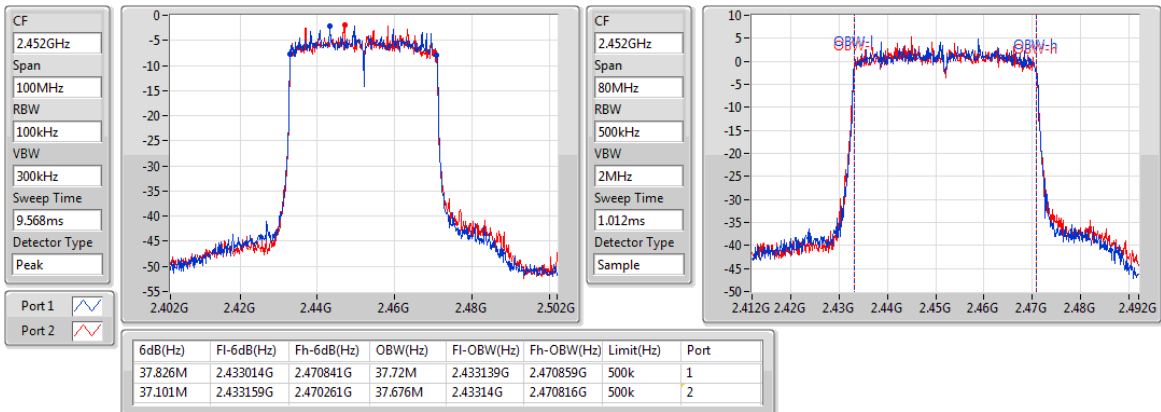

Summary

Mode	Max-N dB (Hz)	Max-OBW (Hz)	ITU-Code	Min-N dB (Hz)	Min-OBW (Hz)
2.4-2.4835GHz	-	-	-	-	-
802.11ax HEW20_RU26_Index4_Nss1,(MCS0)_2TX	2.609M	17.173M	17M2D1D	2.609M	16.915M
802.11ax HEW20_RU52_Index38_Nss1,(MCS0)_2TX	15.072M	17.213M	17M2D1D	13.841M	16.649M
802.11ax HEW20_RU106_Index54_Nss1,(MCS0)_2TX	17.826M	18.188M	18M2D1D	17.101M	14.298M
802.11ax HEW20_RU242_Index61_Nss1,(MCS0)_2TX	19.058M	19.037M	19M0D1D	18.913M	19.002M
802.11ax HEW40_RU26_Index9_Nss1,(MCS0)_2TX	2.029M	36.171M	36M2D1D	2.029M	35.233M
802.11ax HEW40_RU52_Index41_Nss1,(MCS0)_2TX	4.058M	36.036M	36M0D1D	4.058M	35.339M
802.11ax HEW40_RU106_Index54_Nss1,(MCS0)_2TX	35.072M	36.346M	36M3D1D	20.145M	35.129M
802.11ax HEW40_RU242_Index62_Nss1,(MCS0)_2TX	36.957M	37.452M	37M5D1D	36.667M	36.799M
802.11ax HEW40_RU484_Index65_Nss1,(MCS0)_2TX	38.261M	37.997M	38M0D1D	37.971M	37.87M

Max-N dB = Maximum 6dB down bandwidth; **Max-OBW** = Maximum 99% occupied bandwidth;
Min-N dB = Minimum 6dB down bandwidth; **Min-OBW** = Minimum 99% occupied bandwidth;

Result

Mode	Result	Limit (Hz)	Port 1-N dB (Hz)	Port 1-OBW (Hz)	Port 2-N dB (Hz)	Port 2-OBW (Hz)
802.11ax HEW20_RU26_Index4_Nss1,(MCS0)_2TX	-	-	-	-	-	-
2412MHz	Pass	500k	2.609M	17.173M	2.609M	17.044M
2437MHz	Pass	500k	2.609M	17.142M	2.609M	16.915M
2462MHz	Pass	500k	2.609M	17.035M	2.609M	16.923M
802.11ax HEW20_RU52_Index38_Nss1,(MCS0)_2TX	-	-	-	-	-	-
2412MHz	Pass	500k	15M	17.213M	14.928M	16.968M
2437MHz	Pass	500k	15M	17.018M	15.072M	16.761M
2462MHz	Pass	500k	13.841M	16.649M	13.841M	16.901M
802.11ax HEW20_RU106_Index54_Nss1,(MCS0)_2TX	-	-	-	-	-	-
2412MHz	Pass	500k	17.101M	14.298M	17.101M	15.001M
2437MHz	Pass	500k	17.826M	18.188M	17.391M	18.116M
2462MHz	Pass	500k	17.101M	18.138M	17.101M	17.94M
802.11ax HEW20_RU242_Index61_Nss1,(MCS0)_2TX	-	-	-	-	-	-
2412MHz	Pass	500k	19.058M	19.023M	19.058M	19.037M
2437MHz	Pass	500k	18.913M	19.002M	18.986M	19.014M
2462MHz	Pass	500k	18.986M	19.013M	18.986M	19.032M
802.11ax HEW40_RU26_Index9_Nss1,(MCS0)_2TX	-	-	-	-	-	-
2422MHz	Pass	500k	2.029M	35.868M	2.029M	35.665M
2437MHz	Pass	500k	2.029M	35.576M	2.029M	35.233M
2452MHz	Pass	500k	2.029M	36.171M	2.029M	36.046M
802.11ax HEW40_RU52_Index41_Nss1,(MCS0)_2TX	-	-	-	-	-	-
2422MHz	Pass	500k	4.058M	35.339M	4.058M	35.952M
2437MHz	Pass	500k	4.058M	35.82M	4.058M	35.485M
2452MHz	Pass	500k	4.058M	36.036M	4.058M	35.71M
802.11ax HEW40_RU106_Index54_Nss1,(MCS0)_2TX	-	-	-	-	-	-
2422MHz	Pass	500k	33.768M	35.511M	32.609M	35.87M
2437MHz	Pass	500k	20.145M	35.762M	30M	35.129M
2452MHz	Pass	500k	35.072M	36.346M	32.464M	35.94M
802.11ax HEW40_RU242_Index62_Nss1,(MCS0)_2TX	-	-	-	-	-	-
2422MHz	Pass	500k	36.667M	36.799M	36.667M	37.331M
2437MHz	Pass	500k	36.957M	37.088M	36.667M	37.072M
2452MHz	Pass	500k	36.957M	37.452M	36.957M	37.335M
802.11ax HEW40_RU484_Index65_Nss1,(MCS0)_2TX	-	-	-	-	-	-
2422MHz	Pass	500k	37.971M	37.933M	38.116M	37.923M
2437MHz	Pass	500k	37.971M	37.87M	38.116M	37.949M
2452MHz	Pass	500k	38.116M	37.997M	38.261M	37.983M

Port X-N dB = Port X 6dB down bandwidth; **Port X-OBW** = Port X 99% occupied bandwidth;

802.11ax HEW20_RU26_Index4_Nss1,(MCS0)_2TX

EBW

2412MHz

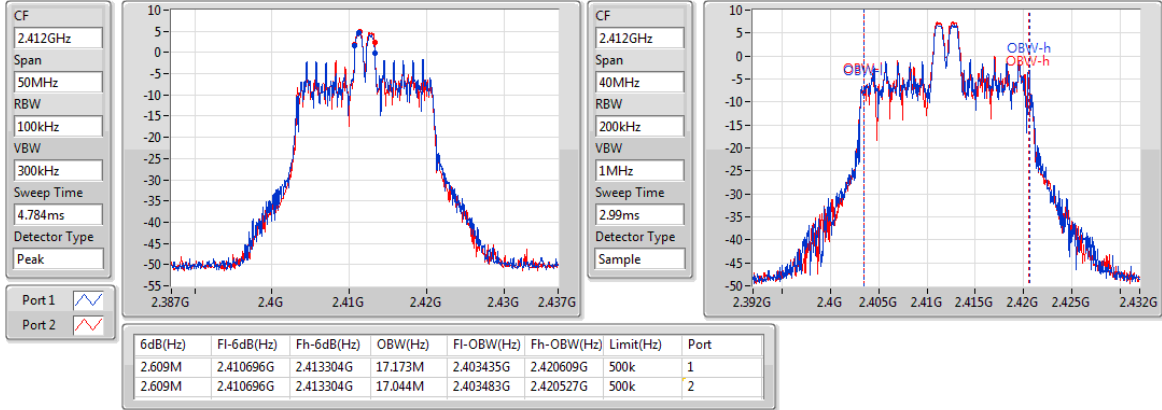

802.11ax HEW20_RU26_Index4_Nss1,(MCS0)_2TX

EBW

2437MHz

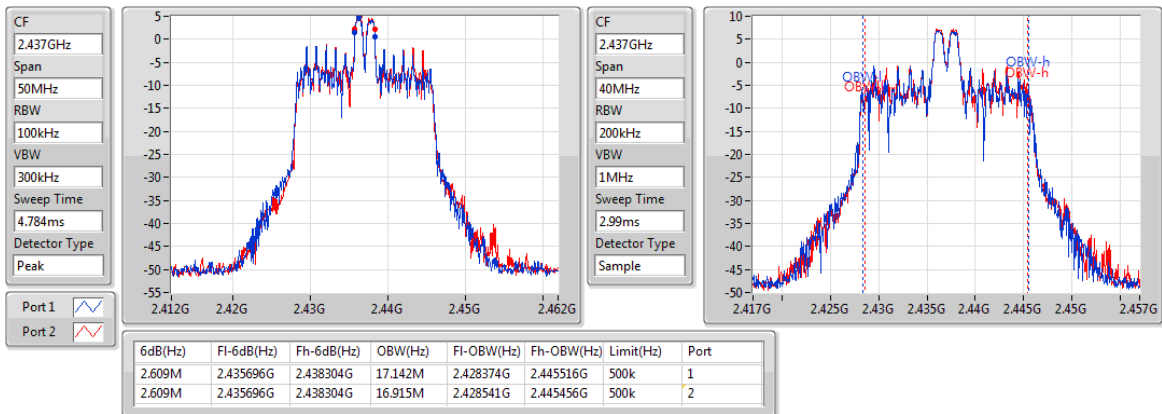

802.11ax HEW20_RU26_Index4_Nss1,(MCS0)_2TX

EBW

2462MHz

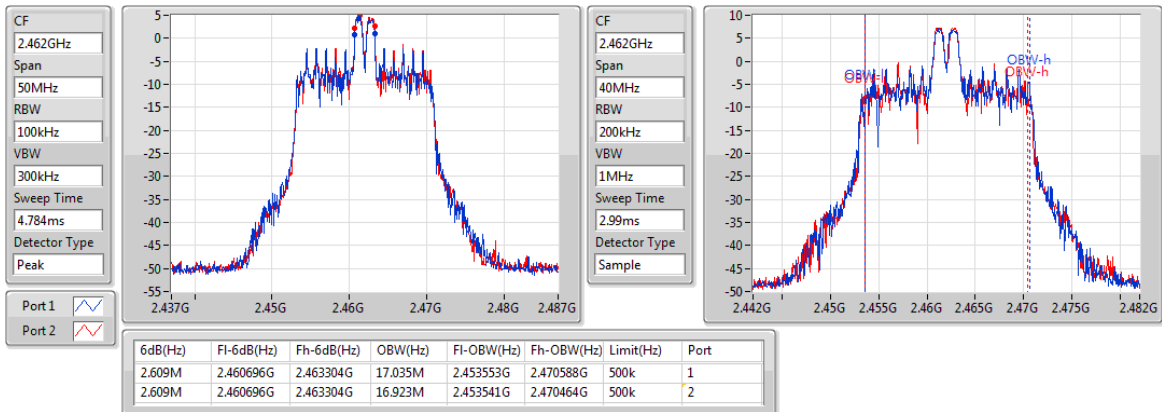

802.11ax HEW20_RU52_Index38_Nss1,(MCS0)_2TX

EBW

2412MHz

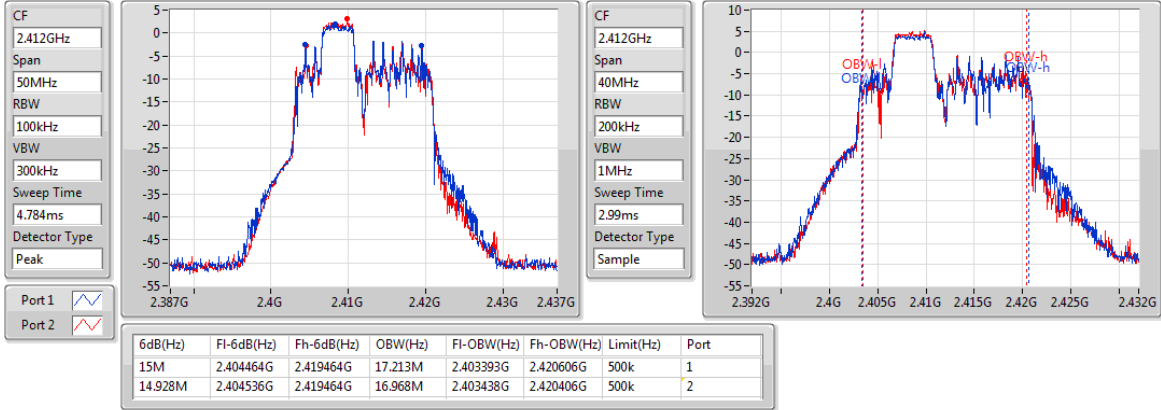

802.11ax HEW20_RU52_Index38_Nss1,(MCS0)_2TX

EBW

2437MHz

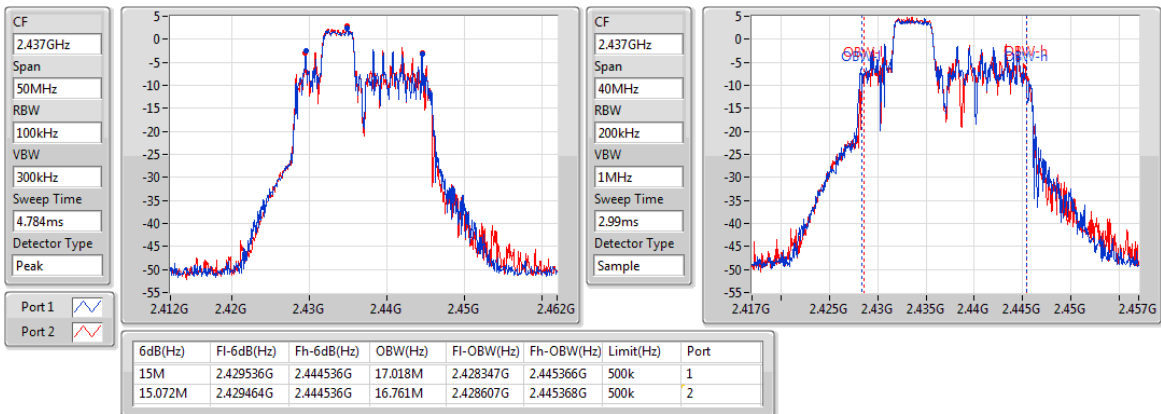

802.11ax HEW20_RU52_Index38_Nss1,(MCS0)_2TX

EBW

2462MHz

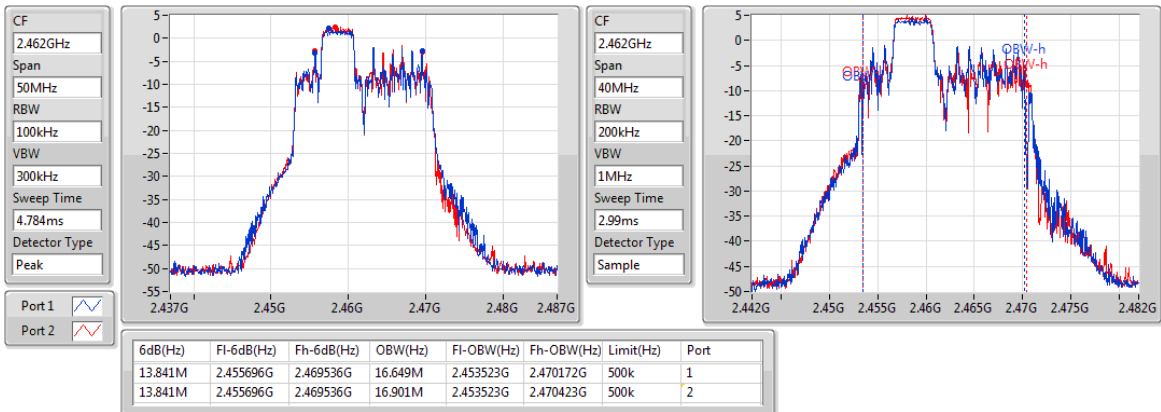

802.11ax HEW20_RU106_Index54_Nss1,(MCS0)_2TX

EBW

2412MHz

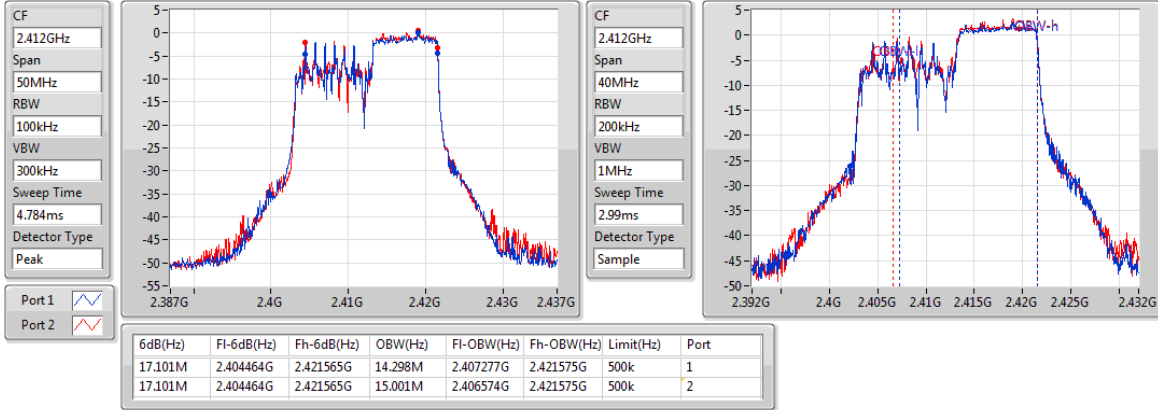

802.11ax HEW20_RU106_Index54_Nss1,(MCS0)_2TX

EBW

2437MHz

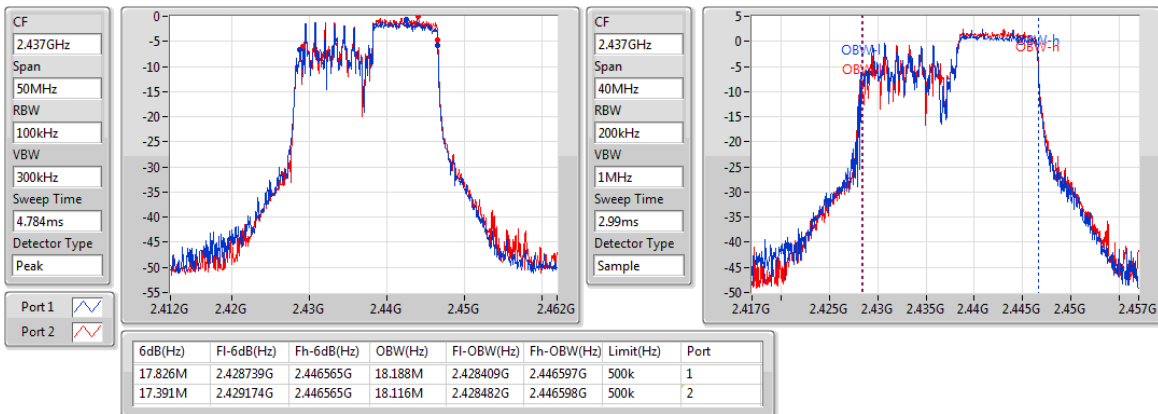

802.11ax HEW20_RU106_Index54_Nss1,(MCS0)_2TX

EBW

2462MHz

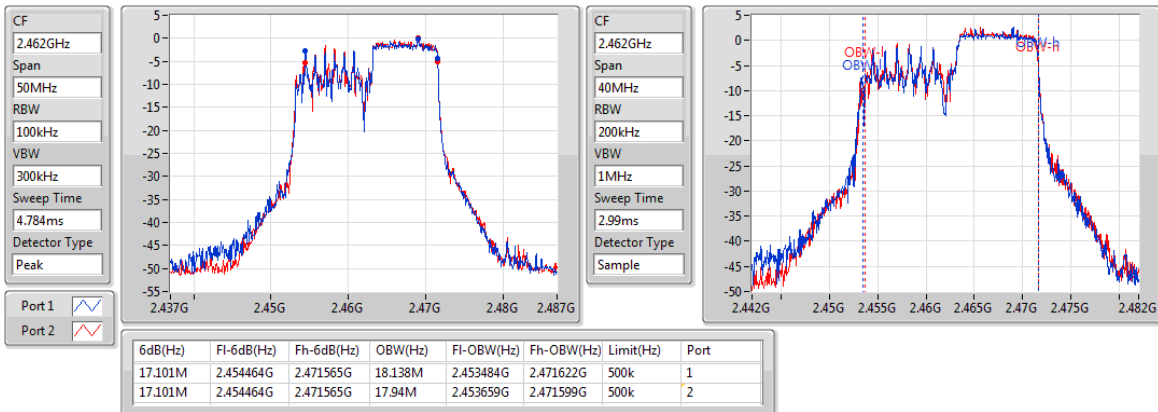

802.11ax HEW20_RU242_Index61_Nss1,(MCS0)_2TX

EBW

2412MHz

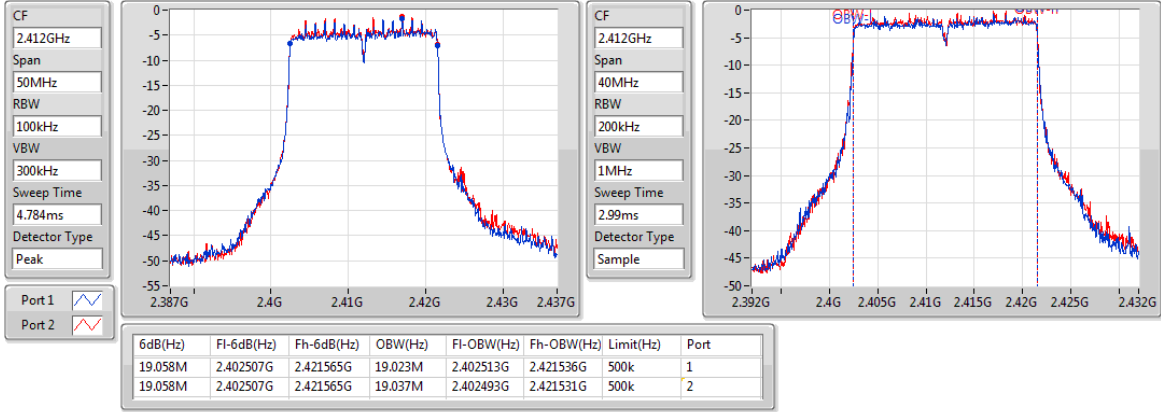

802.11ax HEW20_RU242_Index61_Nss1,(MCS0)_2TX

EBW

2437MHz

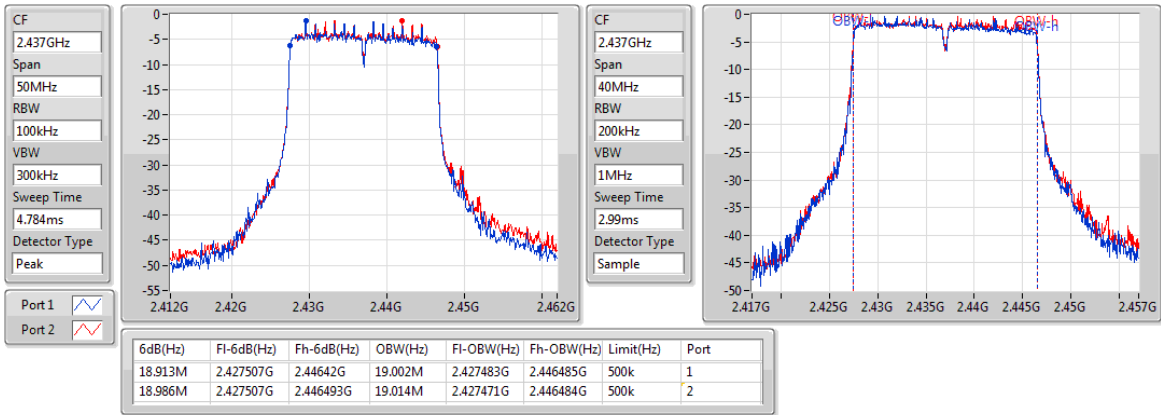

802.11ax HEW20_RU242_Index61_Nss1,(MCS0)_2TX

EBW

2462MHz

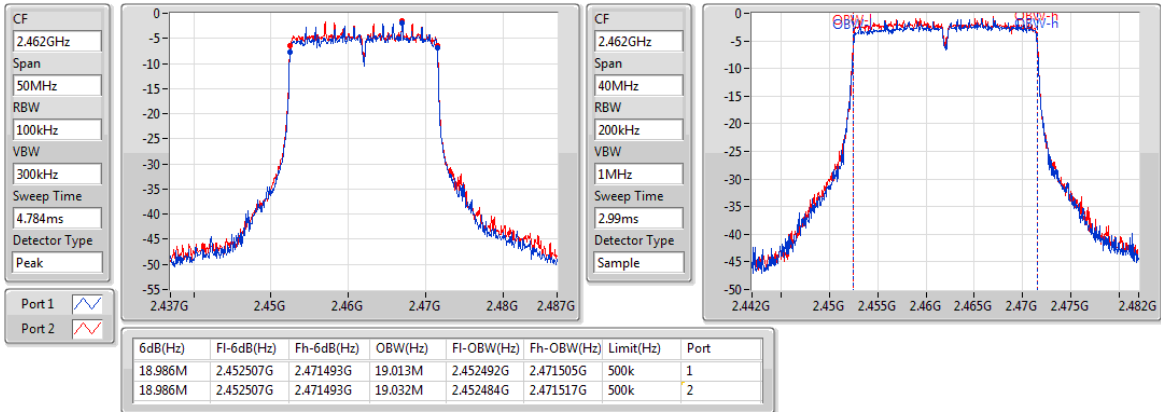

802.11ax HEW40_RU26_Index9_Nss1,(MCS0)_2TX

EBW

2422MHz

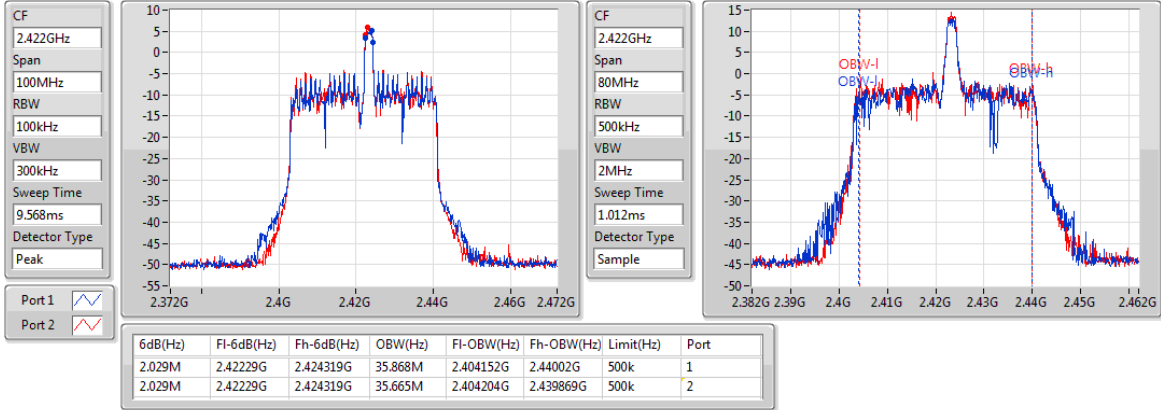

802.11ax HEW40_RU26_Index9_Nss1,(MCS0)_2TX

EBW

2437MHz

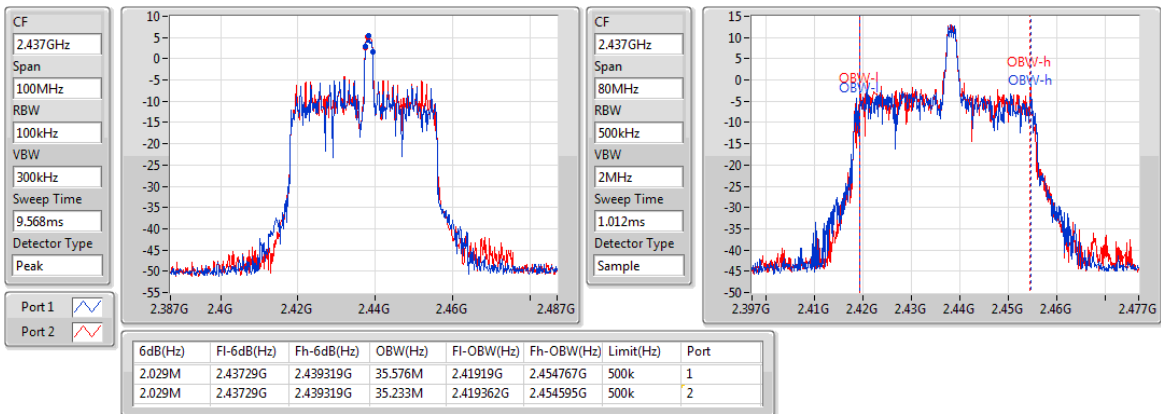

802.11ax HEW40_RU26_Index9_Nss1,(MCS0)_2TX

EBW

2452MHz

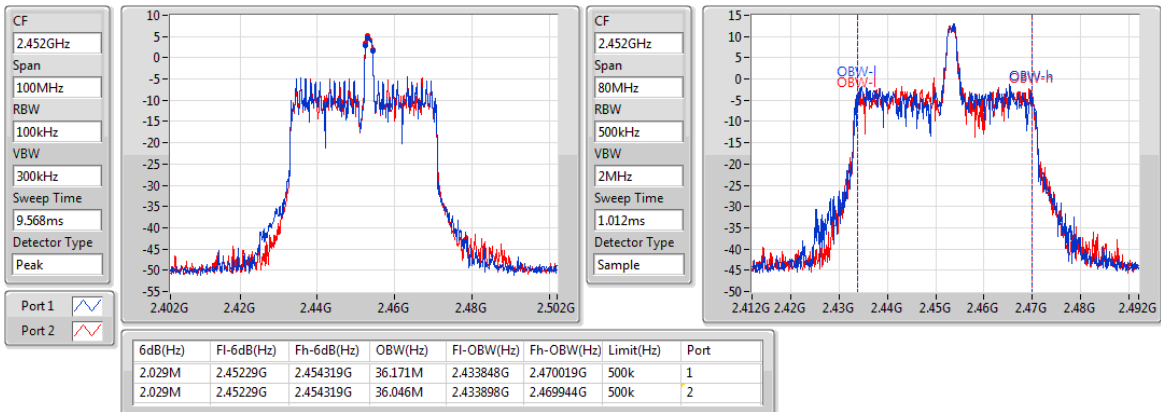

802.11ax HEW40_RU52_Index41_Nss1,(MCS0)_2TX

EBW

2422MHz

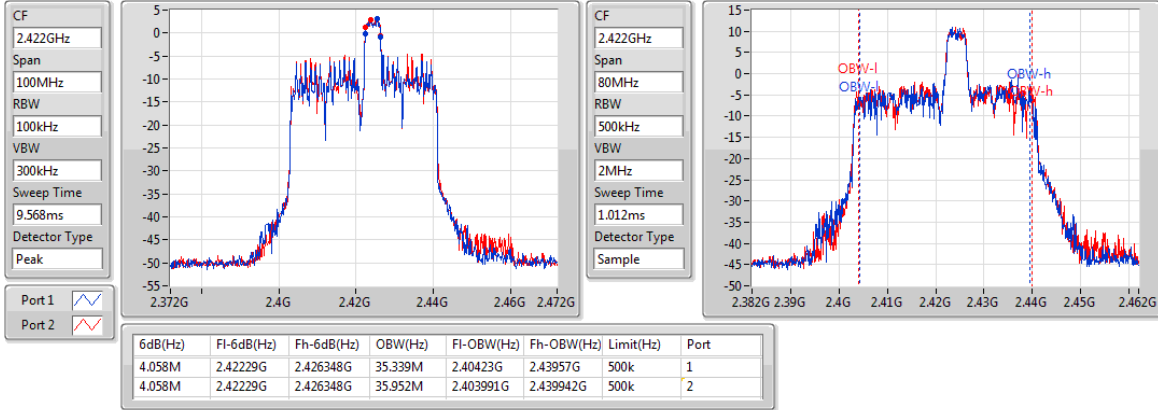

802.11ax HEW40_RU52_Index41_Nss1,(MCS0)_2TX

EBW

2437MHz

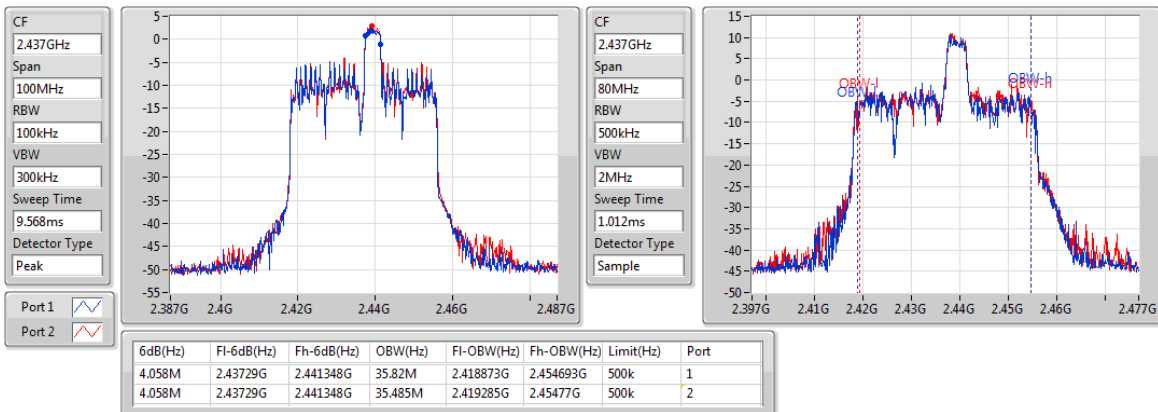

802.11ax HEW40_RU52_Index41_Nss1,(MCS0)_2TX

EBW

2452MHz

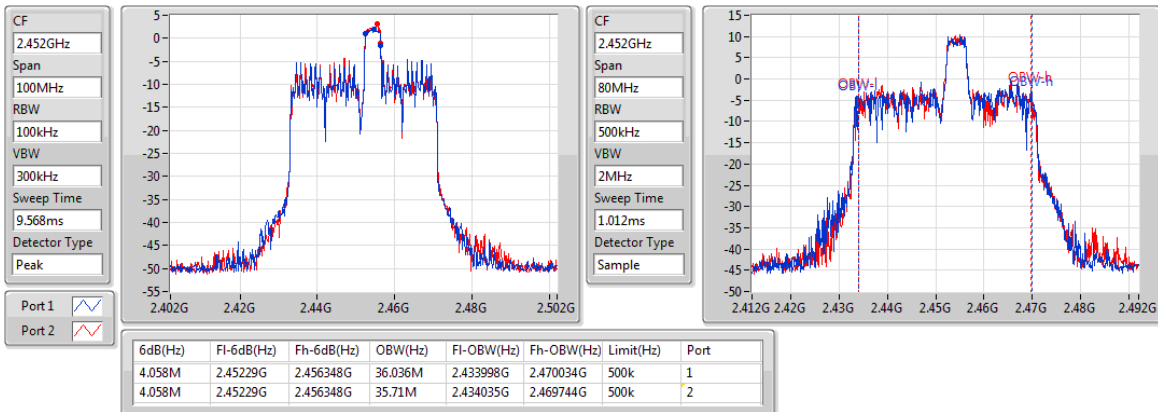

802.11ax HEW40_RU106_Index54_Nss1,(MCS0)_2TX

EBW

2422MHz

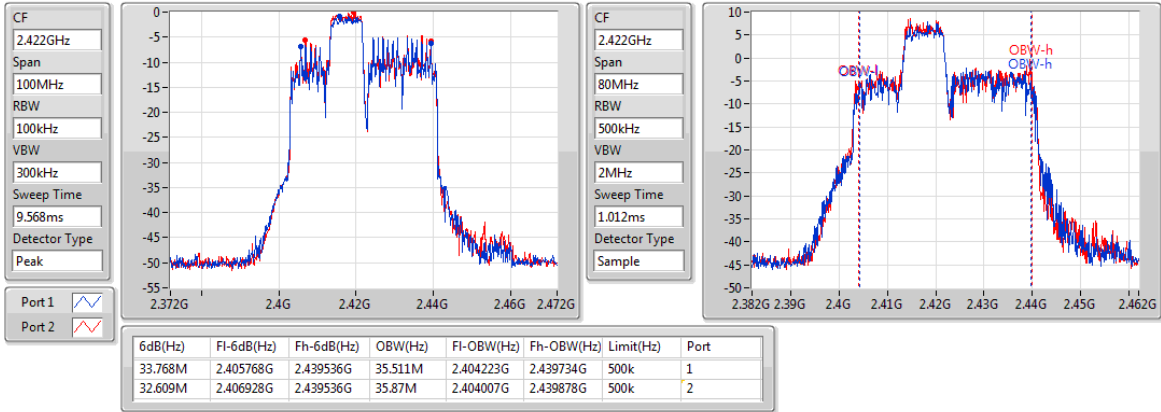

802.11ax HEW40_RU106_Index54_Nss1,(MCS0)_2TX

EBW

2437MHz

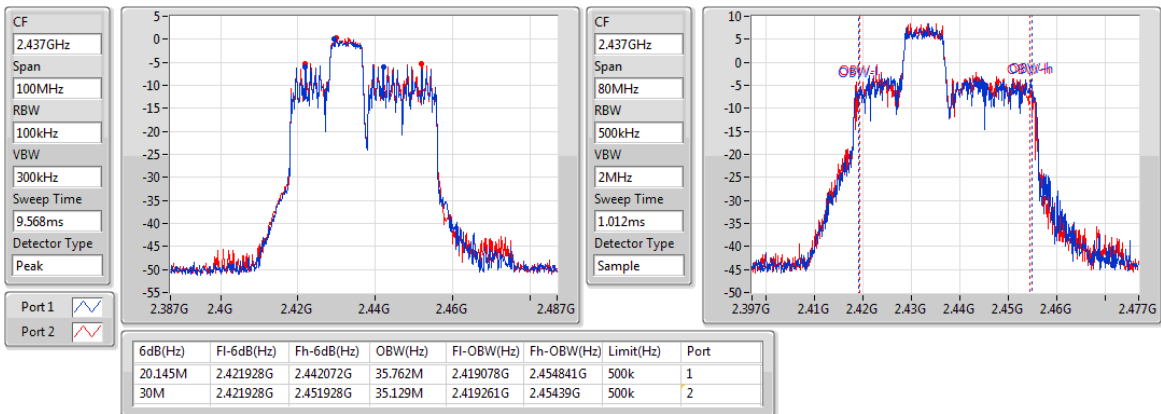

802.11ax HEW40_RU106_Index54_Nss1,(MCS0)_2TX

EBW

2452MHz

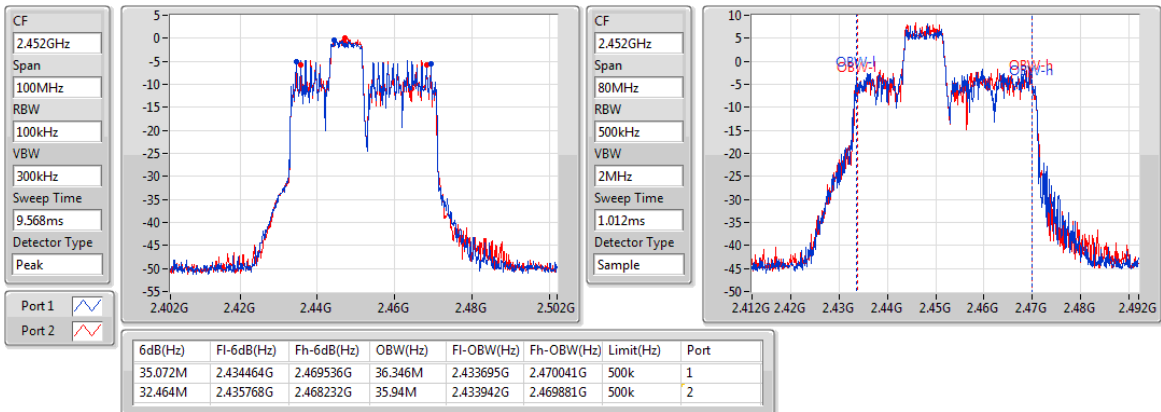

802.11ax HEW40_RU242_Index62_Nss1,(MCS0)_2TX

EBW

2422MHz

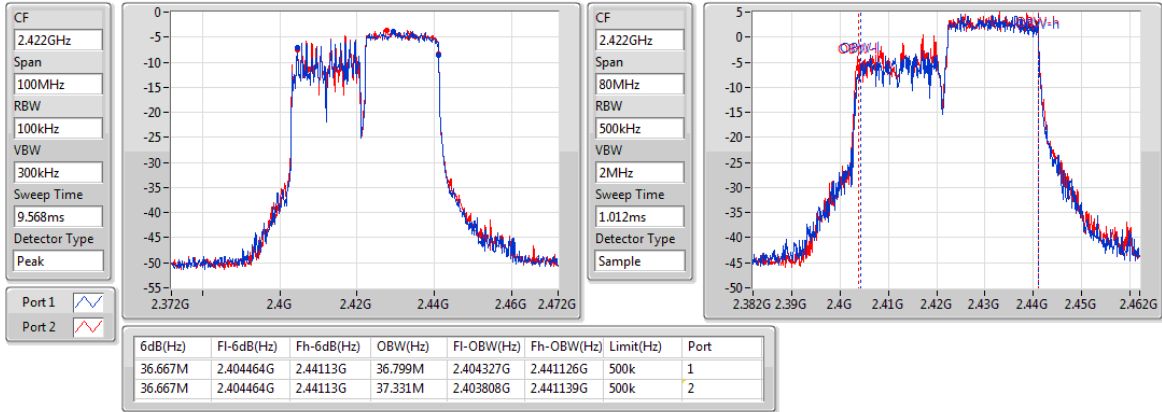

802.11ax HEW40_RU242_Index62_Nss1,(MCS0)_2TX

EBW

2437MHz

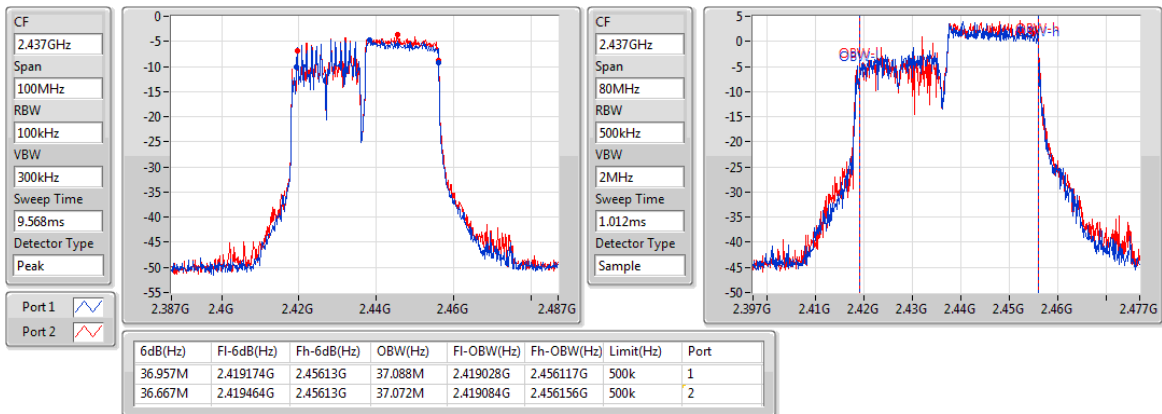

802.11ax HEW40_RU242_Index62_Nss1,(MCS0)_2TX

EBW

2452MHz

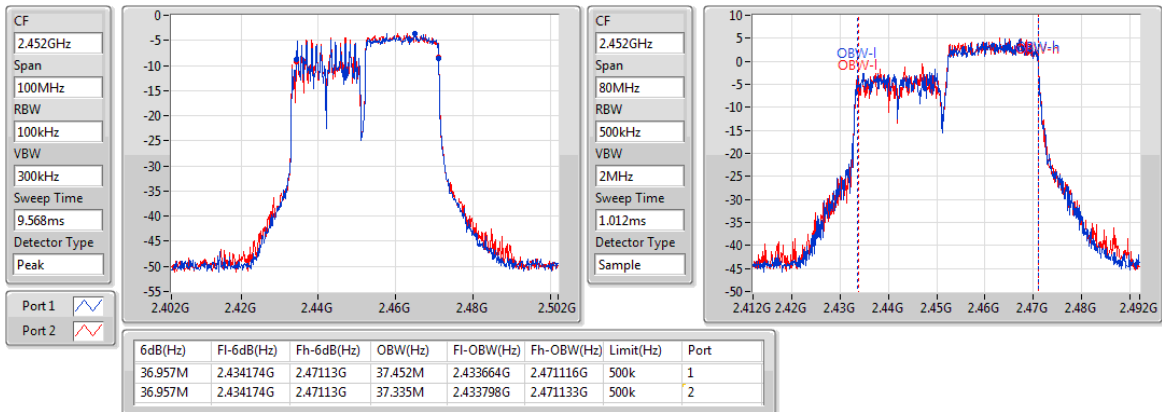

802.11ax HEW40_RU484_Index65_Nss1,(MCS0)_2TX

EBW

2422MHz

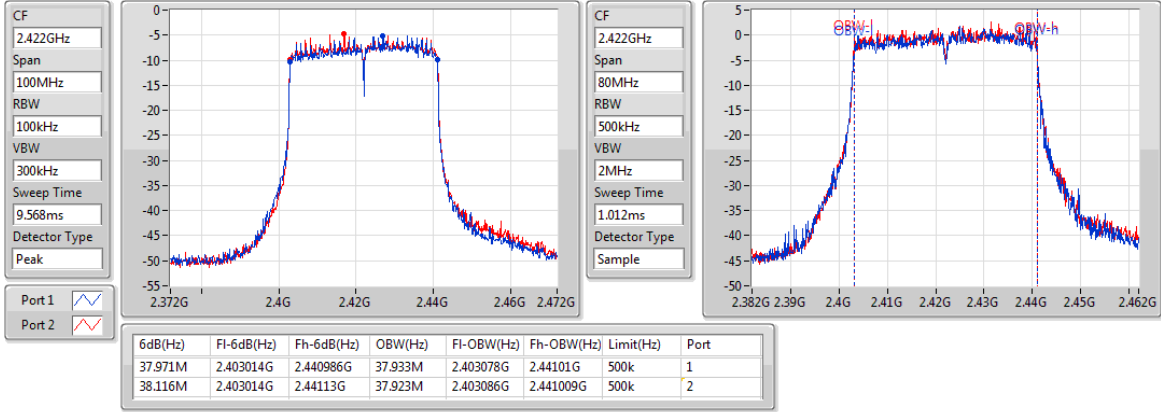

802.11ax HEW40_RU484_Index65_Nss1,(MCS0)_2TX

EBW

2437MHz

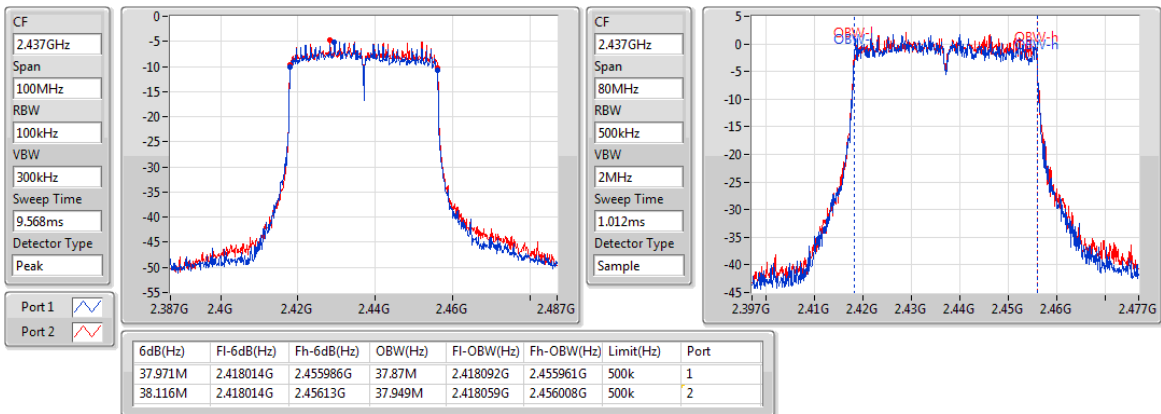

802.11ax HEW40_RU484_Index65_Nss1,(MCS0)_2TX

EBW

2452MHz

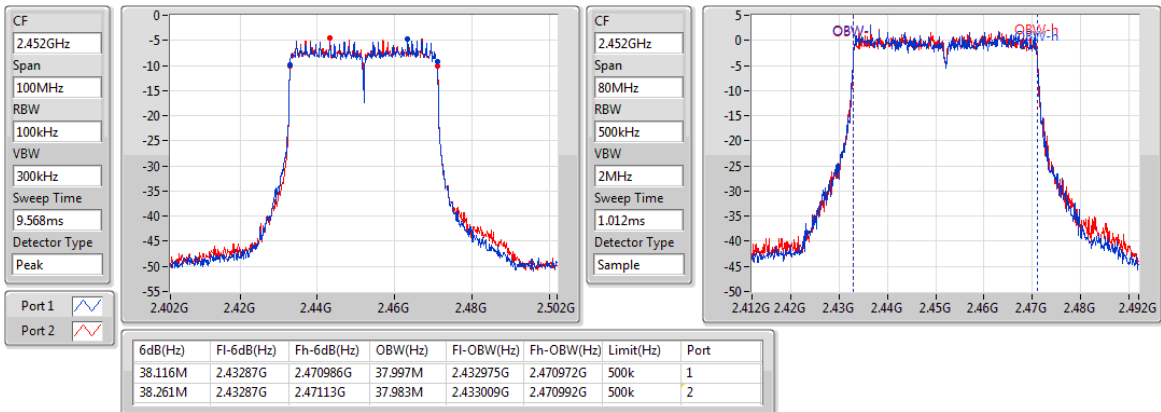

3.3 RF Output Power

3.3.1 Limit of RF Output Power

Conducted power shall not exceed 1Watt.

Antenna gain $\leq 6\text{dBi}$, no any corresponding reduction is in output power limit.

3.3.2 Test Procedures

A broadband RF power meter is used for output power measurement. The video bandwidth of power meter is greater than DTS bandwidth of EUT. If duty cycle of test signal is not 100 %, trigger and gating function of power meter will be enabled to capture transmission burst for measuring output power.

3.3.3 Test Setup

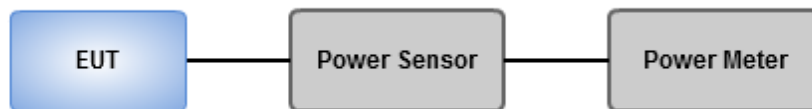

3.3.4 Test Result of Maximum Output Power

Summary of Peak Conducted Output Power

Mode	Total Power (dBm)	Total Power (W)
2.4-2.4835GHz	-	-
802.11b_Nss1,(1Mbps)_2TX	21.65	0.14622
802.11g_Nss1,(6Mbps)_2TX	24.31	0.26977
802.11n HT20_Nss1,(MCS0)_2TX	22.69	0.18578
802.11n HT40_Nss1,(MCS0)_2TX	21.88	0.15417
11AX20_Nss1,(MCS0)_2TX	22.48	0.17701
11AX40_Nss1,(MCS0)_2TX	22.33	0.17100

Result

Mode	Result	DG (dBi)	Port 1 (dBm)	Port 2 (dBm)	Total Power (dBm)	Power Limit (dBm)	EIRP (dBm)	EIRP Limit (dBm)
802.11b_Nss1,(1Mbps)_2TX	-	-	-	-	-	-	-	-
2412MHz	Pass	-6.00	18.54	18.74	21.65	30.00	15.65	36.00
2437MHz	Pass	-6.00	18.26	18.76	21.53	30.00	15.53	36.00
2462MHz	Pass	-6.00	18.47	18.57	21.53	30.00	15.53	36.00
802.11g_Nss1,(6Mbps)_2TX	-	-	-	-	-	-	-	-
2412MHz	Pass	-6.00	21.28	21.31	24.31	30.00	18.31	36.00
2437MHz	Pass	-6.00	21.01	21.29	24.16	30.00	18.16	36.00
2462MHz	Pass	-6.00	20.99	21.29	24.15	30.00	18.15	36.00
802.11n HT20_Nss1,(MCS0)_2TX	-	-	-	-	-	-	-	-
2412MHz	Pass	-6.00	19.39	19.62	22.52	30.00	16.52	36.00
2437MHz	Pass	-6.00	19.58	19.77	22.69	30.00	16.69	36.00
2462MHz	Pass	-6.00	19.21	19.46	22.35	30.00	16.35	36.00
802.11n HT40_Nss1,(MCS0)_2TX	-	-	-	-	-	-	-	-
2422MHz	Pass	-6.00	18.56	18.90	21.74	30.00	15.74	36.00
2437MHz	Pass	-6.00	18.66	18.95	21.82	30.00	15.82	36.00
2452MHz	Pass	-6.00	18.64	19.08	21.88	30.00	15.88	36.00
11AX20_Nss1,(MCS0)_2TX	-	-	-	-	-	-	-	-
2412MHz	Pass	-6.00	19.26	19.54	22.41	30.00	16.41	36.00
2437MHz	Pass	-6.00	19.32	19.61	22.48	30.00	16.48	36.00
2462MHz	Pass	-6.00	19.34	19.32	22.34	30.00	16.34	36.00
11AX40_Nss1,(MCS0)_2TX	-	-	-	-	-	-	-	-
2422MHz	Pass	-6.00	18.89	19.12	22.02	30.00	16.02	36.00
2437MHz	Pass	-6.00	18.82	19.29	22.07	30.00	16.07	36.00
2452MHz	Pass	-6.00	19.24	19.39	22.33	30.00	16.33	36.00

DG = Directional Gain; Port X = Port X output power

Summary of Conducted (Average) Output Power

Mode	Total Power (dBm)	Total Power (W)
2.4-2.4835GHz	-	-
802.11b_Nss1,(1Mbps)_2TX	19.16	0.08241
802.11g_Nss1,(6Mbps)_2TX	17.79	0.06012
802.11n HT20_Nss1,(MCS0)_2TX	15.74	0.03750
802.11n HT40_Nss1,(MCS0)_2TX	14.70	0.02951
11AX20_Nss1,(MCS0)_2TX	14.75	0.02985
11AX40_Nss1,(MCS0)_2TX	14.92	0.03105

Result

Mode	Result	DG (dBi)	Port 1 (dBm)	Port 2 (dBm)	Total Power (dBm)	Power Limit (dBm)	EIRP (dBm)	EIRP Limit (dBm)
802.11b_Nss1,(1Mbps)_2TX	-	-	-	-	-	-	-	-
2412MHz	Pass	-6.00	16.03	16.26	19.16	-	13.16	-
2437MHz	Pass	-6.00	15.84	16.22	19.04	-	13.04	-
2462MHz	Pass	-6.00	15.96	16.16	19.07	-	13.07	-
802.11g_Nss1,(6Mbps)_2TX	-	-	-	-	-	-	-	-
2412MHz	Pass	-6.00	14.75	14.81	17.79	-	11.79	-
2437MHz	Pass	-6.00	14.61	14.76	17.70	-	11.70	-
2462MHz	Pass	-6.00	14.50	14.61	17.57	-	11.57	-
802.11n HT20_Nss1,(MCS0)_2TX	-	-	-	-	-	-	-	-
2412MHz	Pass	-6.00	12.56	12.84	15.71	-	9.71	-
2437MHz	Pass	-6.00	12.62	12.83	15.74	-	9.74	-
2462MHz	Pass	-6.00	12.42	12.61	15.53	-	9.53	-
802.11n HT40_Nss1,(MCS0)_2TX	-	-	-	-	-	-	-	-
2422MHz	Pass	-6.00	11.52	11.72	14.63	-	8.63	-
2437MHz	Pass	-6.00	11.58	11.79	14.70	-	8.70	-
2452MHz	Pass	-6.00	11.58	11.77	14.69	-	8.69	-
11AX20_Nss1,(MCS0)_2TX	-	-	-	-	-	-	-	-
2412MHz	Pass	-6.00	11.57	11.74	14.67	-	8.67	-
2437MHz	Pass	-6.00	11.59	11.89	14.75	-	8.75	-
2462MHz	Pass	-6.00	11.52	11.63	14.59	-	8.59	-
11AX40_Nss1,(MCS0)_2TX	-	-	-	-	-	-	-	-
2422MHz	Pass	-6.00	11.79	11.95	14.88	-	8.88	-
2437MHz	Pass	-6.00	11.74	11.92	14.84	-	8.84	-
2452MHz	Pass	-6.00	11.83	11.99	14.92	-	8.92	-

DG = Directional Gain; Port X = Port X output power

Note : Conducted average output power is for reference only

Summary of Peak Conducted Output Power

Mode	Total Power (dBm)	Total Power (W)
2.4-2.4835GHz	-	-
802.11ax HEW20_RU26_Index0_Nss1,(MCS0)_2TX	21.73	0.14894
802.11ax HEW20_RU26_Index4_Nss1,(MCS0)_2TX	21.85	0.15311
802.11ax HEW20_RU26_Index8_Nss1,(MCS0)_2TX	21.73	0.14894
802.11ax HEW20_RU52_Index37_Nss1,(MCS0)_2TX	22.49	0.17742
802.11ax HEW20_RU52_Index38_Nss1,(MCS0)_2TX	22.59	0.18155
802.11ax HEW20_RU52_Index40_Nss1,(MCS0)_2TX	22.54	0.17947
802.11ax HEW20_RU106_Index53_Nss1,(MCS0)_2TX	22.42	0.17458
802.11ax HEW20_RU106_Index54_Nss1,(MCS0)_2TX	22.43	0.17498
802.11ax HEW20_RU242_Index61_Nss1,(MCS0)_2TX	22.60	0.18197
802.11ax HEW40_RU26_Index0_Nss1,(MCS0)_2TX	21.65	0.14622
802.11ax HEW40_RU26_Index9_Nss1,(MCS0)_2TX	21.81	0.15171
802.11ax HEW40_RU26_Index17_Nss1,(MCS0)_2TX	21.68	0.14723
802.11ax HEW40_RU52_Index37_Nss1,(MCS0)_2TX	22.46	0.17620
802.11ax HEW40_RU52_Index41_Nss1,(MCS0)_2TX	22.50	0.17783
802.11ax HEW40_RU52_Index44_Nss1,(MCS0)_2TX	22.44	0.17539
802.11ax HEW40_RU106_Index53_Nss1,(MCS0)_2TX	22.21	0.16634
802.11ax HEW40_RU106_Index54_Nss1,(MCS0)_2TX	22.24	0.16749
802.11ax HEW40_RU106_Index56_Nss1,(MCS0)_2TX	22.24	0.16749
802.11ax HEW40_RU242_Index61_Nss1,(MCS0)_2TX	22.40	0.17378
802.11ax HEW40_RU242_Index62_Nss1,(MCS0)_2TX	22.53	0.17906
802.11ax HEW40_RU484_Index65_Nss1,(MCS0)_2TX	22.23	0.16711

Result

Mode	Result	DG (dBi)	Port 1 (dBm)	Port 2 (dBm)	Total Power (dBm)	Power Limit (dBm)	EIRP (dBm)	EIRP Limit (dBm)
802.11ax HEW20_RU26_Index0_Nss1,(MCS0)_2TX	-	-	-	-	-	-	-	-
2412MHz	Pass	-6.00	18.43	18.94	21.70	30.00	15.70	36.00
2437MHz	Pass	-6.00	18.61	18.79	21.71	30.00	15.71	36.00
2462MHz	Pass	-6.00	18.71	18.72	21.73	30.00	15.73	36.00
802.11ax HEW20_RU26_Index4_Nss1,(MCS0)_2TX	-	-	-	-	-	-	-	-
2412MHz	Pass	-6.00	18.65	18.9	21.79	30.00	15.79	36.00
2437MHz	Pass	-6.00	18.83	18.85	21.85	30.00	15.85	36.00
2462MHz	Pass	-6.00	18.65	18.91	21.79	30.00	15.79	36.00
802.11ax HEW20_RU26_Index8_Nss1,(MCS0)_2TX	-	-	-	-	-	-	-	-
2412MHz	Pass	-6.00	18.58	18.72	21.66	30.00	15.66	36.00
2437MHz	Pass	-6.00	18.61	18.82	21.73	30.00	15.73	36.00
2462MHz	Pass	-6.00	18.47	18.94	21.72	30.00	15.72	36.00
802.11ax HEW20_RU52_Index37_Nss1,(MCS0)_2TX	-	-	-	-	-	-	-	-
2412MHz	Pass	-6.00	19.34	19.51	22.44	30.00	16.44	36.00
2437MHz	Pass	-6.00	19.23	19.71	22.49	30.00	16.49	36.00
2462MHz	Pass	-6.00	19.22	19.7	22.48	30.00	16.48	36.00
802.11ax HEW20_RU52_Index38_Nss1,(MCS0)_2TX	-	-	-	-	-	-	-	-
2412MHz	Pass	-6.00	19.23	19.67	22.47	30.00	16.47	36.00
2437MHz	Pass	-6.00	19.56	19.57	22.58	30.00	16.58	36.00
2462MHz	Pass	-6.00	19.44	19.72	22.59	30.00	16.59	36.00
802.11ax HEW20_RU52_Index40_Nss1,(MCS0)_2TX	-	-	-	-	-	-	-	-
2412MHz	Pass	-6.00	19.21	19.51	22.37	30.00	16.37	36.00
2437MHz	Pass	-6.00	19.31	19.6	22.47	30.00	16.47	36.00
2462MHz	Pass	-6.00	19.55	19.5	22.54	30.00	16.54	36.00
802.11ax HEW20_RU106_Index53_Nss1,(MCS0)_2TX	-	-	-	-	-	-	-	-
2412MHz	Pass	-6.00	19.28	19.39	22.35	30.00	16.35	36.00
2437MHz	Pass	-6.00	19.29	19.53	22.42	30.00	16.42	36.00
2462MHz	Pass	-6.00	19.04	19.35	22.21	30.00	16.21	36.00
802.11ax HEW20_RU106_Index54_Nss1,(MCS0)_2TX	-	-	-	-	-	-	-	-
2412MHz	Pass	-6.00	19.26	19.47	22.38	30.00	16.38	36.00
2437MHz	Pass	-6.00	19.09	19.62	22.37	30.00	16.37	36.00
2462MHz	Pass	-6.00	19.24	19.6	22.43	30.00	16.43	36.00
802.11ax HEW20_RU242_Index61_Nss1,(MCS0)_2TX	-	-	-	-	-	-	-	-
2412MHz	Pass	-6.00	19.37	19.62	22.51	30.00	16.51	36.00
2437MHz	Pass	-6.00	19.47	19.7	22.60	30.00	16.60	36.00

Mode	Result	DG (dBi)	Port 1 (dBm)	Port 2 (dBm)	Total Power (dBm)	Power Limit (dBm)	EIRP (dBm)	EIRP Limit (dBm)
2462MHz	Pass	-6.00	19.32	19.41	22.38	30.00	16.38	36.00
802.11ax HEW40_RU26_Index0_Nss1,(MCS0)_2TX	-	-	-	-	-	-	-	-
2422MHz	Pass	-6.00	18.59	18.68	21.65	30.00	15.65	36.00
2437MHz	Pass	-6.00	18.49	18.7	21.61	30.00	15.61	36.00
2452MHz	Pass	-6.00	18.29	18.59	21.45	30.00	15.45	36.00
802.11ax HEW40_RU26_Index9_Nss1,(MCS0)_2TX	-	-	-	-	-	-	-	-
2422MHz	Pass	-6.00	18.64	18.82	21.74	30.00	15.74	36.00
2437MHz	Pass	-6.00	18.7	18.9	21.81	30.00	15.81	36.00
2452MHz	Pass	-6.00	18.72	18.7	21.72	30.00	15.72	36.00
802.11ax HEW40_RU26_Index17_Nss1,(MCS0)_2TX	-	-	-	-	-	-	-	-
2422MHz	Pass	-6.00	18.41	18.85	21.65	30.00	15.65	36.00
2437MHz	Pass	-6.00	18.52	18.82	21.68	30.00	15.68	36.00
2452MHz	Pass	-6.00	18.47	18.79	21.64	30.00	15.64	36.00
802.11ax HEW40_RU52_Index37_Nss1,(MCS0)_2TX	-	-	-	-	-	-	-	-
2422MHz	Pass	-6.00	19.34	19.56	22.46	30.00	16.46	36.00
2437MHz	Pass	-6.00	19.06	19.42	22.25	30.00	16.25	36.00
2452MHz	Pass	-6.00	19.48	19.41	22.46	30.00	16.46	36.00
802.11ax HEW40_RU52_Index41_Nss1,(MCS0)_2TX	-	-	-	-	-	-	-	-
2422MHz	Pass	-6.00	19.2	19.69	22.46	30.00	16.46	36.00
2437MHz	Pass	-6.00	19.41	19.51	22.47	30.00	16.47	36.00
2452MHz	Pass	-6.00	19.22	19.75	22.50	30.00	16.50	36.00
802.11ax HEW40_RU52_Index44_Nss1,(MCS0)_2TX	-	-	-	-	-	-	-	-
2422MHz	Pass	-6.00	19.37	19.49	22.44	30.00	16.44	36.00
2437MHz	Pass	-6.00	19.28	19.52	22.41	30.00	16.41	36.00
2452MHz	Pass	-6.00	19.29	19.32	22.32	30.00	16.32	36.00
802.11ax HEW40_RU106_Index53_Nss1,(MCS0)_2TX	-	-	-	-	-	-	-	-
2422MHz	Pass	-6.00	18.86	19.18	22.03	30.00	16.03	36.00
2437MHz	Pass	-6.00	19.19	19.21	22.21	30.00	16.21	36.00
2452MHz	Pass	-6.00	19.07	19.32	22.21	30.00	16.21	36.00
802.11ax HEW40_RU106_Index54_Nss1,(MCS0)_2TX	-	-	-	-	-	-	-	-
2422MHz	Pass	-6.00	19.08	19.17	22.14	30.00	16.14	36.00
2437MHz	Pass	-6.00	19.26	19.2	22.24	30.00	16.24	36.00
2452MHz	Pass	-6.00	18.98	19.31	22.16	30.00	16.16	36.00
802.11ax HEW40_RU106_Index56_Nss1,(MCS0)_2TX	-	-	-	-	-	-	-	-
2422MHz	Pass	-6.00	18.86	19.14	22.01	30.00	16.01	36.00
2437MHz	Pass	-6.00	19.04	19.41	22.24	30.00	16.24	36.00
2452MHz	Pass	-6.00	18.9	19.29	22.11	30.00	16.11	36.00

Mode	Result	DG (dBi)	Port 1 (dBm)	Port 2 (dBm)	Total Power (dBm)	Power Limit (dBm)	EIRP (dBm)	EIRP Limit (dBm)
802.11ax HEW40_RU242_Index61_Nss1,(MCS0)_2TX	-	-	-	-	-	-	-	-
2422MHz	Pass	-6.00	19.09	19.31	22.21	30.00	16.21	36.00
2437MHz	Pass	-6.00	19.13	19.64	22.40	30.00	16.40	36.00
2452MHz	Pass	-6.00	19.1	19.55	22.34	30.00	16.34	36.00
802.11ax HEW40_RU242_Index62_Nss1,(MCS0)_2TX	-	-	-	-	-	-	-	-
2422MHz	Pass	-6.00	19.32	19.56	22.45	30.00	16.45	36.00
2437MHz	Pass	-6.00	19.42	19.61	22.53	30.00	16.53	36.00
2452MHz	Pass	-6.00	19.1	19.68	22.41	30.00	16.41	36.00
802.11ax HEW40_RU484_Index65_Nss1,(MCS0)_2TX	-	-	-	-	-	-	-	-
2422MHz	Pass	-6.00	19.14	19.3	22.23	30.00	16.23	36.00
2437MHz	Pass	-6.00	19.17	19.15	22.17	30.00	16.17	36.00
2452MHz	Pass	-6.00	18.97	19.16	22.08	30.00	16.08	36.00

DG = Directional Gain; **Port X** = Port X output power

Summary of Conducted (Average) Output Power

Mode	Total Power (dBm)	Total Power (W)
2.4-2.4835GHz	-	-
802.11ax HEW20_RU26_Index0_Nss1,(MCS0)_2TX	12.95	0.01972
802.11ax HEW20_RU26_Index4_Nss1,(MCS0)_2TX	13.01	0.02000
802.11ax HEW20_RU26_Index8_Nss1,(MCS0)_2TX	12.91	0.01954
802.11ax HEW20_RU52_Index37_Nss1,(MCS0)_2TX	12.93	0.01963
802.11ax HEW20_RU52_Index38_Nss1,(MCS0)_2TX	13.10	0.02042
802.11ax HEW20_RU52_Index40_Nss1,(MCS0)_2TX	12.97	0.01982
802.11ax HEW20_RU106_Index53_Nss1,(MCS0)_2TX	12.97	0.01982
802.11ax HEW20_RU106_Index54_Nss1,(MCS0)_2TX	13.05	0.02018
802.11ax HEW20_RU242_Index61_Nss1,(MCS0)_2TX	13.04	0.02014
802.11ax HEW40_RU26_Index0_Nss1,(MCS0)_2TX	12.91	0.01954
802.11ax HEW40_RU26_Index9_Nss1,(MCS0)_2TX	13.01	0.02000
802.11ax HEW40_RU26_Index17_Nss1,(MCS0)_2TX	12.95	0.01972
802.11ax HEW40_RU52_Index37_Nss1,(MCS0)_2TX	12.91	0.01954
802.11ax HEW40_RU52_Index41_Nss1,(MCS0)_2TX	13.03	0.02009
802.11ax HEW40_RU52_Index44_Nss1,(MCS0)_2TX	12.95	0.01972
802.11ax HEW40_RU106_Index53_Nss1,(MCS0)_2TX	12.94	0.01968
802.11ax HEW40_RU106_Index54_Nss1,(MCS0)_2TX	12.96	0.01977
802.11ax HEW40_RU106_Index56_Nss1,(MCS0)_2TX	12.92	0.01959
802.11ax HEW40_RU242_Index61_Nss1,(MCS0)_2TX	12.84	0.01923
802.11ax HEW40_RU242_Index62_Nss1,(MCS0)_2TX	13.01	0.02000
802.11ax HEW40_RU484_Index65_Nss1,(MCS0)_2TX	12.97	0.01982

Result

Mode	Result	DG (dBi)	Port 1 (dBm)	Port 2 (dBm)	Total Power (dBm)	Power Limit (dBm)	EIRP (dBm)	EIRP Limit (dBm)
802.11ax HEW20_RU26_Index0_Nss1,(MCS0)_2TX	-	-	-	-	-	-	-	-
2412MHz	Pass	-6.00	9.72	10.06	12.90	-	6.90	-
2437MHz	Pass	-6.00	9.83	10.05	12.95	-	6.95	-
2462MHz	Pass	-6.00	9.74	10.03	12.90	-	6.90	-
802.11ax HEW20_RU26_Index4_Nss1,(MCS0)_2TX	-	-	-	-	-	-	-	-
2412MHz	Pass	-6.00	9.73	10.11	12.93	-	6.93	-
2437MHz	Pass	-6.00	9.88	10.12	13.01	-	7.01	-
2462MHz	Pass	-6.00	9.71	10.1	12.92	-	6.92	-
802.11ax HEW20_RU26_Index8_Nss1,(MCS0)_2TX	-	-	-	-	-	-	-	-
2412MHz	Pass	-6.00	9.61	10.01	12.82	-	6.82	-
2437MHz	Pass	-6.00	9.71	10.08	12.91	-	6.91	-
2462MHz	Pass	-6.00	9.63	10.15	12.91	-	6.91	-
802.11ax HEW20_RU52_Index37_Nss1,(MCS0)_2TX	-	-	-	-	-	-	-	-
2412MHz	Pass	-6.00	9.64	10.07	12.87	-	6.87	-
2437MHz	Pass	-6.00	9.81	10.03	12.93	-	6.93	-
2462MHz	Pass	-6.00	9.66	10.13	12.91	-	6.91	-
802.11ax HEW20_RU52_Index38_Nss1,(MCS0)_2TX	-	-	-	-	-	-	-	-
2412MHz	Pass	-6.00	9.74	10.13	12.95	-	6.95	-
2437MHz	Pass	-6.00	9.98	10.19	13.10	-	7.10	-
2462MHz	Pass	-6.00	9.76	10.16	12.97	-	6.97	-
802.11ax HEW20_RU52_Index40_Nss1,(MCS0)_2TX	-	-	-	-	-	-	-	-
2412MHz	Pass	-6.00	9.67	10.02	12.86	-	6.86	-
2437MHz	Pass	-6.00	9.76	10.06	12.92	-	6.92	-
2462MHz	Pass	-6.00	9.89	10.02	12.97	-	6.97	-
802.11ax HEW20_RU106_Index53_Nss1,(MCS0)_2TX	-	-	-	-	-	-	-	-
2412MHz	Pass	-6.00	9.78	10.02	12.91	-	6.91	-
2437MHz	Pass	-6.00	9.89	10.03	12.97	-	6.97	-
2462MHz	Pass	-6.00	9.91	10.01	12.97	-	6.97	-
802.11ax HEW20_RU106_Index54_Nss1,(MCS0)_2TX	-	-	-	-	-	-	-	-
2412MHz	Pass	-6.00	9.81	10.13	12.98	-	6.98	-
2437MHz	Pass	-6.00	9.89	10.19	13.05	-	7.05	-
2462MHz	Pass	-6.00	9.83	10.17	13.01	-	7.01	-
802.11ax HEW20_RU242_Index61_Nss1,(MCS0)_2TX	-	-	-	-	-	-	-	-
2412MHz	Pass	-6.00	9.92	10.07	13.01	-	7.01	-
2437MHz	Pass	-6.00	9.96	10.1	13.04	-	7.04	-

Mode	Result	DG (dBi)	Port 1 (dBm)	Port 2 (dBm)	Total Power (dBm)	Power Limit (dBm)	EIRP (dBm)	EIRP Limit (dBm)
2462MHz	Pass	-6.00	9.88	10.03	12.97	-	6.97	-
802.11ax HEW40_RU26_Index0_Nss1,(MCS0)_2TX	-	-	-	-	-	-	-	-
2422MHz	Pass	-6.00	9.76	10.02	12.90	-	6.90	-
2437MHz	Pass	-6.00	9.77	10.03	12.91	-	6.91	-
2452MHz	Pass	-6.00	9.66	9.92	12.80	-	6.80	-
802.11ax HEW40_RU26_Index9_Nss1,(MCS0)_2TX	-	-	-	-	-	-	-	-
2422MHz	Pass	-6.00	9.79	10.06	12.94	-	6.94	-
2437MHz	Pass	-6.00	9.89	10.11	13.01	-	7.01	-
2452MHz	Pass	-6.00	9.83	10.03	12.94	-	6.94	-
802.11ax HEW40_RU26_Index17_Nss1,(MCS0)_2TX	-	-	-	-	-	-	-	-
2422MHz	Pass	-6.00	9.76	10.05	12.92	-	6.92	-
2437MHz	Pass	-6.00	9.81	10.06	12.95	-	6.95	-
2452MHz	Pass	-6.00	9.7	10.02	12.87	-	6.87	-
802.11ax HEW40_RU52_Index37_Nss1,(MCS0)_2TX	-	-	-	-	-	-	-	-
2422MHz	Pass	-6.00	9.65	10.06	12.87	-	6.87	-
2437MHz	Pass	-6.00	9.66	10.03	12.86	-	6.86	-
2452MHz	Pass	-6.00	9.86	9.94	12.91	-	6.91	-
802.11ax HEW40_RU52_Index41_Nss1,(MCS0)_2TX	-	-	-	-	-	-	-	-
2422MHz	Pass	-6.00	9.72	10.12	12.93	-	6.93	-
2437MHz	Pass	-6.00	9.89	10.14	13.03	-	7.03	-
2452MHz	Pass	-6.00	9.78	10.11	12.96	-	6.96	-
802.11ax HEW40_RU52_Index44_Nss1,(MCS0)_2TX	-	-	-	-	-	-	-	-
2422MHz	Pass	-6.00	9.81	10.02	12.93	-	6.93	-
2437MHz	Pass	-6.00	9.83	10.05	12.95	-	6.95	-
2452MHz	Pass	-6.00	9.71	9.98	12.86	-	6.86	-
802.11ax HEW40_RU106_Index53_Nss1,(MCS0)_2TX	-	-	-	-	-	-	-	-
2422MHz	Pass	-6.00	9.76	10.01	12.90	-	6.90	-
2437MHz	Pass	-6.00	9.82	10.03	12.94	-	6.94	-
2452MHz	Pass	-6.00	9.76	9.99	12.89	-	6.89	-
802.11ax HEW40_RU106_Index54_Nss1,(MCS0)_2TX	-	-	-	-	-	-	-	-
2422MHz	Pass	-6.00	9.79	10.07	12.94	-	6.94	-
2437MHz	Pass	-6.00	9.81	10.09	12.96	-	6.96	-
2452MHz	Pass	-6.00	9.72	10.06	12.90	-	6.90	-
802.11ax HEW40_RU106_Index56_Nss1,(MCS0)_2TX	-	-	-	-	-	-	-	-
2422MHz	Pass	-6.00	9.74	10.03	12.90	-	6.90	-
2437MHz	Pass	-6.00	9.76	10.05	12.92	-	6.92	-
2452MHz	Pass	-6.00	9.71	9.93	12.83	-	6.83	-

Mode	Result	DG (dBi)	Port 1 (dBm)	Port 2 (dBm)	Total Power (dBm)	Power Limit (dBm)	EIRP (dBm)	EIRP Limit (dBm)
802.11ax HEW40_RU242_Index61_Nss1,(MCS0)_2TX	-	-	-	-	-	-	-	-
2422MHz	Pass	-6.00	9.62	9.87	12.76	-	6.76	-
2437MHz	Pass	-6.00	9.68	9.97	12.84	-	6.84	-
2452MHz	Pass	-6.00	9.7	9.96	12.84	-	6.84	-
802.11ax HEW40_RU242_Index62_Nss1,(MCS0)_2TX	-	-	-	-	-	-	-	-
2422MHz	Pass	-6.00	9.76	10.06	12.92	-	6.92	-
2437MHz	Pass	-6.00	9.91	10.09	13.01	-	7.01	-
2452MHz	Pass	-6.00	9.68	10.13	12.92	-	6.92	-
802.11ax HEW40_RU484_Index65_Nss1,(MCS0)_2TX	-	-	-	-	-	-	-	-
2422MHz	Pass	-6.00	9.75	10.08	12.93	-	6.93	-
2437MHz	Pass	-6.00	9.78	10.13	12.97	-	6.97	-
2452MHz	Pass	-6.00	9.74	9.98	12.87	-	6.87	-

DG = Directional Gain; **Port X** = Port X output power
Note : Conducted average output power is for reference only

3.4 Power Spectral Density

3.4.1 Limit of Power Spectral Density

Power spectral density shall not be greater than 8 dBm in any 3 kHz band.

3.4.2 Test Procedures

- 1 Set the RBW = 3 kHz, VBW = 10 kHz. Detector = RMS.
- 2 Set the sweep time to: ≥ 10 (number of measurement points in sweep) x (total on/off period of the transmitted signal).
- 3 Perform the measurement over a single sweep.
- 4 Use the peak marker function to determine the maximum amplitude level.
- 5 Add $10 \log (1/x)$, where x is the duty cycle.

3.4.3 Test Setup

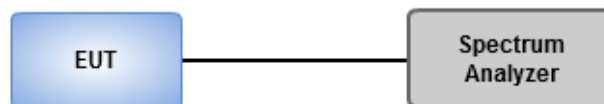

3.4.4 Test Result of Power Spectral Density

Summary

Mode	PD (dBm/RBW)
2.4-2.4835GHz	-
802.11b_Nss1,(1Mbps)_2TX	-5.36
802.11g_Nss1,(6Mbps)_2TX	-8.63
802.11n HT20_Nss1,(MCS0)_2TX	-8.57
802.11n HT40_Nss1,(MCS0)_2TX	-14.68
11AX20_Nss1,(MCS0)_2TX	-11.91
11AX40_Nss1,(MCS0)_2TX	-13.61

Result

Mode	Result	DG (dBi)	Port 1 (dBm/RBW)	Port 2 (dBm/RBW)	PD (dBm/RBW)	PD Limit (dBm/RBW)
802.11b_Nss1,(1Mbps)_2TX	-	-	-	-	-	-
2412MHz	Pass	-3.48	-9.34	-9.03	-6.81	8.00
2437MHz	Pass	-3.48	-7.88	-8.59	-5.91	8.00
2462MHz	Pass	-3.48	-7.76	-8.93	-5.36	8.00
802.11g_Nss1,(6Mbps)_2TX	-	-	-	-	-	-
2412MHz	Pass	-3.48	-11.54	-11.51	-8.75	8.00
2437MHz	Pass	-3.48	-10.63	-11.66	-8.63	8.00
2462MHz	Pass	-3.48	-12.22	-11.23	-9.03	8.00
802.11n HT20_Nss1,(MCS0)_2TX	-	-	-	-	-	-
2412MHz	Pass	-3.48	-11.15	-12.66	-9.72	8.00
2437MHz	Pass	-3.48	-10.46	-10.94	-8.57	8.00
2462MHz	Pass	-3.48	-12.78	-12.64	-10.28	8.00
802.11n HT40_Nss1,(MCS0)_2TX	-	-	-	-	-	-
2422MHz	Pass	-3.48	-17.16	-17.00	-14.82	8.00
2437MHz	Pass	-3.48	-17.74	-16.84	-14.71	8.00
2452MHz	Pass	-3.48	-17.25	-17.09	-14.68	8.00
11AX20_Nss1,(MCS0)_2TX	-	-	-	-	-	-
2412MHz	Pass	-3.48	-14.88	-14.61	-12.62	8.00
2437MHz	Pass	-3.48	-14.16	-14.05	-11.91	8.00
2462MHz	Pass	-3.48	-14.34	-14.43	-12.66	8.00
11AX40_Nss1,(MCS0)_2TX	-	-	-	-	-	-
2422MHz	Pass	-3.48	-16.84	-16.69	-14.74	8.00

Mode	Result	DG (dBi)	Port 1 (dBm/RBW)	Port 2 (dBm/RBW)	PD (dBm/RBW)	PD Limit (dBm/RBW)
2437MHz	Pass	-3.48	-17.25	-16.79	-14.47	8.00
2452MHz	Pass	-3.48	-16.46	-16.66	-13.61	8.00

DG = Directional Gain;

PD = trace bin-by-bin of each transmits port summing can be performed maximum power density; **Port X** = Port X power density;

802.11b_Nss1,(1Mbps)_2TX

PSD

2412MHz

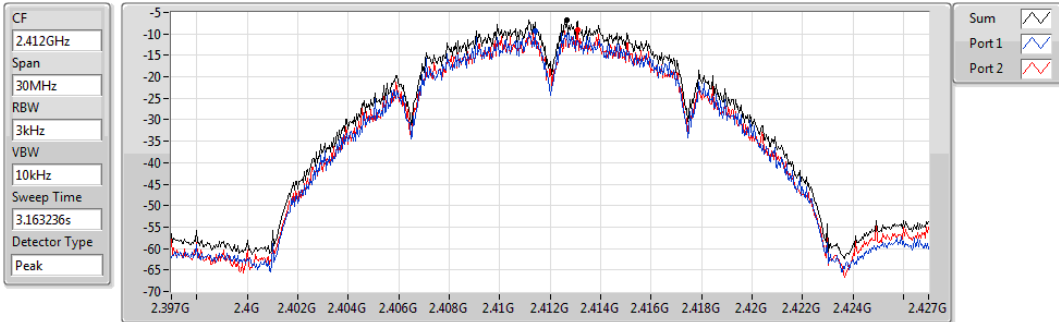

Sum	PD	Port 1	Port 2
(dBm/100kHz)	(dBm/100kHz)	(dBm/100kHz)	(dBm/100kHz)
-6.81	-6.81	-9.34	-9.03

802.11b_Nss1,(1Mbps)_2TX

PSD

2437MHz

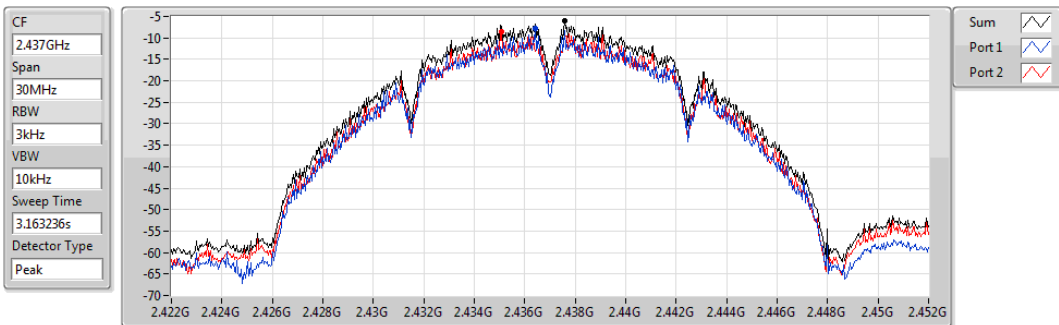

Sum	PD	Port 1	Port 2
(dBm/100kHz)	(dBm/100kHz)	(dBm/100kHz)	(dBm/100kHz)
-5.91	-5.91	-7.88	-8.59

802.11b_Nss1,(1Mbps)_2TX

PSD

2462MHz

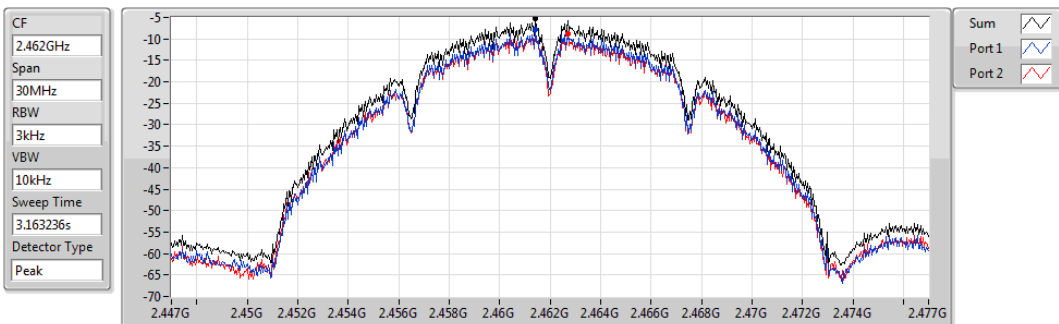

Sum	PD	Port 1	Port 2
(dBm/100kHz)	(dBm/100kHz)	(dBm/100kHz)	(dBm/100kHz)
-5.36	-5.36	-7.76	-8.93

802.11g_Nss1,(6Mbps)_2TX

PSD

2412MHz

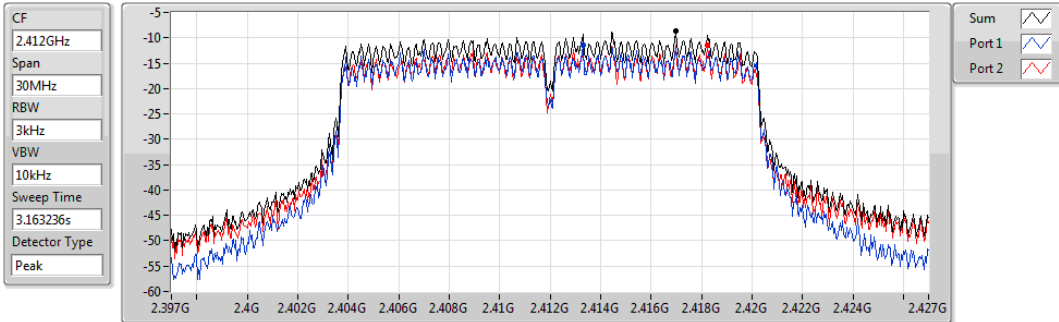

Sum	PD	Port 1	Port 2
(dBm/100kHz)	(dBm/100kHz)	(dBm/100kHz)	(dBm/100kHz)
-8.75	-8.75	-11.54	-11.51

802.11g_Nss1,(6Mbps)_2TX

PSD

2437MHz

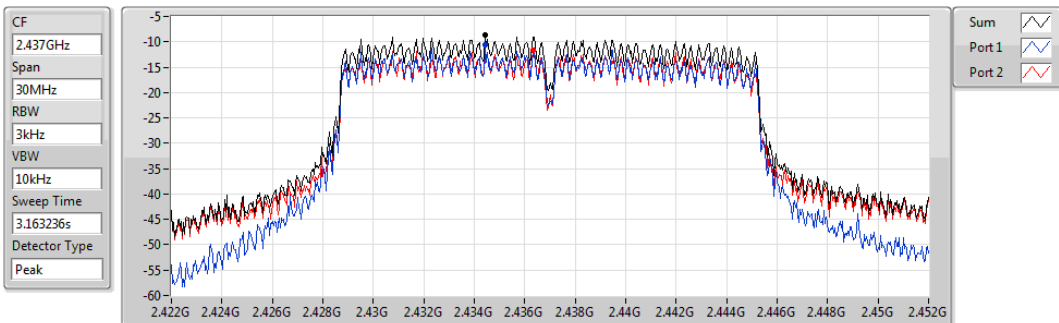

Sum	PD	Port 1	Port 2
(dBm/100kHz)	(dBm/100kHz)	(dBm/100kHz)	(dBm/100kHz)
-8.63	-8.63	-10.63	-11.66

802.11g_Nss1,(6Mbps)_2TX

PSD

2462MHz

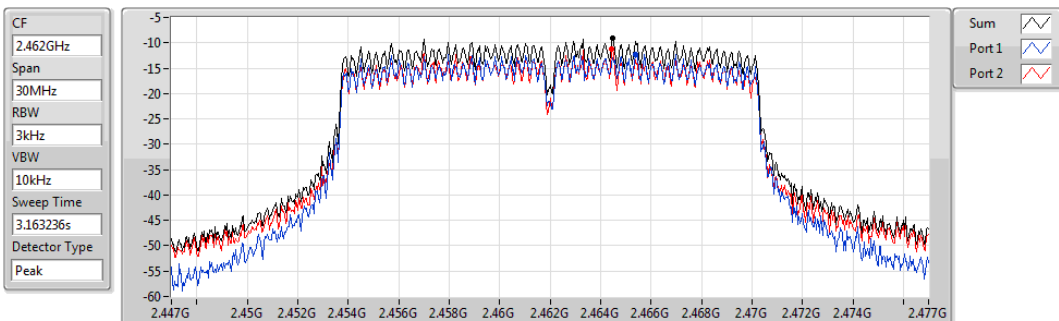

Sum	PD	Port 1	Port 2
(dBm/100kHz)	(dBm/100kHz)	(dBm/100kHz)	(dBm/100kHz)
-9.03	-9.03	-12.22	-11.23

802.11n HT20_Nss1,(MCS0)_2TX

PSD

2412MHz

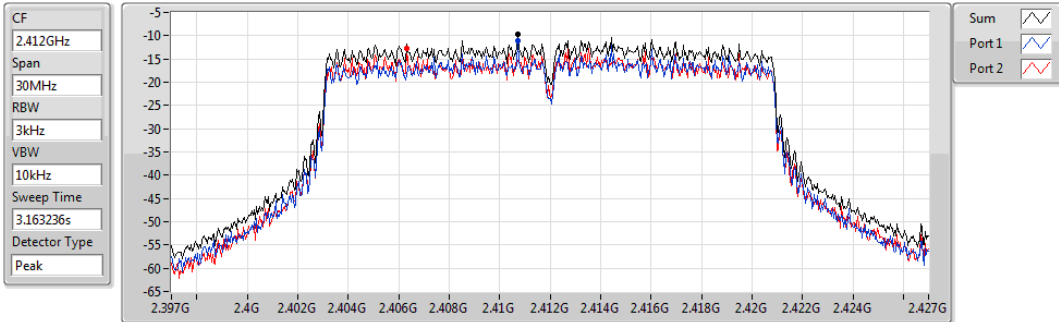

Sum	PD	Port 1	Port 2
(dBm/RBW)	(dBm/RBW)	(dBm/RBW)	(dBm/RBW)
-9.72	-9.72	-11.15	-12.66

802.11n HT20_Nss1,(MCS0)_2TX

PSD

2437MHz

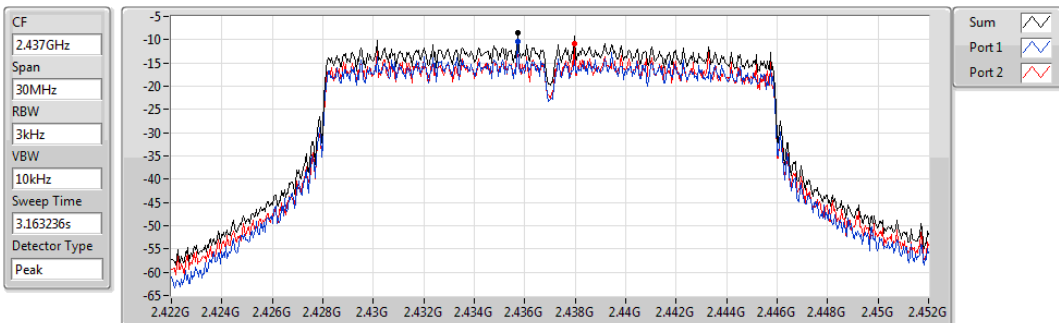

Sum	PD	Port 1	Port 2
(dBm/RBW)	(dBm/RBW)	(dBm/RBW)	(dBm/RBW)
-8.57	-8.57	-10.46	-10.94

802.11n HT20_Nss1,(MCS0)_2TX

PSD

2462MHz

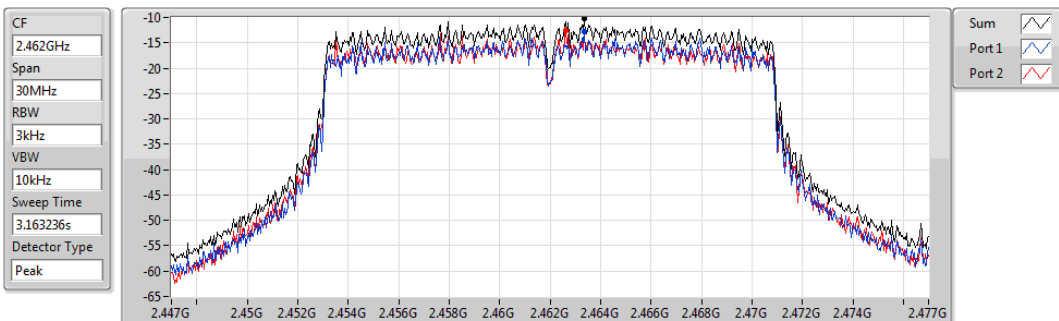

Sum	PD	Port 1	Port 2
(dBm/RBW)	(dBm/RBW)	(dBm/RBW)	(dBm/RBW)
-10.28	-10.28	-12.78	-12.64

802.11n HT40_Nss1,(MCS0)_2TX

PSD

2422MHz

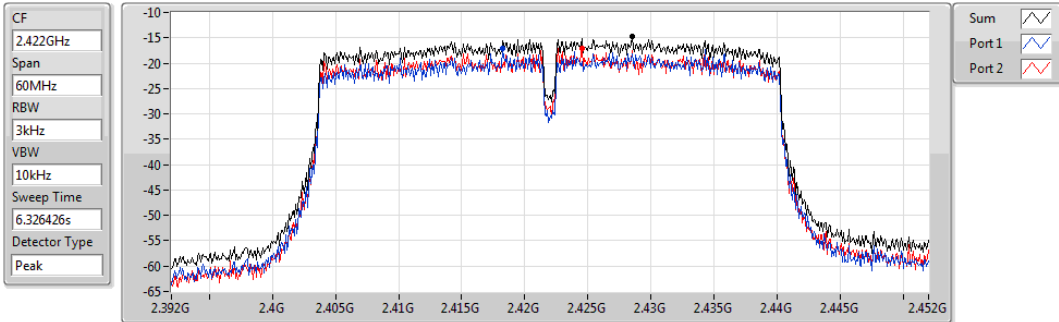

Sum	PD	Port 1	Port 2
(dBm/100kHz)	(dBm/100kHz)	(dBm/100kHz)	(dBm/100kHz)
-14.82	-14.82	-17.16	-17.00

802.11n HT40_Nss1,(MCS0)_2TX

PSD

2437MHz

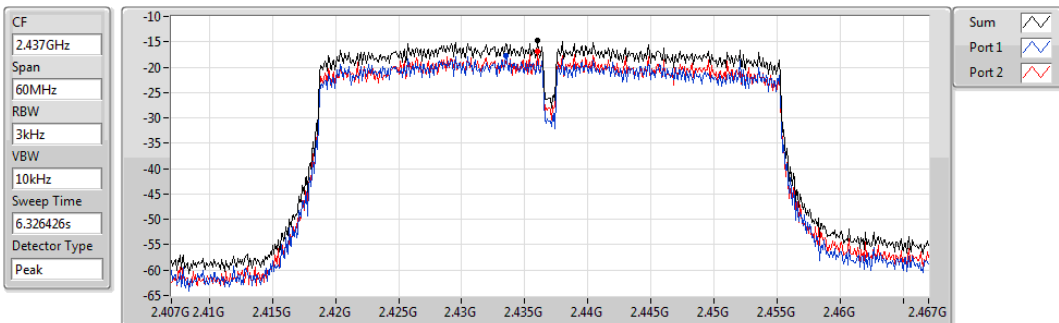

Sum	PD	Port 1	Port 2
(dBm/100kHz)	(dBm/100kHz)	(dBm/100kHz)	(dBm/100kHz)
-14.71	-14.71	-17.74	-16.84

802.11n HT40_Nss1,(MCS0)_2TX

PSD

2452MHz

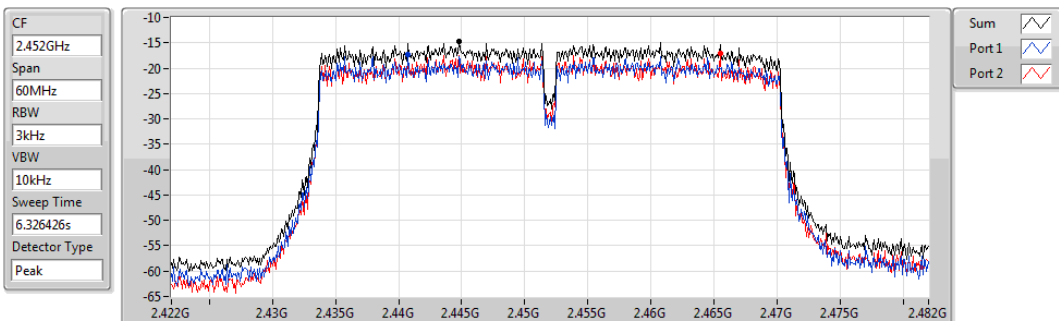

Sum	PD	Port 1	Port 2
(dBm/100kHz)	(dBm/100kHz)	(dBm/100kHz)	(dBm/100kHz)
-14.68	-14.68	-17.25	-17.09

11AX20_Nss1,(MCS0)_2TX

PSD

2412MHz

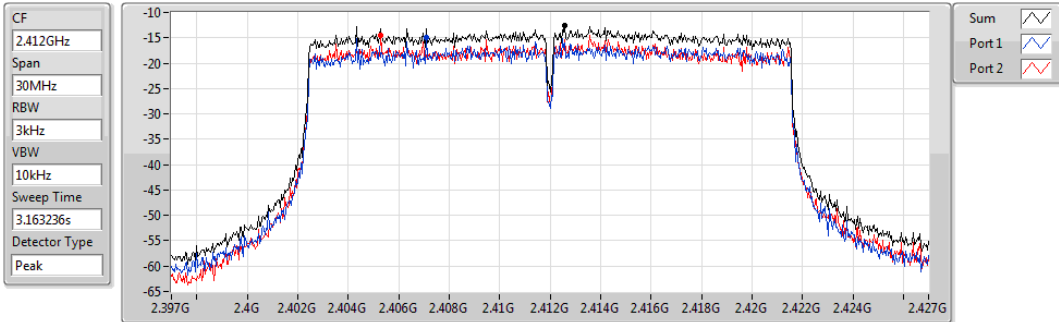

Sum	PD	Port 1	Port 2
(dBm/RBW)	(dBm/RBW)	(dBm/RBW)	(dBm/RBW)
-12.62	-12.62	-14.88	-14.61

11AX20_Nss1,(MCS0)_2TX

PSD

2437MHz

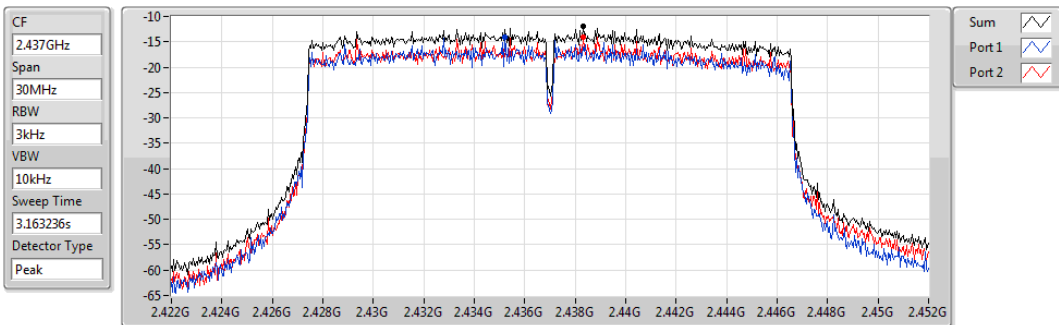

Sum	PD	Port 1	Port 2
(dBm/RBW)	(dBm/RBW)	(dBm/RBW)	(dBm/RBW)
-11.91	-11.91	-14.16	-14.05

11AX20_Nss1,(MCS0)_2TX

PSD

2462MHz

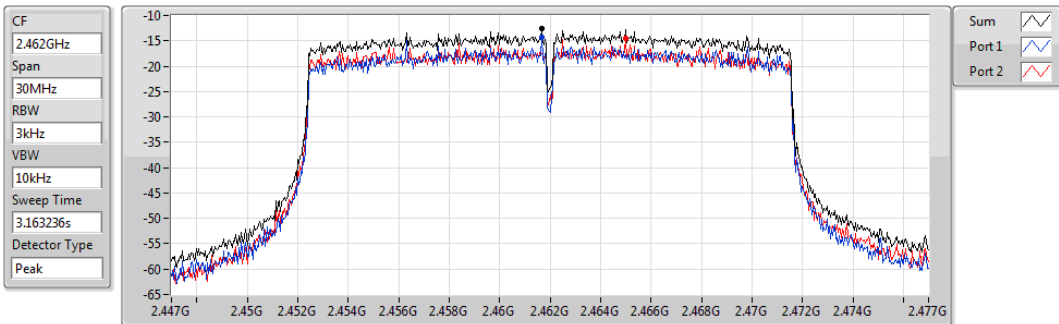

Sum	PD	Port 1	Port 2
(dBm/RBW)	(dBm/RBW)	(dBm/RBW)	(dBm/RBW)
-12.66	-12.66	-14.34	-14.43

11AX40_Nss1,(MCS0)_2TX

PSD

2422MHz

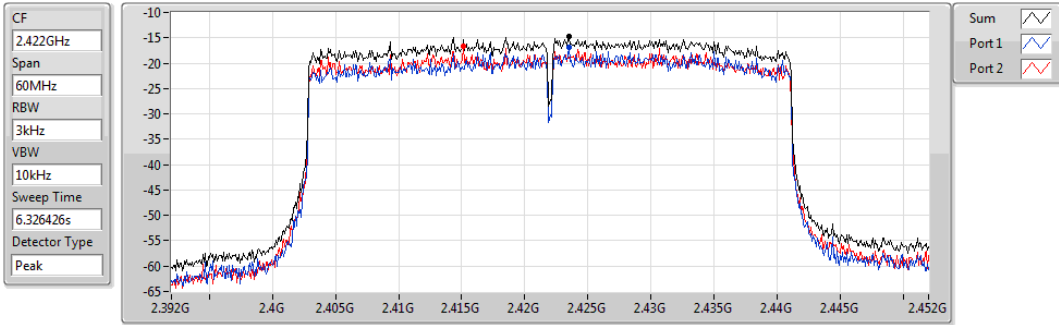

Sum	PD	Port 1	Port 2
(dBm/RBW)	(dBm/RBW)	(dBm/RBW)	(dBm/RBW)
-14.74	-14.74	-16.84	-16.69

11AX40_Nss1,(MCS0)_2TX

PSD

2437MHz

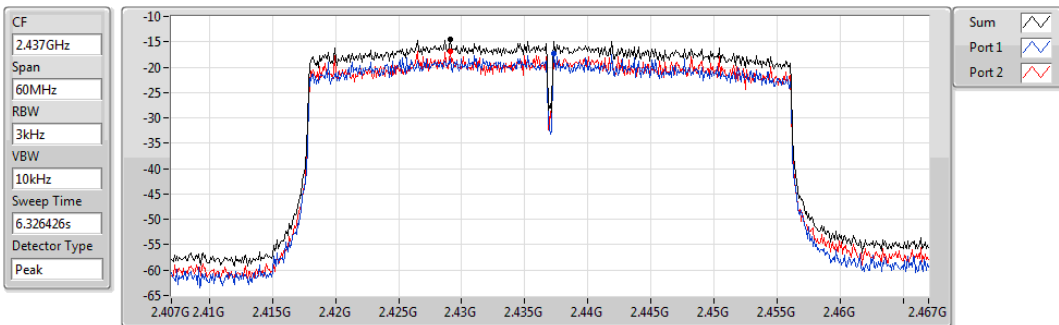

Sum	PD	Port 1	Port 2
(dBm/RBW)	(dBm/RBW)	(dBm/RBW)	(dBm/RBW)
-14.47	-14.47	-17.25	-16.79

11AX40_Nss1,(MCS0)_2TX

PSD

2452MHz

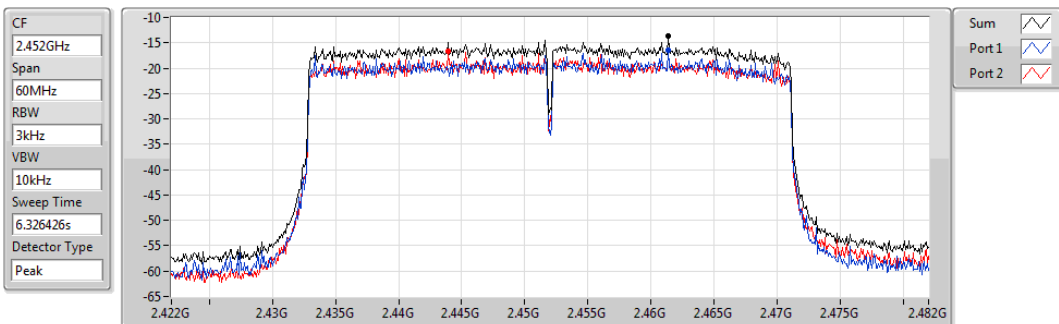

Sum	PD	Port 1	Port 2
(dBm/RBW)	(dBm/RBW)	(dBm/RBW)	(dBm/RBW)
-13.61	-13.61	-16.46	-16.66

Summary

Mode	PD (dBm/RBW)
2.4-2.4835GHz	-
802.11ax HEW20_RU26_Index0_Nss1,(MCS0)_2TX	-6.04
802.11ax HEW20_RU26_Index4_Nss1,(MCS0)_2TX	-5.91
802.11ax HEW20_RU26_Index8_Nss1,(MCS0)_2TX	-5.86
802.11ax HEW20_RU52_Index37_Nss1,(MCS0)_2TX	-7.59
802.11ax HEW20_RU52_Index38_Nss1,(MCS0)_2TX	-7.78
802.11ax HEW20_RU52_Index40_Nss1,(MCS0)_2TX	-7.55
802.11ax HEW20_RU106_Index53_Nss1,(MCS0)_2TX	-10.13
802.11ax HEW20_RU106_Index54_Nss1,(MCS0)_2TX	-10.01
802.11ax HEW20_RU242_Index61_Nss1,(MCS0)_2TX	-13.04
802.11ax HEW40_RU26_Index0_Nss1,(MCS0)_2TX	-5.02
802.11ax HEW40_RU26_Index9_Nss1,(MCS0)_2TX	-5.12
802.11ax HEW40_RU26_Index17_Nss1,(MCS0)_2TX	-4.82
802.11ax HEW40_RU52_Index37_Nss1,(MCS0)_2TX	-7.70
802.11ax HEW40_RU52_Index41_Nss1,(MCS0)_2TX	-7.61
802.11ax HEW40_RU52_Index44_Nss1,(MCS0)_2TX	-7.32
802.11ax HEW40_RU106_Index53_Nss1,(MCS0)_2TX	-9.06
802.11ax HEW40_RU106_Index54_Nss1,(MCS0)_2TX	-9.97
802.11ax HEW40_RU106_Index56_Nss1,(MCS0)_2TX	-9.34
802.11ax HEW40_RU242_Index61_Nss1,(MCS0)_2TX	-13.06
802.11ax HEW40_RU242_Index62_Nss1,(MCS0)_2TX	-13.45
802.11ax HEW40_RU484_Index65_Nss1,(MCS0)_2TX	-16.15

Result

Mode	Result	DG (dBi)	Port 1 (dBm/RBW)	Port 2 (dBm/RBW)	PD (dBm/RBW)	PD Limit (dBm/RBW)
802.11ax HEW20_RU26_Index0_Nss1,(MCS0)_2TX	-	-	-	-	-	-
2412MHz	Pass	-3.48	-8.50	-8.71	-6.04	8.00
2437MHz	Pass	-3.48	-8.91	-9.06	-6.27	8.00
2462MHz	Pass	-3.48	-8.96	-8.24	-6.10	8.00
802.11ax HEW20_RU26_Index4_Nss1,(MCS0)_2TX	-	-	-	-	-	-
2412MHz	Pass	-3.48	-7.98	-7.85	-5.93	8.00
2437MHz	Pass	-3.48	-9.10	-8.43	-6.13	8.00
2462MHz	Pass	-3.48	-9.25	-7.91	-5.91	8.00
802.11ax HEW20_RU26_Index8_Nss1,(MCS0)_2TX	-	-	-	-	-	-
2412MHz	Pass	-3.48	-8.94	-7.67	-5.95	8.00
2437MHz	Pass	-3.48	-9.48	-8.34	-5.86	8.00
2462MHz	Pass	-3.48	-8.97	-8.51	-6.21	8.00
802.11ax HEW20_RU52_Index37_Nss1,(MCS0)_2TX	-	-	-	-	-	-
2412MHz	Pass	-3.48	-11.46	-9.23	-7.73	8.00
2437MHz	Pass	-3.48	-10.99	-9.82	-8.06	8.00
2462MHz	Pass	-3.48	-9.85	-10.18	-7.59	8.00
802.11ax HEW20_RU52_Index38_Nss1,(MCS0)_2TX	-	-	-	-	-	-
2412MHz	Pass	-3.48	-11.59	-9.32	-7.88	8.00
2437MHz	Pass	-3.48	-9.78	-10.32	-7.98	8.00
2462MHz	Pass	-3.48	-10.82	-9.23	-7.78	8.00
802.11ax HEW20_RU52_Index40_Nss1,(MCS0)_2TX	-	-	-	-	-	-
2412MHz	Pass	-3.48	-10.33	-10.13	-7.55	8.00
2437MHz	Pass	-3.48	-10.44	-9.81	-8.05	8.00
2462MHz	Pass	-3.48	-11.21	-10.12	-8.03	8.00
802.11ax HEW20_RU106_Index53_Nss1,(MCS0)_2TX	-	-	-	-	-	-
2412MHz	Pass	-3.48	-12.41	-13.46	-10.41	8.00
2437MHz	Pass	-3.48	-11.98	-13.09	-10.13	8.00
2462MHz	Pass	-3.48	-13.79	-12.28	-10.67	8.00
802.11ax HEW20_RU106_Index54_Nss1,(MCS0)_2TX	-	-	-	-	-	-
2412MHz	Pass	-3.48	-13.28	-12.09	-10.15	8.00
2437MHz	Pass	-3.48	-12.59	-12.97	-10.01	8.00
2462MHz	Pass	-3.48	-12.74	-13.15	-10.46	8.00

Mode	Result	DG (dBi)	Port 1 (dBm/RBW)	Port 2 (dBm/RBW)	PD (dBm/RBW)	PD Limit (dBm/RBW)
802.11ax HEW20_RU242_Index61_Nss1,(MCS0)_2TX	-	-	-	-	-	-
2412MHz	Pass	-3.48	-16.12	-16.09	-14.19	8.00
2437MHz	Pass	-3.48	-15.70	-15.08	-13.04	8.00
2462MHz	Pass	-3.48	-16.40	-17.21	-14.24	8.00
802.11ax HEW40_RU26_Index0_Nss1,(MCS0)_2TX	-	-	-	-	-	-
2422MHz	Pass	-3.48	-8.94	-8.59	-5.88	8.00
2437MHz	Pass	-3.48	-7.69	-7.79	-5.02	8.00
2452MHz	Pass	-3.48	-8.17	-8.62	-5.77	8.00
802.11ax HEW40_RU26_Index9_Nss1,(MCS0)_2TX	-	-	-	-	-	-
2422MHz	Pass	-3.48	-7.74	-7.83	-5.12	8.00
2437MHz	Pass	-3.48	-8.56	-8.16	-5.77	8.00
2452MHz	Pass	-3.48	-9.32	-7.24	-5.39	8.00
802.11ax HEW40_RU26_Index17_Nss1,(MCS0)_2TX	-	-	-	-	-	-
2422MHz	Pass	-3.48	-7.70	-7.97	-4.82	8.00
2437MHz	Pass	-3.48	-9.01	-7.92	-5.46	8.00
2452MHz	Pass	-3.48	-9.27	-8.94	-6.09	8.00
802.11ax HEW40_RU52_Index37_Nss1,(MCS0)_2TX	-	-	-	-	-	-
2422MHz	Pass	-3.48	-10.69	-11.01	-8.23	8.00
2437MHz	Pass	-3.48	-10.98	-9.17	-7.70	8.00
2452MHz	Pass	-3.48	-9.83	-10.46	-7.79	8.00
802.11ax HEW40_RU52_Index41_Nss1,(MCS0)_2TX	-	-	-	-	-	-
2422MHz	Pass	-3.48	-10.53	-10.26	-7.61	8.00
2437MHz	Pass	-3.48	-10.78	-10.42	-8.16	8.00
2452MHz	Pass	-3.48	-9.11	-9.97	-7.81	8.00
802.11ax HEW40_RU52_Index44_Nss1,(MCS0)_2TX	-	-	-	-	-	-
2422MHz	Pass	-3.48	-10.47	-10.52	-7.48	8.00
2437MHz	Pass	-3.48	-10.31	-10.76	-8.17	8.00
2452MHz	Pass	-3.48	-10.40	-10.06	-7.32	8.00
802.11ax HEW40_RU106_Index53_Nss1,(MCS0)_2TX	-	-	-	-	-	-
2422MHz	Pass	-3.48	-13.08	-12.45	-10.24	8.00
2437MHz	Pass	-3.48	-11.98	-12.61	-10.06	8.00
2452MHz	Pass	-3.48	-11.79	-11.70	-9.06	8.00
802.11ax HEW40_RU106_Index54_Nss1,(MCS0)_2TX	-	-	-	-	-	-

Mode	Result	DG (dBi)	Port 1 (dBm/RBW)	Port 2 (dBm/RBW)	PD (dBm/RBW)	PD Limit (dBm/RBW)
2422MHz	Pass	-3.48	-13.39	-11.48	-9.97	8.00
2437MHz	Pass	-3.48	-14.06	-11.52	-10.15	8.00
2452MHz	Pass	-3.48	-12.39	-12.06	-10.52	8.00
802.11ax HEW40_RU106_Index56_Nss1,(MCS0)_2TX	-	-	-	-	-	-
2422MHz	Pass	-3.48	-12.36	-13.57	-10.48	8.00
2437MHz	Pass	-3.48	-13.50	-12.96	-10.21	8.00
2452MHz	Pass	-3.48	-12.36	-12.23	-9.34	8.00
802.11ax HEW40_RU242_Index61_Nss1,(MCS0)_2TX	-	-	-	-	-	-
2422MHz	Pass	-3.48	-16.53	-15.66	-13.06	8.00
2437MHz	Pass	-3.48	-16.19	-15.20	-13.15	8.00
2452MHz	Pass	-3.48	-14.77	-15.99	-13.25	8.00
802.11ax HEW40_RU242_Index62_Nss1,(MCS0)_2TX	-	-	-	-	-	-
2422MHz	Pass	-3.48	-15.66	-15.56	-13.58	8.00
2437MHz	Pass	-3.48	-16.93	-16.30	-14.59	8.00
2452MHz	Pass	-3.48	-15.99	-15.54	-13.45	8.00
802.11ax HEW40_RU484_Index65_Nss1,(MCS0)_2TX	-	-	-	-	-	-
2422MHz	Pass	-3.48	-19.07	-19.32	-17.16	8.00
2437MHz	Pass	-3.48	-20.14	-19.13	-17.56	8.00
2452MHz	Pass	-3.48	-18.12	-19.30	-16.15	8.00

DG = Directional Gain;

PD = trace bin-by-bin of each transmits port summing can be performed maximum power density; **Port X** = Port X power density;

802.11ax HEW20_RU26_Index0_Nss1,(MCS0)_2TX

PSD

2412MHz

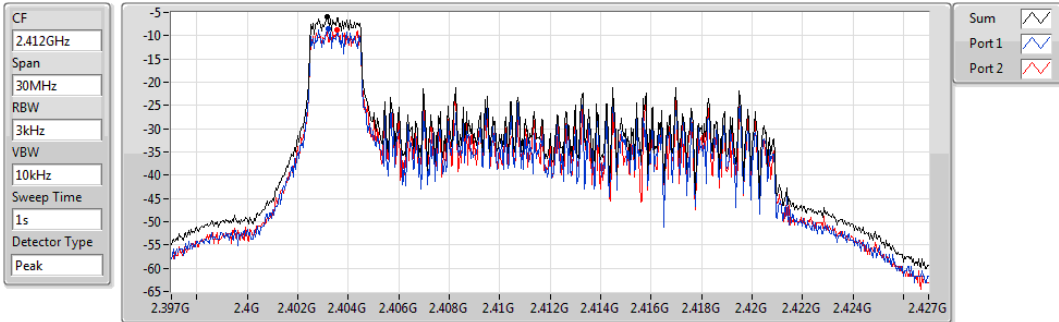

Sum	PD	Port 1	Port 2
(dBm/RBW)	(dBm/RBW)	(dBm/RBW)	(dBm/RBW)
-6.04	-6.04	-8.50	-8.71

802.11ax HEW20_RU26_Index0_Nss1,(MCS0)_2TX

PSD

2437MHz

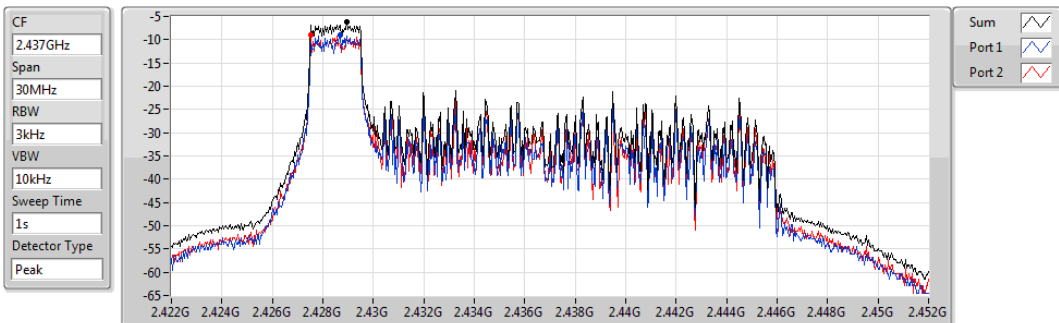

Sum	PD	Port 1	Port 2
(dBm/RBW)	(dBm/RBW)	(dBm/RBW)	(dBm/RBW)
-6.27	-6.27	-8.91	-9.06

802.11ax HEW20_RU26_Index0_Nss1,(MCS0)_2TX

PSD

2462MHz

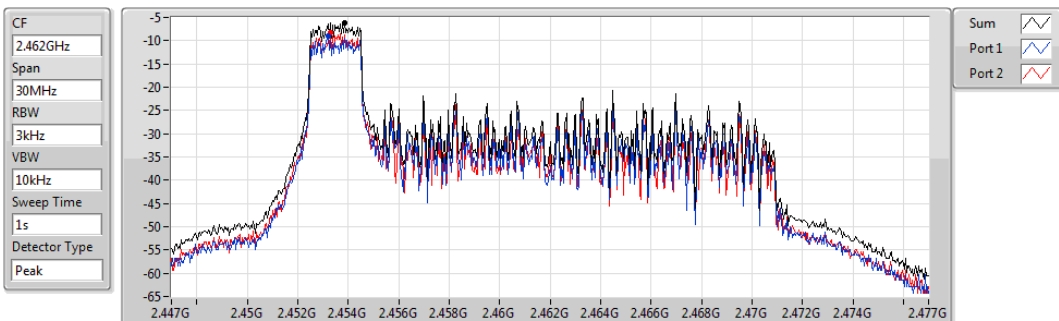

Sum	PD	Port 1	Port 2
(dBm/RBW)	(dBm/RBW)	(dBm/RBW)	(dBm/RBW)
-6.10	-6.10	-8.96	-8.24

802.11ax HEW20_RU26_Index4_Nss1,(MCS0)_2TX

PSD

2412MHz

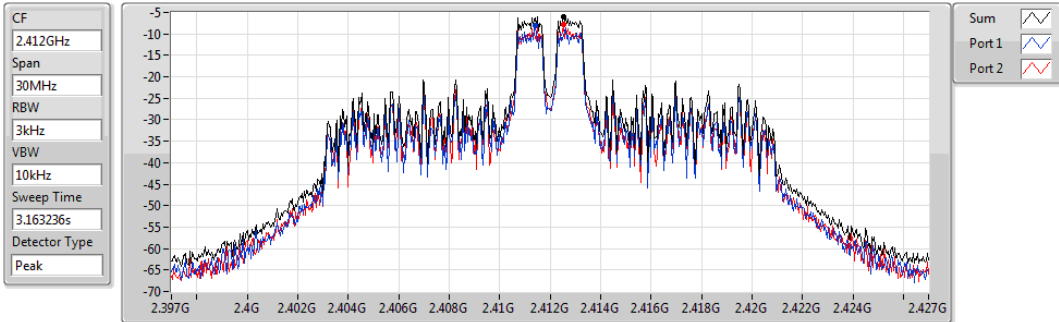

Sum	PD	Port 1	Port 2
(dBm/RBW)	(dBm/RBW)	(dBm/RBW)	(dBm/RBW)
-5.93	-5.93	-7.98	-7.85

802.11ax HEW20_RU26_Index4_Nss1,(MCS0)_2TX

PSD

2437MHz

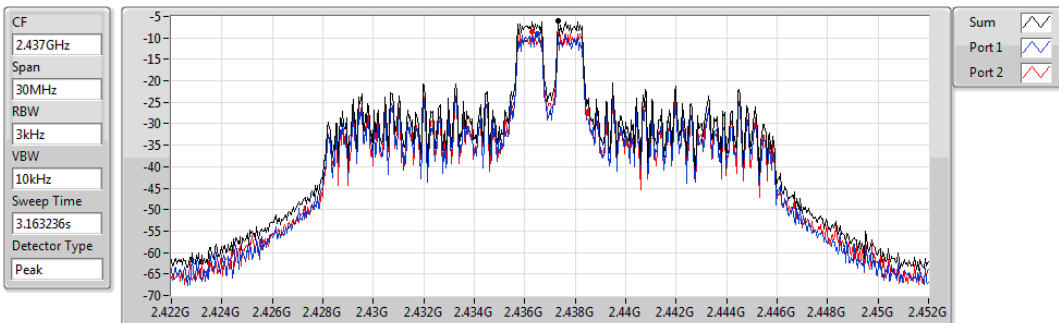

Sum	PD	Port 1	Port 2
(dBm/RBW)	(dBm/RBW)	(dBm/RBW)	(dBm/RBW)
-6.13	-6.13	-9.10	-8.43

802.11ax HEW20_RU26_Index4_Nss1,(MCS0)_2TX

PSD

2462MHz

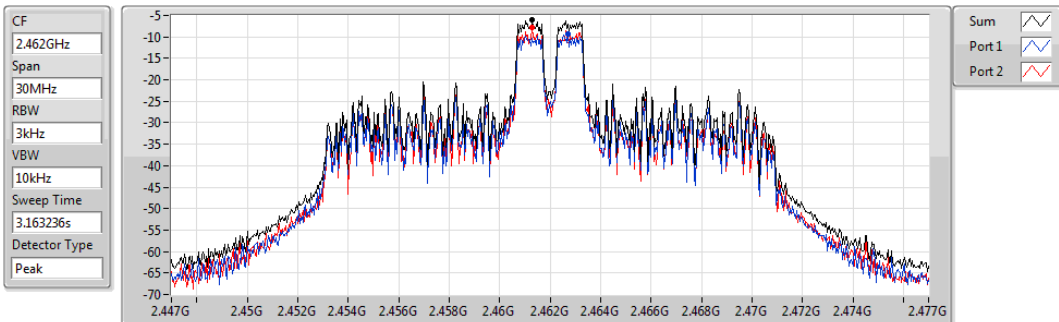

Sum	PD	Port 1	Port 2
(dBm/RBW)	(dBm/RBW)	(dBm/RBW)	(dBm/RBW)
-5.91	-5.91	-9.25	-7.91

802.11ax HEW20_RU26_Index8_Nss1,(MCS0)_2TX

PSD

2412MHz

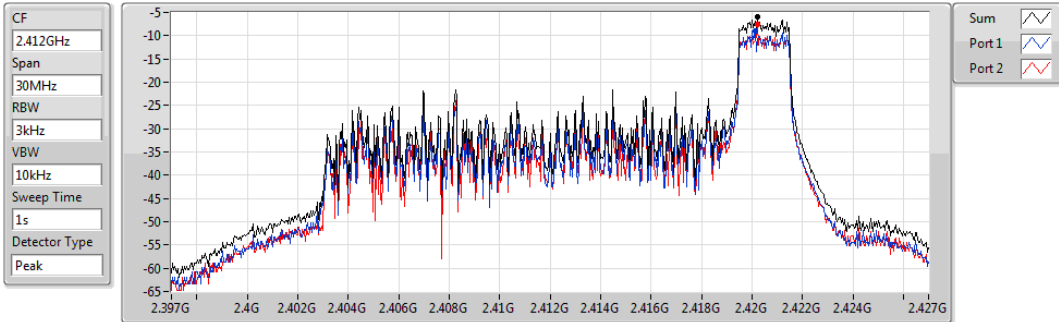

Sum	PD	Port 1	Port 2
(dBm/RBW)	(dBm/RBW)	(dBm/RBW)	(dBm/RBW)
-5.95	-5.95	-8.94	-7.67

802.11ax HEW20_RU26_Index8_Nss1,(MCS0)_2TX

PSD

2437MHz

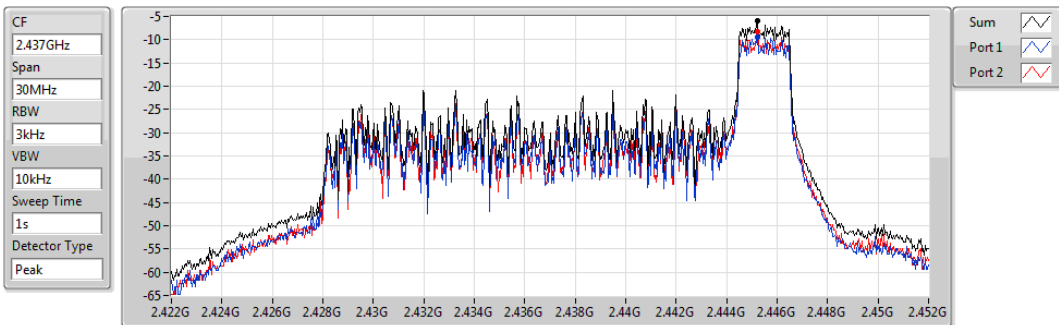

Sum	PD	Port 1	Port 2
(dBm/RBW)	(dBm/RBW)	(dBm/RBW)	(dBm/RBW)
-5.86	-5.86	-9.48	-8.34

802.11ax HEW20_RU26_Index8_Nss1,(MCS0)_2TX

PSD

2462MHz

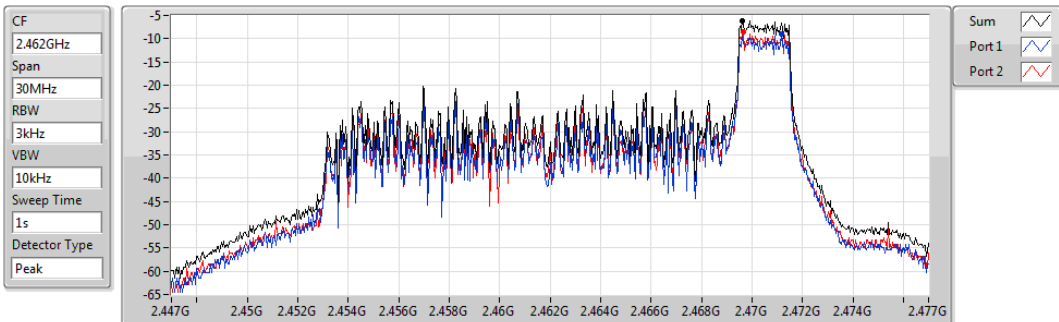

Sum	PD	Port 1	Port 2
(dBm/RBW)	(dBm/RBW)	(dBm/RBW)	(dBm/RBW)
-6.21	-6.21	-8.97	-8.51

802.11ax HEW20_RU52_Index37_Nss1,(MCS0)_2TX

PSD

2412MHz

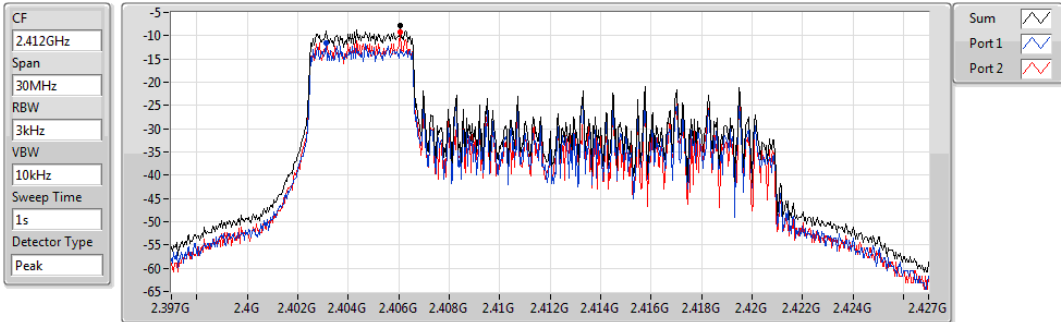

Sum	PD	Port 1	Port 2
(dBm/RBW)	(dBm/RBW)	(dBm/RBW)	(dBm/RBW)
-7.73	-7.73	-11.46	-9.23

802.11ax HEW20_RU52_Index37_Nss1,(MCS0)_2TX

PSD

2437MHz

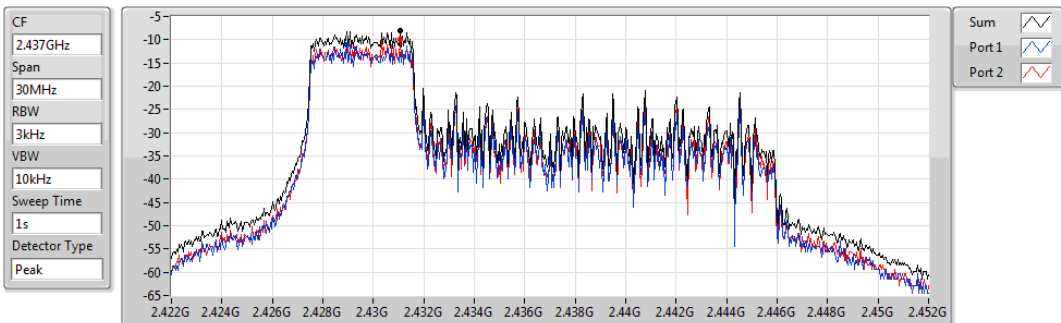

Sum	PD	Port 1	Port 2
(dBm/RBW)	(dBm/RBW)	(dBm/RBW)	(dBm/RBW)
-8.06	-8.06	-10.99	-9.82

802.11ax HEW20_RU52_Index37_Nss1,(MCS0)_2TX

PSD

2462MHz

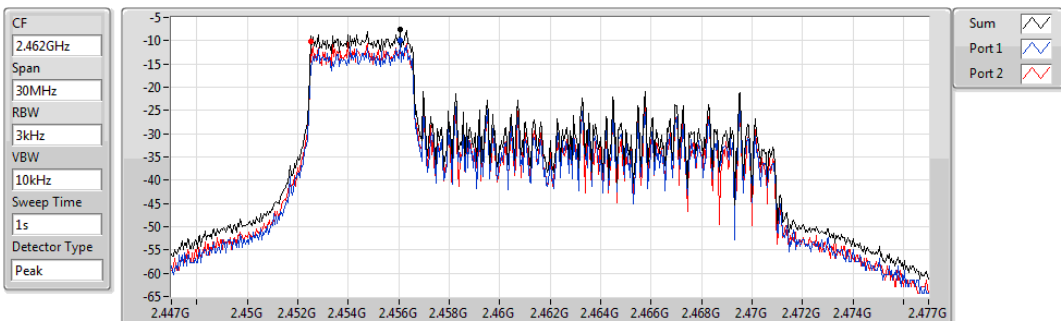

Sum	PD	Port 1	Port 2
(dBm/RBW)	(dBm/RBW)	(dBm/RBW)	(dBm/RBW)
-7.59	-7.59	-9.85	-10.18

802.11ax HEW20_RU52_Index38_Nss1,(MCS0)_2TX

PSD

2412MHz

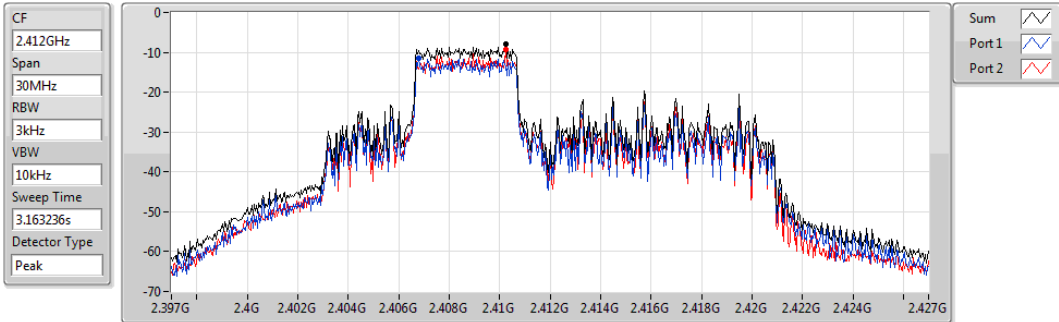

Sum	PD	Port 1	Port 2
(dBm/RBW)	(dBm/RBW)	(dBm/RBW)	(dBm/RBW)
-7.88	-7.88	-11.59	-9.32

802.11ax HEW20_RU52_Index38_Nss1,(MCS0)_2TX

PSD

2437MHz

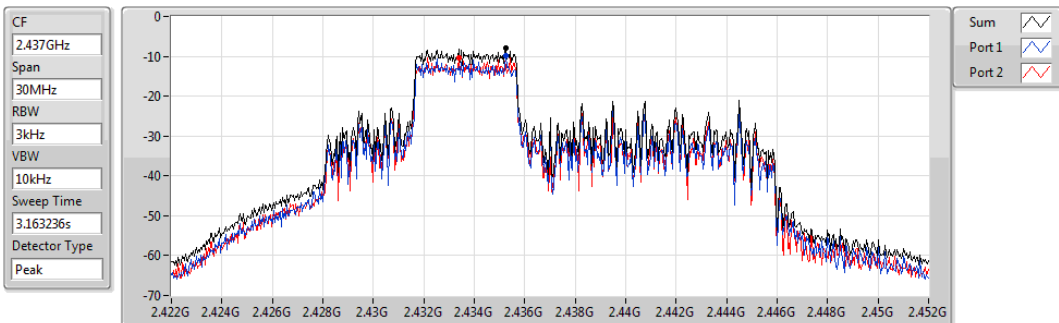

Sum	PD	Port 1	Port 2
(dBm/RBW)	(dBm/RBW)	(dBm/RBW)	(dBm/RBW)
-7.98	-7.98	-9.78	-10.32

802.11ax HEW20_RU52_Index38_Nss1,(MCS0)_2TX

PSD

2462MHz

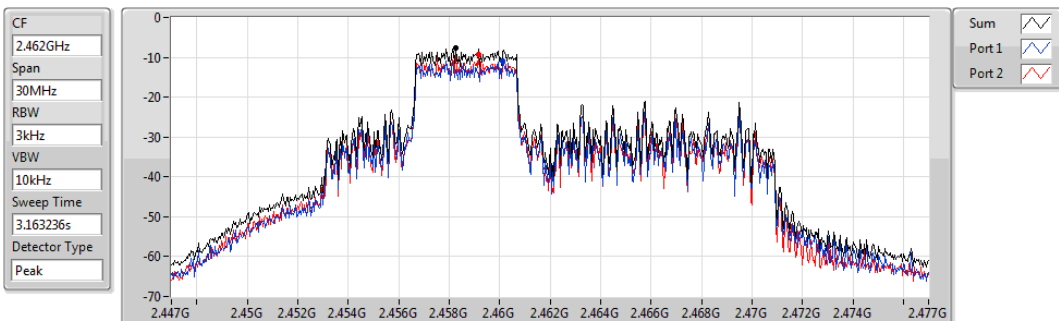

Sum	PD	Port 1	Port 2
(dBm/RBW)	(dBm/RBW)	(dBm/RBW)	(dBm/RBW)
-7.78	-7.78	-10.82	-9.23

802.11ax HEW20_RU52_Index40_Nss1,(MCS0)_2TX

PSD

2412MHz

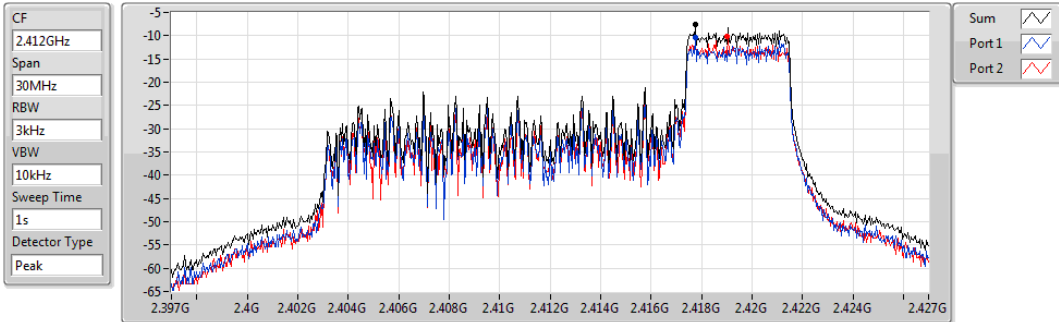

Sum	PD	Port 1	Port 2
(dBm/RBW)	(dBm/RBW)	(dBm/RBW)	(dBm/RBW)
-7.55	-7.55	-10.33	-10.13

802.11ax HEW20_RU52_Index40_Nss1,(MCS0)_2TX

PSD

2437MHz

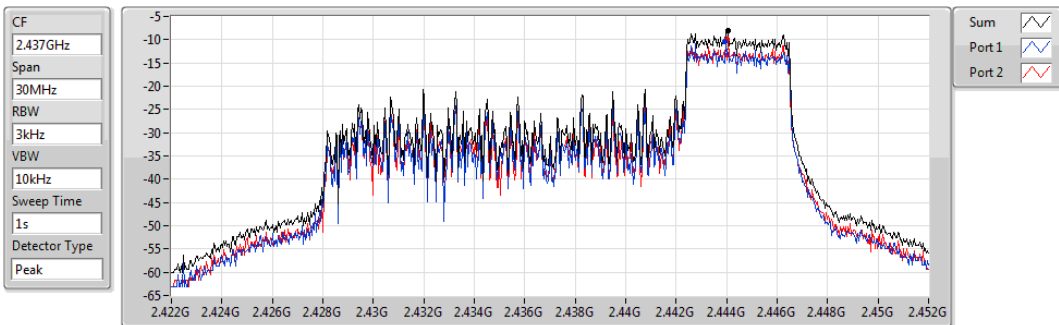

Sum	PD	Port 1	Port 2
(dBm/RBW)	(dBm/RBW)	(dBm/RBW)	(dBm/RBW)
-8.05	-8.05	-10.44	-9.81

802.11ax HEW20_RU52_Index40_Nss1,(MCS0)_2TX

PSD

2462MHz

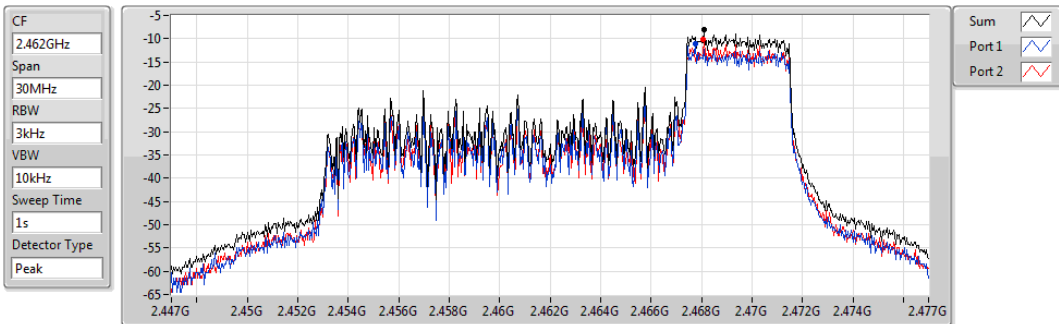

Sum	PD	Port 1	Port 2
(dBm/RBW)	(dBm/RBW)	(dBm/RBW)	(dBm/RBW)
-8.03	-8.03	-11.21	-10.12

802.11ax HEW20_RU106_Index53_Nss1,(MCS0)_2TX

PSD

2412MHz

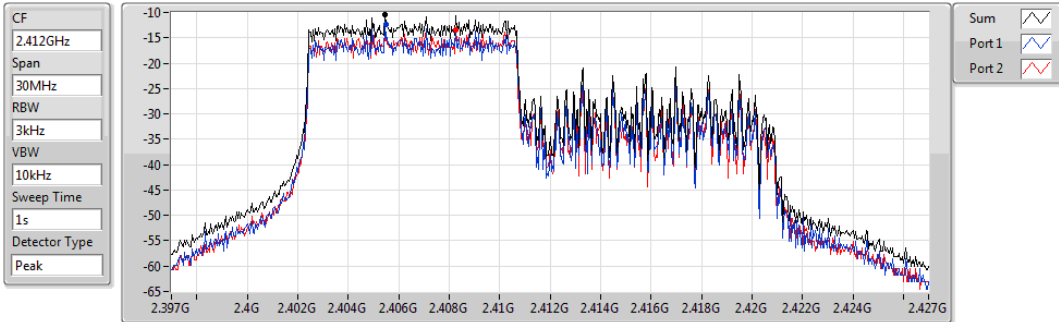

Sum	PD	Port 1	Port 2
(dBm/RBW)	(dBm/RBW)	(dBm/RBW)	(dBm/RBW)
-10.41	-10.41	-12.41	-13.46

802.11ax HEW20_RU106_Index53_Nss1,(MCS0)_2TX

PSD

2437MHz

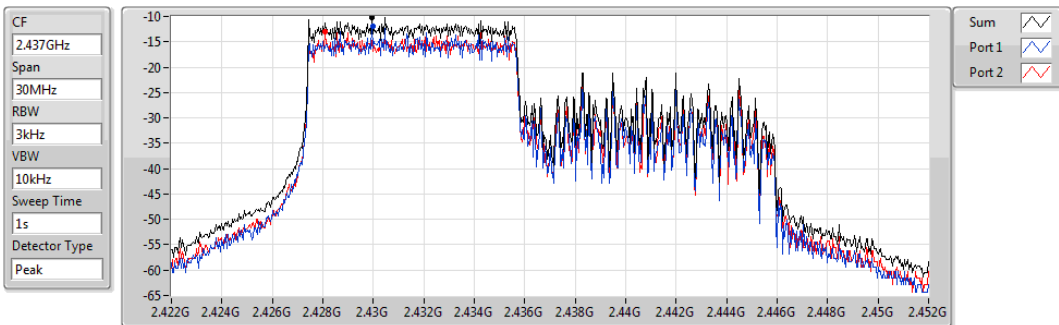

Sum	PD	Port 1	Port 2
(dBm/RBW)	(dBm/RBW)	(dBm/RBW)	(dBm/RBW)
-10.13	-10.13	-11.98	-13.09

802.11ax HEW20_RU106_Index53_Nss1,(MCS0)_2TX

PSD

2462MHz

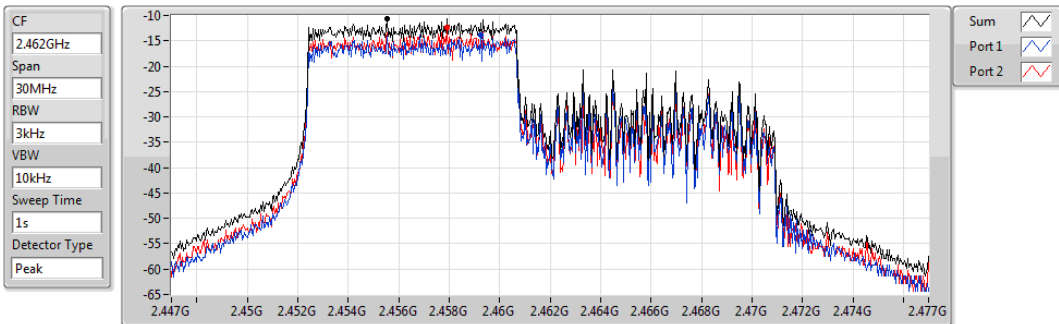

Sum	PD	Port 1	Port 2
(dBm/RBW)	(dBm/RBW)	(dBm/RBW)	(dBm/RBW)
-10.67	-10.67	-13.79	-12.28

802.11ax HEW20_RU106_Index54_Nss1,(MCS0)_2TX

PSD

2412MHz

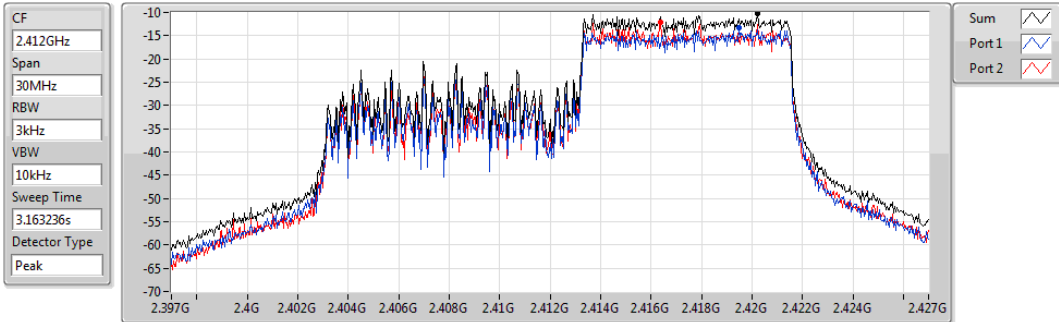

Sum	PD	Port 1	Port 2
(dBm/RBW)	(dBm/RBW)	(dBm/RBW)	(dBm/RBW)
-10.15	-10.15	-13.28	-12.09

802.11ax HEW20_RU106_Index54_Nss1,(MCS0)_2TX

PSD

2437MHz

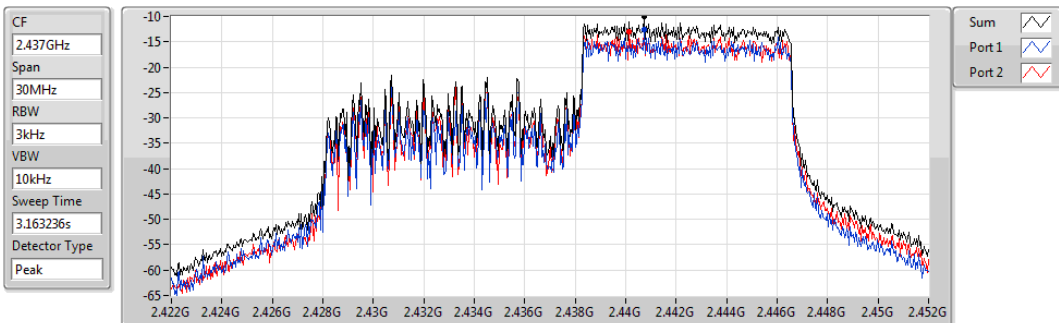

Sum	PD	Port 1	Port 2
(dBm/RBW)	(dBm/RBW)	(dBm/RBW)	(dBm/RBW)
-10.01	-10.01	-12.59	-12.97

802.11ax HEW20_RU106_Index54_Nss1,(MCS0)_2TX

PSD

2462MHz

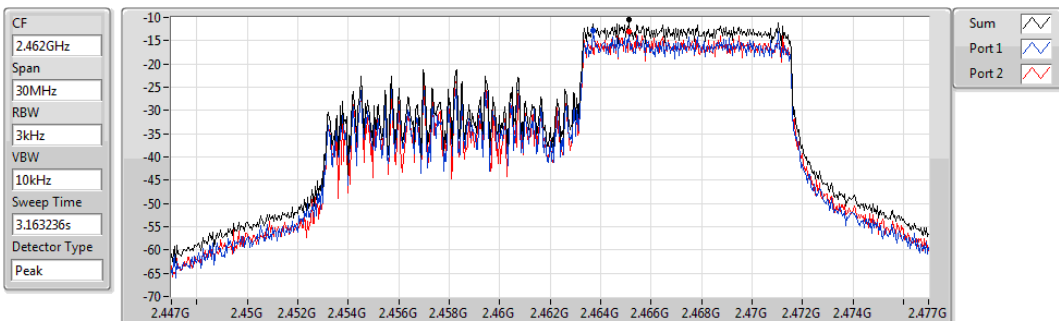

Sum	PD	Port 1	Port 2
(dBm/RBW)	(dBm/RBW)	(dBm/RBW)	(dBm/RBW)
-10.46	-10.46	-12.74	-13.15

802.11ax HEW20_RU242_Index61_Nss1,(MCS0)_2TX

PSD

2412MHz

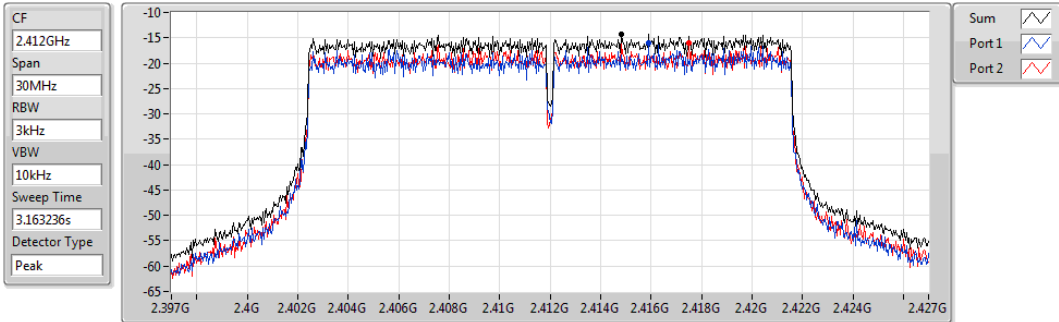

Sum	PD	Port 1	Port 2
(dBm/RBW)	(dBm/RBW)	(dBm/RBW)	(dBm/RBW)
-14.19	-14.19	-16.12	-16.09

802.11ax HEW20_RU242_Index61_Nss1,(MCS0)_2TX

PSD

2437MHz

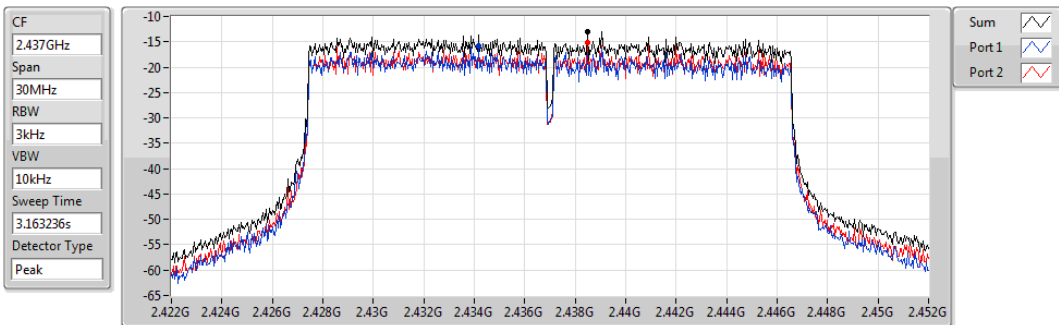

Sum	PD	Port 1	Port 2
(dBm/RBW)	(dBm/RBW)	(dBm/RBW)	(dBm/RBW)
-13.04	-13.04	-15.70	-15.08

802.11ax HEW20_RU242_Index61_Nss1,(MCS0)_2TX

PSD

2462MHz

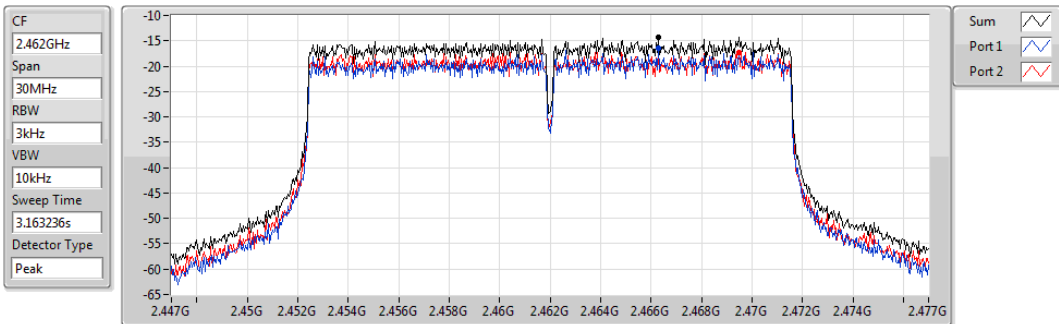

Sum	PD	Port 1	Port 2
(dBm/RBW)	(dBm/RBW)	(dBm/RBW)	(dBm/RBW)
-14.24	-14.24	-16.40	-17.21

802.11ax HEW40_RU26_Index0_Nss1,(MCS0)_2TX

PSD

2422MHz

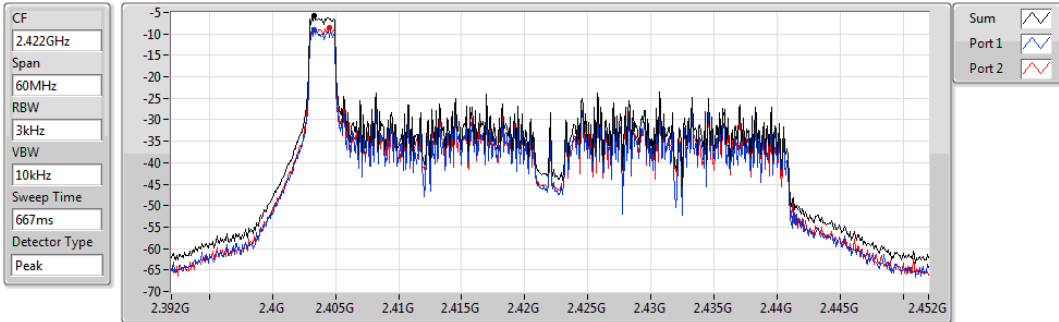

Sum	PD	Port 1	Port 2
(dBm/RBW)	(dBm/RBW)	(dBm/RBW)	(dBm/RBW)
-5.88	-5.88	-8.94	-8.59

802.11ax HEW40_RU26_Index0_Nss1,(MCS0)_2TX

PSD

2437MHz

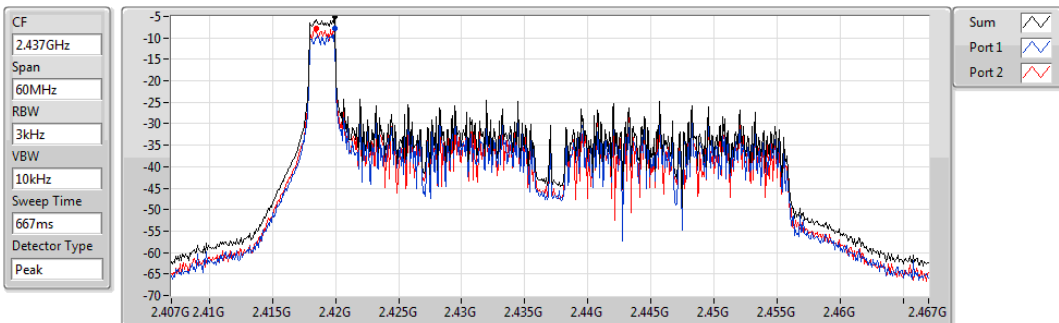

Sum	PD	Port 1	Port 2
(dBm/RBW)	(dBm/RBW)	(dBm/RBW)	(dBm/RBW)
-5.02	-5.02	-7.69	-7.79

802.11ax HEW40_RU26_Index0_Nss1,(MCS0)_2TX

PSD

2452MHz

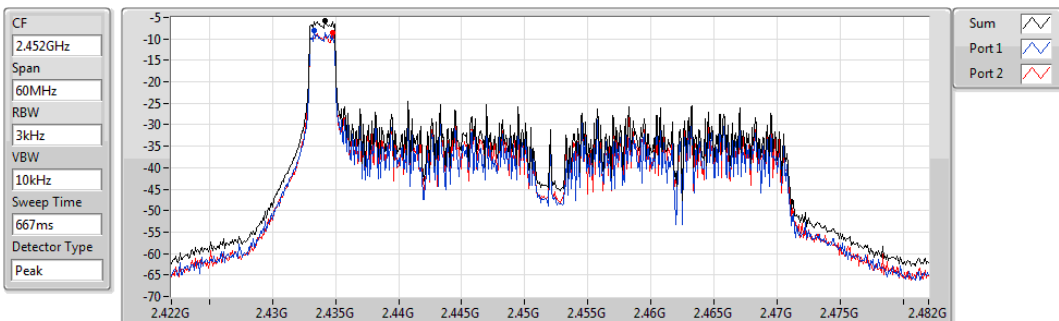

Sum	PD	Port 1	Port 2
(dBm/RBW)	(dBm/RBW)	(dBm/RBW)	(dBm/RBW)
-5.77	-5.77	-8.17	-8.62

802.11ax HEW40_RU26_Index9_Nss1,(MCS0)_2TX

PSD

2422MHz

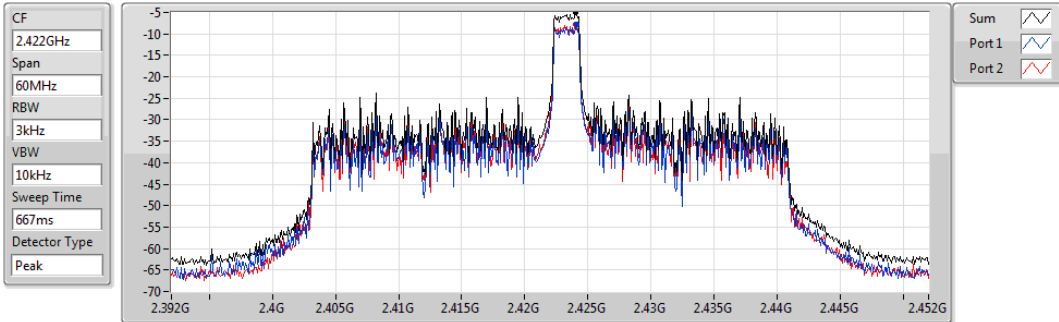

Sum	PD	Port 1	Port 2
(dBm/RBW)	(dBm/RBW)	(dBm/RBW)	(dBm/RBW)
-5.12	-5.12	-7.74	-7.83

802.11ax HEW40_RU26_Index9_Nss1,(MCS0)_2TX

PSD

2437MHz

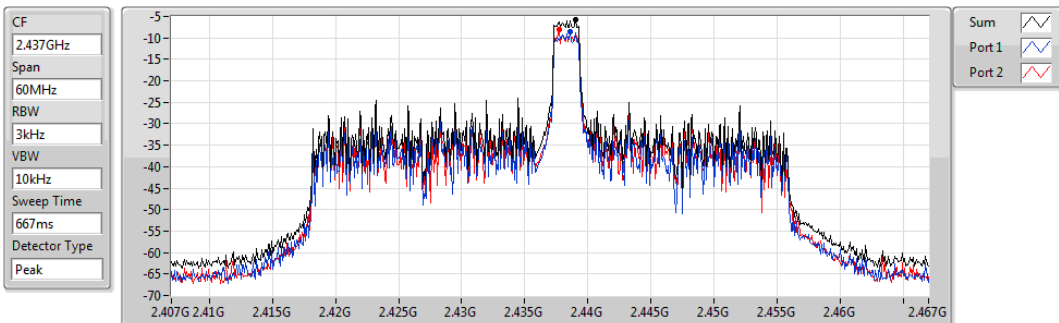

Sum	PD	Port 1	Port 2
(dBm/RBW)	(dBm/RBW)	(dBm/RBW)	(dBm/RBW)
-5.77	-5.77	-8.56	-8.16

802.11ax HEW40_RU26_Index9_Nss1,(MCS0)_2TX

PSD

2452MHz

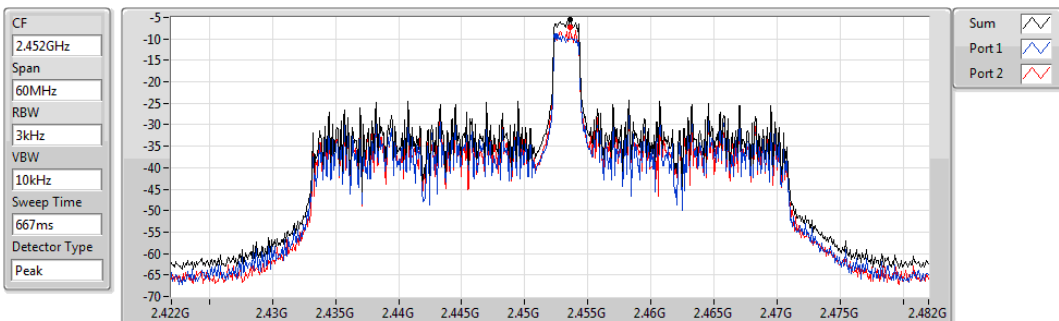

Sum	PD	Port 1	Port 2
(dBm/RBW)	(dBm/RBW)	(dBm/RBW)	(dBm/RBW)
-5.39	-5.39	-9.32	-7.24

802.11ax HEW40_RU26_Index17_Nss1,(MCS0)_2TX

PSD

2422MHz

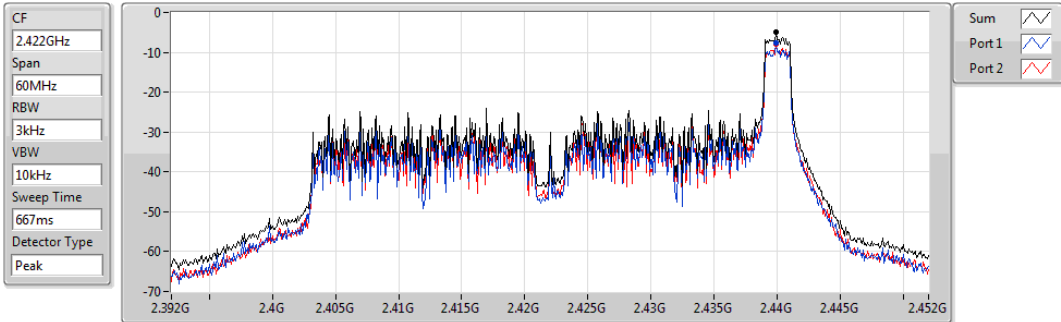

Sum	PD	Port 1	Port 2
(dBm/RBW)	(dBm/RBW)	(dBm/RBW)	(dBm/RBW)
-4.82	-4.82	-7.70	-7.97

802.11ax HEW40_RU26_Index17_Nss1,(MCS0)_2TX

PSD

2437MHz

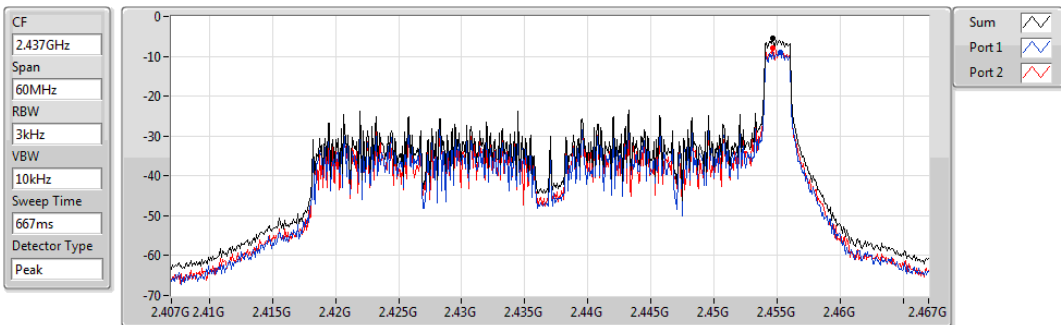

Sum	PD	Port 1	Port 2
(dBm/RBW)	(dBm/RBW)	(dBm/RBW)	(dBm/RBW)
-5.46	-5.46	-9.01	-7.92

802.11ax HEW40_RU26_Index17_Nss1,(MCS0)_2TX

PSD

2452MHz

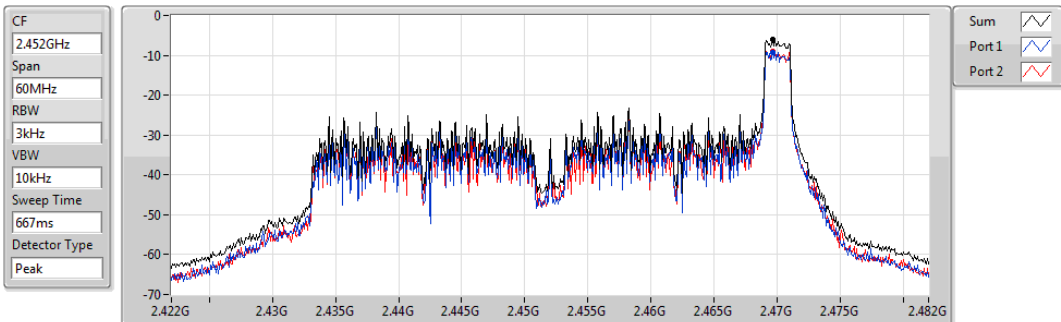

Sum	PD	Port 1	Port 2
(dBm/RBW)	(dBm/RBW)	(dBm/RBW)	(dBm/RBW)
-6.09	-6.09	-9.27	-8.94

802.11ax HEW40_RU52_Index37_Nss1,(MCS0)_2TX

PSD

2422MHz

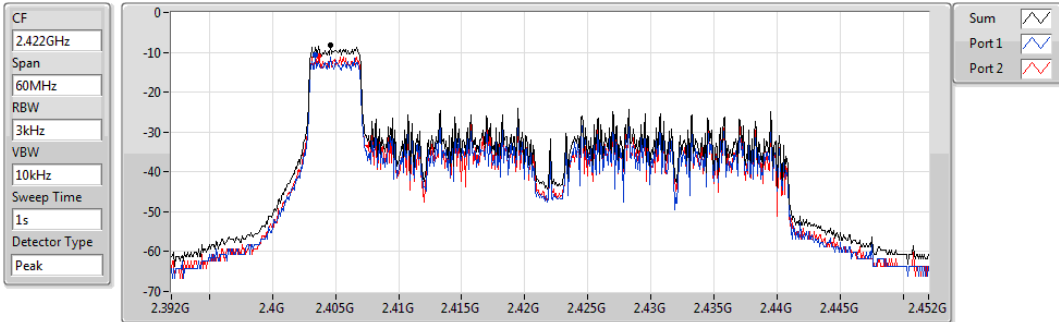

Sum	PD	Port 1	Port 2
(dBm/RBW)	(dBm/RBW)	(dBm/RBW)	(dBm/RBW)
-8.23	-8.23	-10.69	-11.01

802.11ax HEW40_RU52_Index37_Nss1,(MCS0)_2TX

PSD

2437MHz

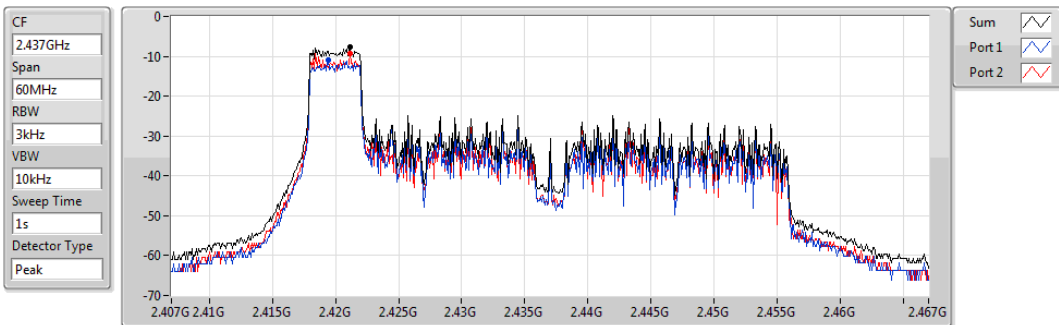

Sum	PD	Port 1	Port 2
(dBm/RBW)	(dBm/RBW)	(dBm/RBW)	(dBm/RBW)
-7.70	-7.70	-10.98	-9.17

802.11ax HEW40_RU52_Index37_Nss1,(MCS0)_2TX

PSD

2452MHz

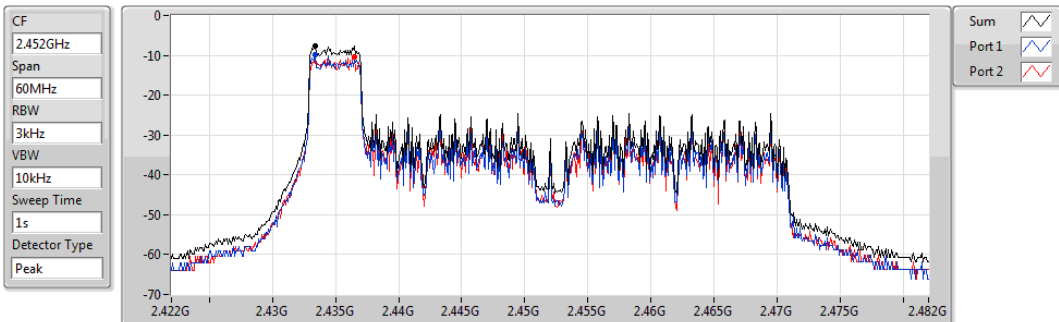

Sum	PD	Port 1	Port 2
(dBm/RBW)	(dBm/RBW)	(dBm/RBW)	(dBm/RBW)
-7.79	-7.79	-9.83	-10.46

802.11ax HEW40_RU52_Index41_Nss1,(MCS0)_2TX

PSD

2422MHz

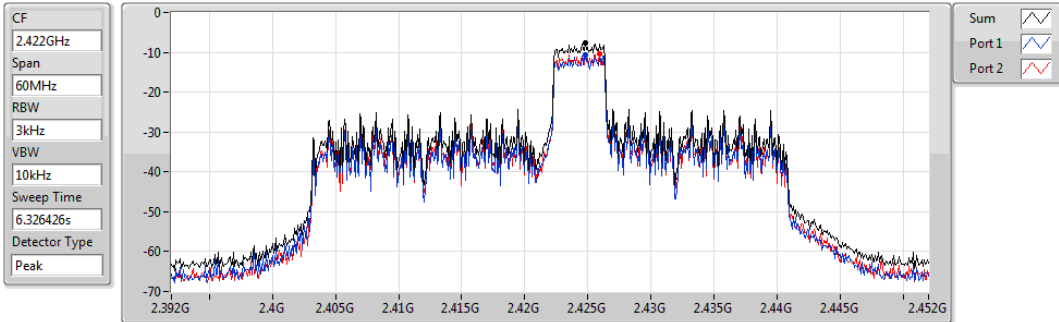

Sum	PD	Port 1	Port 2
(dBm/RBW)	(dBm/RBW)	(dBm/RBW)	(dBm/RBW)
-7.61	-7.61	-10.53	-10.26

802.11ax HEW40_RU52_Index41_Nss1,(MCS0)_2TX

PSD

2437MHz

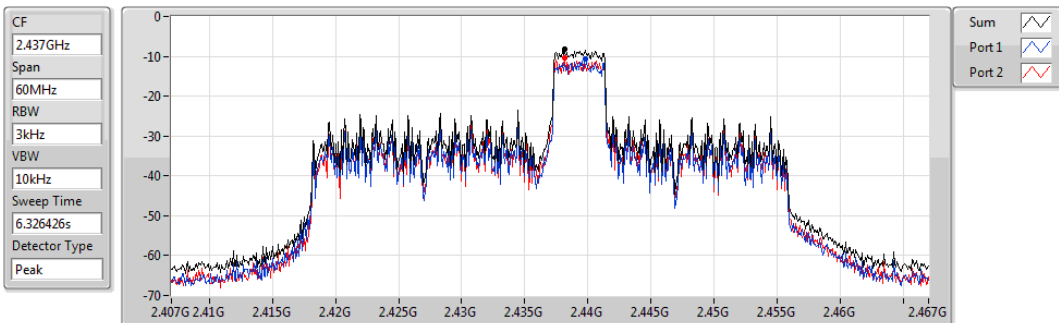

Sum	PD	Port 1	Port 2
(dBm/RBW)	(dBm/RBW)	(dBm/RBW)	(dBm/RBW)
-8.16	-8.16	-10.78	-10.42

802.11ax HEW40_RU52_Index41_Nss1,(MCS0)_2TX

PSD

2452MHz

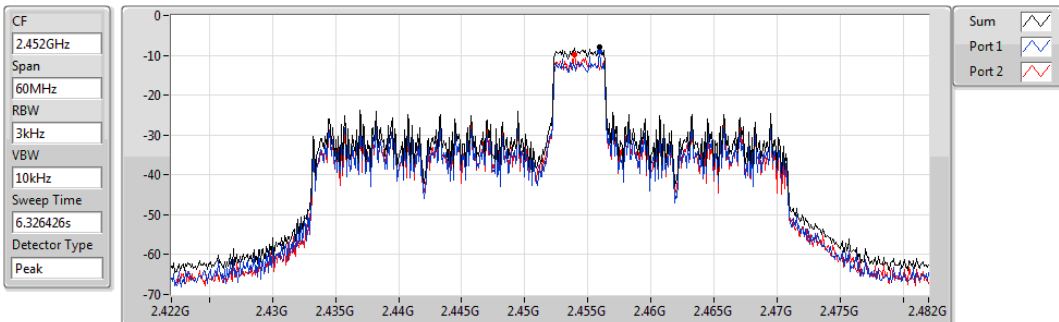

Sum	PD	Port 1	Port 2
(dBm/RBW)	(dBm/RBW)	(dBm/RBW)	(dBm/RBW)
-7.81	-7.81	-9.11	-9.97

802.11ax HEW40_RU52_Index44_Nss1,(MCS0)_2TX

PSD

2422MHz

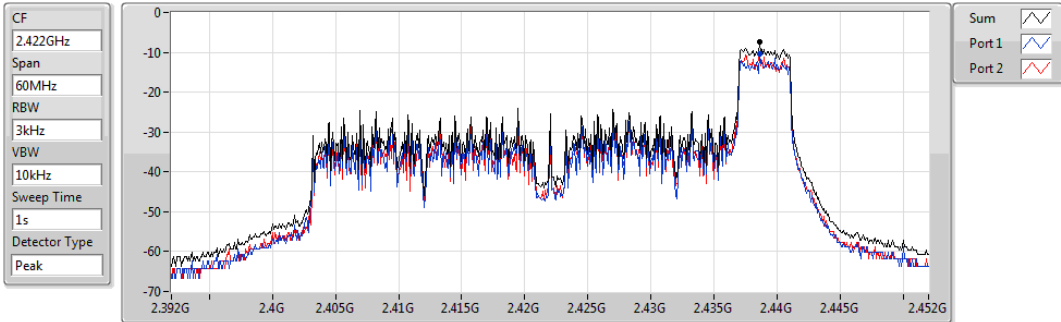

Sum	PD	Port 1	Port 2
(dBm/RBW)	(dBm/RBW)	(dBm/RBW)	(dBm/RBW)
-7.48	-7.48	-10.47	-10.52

802.11ax HEW40_RU52_Index44_Nss1,(MCS0)_2TX

PSD

2437MHz

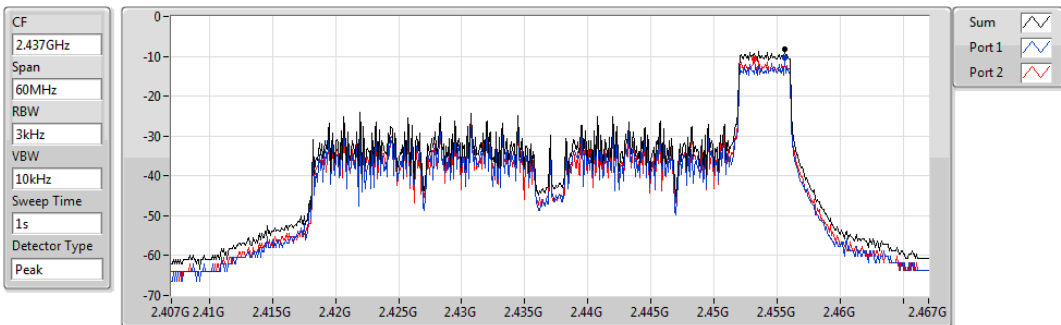

Sum	PD	Port 1	Port 2
(dBm/RBW)	(dBm/RBW)	(dBm/RBW)	(dBm/RBW)
-8.17	-8.17	-10.31	-10.76

802.11ax HEW40_RU52_Index44_Nss1,(MCS0)_2TX

PSD

2452MHz

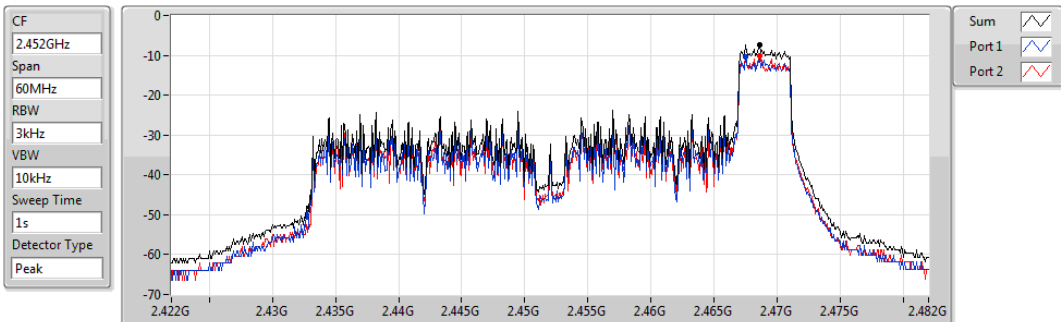

Sum	PD	Port 1	Port 2
(dBm/RBW)	(dBm/RBW)	(dBm/RBW)	(dBm/RBW)
-7.32	-7.32	-10.40	-10.06

802.11ax HEW40_RU106_Index53_Nss1,(MCS0)_2TX

PSD

2422MHz

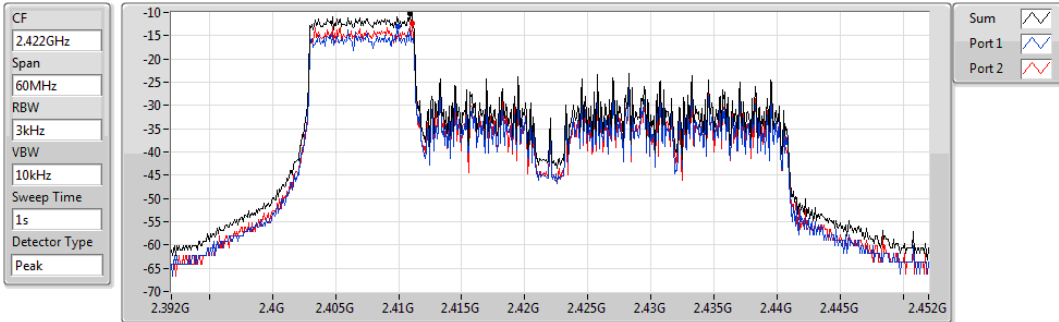

Sum	PD	Port 1	Port 2
(dBm/RBW)	(dBm/RBW)	(dBm/RBW)	(dBm/RBW)
-10.24	-10.24	-13.08	-12.45

802.11ax HEW40_RU106_Index53_Nss1,(MCS0)_2TX

PSD

2437MHz

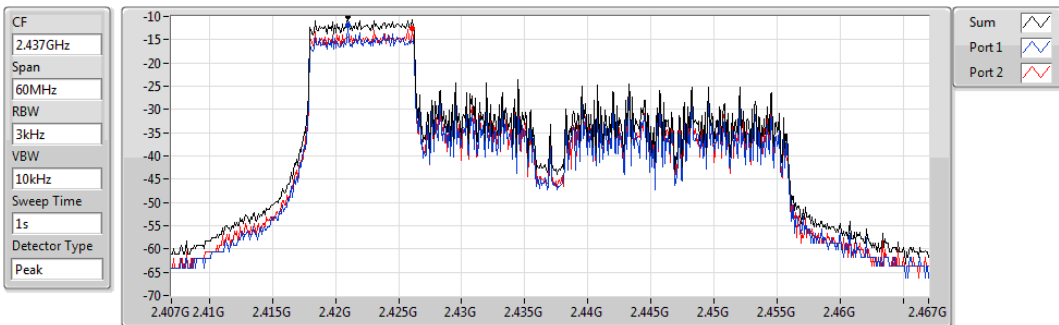

Sum	PD	Port 1	Port 2
(dBm/RBW)	(dBm/RBW)	(dBm/RBW)	(dBm/RBW)
-10.06	-10.06	-11.98	-12.61

802.11ax HEW40_RU106_Index53_Nss1,(MCS0)_2TX

PSD

2452MHz

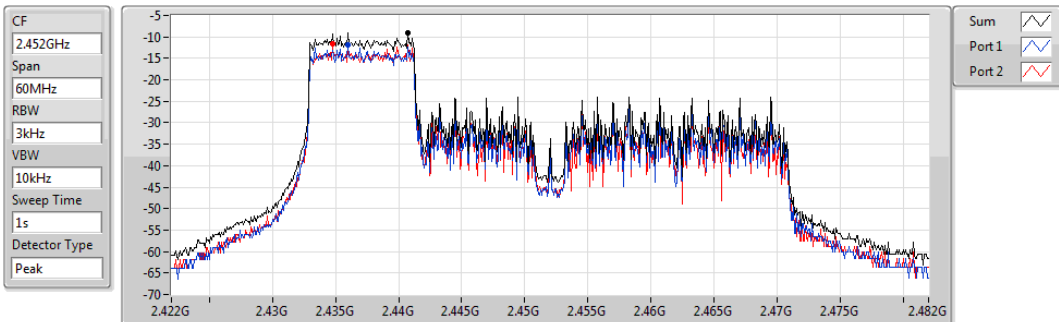

Sum	PD	Port 1	Port 2
(dBm/RBW)	(dBm/RBW)	(dBm/RBW)	(dBm/RBW)
-9.06	-9.06	-11.79	-11.70

802.11ax HEW40_RU106_Index54_Nss1,(MCS0)_2TX

PSD

2422MHz

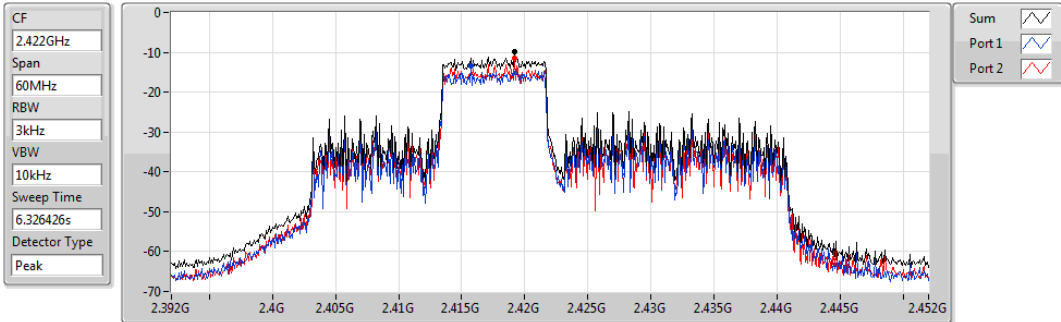

Sum	PD	Port 1	Port 2
(dBm/RBW)	(dBm/RBW)	(dBm/RBW)	(dBm/RBW)
-9.97	-9.97	-13.39	-11.48

802.11ax HEW40_RU106_Index54_Nss1,(MCS0)_2TX

PSD

2437MHz

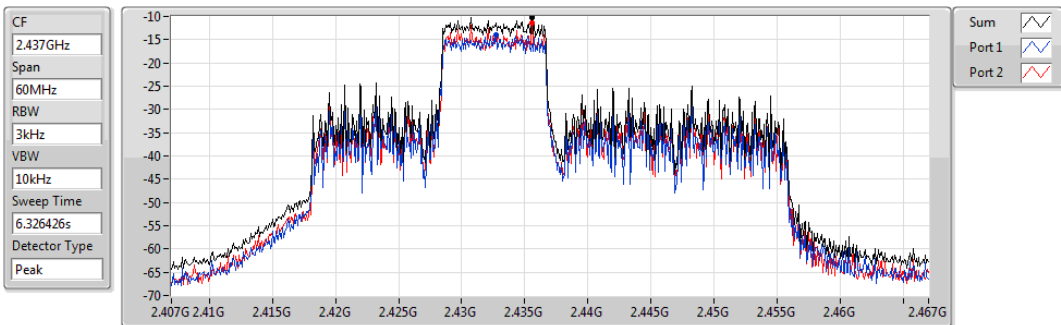

Sum	PD	Port 1	Port 2
(dBm/RBW)	(dBm/RBW)	(dBm/RBW)	(dBm/RBW)
-10.15	-10.15	-14.06	-11.52

802.11ax HEW40_RU106_Index54_Nss1,(MCS0)_2TX

PSD

2452MHz

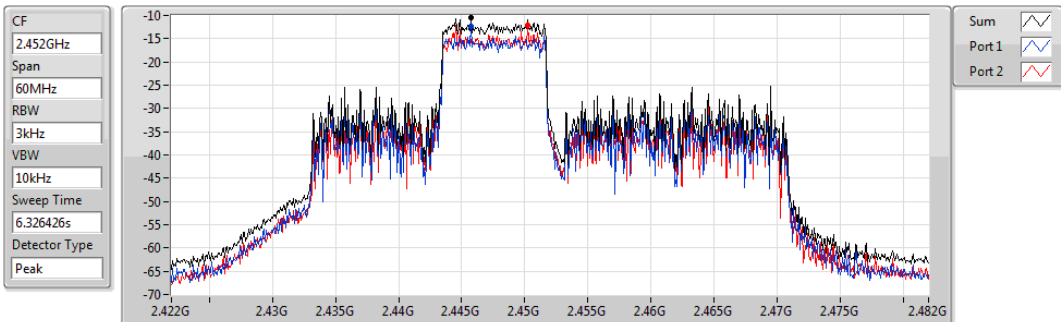

Sum	PD	Port 1	Port 2
(dBm/RBW)	(dBm/RBW)	(dBm/RBW)	(dBm/RBW)
-10.52	-10.52	-12.39	-12.06

802.11ax HEW40_RU106_Index56_Nss1,(MCS0)_2TX

PSD

2422MHz

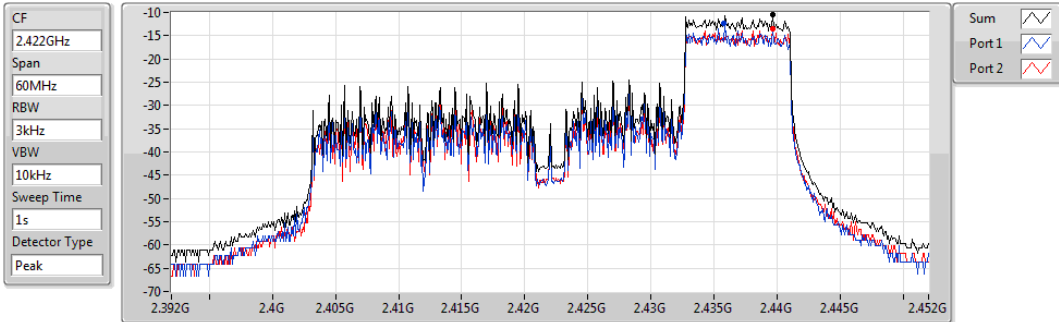

Sum	PD	Port 1	Port 2
(dBm/RBW)	(dBm/RBW)	(dBm/RBW)	(dBm/RBW)
-10.48	-10.48	-12.36	-13.57

802.11ax HEW40_RU106_Index56_Nss1,(MCS0)_2TX

PSD

2437MHz

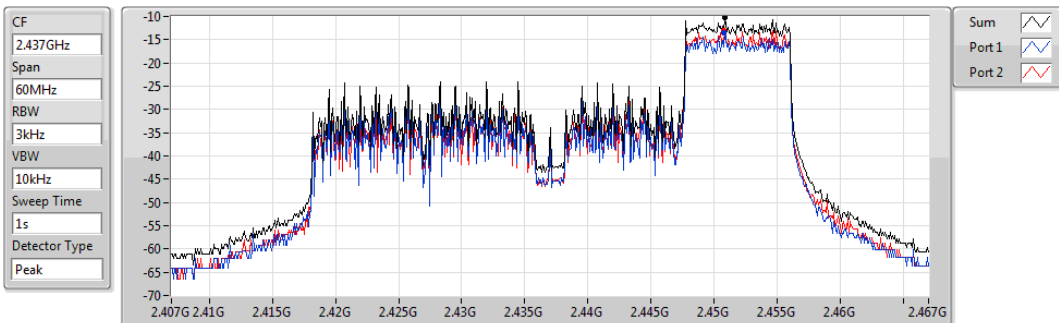

Sum	PD	Port 1	Port 2
(dBm/RBW)	(dBm/RBW)	(dBm/RBW)	(dBm/RBW)
-10.21	-10.21	-13.50	-12.96

802.11ax HEW40_RU106_Index56_Nss1,(MCS0)_2TX

PSD

2452MHz

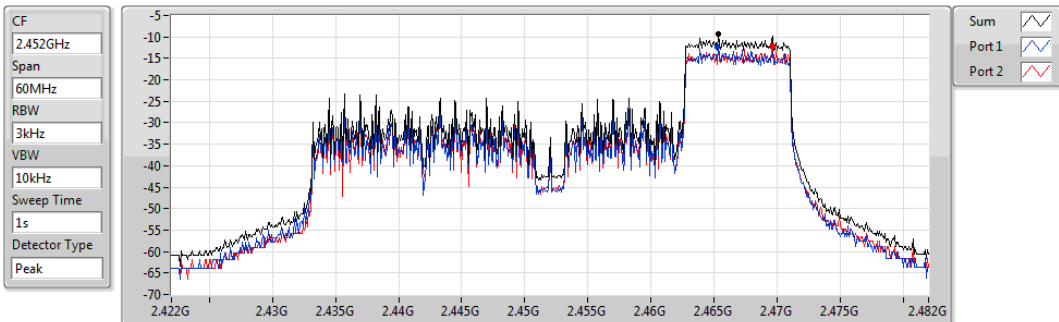

Sum	PD	Port 1	Port 2
(dBm/RBW)	(dBm/RBW)	(dBm/RBW)	(dBm/RBW)
-9.34	-9.34	-12.36	-12.23

802.11ax HEW40_RU242_Index61_Nss1,(MCS0)_2TX

PSD

2422MHz

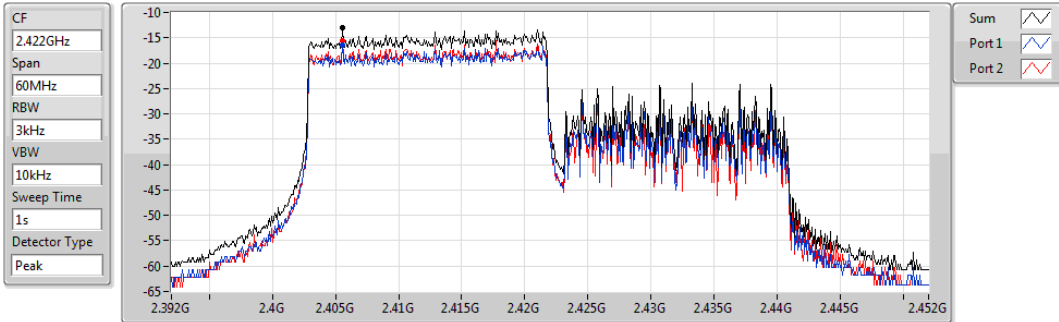

Sum	PD	Port 1	Port 2
(dBm/RBW)	(dBm/RBW)	(dBm/RBW)	(dBm/RBW)
-13.06	-13.06	-16.53	-15.66

802.11ax HEW40_RU242_Index61_Nss1,(MCS0)_2TX

PSD

2437MHz

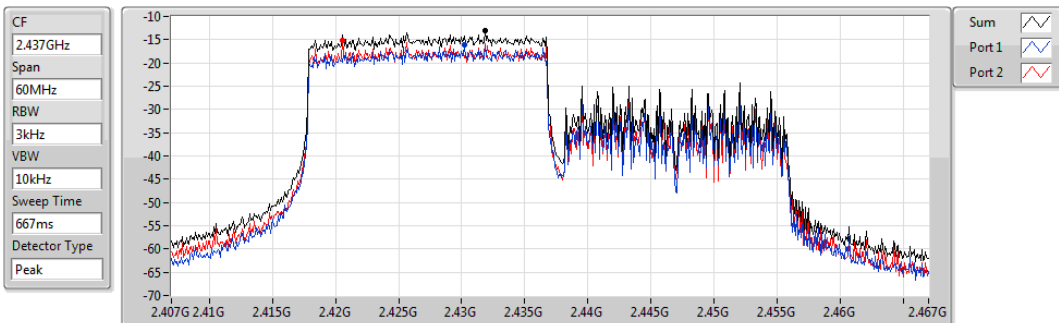

Sum	PD	Port 1	Port 2
(dBm/RBW)	(dBm/RBW)	(dBm/RBW)	(dBm/RBW)
-13.15	-13.15	-16.19	-15.20

802.11ax HEW40_RU242_Index61_Nss1,(MCS0)_2TX

PSD

2452MHz

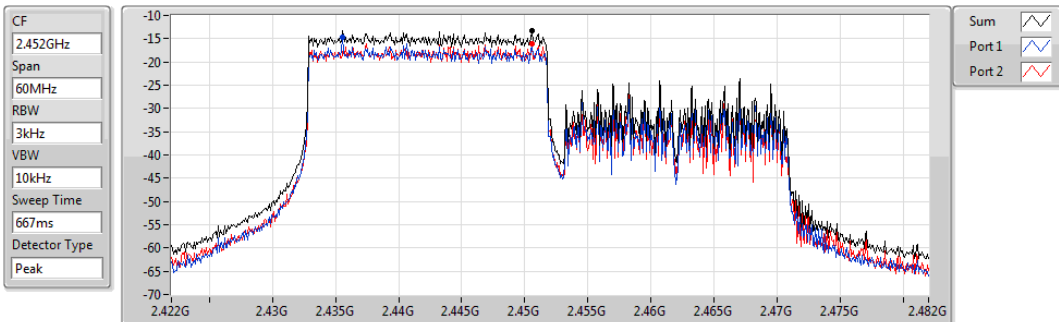

Sum	PD	Port 1	Port 2
(dBm/RBW)	(dBm/RBW)	(dBm/RBW)	(dBm/RBW)
-13.25	-13.25	-14.77	-15.99

802.11ax HEW40_RU242_Index62_Nss1,(MCS0)_2TX

PSD

2422MHz

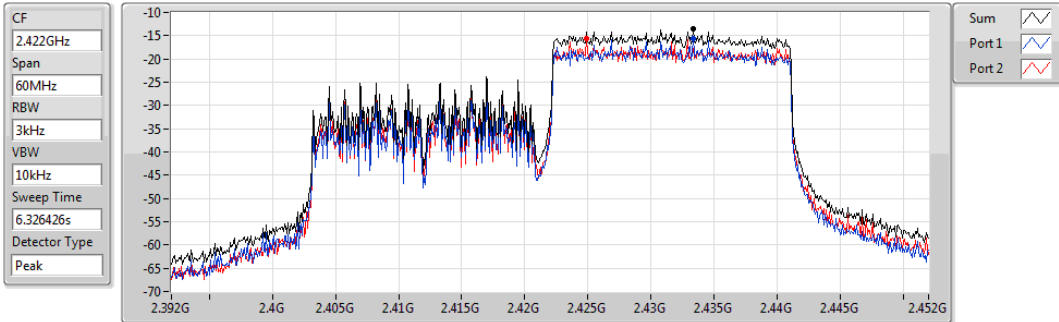

Sum	PD	Port 1	Port 2
(dBm/RBW)	(dBm/RBW)	(dBm/RBW)	(dBm/RBW)
-13.58	-13.58	-15.66	-15.56

802.11ax HEW40_RU242_Index62_Nss1,(MCS0)_2TX

PSD

2437MHz

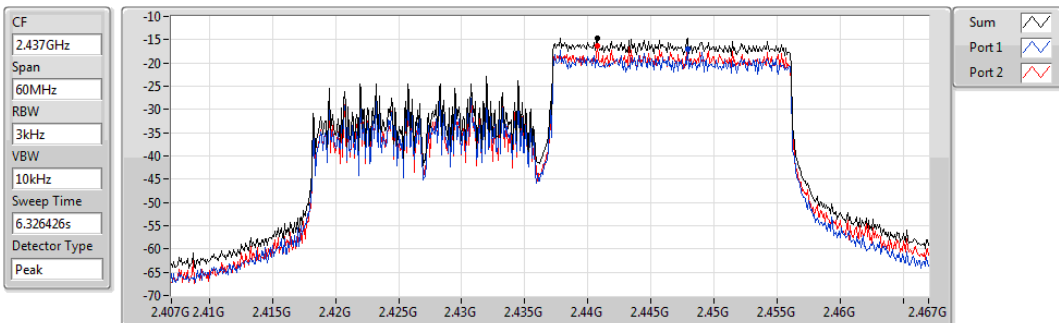

Sum	PD	Port 1	Port 2
(dBm/RBW)	(dBm/RBW)	(dBm/RBW)	(dBm/RBW)
-14.59	-14.59	-16.93	-16.30

802.11ax HEW40_RU242_Index62_Nss1,(MCS0)_2TX

PSD

2452MHz

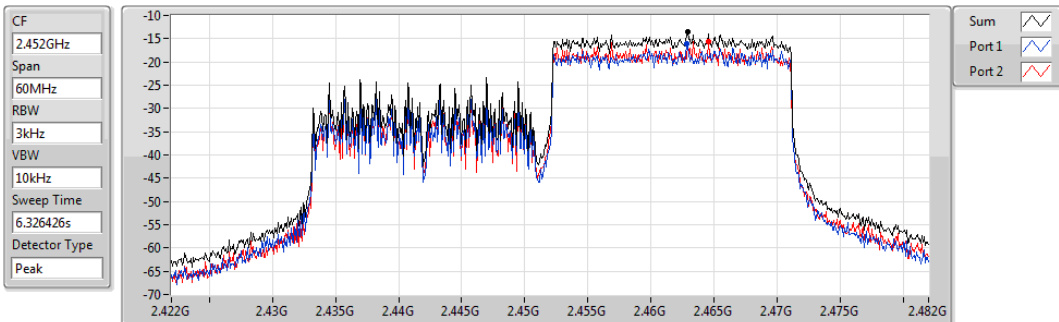

Sum	PD	Port 1	Port 2
(dBm/RBW)	(dBm/RBW)	(dBm/RBW)	(dBm/RBW)
-13.45	-13.45	-15.99	-15.54

802.11ax HEW40_RU484_Index65_Nss1,(MCS0)_2TX

PSD

2422MHz

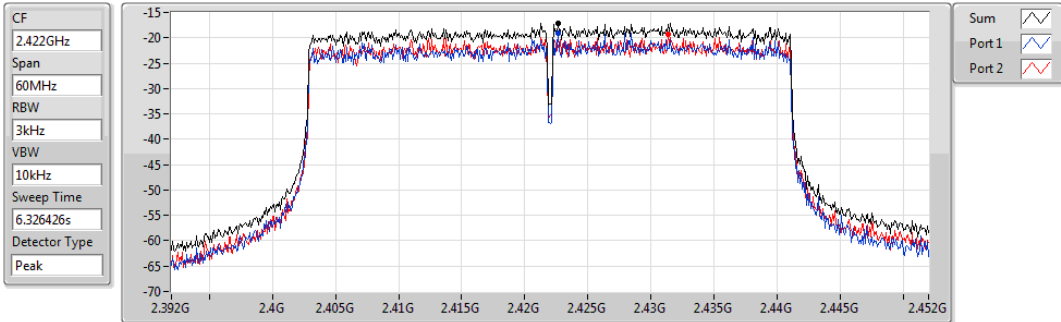

Sum	PD	Port 1	Port 2
(dBm/RBW)	(dBm/RBW)	(dBm/RBW)	(dBm/RBW)
-17.16	-17.16	-19.07	-19.32

802.11ax HEW40_RU484_Index65_Nss1,(MCS0)_2TX

PSD

2437MHz

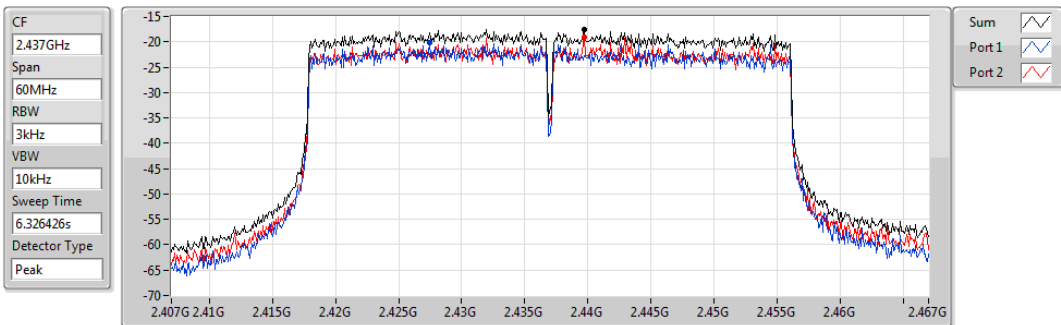

Sum	PD	Port 1	Port 2
(dBm/RBW)	(dBm/RBW)	(dBm/RBW)	(dBm/RBW)
-17.56	-17.56	-20.14	-19.13

802.11ax HEW40_RU484_Index65_Nss1,(MCS0)_2TX

PSD

2452MHz

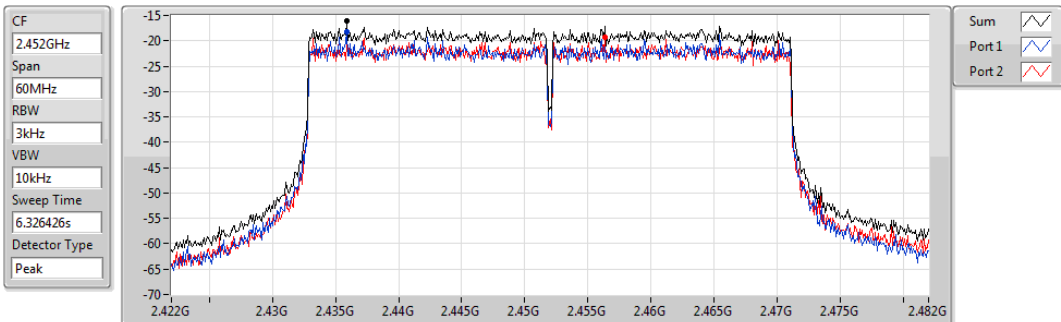

Sum	PD	Port 1	Port 2
(dBm/RBW)	(dBm/RBW)	(dBm/RBW)	(dBm/RBW)
-16.15	-16.15	-18.12	-19.30

3.5 Unwanted Emissions into Restricted Frequency Bands

3.5.1 Limit of Unwanted Emissions into Restricted Frequency Bands

Restricted Band Emissions Limit			
Frequency Range (MHz)	Field Strength (uV/m)	Field Strength (dBuV/m)	Measure Distance (m)
0.009~0.490	2400/F(kHz)	48.5 - 13.8	300
0.490~1.705	24000/F(kHz)	33.8 - 23	30
1.705~30.0	30	29	30
30~88	100	40	3
88~216	150	43.5	3
216~960	200	46	3
Above 960	500	54	3

Note 1:
Quasi-Peak value is measured for frequency below 1GHz except for 9–90 kHz, 110–490 kHz frequency band. Peak and average value are measured for frequency above 1GHz. The limit on average radio frequency emission is as above table. The limit on peak radio frequency emissions is 20 dB above the maximum permitted average emission limit

Note 2:
Measurements may be performed at a distance other than what is specified provided. When performing measurements at a distance other than that specified, the results shall be extrapolated to the specified distance using an extrapolation factor as below, Frequency at or above 30 MHz: 20 dB/decade Frequency below 30 MHz: 40 dB/decade.

3.5.2 Test Procedures

1. Measurement is made at a semi-anechoic chamber that incorporates a turntable allowing a EUT rotation of 360°. A continuously-rotating, remotely-controlled turntable is installed at the test site to support the EUT and facilitate determination of the direction of maximum radiation for each EUT emission frequency. The EUT is placed at test table. For emissions testing at or below 1 GHz, the table height is 80 cm above the reference ground plane. For emission measurements above 1 GHz, the table height is 1.5 m
2. Measurement is made with the antenna positioned in both the horizontal and vertical planes of polarization. The measurement antenna is varied in height (1m ~ 4m) above the reference ground plane to obtain the maximum signal strength. Distance between EUT and antenna is 3 m.
3. This investigation is performed with the EUT rotated 360°, the antenna height scanned between 1 m and 4 m, and the antenna rotated to repeat the measurements for both the horizontal and vertical antenna polarizations.

Note:

1. 120kHz measurement bandwidth of test receiver and Quasi-peak detector is for radiated emission below 1GHz.
2. RBW=1MHz, VBW=3MHz and Peak detector is for peak measured value of radiated emission above 1GHz.
3. RBW=1MHz, VBW=1/T and Peak detector is for average measured value of radiated emission above 1GHz.

3.5.3 Test Setup

Radiated Emissions below 1 GHz

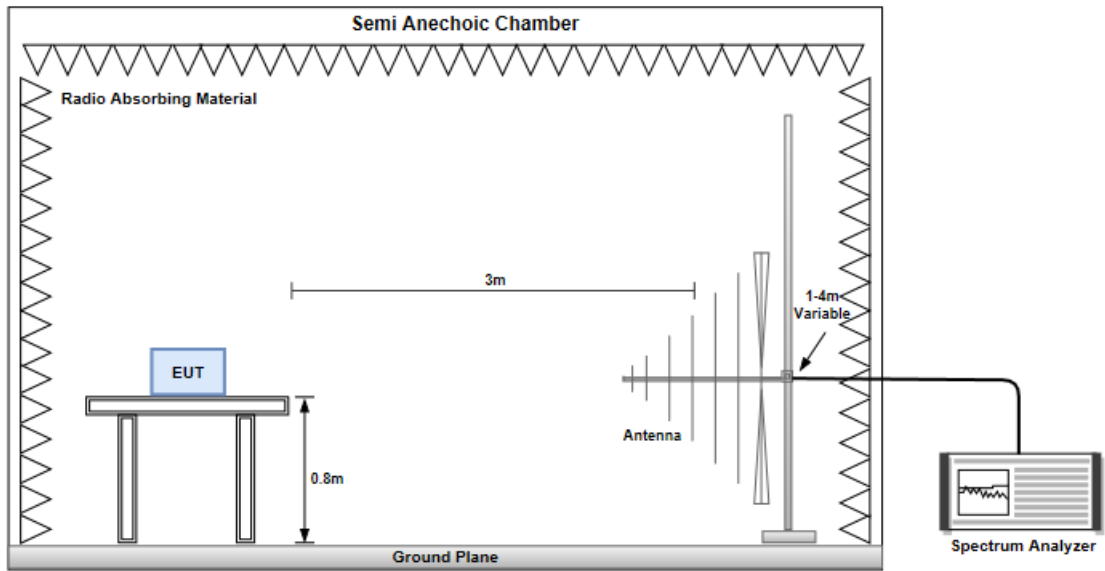

Radiated Emissions above 1 GHz

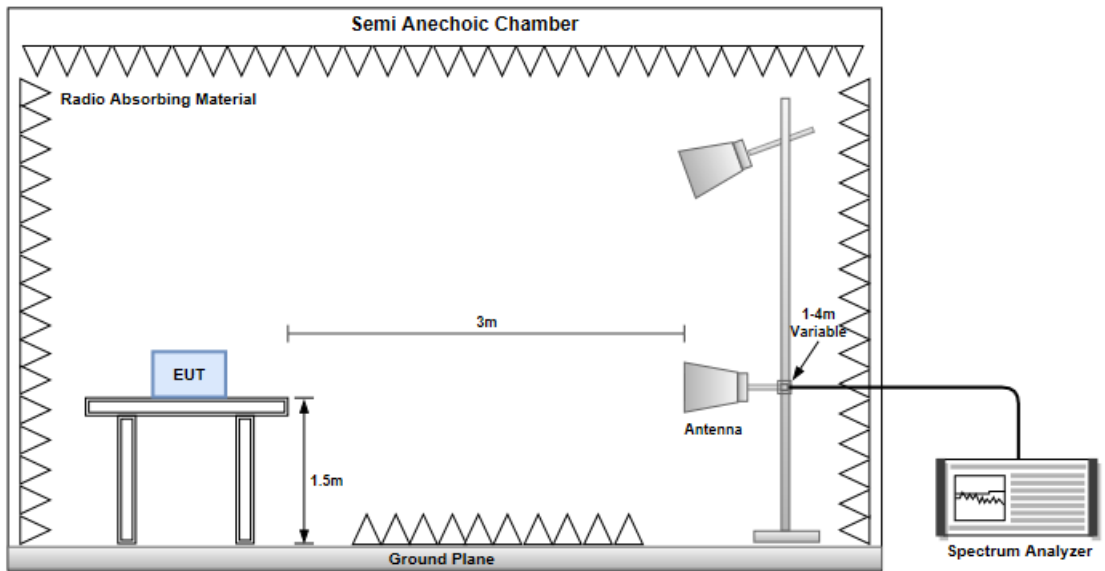

3.5.4 Transmitter Radiated Unwanted Emissions (Below 1GHz)

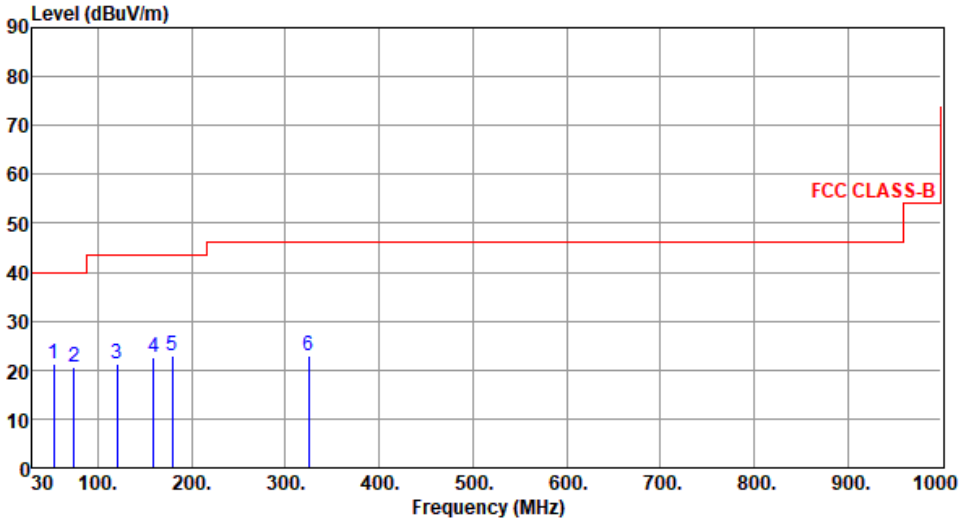
Modulation	11g	Test Freq. (MHz)	2412						
Polarization	Horizontal								
									
	Freq. MHz	Emission level dBuV/m	Limit dBuV/m	Margin dB	SA reading dBuV	Factor dB	Remark	ANT High cm	Turn Table deg
1	52.45	21.18	40.00	-18.82	29.62	-8.44	Peak	---	---
2	74.59	20.68	40.00	-19.32	32.24	-11.56	Peak	---	---
3	120.31	21.36	43.50	-22.14	31.95	-10.59	Peak	---	---
4	159.15	22.61	43.50	-20.89	30.95	-8.34	Peak	---	---
5	179.42	22.87	43.50	-20.63	32.68	-9.81	Peak	---	---
6	324.79	22.84	46.00	-23.16	30.12	-7.28	Peak	---	---

Note 1: Emission Level (dBuV/m) = SA Reading (dBuV/m) + Factor* (dB)
*Factor includes antenna factor , cable loss and amplifier gain
Note 2: Margin (dB) = Emission level (dBuV/m) – Limit (dBuV/m).
Note 3: All spurious emissions below 30MHz are more than 20 dB below the limit.

Modulation	11g	Test Freq. (MHz)	2412
Polarization	Vertical		

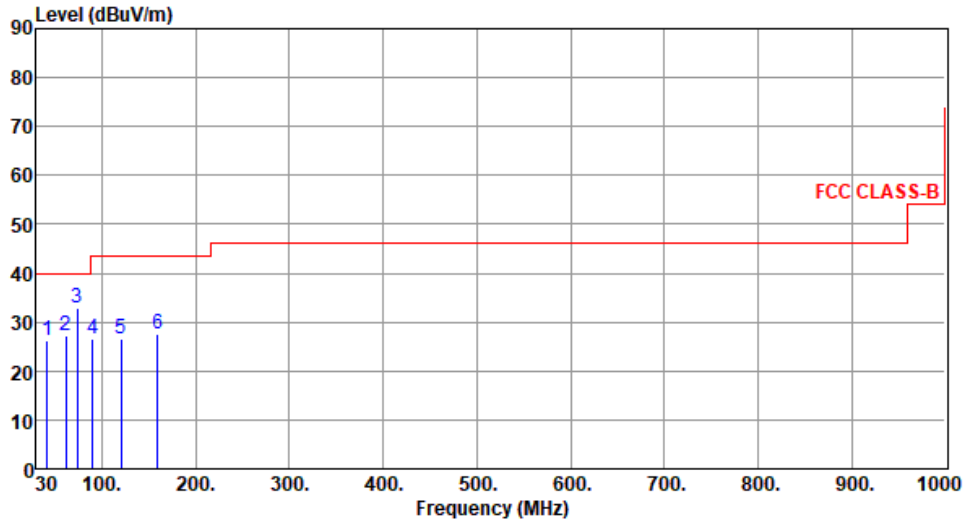

	Freq. MHz	Emission level dBuV/m	Limit dBuV/m	Margin dB	SA reading dBuV	Factor dB	Remark	ANT High cm	Turn Table deg
1	41.55	26.21	40.00	-13.79	34.63	-8.42	Peak	---	---
2	61.21	27.37	40.00	-12.63	36.41	-9.04	Peak	---	---
3	73.49	32.78	40.00	-7.22	44.22	-11.44	Peak	---	---
4	90.14	26.59	43.50	-16.91	40.86	-14.27	Peak	---	---
5	120.31	26.48	43.50	-17.02	37.07	-10.59	Peak	---	---
6	159.11	27.45	43.50	-16.05	35.78	-8.33	Peak	---	---

Note 1: Emission Level (dBuV/m) = SA Reading (dBuV/m) + Factor* (dB)

*Factor includes antenna factor , cable loss and amplifier gain

Note 2: Margin (dB) = Emission level (dBuV/m) – Limit (dBuV/m).

Note 3: All spurious emissions below 30MHz are more than 20 dB below the limit.

3.5.5 Transmitter Radiated Unwanted Emissions (Above 1GHz) for 11b

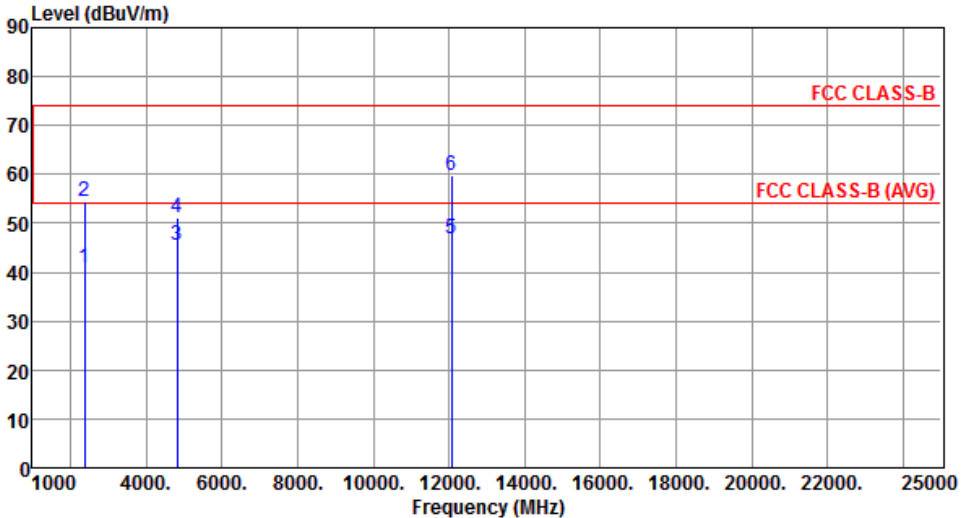
Modulation	11b	Test Freq. (MHz)	2412						
Polarization	Horizontal								
									
	Freq.	Emission level	Limit	Margin	SA reading	Factor	Remark	ANT High	Turn Table
	MHz	dBuV/m	dBuV/m	dB	dBuV	dB		cm	deg
1	2390.00	40.83	54.00	-13.17	43.63	-2.80	Average	121	154
2	2390.00	54.53	74.00	-19.47	57.33	-2.80	Peak	121	154
3	4824.00	45.35	54.00	-8.65	41.75	3.60	Average	244	125
4	4824.00	51.18	74.00	-22.82	47.58	3.60	Peak	244	125
5	12060.00	46.72	54.00	-7.28	32.87	13.85	Average	100	50
6	12060.00	59.79	74.00	-14.21	45.94	13.85	Peak	100	50
<p>Note 1: Emission Level (dBuV/m) = SA Reading (dBuV/m) + Factor* (dB) *Factor includes antenna factor , cable loss and amplifier gain</p> <p>Note 2: Margin (dB) = Emission level (dBuV/m) – Limit (dBuV/m).</p>									

Modulation	11b	Test Freq. (MHz)	2412
Polarization	Vertical		

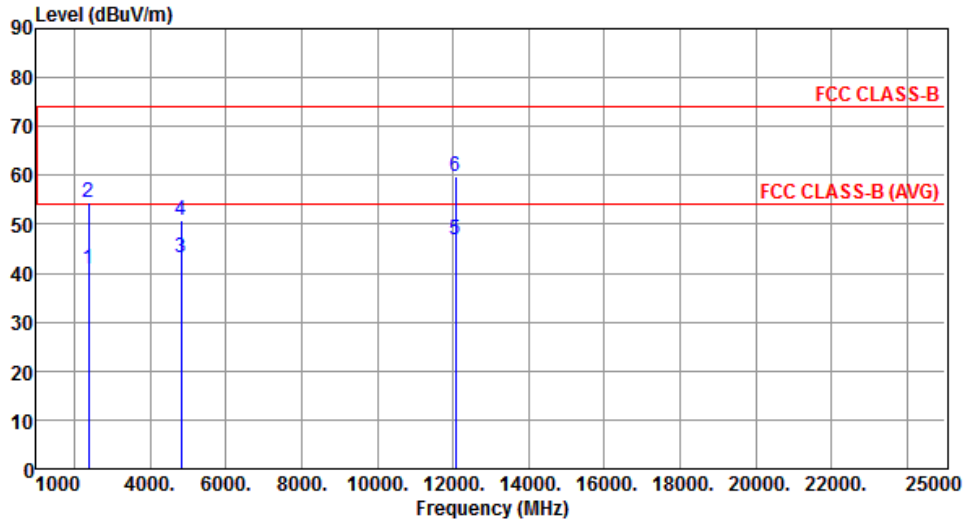

	Freq. MHz	Emission level dBuV/m	Limit dBuV/m	Margin dB	SA reading dBuV	Factor dB	Remark	ANT High cm	Turn Table deg
1	2390.00	40.79	54.00	-13.21	43.59	-2.80	Average	185	92
2	2390.00	54.41	74.00	-19.59	57.21	-2.80	Peak	185	92
3	4824.00	43.14	54.00	-10.86	39.54	3.60	Average	105	106
4	4824.00	50.84	74.00	-23.16	47.24	3.60	Peak	105	106
5	12060.00	46.80	54.00	-7.20	32.95	13.85	Average	100	20
6	12060.00	59.82	74.00	-14.18	45.97	13.85	Peak	100	20

Note 1: Emission Level (dBuV/m) = SA Reading (dBuV/m) + Factor* (dB)

*Factor includes antenna factor , cable loss and amplifier gain

Note 2: Margin (dB) = Emission level (dBuV/m) – Limit (dBuV/m).

Modulation	11b	Test Freq. (MHz)	2437
Polarization	Horizontal		

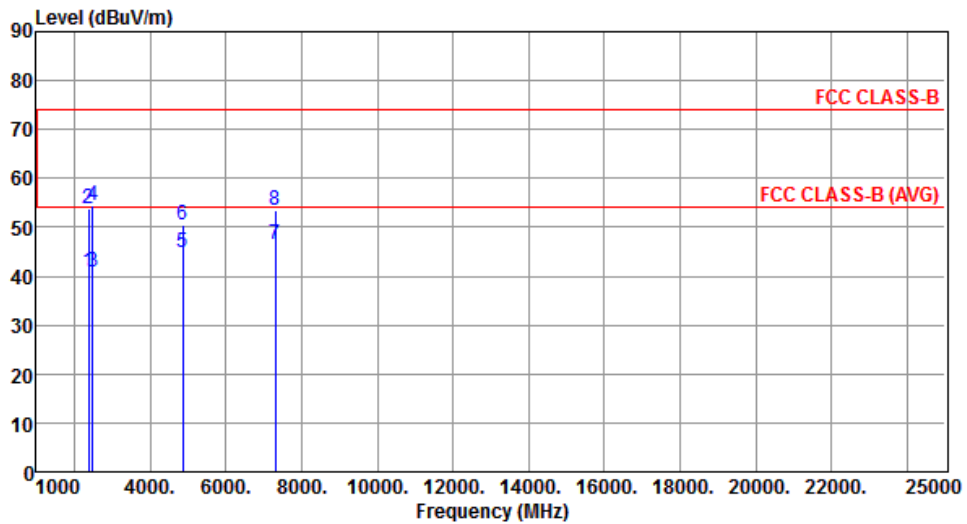

	Freq. MHz	Emission level dBuV/m	Limit dBuV/m	Margin dB	SA reading dBuV	Factor dB	Remark	ANT High cm	Turn Table deg
1	2390.00	40.80	54.00	-13.20	43.60	-2.80	Average	100	142
2	2390.00	53.80	74.00	-20.20	56.60	-2.80	Peak	100	142
3	2483.50	40.88	54.00	-13.12	43.91	-3.03	Average	100	142
4	2483.50	54.38	74.00	-19.62	57.41	-3.03	Peak	100	142
5	4874.00	44.78	54.00	-9.22	41.14	3.64	Average	237	129
6	4874.00	50.58	74.00	-23.42	46.94	3.64	Peak	237	129
7	7311.00	46.33	54.00	-7.67	37.06	9.27	Average	225	119
8	7311.00	53.61	74.00	-20.39	44.34	9.27	Peak	225	119

Note 1: Emission Level (dBuV/m) = SA Reading (dBuV/m) + Factor* (dB)

*Factor includes antenna factor , cable loss and amplifier gain

Note 2: Margin (dB) = Emission level (dBuV/m) – Limit (dBuV/m).

Modulation	11b	Test Freq. (MHz)	2437
Polarization	Vertical		

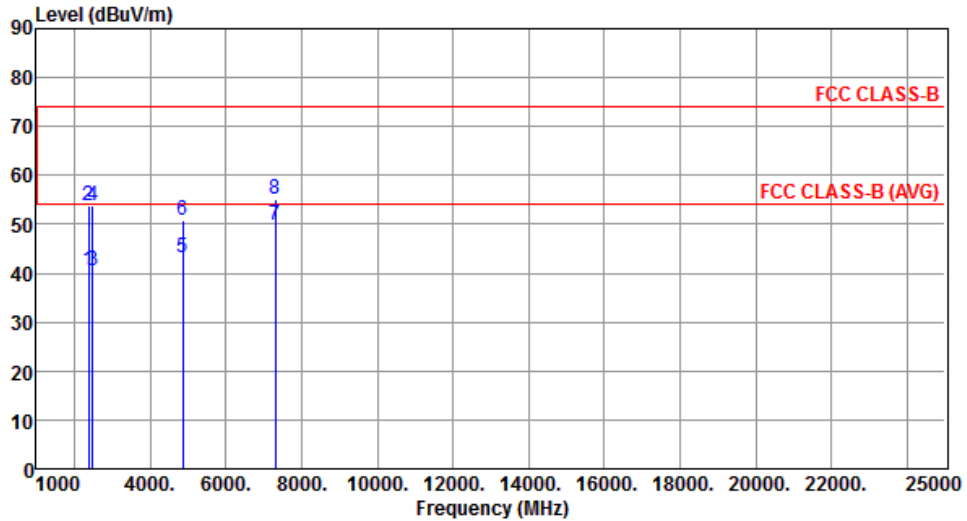

	Freq. MHz	Emission level dBuV/m	Limit dBuV/m	Margin dB	SA reading dBuV	Factor dB	Remark	ANT High cm	Turn Table deg
1	2390.00	40.47	54.00	-13.53	43.27	-2.80	Average	184	91
2	2390.00	53.81	74.00	-20.19	56.61	-2.80	Peak	184	91
3	2483.50	40.53	54.00	-13.47	43.56	-3.03	Average	184	91
4	2483.50	53.91	74.00	-20.09	56.94	-3.03	Peak	184	91
5	4874.00	43.27	54.00	-10.73	39.63	3.64	Average	101	101
6	4874.00	50.68	74.00	-23.32	47.04	3.64	Peak	101	101
7	7311.00	49.87	54.00	-4.13	40.60	9.27	Average	245	165
8	7311.00	55.00	74.00	-19.00	45.73	9.27	Peak	245	165

Note 1: Emission Level (dBuV/m) = SA Reading (dBuV/m) + Factor* (dB)

*Factor includes antenna factor , cable loss and amplifier gain

Note 2: Margin (dB) = Emission level (dBuV/m) – Limit (dBuV/m).

Modulation	11b	Test Freq. (MHz)	2462
Polarization	Horizontal		

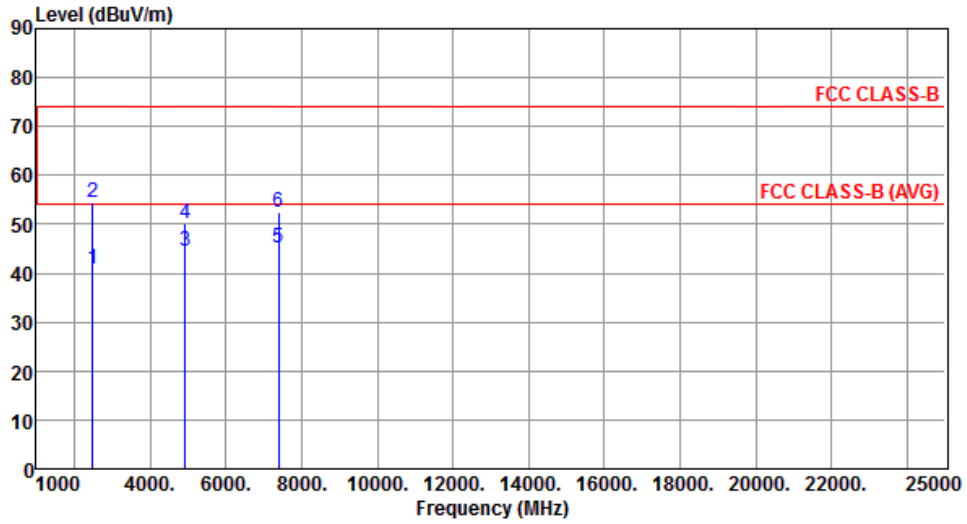

	Freq. MHz	Emission level dBuV/m	Limit dBuV/m	Margin dB	SA reading dBuV	Factor dB	Remark	ANT High cm	Turn Table deg
1	2483.50	40.75	54.00	-13.25	43.78	-3.03	Average	121	152
2	2483.50	54.42	74.00	-19.58	57.45	-3.03	Peak	121	152
3	4924.00	44.53	54.00	-9.47	40.84	3.69	Average	240	131
4	4924.00	50.27	74.00	-23.73	46.58	3.69	Peak	240	131
5	7386.00	45.26	54.00	-8.74	36.19	9.07	Average	230	121
6	7386.00	52.49	74.00	-21.51	43.42	9.07	Peak	230	121

Note 1: Emission Level (dBuV/m) = SA Reading (dBuV/m) + Factor* (dB)

*Factor includes antenna factor , cable loss and amplifier gain

Note 2: Margin (dB) = Emission level (dBuV/m) – Limit (dBuV/m).

Modulation	11b	Test Freq. (MHz)	2462
Polarization	Vertical		

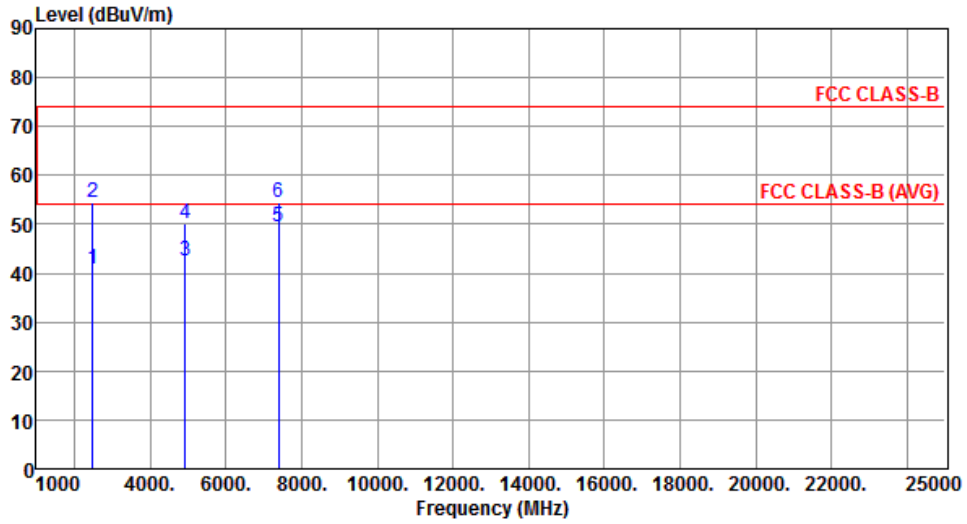

	Freq. MHz	Emission level dBuV/m	Limit dBuV/m	Margin dB	SA reading dBuV	Factor dB	Remark	ANT High cm	Turn Table deg
1	2483.50	40.69	54.00	-13.31	43.72	-3.03	Average	185	96
2	2483.50	54.31	74.00	-19.69	57.34	-3.03	Peak	185	96
3	4924.00	42.37	54.00	-11.63	38.68	3.69	Average	110	99
4	4924.00	50.09	74.00	-23.91	46.40	3.69	Peak	110	99
5	7386.00	49.39	54.00	-4.61	40.32	9.07	Average	244	158
6	7386.00	54.47	74.00	-19.53	45.40	9.07	Peak	244	158

Note 1: Emission Level (dBuV/m) = SA Reading (dBuV/m) + Factor* (dB)

*Factor includes antenna factor , cable loss and amplifier gain

Note 2: Margin (dB) = Emission level (dBuV/m) – Limit (dBuV/m).

3.5.6 Transmitter Radiated Unwanted Emissions (Above 1GHz) for 11g

Modulation	11g	Test Freq. (MHz)	2412						
Polarization	Horizontal								
Freq.	Emission level	Limit	Margin	SA reading	Factor	Remark	ANT High cm	Turn Table deg	
MHz	dBuV/m	dBuV/m	dB	dBuV	dB				
1	2390.00	40.52	54.00	-13.48	43.32	-2.80	Average	101	141
2	2390.00	54.35	74.00	-19.65	57.15	-2.80	Peak	101	141
3	4824.00	36.60	54.00	-17.40	33.00	3.60	Average	100	130
4	4824.00	48.18	74.00	-25.82	44.58	3.60	Peak	100	130
5	12060.00	46.71	54.00	-7.29	32.86	13.85	Average	100	50
6	12060.00	59.71	74.00	-14.29	45.86	13.85	Peak	100	50

Note 1: Emission Level (dBuV/m) = SA Reading (dBuV/m) + Factor* (dB)
*Factor includes antenna factor , cable loss and amplifier gain
Note 2: Margin (dB) = Emission level (dBuV/m) – Limit (dBuV/m).

Modulation	11g	Test Freq. (MHz)	2412
Polarization	Vertical		

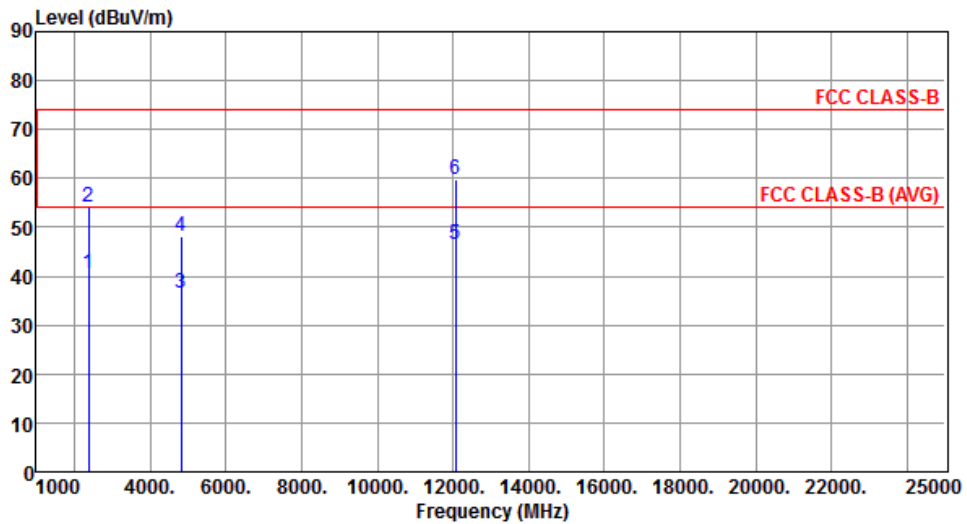

	Freq. MHz	Emission level dBuV/m	Limit dBuV/m	Margin dB	SA reading dBuV	Factor dB	Remark	ANT High cm	Turn Table deg
1	2390.00	40.41	54.00	-13.59	43.21	-2.80	Average	193	92
2	2390.00	54.28	74.00	-19.72	57.08	-2.80	Peak	193	92
3	4824.00	36.45	54.00	-17.55	32.85	3.60	Average	100	52
4	4824.00	48.09	74.00	-25.91	44.49	3.60	Peak	100	52
5	12060.00	46.65	54.00	-7.35	32.80	13.85	Average	100	61
6	12060.00	59.68	74.00	-14.32	45.83	13.85	Peak	100	61

Note 1: Emission Level (dBuV/m) = SA Reading (dBuV/m) + Factor* (dB)

*Factor includes antenna factor , cable loss and amplifier gain

Note 2: Margin (dB) = Emission level (dBuV/m) – Limit (dBuV/m).

Modulation	11g	Test Freq. (MHz)	2437
Polarization	Horizontal		

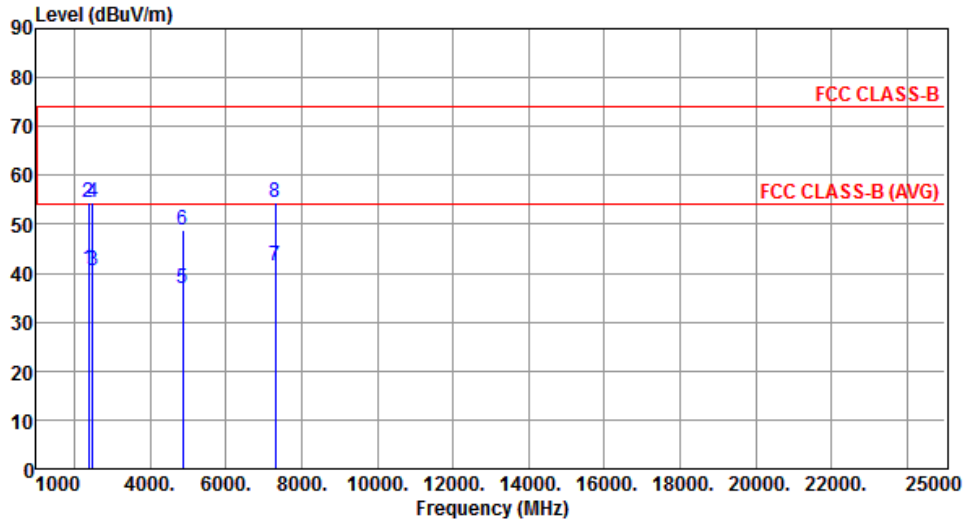

	Freq. MHz	Emission level dBuV/m	Limit dBuV/m	Margin dB	SA reading dBuV	Factor dB	Remark	ANT High cm	Turn Table deg
1	2390.00	40.80	54.00	-13.20	43.60	-2.80	Average	103	143
2	2390.00	54.36	74.00	-19.64	57.16	-2.80	Peak	103	143
3	2483.50	40.64	54.00	-13.36	43.67	-3.03	Average	103	143
4	2483.50	54.56	74.00	-19.44	57.59	-3.03	Peak	103	143
5	4874.00	36.73	54.00	-17.27	33.09	3.64	Average	100	135
6	4874.00	48.66	74.00	-25.34	45.02	3.64	Peak	100	135
7	7311.00	41.42	54.00	-12.58	32.15	9.27	Average	100	245
8	7311.00	54.43	74.00	-19.57	45.16	9.27	Peak	100	245

Note 1: Emission Level (dBuV/m) = SA Reading (dBuV/m) + Factor* (dB)

*Factor includes antenna factor , cable loss and amplifier gain

Note 2: Margin (dB) = Emission level (dBuV/m) – Limit (dBuV/m).

Modulation	11g	Test Freq. (MHz)	2437
Polarization	Vertical		

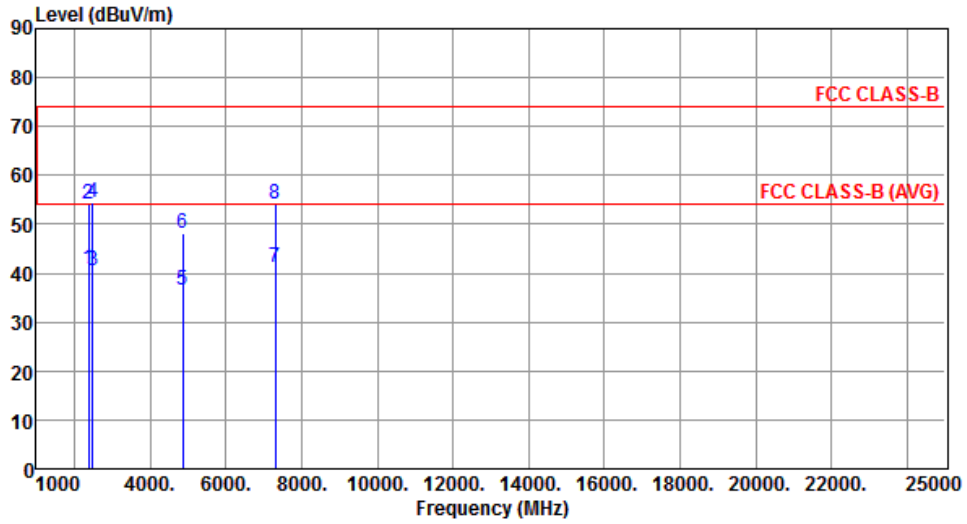

	Freq. MHz	Emission level dBuV/m	Limit dBuV/m	Margin dB	SA reading dBuV	Factor dB	Remark	ANT High cm	Turn Table deg
1	2390.00	40.75	54.00	-13.25	43.55	-2.80	Average	194	95
2	2390.00	54.27	74.00	-19.73	57.07	-2.80	Peak	194	95
3	2483.50	40.59	54.00	-13.41	43.62	-3.03	Average	194	95
4	2483.50	54.48	74.00	-19.52	57.51	-3.03	Peak	194	95
5	4874.00	36.63	54.00	-17.37	32.99	3.64	Average	100	20
6	4874.00	48.07	74.00	-25.93	44.43	3.64	Peak	100	20
7	7311.00	41.29	54.00	-12.71	32.02	9.27	Average	100	50
8	7311.00	54.20	74.00	-19.80	44.93	9.27	Peak	100	50

Note 1: Emission Level (dBuV/m) = SA Reading (dBuV/m) + Factor* (dB)

*Factor includes antenna factor , cable loss and amplifier gain

Note 2: Margin (dB) = Emission level (dBuV/m) – Limit (dBuV/m).

Modulation	11g	Test Freq. (MHz)	2462
Polarization	Horizontal		

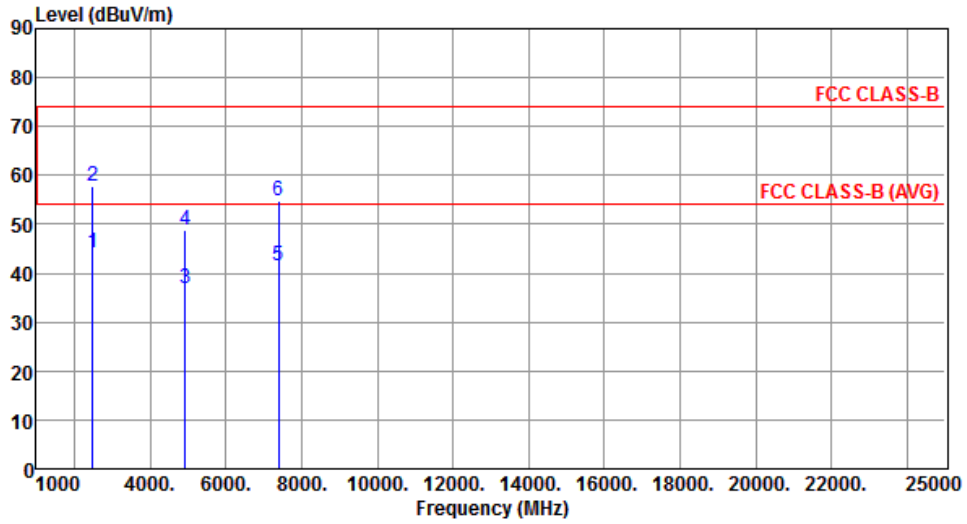

	Freq. MHz	Emission level dBuV/m	Limit dBuV/m	Margin dB	SA reading dBuV	Factor dB	Remark	ANT High cm	Turn Table deg
1	2483.50	44.02	54.00	-9.98	47.05	-3.03	Average	105	145
2	2483.50	57.86	74.00	-16.14	60.89	-3.03	Peak	105	145
3	4924.00	36.81	54.00	-17.19	33.12	3.69	Average	100	130
4	4924.00	48.98	74.00	-25.02	45.29	3.69	Peak	100	130
5	7386.00	41.38	54.00	-12.62	32.31	9.07	Average	100	240
6	7386.00	54.70	74.00	-19.30	45.63	9.07	Peak	100	240

Note 1: Emission Level (dBuV/m) = SA Reading (dBuV/m) + Factor* (dB)

*Factor includes antenna factor , cable loss and amplifier gain

Note 2: Margin (dB) = Emission level (dBuV/m) – Limit (dBuV/m).

Modulation	11g	Test Freq. (MHz)	2462
Polarization	Vertical		

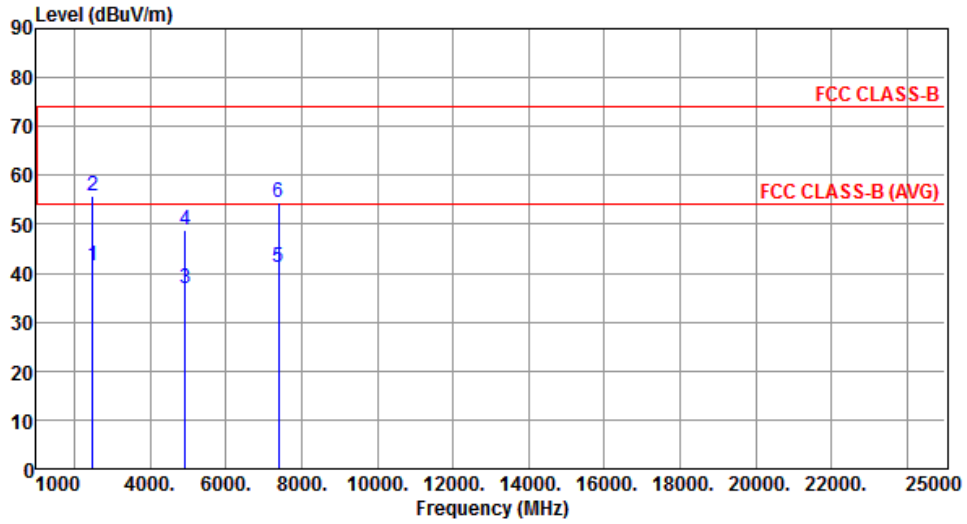

	Freq. MHz	Emission level dBuV/m	Limit dBuV/m	Margin dB	SA reading dBuV	Factor dB	Remark	ANT High cm	Turn Table deg
1	2483.50	41.55	54.00	-12.45	44.58	-3.03	Average	194	95
2	2483.50	55.81	74.00	-18.19	58.84	-3.03	Peak	194	95
3	4924.00	36.75	54.00	-17.25	33.06	3.69	Average	100	52
4	4924.00	48.81	74.00	-25.19	45.12	3.69	Peak	100	52
5	7386.00	41.33	54.00	-12.67	32.26	9.07	Average	100	47
6	7386.00	54.62	74.00	-19.38	45.55	9.07	Peak	100	47

Note 1: Emission Level (dBuV/m) = SA Reading (dBuV/m) + Factor* (dB)

*Factor includes antenna factor , cable loss and amplifier gain

Note 2: Margin (dB) = Emission level (dBuV/m) – Limit (dBuV/m).

3.5.7 Transmitter Radiated Unwanted Emissions (Above 1GHz) for HT20

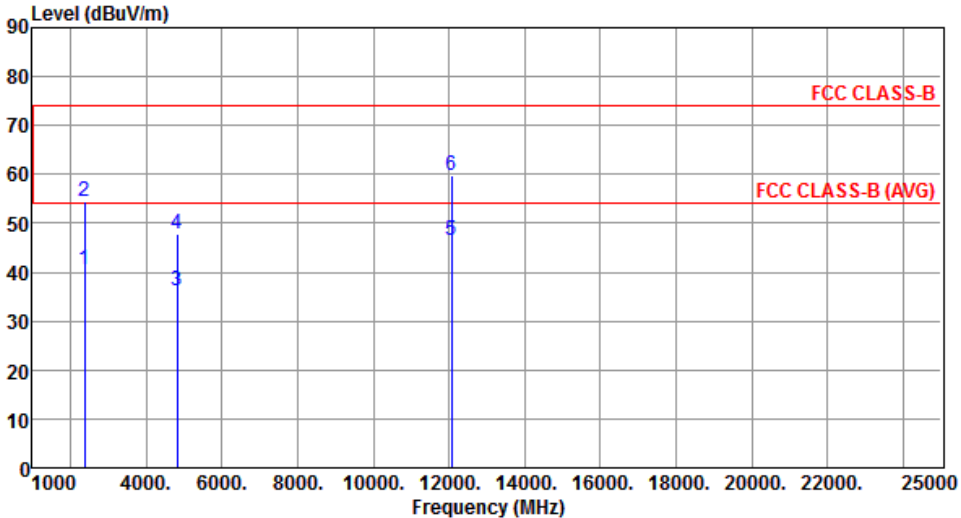
Modulation	HT20	Test Freq. (MHz)	2412						
Polarization	Horizontal								
									
	Freq. MHz	Emission level dBuV/m	Limit dBuV/m	Margin dB	SA reading dBuV	Factor dB	Remark	ANT High cm	Turn Table deg
1	2390.00	40.52	54.00	-13.48	43.32	-2.80	Average	100	147
2	2390.00	54.30	74.00	-19.70	57.10	-2.80	Peak	100	147
3	4824.00	36.17	54.00	-17.83	32.57	3.60	Average	100	40
4	4824.00	47.84	74.00	-26.16	44.24	3.60	Peak	100	40
5	12060.00	46.38	54.00	-7.62	32.53	13.85	Average	100	80
6	12060.00	59.77	74.00	-14.23	45.92	13.85	Peak	100	80

Note 1: Emission Level (dBuV/m) = SA Reading (dBuV/m) + Factor* (dB)
*Factor includes antenna factor , cable loss and amplifier gain
Note 2: Margin (dB) = Emission level (dBuV/m) – Limit (dBuV/m).

Modulation	HT20	Test Freq. (MHz)	2412
Polarization	Vertical		

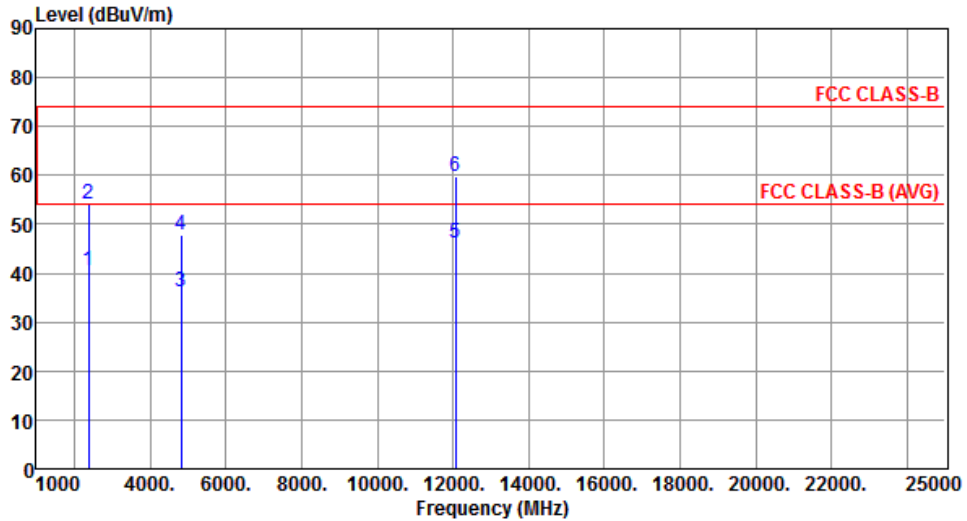

	Freq. MHz	Emission level dBuV/m	Limit dBuV/m	Margin dB	SA reading dBuV	Factor dB	Remark	ANT High cm	Turn Table deg
1	2390.00	40.39	54.00	-13.61	43.19	-2.80	Average	191	96
2	2390.00	54.21	74.00	-19.79	57.01	-2.80	Peak	191	96
3	4824.00	36.04	54.00	-17.96	32.44	3.60	Average	100	45
4	4824.00	47.69	74.00	-26.31	44.09	3.60	Peak	100	45
5	12060.00	46.27	54.00	-7.73	32.42	13.85	Average	100	72
6	12060.00	59.65	74.00	-14.35	45.80	13.85	Peak	100	72

Note 1: Emission Level (dBuV/m) = SA Reading (dBuV/m) + Factor* (dB)

*Factor includes antenna factor , cable loss and amplifier gain

Note 2: Margin (dB) = Emission level (dBuV/m) – Limit (dBuV/m).

Modulation	HT20	Test Freq. (MHz)	2437
Polarization	Horizontal		

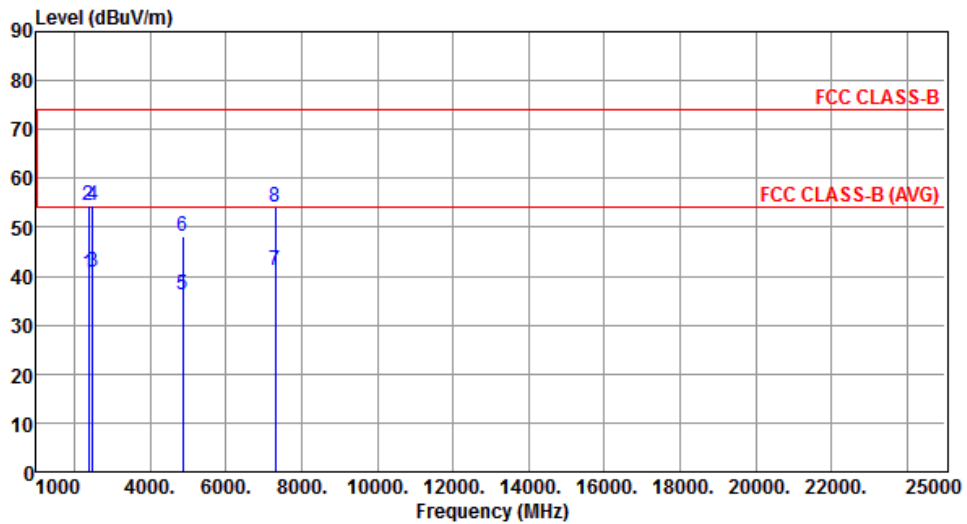

	Freq. MHz	Emission level dBuV/m	Limit dBuV/m	Margin dB	SA reading dBuV	Factor dB	Remark	ANT High cm	Turn Table deg
1	2390.00	40.59	54.00	-13.41	43.39	-2.80	Average	100	143
2	2390.00	54.50	74.00	-19.50	57.30	-2.80	Peak	100	143
3	2483.50	40.73	54.00	-13.27	43.76	-3.03	Average	100	143
4	2483.50	54.41	74.00	-19.59	57.44	-3.03	Peak	100	143
5	4874.00	36.05	54.00	-17.95	32.41	3.64	Average	100	20
6	4874.00	48.06	74.00	-25.94	44.42	3.64	Peak	100	20
7	7311.00	41.29	54.00	-12.71	32.02	9.27	Average	100	50
8	7311.00	54.29	74.00	-19.71	45.02	9.27	Peak	100	50

Note 1: Emission Level (dBuV/m) = SA Reading (dBuV/m) + Factor* (dB)

*Factor includes antenna factor , cable loss and amplifier gain

Note 2: Margin (dB) = Emission level (dBuV/m) – Limit (dBuV/m).

Modulation	HT20	Test Freq. (MHz)	2437
Polarization	Vertical		

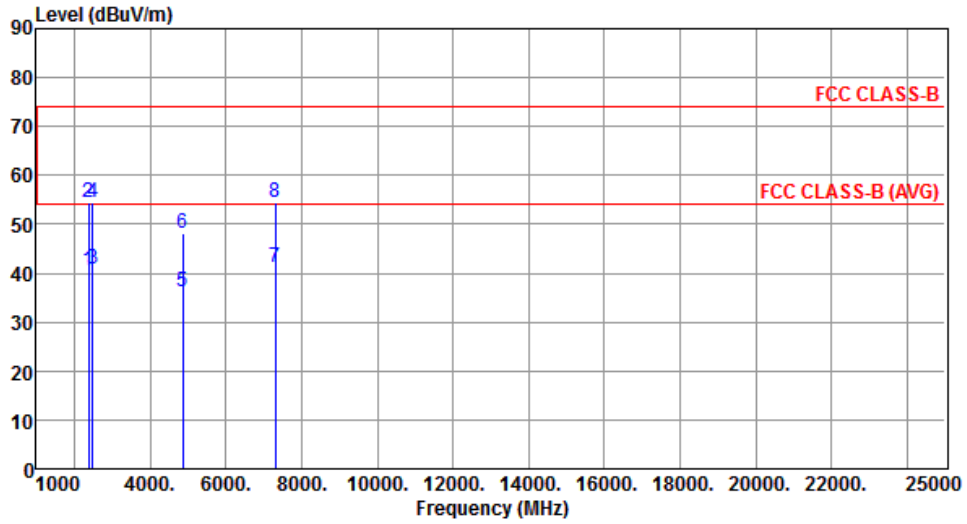

	Freq. MHz	Emission level dBuV/m	Limit dBuV/m	Margin dB	SA reading dBuV	Factor dB	Remark	ANT High cm	Turn Table deg
1	2390.00	40.48	54.00	-13.52	43.28	-2.80	Average	195	96
2	2390.00	54.36	74.00	-19.64	57.16	-2.80	Peak	195	96
3	2483.50	40.69	54.00	-13.31	43.72	-3.03	Average	195	96
4	2483.50	54.35	74.00	-19.65	57.38	-3.03	Peak	195	96
5	4874.00	36.21	54.00	-17.79	32.57	3.64	Average	100	33
6	4874.00	48.19	74.00	-25.81	44.55	3.64	Peak	100	33
7	7311.00	41.28	54.00	-12.72	32.01	9.27	Average	100	62
8	7311.00	54.31	74.00	-19.69	45.04	9.27	Peak	100	62

Note 1: Emission Level (dBuV/m) = SA Reading (dBuV/m) + Factor* (dB)

*Factor includes antenna factor , cable loss and amplifier gain

Note 2: Margin (dB) = Emission level (dBuV/m) – Limit (dBuV/m).

Modulation	HT20	Test Freq. (MHz)	2462
Polarization	Horizontal		

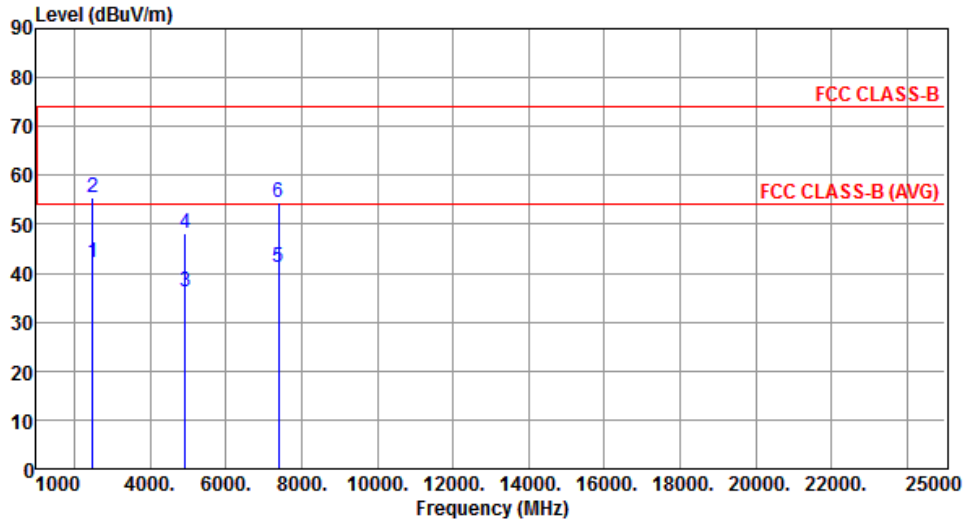

	Freq. MHz	Emission level dBuV/m	Limit dBuV/m	Margin dB	SA reading dBuV	Factor dB	Remark	ANT High cm	Turn Table deg
1	2483.50	42.16	54.00	-11.84	45.19	-3.03	Average	100	145
2	2483.50	55.52	74.00	-18.48	58.55	-3.03	Peak	100	145
3	4924.00	36.09	54.00	-17.91	32.40	3.69	Average	100	50
4	4924.00	48.13	74.00	-25.87	44.44	3.69	Peak	100	50
5	7386.00	41.29	54.00	-12.71	32.22	9.07	Average	100	40
6	7386.00	54.45	74.00	-19.55	45.38	9.07	Peak	100	40

Note 1: Emission Level (dBuV/m) = SA Reading (dBuV/m) + Factor* (dB)

*Factor includes antenna factor , cable loss and amplifier gain

Note 2: Margin (dB) = Emission level (dBuV/m) – Limit (dBuV/m).

Modulation	HT20	Test Freq. (MHz)	2462
Polarization	Vertical		

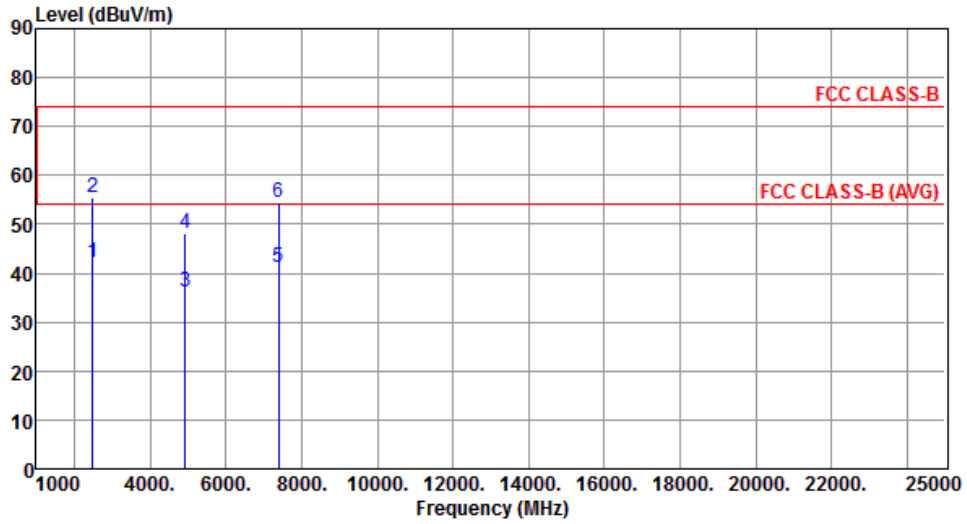

	Freq. MHz	Emission level dBuV/m	Limit dBuV/m	Margin dB	SA reading dBuV	Factor dB	Remark	ANT High cm	Turn Table deg
1	2483.50	42.13	54.00	-11.87	45.16	-3.03	Average	191	93
2	2483.50	55.41	74.00	-18.59	58.44	-3.03	Peak	191	93
3	4924.00	36.15	54.00	-17.85	32.46	3.69	Average	100	44
4	4924.00	48.21	74.00	-25.79	44.52	3.69	Peak	100	44
5	7386.00	41.25	54.00	-12.75	32.18	9.07	Average	100	93
6	7386.00	54.41	74.00	-19.59	45.34	9.07	Peak	100	93

Note 1: Emission Level (dBuV/m) = SA Reading (dBuV/m) + Factor* (dB)

*Factor includes antenna factor , cable loss and amplifier gain

Note 2: Margin (dB) = Emission level (dBuV/m) – Limit (dBuV/m).

3.5.8 Transmitter Radiated Unwanted Emissions (Above 1GHz) for HT40

Modulation	HT40	Test Freq. (MHz)	2422
Polarization	Horizontal		

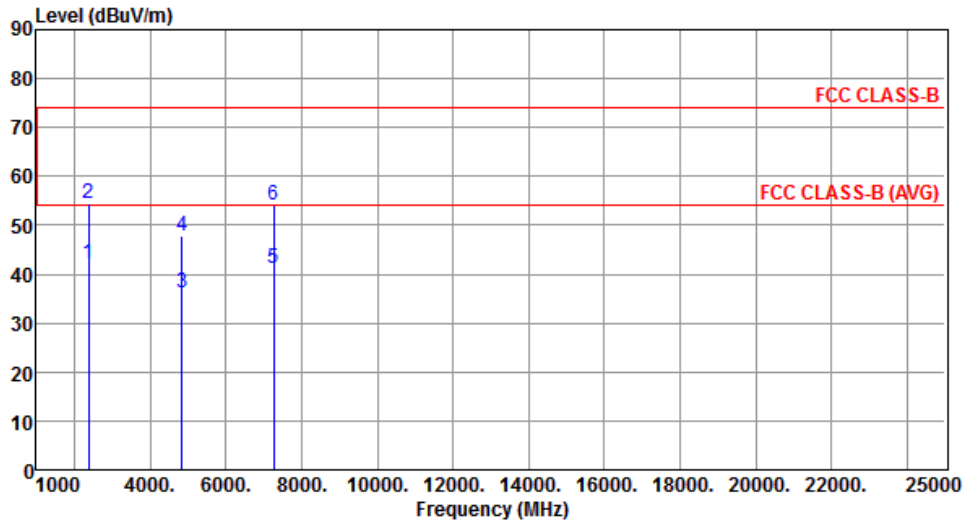

	Freq. MHz	Emission level dBuV/m	Limit dBuV/m	Margin dB	SA reading dBuV	Factor dB	Remark	ANT High cm	Turn Table deg
1	2390.00	42.19	54.00	-11.81	44.99	-2.80	Average	100	145
2	2390.00	54.45	74.00	-19.55	57.25	-2.80	Peak	100	145
3	4844.00	36.12	54.00	-17.88	32.47	3.65	Average	100	40
4	4844.00	47.79	74.00	-26.21	44.14	3.65	Peak	100	40
5	7266.00	41.06	54.00	-12.94	31.73	9.33	Average	100	30
6	7266.00	54.15	74.00	-19.85	44.82	9.33	Peak	100	30

Note 1: Emission Level (dBuV/m) = SA Reading (dBuV/m) + Factor* (dB)

*Factor includes antenna factor , cable loss and amplifier gain

Note 2: Margin (dB) = Emission level (dBuV/m) – Limit (dBuV/m).

Modulation	HT40	Test Freq. (MHz)	2422
Polarization	Vertical		

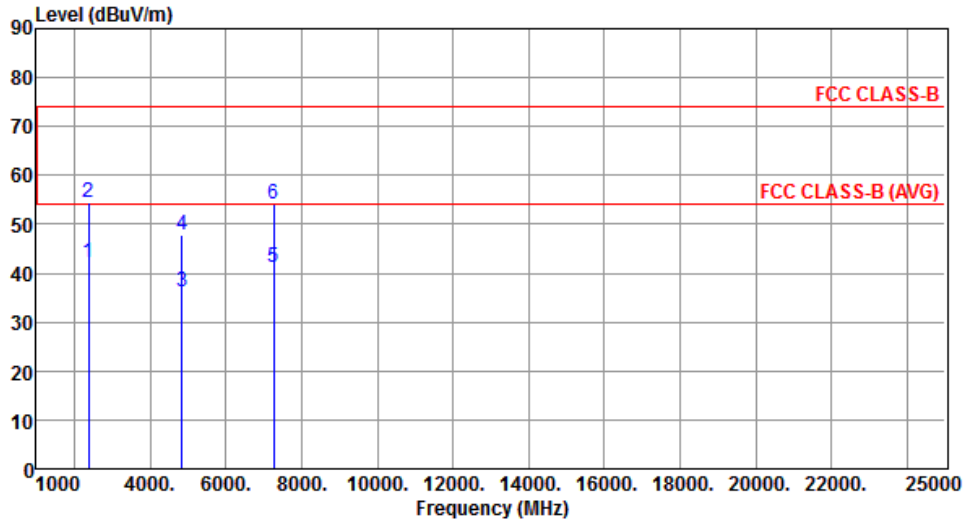

	Freq. MHz	Emission level dBuV/m	Limit dBuV/m	Margin dB	SA reading dBuV	Factor dB	Remark	ANT High cm	Turn Table deg
1	2390.00	42.15	54.00	-11.85	44.95	-2.80	Average	195	88
2	2390.00	54.36	74.00	-19.64	57.16	-2.80	Peak	195	88
3	4844.00	36.05	54.00	-17.95	32.40	3.65	Average	100	47
4	4844.00	47.68	74.00	-26.32	44.03	3.65	Peak	100	47
5	7266.00	41.02	54.00	-12.98	31.69	9.33	Average	100	51
6	7266.00	54.13	74.00	-19.87	44.80	9.33	Peak	100	51

Note 1: Emission Level (dBuV/m) = SA Reading (dBuV/m) + Factor* (dB)

*Factor includes antenna factor , cable loss and amplifier gain

Note 2: Margin (dB) = Emission level (dBuV/m) – Limit (dBuV/m).

Modulation	HT40	Test Freq. (MHz)	2437
Polarization	Horizontal		

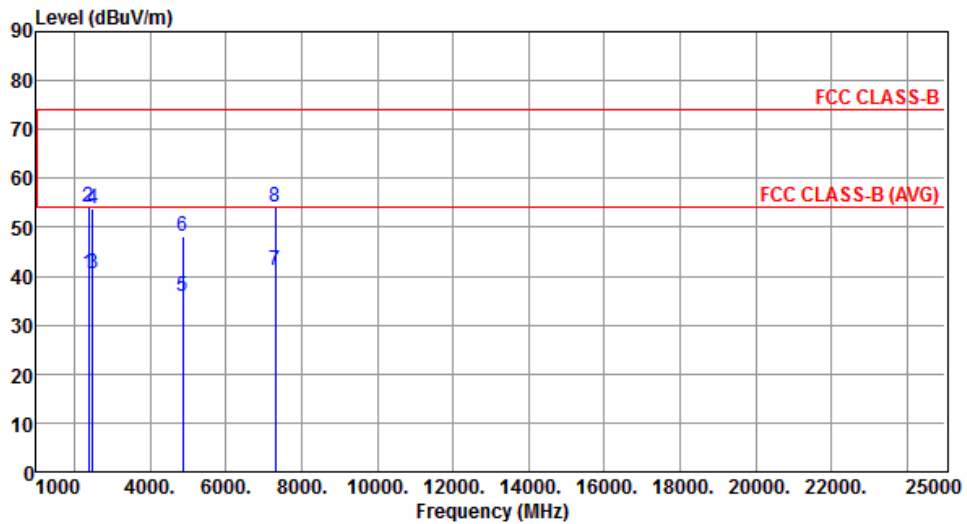

	Freq. MHz	Emission level dBuV/m	Limit dBuV/m	Margin dB	SA reading dBuV	Factor dB	Remark	ANT High cm	Turn Table deg
1	2390.00	40.50	54.00	-13.50	43.30	-2.80	Average	100	142
2	2390.00	54.09	74.00	-19.91	56.89	-2.80	Peak	100	142
3	2483.50	40.41	54.00	-13.59	43.44	-3.03	Average	100	142
4	2483.50	53.95	74.00	-20.05	56.98	-3.03	Peak	100	142
5	4874.00	35.73	54.00	-18.27	32.09	3.64	Average	100	30
6	4874.00	48.02	74.00	-25.98	44.38	3.64	Peak	100	30
7	7311.00	41.20	54.00	-12.80	31.93	9.27	Average	100	60
8	7311.00	54.29	74.00	-19.71	45.02	9.27	Peak	100	60

Note 1: Emission Level (dBuV/m) = SA Reading (dBuV/m) + Factor* (dB)

*Factor includes antenna factor , cable loss and amplifier gain

Note 2: Margin (dB) = Emission level (dBuV/m) – Limit (dBuV/m).

Modulation	HT40	Test Freq. (MHz)	2437
Polarization	Vertical		

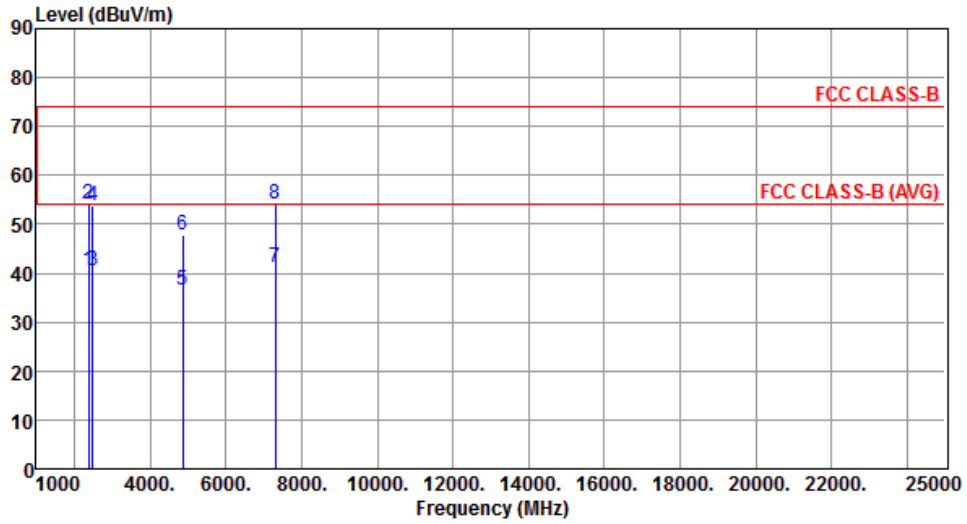

	Freq. MHz	Emission level dBuV/m	Limit dBuV/m	Margin dB	SA reading dBuV	Factor dB	Remark	ANT High cm	Turn Table deg
1	2390.00	40.42	54.00	-13.58	43.22	-2.80	Average	193	94
2	2390.00	54.06	74.00	-19.94	56.86	-2.80	Peak	193	94
3	2483.50	40.39	54.00	-13.61	43.42	-3.03	Average	193	94
4	2483.50	53.82	74.00	-20.18	56.85	-3.03	Peak	193	94
5	4874.00	36.52	54.00	-17.48	32.88	3.64	Average	100	35
6	4874.00	47.95	74.00	-26.05	44.31	3.64	Peak	100	35
7	7311.00	41.15	54.00	-12.85	31.88	9.27	Average	100	62
8	7311.00	54.21	74.00	-19.79	44.94	9.27	Peak	100	62

Note 1: Emission Level (dBuV/m) = SA Reading (dBuV/m) + Factor* (dB)

*Factor includes antenna factor , cable loss and amplifier gain

Note 2: Margin (dB) = Emission level (dBuV/m) – Limit (dBuV/m).

Modulation	HT40	Test Freq. (MHz)	2452
Polarization	Horizontal		

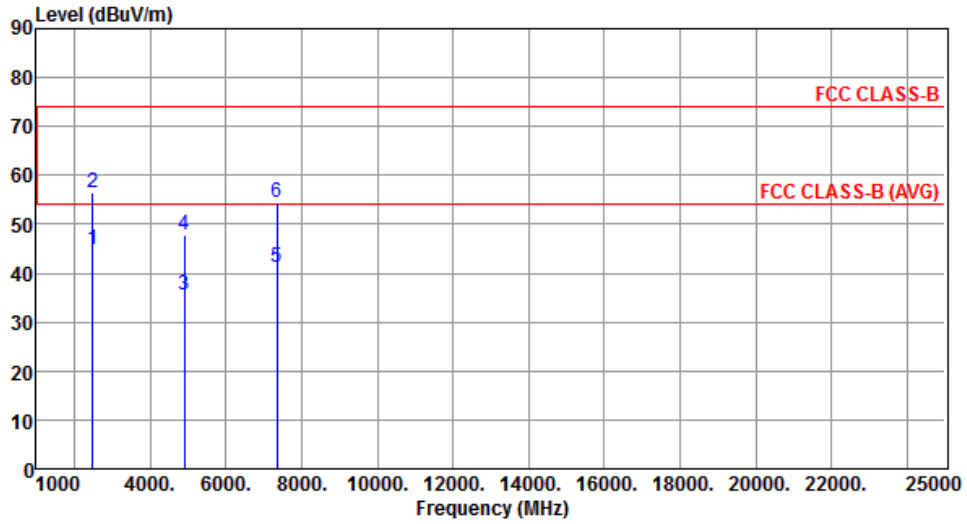

	Freq. MHz	Emission level dBuV/m	Limit dBuV/m	Margin dB	SA reading dBuV	Factor dB	Remark	ANT High cm	Turn Table deg
1	2483.50	44.91	54.00	-9.09	47.94	-3.03	Average	100	180
2	2483.50	56.37	74.00	-17.63	59.40	-3.03	Peak	100	180
3	4904.00	35.56	54.00	-18.44	31.93	3.63	Average	100	20
4	4904.00	47.77	74.00	-26.23	44.14	3.63	Peak	100	20
5	7356.00	41.18	54.00	-12.82	32.10	9.08	Average	100	60
6	7356.00	54.37	74.00	-19.63	45.29	9.08	Peak	100	60

Note 1: Emission Level (dBuV/m) = SA Reading (dBuV/m) + Factor* (dB)

*Factor includes antenna factor , cable loss and amplifier gain

Note 2: Margin (dB) = Emission level (dBuV/m) – Limit (dBuV/m).

Modulation	HT40	Test Freq. (MHz)	2452
Polarization	Vertical		

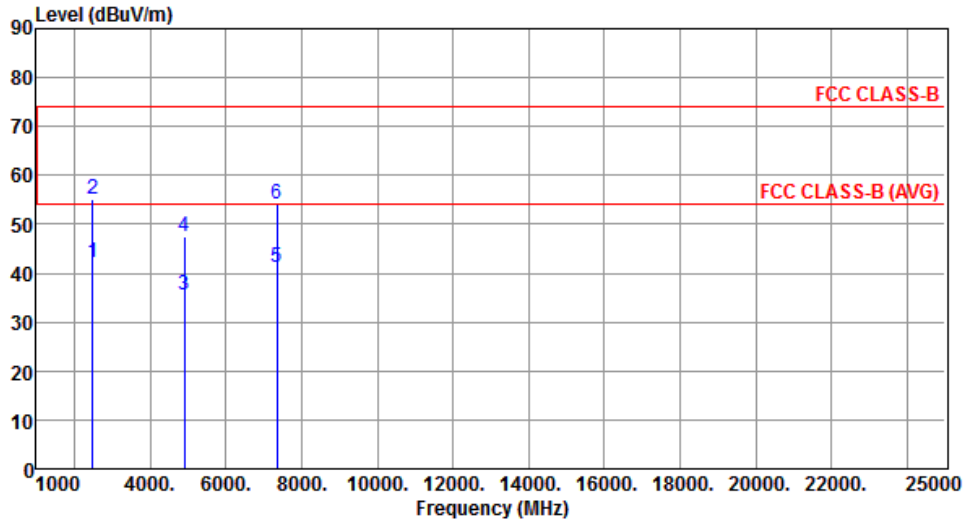

	Freq. MHz	Emission level dBuV/m	Limit dBuV/m	Margin dB	SA reading dBuV	Factor dB	Remark	ANT High cm	Turn Table deg
1	2483.50	42.26	54.00	-11.74	45.29	-3.03	Average	194	98
2	2483.50	55.24	74.00	-18.76	58.27	-3.03	Peak	194	98
3	4904.00	35.46	54.00	-18.54	31.83	3.63	Average	100	22
4	4904.00	47.61	74.00	-26.39	43.98	3.63	Peak	100	22
5	7356.00	41.14	54.00	-12.86	32.06	9.08	Average	100	17
6	7356.00	54.25	74.00	-19.75	45.17	9.08	Peak	100	17

Note 1: Emission Level (dBuV/m) = SA Reading (dBuV/m) + Factor* (dB)

*Factor includes antenna factor , cable loss and amplifier gain

Note 2: Margin (dB) = Emission level (dBuV/m) – Limit (dBuV/m).

3.5.9 Transmitter Radiated Unwanted Emissions (Above 1GHz) for ax HE20

Modulation	ax HE20	Test Freq. (MHz)	2412
Polarization	Horizontal		

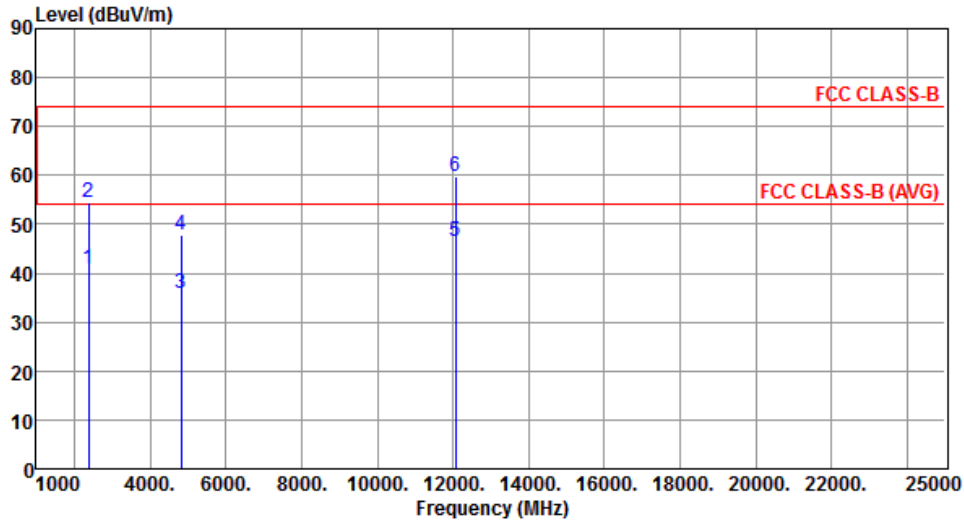

	Freq. MHz	Emission level dBuV/m	Limit dBuV/m	Margin dB	SA reading dBuV	Factor dB	Remark	ANT High cm	Turn Table deg
1	2390.00	40.82	54.00	-13.18	43.62	-2.80	Average	100	144
2	2390.00	54.53	74.00	-19.47	57.33	-2.80	Peak	100	144
3	4824.00	35.85	54.00	-18.15	32.25	3.60	Average	100	30
4	4824.00	47.74	74.00	-26.26	44.14	3.60	Peak	100	30
5	12060.00	46.51	54.00	-7.49	32.66	13.85	Average	100	20
6	12060.00	59.69	74.00	-14.31	45.84	13.85	Peak	100	20

Note 1: Emission Level (dBuV/m) = SA Reading (dBuV/m) + Factor* (dB)

*Factor includes antenna factor , cable loss and amplifier gain

Note 2: Margin (dB) = Emission level (dBuV/m) – Limit (dBuV/m).

Modulation	ax HE20	Test Freq. (MHz)	2412
Polarization	Vertical		

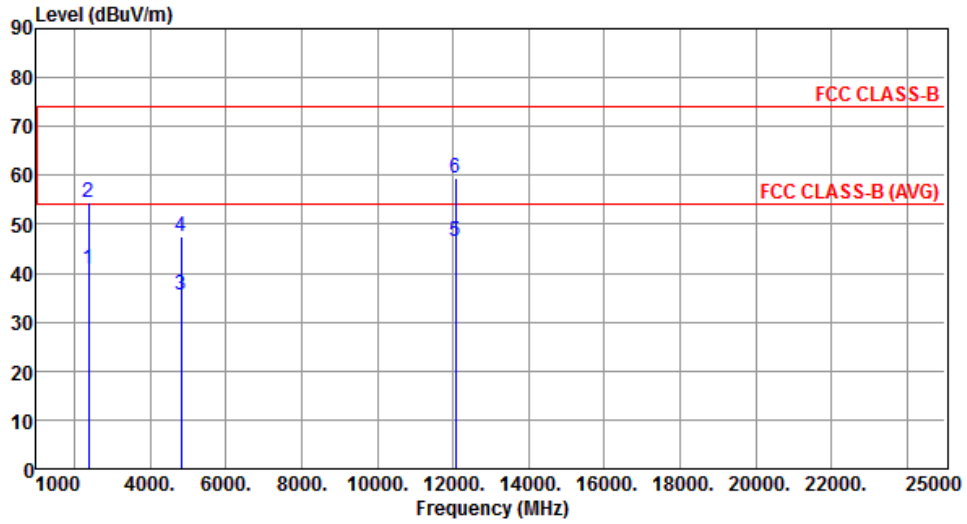

	Freq. MHz	Emission level dBuV/m	Limit dBuV/m	Margin dB	SA reading dBuV	Factor dB	Remark	ANT High cm	Turn Table deg
1	2390.00	40.76	54.00	-13.24	43.56	-2.80	Average	196	97
2	2390.00	54.41	74.00	-19.59	57.21	-2.80	Peak	196	97
3	4824.00	35.56	54.00	-18.44	31.96	3.60	Average	100	41
4	4824.00	47.62	74.00	-26.38	44.02	3.60	Peak	100	41
5	12060.00	46.35	54.00	-7.65	32.50	13.85	Average	100	55
6	12060.00	59.58	74.00	-14.42	45.73	13.85	Peak	100	55

Note 1: Emission Level (dBuV/m) = SA Reading (dBuV/m) + Factor* (dB)

*Factor includes antenna factor , cable loss and amplifier gain

Note 2: Margin (dB) = Emission level (dBuV/m) – Limit (dBuV/m).

Modulation	ax HE20	Test Freq. (MHz)	2437
Polarization	Horizontal		

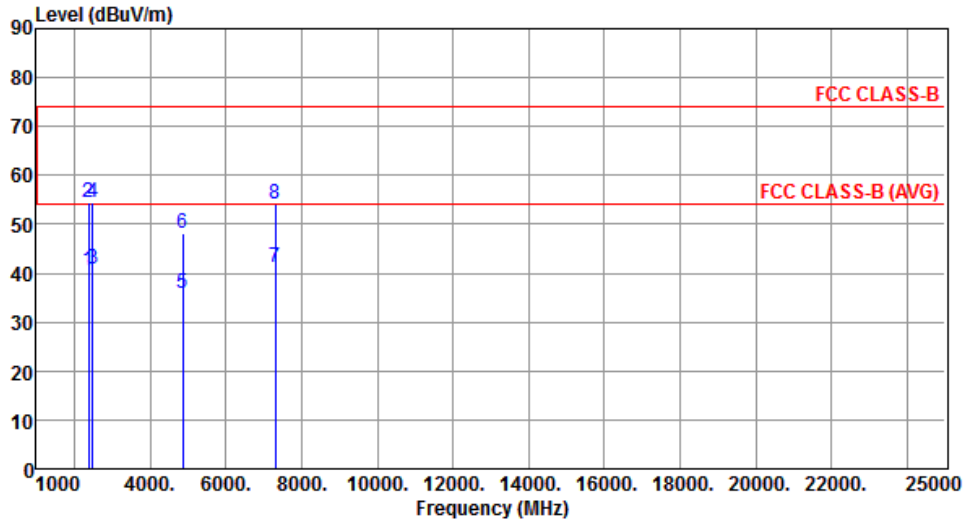

	Freq. MHz	Emission level dBuV/m	Limit dBuV/m	Margin dB	SA reading dBuV	Factor dB	Remark	ANT High cm	Turn Table deg
1	2390.00	40.50	54.00	-13.50	43.30	-2.80	Average	100	141
2	2390.00	54.30	74.00	-19.70	57.10	-2.80	Peak	100	141
3	2483.50	40.80	54.00	-13.20	43.83	-3.03	Average	100	141
4	2483.50	54.52	74.00	-19.48	57.55	-3.03	Peak	100	141
5	4874.00	35.96	54.00	-18.04	32.32	3.64	Average	100	70
6	4874.00	48.02	74.00	-25.98	44.38	3.64	Peak	100	70
7	7311.00	41.23	54.00	-12.77	31.96	9.27	Average	100	25
8	7311.00	54.18	74.00	-19.82	44.91	9.27	Peak	100	25

Note 1: Emission Level (dBuV/m) = SA Reading (dBuV/m) + Factor* (dB)

*Factor includes antenna factor , cable loss and amplifier gain

Note 2: Margin (dB) = Emission level (dBuV/m) – Limit (dBuV/m).

Modulation	ax HE20	Test Freq. (MHz)	2437
Polarization	Vertical		

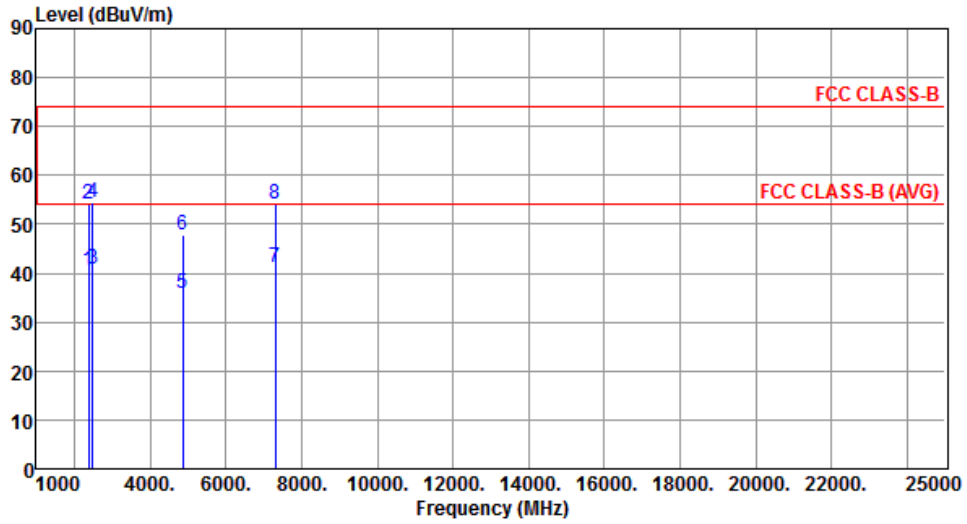

	Freq. MHz	Emission level dBuV/m	Limit dBuV/m	Margin dB	SA reading dBuV	Factor dB	Remark	ANT High cm	Turn Table deg
1	2390.00	40.38	54.00	-13.62	43.18	-2.80	Average	191	94
2	2390.00	54.16	74.00	-19.84	56.96	-2.80	Peak	191	94
3	2483.50	40.75	54.00	-13.25	43.78	-3.03	Average	191	94
4	2483.50	54.45	74.00	-19.55	57.48	-3.03	Peak	191	94
5	4874.00	35.81	54.00	-18.19	32.17	3.64	Average	100	69
6	4874.00	47.94	74.00	-26.06	44.30	3.64	Peak	100	69
7	7311.00	41.15	54.00	-12.85	31.88	9.27	Average	100	77
8	7311.00	54.03	74.00	-19.97	44.76	9.27	Peak	100	77

Note 1: Emission Level (dBuV/m) = SA Reading (dBuV/m) + Factor* (dB)

*Factor includes antenna factor , cable loss and amplifier gain

Note 2: Margin (dB) = Emission level (dBuV/m) – Limit (dBuV/m).

Modulation	ax HE20	Test Freq. (MHz)	2462
Polarization	Horizontal		

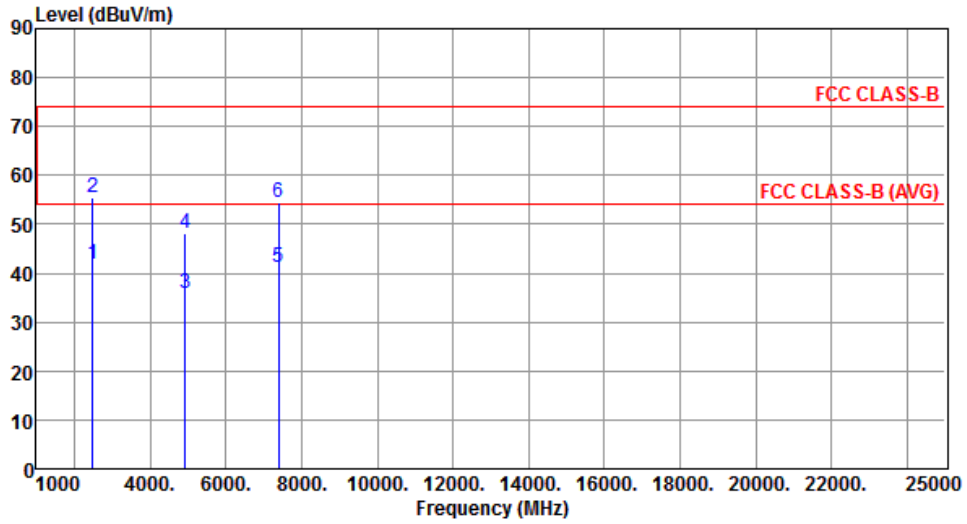

	Freq. MHz	Emission level dBuV/m	Limit dBuV/m	Margin dB	SA reading dBuV	Factor dB	Remark	ANT High cm	Turn Table deg
1	2483.50	41.79	54.00	-12.21	44.82	-3.03	Average	100	142
2	2483.50	55.49	74.00	-18.51	58.52	-3.03	Peak	100	142
3	4924.00	35.89	54.00	-18.11	32.20	3.69	Average	100	20
4	4924.00	48.04	74.00	-25.96	44.35	3.69	Peak	100	20
5	7386.00	41.18	54.00	-12.82	32.11	9.07	Average	100	60
6	7386.00	54.35	74.00	-19.65	45.28	9.07	Peak	100	60

Note 1: Emission Level (dBuV/m) = SA Reading (dBuV/m) + Factor* (dB)

*Factor includes antenna factor , cable loss and amplifier gain

Note 2: Margin (dB) = Emission level (dBuV/m) – Limit (dBuV/m).

Modulation	ax HE20	Test Freq. (MHz)	2462
Polarization	Vertical		

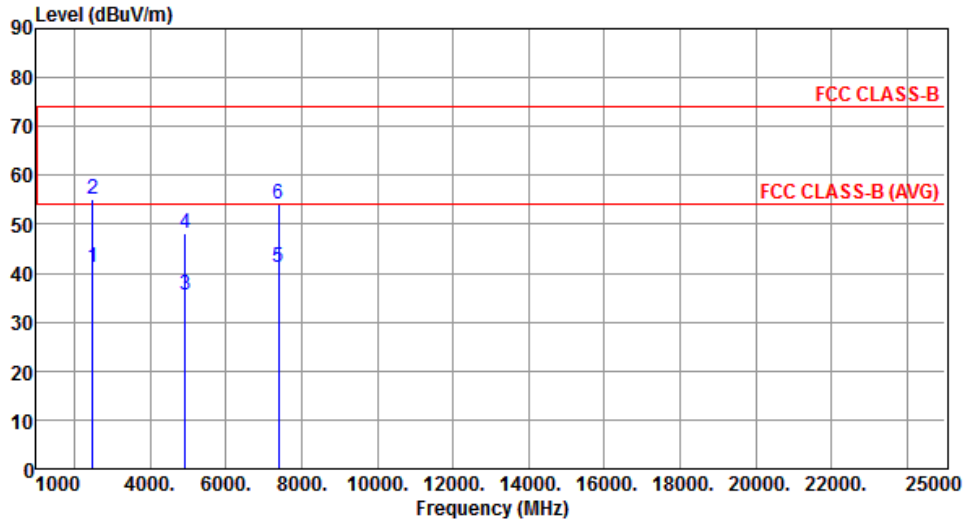

	Freq. MHz	Emission level dBuV/m	Limit dBuV/m	Margin dB	SA reading dBuV	Factor dB	Remark	ANT High cm	Turn Table deg
1	2483.50	41.22	54.00	-12.78	44.25	-3.03	Average	192	93
2	2483.50	55.16	74.00	-18.84	58.19	-3.03	Peak	192	93
3	4924.00	35.62	54.00	-18.38	31.93	3.69	Average	100	47
4	4924.00	48.11	74.00	-25.89	44.42	3.69	Peak	100	47
5	7386.00	41.15	54.00	-12.85	32.08	9.07	Average	100	47
6	7386.00	54.29	74.00	-19.71	45.22	9.07	Peak	100	47

Note 1: Emission Level (dBuV/m) = SA Reading (dBuV/m) + Factor* (dB)

*Factor includes antenna factor , cable loss and amplifier gain

Note 2: Margin (dB) = Emission level (dBuV/m) – Limit (dBuV/m).

3.5.10 Transmitter Radiated Unwanted Emissions (Above 1GHz) for ax HE40

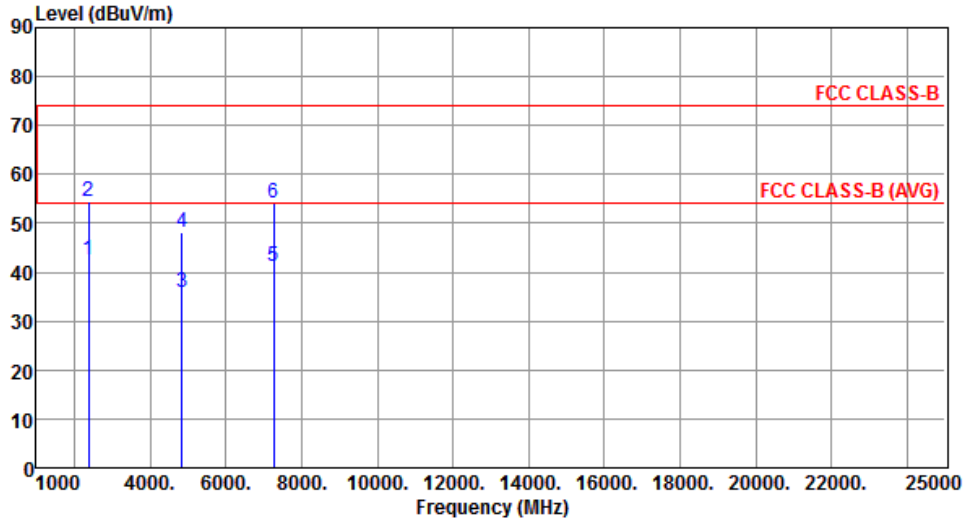
Modulation	ax HE40	Test Freq. (MHz)	2422						
Polarization	Horizontal								
									
	Freq.	Emission level	Limit	Margin	SA reading	Factor	Remark	ANT High	Turn Table
	MHz	dBuV/m	dBuV/m	dB	dBuV	dB		cm	deg
1	2390.00	42.36	54.00	-11.64	45.16	-2.80	Average	100	144
2	2390.00	54.57	74.00	-19.43	57.37	-2.80	Peak	100	144
3	4844.00	35.71	54.00	-18.29	32.06	3.65	Average	100	30
4	4844.00	48.12	74.00	-25.88	44.47	3.65	Peak	100	30
5	7266.00	41.07	54.00	-12.93	31.74	9.33	Average	100	40
6	7266.00	54.22	74.00	-19.78	44.89	9.33	Peak	100	40
<p>Note 1: Emission Level (dBuV/m) = SA Reading (dBuV/m) + Factor* (dB) *Factor includes antenna factor , cable loss and amplifier gain</p> <p>Note 2: Margin (dB) = Emission level (dBuV/m) – Limit (dBuV/m).</p>									

Modulation	ax HE40	Test Freq. (MHz)	2422
Polarization	Vertical		

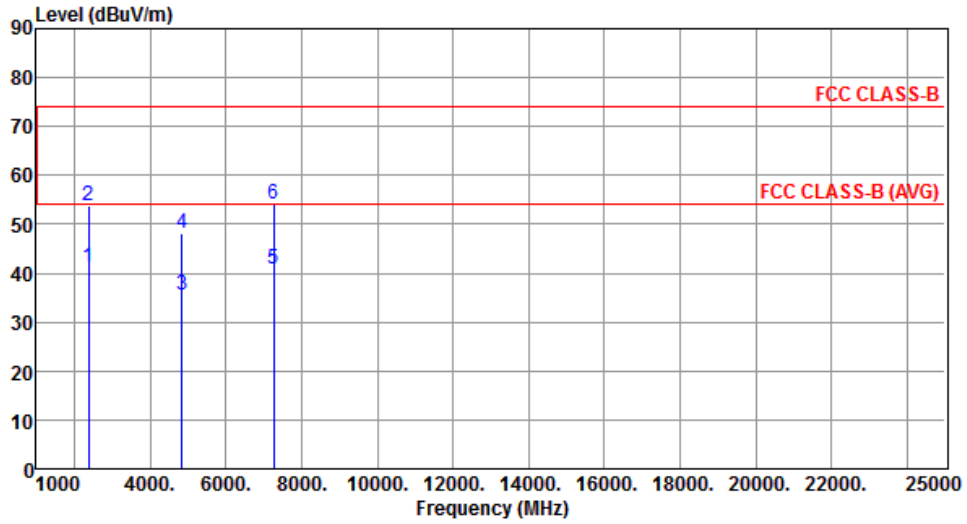

	Freq. MHz	Emission level dBuV/m	Limit dBuV/m	Margin dB	SA reading dBuV	Factor dB	Remark	ANT High cm	Turn Table deg
1	2390.00	41.18	54.00	-12.82	43.98	-2.80	Average	265	110
2	2390.00	53.80	74.00	-20.20	56.60	-2.80	Peak	265	110
3	4844.00	35.62	54.00	-18.38	31.97	3.65	Average	100	47
4	4844.00	48.03	74.00	-25.97	44.38	3.65	Peak	100	47
5	7266.00	40.96	54.00	-13.04	31.63	9.33	Average	100	66
6	7266.00	54.15	74.00	-19.85	44.82	9.33	Peak	100	66

Note 1: Emission Level (dBuV/m) = SA Reading (dBuV/m) + Factor* (dB)

*Factor includes antenna factor , cable loss and amplifier gain

Note 2: Margin (dB) = Emission level (dBuV/m) – Limit (dBuV/m).

Modulation	ax HE40	Test Freq. (MHz)	2437
Polarization	Horizontal		

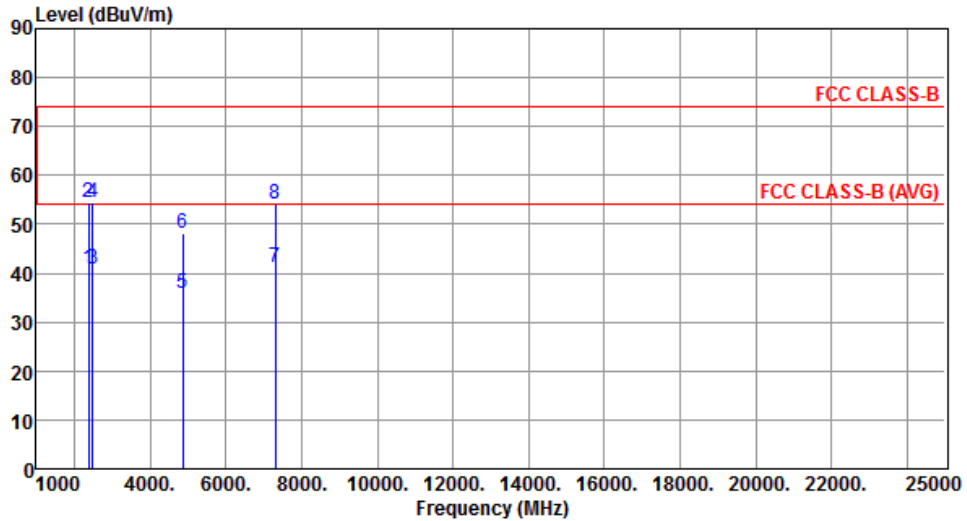

	Freq. MHz	Emission level dBuV/m	Limit dBuV/m	Margin dB	SA reading dBuV	Factor dB	Remark	ANT High cm	Turn Table deg
1	2390.00	40.83	54.00	-13.17	43.63	-2.80	Average	100	145
2	2390.00	54.49	74.00	-19.51	57.29	-2.80	Peak	100	145
3	2483.50	40.85	54.00	-13.15	43.88	-3.03	Average	100	145
4	2483.50	54.45	74.00	-19.55	57.48	-3.03	Peak	100	145
5	4874.00	35.73	54.00	-18.27	32.09	3.64	Average	100	30
6	4874.00	48.05	74.00	-25.95	44.41	3.64	Peak	100	30
7	7311.00	41.28	54.00	-12.72	32.01	9.27	Average	100	50
8	7311.00	54.25	74.00	-19.75	44.98	9.27	Peak	100	50

Note 1: Emission Level (dBuV/m) = SA Reading (dBuV/m) + Factor* (dB)

*Factor includes antenna factor , cable loss and amplifier gain

Note 2: Margin (dB) = Emission level (dBuV/m) – Limit (dBuV/m).

Modulation	ax HE40	Test Freq. (MHz)	2437
Polarization	Vertical		

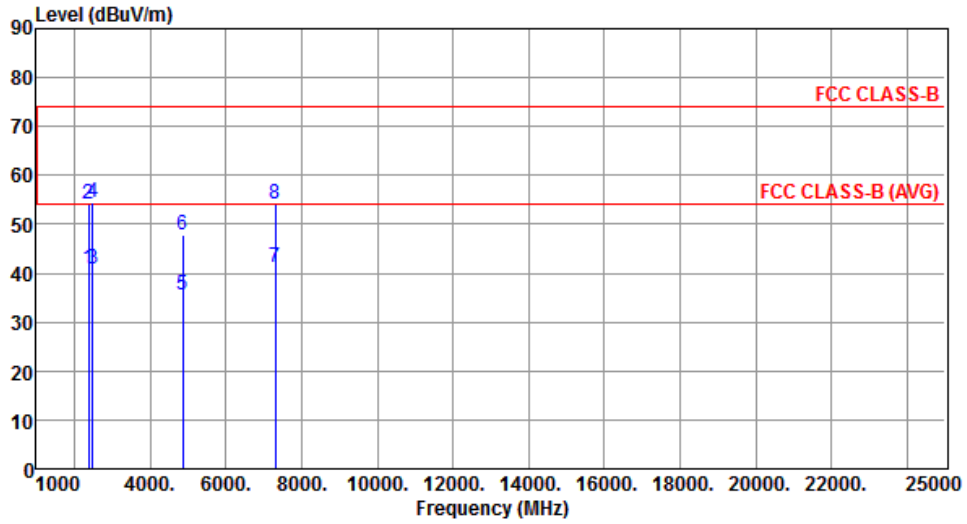

	Freq. MHz	Emission level dBuV/m	Limit dBuV/m	Margin dB	SA reading dBuV	Factor dB	Remark	ANT High cm	Turn Table deg
1	2390.00	40.71	54.00	-13.29	43.51	-2.80	Average	195	91
2	2390.00	54.28	74.00	-19.72	57.08	-2.80	Peak	195	91
3	2483.50	40.81	54.00	-13.19	43.84	-3.03	Average	195	91
4	2483.50	54.36	74.00	-19.64	57.39	-3.03	Peak	195	91
5	4874.00	35.61	54.00	-18.39	31.97	3.64	Average	100	27
6	4874.00	47.92	74.00	-26.08	44.28	3.64	Peak	100	27
7	7311.00	41.16	54.00	-12.84	31.89	9.27	Average	100	52
8	7311.00	54.19	74.00	-19.81	44.92	9.27	Peak	100	52

Note 1: Emission Level (dBuV/m) = SA Reading (dBuV/m) + Factor* (dB)

*Factor includes antenna factor , cable loss and amplifier gain

Note 2: Margin (dB) = Emission level (dBuV/m) – Limit (dBuV/m).

Modulation	ax HE40	Test Freq. (MHz)	2452
Polarization	Horizontal		

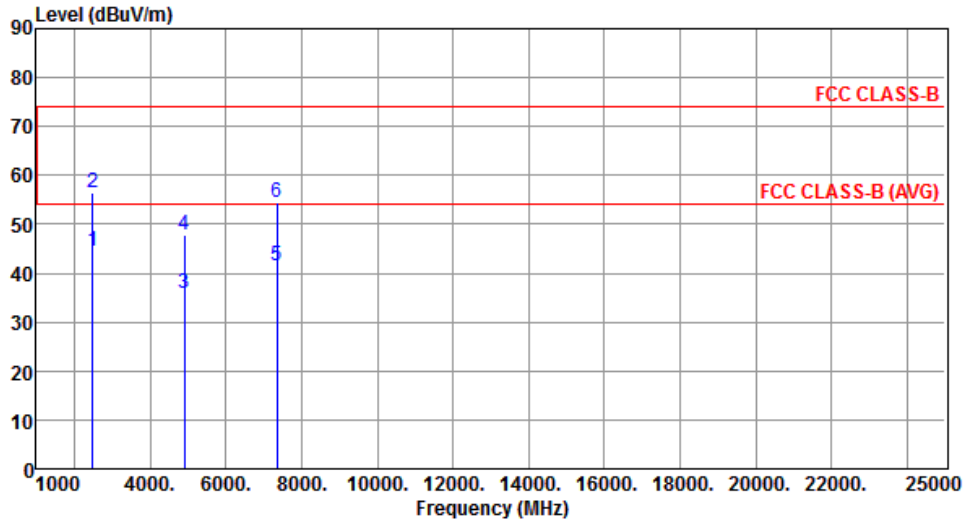

	Freq. MHz	Emission level dBuV/m	Limit dBuV/m	Margin dB	SA reading dBuV	Factor dB	Remark	ANT High cm	Turn Table deg
1	2483.50	44.52	54.00	-9.48	47.55	-3.03	Average	100	177
2	2483.50	56.42	74.00	-17.58	59.45	-3.03	Peak	100	177
3	4904.00	35.77	54.00	-18.23	32.14	3.63	Average	100	70
4	4904.00	47.98	74.00	-26.02	44.35	3.63	Peak	100	70
5	7356.00	41.37	54.00	-12.63	32.29	9.08	Average	100	50
6	7356.00	54.38	74.00	-19.62	45.30	9.08	Peak	100	50

Note 1: Emission Level (dBuV/m) = SA Reading (dBuV/m) + Factor* (dB)

*Factor includes antenna factor , cable loss and amplifier gain

Note 2: Margin (dB) = Emission level (dBuV/m) – Limit (dBuV/m).

Modulation	ax HE40	Test Freq. (MHz)	2452
Polarization	Vertical		

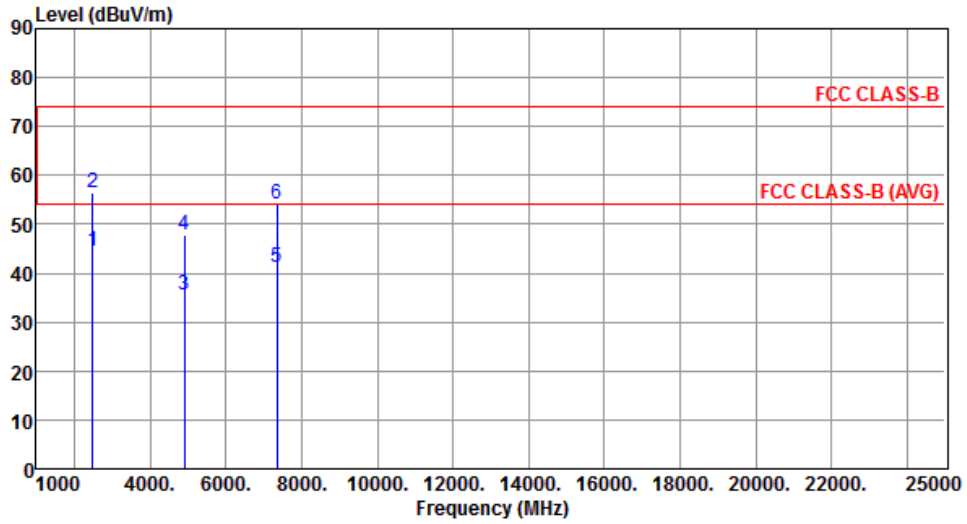

	Freq. MHz	Emission level dBuV/m	Limit dBuV/m	Margin dB	SA reading dBuV	Factor dB	Remark	ANT High cm	Turn Table deg
1	2483.50	44.48	54.00	-9.52	47.51	-3.03	Average	196	98
2	2483.50	56.31	74.00	-17.69	59.34	-3.03	Peak	196	98
3	4904.00	35.56	54.00	-18.44	31.93	3.63	Average	100	44
4	4904.00	47.82	74.00	-26.18	44.19	3.63	Peak	100	44
5	7356.00	41.22	54.00	-12.78	32.14	9.08	Average	100	58
6	7356.00	54.29	74.00	-19.71	45.21	9.08	Peak	100	58

Note 1: Emission Level (dBuV/m) = SA Reading (dBuV/m) + Factor* (dB)

*Factor includes antenna factor , cable loss and amplifier gain

Note 2: Margin (dB) = Emission level (dBuV/m) – Limit (dBuV/m).

3.6 Emissions in Non-Restricted Frequency Bands

3.6.1 Emissions in Non-Restricted Frequency Bands Limit

Peak power in any 100 kHz bandwidth outside of the authorized frequency band shall be attenuated by at least 20 dB relative to the maximum in-band peak PSD level in 100 kHz.

3.6.2 Test Procedures

Reference level measurement

1. Set RBW=100kHz, VBW = 300kHz , Detector = Peak, Sweep time = Auto
2. Trace = max hold , Allow Trace to fully stabilize
3. Use the peak marker function to determine the maximum PSD level

Emission level measurement

1. Set RBW=100kHz, VBW = 300kHz , Detector = Peak, Sweep time = Auto
2. Trace = max hold , Allow Trace to fully stabilize
3. Scan Frequency range is up to 25GHz
4. Use the peak marker function to determine the maximum amplitude level

3.6.3 Test Setup

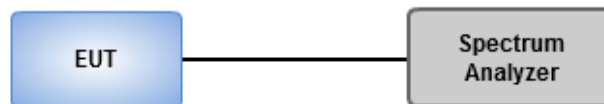

3.6.4 Unwanted Emissions into Non-Restricted Frequency Bands

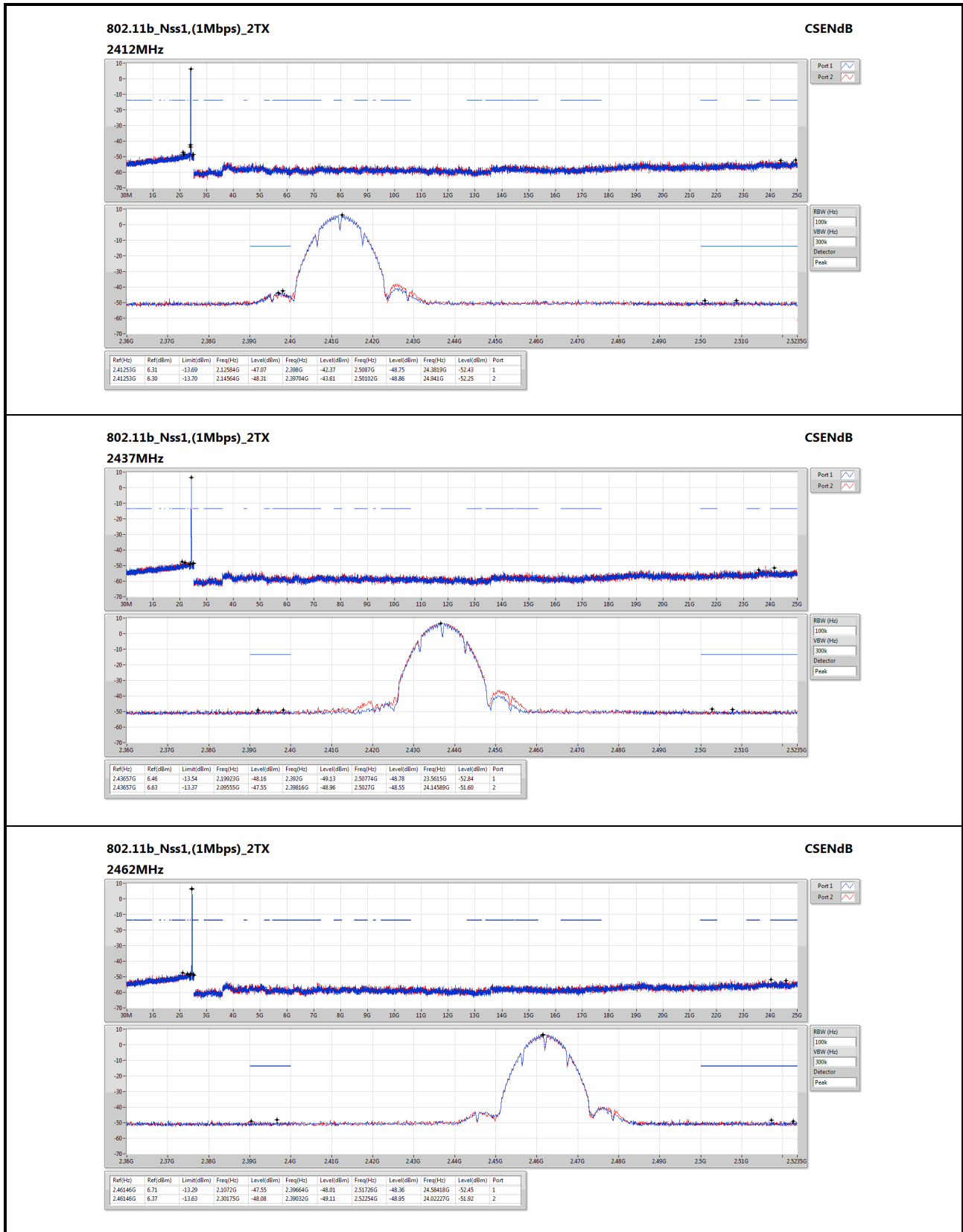
802.11b_Nss1,(1Mbps)_2TX
CSEndB
2462MHz

802.11g_Nss1,(6Mbps)_2TX
2412MHz

CSEndB

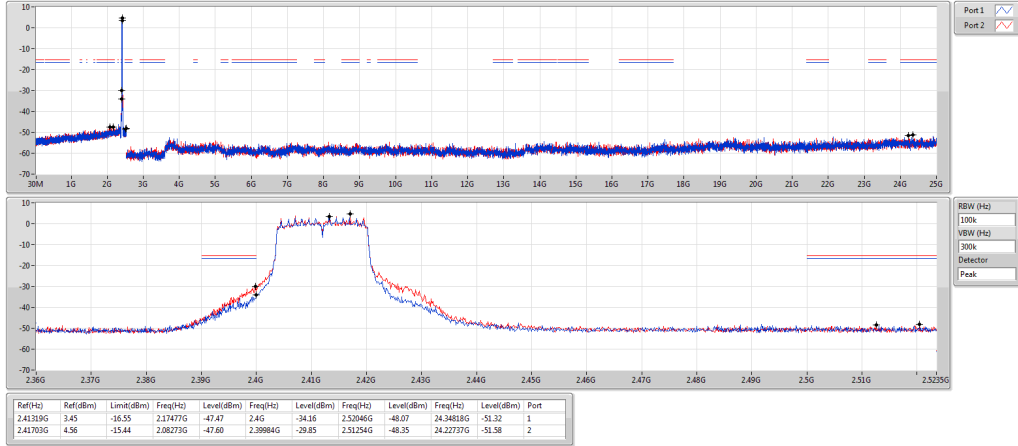

802.11g_Nss1,(6Mbps)_2TX
2437MHz

CSEndB

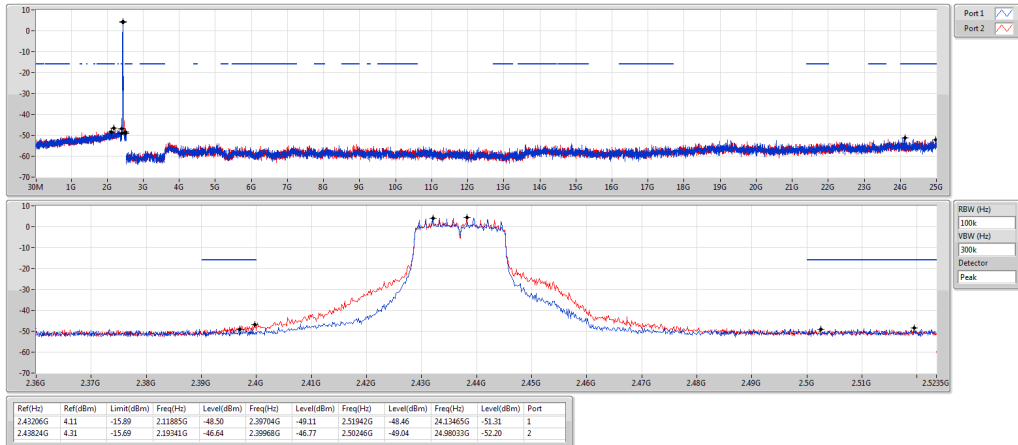

802.11g_Nss1,(6Mbps)_2TX
2462MHz

CSEndB

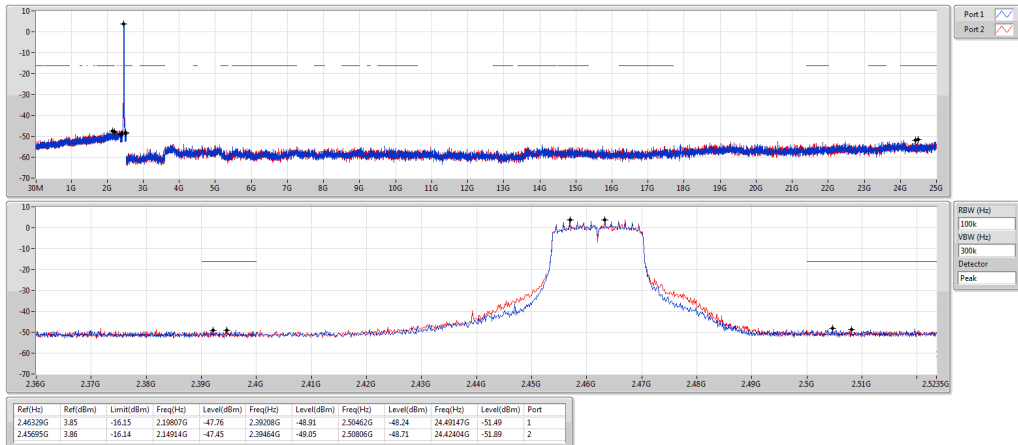

802.11n HT20_Nss1,(MCS0)_2TX
2412MHz

CSEndB

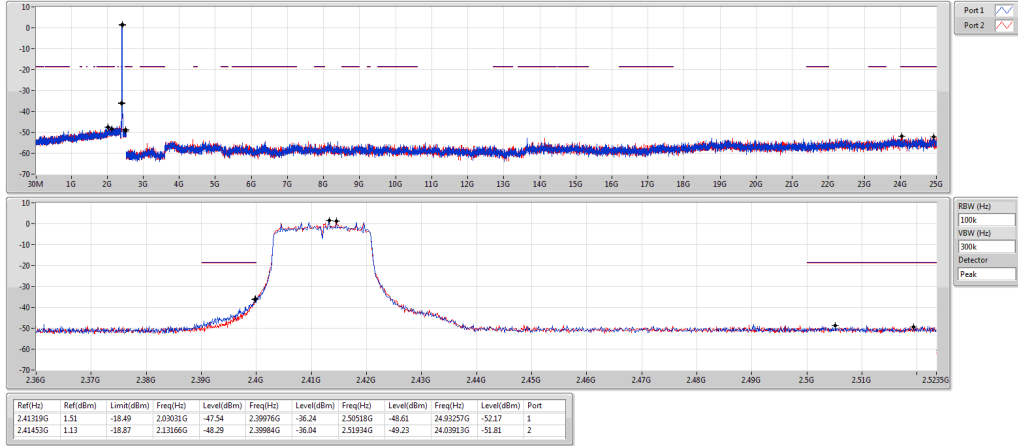

802.11n HT20_Nss1,(MCS0)_2TX
2437MHz

CSEndB

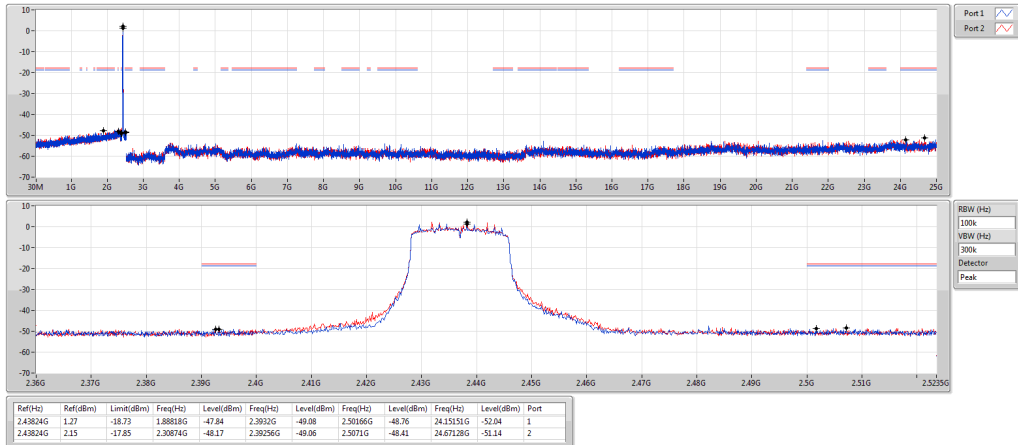

802.11n HT20_Nss1,(MCS0)_2TX
2462MHz

CSEndB

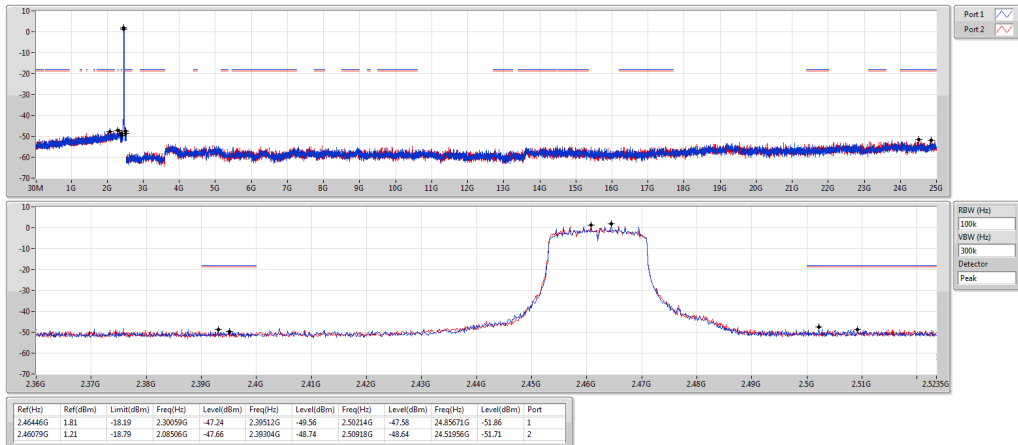

802.11n HT40_Nss1,(MCS0)_2TX
2422MHz

CSEndB

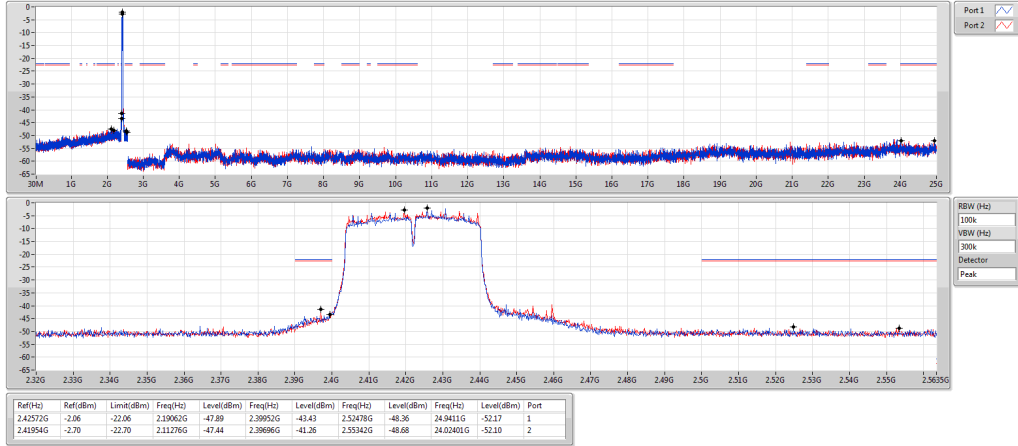

802.11n HT40_Nss1,(MCS0)_2TX
2437MHz

CSEndB

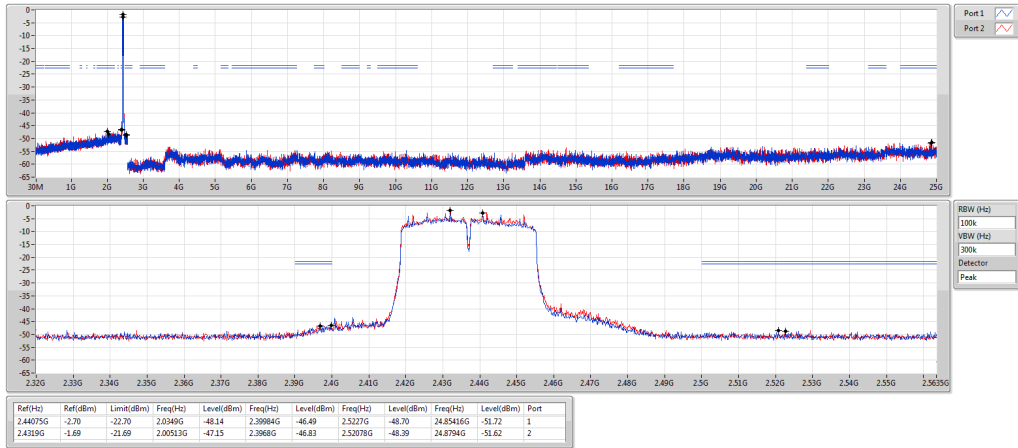

802.11n HT40_Nss1,(MCS0)_2TX
2452MHz

CSEndB

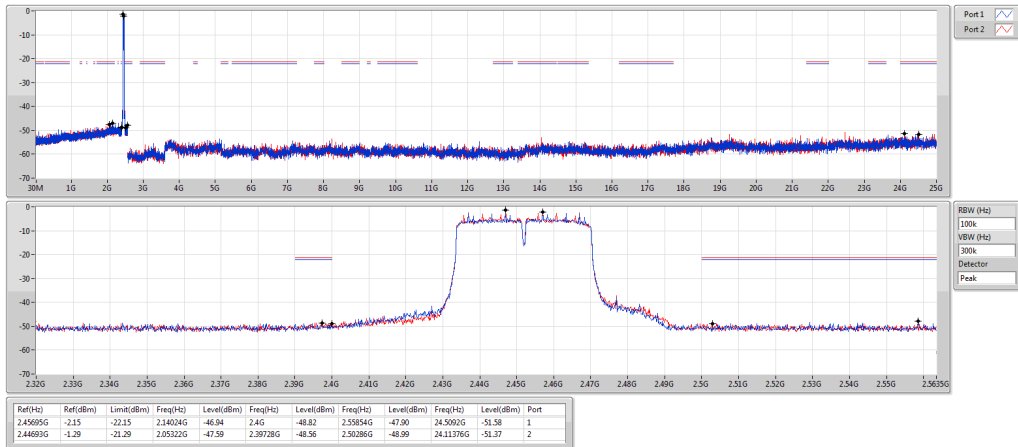

11AX20_Nss1,(MCS0)_2TX
2412MHz

CSEndB

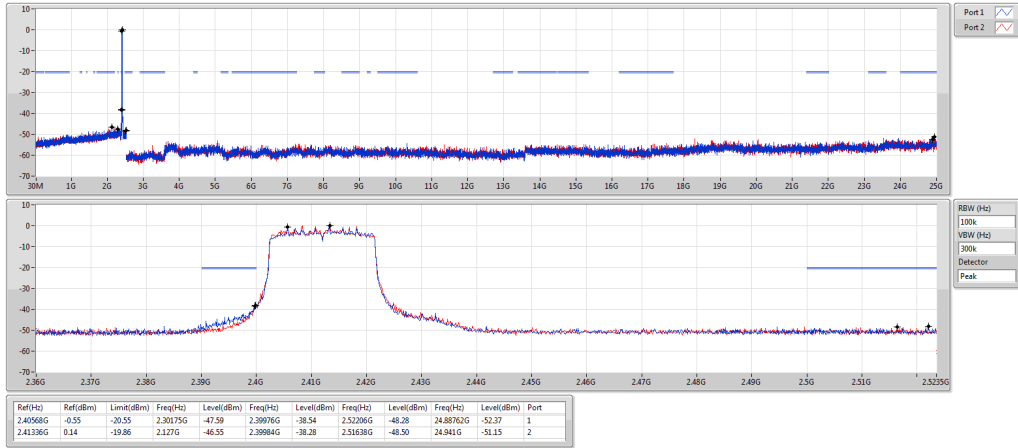

11AX20_Nss1,(MCS0)_2TX
2437MHz

CSEndB

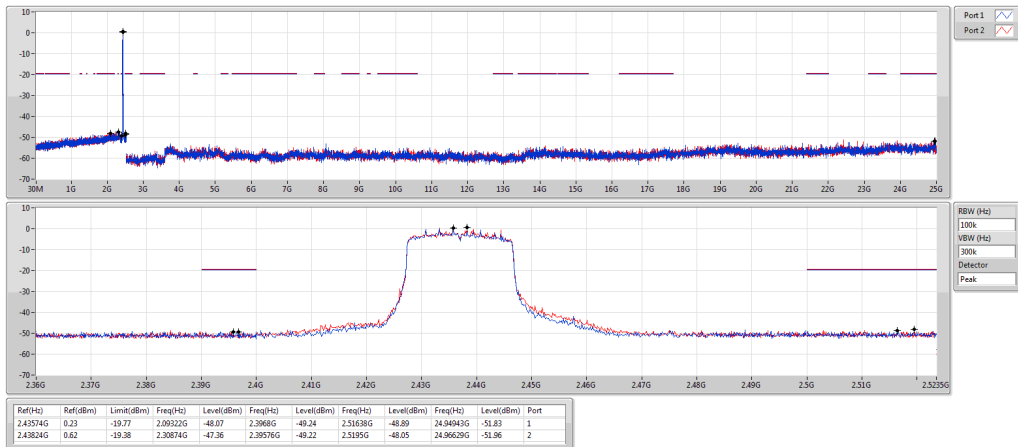

11AX20_Nss1,(MCS0)_2TX
2462MHz

CSEndB

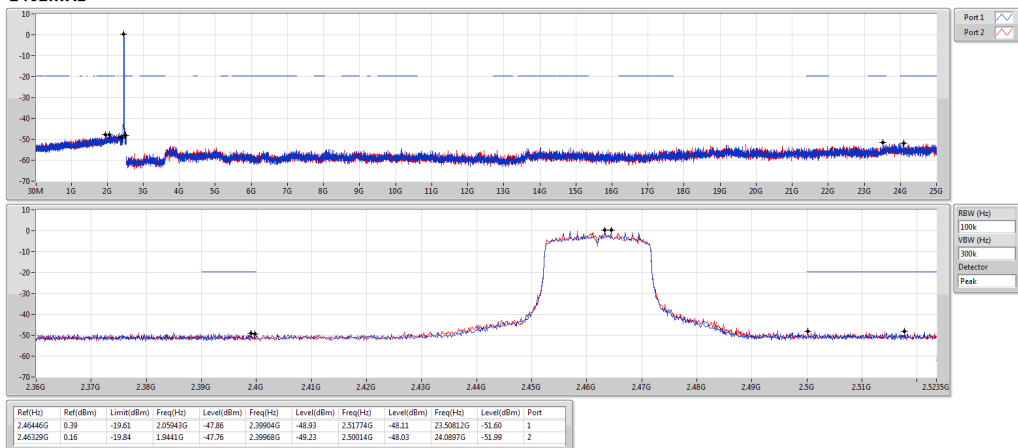

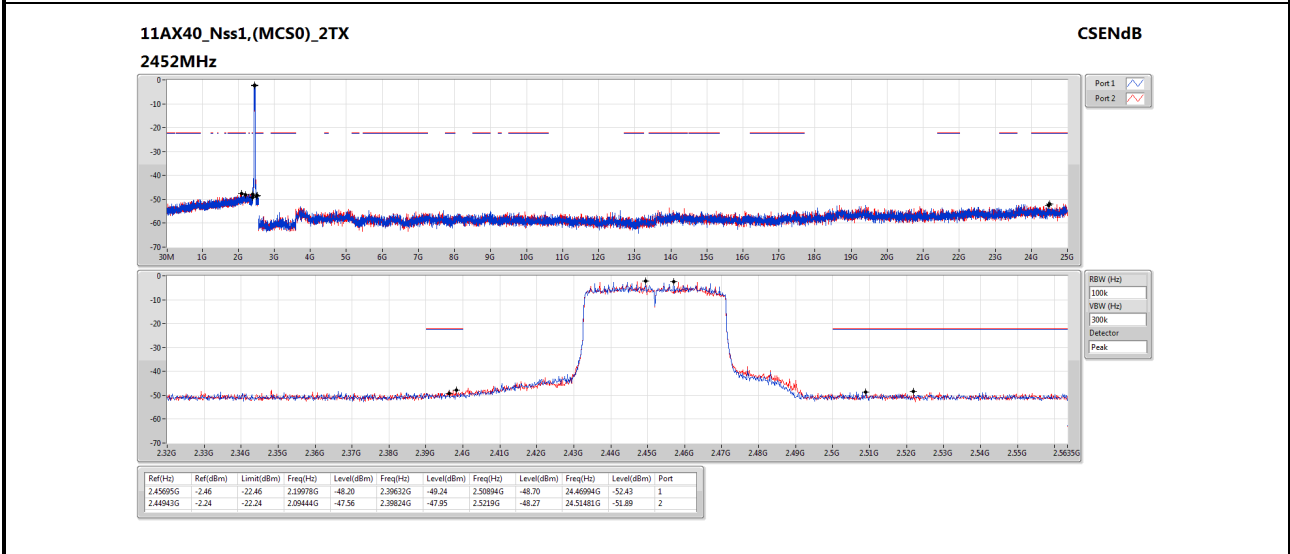
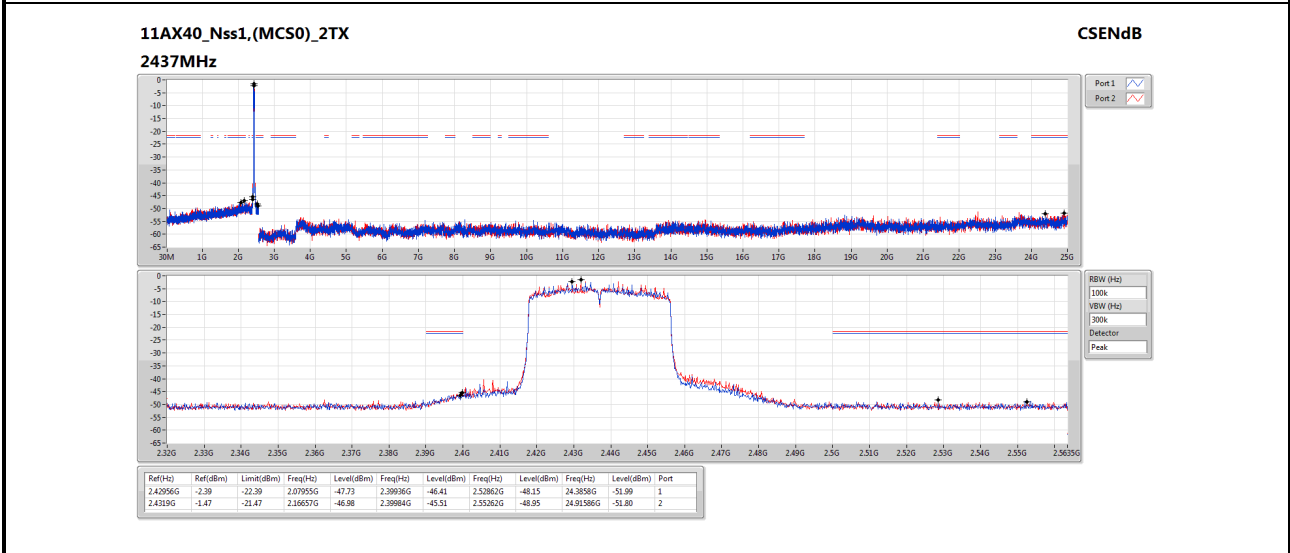
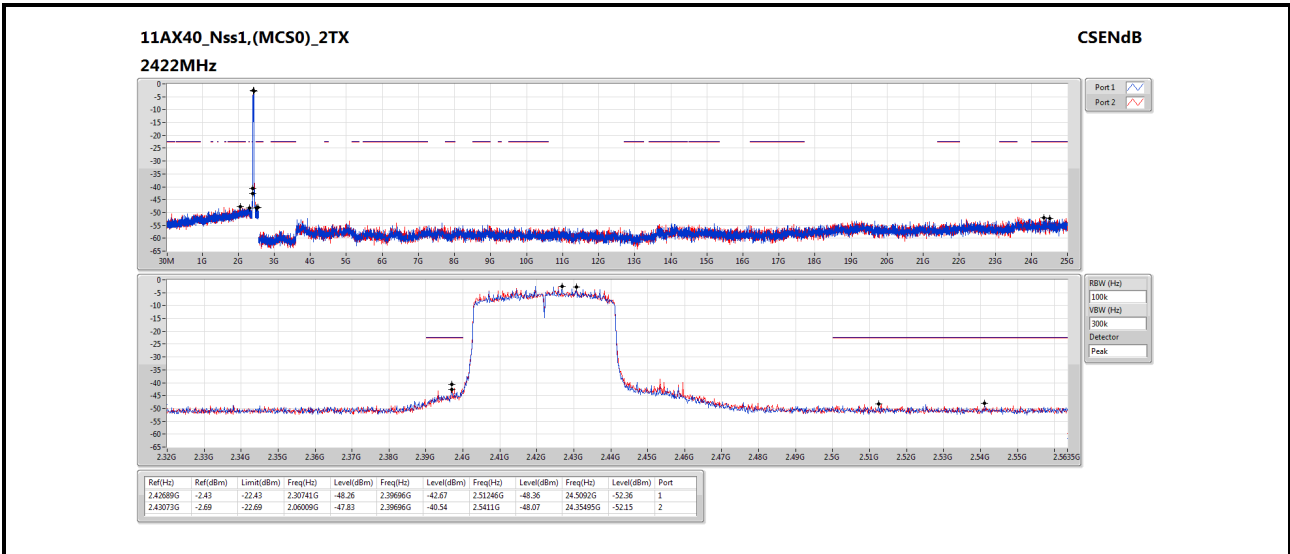

802.11ax HEW40_RU26_Index0_Nss1,(MCS0)_2TX
2422MHz

CSEndB

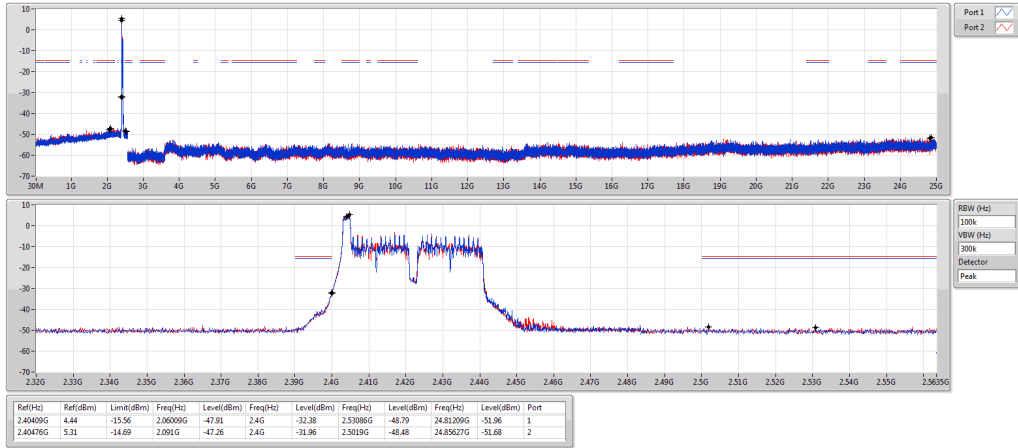

802.11ax HEW40_RU26_Index9_Nss1,(MCS0)_2TX
2437MHz

CSEndB

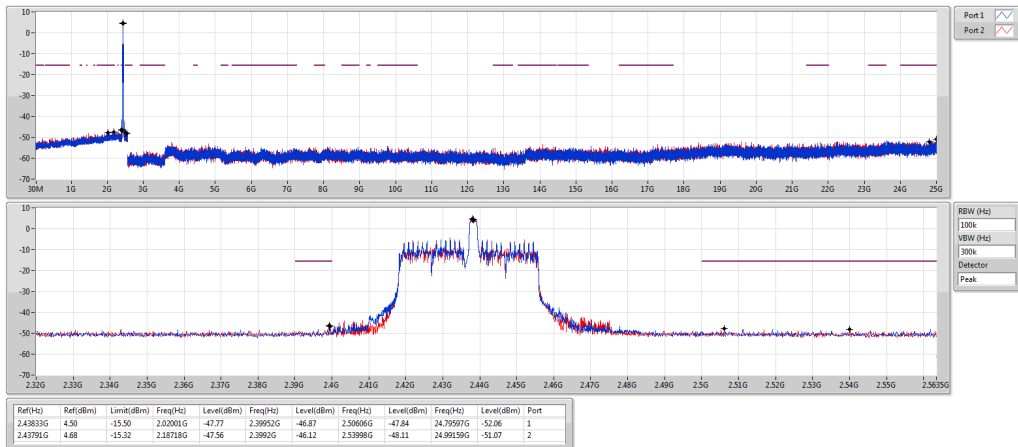

802.11ax HEW40_RU26_Index17_Nss1,(MCS0)_2TX
2452MHz

CSEndB

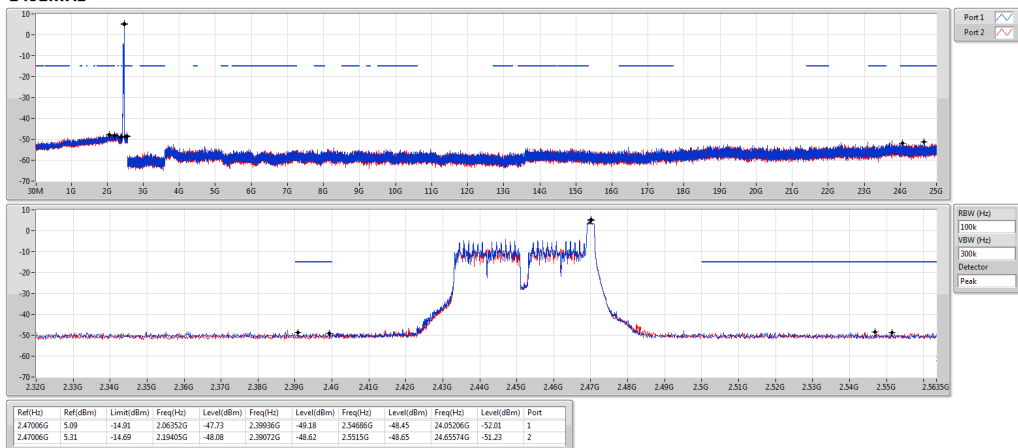

802.11ax HEW40_RU52_Index37_Nss1,(MCS0)_2TX
2422MHz

CSEndB



802.11ax HEW40_RU52_Index41_Nss1,(MCS0)_2TX
2437MHz

CSEndB

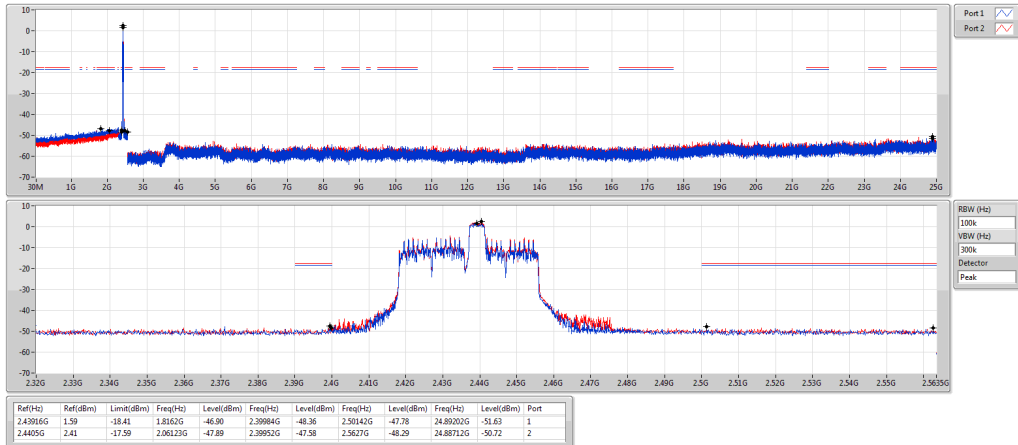

802.11ax HEW40_RU52_Index44_Nss1,(MCS0)_2TX
2452MHz

CSEndB

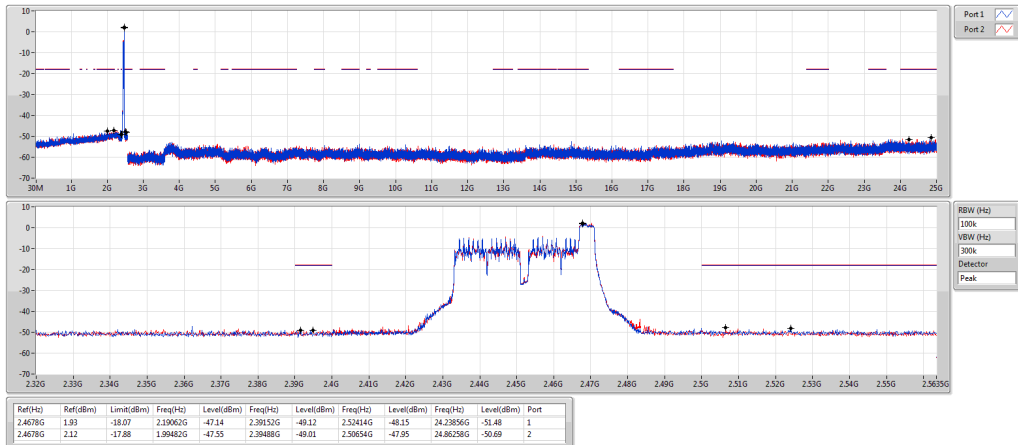

802.11ax HEW40_RU106_Index53_Nss1,(MCS0)_2TX
2422MHz

CSEndB

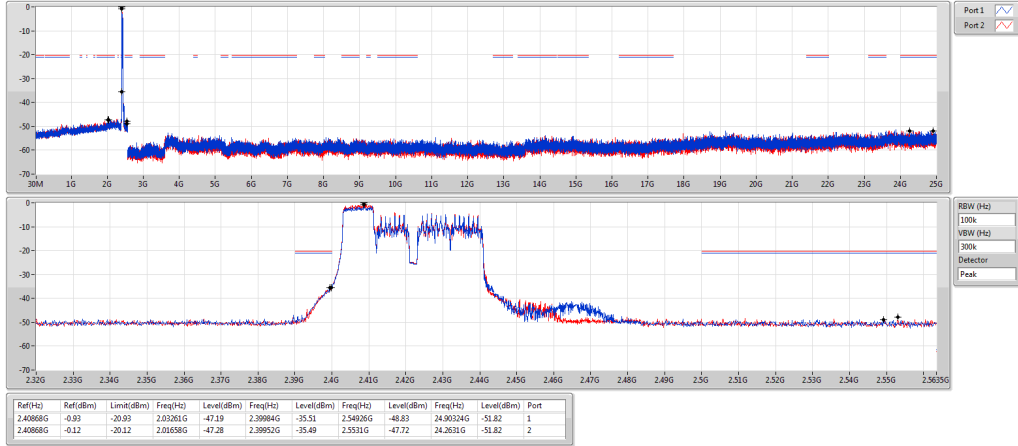

802.11ax HEW40_RU106_Index54_Nss1,(MCS0)_2TX
2437MHz

CSEndB

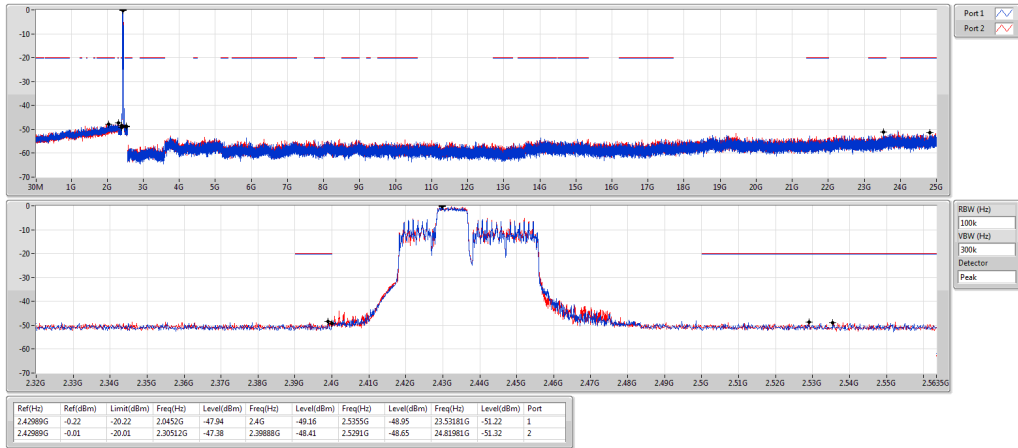

802.11ax HEW40_RU106_Index56_Nss1,(MCS0)_2TX
2452MHz

CSEndB

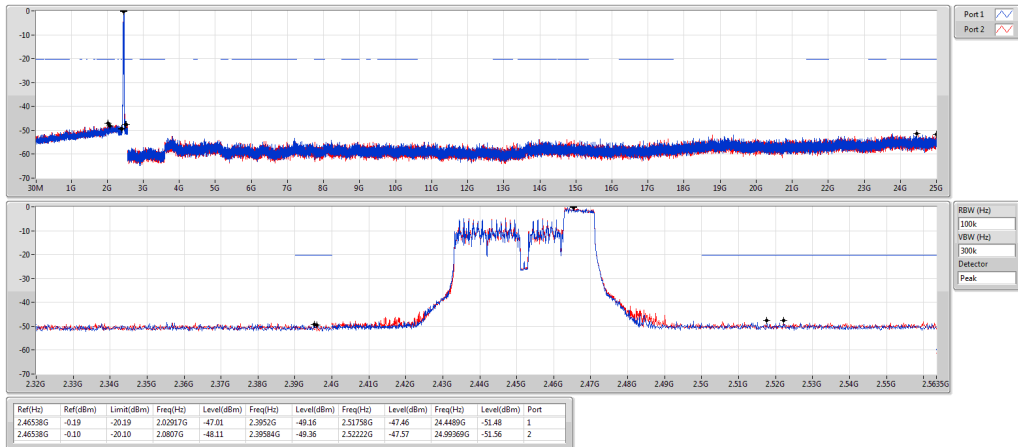

802.11ax HEW40_RU242_Index61_Nss1,(MCS0)_2TX
2422MHz

CSEndB

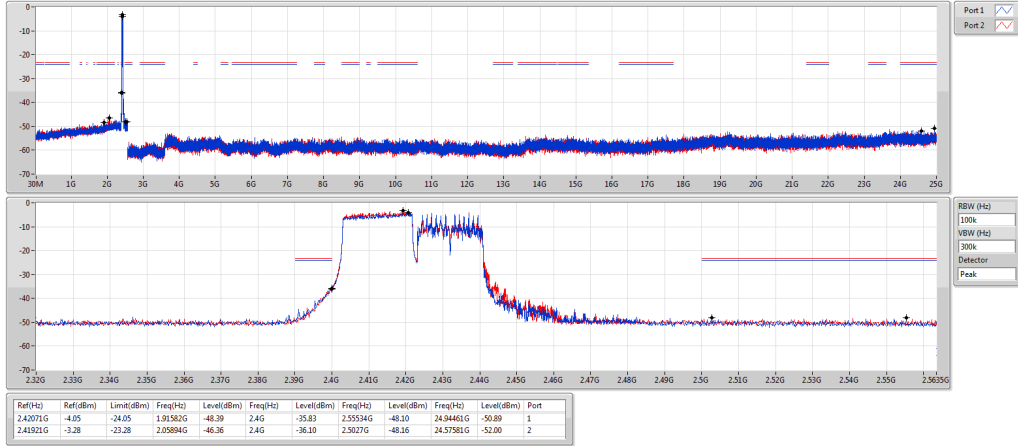

802.11ax HEW40_RU242_Index62_Nss1,(MCS0)_2TX
2437MHz

CSEndB

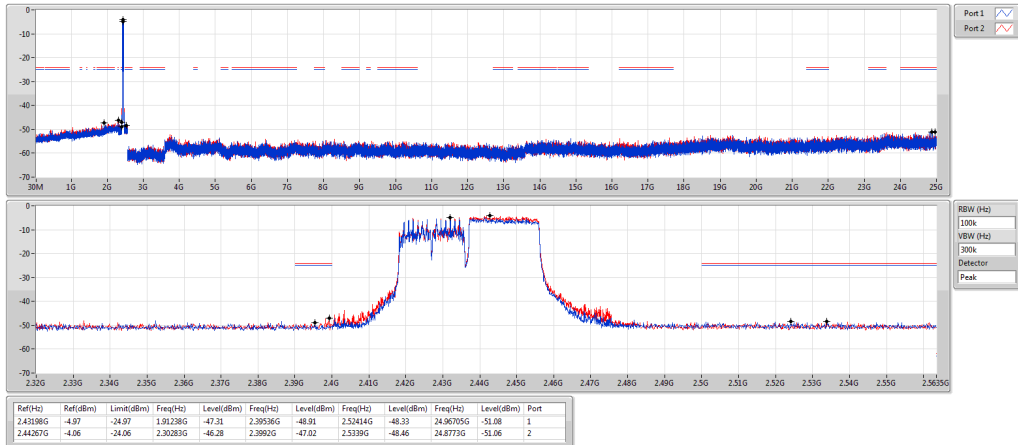

802.11ax HEW40_RU242_Index62_Nss1,(MCS0)_2TX
2452MHz

CSEndB

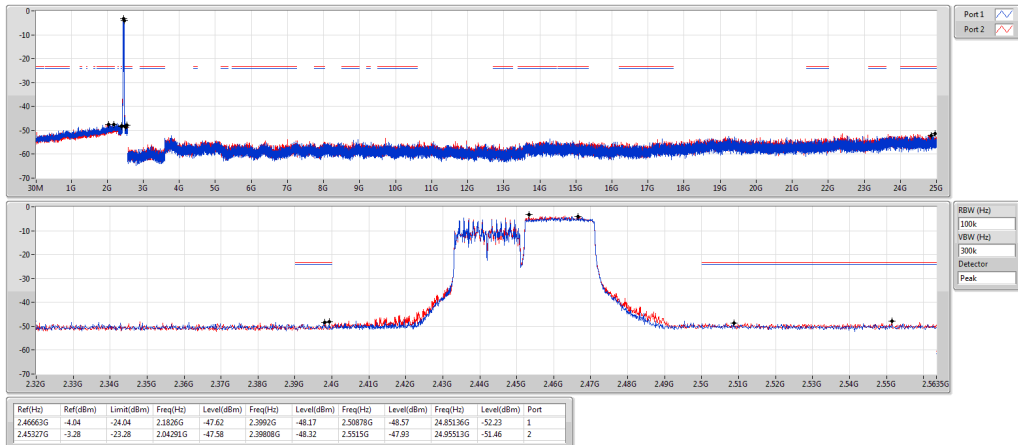

4 Test laboratory information

Established in 2012, ICC provides foremost EMC & RF Testing and advisory consultation services by our skilled engineers and technicians. Our services employ a wide variety of advanced edge test equipment and one of the widest certification extents in the business.

International Certification Corp (EMC and Wireless Communication Laboratory), it is our definitive objective is to institute long term, trust-based associations with our clients. The expectation we set up with our clients is based on outstanding service, practical expertise and devotion to a certified value structure. Our passion is to grant our clients with best EMC / RF services by oriented knowledgeable and accommodating staff.

Our Test sites are located at Linkou District and Kwei Shan District. Location map can be found on our website <http://www.icertifi.com.tw>.

Linkou

Tel: 886-2-2601-1640

No. 30-2, Ding Fwu Tsuen, Lin
Kou District, New Taipei City,
Taiwan, R.O.C.

Kwei Shan

Tel: 886-3-271-8666

No. 3-1, Lane 6, Wen San 3rd St.,
Kwei Shan District, Tao Yuan City
333, Taiwan, R.O.C.

Kwei Shan Site II

Tel: 886-3-271-8640

No. 14-1, Lane 19, Wen San 3rd
St., Kwei Shan District, Tao Yuan
City 333, Taiwan, R.O.C.

If you have any suggestion, please feel free to contact us as below information.

Tel: 886-3-271-8666

Fax: 886-3-318-0155

Email: ICC_Service@icertifi.com.tw

==END==